

COMBINATORICS OF INFINITE RANK MODULE CATEGORIES OVER FINITE DIMENSIONAL \mathfrak{sl}_3 -MODULES IN LIE-ALGEBRAIC CONTEXT

VOLODYMYR MAZORCHUK AND XIAOYU ZHU

ABSTRACT. We determine the combinatorics of transitive module categories over the monoidal category of finite dimensional \mathfrak{sl}_3 -modules which arise when acting by the latter monoidal category on arbitrary simple \mathfrak{sl}_3 -modules. This gives us a family of eight graphs which can be viewed as \mathfrak{sl}_3 -generalizations of the classical infinite Dynkin diagrams.

1. INTRODUCTION AND DESCRIPTION OF THE RESULTS

1.1. Infinite Dynkin diagrams. Classical Dynkin diagrams are combinatorial objects that arise in a variety of different contexts, for example, in the classification of finite root systems, semi-simple Lie algebras or representation finite hereditary algebras. There are various generalizations of Dynkin diagrams, for instance, affine Dynkin diagrams which appear, among other places, in the McKay correspondence and in spectral theory of finite graphs. Infinite generalization of Dynkin diagrams also appear in various contexts. For example, the following list of infinite Dynkin diagrams appears in [HPR80a, HPR80b]:

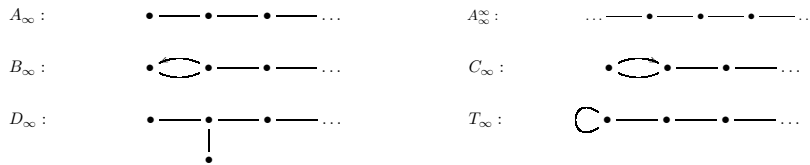

In our previous paper [MZ24], we investigated combinatorics of transitive module categories over the monoidal category of finite dimensional \mathfrak{sl}_2 -modules which arise when acting by the latter monoidal category on arbitrary simple \mathfrak{sl}_2 -modules. It turns out that this combinatorics is always described by an infinite Dynkin diagram. One could loosely say that infinite Dynkin diagrams capture \mathfrak{sl}_2 -symmetries in the Lie algebraic context.

1.2. \mathfrak{sl}_3 -generalization. In the present paper, we study \mathfrak{sl}_3 -generalizations of the results of [MZ24] mentioned above. We consider the monoidal category \mathcal{C} of finite dimensional \mathfrak{sl}_3 -modules and look at the \mathcal{C} -module categories of the form $\text{add}(\mathcal{C} \cdot L)$, where L is a simple \mathfrak{sl}_3 -module. A major part of the paper is dedicated to the case when L is a simple highest weight module or a Whittaker module. However, our main result, Theorem 20, deals with the case of an arbitrary simple L .

Given a “nice” \mathcal{C} -module category \mathbf{M} , for example, an additive and Krull-Schmidt category on which \mathcal{C} acts via additive functors, the combinatorial shadow of the action of an object of \mathcal{C} can be collected in a non-negative integer matrix which bookkeeps the multiplicities of the action in the natural basis of the split Grothendieck group consisting of all indecomposable objects. The category \mathcal{C} is generated, as a monoidal category, by one object: the natural \mathfrak{sl}_3 -module. Therefore, the underlying combinatorics of the

action is, to some extent, determined by one such matrix or, equivalently, by a certain oriented graph, call it Γ .

The \mathcal{C} -module category $\text{add}(\mathcal{C} \cdot L)$ admits a “composition series” with “simple” subquotients. Combinatorially, this simplicity means that the corresponding graph Γ is strongly connected. In this paper we determine all possible Γ which can appear, for arbitrary L . It turns out that the list is finite (however, all graphs in this list are infinite). In fact, the list consists of exactly eight graphs, see Figure 16. It is natural to view these eight graphs as \mathfrak{sl}_3 -generalizations of the infinite Dynkin diagrams (if we interpret the latter as \mathfrak{sl}_2 -related objects).

1.3. Content of the paper. Our main result, Theorem 20, asserts exactly that the combinatorics of a “simple” subquotient of a \mathcal{C} -module category of the form $\text{add}(\mathcal{C} \cdot L)$ is governed by one of the eight graphs listed in Figure 16.

However, a major part of the paper is devoted to determination of these eight graphs, for very particular simple modules L . Seven of these eight graphs come from the case when L is a simple highest weight module, that is, an object of the BGG category \mathcal{O} associated to \mathfrak{sl}_3 , cf. [BGG76]. The remaining graph appears in the case when L is a non-degenerate Whittaker module, cf. [Ko78]. After this, fairly technical part, it is not too difficult to show, using the standard techniques of Harish-Chandra bimodules, that all other cases of L are similar to either category \mathcal{O} or to Whittaker modules (in fact, there is even an equivalence of the corresponding \mathcal{C} -module categories, generalizing the approach of [MiSo97]).

For all graphs, we determine the Perron-Frobenius eigenvector for the Perron-Frobenius eigenvalue 3 of the corresponding matrix and discuss the interpretation of the coefficients of this eigenvector in Lie-theoretic context. The coefficients are usually naturally related to either the dimension or the Gelfand-Kirillov dimension or the Bernstein coefficient of the modules involved.

1.4. Structure of the paper. Section 2 introduces all necessary preliminaries and notation related to the Lie algebra \mathfrak{sl}_3 . Weight pictures play an important role in helping to understand the combinatorics we want to describe. Therefore, in Section 2, we, in particular, provide pictorial representations of all our main ingredients.

In Section 3 we collected all necessary preliminaries related to the monoidal category \mathcal{C} and module categories over it. We also comment on the relation of our problems to the classical Perron-Frobenius theory.

Sections 4, 5 and 6 contain the special cases preparation work for the main theorem. Section 4 looks at the regular \mathcal{C} -module category. This is a very special case in which one can derive many more properties compared to the general case. In particular, here we prove Theorem 1 which asserts that a simple \mathcal{C} -module category with the same combinatorics as the regular \mathcal{C} -module category is, in fact, equivalent to the regular \mathcal{C} -module category. Section 5 studies combinatorics of \mathcal{C} -module categories in the context of BGG category \mathcal{O} . Section 6 studies combinatorics of \mathcal{C} -module categories in the context of Whittaker modules.

Our main result, Theorem 20, is formulated and proved in Section 7.

Acknowledgments. The first author is partially supported by the Swedish Research Council. The second author is partially supported by the Zhejiang Provincial Natural Science Foundation of China, Grant No. QN25A010010.

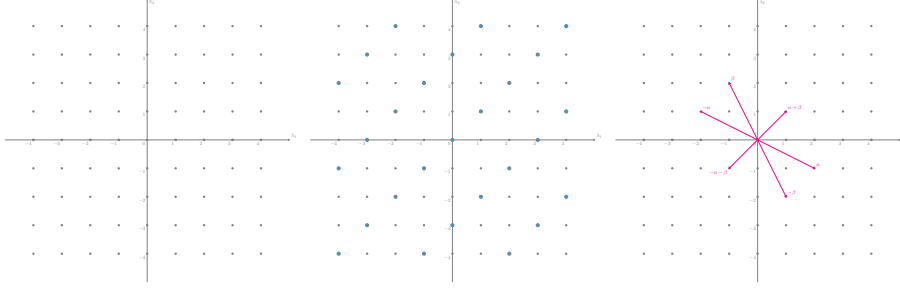
FIGURE 1. The sets Λ , Θ and \mathbf{R}

2. THE LIE ALGEBRA \mathfrak{sl}_3

2.1. Setup. In this paper, we work over the field \mathbb{C} of complex numbers. Consider the Lie algebra $\mathfrak{g} := \mathfrak{sl}_3 = \mathfrak{sl}_3(\mathbb{C})$ of all traceless 3×3 complex matrices. It has the standard triangular decomposition

$$\mathfrak{sl}_3 = \mathfrak{n}_- \oplus \mathfrak{h} \oplus \mathfrak{n}_+.$$

Here \mathfrak{h} is the Cartan subalgebra of all traceless diagonal matrices, \mathfrak{n}_+ is the subalgebra of all strictly upper triangular matrices and \mathfrak{n}_- is the subalgebra of all strictly lower triangular matrices.

For $i, j \in \{1, 2, 3\}$, we denote by $e_{i,j}$ the corresponding matrix unit. Then $\{e_{1,2}, e_{1,3}, e_{2,3}\}$ is a basis in \mathfrak{n}_+ , $\{e_{2,1}, e_{3,1}, e_{3,2}\}$ is a basis in \mathfrak{n}_- , and $\{h_1, h_2\}$, where $h_1 := e_{1,1} - e_{2,2}$ and $h_2 := e_{2,2} - e_{3,3}$, is a basis in \mathfrak{h} .

For a Lie algebra \mathfrak{a} , we denote by $U(\mathfrak{a})$ the universal enveloping algebra of \mathfrak{a} .

2.2. Weights and roots. Consider the dual space $\mathfrak{h}^* := \text{Hom}_{\mathbb{C}}(\mathfrak{h}, \mathbb{C})$. As usual, we will call the elements of \mathfrak{h}^* *weights*. An element $\lambda \in \mathfrak{h}^*$ will be identified with $(\lambda(h_1), \lambda(h_2)) \in \mathbb{C}^2$. We set $\lambda_1 := \lambda(h_1)$ and $\lambda_2 := \lambda(h_2)$.

Let $\mathbf{R} \subset \mathfrak{h}^*$ be the root system of \mathfrak{sl}_3 . Then the above triangular decomposition induces a choice of a basis π in \mathbf{R} and the corresponding decomposition of \mathbf{R} into positive and negative roots: $\mathbf{R} = \mathbf{R}_+ \amalg \mathbf{R}_-$. We denote by α the root corresponding to e_{12} and by β the root corresponding to e_{23} . Then $\pi = \{\alpha, \beta\}$, $\mathbf{R}_+ = \{\alpha, \beta, \alpha + \beta\}$ and $\mathbf{R}_- = \{-\alpha, -\beta, -\alpha - \beta\}$.

We denote by Θ the set $\mathbb{Z}\pi$, and by Λ the set of all *integral weights*, that is, the set of all $\lambda \in \mathfrak{h}^*$ such that both $\lambda(h_1)$ and $\lambda(h_2)$ are integers. Note that Θ is a subgroup of Λ and Λ/Θ is a cyclic group of order 3. The sets Λ , Θ and \mathbf{R} are major players in our story. They are visualized in Figure 1.

2.3. Highest weight modules. For each $\lambda \in \mathfrak{h}^*$, we have the corresponding *Verma module* $\Delta(\lambda)$ with highest weight λ , see [Di96, Hu08]. We denote by $L(\lambda)$ the unique simple top of $\Delta(\lambda)$. We refer to [Di96, Hu08] for all details on standard properties of these modules.

Let $Z(\mathfrak{g})$ be the center of $U(\mathfrak{g})$. Then each element $z \in Z(\mathfrak{g})$ acts on $\Delta(\lambda)$ (and hence also on $L(\lambda)$) as a scalar, which we denote by $\chi_\lambda(z)$. The map $\chi_\lambda : Z(\mathfrak{g}) \rightarrow \mathbb{C}$ is an algebra homomorphism and is called the *central character* (of $\Delta(\lambda)$). Let W be the Weyl group of the pair $(\mathfrak{g}, \mathfrak{h})$. Set

$$\rho := \alpha + \beta = \frac{1}{2} \sum_{\gamma \in \mathbf{R}_+} \gamma.$$

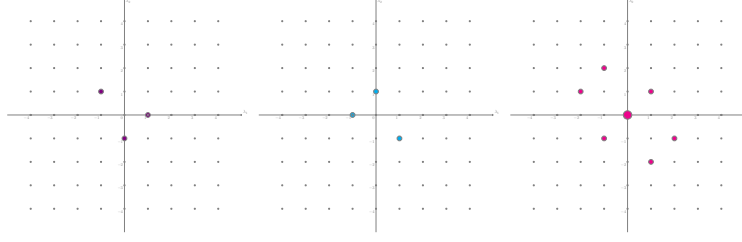

FIGURE 2. The supports of $L((1,0))$, $L((0,1))$ and $L((1,1))$

Then we can define the *dot-action* of W on \mathfrak{h}^* from the usual action of W on \mathfrak{h}^* as follows: $w \cdot \lambda := w(\lambda + \rho) - \rho$. Now, for $\lambda, \mu \in \mathfrak{h}^*$, we have $\chi_\lambda = \chi_\mu$ if and only if $\lambda \in W \cdot \mu$.

Note that W is isomorphic to the symmetric group S_3 . If we denote by s the simple reflection with respect to α and by r the simple reflection with respect to β , then $W = \{e, r, s, rs, sr, w_0\}$, where $w_0 = srs = rsr$.

2.4. Finite dimensional \mathfrak{sl}_3 -modules. Our main protagonist in this paper is the semi-simple monoidal category \mathcal{C} of all finite dimensional \mathfrak{sl}_3 -modules. The monoidal structure is given by tensoring over \mathbb{C} (which has the natural structure of an \mathfrak{sl}_3 -module using the standard comultiplication on $U(\mathfrak{sl}_3)$ which sends $g \in \mathfrak{sl}_3$ to $g \otimes \text{id} + \text{id} \otimes g$). The monoidal category \mathcal{C} is rigid and symmetric. The dual of an object V is the object $V^* = \text{Hom}_{\mathbb{C}}(V, \mathbb{C})$, on which the action of \mathfrak{sl}_3 is defined using the canonical anti-involution $g \mapsto -g$, for $g \in \mathfrak{sl}_3$.

The simple objects in \mathcal{C} , up to isomorphism, are exactly the modules $L(\lambda)$, where $\lambda \in \mathfrak{h}^*$ is such that both λ_1 and λ_2 are non-negative integers. As an idempotent split additive monoidal category, the category \mathcal{C} is generated by the object $L((1,0))$. The latter object is the *natural* 3-dimensional \mathfrak{sl}_3 -module \mathbb{C}^3 on which \mathfrak{sl}_3 acts by matrix multiplication. To simplify notation, we denote the object $L((1,0))$ by F and the object $L((0,1))$ by G . Note that F and G are biadjoint.

2.5. Weights of finite dimensional \mathfrak{sl}_3 -modules. For a \mathfrak{g} -module M and $\lambda \in \mathfrak{h}^*$, consider the space

$$M_\lambda = \{v \in M : h(v) = \lambda(h)v, \text{ for all } h \in \mathfrak{h}\}.$$

The space M_λ is usually called the *weight space* of M corresponding to the weight λ . A \mathfrak{g} -module M is called a *weight module* provided that it is the direct sum of its weight spaces. For a weight \mathfrak{g} -module M , the set of all $\lambda \in \mathfrak{h}^*$ such that $M_\lambda \neq 0$ is called the *support* of M and denoted $\text{supp}(M)$.

All finite dimensional \mathfrak{g} -modules are weight modules. Moreover, the support of each finite dimensional \mathfrak{g} -module is W -invariant. Furthermore, the set Λ coincides with the union of the supports of all finite dimensional \mathfrak{g} -module.

The algebra $U(\mathfrak{g})$ is a \mathfrak{g} -module with respect to the adjoint action. Moreover, the latter action is locally finite. Furthermore, the set Θ coincides with the union of the supports of all finite dimensional \mathfrak{g} -modules which appear as summands of $U(\mathfrak{g})$, considered as the adjoint \mathfrak{g} -module. Note that, a simple finite dimensional \mathfrak{g} -module $L(\lambda)$ appears as a summand of $U(\mathfrak{g})$, considered as an adjoint \mathfrak{g} -module, if and only if $L(\lambda)_0 \neq 0$.

In Figure 2, we depicted the supports of the simple \mathfrak{g} -modules $L((1,0))$, its dual $L((0,1)) = L((1,0))^*$ and the adjoint module $\mathfrak{g} = L((1,1))$. Note that, for the latter module, the weight space corresponding to 0 has dimension 2.

2.6. Gelfand-Kirillov dimension and Bernstein number. Each finitely generated $U(\mathfrak{g})$ -module M has finite *Gelfand-Kirillov dimension*, denoted $\text{GKdim}(M)$. This dimension characterizes the rate of (polynomial) growth of M with respect to some choice of a filtration of $U(\mathfrak{g})$. In fact, it is well-known (see [Ja83, KL00]) that $\text{GKdim}(M)$ is independent of the choice of such filtration.

We denote by $\mathbf{b}(M)$ the leading term of the polynomial that describes the growth of M , this is known as the *Bernstein number*. Unlike $\text{GKdim}(M)$, the number $\mathbf{b}(M)$ might depend on the choice of a filtration of $U(\mathfrak{g})$. Therefore we fix some choice of such filtration until the end of the paper (for example, we can take the filtration by monomial degree).

For any finite-dimensional $U(\mathfrak{g})$ -module V , we have:

- $\text{GKdim}(V) = 0$ and $\mathbf{b}(V) = \dim(V)$;
- $\text{GKdim}(M \otimes_{\mathbb{C}} V) = \text{GKdim}(M)$;
- $\mathbf{b}(M \otimes_{\mathbb{C}} V) = \dim(V) \cdot \mathbf{b}(M)$.

2.7. Projective functors. Denote by \mathcal{Z} the full subcategory of $\mathfrak{g}\text{-mod}$ consisting of all objects, the action of $Z(\mathfrak{g})$ on which is locally finite. The category \mathcal{Z} decomposes into a direct sum of full subcategories \mathcal{Z}_{χ} , indexed by central characters $\chi : Z(\mathfrak{g}) \rightarrow \mathbb{C}$. The category \mathcal{Z}_{χ} consists of all modules in \mathcal{Z} on which the kernel of χ acts locally nilpotently. The category \mathcal{Z} is stable under the action of \mathcal{C} on $\mathfrak{g}\text{-mod}$.

A *projective functor* is an endofunctor of \mathcal{Z} which is isomorphic to a direct summand of tensoring with some finite dimensional \mathfrak{g} -modules. Indecomposable projective functors are classified in [BG80]. They are in bijection with dot-orbits of W on pairs (λ, μ) , where $\lambda, \mu \in \mathfrak{h}^*$ are such that $\lambda - \mu \in \Lambda$. Each such orbit contains at least one pair (λ, μ) such that

- λ is dominant with respect to its integral Weyl group;
- μ is anti-dominant with respect to the dot-stabilizer of λ .

Such a pair (λ, μ) is called *proper*. We will denote the indecomposable projective functor corresponding to (λ, μ) by $\theta_{\lambda, \mu}$.

3. LOCALLY FINITARY \mathcal{C} -MODULE CATEGORIES

3.1. Basics. We refer to [EGNO15] for basics on representations of monoidal categories.

Let \mathcal{M} be a \mathcal{C} -module category. We will say that \mathcal{M} is *locally finitary* provided that

- \mathcal{M} is \mathbb{C} -linear, additive, idempotent split and Krull-Schmidt;
- \mathcal{M} has at most countably many indecomposable objects, up to isomorphism;
- $\dim \mathcal{M}(X, Y) < \infty$, for all $X, Y \in \mathcal{M}$.

A typical example is \mathcal{C} itself, considered as a \mathcal{C} -module category with respect to the left regular action.

A locally finitary \mathcal{C} -module category \mathcal{M} is called *admissible* provided that it has weak kernels, see [Fr66]. For example, any semi-simple \mathcal{C} -module category \mathcal{M} is admissible.

3.2. Module categories of interest. The category $\mathfrak{sl}_3\text{-Mod}$ of all \mathfrak{sl}_3 -modules is a \mathcal{C} -module category in the obvious way. The category $\mathfrak{sl}_3\text{-mod}$ of all finitely generated \mathfrak{sl}_3 -modules is a \mathcal{C} -module subcategory of $\mathfrak{sl}_3\text{-Mod}$.

We will be interested in \mathcal{C} -module subcategories of $\mathfrak{sl}_3\text{-mod}$ of the form $\text{add}(\mathcal{C} \cdot L)$, where L is a simple \mathfrak{sl}_3 -module (not necessarily finite dimensional). These categories are defined as follows:

Given a simple \mathfrak{sl}_3 -module L and a finite dimensional \mathfrak{sl}_3 -module V , the module $V \otimes_{\mathbb{C}} L$ has a finite dimensional endomorphism algebra (see [MMM23]) and hence decomposes into a finite direct sum of indecomposable modules. The category $\text{add}(\mathcal{C} \cdot L)$ is the full subcategory of $\mathfrak{sl}_3\text{-mod}$ which consists of all objects that are isomorphic to direct sums of modules appearing as summands in $V \otimes_{\mathbb{C}} L$, where V can vary inside \mathcal{C} . Consequently, any $\text{add}(\mathcal{C} \cdot L)$ is a locally finitary \mathcal{C} -module category.

3.3. Action matrices and graphs. Let \mathcal{M} be a locally finitary \mathcal{C} -module category and $\text{Ind}(\mathcal{M}) = \{N_i : i \in \mathbf{I}\}$ be a complete and irredundant set of representatives of isomorphism classes of indecomposable objects in \mathcal{M} . Then, to each $\theta \in \mathcal{C}$, we can associate the $\mathbf{I} \times \mathbf{I}$ matrix $[\theta]$ with coefficients $m_{i,j}$, where $i, j \in \mathbf{I}$, defined as follows: $m_{i,j}$ is the multiplicity of X_i as a summand of $\theta(X_j)$.

Note that all $m_{i,j}$ are non-negative integers. Therefore, we can alternatively encode $[\theta]$ as an oriented graph, which we call Γ_θ , whose vertex set is \mathbf{I} and which has exactly $m_{i,j}$ oriented edges from j to i .

Since the monoidal category \mathcal{C} is generated by \mathbb{F} , in many cases, almost all essential information about all $[\theta]$ and all Γ_θ is contained already in $[\mathbb{F}]$ and $\Gamma_{\mathbb{F}}$. For example, if \mathcal{M} is semi-simple, then $[\mathbb{F}^*] = [\mathbb{F}]^t$, see e.g. [AM11, Lemma 8]. In particular, the graph $\Gamma_{\mathbb{F}^*}$ is the opposite of $\Gamma_{\mathbb{F}}$. Note that $[\mathbb{F}^*]$ and $[\mathbb{F}]$ commute, which puts very strong restrictions on $[\mathbb{F}]$.

We will make the connection between $[\mathbb{F}]$ and an arbitrary $[\theta]$ more precise in the next subsection, in particular, we will describe how any $[\theta]$ can be expressed as a polynomial in $[\mathbb{F}]$ and $[\mathbb{F}^*]$.

We will call $[\mathbb{F}]$ the *matrix of \mathcal{M}* , $[\mathbb{F}^*]$ the *dual matrix of \mathcal{M}* , $\Gamma_{\mathbb{F}}$ the *graph of \mathcal{M}* and $\Gamma_{\mathbb{F}^*}$ the *dual graph of \mathcal{M}* .

3.4. Grothendieck groups. Consider the Grothendieck ring $\mathbf{Gr}(\mathcal{C})$ of \mathcal{C} . It has the natural basis given by $[L((i, j))]$, where $i, j \in \mathbb{Z}_{\geq 0}$, with the structure constants with respect to this basis given by the Clebsch-Gordan coefficients $\gamma_{(i,j),(i',j')}^{(k,l)}$ defined via

$$L((i, j)) \otimes_{\mathbb{C}} L((i', j')) \cong \bigoplus_{(k,l)} L((k, l))^{\oplus \gamma_{(i,j),(i',j')}^{(k,l)}}.$$

Since \mathfrak{h} -eigenvalues behave additively with respect to tensor products, one obtains both the equality $\gamma_{(i,j),(i',j')}^{(i+i',j+j')} = 1$ and the fact that $\gamma_{(i,j),(i',j')}^{(k,l)} \neq 0$ implies the inequality $(k, l) \leq (i + i', j + j')$ in the sense that $(i + i' - k, j + j' - l) \in \mathbb{Z}_{\geq 0} \pi$. Consequently, $\mathbf{Gr}(\mathcal{C})$ is isomorphic to the polynomial algebra $\mathbb{Z}[x, y]$, by sending $[L(1, 0)]$ to x and $[L(0, 1)]$ to y .

Following [MMMT20, Subsection 2.2], for $(i, j) \in \mathbb{Z}$, define polynomials $\mathbb{U}_{i,j}(x, y)$ recursively as follows:

- $\mathbb{U}_{i,j}(x, y) = 0$ provided that $(i, j) \notin \mathbb{Z}_{\geq 0}^2$;
- $\mathbb{U}_{0,0}(x, y) = 1$;

- $XU_{i,j}(x, y) = U_{i+1,j}(x, y) + U_{i-1,j+1}(x, y) + U_{i,j-1}(x, y);$
- $YU_{i,j}(x, y) = U_{i,j+1}(x, y) + U_{i+1,j-1}(x, y) + U_{i-1,j}(x, y).$

Here are some small examples:

$$U_{1,0}(x, y) = x, \quad U_{0,1}(x, y) = y, \quad U_{2,0}(x, y) = x^2 - y, \quad U_{1,1}(x, y) = xy - 1.$$

Note that directly from the definitions it follows that $U_{i,j}(x, y) = U_{j,i}(y, x).$

The polynomials $\{U_{i,j}(x, y) : (i, j) \in \mathbb{Z}_{\geq 0}\}$ form a basis of $\mathbb{Z}[x, y]$, moreover, under the above isomorphism between $\mathbf{Gr}(\mathcal{C})$ and $\mathbb{Z}[x, y]$, the polynomial $U_{i,j}(x, y)$ corresponds to $[L((i, j))]$. This is due to the fact that the recursive definition of $U_{i,j}$ simply mimics the Clebsch-Gordan rule for tensoring with $L((1, 0))$ and $L((0, 1))$. It could be helpful to compare the recursive steps with the supports of $L((1, 0))$ and $L((0, 1))$ given in Figure 3.

If \mathcal{M} is a locally finitary \mathcal{C} -module, then the split Grothendieck group $\mathbf{Gr}(\mathcal{M})$ is, naturally, a $\mathbf{Gr}(\mathcal{C})$ -module. The group $\mathbf{Gr}(\mathcal{M})$ is a free abelian group with the standard basis given by the isomorphism classes of the indecomposable objects in \mathcal{M} . With respect to this basis, the matrix of the linear operator corresponding to the action of $\theta \in \mathcal{C}$ is exactly the action matrix $[\theta]$. Consequently, if \mathcal{M} is a locally finitary \mathcal{C} -module category, then, for any $(i, j) \in \mathbb{Z}_{\geq 0}$, we have

$$[L((i, j))] = U_{i,j}([L((1, 0))], [L((0, 1))]).$$

In particular, the knowledge of $[L((1, 0))]$ and $[L((0, 1))]$ determines all the remaining $[L((i, j))]$ uniquely.

3.5. Transitive module categories. A locally finitary \mathcal{C} -module category \mathcal{M} is called *transitive* provided that, for all indecomposable objects X and Y in \mathcal{M} , there is $\theta \in \mathcal{C}$ such that Y is isomorphic to a summand of $\theta(X)$, see [MM16]. Alternatively, \mathcal{M} is transitive provided that $\Gamma_{\mathbb{F}}$ is strongly connected.

A locally finitary \mathcal{C} -module category \mathcal{M} is called *simple* provided that \mathcal{M} is non-zero and does not have any non-trivial \mathcal{C} -stable ideals. Every simple \mathcal{C} -module category is automatically transitive. Every locally finitary transitive \mathcal{C} -module category has a unique simple transitive quotient. More generally, every locally finitary \mathcal{C} -module category admits a (possibly infinite) filtration with transitive subquotients. The multiset of the corresponding simple transitive subquotients is independent of the choice of the filtration.

3.6. Abelianization. Given a locally finitary \mathcal{C} -module category \mathcal{M} , the abelianization $\overline{\mathcal{M}}$ of \mathcal{M} is defined as the following category of diagrams over \mathcal{M} , see [MM11]:

- the objects of $\overline{\mathcal{M}}$ are diagrams $\alpha : X \rightarrow Y$ over \mathcal{M} ;
- the morphisms in $\overline{\mathcal{M}}$ from $\alpha : X \rightarrow Y$ to $\alpha' : X' \rightarrow Y'$ are given as the quotient of the space of all solid commutative diagrams over \mathcal{M} as below, modulo the subspace generated by all diagrams for which the right vertical map factors through some dotted morphism:

$$\begin{array}{ccc} X & \xrightarrow{\alpha} & Y \\ \downarrow & \searrow \text{dotted} & \downarrow \\ X' & \xrightarrow{\alpha'} & Y' \end{array}$$

The category $\overline{\mathcal{M}}$ inherits from \mathcal{M} a structure of a \mathcal{C} -module category. Furthermore, $\overline{\mathcal{M}}$ is abelian provided that \mathcal{M} is admissible. In the latter case, $\overline{\mathcal{M}}$ has enough projective objects and \mathcal{M} is equivalent, via the embedding $X \mapsto (0 \rightarrow X)$, to the category of

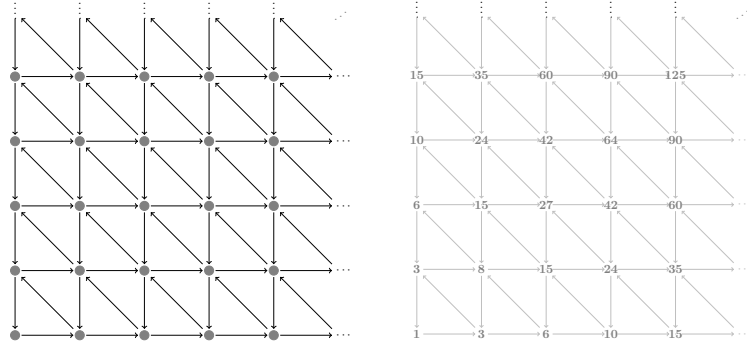

FIGURE 3. The graph of the left regular \mathcal{C} -module category and the corresponding eigenvector

projective objects in $\overline{\mathcal{M}}$. Moreover, for an indecomposable $X \in \mathcal{M}$, mapping the object $0 \rightarrow X$ to its simple top gives rise to a bijection between the indecomposable projective and simple objects in $\overline{\mathcal{M}}$.

For $\theta \in \mathcal{C}$ and two simple objects L and N in $\overline{\mathcal{M}}$, we can define $a_{N,L}^\theta$ as the composition multiplicity of N in θL , which coincides with $\dim \overline{\mathcal{M}}(P_N, \theta L)$, where P_N is the projective cover of N . These can be assembled into the matrix $[[\theta]]$. By [AM11, Lemma 8], the matrix $[[\theta]]$ is transposed to the matrix $[\theta^*]$.

3.7. Positive eigenvectors. Let L be a simple \mathfrak{sl}_3 -module. Consider the \mathcal{C} -module category $\text{add}(\mathcal{C} \cdot L)$. This is an admissible \mathcal{C} -module category. Let us assume that $\{X_i : i \in \mathbf{I}\}$ is a complete and irredundant list of indecomposable objects in $\text{add}(\mathcal{C} \cdot L)$. Then, for every $i \in \mathbf{I}$, we have (see [MMM23]):

$$\text{GKdim}(X_i) = \text{GKdim}(L).$$

Moreover, for the (column) vector $\mathbf{B}_L = (\mathbf{b}(X_i))_{i \in \mathbf{I}}$, from the last property in Subsection 2.6 it follows that

$$\mathbf{B}_L^t [\mathbf{F}] = 3\mathbf{B}_L^t.$$

In particular, 3 is the Perron-Frobenius eigenvalue of $[\mathbf{F}]$ and \mathbf{B}_L is the unique (up to a positive scalar) left Perron-Frobenius eigenvector for that eigenvalue.

Similarly, we can define the vector $\mathbf{B}_{\mathcal{M}}$ for any transitive \mathcal{C} -module category \mathcal{M} and have $\mathbf{B}_{\mathcal{M}}^t [\mathbf{F}] = 3\mathbf{B}_{\mathcal{M}}^t$.

4. THE LEFT REGULAR MODULE CATEGORY

4.1. Basic combinatorics. The left regular \mathcal{C} -module category ${}_{\mathcal{C}}\mathcal{C}$ is transitive with semi-simple underlying category. Consequently, ${}_{\mathcal{C}}\mathcal{C}$ is a simple \mathcal{C} -module category and coincides with $\text{add}(\mathcal{C} \cdot L)$, for any simple finite dimensional \mathfrak{sl}_3 -module L .

The indecomposable objects in \mathcal{C} are $\{L((i, j)) : i, j \in \mathbb{Z}_{\geq 0}\}$. We have:

$$L((1, 0)) \otimes_{\mathbb{C}} L((i, j)) \cong \begin{cases} L((1, 0)), & (i, j) = (0, 0); \\ L((i+1, 0)) \oplus L((i-1, 1)), & i > 0, j = 0; \\ L((1, j)) \oplus L((i, j-1)), & i = 0, j > 0; \\ L((i+1, j)) \oplus L((i-1, j+1)) \oplus L((i, j-1)), & i, j > 0. \end{cases}$$

This implies that the graph $\Gamma_{\mathbf{F}}$ is as in Figure 3. Since the underlying category ${}_{\mathcal{C}}\mathcal{C}$ is semi-simple, the graph $\Gamma_{\mathbf{G}}$ is just the opposite of $\Gamma_{\mathbf{F}}$.

4.2. Eigenvector. Since Γ_F is strongly connected and all vertices have finite degree, from the infinite analogue of the Perron-Frobenius Theorem, the matrix $[F]$ has a unique, up to scalar, eigenvector with strictly positive entries. The corresponding eigenvalue is the Perron-Frobenius eigenvalue of $[F]$.

Clearly, the vector $(\dim(L((i, j)))_{(i, j) \in \mathbb{Z}_{\geq 0}^2}$ is an eigenvector for the matrix $[F]$ with eigenvalue $3 = \dim(L((1, 0)))$. From the definition of $U_{(i, j)}(X, Y)$ it follows directly that $\dim(L((i, j))) = U_{(i, j)}(3, 3)$. It is easy to check that the assignment

$$(i, j) \mapsto \frac{(i+1)(j+1)(i+j+2)}{2}$$

satisfies the same recursion and hence equals $\dim(L((i, j)))$. An alternative way to come to this is to use the Weyl character formula.

This means that the integral sequence

$$\dim(L((0, 0))), \dim(L((1, 0))), \dim(L((0, 1))), \dim(L((2, 0))), \dim(L((1, 1))), \dots$$

is the sequence A107985 in [OEIS].

The above eigenvector is depicted in Figure 3. Clearly, it is also an eigenvector for $[G]$, with the same eigenvalue.

4.3. Simple \mathcal{C} -module categories with the same combinatorics. The following theorem shows that the \mathcal{C} -module category ${}_{\mathcal{C}}\mathcal{C}$ is determined uniquely, up to isomorphism, by its graph and dual graph in the class of admissible simple \mathcal{C} -module categories.

Theorem 1. *Let \mathcal{M} be an admissible simple \mathcal{C} -module category with the same graph and dual graph as ${}_{\mathcal{C}}\mathcal{C}$. Then \mathcal{M} is equivalent to ${}_{\mathcal{C}}\mathcal{C}$.*

Proof. Let $\{M_{(i, j)} : (i, j) \in \mathbb{Z}_{\geq 0}^2\}$ be a complete and irredundant list of representatives of isomorphism classes of indecomposable objects in \mathcal{M} , indexed such that the map $L((i, j)) \mapsto M_{(i, j)}$ induces an isomorphism between the graphs of ${}_{\mathcal{C}}\mathcal{C}$ and \mathcal{M} . Clearly, the graph in Figure 3 has no non-trivial automorphisms, which implies that we automatically have the induced isomorphism between the dual graphs of ${}_{\mathcal{C}}\mathcal{C}$ and \mathcal{M} .

Consider $\overline{\mathcal{M}}$ and let $N_{(i, j)}$ be the simple top of $M_{(i, j)}$ in $\overline{\mathcal{M}}$. Then we have the matrices $[[F]]$ and $[[F^*]]$ which are the transposes of $[F^*]$ and $[F]$, respectively. Now recall that the underline category of ${}_{\mathcal{C}}\mathcal{C}$ is semi-simple. Hence $[F^*]$ is the transpose of $[F]$. Consequently, $[[F]] = [F]$. Similarly,

$$(1) \quad [[\theta]] = [\theta],$$

for any $\theta \in \mathcal{C}$.

The last observation allows us to adopt the argument from [MZ24, Proposition 7]. Denote by \mathcal{N} the category of all semi-simple objects in $\overline{\mathcal{M}}$. For $(i, j) \in \mathbb{Z}_{\geq 0}^2$, we have $L((i, j)) \otimes_{\mathbb{C}} L((0, 0)) \cong L((i, j))$. Therefore (1) implies $L((i, j))(N_{(0, 0)}) \cong N_{(i, j)}$.

For $\theta \in \mathcal{C}$, we thus can write $\theta(N_{(i, j)})$ as $(\theta \otimes_{\mathbb{C}} L((i, j)))(N_{(0, 0)})$ and, from the previous paragraph, it follows that $\theta(N_{(i, j)}) \in \mathcal{N}$. Consequently, \mathcal{N} is stable under the action of \mathcal{C} .

In order to prove the claim of the theorem, we need to show that the radical of \mathcal{M} is \mathcal{C} -invariant. Since \mathcal{C} is monoidally generated by F , it is enough to prove that the radical of \mathcal{M} is F -invariant. The radical of \mathcal{M} is generated by the morphisms of the form $\varphi : X \rightarrow Y$, where X and Y are two non-isomorphism indecomposable objects in

\mathcal{M} , and the radical morphisms of the form $\psi : X \rightarrow X$, where X is an indecomposable object in \mathcal{M} .

In the latter case, ψ is nilpotent as \mathcal{M} is locally finitary. Therefore $F(\psi)$ is nilpotent. Since $F(X)$ is multiplicity free (the graph in Figure 3 does not have any multiple edges), it follows that $F(\psi)$ is a radical morphism.

In the former case, the image of φ belongs to the radical of Y and we need to show that the image of $F(\varphi)$ belongs to the radical of $F(Y)$. For this we apply F to the short exact sequence

$$0 \rightarrow \text{Rad}(Y) \rightarrow Y \rightarrow N_Y \rightarrow 0,$$

where N_Y is the simple top of Y , and obtain a short exact sequence

$$0 \rightarrow F(\text{Rad}(Y)) \rightarrow F(Y) \rightarrow F(N_Y) \rightarrow 0.$$

From (1), we have that the top of $F(Y)$ is isomorphic to $F(N_Y)$. Hence the radical of $F(Y)$ is isomorphic to $F(\text{Rad}(Y))$. The claim follows.

The above shows that \mathcal{M} is equivalent to \mathcal{N} . The Yoneda Lemma implies that, mapping $L((0,0))$ to $N_{(0,0)}$ induces a morphism of \mathcal{C} -module categories from \mathcal{C} to \mathcal{N} . As $L((i,j))(N_{(0,0)}) \cong N_{(i,j)}$ and both categories are semi-simple, this morphism is an equivalence. \square

Remark 2. The argument in the proof of Theorem 1 generalizes to the following situation: Let \mathcal{X} be a semi-simple rigid monoidal category with only one \mathcal{H} -cell in the sense of [MM11], then every admissible simple \mathcal{X} -module category with the same action matrices as for the left regular module category is equivalent to the left regular module category.

5. \mathcal{C} -MODULE CATEGORIES FROM CATEGORY \mathcal{O}

5.1. Category \mathcal{O} . Consider the BGG category \mathcal{O} for \mathfrak{g} , see [BGG76, Hu08]. For $\lambda \in \mathfrak{h}^*$, the corresponding Verma module $\Delta(\lambda)$ and its simple top $L(\lambda)$ are objects in \mathcal{O} . Each $L(\lambda)$ has an indecomposable projective cover in \mathcal{O} , which we denote by $P(\lambda)$. The set $\{L(\lambda) : \lambda \in \mathfrak{h}^*\}$ is a complete and irredundant list of representatives of the isomorphism classes of simple objects in \mathcal{O} .

Category \mathcal{O} is a subcategory of \mathcal{Z} and inherits from the latter the decomposition

$$\mathcal{O} \cong \bigoplus_x \mathcal{O}_x.$$

Category \mathcal{O} is stable under the action of \mathcal{C} and of all projective functors.

5.2. The integral part of \mathcal{O} . Consider the full subcategory \mathcal{O}^{int} of \mathcal{O} consisting of all modules with integral supports, that is, consisting of all $M \in \mathcal{O}$ such that $\text{supp}(M) \subset \Lambda$. We will call $\lambda = (\lambda_1, \lambda_2)$

- a *top weight* provided that $\lambda_1, \lambda_2 \geq 0$;
- a *middle weight* provided that $(\lambda_1 < 0 \text{ and } \lambda_2 \geq 0)$ or $(\lambda_1 \geq 0 \text{ and } \lambda_2 < 0)$;
- a *bottom weight* provided that $\lambda_1, \lambda_2 < 0$.

Note that

- the top weights are exactly the highest weights of simple finite dimensional modules, that is simple objects in \mathcal{C} ;
- the bottom weights are exactly the highest weights of (integral) simple Verma modules.

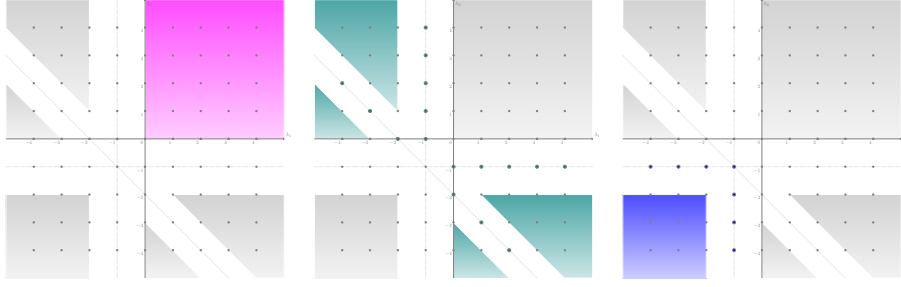
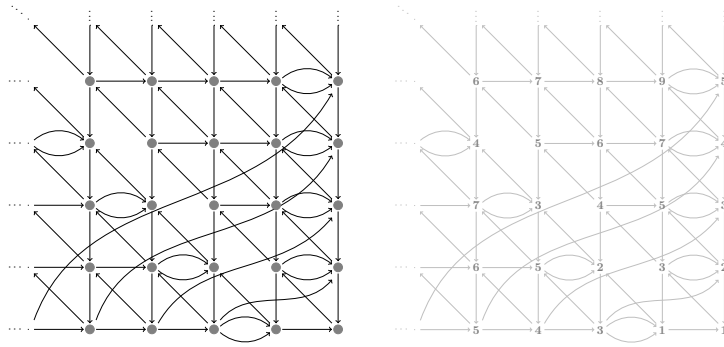

FIGURE 4. Top, middle and bottom integral weights

FIGURE 5. The graph of the upper middle \mathcal{C} -module category \mathcal{N}_1 and the corresponding positive eigenvector

The dot-orbit of an integral λ may have 6, 3 or 1 element. In the first case, λ is *regular*, otherwise it is *singular*. In Figure 4, one can find a depiction of integral weights with top, middle and bottom weights highlighted with different colors; the areas with regular weights shaded, and singular weights lying on dotted lines (the latter are the reflection hyperplanes for the dot action of W).

For a regular, integral and dominant λ and $w \in W$, denote $\theta_{\lambda, w \cdot \lambda}$ simply by θ_w .

For each integral λ , define a module $N(\lambda)$ as follows:

- $N(\lambda) = L(\lambda)$, if λ is a top weight or a singular middle weight;
- $N(\lambda) = \theta_t L(\lambda)$, where $t \in \{r, s\}$ is the unique element such that $\theta_t L(\lambda) \neq 0$, if λ is a regular middle weight;
- $N(\lambda) = P(\lambda)$, if λ is a bottom weight.

If λ is a top weight, then $\text{add}(\mathcal{C} \cdot L(\lambda)) = \mathcal{C}$ and this case has already been studied in Section 4. Hence in what follows we concentrate on middle and bottom λ .

5.3. Upper middle weights. A middle weight λ will be called an upper middle weight provided that $\lambda_2 \geq 0$ and a lower middle weight provided that $\lambda_2 < 0$. In this subsection we fix an upper middle weight λ .

Denote by \mathcal{N}_1 the additive closure of all $N(\mu)$, where μ is an upper middle weight.

Proposition 3. *If λ is a singular upper middle weight, then $\text{add}(\mathcal{C} \cdot L(\lambda))$ coincides with \mathcal{N}_1 , moreover, the latter is a simple transitive \mathcal{C} -module category whose graph and positive eigenvector are depicted in Figure 5.*

Proof. We start by observing that all singular middle weights belong to exactly one wall (either an r -wall or an s -wall, but not both). Therefore, our $L(\lambda)$ can be seen as the translation of some $L(\mu)$, where μ is an upper middle regular weight, to this wall. Translating back, we get exactly $N(\mu)$.

The module $N(\mu)$ has, by construction, simple top and socle isomorphic to $L(\mu)$. It also has one more simple subquotient of the form $L(\mu')$, where μ' is obtained from μ by reflection with respect to the line $x + y = -2$ (here x and y are standard coordinates in the plane), which is again an upper middle regular weight. Note that, sometimes, $N(\mu)$ also has a finite dimensional subquotient which is not very relevant for our story as it is always killed by translation to any wall. Translating $N(\mu)$ to some singular upper middle weight produces either a simple module (if $L(\mu)$ is killed and $L(\mu')$ survives) or a direct sum of two simple modules (if $L(\mu')$ is killed and $L(\mu)$ survives). This implies that $\text{add}(\mathcal{C} \cdot L(\lambda)) = \mathcal{N}_1$.

Now let us argue that \mathcal{N}_1 is simple transitive. Any $N(\mu)$, where μ is upper middle regular, can be translated to any wall and then back to get all other $N(\mu')$ (possibly with some non-zero multiplicities). This implies that \mathcal{N}_1 is transitive.

If $\varphi : N(\mu) \rightarrow N(\mu')$ is a non-zero morphism, we can translate it to a wall such that $L(\mu)$ survives and becomes some $L(\nu)$. The part of \mathcal{N}_1 on the wall that corresponds to the central character of $L(\nu)$ is just a copy of vector spaces with $L(\nu)$ being the simple object. The morphism φ survives translation (as $L(\mu)$ survives it) and hence its translation becomes a non-zero morphism in the category of vector spaces. As the latter category is simple, this non-zero morphism generates the whole category, in particular, it generates the identity on $L(\nu)$. Translating back, we get the identity on all $N(\mu)$. This shows that \mathcal{N}_1 is simple.

It remains to determine the combinatorics of \mathcal{N}_1 . For this, we need to do a case-by-case analysis. Recall that $\text{supp}(L(1, 0)) = \{(1, 0), (0, -1), (-1, 1)\}$.

Case 1. Assume that the weights μ , $\mu + (1, 0)$, $\mu + (0, -1)$ and $\mu + (-1, 1)$ are all regular. In this case, tensoring with $L((1, 0))$ splits into a direct sum of three equivalences: from the block containing $L(\mu)$ to the three blocks containing $L(\mu + (1, 0))$, $L(\mu + (0, -1))$ and $L(\mu + (-1, 1))$, respectively. This implies that the module $L(1, 0) \otimes_{\mathbb{C}} N(\mu)$ splits as

$$N(\mu + (1, 0)) \oplus N(\mu + (0, -1)) \oplus N(\mu + (-1, 1)).$$

This gives the following local picture in the graph (the node μ is in the middle):

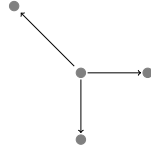

(2)

Case 2. Assume that μ is regular, $\mu_1 = -2$ and $\mu_2 \geq 2$. In this case both $\mu + (0, -1)$ and $\mu + (-1, 1)$ are regular but $\mu + (1, 0)$ is singular. Therefore, we get the direct sum of two equivalences, from the block containing $L(\mu)$ to the two blocks containing $L(\mu + (0, -1))$ and $L(\mu + (-1, 1))$, respectively, together with translation to the wall, from the block containing $L(\mu)$ to the block containing $L(\mu + (1, 0))$. Since $N(\mu)$ has two copies of $L(\mu)$, translating to the wall we obtain two copies of the simple module on the wall. This implies that $L((1, 0)) \otimes_{\mathbb{C}} N(\mu)$ is isomorphic to

$$N(\mu + (-1, 1)) \oplus N(\mu + (0, -1)) \oplus N(\mu + (1, 0)) \oplus N(\mu + (1, 0)),$$

which gives the following local picture in the graph (the node μ is in the middle):



Case 3. Assume that $\mu = (-2, 1)$. In this case μ and $\mu + (-1, 1)$ are regular, while $\mu + (0, -1)$ and $\mu + (1, 0)$ are singular but with different singularities. As in Case 2, we get an equivalence for $\mu + (-1, 1)$ which produces a summand $N(\mu + (-1, 1))$ and two copies of $L(\mu + (1, 0))$. At the same time, we will only get one copy of $L(\mu + (0, -1))$ as $N(\mu)$ has only one copy of $L((-3, 0))$. This means that the combinatorics in this case is exactly the same as in Case 2.

Case 4. Assume that $\mu = (-1, i)$, for $i > 0$. In this case μ and $\mu + (0, -1)$ are singular with the same singularity, while $\mu + (-1, 1)$ is regular and $\mu + (1, 0)$ is not a middle weight. Therefore tensoring with $L((1, 0))$ splits into an equivalence between the blocks containing $L(\mu)$ and $L(\mu + (0, -1))$ and a translation out of the wall from the blocks containing $L(\mu)$ to the block containing $L(\mu + (-1, 1))$. This implies that $L((1, 0)) \otimes_{\mathbb{C}} N(\mu)$ is isomorphic to

$$N(\mu + (-1, 1)) \oplus N(\mu + (0, -1)),$$

which gives the following local picture in the graph (the node μ is in the middle):

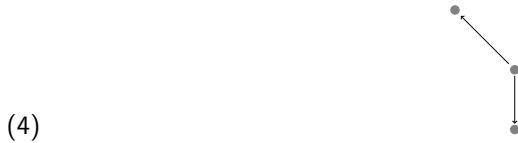

Case 5. Assume that $\mu = (-1, 0)$. In this case μ is singular, while $\mu + (-1, 1)$ is regular and neither $\mu + (1, 0)$ nor $\mu + (0, -1)$ is a middle weight. Therefore tensoring with $L((1, 0))$ gives just translation out of the wall. This implies that $L((1, 0)) \otimes_{\mathbb{C}} N(\mu)$ is isomorphic to $N(\mu + (-1, 1))$ which gives the following local picture in the graph (the node μ is on the south-east):



Case 6. Assume that $\mu = (-2 - i, 1 + i)$, for some $i > 0$. In this case μ , $\mu + (-1, 1)$ and $\mu + (1, 0)$ are regular, while $\mu + (0, -1)$ is singular. Thus, we get two equivalences, from μ to $\mu + (-1, 1)$ and $\mu + (1, 0)$, and one translation to the wall, from μ to $\mu + (0, -1)$. As $N(\mu)$ has only one copy of $L(\mu + (-1, -1))$, the translation to the wall outputs one copy of the corresponding simple module. This means that the combinatorics of this case is exactly the same as in Case 1.

Case 7. Assume that $\mu = (-2, 0)$. In this case μ and $\mu + (-1, 1)$ are singular with the same singularity, while $\mu + (1, 0)$ is singular with different singularity and $\mu + (0, -1)$ is not a middle weight. This gives us an equivalence from μ to $\mu + (-1, 1)$ together with the composition of translation out of the wall (from μ) to some regular weight followed by translation to the wall (to $\mu + (1, 0)$). Translation of a simple out of the wall contains only one copy of the simple which survives the translation to the other wall. Therefore $L((1, 0)) \otimes_{\mathbb{C}} N(\mu)$ is isomorphic to $N(\mu + (-1, 1)) \oplus N(\mu + (1, 0))$ which gives the following local picture in the graph (the node μ is in the middle):

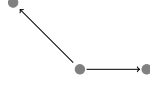

Case 8. Assume that $\mu = (-2 - i, i)$, for some $i > 0$. In this case μ and $\mu + (-1, 1)$ are singular with the same singularity, while $\mu + (1, 0)$ and $\mu + (0, -1)$ are regular but belong to two different connected shaded components. Also, in this case $\mu + (1, 0)$ and $\mu + (0, -1)$ belong to the same dot-orbit of W . Thus, we only get an equivalence from μ to $\mu + (-1, 1)$ and one translation out of the wall from μ to the block containing both $\mu + (1, 0)$ and $\mu + (0, -1)$. This means that the combinatorics of this case is exactly the same as in Case 4.

Case 9. Assume that $\mu = (-3 - i, i)$, for some $i > 0$. In this case, the situation is exactly the same as in Case 2.

We are now left with two most complicated cases.

Case 10. Assume that $\mu = (-3, 0)$. In this case μ and $\mu + (-1, 1) = (-4, 1)$ are regular, $\mu + (1, 0) = (-2, 0)$ is singular and $\mu + (0, -1) = (-3, -1)$ is not a middle weight. However, we have the middle weight $(-1, 1)$ which belongs to the same dot-orbit as $(-3, -1)$ and the difference between $(-1, 1)$ and the weight $(-2, 1)$ which belongs to the same dot-orbit as μ is $(1, 0)$. This means that tensoring with $L((1, 0))$ splits into three summands: an equivalence from μ and $(-4, 1)$ and two translations to walls: from μ to $(-2, 0)$ and from $(-2, 1)$ to $(-1, 1)$. As $[N(\mu) : L(\mu)] = 2$, the first translation produces two simples. As $[N(\mu) : L((-2, 1))] = 1$, the second translation produces one simple. Therefore $L((1, 0)) \otimes_{\mathbb{C}} N(\mu)$ is isomorphic to

$$N((-4, 1)) \oplus N((-2, 0)) \oplus N((-2, 0)) \oplus N((-1, 1)),$$

which gives the following local picture in the graph (the node μ is the source):

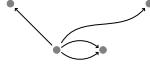

Case 11. Assume that $\mu = (-i, 0)$, for some $i > 3$. In this case μ , $\mu + (-1, 1)$ and $\mu + (1, 0)$ are regular while $\mu + (0, -1)$ is not a middle weight. However, just like in Case 10, the dot-orbit of the weight $\mu + (0, -1)$ contains a middle weight, namely, $(-1, i - 2)$, which has difference $(1, 0)$ to the middle weight $(-2, i - 2)$ which is in the dot-orbit of μ . Therefore, tensoring with $L((1, 0))$ splits again into three summands: two equivalences, from μ to $\mu + (-1, 1)$ and $\mu + (1, 0)$, and a translation to the wall, namely from $(-2, i - 2)$ to $(-1, i - 2)$. Therefore $L((1, 0)) \otimes_{\mathbb{C}} N(\mu)$ is isomorphic to

$$N(\mu + (-1, 1)) \oplus N(\mu + (1, 0)) \oplus N((-1, i - 2)),$$

which gives the following local picture in the graph (the node μ is the source):

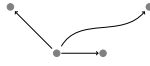

Combining all these cases together, gives the left graph in Figure 5.

Now let us construct a Perron-Frobenius eigenvector for the corresponding matrix, we will see that the corresponding eigenvalue is 3. As the defining property of the middle weights (among all integral weights) one can take the property that the corresponding simple highest weight modules are, on the one hand, infinite dimensional but, on the other hand, not isomorphic to Verma modules. This, in particular, implies that all simple highest weight modules for middle weights have uniformly bounded weight spaces.

For a module M with uniformly bounded weight spaces, denote by $d(M)$ the maximum value of $\dim M_\mu$, taken over all μ . For any simple highest weight module L and for any negative root γ , non-zero elements from \mathfrak{g}_γ act either locally nilpotently or injectively on L . Consequently, as soon as some L_μ has dimension $d(L)$, for any negative root γ for which the non-zero elements from \mathfrak{g}_γ act injectively on L , we have $\dim L_{\mu+\gamma} = d(L)$. Note that, for all upper middle weights ν , the non-zero elements from both $\mathfrak{g}_{-\alpha}$ and $\mathfrak{g}_{-\alpha-\beta}$ act injectively on $L(\nu)$.

This implies that, for all upper middle ν , we have $d(L(\nu) \otimes L((1, 0))) = 3d(L(\nu))$ and that $d(N(\nu))$ is the sum of $d(L(\mu))$, taken over all upper middle subquotients $L(\mu)$ of $N(\nu)$ (counted with the corresponding multiplicities). This implies the equality $d(N(\nu) \otimes L((1, 0))) = 3d(N(\nu))$ and therefore, assigning to an upper middle weight ν the value $d(N(\nu))$ produces an eigenvector for the matrix corresponding to our graph, with the eigenvalue 3. It remains to compute these values $d(N(\nu))$.

For any Verma module $\Delta(\nu)$ and for all $a, b \in \mathbb{Z}_{\geq 0}$, we have

$$\dim \Delta(\nu)_{\nu-a\alpha-b\beta} = \min(a+1, b+1),$$

which equals the value of Kostant's partition function at $a\alpha + b\beta$, that is the number of ways to write $a\alpha + b\beta$ as a linear combination of α , β and $\alpha + \beta$ with non-negative integer coefficients. Consequently, for the quotient $M = \Delta(\nu)/\Delta(\nu - a\alpha - b\beta)$, we have $d(M) = \max(a, b)$.

From [Di96, Theorem 7.6.23], for any middle upper weight $\mu = (\mu_1, \mu_2)$, we have the embedding

$$\Delta(\mu - (\mu_2 + 1)(-1, 2)) \subset \Delta(\mu)$$

as well as the embedding

$$\Delta(\mu - (\mu_2 - \mu_1 + 2)(1, 1)) \subset \Delta(\mu).$$

This implies that $d(L(\mu))$ is given by the following table:

\dots	\vdots	\vdots	\vdots	\vdots	\vdots	\vdots
\dots	1	2	3	4	5	4
\dots	4	1	2	3	4	3
\dots	3	3	1	2	3	2
\dots	2	2	2	1	2	1
\dots	1	1	1	1	1	0
\dots	-5	-4	-3	-2	-1	$\mu_1 \setminus \mu_2$

Now, for **singular weights (shown in purple)**, we have $L(\mu) = N(\mu)$, thus the table above already outputs $d(N(\mu))$. For regular weights (shown in black), we know that $[N(\mu) : L(\mu)] = 2$ and $[N(\mu) : L(\mu')] = 1$, where μ' is a reflection of μ with respect to the diagonal singular line. Taking the corresponding linear combination of the values gives exactly the right hand side picture in Figure 5. For the record, here is an explicit formula for $d(N(\mu))$:

$$d(N(\mu)) = \begin{cases} \mu_2 + 1, & \mu_1 = -1 \text{ or } \mu_1 + \mu_2 = -2; \\ 2\mu_2 + \mu_1 + 3, & -2 < \mu_1 + \mu_2 \text{ and } \mu_1 < -1; \\ \mu_2 - \mu_1, & \mu_1 + \mu_2 < -2. \end{cases}$$

It is easy to check that this is, indeed, an eigenvector with eigenvalue 3, that is, that three times the value at each vertex v coincides with the sum, taken over all arrows $\eta : v \rightarrow w$ that start at v , of the values at the corresponding endpoints w . This completes the proof of our proposition. \square

Proposition 4. *Let λ be a regular upper middle weight. Then we have:*

- (a) *The \mathcal{C} -module category $\text{add}(\mathcal{C} \cdot L(\lambda))$ contains \mathcal{N}_1 as a \mathcal{C} -module subcategory.*
- (b) *The quotient of $\text{add}(\mathcal{C} \cdot L(\lambda))$ by the ideal \mathcal{I} generated by \mathcal{N}_1 is a simple transitive \mathcal{C} -module category that is equivalent to ${}_{\mathcal{C}}\mathcal{C}$.*
- (c) *The indecomposable objects in $\text{add}(\mathcal{C} \cdot L(\lambda))/\mathcal{I}$ are given by the images of $L(\mu)$, where μ is a regular upper middle weight from the same shaded connected component as λ , see Figure 4.*

Proof. We can translate $L(\lambda)$ to a wall to obtain some singular $L(\lambda') \in \text{add}(\mathcal{C} \cdot L(\lambda))$. Now Claim (a) follows from Proposition 3.

If we do not translate to any wall, the only projective functors that remain are equivalences between regular blocks. These send simples to simples. Also note that the two connected shaded upper middle weight components are separated by a wall. To go from one of these components to another one, we must cross this wall in which case we end up in the \mathcal{C} -module subcategory \mathcal{N}_1 . This implies Claim (c).

Finally, for Claim (b), we can now apply Theorem 1. For this we just note that the combinatorics of tensoring with $L((1, 0))$ between the regular simples within one connected shaded component is the same as the combinatorics of tensoring with $L((1, 0))$ in ${}_{\mathcal{C}}\mathcal{C}$. This is clear because we can transform our connected component to the component of top weights by applying some Weyl group element. This completes the proof. \square

5.4. Lower middle weights. In this subsection we fix a lower middle weight λ . Denote by \mathcal{N}_2 the additive closure of all $N(\mu)$, where μ is a lower middle weight.

Proposition 5. *If λ is a singular lower middle weight, then $\text{add}(\mathcal{C} \cdot L(\lambda))$ coincides with \mathcal{N}_2 , moreover, the latter is a simple transitive \mathcal{C} -module category whose graph and positive eigenvector are depicted in Figure 6.*

Proof. Mutatis mutandis the proof of Proposition 3. \square

We note that the \mathcal{C} -module categories \mathcal{N}_1 and \mathcal{N}_2 are not equivalent. In fact, they have different combinatorics: comparing Figure 5 with Figure 6 we see that the graphs are not isomorphic. Indeed, in Figure 5, the points of indegree 3 form an infinite chain of the form

$$\dots \longrightarrow \bullet \longrightarrow \bullet \longrightarrow \bullet$$

while, in Figure 6, the points of indegree 3 form an infinite chain of the form

$$\bullet \longrightarrow \bullet \longrightarrow \bullet \longrightarrow \dots$$

This is explained by the lack of symmetry between the two cases. While all upper middle weights can be transferred to lower middle weights by a Weyl group element, the additional influence of the support of $L((1, 0))$ is asymmetric in the two cases. This stays in a sharp contrast to the action of projective functors on a fixed block of category \mathcal{O} . In that case, the actions on the upper middle part and on the lower middle part are equivalent, see [MM11, MS08].

Proposition 6. *Let λ be a regular lower middle weight. Then we have:*

- (a) *The \mathcal{C} -module category $\text{add}(\mathcal{C} \cdot L(\lambda))$ contains \mathcal{N}_2 as a \mathcal{C} -module subcategory.*
- (b) *The quotient of $\text{add}(\mathcal{C} \cdot L(\lambda))$ by the ideal \mathcal{I} generated by \mathcal{N}_2 is a simple transitive \mathcal{C} -module category that is equivalent to ${}_{\mathcal{C}}\mathcal{C}$.*

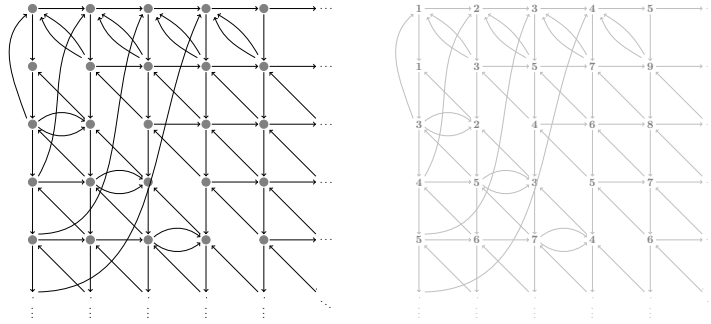

FIGURE 6. The graph of the lower middle \mathcal{C} -module category \mathcal{N}_2 and the corresponding positive eigenvector

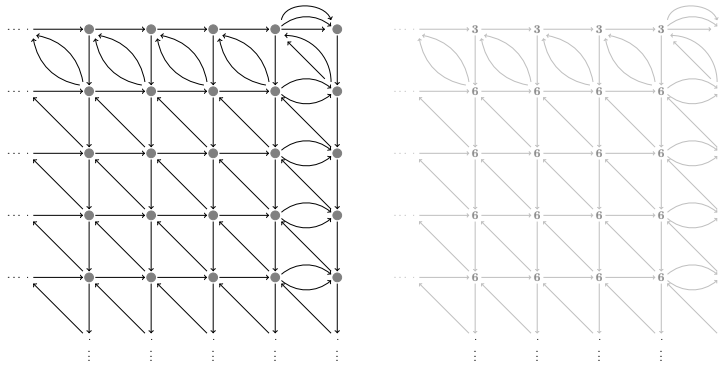

FIGURE 7. The graph of the bottom \mathcal{C} -module category \mathcal{N}_3 and the corresponding positive eigenvector

(c) *The indecomposable objects in $\text{add}(\mathcal{C} \cdot L(\lambda))/\mathcal{I}$ are given by the images of $L(\mu)$, where μ is a regular lower middle weight from the same shaded connected component as λ , see Figure 4.*

Proof. Mutatis mutandis the proof of Proposition 4. □

5.5. Bottom weights. In this subsection we fix a bottom weight λ . Denote by \mathcal{N}_3 the additive closure of all $N(\mu)$, where μ is a bottom weight.

Proposition 7. *The \mathcal{C} -module category $\text{add}(\mathcal{C} \cdot L((-1, -1)))$ coincides with \mathcal{N}_3 , moreover, the latter is a simple transitive \mathcal{C} -module category whose graph and positive eigenvector are depicted in Figure 7.*

Proof. To start with, let us note that the bottom weights are exactly those integral weights for which the corresponding projective modules are injective. As projective functors have biadjoints, they preserve projective-injective modules. This implies that \mathcal{N}_3 is a \mathcal{C} -module category.

The weight $(-1, -1)$ is a fixed point for the dot-action of W . This implies that $L((-1, -1)) = P((-1, -1))$, moreover, this module is also injective. As projective functors preserve projective-injective modules, it follows that $\text{add}(\mathcal{C} \cdot L((-1, -1)))$ is a subcategory of \mathcal{N}_3 . On the other hand, any integral projective-injective module can be translated to the most singular wall, that is to the additive closure of $L((-1, -1))$. This

gives us the reversed inclusion and thus implies that $\text{add}(\mathcal{C} \cdot L((-1, -1)))$ coincides with \mathcal{N}_3 .

The simple tops (and socles) of projective-injective modules are simple Verma modules. Any non-zero homomorphism between two projective-injective modules hence induces the identity map between the corresponding simple Verma subquotients. Translating this to the additive closure of $L((-1, -1))$, we get the identity map on $L((-1, -1))$. By the previous paragraph, that generates the whole of \mathcal{N}_3 under the action of \mathcal{C} . This implies that \mathcal{N}_3 is a simple transitive \mathcal{C} -module category.

It remains to determine the combinatorics. For this, let us recall that every projective object in \mathcal{O} has a Verma flag, that is a filtration whose subquotients are Verma modules. For a module M with a Verma flag, let us denote by $v(M)$ the length of a Verma flag of M , which can be alternatively described as follows: $v(M) = \sum_{\text{bottom } \mu} [M : L(\mu)]$.

Clearly, $v(M \otimes L((1, 0))) = 3v(M)$, which implies that sending a bottom weight μ to $v(N(\mu))$ gives an eigenvector with eigenvalue 3 for the graph of \mathcal{N}_3 .

Note that $v(N(\mu))$ equals $\frac{|W|}{|G|}$, where G is the dot-stabilizer of μ in W . Consequently, $v(N(\mu)) = |W| = 6$ if μ is regular, further $v(N(-1, -1)) = 1$ and, finally, $v(N(\mu)) = 3$ for all other singular weights. This is depicted on the right hand side of Figure 7. To determine the graph of \mathcal{N}_3 , we should again go into a case-by-case analysis.

Case 1. Assume that the weights μ , $\mu + (1, 0)$, $\mu + (0, -1)$ and $\mu + (-1, 1)$ are all regular. This is exactly analogous to Case 1 in the proof of Proposition 3 and produces the local picture (2).

Case 2. Assume that the weights μ , $\mu + (0, -1)$ and $\mu + (-1, 1)$ are regular and $\mu + (1, 0)$ is singular. This is exactly analogous to Case 2 in the proof of Proposition 3 and produces the local picture (3).

Case 3. Assume that the weights μ , $\mu + (0, -1)$ and $\mu + (1, 0)$ are regular and $\mu + (-1, 1)$ is singular. The symmetry argument, when compared with the previous case, outputs the following local picture:

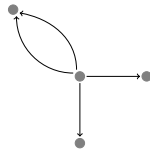

Case 4. Assume that the weights μ and $\mu + (0, -1)$ are regular while $\mu + (1, 0)$ and $\mu + (-1, 1)$ are singular. In this case $\mu = (-2, -2)$. Here, by merging the Cases 2 and 3 we obtain the following local picture:

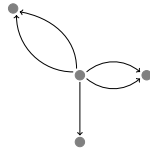

Case 5. Assume that the weights μ and $\mu + (0, -1)$ are singular with the same singularity, $\mu + (-1, 1)$ is regular and $\mu + (1, 0)$ is not a bottom weight. This is exactly analogous to Case 4 in the proof of Proposition 3 and produces the local picture (4).

Case 6. Assume that the weights μ and $\mu + (1, 0)$ are singular with the same singularity, $\mu + (0, -1)$ is regular and $\mu + (-1, 1)$ is not a bottom weight. The symmetry argument, when compared with the previous case, outputs the following local picture:

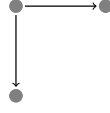

Case 7. Assume that the weights μ , $\mu + (-1, 1)$ and $\mu + (0, -1)$ are singular while $\mu + (1, 0)$ is not a bottom weight. In this case $\mu = (-1, -2)$. One summand of tensoring with $L((1, 0))$ will be an equivalence between the singular blocks of $(-1, -2)$ and $(-1, -3)$. As $\mu + (1, 0)$ is in the same dot orbit as $\mu + (-1, 1)$, we will get a double contribution for translation from the $(-1, -2)$ -block to the $(-2, -1)$ -block. Hence we get the following local picture:

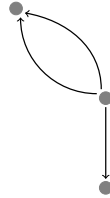

Case 8. Assume that the weights μ and $\mu + (1, 0)$ are singular, $\mu + (0, -1)$ is regular while $\mu + (-1, 1)$ is not a bottom weight. In this case $\mu = (-2, -1)$. Note that $\mu + (-1, 1)$ is in the same dot orbit as the regular weight $\mu + (0, -1)$. So, they together give one summand of translation out of the wall from $(-2, -1)$ and $(-2, -2)$. Additionally, we also have a translation from $(-2, -1)$ to the most singular weight $(-1, -1)$. As here the stabilizer grows by a factor of 3, we will have three arrows in the graph, giving us the following local picture:

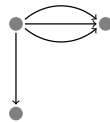

Case 9. Assume that $\mu = (-1, -1)$. This is the most singular point. For it, tensoring with $L((1, 0))$ produces just a translation out of the most singular wall to the singular weight $(-1, -2)$. This results in one arrow from μ to $(-1, -2)$.

The final graph of \mathcal{N}_3 is depicted on the left hand side of Figure 7. □

Proposition 8. Assume that λ is a bottom weight of the form $(a, -1)$, for some element $a \in \{-2, -3, \dots\}$. Then we have:

- (a) The \mathcal{C} -module category $\text{add}(\mathcal{C} \cdot L(\lambda))$ contains \mathcal{N}_3 as a \mathcal{C} -module subcategory.
- (b) The quotient of $\text{add}(\mathcal{C} \cdot L(\lambda))$ by the ideal \mathcal{I} generated by \mathcal{N}_3 is a simple transitive \mathcal{C} -module category that is equivalent to \mathcal{N}_1 .

Proof. We can translate the module $L(\lambda)$ to the most singular weight $(-1, -1)$ to obtain $L((-1, -1))$. This implies that $\text{add}(\mathcal{C} \cdot L((-1, -1))) = \mathcal{N}_3$ is a \mathcal{C} -module subcategory of $\text{add}(\mathcal{C} \cdot L(\lambda))$, proving Claim (a).

To prove Claim (b), we start by noting that $L(\lambda)$ is a Verma module, since λ is a bottom weight. Therefore all modules in $\text{add}(\mathcal{C} \cdot L(\lambda))$ are tilting modules in \mathcal{O} , that is, self-dual modules with Verma flag. Consider the adjoint of the twisting functor Υ_{w_0} , see [AS03, KM05]. This functor maps anti-dominant Verma modules to dominant Verma modules, commutes with the action of \mathcal{C} and induces an equivalence between the categories of tilting and projective modules in \mathcal{O} . This means that $\text{add}(\mathcal{C} \cdot L(\lambda))$ is equivalent, as a \mathcal{C} -module subcategory, to $\text{add}(\mathcal{C} \cdot \Delta(\tilde{\lambda}))$, where $\tilde{\lambda}$ is the dominant weight in the dot W -orbit of λ . Note that $\tilde{\lambda}$ is an upper middle weight.

Since $\tilde{\lambda}$ is dominant, the module $\Delta(\tilde{\lambda})$ is projective in \mathcal{O} . As projective functors preserve projective modules, it follows that $\text{add}(\mathcal{C} \cdot \Delta(\tilde{\lambda}))$ is a subcategory of the category of all projective modules in \mathcal{O} . We claim that $\text{add}(\mathcal{C} \cdot \Delta(\tilde{\lambda}))$ is the additive closure of all $P(\mu)$, where μ is either an upper middle weight or a bottom weight.

Indeed, let ν be either a top weight or a lower middle weight and θ a projective functor. Then, by adjunction,

$$\text{Hom}(\theta P(\tilde{\lambda}), L(\nu)) \cong \text{Hom}(P(\tilde{\lambda}), \theta^* L(\nu)).$$

In the previous subsections, we have seen that $\theta^* L(\nu)$ can only have top or lower middle subquotients. Therefore $\text{Hom}(P(\tilde{\lambda}), \theta^* L(\nu)) = 0$ and we conclude that all indecomposable summands of $\theta P(\tilde{\lambda})$ are given by either bottom or upper middle weights.

The additive closure of all indecomposable projective modules indexed by bottom weights is exactly \mathcal{N}_3 . Factoring out from $\text{add}(\mathcal{C} \cdot \Delta(\tilde{\lambda}))$ the ideal generated by the bottom projectives, each $P(\mu)$, where μ is an upper middle weight, is replaced by $P(\mu)/K$, where K is the trace of all bottom projectives in $P(\mu)$. This quotient surjects onto $N(\mu)$ and the kernel of this surjection has only simple subquotients indexed by either lower middle weights or top weights. Since we do not have any corresponding projectives in our picture, the kernel makes no contribution to our story. Now Claim (b) follows from Proposition 3 and the proof is complete. \square

Proposition 9. *Assume that λ is a bottom weight of the form $(-1, b)$, for some element $b \in \{-2, -3, \dots\}$. Then we have:*

- (a) *The \mathcal{C} -module category $\text{add}(\mathcal{C} \cdot L(\lambda))$ contains \mathcal{N}_3 as a \mathcal{C} -module subcategory.*
- (b) *The quotient of $\text{add}(\mathcal{C} \cdot L(\lambda))$ by the ideal \mathcal{I} generated by \mathcal{N}_3 is a simple transitive \mathcal{C} -module category that is equivalent to \mathcal{N}_2 .*

Proof. Mutatis mutandis the proof of Proposition 8. \square

Proposition 10. *Assume that λ is a regular bottom weight. Then we have:*

- (a) *The \mathcal{C} -module category $\text{add}(\mathcal{C} \cdot L(\lambda))$ contains \mathcal{N}_3 as a \mathcal{C} -module subcategory.*
- (b) *The \mathcal{C} -module category $\text{add}(\mathcal{C} \cdot L(\lambda))$ contains $\text{add}(\mathcal{C} \cdot L((-1, -2)))$ as a \mathcal{C} -module subcategory.*
- (c) *The \mathcal{C} -module category $\text{add}(\mathcal{C} \cdot L(\lambda))$ contains $\text{add}(\mathcal{C} \cdot L((-2, -1)))$ as a \mathcal{C} -module subcategory.*
- (d) *The category \mathcal{N}_3 coincides with the intersection of $\text{add}(\mathcal{C} \cdot L((-1, -2)))$ with $\text{add}(\mathcal{C} \cdot L((-2, -1)))$ inside $\text{add}(\mathcal{C} \cdot L(\lambda))$.*
- (e) *The quotient of $\text{add}(\mathcal{C} \cdot L(\lambda))$ by the ideal \mathcal{I} , generated by \mathcal{N}_3 , $\text{add}(\mathcal{C} \cdot L((-1, -2)))$ and $\text{add}(\mathcal{C} \cdot L((-2, -1)))$, is a simple transitive \mathcal{C} -module category that is equivalent to ${}_{\mathcal{C}}\mathcal{C}$.*

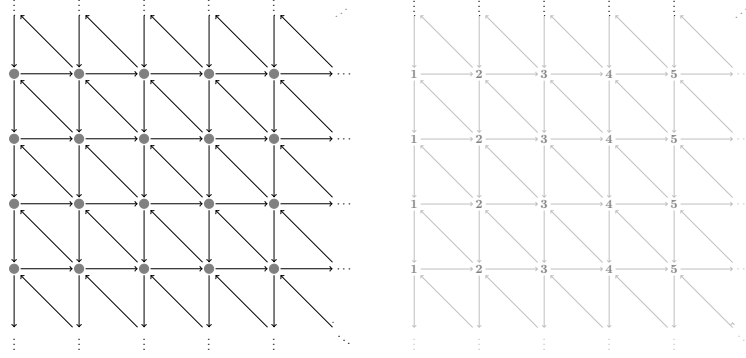

FIGURE 8. The first case of partially integral weights

Proof. As λ is regular and anti-dominant, the module $L(\lambda)$ is a regular tilting module in \mathcal{O} and hence $\text{add}(\mathcal{C} \cdot L(\lambda))$ coincides with the category of (integral) tilting modules in \mathcal{O} . Applying \mathbb{T}_{w_0} , just like in the proof of Proposition 8, we get an equivalence of \mathcal{C} -module categories between $\text{add}(\mathcal{C} \cdot L(\lambda))$ and the category of integral projective modules in \mathcal{O} .

The subcategory of all integral projective-injective modules is exactly \mathcal{N}_3 , proving Claim (a). Extending this \mathcal{N}_3 by all projective modules indexed by lower middle weights and taking the additive closure, we get exactly $\text{add}(\mathcal{C} \cdot L((-1, -2)))$, as was shown in the proof of Proposition 9. This proves Claim (b). Extending \mathcal{N}_3 by all projective modules indexed by upper middle weights, we similarly get $\text{add}(\mathcal{C} \cdot L((-2, -1)))$. This proves Claim (c) and Claim (d).

Factoring from the category of projective modules out the ideal generated by all bottom and middle projectives, each $P(\mu)$, where μ is a top weight, is replaced by $P(\mu)/K$, where K is the trace of all middle and bottom projectives in $P(\mu)$. This quotient is exactly $L(\mu)$. Now Claim (e) follows from Theorem 1 and the proof is complete. \square

5.6. Partially integral weights. For $a \in \mathbb{C} \setminus \mathbb{Z}$, consider the set $(0, a) + \Lambda$. We split this set into a disjoint union $(0, a) + \Lambda = X_1 \cup X_2$, where X_1 consists of all $\lambda \in (0, a) + \Lambda$ such that $\lambda_1 \geq 0$ and X_2 is the complement of X_1 inside $(0, a) + \Lambda$. Denote by \mathcal{M}_1^a the additive closure of all $L(\lambda)$, where $\lambda \in X_1$.

Proposition 11. *For any $\lambda \in X_1$, the \mathcal{C} -module category $\text{add}(\mathcal{C} \cdot L(\lambda))$ coincides with \mathcal{M}_1^a , moreover, the latter is a simple transitive \mathcal{C} -module category whose graph and positive eigenvector are depicted in Figure 8.*

Proof. For $\lambda \in X_1$ the intersection of the dot-orbit of λ with $(0, a) + \Lambda$ consists of λ and $s \cdot \lambda$. Therefore, for each $\lambda \in X_1$, we have a short exact sequence

$$0 \rightarrow L(s \cdot \lambda) \rightarrow \Delta(\lambda) \rightarrow L(\lambda) \rightarrow 0.$$

The module $L((1, 0)) \otimes_{\mathbb{C}} \Delta(\lambda)$ has a standard filtration (Verma flag) whose subquotients are $\Delta(\lambda + (1, 0))$, $\Delta(\lambda + (0, -1))$ and $\Delta(\lambda + (-1, 1))$, each occurring with multiplicity one. For $\lambda \in X_1$, the weights $\lambda + (1, 0)$, $\lambda + (0, -1)$ and $\lambda + (-1, 1)$ belong to different dot-orbits and hence the modules $\Delta(\lambda + (1, 0))$, $\Delta(\lambda + (0, -1))$ and $\Delta(\lambda + (-1, 1))$ have different central characters. Therefore, $L((1, 0)) \otimes_{\mathbb{C}} \Delta(\lambda)$ splits as their direct sum.

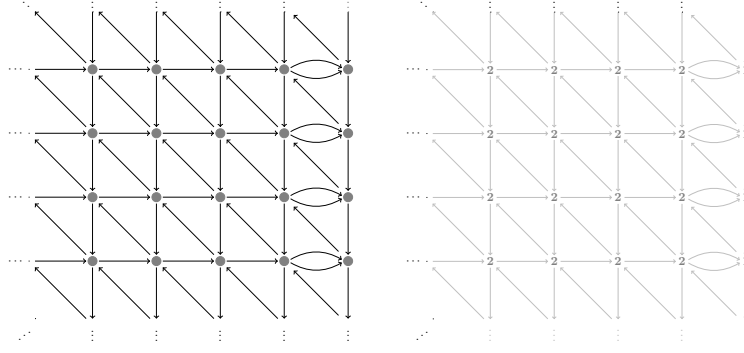

FIGURE 9. The second case of partially integral weights

Next we observe that, if $\lambda_1 \neq 0$, then all three weights $\lambda + (1, 0)$, $\lambda + (0, -1)$ and $\lambda + (-1, 1)$ still belong to X_1 . Therefore, in this case the module $L((1, 0)) \otimes_{\mathbb{C}} L(\lambda)$ splits as a direct sum of $L(\lambda + (1, 0))$, $L(\lambda + (0, -1))$ and $L(\lambda + (-1, 1))$.

If $\lambda_1 = 0$, then $\lambda + (1, 0) \in X_1$ and $\lambda + (0, -1) \in X_1$ but $\lambda + (-1, 1) \notin X_1$. Therefore, in this case the module $L((1, 0)) \otimes_{\mathbb{C}} L(\lambda)$ splits as a direct sum of $L(\lambda + (1, 0))$ and $L(\lambda + (0, -1))$. This implies both that $\text{add}(\mathcal{C} \cdot L(\lambda))$ coincides with \mathcal{M}_1^a and that the latter is simple transitive. We also have that the combinatorics of this simple transitive \mathcal{C} -module category is described by the left part of Figure 8.

It is straightforward to verify that the right part of Figure 8 provides an eigenvector, as claimed. \square

Denote by \mathcal{M}_2^a the additive closure of all $P(\lambda)$, where $\lambda \in X_2$.

Proposition 12. (a) For $\lambda \in X_2$ such that $\lambda_1 = -1$, $\text{add}(\mathcal{C} \cdot L(\lambda))$ coincides with \mathcal{M}_2^a and is a simple transitive \mathcal{C} -module category whose graph and positive eigenvector are depicted in Figure 9.

(b) For $\lambda \in X_2$ such that $\lambda_1 \neq -1$, $\text{add}(\mathcal{C} \cdot L(\lambda))$ contains \mathcal{M}_2^a as a \mathcal{C} -module subcategory, moreover, the quotient of $\text{add}(\mathcal{C} \cdot L(\lambda))$ by the ideal \mathcal{I} generated by \mathcal{M}_2^a is a simple transitive \mathcal{C} -module category that is equivalent to \mathcal{M}_1^a .

(c) If $\lambda_1 \neq -1$, then the indecomposable objects in $\text{add}(\mathcal{C} \cdot L(\lambda))/\mathcal{I}$ are given by the images of $L(\mu)$, where $\mu \in X_2$ is such that $\mu_1 \neq -1$.

Proof. A weight $\lambda \in X_2$ is singular if and only if $\lambda_1 = -1$. The integral Weyl group of all weights in $(0, a) + \Lambda$ equals $\{e, s\}$. Consequently, $L(\lambda) = P(\lambda) = I(\lambda)$ for all singular weights in X_2 .

Note that X_2 coincides with the set of all antidominant weights in $(0, a) + \Lambda$ (with respect to the integral Weyl group), equivalently, the set of all weights for which the corresponding projective module is injective. As applying projective functors preserves both projectivity and injectivity, it follows that, for each singular $\lambda \in X_2$, the category $\text{add}(\mathcal{C} \cdot L(\lambda))$ is a subcategory of \mathcal{M}_2^a .

Let us determine the combinatorics of \mathcal{M}_2^a . If $\lambda \in X_2$ is regular, then we have a short exact sequence

$$0 \rightarrow \Delta(s \cdot \lambda) \rightarrow P(\lambda) \rightarrow \Delta(\lambda) \rightarrow 0.$$

We have to consider three cases

Case 1. Assume $\lambda_1 \leq -3$. Looking at the Verma filtration of $L((1,0)) \otimes_{\mathbb{C}} P(\lambda)$, we see that the highest weights in X_2 of the Verma subquotients appearing in that filtration are $\lambda + (1,0)$, $\lambda + (0,-1)$ and $\lambda + (-1,1)$, each appearing with multiplicity one. As all these weights belong to X_2 and are regular, it follows that

$$L((1,0)) \otimes_{\mathbb{C}} P(\lambda) \cong P(\lambda + (1,0)) \oplus P(\lambda + (0,-1)) \oplus P(\lambda + (-1,1)).$$

Case 2. Assume $\lambda_1 = -2$. Looking at the Verma filtration of $L((1,0)) \otimes_{\mathbb{C}} P(\lambda)$, we see that the highest weights in X_2 of the Verma subquotients appearing in that filtration are $\lambda + (1,0)$, $\lambda + (0,-1)$ and $\lambda + (-1,1)$. However, the weights $\lambda + (0,-1)$ and $\lambda + (-1,1)$ appear with multiplicity one while the weight $\lambda + (1,0)$ appears with multiplicity two (as $\lambda + (1,0) = s \cdot \lambda + (-1,1)$). As all these weights belong to X_2 , it follows that

$$L((1,0)) \otimes_{\mathbb{C}} P(\lambda) \cong P(\lambda + (1,0)) \oplus P(\lambda + (1,0)) \oplus P(\lambda + (0,-1)) \oplus P(\lambda + (-1,1)).$$

Case 3. Assume $\lambda_1 = -1$. Looking at the Verma filtration of $L((1,0)) \otimes_{\mathbb{C}} P(\lambda)$, we see that the highest weights in X_2 of the Verma subquotients appearing in that filtration are $\lambda + (0,-1)$ and $\lambda + (-1,1)$, both appearing with multiplicity one. It follows that

$$L((1,0)) \otimes_{\mathbb{C}} P(\lambda) \cong P(\lambda + (0,-1)) \oplus P(\lambda + (-1,1)).$$

Combining the three cases, we get that the combinatorics of \mathcal{M}_2^a is given by the graph on the left hand side of Figure 9. As this graph is strongly connected, it follows that \mathcal{M}_2^a is transitive. That the right hand side of Figure 9 provides an eigenvector follows from a direct computation. Note that this eigenvector can be interpreted as the Verma length of the projective object corresponding to a vertex.

The category \mathcal{M}_2^a is not semi-simple, however, there are no homomorphisms between different indecomposable objects in \mathcal{M}_2^a . In fact, for $\lambda \in X_2$, the endomorphism algebra of $P(\lambda)$ is trivial if and only if λ is singular. If λ is regular, this endomorphism algebra is isomorphic to the algebra of dual numbers. Let \mathcal{J} be a \mathcal{C} -stable ideal of \mathcal{M}_2^a different from \mathcal{M}_2^a . Then \mathcal{J} must contain a non-zero radical endomorphism of some regular $P(\lambda)$. Translating this onto the s -wall gives a non-zero endomorphism there. Since the block on the wall is semi-simple, it follows that \mathcal{J} contains the identity morphism of some non-zero singular object. Since \mathcal{M}_2^a is transitive, it follows that $\mathcal{J} = \mathcal{M}_2^a$, a contradiction. This proves that \mathcal{M}_2^a is simple transitive. This proves Claim (a).

Denote that \mathcal{M} the additive closure of all $P(\lambda)$, where $\lambda \in (0,a) + \Lambda$. For a regular $\lambda \in X_2$, the functor \mathbb{T}_s induces an equivalence of \mathcal{C} -module categories between \mathcal{M} and $\text{add}(\mathcal{C} \cdot L(\lambda))$. The category \mathcal{M}_2^a is a \mathcal{C} -module subcategory of \mathcal{M} . Factoring out of \mathcal{M} the ideal generated by \mathcal{M}_2^a outputs the additive closure of all $P(\lambda)$, where $\lambda \in X_1$. As all these modules have trivial endomorphism algebra, it follows that this quotient is a semi-simple category. By mapping each $P(\lambda)$, where $\lambda \in X_1$, to its simple top, defines an equivalence of \mathcal{C} -module categories between this quotient and \mathcal{M}_1^a . This implies Claims (b) and (c) and completes the proof. \square

For $a \in \mathbb{C} \setminus \mathbb{Z}$, consider the set $(a,0) + \Lambda$. We split this set into a disjoint union $(a,0) + \Lambda = X_3 \cup X_4$, where X_3 consists of all $\lambda \in (a,0) + \Lambda$ such that $\lambda_2 \geq 0$ and X_4 is the complement of X_3 inside $(a,0) + \Lambda$. Denote by \mathcal{M}_3^a the additive closure of all $L(\lambda)$, where $\lambda \in X_3$.

Proposition 13. *For any $\lambda \in X_3$, the \mathcal{C} -module category $\text{add}(\mathcal{C} \cdot L(\lambda))$ coincides with \mathcal{M}_3^a , moreover, the latter is a simple transitive \mathcal{C} -module category whose graph and positive eigenvector are depicted in Figure 10.*

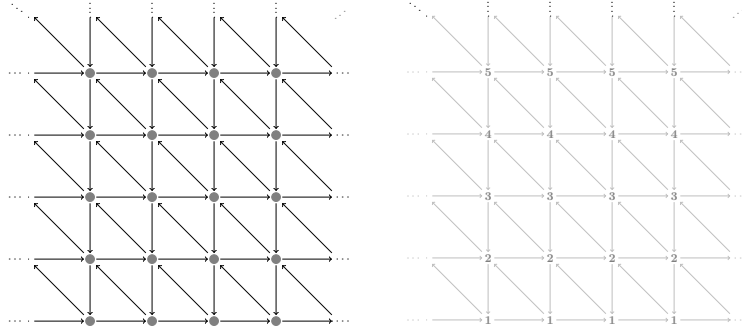

FIGURE 10. The third case of partially integral weights

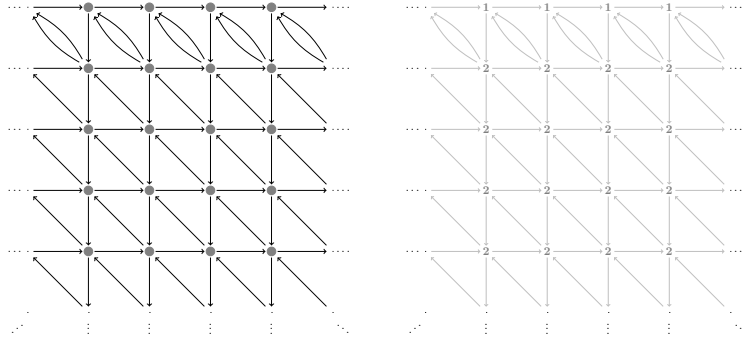

FIGURE 11. The fourth case of partially integral weights

Proof. Mutatis mutandis the proof of Proposition 11. □

Denote by \mathcal{M}_4^a the additive closure of all $P(\lambda)$, where $\lambda \in X_4$.

Proposition 14. (a) For $\lambda \in X_4$ such that $\lambda_2 = -1$, $\text{add}(\mathcal{C} \cdot L(\lambda))$ coincides with \mathcal{M}_4^a and is a simple transitive \mathcal{C} -module category whose graph and positive eigenvector are depicted in Figure 11.

(b) For $\lambda \in X_4$ such that $\lambda_2 \neq -1$, $\text{add}(\mathcal{C} \cdot L(\lambda))$ contains \mathcal{M}_4^a as a \mathcal{C} -module subcategory, moreover, the quotient of $\text{add}(\mathcal{C} \cdot L(\lambda))$ by the ideal \mathcal{I} generated by \mathcal{M}_4^a is a simple transitive \mathcal{C} -module category that is equivalent to \mathcal{M}_3^a .

(c) If $\lambda_2 \neq -1$, then the indecomposable objects in $\text{add}(\mathcal{C} \cdot L(\lambda))/\mathcal{I}$ are given by the images of $L(\mu)$, where $\mu \in X_4$ is such that $\mu_2 \neq -1$.

Proof. Mutatis mutandis the proof of Proposition 12. □

For $a \in \mathbb{C} \setminus \mathbb{Z}$, consider the set $(a, -a) + \Lambda$. We split this set into a disjoint union $(a, -a) + \Lambda = X_5 \cup X_6$, where X_5 consists of all $\lambda \in (a, -a) + \Lambda$ such that $\lambda_1 + \lambda_2 \geq 0$ and X_6 is the complement of X_5 inside $(a, -a) + \Lambda$. Denote by \mathcal{M}_5^a the additive closure of all $L(\lambda)$, where $\lambda \in X_5$.

Proposition 15. For any $\lambda \in X_5$, the \mathcal{C} -module category $\text{add}(\mathcal{C} \cdot L(\lambda))$ coincides with \mathcal{M}_5^a , moreover, the latter is a simple transitive \mathcal{C} -module category whose graph and positive eigenvector are depicted in Figure 12.

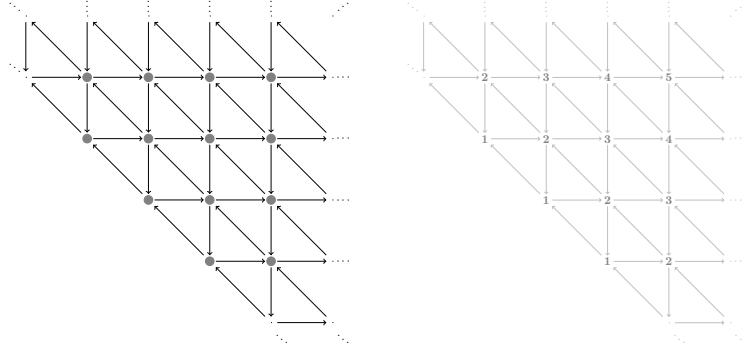

FIGURE 12. The fifth case of partially integral weights

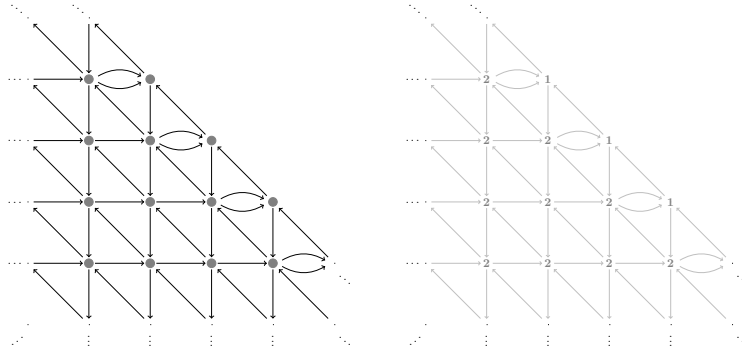

FIGURE 13. The sixth case of partially integral weights

Proof. Mutatis mutandis the proof of Proposition 11. □

Denote by \mathcal{M}_6^a the additive closure of all $P(\lambda)$, where $\lambda \in X_6$.

Proposition 16. (a) For $\lambda \in X_4$ such that $\lambda_1 + \lambda_2 = -1$, $\text{add}(\mathcal{C} \cdot L(\lambda))$ coincides with \mathcal{M}_6^a and is a simple transitive \mathcal{C} -module category whose graph and positive eigenvector are depicted in Figure 13.

(b) For $\lambda \in X_6$ such that $\lambda_1 + \lambda_2 \neq -1$, $\text{add}(\mathcal{C} \cdot L(\lambda))$ contains \mathcal{M}_6^a as a \mathcal{C} -module subcategory, moreover, the quotient of $\text{add}(\mathcal{C} \cdot L(\lambda))$ by the ideal \mathcal{I} generated by \mathcal{M}_6^a is a simple transitive \mathcal{C} -module category that is equivalent to \mathcal{M}_5^a .

(c) If $\lambda_1 + \lambda_2 \neq -1$, then the indecomposable objects in $\text{add}(\mathcal{C} \cdot L(\lambda))/\mathcal{I}$ are given by the images of $L(\mu)$, where $\mu \in X_6$ is such that $\mu_1 + \mu_2 \neq -1$.

Proof. Mutatis mutandis the proof of Proposition 12. □

The weights λ that appeared in this subsection will be called *partially integral weights*.

It is easy to see that the graphs shown in Figures 8, 10, 12 are isomorphic and, similarly, the graphs shown in Figures 9, 11, 13 are isomorphic.

5.7. Generic weights. Let now λ be a weight that is neither integral nor partially integral. We will call such λ *generic*. Denote by \mathcal{K} the additive closure of all $L(\mu)$, where $\mu \in \lambda + \Lambda$.

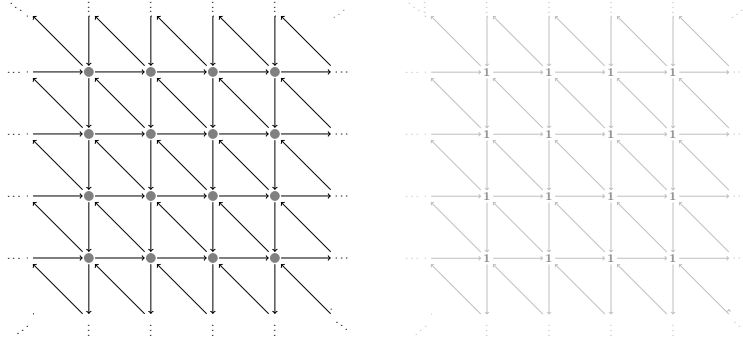

FIGURE 14. Generic weights

Proposition 17. *For any generic λ , the \mathcal{C} -module category $\text{add}(\mathcal{C} \cdot L(\lambda))$ coincides with \mathcal{K} , moreover, the latter is a simple transitive \mathcal{C} -module category whose graph and positive eigenvector are depicted in Figure 14.*

Proof. Note that, for a generic λ , we have $L(\lambda) = \Delta(\lambda)$. Moreover, all generic blocks of category \mathcal{O} are semi-simple. Consequently, for a generic λ , the usual standard filtration of the module $L((1,0)) \otimes_{\mathbb{C}} \Delta(\lambda)$ with subquotients $\Delta(\lambda + (1,0))$, $\Delta(\lambda + (0,-1))$ and $\Delta(\lambda + (-1,1))$ gives rise to a decomposition of $L((1,0)) \otimes_{\mathbb{C}} L(\lambda)$ into a direct sum of $L(\lambda + (1,0))$, $L(\lambda + (0,-1))$ and $L(\lambda + (-1,1))$. This implies that \mathcal{K} is a simple \mathcal{C} -module category whose graph is depicted on the left picture in Figure 14. That the positive eigenvector is as depicted on the right picture in Figure 14 is easy to check.

Since the graph is simply connected, the \mathcal{C} -module \mathcal{K} is transitive, hence also simple transitive due to the semi-simplicity of the underlying category \mathcal{K} . We also, clearly, have that $\text{add}(\mathcal{C} \cdot L(\lambda)) = \mathcal{K}$ and the proof is complete. \square

This completes our description of the combinatorics of the \mathcal{C} -module categories of the form $\text{add}(\mathcal{C} \cdot L(\lambda))$, for $\lambda \in \mathfrak{h}^*$.

6. \mathcal{C} -MODULE CATEGORIES FROM WHITTAKER MODULES

6.1. Whittaker modules. Fix a Lie algebra homomorphism $\eta : \mathfrak{n}_+ \rightarrow \mathbb{C}$ such that both $\eta(e_{1,2}) \neq 0$ and $\eta(e_{2,3}) \neq 0$. Associated to η , we have the corresponding universal Whittaker module \mathbf{K}_η defined as the quotient of $U(\mathfrak{g})$ modulo the left ideal generated by $e_{1,2} - \eta(e_{1,2})$, $e_{2,3} - \eta(e_{2,3})$ and $e_{1,3}$ (note that $\eta(e_{1,3}) = 0$), see [Ko78].

Now, given a central character $\chi : Z(\mathfrak{g}) \rightarrow \mathbb{C}$, the quotient of \mathbf{K}_η modulo $\text{Ker}(\chi)\mathbf{K}_\eta$ is a simple \mathfrak{g} -module denoted by $\mathbf{L}(\eta, \chi)$. The module $\mathbf{L}(\eta, \chi)$ is the unique, up to isomorphism, simple \mathfrak{g} -module with central character χ , on which the action of $v - \eta(v)$ is locally nilpotent, for any $v \in \mathfrak{n}_+$.

6.2. Some weight combinatorics. Here, for a weight $\lambda \in \mathfrak{h}^*$, we determine all possible cases for how $\lambda + \Lambda$ may intersect $W \cdot \lambda$.

Proposition 18. *For $\lambda \in \mathfrak{h}^*$, we have:*

- (a) *If $\lambda \in \Lambda$, then $(W \cdot \lambda) \cap (\lambda + \Lambda) = W \cdot \lambda$.*
- (b) *If $\lambda \in (0, a) + \Lambda$, for some $a \in \mathbb{C} \setminus \mathbb{Z}$, then $(W \cdot \lambda) \cap (\lambda + \Lambda) = \{\lambda, s \cdot \lambda\}$.*
- (c) *If $\lambda \in (a, 0) + \Lambda$, for some $a \in \mathbb{C} \setminus \mathbb{Z}$, then $(W \cdot \lambda) \cap (\lambda + \Lambda) = \{\lambda, r \cdot \lambda\}$.*

- (d) If $\lambda \in (a, -a) + \Lambda$, for some $a \in \mathbb{C} \setminus \mathbb{Z}$, then $(W \cdot \lambda) \cap (\lambda + \Lambda) = \{\lambda, w_0 \cdot \lambda\}$.
- (e) If $\lambda \in (\frac{1}{3}, \frac{1}{3}) + \Lambda$ or $\lambda \in (\frac{2}{3}, \frac{2}{3}) + \Lambda$, then $(W \cdot \lambda) \cap (\lambda + \Lambda) = \{\lambda, sr \cdot \lambda, rs \cdot \lambda\}$.
- (f) In all other cases, $(W \cdot \lambda) \cap (\lambda + \Lambda) = \{\lambda\}$.

We note that the most interesting case for us in this proposition is Case (e). In the setup of category \mathcal{O} , the weights described by Case (e) are generic. As we will see, in the setup of Whittaker modules, they are not (only the weights described by Case (f) are generic).

Proof. The group S_3 has exactly six subgroups: $\{e\}$, $\{e, s\}$, $\{e, r\}$, $\{e, w_0\}$, $\{e, rs, sr\}$ and S_3 . This gives us six different possibilities for the stabilizer of the set $\lambda + \Lambda$ with respect to the dot-action.

In the standard basis of \mathfrak{h}^* , the actions of the linear operators s , r and sr are given by the following matrices:

$$[s] = \begin{pmatrix} -1 & 0 \\ 1 & 1 \end{pmatrix}, \quad [r] = \begin{pmatrix} 1 & 1 \\ 0 & -1 \end{pmatrix}, \quad [sr] = \begin{pmatrix} -1 & -1 \\ 1 & 0 \end{pmatrix}.$$

Using these, the condition $s \cdot \lambda \in \lambda + \Lambda$ can be rewritten as the conjunction of $-\lambda_1 \in \lambda_1 + \mathbb{Z}$ and $\lambda_1 + \lambda_2 \in \lambda_2 + \mathbb{Z}$. This is equivalent to $\lambda_1 \in \mathbb{Z}$. Similarly, $r \cdot \lambda \in \lambda + \Lambda$ is equivalent to $\lambda_2 \in \mathbb{Z}$.

Therefore the conjunction of $s \cdot \lambda \in \lambda + \Lambda$ and $r \cdot \lambda \in \lambda + \Lambda$ implies Claim (a). Taking this into account, each condition separately implies Claim (b) and Claim (c). Claim (d) is proved similarly.

To prove Claim (e), we note that the condition $sr \cdot \lambda \in \lambda + \Lambda$ can be rewritten as the conjunction of $-\lambda_1 - \lambda_2 \in \lambda_1 + \mathbb{Z}$ and $\lambda_1 \in \lambda_2 + \mathbb{Z}$. This is equivalent to $\lambda_2 \in \frac{1}{3}\mathbb{Z}$ and $\lambda_1 \in \lambda_2 + \mathbb{Z}$. Together with already established Claim (a), this implies Claim (e).

Claim (f) follows as the logical complement to the union of all the preceding claims. \square

6.3. \mathcal{C} -module categories generated by simple Whittaker modules. For a central character, $\chi : Z(\mathfrak{g}) \rightarrow \mathbb{C}$, fix some *anti-dominant* $\lambda_\chi \in \mathfrak{h}^*$ such that $\chi = \chi_{\lambda_\chi}$. Note that λ_χ is not unique, in general.

For $\eta : \mathfrak{n}_+ \rightarrow \mathbb{C}$ such that both $\eta(e_{1,2}) \neq 0$ and $\eta(e_{2,3}) \neq 0$, and for $\chi : Z(\mathfrak{g}) \rightarrow \mathbb{C}$, consider the module $\mathbf{L}(\eta, \chi)$ and the \mathcal{C} -module category $\text{add}(\mathcal{C} \cdot \mathbf{L}(\eta, \chi))$.

Proposition 19. *For η and χ as above, we have:*

- (a) If $\lambda_\chi \in (\frac{1}{3}, \frac{1}{3}) + \Lambda$ or $\lambda_\chi \in (\frac{2}{3}, \frac{2}{3}) + \Lambda$, then $\text{add}(\mathcal{C} \cdot \mathbf{L}(\eta, \chi))$ is semi-simple and is a simple transitive \mathcal{C} -module category whose graph and positive eigenvector are depicted in Figure 15.
- (b) In all other cases, $\text{add}(\mathcal{C} \cdot \mathbf{L}(\eta, \chi))$ is equivalent to $\text{add}(\mathcal{C} \cdot L(\lambda_\chi))$, as a \mathcal{C} -module category.

Proof. Claim (b) follows from [MiSo97, Theorem 5.3]. Claim (a) differs from Claim (b) due to the fact that, in this case, the second condition in [MiSo97, Proposition 5.5] is violated.

Indeed, let $\lambda_\chi \in (\frac{1}{3}, \frac{1}{3}) + \Lambda$ or $\lambda_\chi \in (\frac{2}{3}, \frac{2}{3}) + \Lambda$. Then $(W \cdot \lambda) \cap \lambda_\chi + \Lambda$ consists of λ_χ , $sr \cdot \lambda_\chi$ and $rs \cdot \lambda_\chi$. At the same time, the integral Weyl group of λ_χ is trivial.

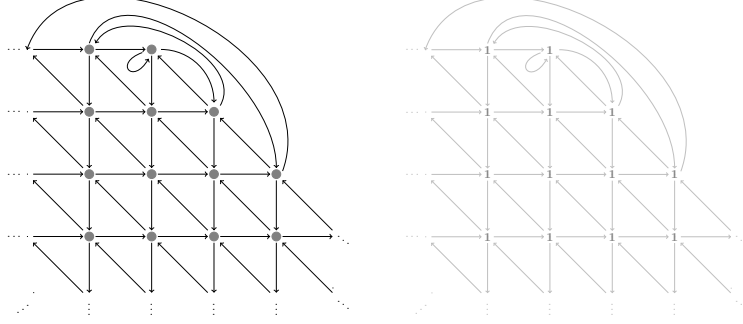

FIGURE 15. Additional combinatorics from the Whittaker setup

Our classification of projective functors tells us that we have two non-trivial projective functors, namely $\theta_{\lambda_\chi, sr \cdot \lambda_\chi}$ and $\theta_{\lambda_\chi, rs \cdot \lambda_\chi}$. On the one hand, they are defined via

$$\theta_{\lambda_\chi, sr \cdot \lambda_\chi} L(\lambda_\chi) \cong L(sr \cdot \lambda_\chi) \quad \text{and} \quad \theta_{\lambda_\chi, rs \cdot \lambda_\chi} L(\lambda_\chi) \cong L(rs \cdot \lambda_\chi).$$

On the other hand, we have

$$\theta_{\lambda_\chi, sr \cdot \lambda_\chi} \mathbf{L}(\eta, \chi) \cong \theta_{\lambda_\chi, rs \cdot \lambda_\chi} \mathbf{L}(\eta, \chi) \cong \mathbf{L}(\eta, \chi),$$

due to the uniqueness of $\mathbf{L}(\eta, \chi)$. In particular, $\text{add}(\mathcal{C} \cdot \mathbf{L}(\eta, \chi))$ is semi-simple, which implies that it is also a simple transitive \mathcal{C} -module category.

To obtain its combinatorics, we can think of $\text{add}(\mathcal{C} \cdot \mathbf{L}(\eta, \chi))$ as a “quotient” of $\text{add}(\mathcal{C} \cdot L(\lambda_\chi))$ under the action of the stabilizer group $\{e, sr, rs\}$. Then it is easy to check that Figure 15 is simply such a quotient of Figure 14. \square

7. COMBINATORICS OF TRANSITIVE \mathcal{C} -MODULE SUBQUOTIENT OF ARBITRARY $\text{add}(\mathcal{C} \cdot L)$

7.1. Setup. Let now L be a simple \mathfrak{g} -module. Associated to L , we have the \mathcal{C} -module category $\text{add}(\mathcal{C} \cdot L)$. The category $\text{add}(\mathcal{C} \cdot L)$ is locally finitary, moreover, for any indecomposable object X , there are only finitely many, up to isomorphism, indecomposable objects Y such that $\text{Hom}(X, Y) \neq 0$ (and, similarly, in the other direction). We refer to [MMM23] for the details and to [Mac22a, Mac22b] for more information on finitary module categories.

7.2. Main result. We are now ready to formulate the main result of our paper which describes combinatorics of transitive subquotients of $\text{add}(\mathcal{C} \cdot L)$.

Theorem 20. *Let L be a simple \mathfrak{g} -module and \mathbf{N} a transitive subquotient of $\text{add}(\mathcal{C} \cdot L)$. Then the graph $\Gamma_{\mathbf{F}}$ for \mathbf{N} is isomorphic to the graph given by one of the following figures: Figure 3, Figure 5, Figure 6, Figure 7, Figure 8, Figure 9, Figure 10, Figure 11, Figure 12, Figure 13, Figure 14, Figure 15 (note that some of them are isomorphic).*

For convenience, we collected all these graphs together in Figure 16.

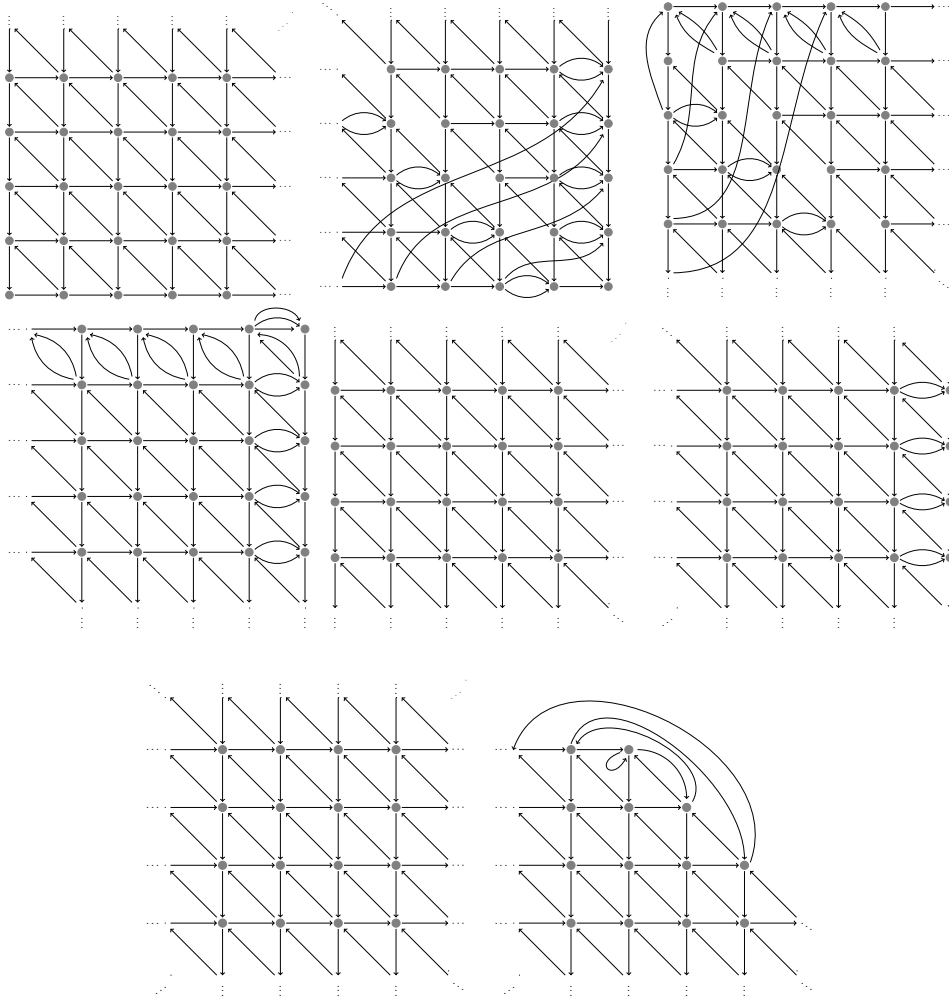

FIGURE 16. All eight graphs mentioned in Theorem 20

7.3. Proof. In order to prove Theorem 20, we reinterpret the results of [MiSo97] (which we already mentioned in the proof of Proposition 19) in terms of the approach to representations of monoidal categories via algebra objects as described in, e.g. [EGNO15, Chapter 7]. This will allow us to generalize the necessary results of [MiSo97] to the case of our arbitrary simple module L .

Consider the \mathfrak{g} - \mathfrak{g} -bimodule $\text{Hom}_{\mathbb{C}}(L, L)$ of all linear endomorphisms of L . It contains a subbimodule $\mathcal{L}(L, L)$ which consists of all elements, the adjoint action of \mathfrak{g} on which is locally finite. In fact, the multiplicity of each simple finite dimensional \mathfrak{g} -module in the adjoint \mathfrak{g} -module $\mathcal{L}(L, L)$ is finite, that is, $\mathcal{L}(L, L)$ is a Harish-Chandra \mathfrak{g} - \mathfrak{g} -bimodule, see [Ja83, Kapitel 6]. The monoidal category \mathcal{H} of Harish-Chandra bimodules, see [BG80], is a proxy for the action of \mathcal{C} on \mathfrak{g} -modules with locally finite action of $Z(\mathfrak{g})$.

The space $\mathcal{L}(L, L)$ has the natural structure of an algebra. By the combination of [EGNO15, Remark 7.9.1] with [EGNO15, Theorem 7.10.1], the category of all $\mathcal{L}(L, L)$ -modules in \mathcal{H} is equivalent to $\text{add}(\mathcal{C} \cdot L)$. Therefore, in order to prove Theorem 20, we just need to show that there either exists a simple highest weight module $L(\lambda)$ or

a simple Whittaker module $\mathbf{L}(\eta, \chi)$ such that $\mathcal{L}(L, L)$ is isomorphic (as an algebra) to the corresponding $\mathcal{L}(L(\lambda), L(\lambda))$ or $\mathcal{L}(\mathbf{L}(\eta, \chi), \mathbf{L}(\eta, \chi))$, respectively.

By [Di96, Proposition 2.6.8], the module L admits a central character, say χ . Then there exists $\lambda \in \mathfrak{h}^*$ such that the annihilators of L and $L(\lambda)$ in $U(\mathfrak{g})$ coincide, see [Du77]. In particular, χ is also the central character of $L(\lambda)$.

Consider first the case $\lambda \notin (\frac{1}{3}, \frac{1}{3}) + \Lambda$. We claim that, in this case, the following holds:

$$\mathcal{L}(L(\lambda), L(\lambda)) \cong \mathcal{L}(L, L) \cong U(\mathfrak{g})/\text{Ann}_{U(\mathfrak{g})}(L).$$

All this can be found in the literature, see [MS08, MMM23, Ma23]. The point of this case is that the part of \mathcal{O}_χ which corresponds to the weights in $\lambda + \Lambda$ is indecomposable (as a category) and hence the action of projective functors on this part is similar to the action on an integral block. Therefore the isomorphisms above just reflect the fact that Kostant's problem has positive solution for all simple \mathfrak{sl}_2 and \mathfrak{sl}_3 -modules with integral central characters, see [Ma23] for details.

Now consider the case $\lambda \in (\frac{1}{3}, \frac{1}{3}) + \Lambda$. In this case, the block \mathcal{O}_χ is semi-simple, so $L(\lambda)$ is, in fact, a Verma module. This implies that

$$\mathcal{L}(L(\lambda), L(\lambda)) \cong U(\mathfrak{g})/\text{Ann}_{U(\mathfrak{g})}(L),$$

see [Ja83, Section 6.9].

However, the intersection of $W \cdot \lambda$ with $\lambda + \Lambda$ contains two other weights, different from λ . Let us denote them by λ' and λ'' . This means that there are three pairwise non-isomorphic indecomposable projective endofunctors of \mathcal{O}_χ , namely $\theta_{\lambda, \lambda}$, $\theta_{\lambda, \lambda'}$ and $\theta_{\lambda, \lambda''}$. They all send simple modules to simple modules and hence are equivalences of categories. In other words, we have the cyclic group of order 3 acting on \mathcal{O}_χ by equivalences. This leads to two different subcases:

Subcase 1. Assume that the modules L and $\theta_{\lambda, \lambda'}L$ are not isomorphic. In this subcase we automatically have that the modules L , $\theta_{\lambda, \lambda'}L$ and $\theta_{\lambda, \lambda''}L$ are pairwise non-isomorphic (as the only proper subgroup of the cyclic group on three elements is the trivial subgroup). This means that, for an indecomposable projective functor θ , the inequality $\text{Hom}(L, \theta L) \neq 0$ implies that θ is the identity functor. Exactly the same property holds if we substitute L by $L(\lambda)$. Therefore, for any finite dimensional \mathfrak{g} -module V , using [Ja83, Section 6.8], we have

$$\dim \text{Hom}_{\mathfrak{g}}(V, \mathcal{L}(L, L)^{\text{ad}}) = \dim \text{Hom}_{\mathfrak{g}}(V, \mathcal{L}(L(\lambda), L(\lambda))^{\text{ad}}),$$

where in the second argument we consider the adjoint \mathfrak{g} -action, which implies that the natural inclusion $U(\mathfrak{g})/\text{Ann}_{U(\mathfrak{g})}(L) \subset \mathcal{L}(L, L)$ is an isomorphism. This shows that $\mathcal{L}(L, L) \cong \mathcal{L}(L(\lambda), L(\lambda))$ and we are done.

Subcase 2. Assume that the modules L and $\theta_{\lambda, \lambda'}L$ are isomorphic. In this subcase we automatically have that the modules L , $\theta_{\lambda, \lambda'}L$ and $\theta_{\lambda, \lambda''}L$ are all isomorphic (as the only non-trivial subgroup of the cyclic group on three elements is the group itself). This means that, for any indecomposable projective endofunctor θ of \mathcal{O}_χ , we have $\text{Hom}(L, \theta L) \cong \mathbb{C}$. Note that the same holds for $\mathbf{L}(\eta, \chi)$. Therefore, for any finite dimensional \mathfrak{g} -module V , using [Ja83, Section 6.8], we have

$$(5) \quad \dim \text{Hom}_{\mathfrak{g}}(V, \mathcal{L}(L, L)^{\text{ad}}) = \dim \text{Hom}_{\mathfrak{g}}(V, \mathcal{L}(\mathbf{L}(\eta, \chi), \mathbf{L}(\eta, \chi))^{\text{ad}}).$$

Note that both $\mathcal{L}(L, L)$ and $\mathcal{L}(\mathbf{L}(\eta, \chi), \mathbf{L}(\eta, \chi))$ are semi-simple by [BG80, Theorem 5.9]. From (5) it follows that each simple bimodule appears in $\mathcal{L}(L, L)$ and $\mathcal{L}(\mathbf{L}(\eta, \chi), \mathbf{L}(\eta, \chi))$ with the same multiplicity. This implies that the bimodules $\mathcal{L}(L, L)$ and $\mathcal{L}(\mathbf{L}(\eta, \chi), \mathbf{L}(\eta, \chi))$ are isomorphic. The proof of the main theorem is now complete.

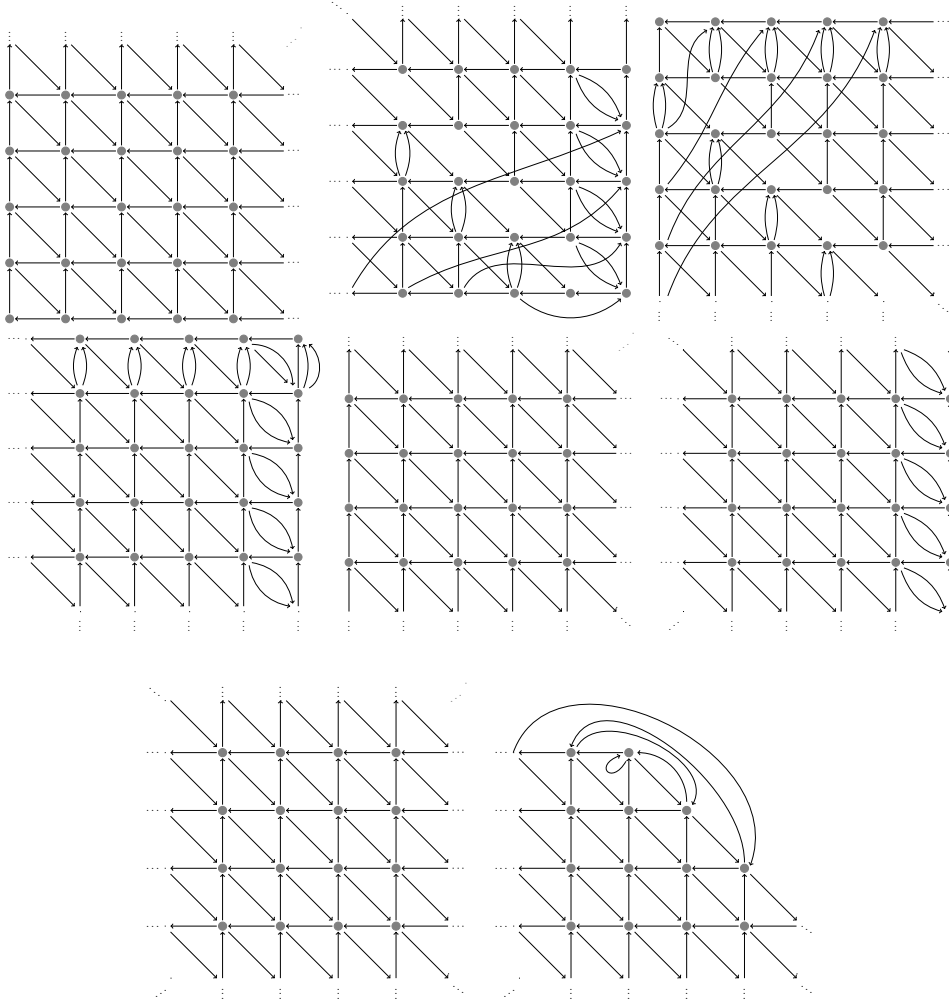
FIGURE 17. The graphs Γ_G corresponding to Figure 16

7.4. The action of G . As the complete combinatorics is uniquely determined by $[F]$ and $[G]$, see Subsection 3.4, for convenience, in Figure 17 we collected the graphs Γ_G corresponding to the graphs in Figure 16. Determination of the graphs in Figure 17 is similar to our determination of the graphs in Figure 16.

7.5. Semi-simplicity of some underlying categories. Similarly to [MZ24, Proposition 20], we also have the following:

Proposition 21. *Let \mathcal{M} be a simple transitive admissible \mathcal{C} -module category whose combinatorics is given by one of the four graphs in Figure 16 that does not have double oriented arrows describing the action of F , with the corresponding graph in Figure 17 describing the action of G . Then the category \mathcal{M} is semi-simple.*

Proof. The proof is an adaptation of the proof of [MZ24, Proposition 20]. We just sketch the main steps below, leaving the details to the reader. Consider the abelianization $\overline{\mathcal{M}}$. We need to prove that the radical of $\overline{\mathcal{M}}$ is \mathcal{C} -invariant. As \mathcal{C} is generated by F , we just need to prove that the radical of $\overline{\mathcal{M}}$ is F -invariant.

The radical of $\overline{\mathcal{M}}$ is generated by morphisms between non-isomorphic indecomposable projectives together with the nilpotent endomorphisms of indecomposable projectives. The action of F preserves nilpotency and hence the outcome, when applied to a nilpotent endomorphism of an indecomposable projective, is a radical morphism, since, by our assumptions, this action is multiplicity free in the basis of projectives.

Under our assumptions, the graphs Γ_F and Γ_G are opposite to each other. This implies that the combinatorics of the action of F in the basis of simples in $\overline{\mathcal{M}}$ coincides with the combinatorics of the action of F in the basis of projectives in $\overline{\mathcal{M}}$. Given a morphism $f : P \rightarrow Q$ between two indecomposable projectives, the image of f belongs to the radical of Q . So, we need to show that the image of $F(f)$ belongs to the radical of $F(Q)$. In fact, $F(\text{Rad}(Q)) = \text{Rad}(F(Q))$. Indeed, applying the exact functor F to the short exact sequence

$$0 \rightarrow \text{Rad}(Q) \rightarrow Q \rightarrow Q/\text{Rad}(Q) \rightarrow 0,$$

we observe that the top of $F(Q)$ is isomorphic to $F(Q/\text{Rad}(Q))$ since the combinatorics of the action of F in the bases of projectives and simples agree. This implies the claim and completes the proof. \square

REFERENCES

- [AM11] Agerholm, T.; Mazorchuk, V. On selfadjoint functors satisfying polynomial relations. *J. Algebra* **330** (2011), 448–467.
- [AS03] Andersen, H. H.; Stroppel, C. Twisting functors on \mathcal{O} . *Represent. Theory* **7** (2003), 681–699.
- [BG80] Bernstein, J.; Gelfand, S. Tensor products of finite- and infinite-dimensional representations of semisimple Lie algebras. *Compositio Math.* **41** (1980), no.2, 245–285.
- [BGG76] Bernstein, I.; Gelfand, I.; Gelfand, S. A certain category of \mathfrak{g} -modules. *Funkcional. Anal. i Priložen.* **10** (1976), no. 2, 1–8.
- [Di96] Dixmier, J. *Enveloping algebras*. *Grad. Stud. Math.* **11**, American Mathematical Society, Providence, RI, 1996, xx+379 pp.
- [Du77] Duflo, M. Sur la classification des idéaux primitifs dans l’algèbre enveloppante d’une algèbre de Lie semi-simple. *Ann. of Math. (2)* **105** (1977), no. 1, 107–120.
- [EGNO15] Etingof, P.; Gelaki, S.; Nikshych, D.; Ostrik, V. *Tensor categories*. *Math. Surveys Monogr.*, **205** American Mathematical Society, Providence, RI, 2015, xvi+343 pp.
- [Fr66] Freyd, P. *Representations in abelian categories*. Springer-Verlag New York, Inc., New York, 1966, pp. 95–120.
- [HPR80a] Happel, D.; Preiser, U.; Ringel, C. M. Binary polyhedral groups and Euclidean diagrams. *Manuscripta Math.* **31** (1980), no. 1-3, 317–329.
- [HPR80b] Happel, D.; Preiser, U.; Ringel, C. M. Vinberg’s characterization of Dynkin diagrams using subadditive functions with application to DTr-periodic modules. *Lecture Notes in Math.*, **832**, Springer, Berlin, 1980, pp. 280–294.
- [Hu08] Humphreys, J. *Representations of semisimple Lie algebras in the BGG category \mathcal{O}* . *Grad. Stud. Math.*, **94** American Mathematical Society, Providence, RI, 2008, xvi+289 pp.
- [Ja83] Jantzen, J. C. *Einhüllende Algebren halbeinfacher Lie-Algebren*. *Ergebnisse der Mathematik und ihrer Grenzgebiete (3)*, **3**. Springer-Verlag, Berlin, 1983. ii+298 pp.
- [KM05] Khomenko, O.; Mazorchuk, V. On Arkhipov’s and Enright’s functors. *Math. Z.* **249** (2005), no.2, 357–386.
- [Ko78] Kostant, B. On Whittaker vectors and representation theory. *Invent. Math.* **48** (1978), no. 2, 101–184.
- [KL00] Krause, G.; Lenagan, T. *Growth of algebras and Gelfand-Kirillov dimension*. *Grad. Stud. Math.*, **22** American Mathematical Society, Providence, RI, 2000, x+212 pp.
- [MMM23] Mackaay, M.; Mazorchuk, V.; Miemietz, V. Applying projective functors to arbitrary holonomic simple modules. *J. Lond. Math. Soc. (2)* **110** (2024), no. 2, Paper No. e12965.
- [MMMT20] Mackaay, M.; Mazorchuk, V.; Miemietz, V.; Tubbenhauer, D. Trihedral Soergel bimodules. *Fund. Math.* **248** (2020), no.3, 219–300.
- [Mac22a] Macpherson, J. Extension of the 2-representation theory of finitary 2-categories to locally (graded) finitary 2-categories. *Ark. Mat.* **60** (2022), no. 1, 125–172.
- [Mac22b] Macpherson, J. 2-representations and associated coalgebra 1-morphisms for locally wide finitary 2-categories. *J. Pure Appl. Algebra* **226** (2022), no. 11, Paper No. 107081, 27 pp.

- [Ma23] Mazorchuk, V. The tale of Kostant's problem. Preprint arXiv:2308.02839.
- [MM11] Mazorchuk, V.; Miemietz, V. Cell 2-representations of finitary 2-categories. *Compos. Math.* **147** (2011), no. 5, 1519–1545.
- [MM16] Mazorchuk, V.; Miemietz, V. Transitive 2-representations of finitary 2-categories. *Trans. Amer. Math. Soc.* **368** (2016), no. 11, 7623–7644.
- [MS08] Mazorchuk, V.; Stroppel, C. Categorification of (induced) cell modules and the rough structure of generalised Verma modules. *Adv. Math.* **219** (2008), no. 4, 1363–1426.
- [MZ24] Mazorchuk, V.; Zhu, X. Infinite rank module categories over finite dimensional \mathfrak{sl}_2 -modules in Lie-algebraic context. Preprint arXiv:2405.19894.
- [MiSo97] Miličić, D.; Soergel, W. The composition series of modules induced from Whittaker modules. *Comment. Math. Helv.* **72** (1997), no. 4, 503–520.
- [OEIS] Sloane, N. J. A. The Online Encyclopedia of Integer Sequences. Founded in 1964.

V. M.: Department of Mathematics, Uppsala University, Box. 480, SE-75106, Uppsala, SWEDEN, email: mazor@math.uu.se

X. Z.: School of Mathematics and Statistics, Ningbo University, Ningbo, Zhejiang, 315211, China, email: zhuxiaoyu1@nbu.edu.cn