

# Excluding a rectangular grid minor

Clément Rambaud\*

Université Côte d'Azur, CNRS, Inria, I3S  
Sophia-Antipolis, France  
clement.rambaud@inria.fr

January 22, 2025

## Abstract

For every positive integer  $k$ , we define the  $k$ -treedepth as the largest graph parameter  $\text{td}_k$  satisfying (i)  $\text{td}_k(\emptyset) = 0$ ; (ii)  $\text{td}_k(G) \leq 1 + \text{td}_k(G - u)$  for every graph  $G$  and every vertex  $u \in V(G)$ ; and (iii) if  $G$  is a  $(< k)$ -clique-sum of  $G_1$  and  $G_2$ , then  $\text{td}_k(G) \leq \max\{\text{td}_k(G_1), \text{td}_k(G_2)\}$ , for all graphs  $G_1, G_2$ . This parameter coincides with treedepth if  $k = 1$ , and with treewidth plus 1 if  $k \geq |V(G)|$ . We prove that for every positive integer  $k$ , a class of graphs  $\mathcal{C}$  has bounded  $k$ -treedepth if and only if there is a positive integer  $\ell$  such that for every tree  $T$  on  $k$  vertices, no graph in  $\mathcal{C}$  contains  $T \square P_\ell$  as a minor.

This implies for  $k = 1$  that a minor-closed class of graphs has bounded treedepth if and only if it excludes a path, for  $k = 2$  that a minor-closed class of graphs has bounded 2-treedepth if and only if it excludes as a minor a ladder (Huynh, Joret, Micek, Seweryn, and Wollan; *Combinatorica*, 2021), and for large values of  $k$  that a minor-closed class of graphs has bounded treewidth if and only if it excludes a grid (Grid-Minor Theorem, Robertson and Seymour; *JCTB*, 1986).

As a corollary, we obtain the following qualitative strengthening of the Grid-Minor Theorem in the case of bounded-height grids. For all positive integers  $k, \ell$ , every graph that does not contain the  $k \times \ell$  grid as a minor has  $(2k - 1)$ -treedepth at most a function of  $(k, \ell)$ .

**Keywords:** Graph minor, grid graph, tree decomposition, treedepth, treewidth.

The Grid-Minor Theorem, proved by Robertson and Seymour [RS86], characterizes classes of graphs having bounded treewidth in terms of excluded minors. More precisely, it asserts that a class of graphs  $\mathcal{C}$  has bounded treewidth if and only if there is a positive integer  $\ell$  such that, for every  $G \in \mathcal{C}$ , the  $\ell \times \ell$  grid is not a minor of  $G$  (see Section 2.1 for the definition of grid). The “only if” part can be easily obtained from the fact that treewidth is monotone for the graph minor relation, and that grids have unbounded treewidth. Hence the core of this theorem is the fact that graphs excluding the  $\ell \times \ell$  grid as a minor have treewidth at most  $f(\ell)$ , for some function  $f$ . A lot of research has been carried out to obtain good bounds on the smallest such function  $f$ . While the original proof of Robertson and Seymour give a superpolynomial upper bound on  $f$ , Chekuri and Chuzhoy proved a first polynomial upper bound in [CC16], which was later lowered down to  $\ell^9 \log(\ell)^{\mathcal{O}(1)}$  by Chuzhoy and Tan [CT21].

The treedepth is a graph parameter larger than treewidth which can be characterized as the largest graph parameter  $\text{td}$  satisfying (i)  $\text{td}(\emptyset) = 0$ <sup>1</sup>, (ii)  $\text{td}(G) \leq \text{td}(G - u) + 1$  for every graph

---

\*Research supported by the French Agence Nationale de la Recherche under contract Digraphs ANR-19-CE48-0013.

<sup>1</sup>We denote by  $\emptyset$  both the empty set and the graph with no vertices.

$G$  and for every  $u \in V(G)$ , and (iii)  $\text{td}(G) \leq \max\{\text{td}(G_1), \text{td}(G_2)\}$  if  $G$  is the disjoint union of  $G_1$  and  $G_2$ , for all graphs  $G_1, G_2$ . A class of graphs  $\mathcal{C}$  has bounded treedepth if and only if there is a positive integer  $\ell$  such that for every  $G \in \mathcal{C}$ ,  $P_\ell$ , the path on  $\ell$  vertices, is not a minor of  $G$ . This analog of the Grid-Minor Theorem for treedepth can be easily obtained by elementary arguments, see [NOdM12, Proposition 6.1].

Huynh, Joret, Micek, Seweryn, and Wollan [HJM<sup>+</sup>21] recently introduced a variant of treedepth, called 2-treedepth and denoted by  $\text{td}_2$ , which can be characterized as the largest graph parameter satisfying (i)-(iii) of the definition of treedepth, together with the property (iv)  $\text{td}_2(G) \leq \max\{\text{td}_2(G_1), \text{td}_2(G_2)\}$  if  $G$  can be obtained from the disjoint union of  $G_1$  and  $G_2$  by identifying one vertex in  $G_1$  with one vertex in  $G_2$ , for all graphs  $G_1, G_2$ . Huynh, Joret, Micek, Seweryn, and Wollan proved that a class of graphs has bounded 2-treedepth if and only if for some positive integer  $\ell$ , every graph in this class excludes the  $2 \times \ell$  grid, as a minor. While initially defined to describe the structure of graphs excluding a  $2 \times \ell$  grid as a minor, it turns out that this parameter plays an important role in the study of weak coloring numbers in minor-closed classes of graphs, see [HLMR24b].

It is noteworthy that treewidth has a similar characterization: the treewidth is the largest graph parameter  $\text{tw}$  satisfying (i)  $\text{tw}(\emptyset) = -1$ , (ii)  $\text{tw}(G) \leq \text{tw}(G - u) + 1$  for every graph  $G$  and for every  $u \in V(G)$ , and (iii)  $\text{tw}(G) \leq \max\{\text{tw}(G_1), \text{tw}(G_2)\}$  if  $G$  is a clique-sum of  $G_1$  and  $G_2$ , for all graphs  $G_1, G_2$ . Here, a clique-sum of two graphs  $G_1$  and  $G_2$  is any graph  $G$  obtained from the disjoint union of  $G_1$  and  $G_2$  by identifying a clique in  $G_1$  with a clique in  $G_2$  of the same size. Furthermore, for every positive integer  $k$ , if these cliques have size less than  $k$ , then we say that  $G$  is a ( $< k$ )-clique-sum of  $G_1$  and  $G_2$ . In particular, a ( $< 1$ )-clique-sum of  $G_1$  and  $G_2$  is always the disjoint union of  $G_1$  and  $G_2$ . This notion leads to the following generalization of treewidth, which is the subject of this paper.

For every  $k \in \mathbb{N}_{>0} \cup \{+\infty\}$ , we define the  $k$ -treedepth as the largest graph parameter  $\text{td}_k$  satisfying

- (i)  $\text{td}_k(\emptyset) = 0$ ,
- (ii)  $\text{td}_k(G) \leq 1 + \text{td}_k(G - u)$  for every graph  $G$  and every vertex  $u \in V(G)$ , and
- (iii)  $\text{td}_k(G) \leq \max\{\text{td}_k(G_1), \text{td}_k(G_2)\}$  if  $G$  is a ( $< k$ )-clique-sum of  $G_1$  and  $G_2$ , for all graphs  $G_1, G_2$ .

This gives a well-defined parameter because if  $\mathcal{P}$  is the family of all the graph parameters satisfying (i)-(iii), then  $\text{td}_k: G \mapsto \max_{p \in \mathcal{P}} p(G)$  also satisfies (i)-(iii). A more explicit definition is given in Section 2.3.

Note that the 1-treedepth is the usual treedepth, the 2-treedepth coincides with the homonymous parameter  $\text{td}_2$  introduced by Huynh, Joret, Micek, Seweryn, and Wollan in [HJM<sup>+</sup>21], and that the  $+\infty$ -treedepth coincides with the treewidth plus 1. Hence, for every graph  $G$ ,

$$\text{td}(G) = \text{td}_1(G) \geq \text{td}_2(G) \geq \dots \geq \text{td}_{+\infty}(G) = \text{tw}(G) + 1.$$

Our main result is a characterization of classes of graphs having bounded  $k$ -treedepth in terms of excluded minors, which generalizes the aforementioned results on treedepth, 2-treedepth, and treewidth.

**Theorem 1.** *Let  $k$  be a positive integer. A class  $\mathcal{C}$  of graphs has bounded  $k$ -treedepth if and only if there exists an integer  $\ell$  such that for every tree  $T$  on  $k$  vertices, no graph in  $\mathcal{C}$  contains  $T \square P_\ell$  as a minor.*

Here,  $\square$  denotes the Cartesian product: for all graphs  $G_1, G_2$ ,  $G_1 \square G_2 = (V(G_1) \times V(G_2), \{(u, v)(u', v') \mid (u = v \text{ and } u'v' \in E(G_2)) \text{ or } (uv \in E(G_1) \text{ and } u' = v')\})$ ; and  $P_\ell$  denotes the path on  $\ell$  vertices. See Figure 1 for some examples of graphs of the form  $T \square P_\ell$ .

Theorem 1 gives for every positive integer  $k$  a characterization of classes of graphs having bounded  $k$ -treedepth in terms of excluded minors, which was previously known only for  $k = 1$  and  $k = 2$  [HJM<sup>+</sup>21]. For example, when  $k = 5$ , Theorem 1 applied to  $k = 5$  implies that for every fixed positive integer  $\ell$ , graphs excluding  $T_1 \square P_\ell, T_2 \square P_\ell$ , and  $T_3 \square P_\ell$  as minors have bounded 5-treedepth, where  $T_1, T_2, T_3$  are the three trees on 5 vertices up to isomorphism (see Figure 1). This is optimal since each of the three families  $\{T_1 \square P_\ell\}_{\ell \geq 1}, \{T_2 \square P_\ell\}_{\ell \geq 1}, \{T_3 \square P_\ell\}_{\ell \geq 1}$  has unbounded  $k$ -treedepth.

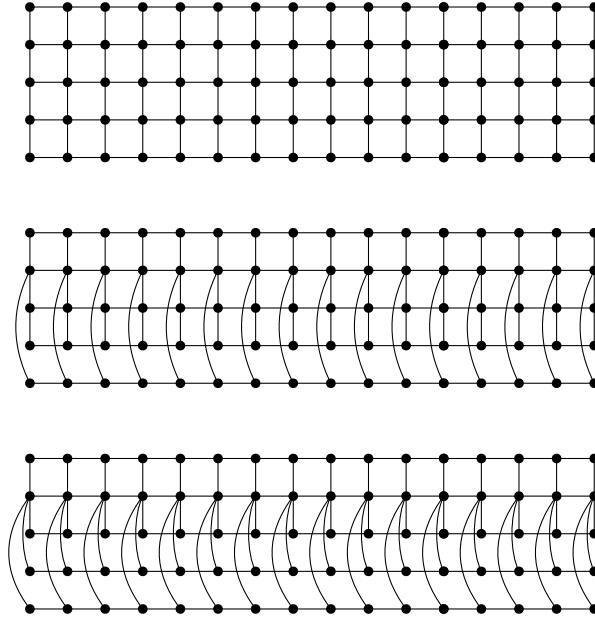

Figure 1: The three families of obstructions for 5-treedepth given by Theorem 1.

A similar result was obtained by Geelen and Joeris [GJ16] for the parameter called  $k$ -treewidth, which is the minimum width of a tree decomposition with adhesion smaller than  $k$  (see Section 2.2 for the definition of tree decomposition and adhesion). However, their proof relies on very different techniques. Indeed, the argument of [GJ16] is a generalization of a proof of the Grid-Minor Theorem, while here, the structure we are looking for is more complex, but we use the Grid-Minor Theorem as a black box.

As a corollary of Theorem 1, we obtain the following structural property for the graphs excluding the  $k \times \ell$  grid as a minor, when  $k$  is small compared to  $\ell$ . This is a qualitative strengthening of the celebrated Grid-Minor Theorem by Robertson and Seymour [RS86].

**Corollary 2.** *There is a function  $f: \mathbb{N}^2 \rightarrow \mathbb{N}$  such that for all positive integers  $k, \ell$ , for every graph  $G$ , if the  $k \times \ell$  grid is not a minor of  $G$ , then*

$$\text{td}_{2k-1}(G) \leq f(k, \ell).$$

In [BCE<sup>+</sup>19], Biedl, Chambers, Eppstein, De Mesmay, and Ophelders defined the **grid-major height** of a planar graph  $H$ , denoted by  $\text{GMh}(H)$ , as the smallest integer  $k$  such that  $H$  is a minor of the  $k \times \ell$  grid for some integer  $\ell$ . With this definition, Corollary 2 implies the following.

**Corollary 3.** *There is a function  $f: \mathbb{N} \rightarrow \mathbb{N}$  such that the following holds. For every planar graph  $H$  with at least one vertex and for every  $H$ -minor-free graph  $G$ ,*

$$\text{td}_{2\text{GMh}(H)-1}(G) \leq f(|V(H)|).$$

Moreover,  $\text{GMh}$  is the right parameter in such a result since  $H$ -minor-free graphs have unbounded  $\text{td}_{\text{GMh}(H)-1}$ , as witnessed by the family of the  $(\text{GMh}(H) - 1) \times \ell$  grids for  $\ell > 0$ . This gives a better understanding of  $H$ -minor-free graphs when  $H$  is planar and has a specific structure. In the same spirit, Dujmović, Hickingbotham, Hodor, Joret, La, Micek, Morin, Rambaud, and Wood [DHH<sup>+</sup>24] recently gave a product structure for  $H$ -minor-free graphs when  $H$  is planar and has bounded treedepth.

We also investigate the variant of  $k$ -treedepth for path decompositions, instead of tree decompositions, that we call  $k$ -pathdepth and denoted by  $\text{pd}_k$ . Informally, the  $k$ -**pathdepth**  $\text{pd}_k$  is the largest parameter satisfying (i) and (ii) of the definition of  $k$ -treedepth, and an analog of (iii) ensuring that the clique-sums are made in the way of a path. See Section 1 for a formal definition. This gives a family of parameters satisfying for every graph  $G$

$$\text{td}(G) = \text{pd}_1(G) \geq \text{pd}_2(G) \geq \dots \geq \text{pd}_{+\infty}(G) = \text{pw}(G) + 1$$

and

$$\text{pd}_k(G) \geq \text{td}_k(G)$$

for every positive integer  $k$ . Hence, if a class of graphs has bounded  $k$ -pathdepth, then it has bounded  $k$ -treedepth and bounded pathwidth. Quite surprisingly, these two necessary conditions are also sufficient.

**Theorem 4.** *Let  $k$  be a positive integer and let  $\mathcal{C}$  be a class of graphs. The following are equivalent.*

- (1)  $\mathcal{C}$  has bounded  $k$ -pathdepth.
- (2)  $\mathcal{C}$  has bounded pathwidth and bounded  $k$ -treedepth.
- (3) There is an integer  $\ell$  such that for every  $G \in \mathcal{C}$ ,  $\text{pw}(G) \leq \ell$ , and for every tree  $T$  on  $k$  vertices,  $T \square P_\ell$  is not a minor of  $G$ .

Our proof actually shows the equivalence between Items (1) and (3), while the equivalence between Items (2) and (3) follows from Theorem 1.

**Outline of the paper.** In Section 1 are presented the main ideas behind the proof of Theorem 1, and in particular a proof of the implication (3) $\Rightarrow$ (1) of Theorem 4. In Section 2, we introduce some notation and basic tools to study graph minors and tree decompositions. Section 3 contains the proof that graphs of the form  $T \square P_\ell$  have unbounded  $k$ -treedepth as  $\ell \rightarrow +\infty$ , for every tree  $T$  on  $k$  vertices. This constitutes the easy direction in Theorem 1. Sections 4 to 6 are devoted to the proof of technical lemmas used in the final proof of Theorem 1, which is in Section 7. Then, in Section 8, we show that every graph of the form  $T \square P_L$  for some tree  $T$  on  $2k - 1$  vertices contains the  $k \times \ell$  grid as a minor, if  $L$  is large enough compared to  $\ell$ . Together with Theorem 1, this gives Corollary 2. Finally, we conclude in Section 9 by introducing a wide family of graph parameters, including notably treewidth,  $k$ -treedepth, vertex cover number, feedback vertex set number, and we pose the problem of finding universal obstructions for these parameters.

# 1 Outline of the proof

In this section, we present the main ideas behind the proof of Theorem 1. First, we give an alternative definition of  $k$ -treedepth of a graph  $G$ , as the minimum width (plus one) of a “ $k$ -dismantable” tree decomposition of  $G$ . Recall that a **tree decomposition** of a graph  $G$  is a pair  $\mathcal{D} = (T, (W_x \mid x \in V(T)))$  where  $T$  is a tree and  $W_x \subseteq V(G)$  for every  $x \in V(T)$  satisfying

- (i) for every  $u \in V(T)$ ,  $\{x \in V(T) \mid u \in W_x\}$  induces a non-empty connected subtree of  $T$ , and
- (ii) for every  $uv \in E(G)$ , there exists  $x \in V(T)$  such that  $u, v \in W_x$ .

For every vertex  $x \in V(T)$ , we call the set  $W_x$  the **bag** of  $x$  in this tree decomposition. For every edge  $xy \in E(T)$ , we call the set  $B_x \cap B_y$  the **adhesion** of  $xy$  in this tree decomposition. The **width** of  $\mathcal{D}$  is  $\max_{x \in V(T)} |W_x| - 1$ . The **adhesion** of  $\mathcal{D}$  is  $\max_{xy \in E(T)} |W_x \cap W_y|$ . The **treewidth** of  $G$  is the minimum width of a tree decomposition of  $G$ . For an introduction to tree decompositions and treewidth, see [Die17, Chapter 12].

More generally, when no graph is specified, we call tree decomposition any pair  $(T, (W_x \mid x \in V(T)))$  satisfying (i). A tree decomposition  $(T, (W_x \mid x \in V(T)))$  is  **$k$ -dismantable** if one of the following holds.

- (i)  $T$  has a single vertex  $x$  and  $W_x = \emptyset$ ; or
- (ii) there is a vertex  $v \in V(G)$  such that  $v \in W_x$  for every  $x \in V(T)$ , and  $(T, (W_x \setminus \{v\} \mid x \in V(T)))$  is  $k$ -dismantable; or
- (iii) there is an edge  $xy \in E(T)$  such that  $|W_x \cap W_y| < k$  and the tree decompositions  $(T_{x|y}, (W_z \mid z \in V(T_{x|y})))$  and  $(T_{y|x}, (W_z \mid z \in V(T_{y|x})))$  are  $k$ -dismantable.

Here,  $T_{x|y}$  denotes the connected component of  $x$  in  $T \setminus xy$ , for every edge  $xy$  of  $T$ . A straightforward induction shows the following observation. See Section 2.3 for a proof.

**Observation.** *Let  $k$  be a positive integer, let  $G$  be a graph, and let  $t$  be a nonnegative integer. The  $k$ -treedepth of  $G$  is 1 plus the minimum width of a  $k$ -dismantable tree decomposition of  $G$ .*

This definition of  $k$ -treedepth based on tree decompositions will be useful in particular to show that  $\text{td}_k(T \square P_\ell) \rightarrow +\infty$  as  $\ell \rightarrow +\infty$  for every tree  $T$  on  $k$  vertices. This proof does not represent any particular difficulty, see Section 3.

Hence, to prove Theorem 1, it remains to show that there is a function  $f: \mathbb{N}^2 \rightarrow \mathbb{N}$  such that for every graph  $G$  and every positive integer  $\ell$ , if  $T \square P_\ell$  is not a minor of  $G$  for every tree  $T$  on  $k$  vertices, then  $\text{td}_k(G) \leq f(k, \ell)$ . A first ingredient is the following lemma, which shows how to extract a minor of the form  $T \square P_\ell$  for some tree  $T$  on  $k$  vertices, from  $k$  disjoint paths  $Q_1, \dots, Q_k$  and sufficiently many pairwise disjoint connected subgraphs each intersecting  $Q_i$  for every  $i \in [k]$ .

**Lemma 5.** *There exists a function  $f_5: \mathbb{N}^2 \rightarrow \mathbb{N}$  such that the following holds. Let  $k$  be a positive integer. For every graph  $G$ , for all  $k$  disjoint paths  $Q_1, \dots, Q_k$  in  $G$ , if there exist  $f_5(k, \ell)$  pairwise disjoint connected subgraphs of  $G$  each of them intersecting  $V(Q_i)$  for every  $i \in [k]$ , then there is a tree  $T$  on  $k$  vertices such that  $T \square P_\ell$  is a minor of  $G$ .*

The proof of this lemma is given in Section 4. The fact that trees on  $k$  vertices appear in this statement, and so in Theorem 1, can be easily explained. The proof of Lemma 5 actually yields a minor  $H$  of  $G$  with vertex set  $[k] \times [k^{k-2}(\ell - 1) + 1]$  such that each “row”  $\{(i, 1), \dots, (i, k^{k-2}(\ell -$

$1) + 1\}$  for  $i \in [k]$  is a path in  $H$ , and each ‘‘column’’  $\{(1, j), \dots, (k, j)\}$  for  $j \in [k^{k-2}(\ell - 1) + 1]$  induces a connected subgraph of  $H$ . Now, each of these columns contains a spanning tree. By Cayley’s formula and the pigeonhole principle, at least  $\ell$  of these columns have the same spanning tree  $T$  when projecting on the first coordinate. By ignoring the other columns, we deduce that  $H$  contains  $T \square P_\ell$  as a minor.

To illustrate how Lemma 5 can be used, we prove Theorem 4. The  $k$ -**pathdepth** of a graph  $G$ , noted  $\text{pd}_k(G)$ , is 1 plus the minimum width of a  $k$ -dismantable path decomposition of  $G$ , that is a  $k$ -dismantable tree decomposition  $(T, (W_x \mid x \in V(T)))$  of  $G$  for which  $T$  is a path. Together with the following unpublished result of Robertson and Seymour [RS] (see [Erd18] for a proof), Lemma 5 provides a simple proof of Theorem 4.

**Lemma 6** (Robertson and Seymour [RS]). *For every graph  $G$ , there exists a path decomposition  $\mathcal{D} = (P, (W_x \mid x \in V(P)))$  of  $G$  of width at most  $\text{pw}(G)$  such that for every distinct  $x, y \in V(P)$ , either*

- (1) *there are  $k$  pairwise disjoint  $(W_x, W_y)$ -paths in  $G$ , or*
- (2) *there is an edge  $zz'$  in  $P[x, y]$  with  $|W_z \cap W_{z'}| < k$ .*

Again, knowing that  $\text{pd}_k(T \square P_\ell) \geq \text{td}_k(T \square P_\ell)$  and  $\text{td}_k(T \square P_\ell) \rightarrow +\infty$  as  $\ell \rightarrow +\infty$  for every tree  $T$  on  $k$  vertices, and  $\text{pd}_k(G) \geq \text{pw}(G) + 1$  for every graph  $G$ , it remains to show the following.

**Theorem 7.** *There is a function  $f_7: \mathbb{N}^3 \rightarrow \mathbb{N}$  such that for every positive integer  $\ell$  and every graph  $G$ , if  $T \square P_\ell$  is not a minor of  $G$  for every tree  $T$  on  $k$  vertices, then*

$$\text{pd}_k(G) \leq f_7(k, \ell, \text{pw}(G)).$$

*Proof.* Let  $k, \ell$  be positive integers. For every nonnegative integer  $p$ , let

$$f_7(k, \ell, p) = \begin{cases} k & \text{if } p < k, \\ f(k, \ell, p - 1) + (f_5(k, \ell) - 1)(p + 1) + 2(k - 1) & \text{if } p \geq k. \end{cases}$$

We proceed by induction on  $\text{pw}(G)$ . Suppose that  $T \square P_\ell$  is not a minor of  $G$  for every tree  $T$  on  $k$  vertices. If  $\text{pw}(G) < k$ , then every path decomposition of  $G$  of width less than  $k$  is  $k$ -dismantable, and so  $\text{pd}_k(G) \leq k = f_7(k, \ell, \text{pw}(G))$ . Now assume  $\text{pw}(G) \geq k$ . Then, by Lemma 6, there exists a path decomposition  $\mathcal{D} = (P, (W_x \mid x \in V(P)))$  of  $G$  of width at most  $\text{pw}(G)$  satisfying (1) and (2) for every distinct  $x, y \in V(P)$ . Let  $P^1, \dots, P^m$  be the connected components of  $P \setminus \{xy \in E(P) \mid |W_x \cap W_y| < k\}$ , in this order along  $P$ .

Fix some  $h \in [m]$ . Let  $x_h, y_h$  be respectively the first and last vertex of  $P^h$ . Let  $A_h$  be the union of the at most two adhesions neighboring  $P^h$ , that is the set  $\bigcup_{zz' \in E(P), z \in V(P^h), z' \notin V(P^h)} W_z \cap W_{z'}$ . Note that  $|A_h| \leq 2(k - 1)$ . Finally, let  $G_h = G \left[ \bigcup_{z \in V(P^h)} W_z \right] \cup \binom{A_h}{2}$ . Since  $G$  is a  $(< k)$ -clique-sum of  $G_1, \dots, G_m$ , we want to bound  $\text{pd}_k(G_h)$ . If  $x_h = y_h$ , then  $|V(G_h)| = |W_{x_h}|$  and so the path decomposition of  $G_h$  consisting of a single bag has width less than  $\text{pw}(G) + 1 \leq f_7(k, \ell, \text{pw}(G))$  and is  $k$ -dismantable. Now suppose that  $x_h \neq y_h$ . By the properties of  $\mathcal{D}$ , there are  $k$  pairwise vertex-disjoint paths  $Q_1, \dots, Q_k$  from  $W_{x_h}$  to  $W_{y_h}$  in  $G$ . See Figure 2. Let  $\mathcal{F}$  be the family of all the connected subgraphs  $H$  of  $G_h - A_h$  such that  $V(H) \cap V(Q_i) \neq \emptyset$  for every  $i \in [k]$ . By Lemma 5, there are no  $f_5(k, \ell)$  pairwise disjoint members of  $\mathcal{F}$ . Now, by Lemma 10, there are  $f_5(k, \ell) - 1$  bags of  $\mathcal{D}$  whose union intersects every member of  $\mathcal{F}$ . Hence there is a set  $X_0^h$  of at most  $(f_5(k, \ell) - 1)(\text{pw}(G) + 1)$  vertices in  $G$  that intersects every member of  $\mathcal{F}$ . Let  $X_1^h = (X_0^h \cap V(G_h)) \cup A_h$ . For every connected component  $C$  of  $G_h - X_1^h$ ,  $V(C)$  is disjoint from  $X_0^h$ , and so  $C \notin \mathcal{F}$ . This implies that one the the paths in

$\{Q_1, \dots, Q_k\}$  is disjoint from  $V(C)$ , and so there is a path in  $G$  from  $W_{x_h}$  to  $W_{y_h}$  disjoint from  $V(C)$ . Since this path intersects  $W_z$  for all  $z \in P^h$ ,  $(P^h, (W_z \cap V(C) \mid z \in V(P^h)))$  is a path decomposition of  $C$  of width at most  $\text{pw}(G) - 1$ . By induction,  $\text{pd}_k(C) \leq f_7(k, \ell, \text{pw}(G) - 1)$  and so

$$\begin{aligned} \text{pd}_k(G_h - X_1^h) &\leq \max_{C \text{ connected component of } G_h - X_1^h} \text{pd}_k(C) \\ &\leq f_7(k, \ell, \text{pw}(G) - 1). \end{aligned}$$

Consider now a  $k$ -dismantlable path decomposition  $\mathcal{D}_h = (R^h, (W_{0,x}^h \mid x \in V(R^h)))$  of  $G_h - X_1^h$  of width at most  $f_7(k, \ell, \text{pw}(G) - 1)$ . Then  $(R^h, (W_{0,x}^h \cup X_1^h \mid x \in V(R^h)))$  is a  $k$ -dismantlable path decomposition of  $G_h$  of width less than  $f_7(k, \ell, \text{pw}(G) - 1) + (f_5(k, \ell) - 1)(\text{pw}(G) + 1) + 2(k - 1) = f_7(k, \ell, \text{pw}(G))$  such that  $A_h$  is included in every bag. In both cases ( $x_h = y_h$  and  $x_h \neq y_h$ ), we obtained a  $k$ -dismantlable path decomposition  $(R^h, (W_x^h \mid x \in V(R^h)))$  of  $G_h$  whose bags have size at most  $f_7(k, \ell, \text{pw}(G))$ , and with  $A_h$  included in every bag. Let  $R$  be the path obtained from the disjoint union of  $R^1, \dots, R^m$ , and adding an edge between the last vertex of  $R^h$  and the first vertex of  $R^{h+1}$ , for every  $h \in [m - 1]$ , and let  $W'_x = W_x^h$  for every  $x \in V(R^h)$ , for every  $h \in [m]$ . Then  $(R, (W'_x \mid x \in V(R)))$  is a  $k$ -dismantlable path decomposition of  $G$  whose bags have size at most  $f_7(k, \ell, \text{pw}(G))$ . This proves the theorem.  $\square$

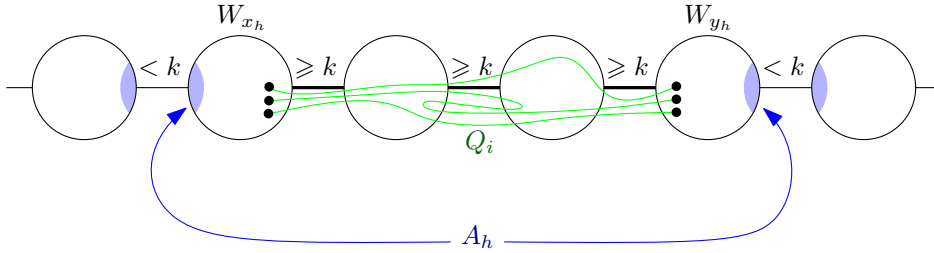

Figure 2: Illustration for the proof of Theorem 7.

This proof already contains several of the main ideas behind the proof of Theorem 1. The general approach to bound the  $k$ -treedepth of a graph  $G$  is to decompose  $G$  as a  $(< k)$ -clique-sum of graphs  $G_1, \dots, G_m$  such that for every  $i \in [m]$ , there exists  $X_i \subseteq G_i$  of bounded size such that we can bound the  $k$ -treedepth of  $G_i - X_i$  (typically by induction). Hence a first step is to identify these graphs  $G_i$ . In the bounded pathwidth case, this was done using Lemma 6, the clique-sums being then given by the adhesions of size less than  $k$  in the obtained path decomposition. In the case  $k = 2$ , there is a very natural way to find these clique-sums:  $G$  is a  $(< 2)$ -clique-sum of its blocks<sup>2</sup>, as used in [HJM<sup>+</sup>21]. For the general case, we will use a version of Lemma 6 for tree decompositions, which is inspired by a classical result by Thomas [Tho90] on the existence of “lean” tree decompositions. This initial tree decomposition will be built in Section 6. The techniques used in this section are inspired by a simple proof of Thomas’ result by Bellenbaum and Diestel [BD02].

An issue arising from this approach when considering tree decompositions instead of path decompositions is the following. When we say that  $G$  is a  $(< k)$ -clique-sums of  $G_1, \dots, G_m$ , the graphs  $G_i$  are not necessarily minors of  $G$ , and so they may contain a graph of the form  $T \square P_\ell$  for some tree  $T$  on  $k$  vertices. In the bounded pathwidth case, the graphs  $G_h$  for  $h \in [m]$  had just two additional cliques, corresponding to the right and left adhesions, and so we just removed

<sup>2</sup>The **blocks** of a graph  $G$  are the maximal subgraphs of  $G$  which consists in either a single vertex, a graph consisting of a single edge, or a 2-connected subgraph.

these cliques (the set  $A_h$ ) to obtain a subgraph of  $G$ . This is not possible in the general case since we can have arbitrarily many such cliques. To solve this issue, we will build  $G_1, \dots, G_m$  with  $V(G_h) \subseteq V(G)$  for every  $i \in [m]$ , such that, while  $G_h$  might not be a minor of  $G$ , the “connectivity” in  $G_h$  is not higher than in  $G$ , meaning that for every  $Z_1, Z_2 \subseteq V(G_h)$  both of size  $i$ , if there are  $i$  pairwise disjoint paths between  $Z_1$  and  $Z_2$  in  $G_h$ , then there are  $i$  pairwise disjoint paths between  $Z_1$  and  $Z_2$  in  $G$ . Hence, in the main proof, we will work on such an “almost minor” of  $G$ , and every time we will need the assumption that there is no minor of the form  $T \square P_\ell$  for a tree  $T$  on  $k$  vertices, we will come back to the original graph using this connectivity property. This notion is developed in Section 5.

Another important idea in the proof of Theorem 7 is the induction on  $\text{pw}(G)$ . For the general case, we want to proceed by induction on  $\text{tw}(G)$ , which is bounded by the Grid-Minor Theorem. However, it is in practice harder to decrease the treewidth than the pathwidth. To circumvent this issue, we need a notion of “partial tree decomposition”, which was already recently used in [HLMR24a] to prove some other excluded-minor results.

Let  $G$  be a graph and let  $S \subseteq V(G)$ . A **tree decomposition of  $(G, S)$**  is a tree decomposition  $(T, (W_x \mid x \in V(T)))$  of  $G[S]$  such that for every connected component  $C$  of  $G - S$ , there exists  $x \in V(T)$  such that  $N_G(V(C)) \subseteq W_x$  (the notation  $N_G(V(C))$  refers to the set  $\{u \in V(G) \setminus V(C) \mid \exists v \in V(C), uv \in E(G)\}$ ). Now, we will just assume that there is a tree decomposition of  $(G, S)$  of small width, and build by induction on this tree decomposition (actually on its adhesion) a  $k$ -dismantable tree decomposition of  $(G, S')$  of bounded width, for some  $S' \subseteq V(G)$  containing  $S$ . The point of reinforcing this way the induction hypothesis is that it is much easier to decrease the width or adhesion of a tree decomposition of a subset of  $V(G)$  than for the full  $V(G)$ . A crucial example is the following: let  $G$  be a graph, let  $\mathcal{D} = (T, (W_x \mid x \in V(T)))$  be a tree decomposition of  $G$ , let  $u \in V(G)$ , and let  $S = \bigcup_{x \in V(T), u \in W_x} W_x \setminus \{u\}$ . Now, for  $T' = T[\{x \in V(T) \mid u \in W_x\}]$ ,  $(T', (W_x \setminus \{u\} \mid x \in V(T')))$  is a tree decomposition of  $(G - u, S)$  whose width (resp. adhesion) is smaller than the width (resp. adhesion) of  $\mathcal{D}$ . See Figure 3. We can now call the induction hypothesis on  $(G - u, S)$ , and thus decompose a superset of  $N_G(u)$  in  $G - u$ . This idea is used in the final proof of Theorem 1, which is presented in Section 7.

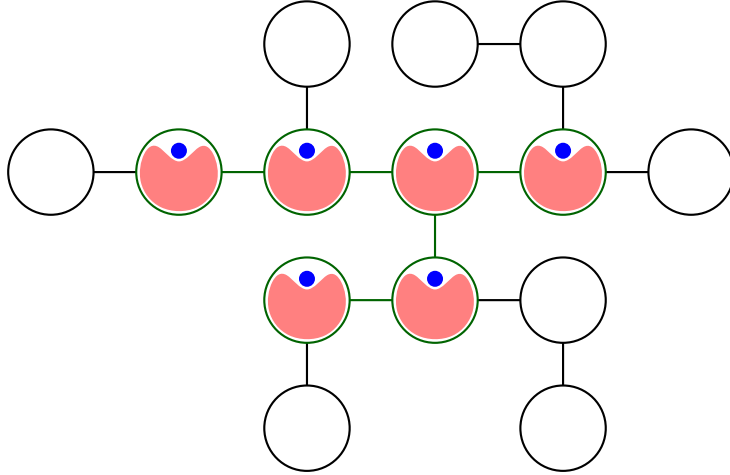

Figure 3: A tree decomposition of  $(G - u, S)$  of width at most  $\text{tw}(G) - 1$ . The blue vertex depicts  $u$ , the tree  $T' = T[\{x \in V(T) \mid u \in W_x\}]$  is depicted in green, and  $S = \bigcup_{x \in V(T')} W_x \setminus \{u\}$  is the union of the red sets.



## 2 Preliminaries

### 2.1 Notation

We will use the following standard notation. Let  $k$  be a positive integer and let  $X$  be a set. We denote by  $[k]$  the set  $\{1, \dots, k\}$ , and by  $\binom{X}{k}$  the family of all the subsets of  $X$  of size  $k$ .

Graphs considered in this paper are finite, undirected, with no loops, and with no multiple edges. Let  $G$  be a graph. We denote by  $V(G)$  its vertex set and by  $E(G)$  its edge set. If  $u \in V(G)$ , then  $N_G(u) = \{v \in V(G) \mid uv \in E(G)\}$ . If  $U \subseteq V(G)$ , then  $N_G(U) = \bigcup_{u \in U} (N_G(u) \setminus U)$ . If  $U \subseteq V(G)$ , we say that  $U$  is **connected in  $G$**  if there is a connected component of  $G$  containing  $U$ . If  $X \subseteq V(G)$ , we denote by  $G - X$  is the subgraph of  $G$  induced by  $V(G) \setminus X$ . If  $F \subseteq \binom{V(G)}{2}$ , we denote by  $G \cup F$  is the graph obtained from  $G$  by adding an edge between every pair of vertices in  $F$ , and by  $G \setminus F$  is the graph obtained from  $G$  by removing every edge in  $F \cap E(G)$ . A **path partition** of  $G$  is a sequence of  $(V_0, \dots, V_\ell)$  of pairwise disjoint nonempty subsets of  $V(G)$ , such that  $\bigcup_{0 \leq i \leq \ell} V_i = V(G)$ , and for every edge  $uv$  of  $G$ , if  $i, j \in \{0, \dots, \ell\}$  are the indices such that  $u \in V_i$  and  $v \in V_j$ , then  $|i - j| \leq 1$ .

Let  $G_1, G_2$  be two graphs. The **Cartesian product** of  $G_1$  and  $G_2$ , denoted by  $G_1 \square G_2$ , is the graph with vertex set  $V(G_1) \times V(G_2)$  and edge set  $\{(u_1, u_2)(v_1, v_2) \mid (u_1 = v_1 \text{ and } u_2 v_2 \in E(G_2)) \text{ or } (u_1 v_1 \in E(G_1) \text{ and } u_2 = v_2)\}$ .

Let  $G$  be a graph. A **path** in  $G$  is a sequence  $P = (p_1, \dots, p_\ell)$  of pairwise distinct vertices of  $G$  such that  $p_i p_{i+1} \in E(G)$  for every  $i \in [\ell - 1]$ . Then we say that  $P$  is a  $(p_1, p_\ell)$ -path in  $G$ , or simply a path from  $p_1$  to  $p_\ell$ . The **length** of  $P$  is  $\ell - 1$ . We denote by  $\text{init}(P)$  its **initial vertex**  $p_1$ , and by  $\text{term}(P)$  its **terminal vertex**  $p_\ell$ . If  $p_1 \in U$  and  $p_\ell \in U'$  for some  $U, U' \subseteq V(G)$ , we say that  $P$  is a  $(U, U')$ -path, or a path from  $U$  to  $U'$ . Note that paths are thus oriented, but we will sometimes identify such a path  $P$  with the subgraph  $(V(P), \{p_i p_{i+1} \mid i \in [\ell - 1]\})$ . A  $(U, U')$ -**cut** is a set  $X$  of vertices in  $G$  such that every  $(U, U')$ -path intersects  $X$ . Recall that Menger's Theorem asserts that the minimum size of a  $(U, U')$ -cut is equal to the maximum number of pairwise vertex-disjoint  $(U, U')$ -paths. For every positive integer  $\ell$ , we denote by  $P_\ell$  the path  $(1, \dots, \ell)$ , seen as the graph  $([\ell], \{(i, i + 1) \mid i \in [\ell - 1]\})$ . We call the graph  $P_k \square P_\ell$  the  $k \times \ell$  **grid**.

Let  $T$  be a tree and let  $u, v \in V(T)$ . We denote by  $T[u, v]$  the (unique) path from  $u$  to  $v$  in  $T$ . Similarly,  $T]u, v[ = T[u, v] - \{u\}$ ,  $T[u, v[ = T[u, v] - \{v\}$ ,  $T]u, v[ = T[u, v] - \{u, v\}$ . Moreover, if  $uv$  is an edge of  $T$ , then we denote by  $T_{u|v}$  the connected component of  $u$  in  $T \setminus \{uv\}$ .

Throughout the paper, we say that two graphs  $G_1, G_2$  are **disjoint** if they are vertex-disjoint, that is  $V(G_1) \cap V(G_2) = \emptyset$ .

### 2.2 Graph minors and tree decompositions

Let  $H, G$  be two graphs. We say that  $H$  is a **minor** of  $G$  if  $H$  can be obtained from  $G$  by successive vertex deletions, edge deletions, edge contractions. Equivalently,  $H$  is a minor of  $G$  if and only if  $G$  contains a **model of  $H$** , that is a family  $(B_x \mid x \in V(H))$  of pairwise disjoint subsets of  $V(G)$  such that

- (i)  $G[B_x]$  is connected for every  $x \in V(H)$ , and
- (ii) there is an edge in  $G$  between  $B_x$  and  $B_y$  for every  $xy \in E(H)$ .

If  $H$  is not a minor of  $G$ , then we say that  $G$  is  **$H$ -minor-free**.

Given two graphs  $G_1, G_2$ , a **clique-sum of  $G_1$  and  $G_2$**  is a graph  $G$  obtained by choosing a clique  $C_1$  in  $G_1$ , a clique  $C_2$  in  $G_2$ , and a bijection  $\varphi: V(C_1) \rightarrow V(C_2)$ , and by identifying in the disjoint union of  $G_1$  and  $G_2$  the vertex  $u$  with  $\varphi(u)$ , for every  $u \in V(C_1)$ , and possibly removing

some edges in the resulting clique. Given an integer  $k$ , a  $(< k)$ -**clique-sum of  $G_1$  and  $G_2$**  is such a graph  $G$ , with the additional condition  $|C_1| = |C_2| < k$ . The notion of clique-sum behaves well with the minor relation. In particular a minor of a clique-sum of  $G_1$  and  $G_2$  is a clique-sum of a minor of  $G_1$  and a minor  $G_2$ . Moreover, the notion of clique-sum gives the following characterization of treewidth.

**Proposition 8** (Folklore). *The treewidth is the largest graph parameter  $\text{tw}$  satisfying*

- (a)  $\text{tw}(\emptyset) = -1$ ,
- (b)  $\text{tw}(G) \leq \text{tw}(G - u) + 1$  for every graph  $G$  and every  $u \in V(G)$ , and
- (c)  $\text{tw}(G) \leq \max\{\text{tw}(G_1), \text{tw}(G_2)\}$  if  $G$  is a clique-sum of  $G_1$  and  $G_2$ .

Robertson and Seymour [RS86] characterized minor-closed classes of graphs of bounded treewidth in terms of excluded minors. This fundamental result, known as the Grid-Minor Theorem, will be used several times in this paper.

**Theorem 9** (Robertson and Seymour [RS86]). *There is a function  $f_9: \mathbb{N} \rightarrow \mathbb{N}$  such that for every integer  $\ell$ , for every graph  $G$ , if the  $\ell \times \ell$  grid is not a minor of  $G$ , then*

$$\text{tw}(G) < f_9(\ell).$$

Let  $\mathcal{D} = (T, (W_x \mid x \in V(T)))$  be a tree decomposition of a graph  $G$ . Given a connected subgraph  $F$  of  $G$ , its **projection** on  $T$  (according to  $\mathcal{D}$ ) is the subtree of  $T$  induced by  $\{x \in V(T) \mid V(F) \cap W_x \neq \emptyset\}$ . By the properties of tree decompositions, the projection of a connected subgraph is connected. By the Helly property for subtrees, we obtain the following fundamental lemma.

**Lemma 10** (Statement (8.7) in [RS86]). *Let  $d$  be a positive integer. For every graph  $G$ , for every tree decomposition  $\mathcal{D}$  of  $G$ , for every family  $\mathcal{F}$  of connected subgraphs of  $G$ , one of the following holds:*

- (1) *there are  $d$  members of  $\mathcal{F}$  whose projections are pairwise disjoint, or*
- (2) *there is a set of at most  $d - 1$  bags of  $\mathcal{D}$  whose union intersects every member of  $\mathcal{F}$ .*

Let  $G$  be a graph and let  $S$  be a non empty subset of  $V(G)$ . A **tree decomposition of  $(G, S)$**  is a pair  $\mathcal{D} = (T, (W_x \mid x \in V(T)))$  such that

- (i)  $\mathcal{D}$  is a tree decomposition of  $G[S]$ , and
- (ii) for every connected component  $C$  of  $G - S$ , there exists  $x \in V(T)$  such that  $N_G(V(C)) \subseteq W_x$ .

We denote by  $\text{tw}(G, S)$  the minimum width of a tree decomposition of  $(G, S)$ .

### 2.3 $k$ -dismantable tree decompositions

In this section, we recall the definition of  $k$ -dismantable tree decompositions, and we prove some of their properties. Let  $k$  be a positive integer. A tree decomposition  $(T, (W_x \mid x \in V(T)))$  is  **$k$ -dismantable** if one of the following holds.

- (i)  $T$  has a single vertex  $x$  and  $W_x = \emptyset$ ; or

- (ii) there is a vertex  $v \in V(G)$  such that  $v \in W_x$  for every  $x \in V(T)$ , and  $(T, (W_x \setminus \{v\} \mid x \in V(T)))$  is  $k$ -dismantable; or
- (iii) there is an edge  $xy \in E(T)$  such that  $|W_x \cap W_y| < k$  and the tree decompositions  $(T_{x|y}, (W_z \mid z \in V(T_{x|y})))$  and  $(T_{y|x}, (W_z \mid z \in V(T_{y|x})))$  are  $k$ -dismantable.

A straightforward induction shows the following.

**Observation 11.** *A graph  $G$  has  $k$ -treedepth at most  $t$  if and only if  $G$  admits a  $k$ -dismantable tree decomposition of width less than  $t$ .*

*Proof.* Let  $\text{td}'_k(G)$  be 1 plus the minimum width of a  $k$ -dismantable tree decomposition of  $G$ , for every graph  $G$ . We want to prove that  $\text{td}'_k(G) = \text{td}_k(G)$  for every graph  $G$ . First we show that  $\text{td}'_k(G) \leq \text{td}_k(G)$ . It is enough to show that (i)  $\text{td}'_k(\emptyset) = 0$ ; (ii)  $\text{td}'_k(G) \leq 1 + \text{td}'_k(G - u)$  for every  $u \in V(G)$ ; and (iii)  $\text{td}'_k(G) \leq \max\{\text{td}'_k(G_1), \text{td}'_k(G_2)\}$  if  $G$  is a  $(< k)$ -clique-sum of  $G_1$  and  $G_2$ . The first point is clear. The second one comes from the fact that if  $(T, (W_x \mid x \in V(T)))$  is a  $k$ -dismantable tree decomposition of  $G - u$ , then  $(T, (W_x \cup \{u\} \mid x \in V(T)))$  is a  $k$ -dismantable tree decomposition of  $G$ . For the third point, suppose that  $G$  is obtained from the union of two graphs  $G_1$  and  $G_2$  with  $C = V(G_1) \cap V(G_2)$  inducing a clique of size at most  $k - 1$  in both  $G_1$  and  $G_2$ . Let  $(T_i, (W_x \mid x \in V(T_i)))$  is a  $k$ -dismantable tree decomposition of  $G_i$ , for  $i \in \{1, 2\}$ . Then, since  $C$  is a clique in  $G_i$ , the projections of  $G_i[\{u\}]$  for  $u \in C$  pairwise intersect. Hence by the Helly property, there exists  $x_i \in V(T_i)$  intersecting all these projections, that is  $C \subseteq W_{x_i}$ . Now,  $(T_1 \cup T_2 \cup \{x_1 x_2\}, (W_x \mid x \in V(T_1) \cup V(T_2)))$  is a  $k$ -dismantable tree decomposition of  $G$ . This proves that  $\text{td}'_k(G) \leq \text{td}_k(G)$  for every graph  $G$ .

Now we show by induction on  $|V(G)| + |V(T)|$  that  $\text{td}_k(G) \leq \text{td}'_k(G)$  for every graph  $G$ . Let  $(T, (W_x \mid x \in V(T)))$  be a  $k$ -dismantable tree decomposition of  $G$  of width  $t - 1$  for  $t = \text{td}'_k(G)$ . If  $T$  has a single vertex  $x$  and  $W_x = \emptyset$ , then  $t = 0$  and  $\text{td}_k(G) = 0 \leq t$ . If  $v \in V(G)$  is such that  $v \in W_x$  for every  $x \in V(T)$ , and  $(T, (W_x \setminus \{v\} \mid x \in V(T)))$  is  $k$ -dismantable, then  $\text{td}_k(G - v) \leq \text{td}'_k(G - v) \leq t - 1$  by the induction hypothesis, and so  $\text{td}_k(G) \leq 1 + \text{td}_k(G - v) \leq t$ . If there is an edge  $xy \in E(T)$  such that  $|W_x \cap W_y| < k$  and the tree decompositions  $(T_{x|y}, (W_z \mid z \in V(T_{x|y})))$  and  $(T_{y|x}, (W_z \mid z \in V(T_{y|x})))$  are  $k$ -dismantable, then let  $G_1 = G \left[ \bigcup_{z \in V(T_{x|y})} W_z \right] \cup (W_x \cap W_y)$  and  $G_2 = G \left[ \bigcup_{z \in V(T_{y|x})} W_z \right] \cup (W_x \cap W_y)$ . Observe that  $W_x \cap W_y = V(G_1) \cap V(G_2)$  induces a clique of size less than  $k$  in both  $G_1$  and  $G_2$ , and  $G$  is a  $(< k)$ -clique-sum of  $G_1$  and  $G_2$ . Moreover, the  $k$ -dismantable tree decompositions  $(T_{x|y}, (W_z \mid z \in V(T_{x|y})))$ ,  $(T_{y|x}, (W_z \mid z \in V(T_{y|x})))$  witness the fact that  $\text{td}'_k(G_1), \text{td}'_k(G_2) \leq t$ . Hence, since by the induction hypothesis  $\text{td}'_k(G_1), \text{td}'_k(G_2) \leq t$ , we have  $\text{td}_k(G) \leq \max\{\text{td}_k(G_1), \text{td}_k(G_2)\} \leq t$ . This proves that  $\text{td}_k(G) \leq \text{td}'_k(G)$ .  $\square$

We now prove that  $k$ -treedepth is monotone for the graph minor relation.

**Lemma 12.** *Let  $k$  be a positive integer and let  $G, H$  be two graphs. If  $H$  is a minor of  $G$ , then*

$$\text{td}_k(H) \leq \text{td}_k(G).$$

*Proof.* Given a class of graphs  $\mathcal{C}$ , we denote by  $\mathbf{A}(\mathcal{C})$  the class of all the graphs  $G$  such that  $G \in \mathcal{C}$  or there exists  $u \in V(G)$  such that  $G - u \in \mathcal{C}$ . We claim that

if  $\mathcal{C}$  is minor-closed, then  $\mathbf{A}(\mathcal{C})$  is minor-closed.

Indeed, if  $G$  is a graph and  $u \in V(G)$  such that  $G - u \in \mathcal{C}$ , then for every minor  $H$  of  $G$ , if  $(B_x \mid x \in V(H))$  is a model of  $H$  in  $G$ , then either  $u \notin \bigcup_{x \in V(H)} B_x$ , and so  $(B_x \mid x \in V(H))$  is a model of  $H$  in  $G - u$ , which implies  $H \in \mathcal{C} \subseteq \mathbf{A}(\mathcal{C})$ ; or  $u \in \bigcup_{x \in V(H)} B_x$ , and then

$(B_x \mid x \in V(H - x_0))$  is a model of  $H - x_0$  in  $G - u$ , where  $x_0$  is the unique vertex of  $V(H)$  such that  $u \in B_{x_0}$ , which implies  $H - x_0 \in \mathcal{C}$  and so  $H \in \mathbf{A}(\mathcal{C})$ .

Let  $k$  be a positive integer. We denote by  $\mathbf{S}_k(\mathcal{C})$  the class of all the graphs  $G$  such that  $G$  is a  $(< k)$ -clique-sum of two graphs in  $\mathcal{C}$ . We claim that

if  $\mathcal{C}$  is minor-closed, then  $\mathbf{S}_k(\mathcal{C})$  is minor-closed.

To see that, consider a graph  $G$  which is a  $(< k)$ -clique-sums of two graphs  $G_1$  and  $G_2$  in  $\mathcal{C}$ . We can assume that  $V(G) = V(G_1) \cup V(G_2)$ ,  $E(G) \subseteq E(G_1) \cup E(G_2)$ , and  $V(G_1) \cap V(G_2)$  induces a clique of size at most  $k - 1$  in both  $G_1$  and  $G_2$ . Let  $H$  be a minor of  $G$ , and let  $(B_x \mid x \in V(H))$  be a model of  $H$  in  $G$ . For  $i \in \{1, 2\}$ , let  $X_i = \{x \in V(H) \mid B_x \cap V(G_i) \neq \emptyset\}$ , and let  $H_i = H[X_i] \cup \binom{X_1 \cap X_2}{2}$ . Then, for each  $i \in \{1, 2\}$ ,  $(B_x \cap V(G_i) \mid x \in X_i)$  is a model of  $H_i$  in  $G_i$ , and so  $H_i$  is a minor of  $G_i$ . In particular,  $H_i \in \mathcal{C}$ . Finally,  $H$  is a  $(< k)$ -clique-sum of  $H_1$  and  $H_2$ , and so  $H \in \mathbf{S}_k(\mathcal{C})$ .

For every nonnegative integer  $i$ , let

$$\mathbf{S}_k^i(\mathcal{C}) = \begin{cases} \mathcal{C} & \text{if } i = 0 \\ \mathbf{S}_k(\mathbf{S}_k^{i-1}(\mathcal{C})) & \text{if } i > 0. \end{cases}$$

By induction on  $i$ ,  $\mathbf{S}_k^i(\mathcal{C})$  is minor-closed if  $\mathcal{C}$  is minor-closed. Then  $(\mathbf{S}_k^i(\mathcal{C}))_{i \geq 0}$  is an inclusion-wise monotone sequence of minor-closed classes of graphs, and so its union  $\overline{\mathbf{S}}_k(\mathcal{C})$  is minor-closed.

We can now show by induction that for every nonnegative integer  $t$ , the class  $\{\text{td}_k \leq t\}$  of all the graphs of  $k$ -treedepth at most  $t$  is minor-closed. Indeed, when  $t = 0$ ,  $\{\text{td}_k \leq 0\} = \{\emptyset\}$  is clearly minor-closed. Moreover, if  $t \geq 1$  and  $\{\text{td}_k \leq t - 1\}$  is minor-closed, then the class  $\overline{\mathbf{S}}_k(\mathbf{A}(\{\text{td}_k \leq t - 1\}))$  is also minor-closed by the previous observations. To conclude, it is enough to show that

$$\{\text{td}_k \leq t\} = \overline{\mathbf{S}}_k(\mathbf{A}(\{\text{td}_k \leq t - 1\})). \quad (1)$$

The inclusion  $\overline{\mathbf{S}}_k(\mathbf{A}(\{\text{td}_k \leq t - 1\})) \subseteq \{\text{td}_k \leq t\}$  follows from the definition of  $k$ -treedepth. We now prove the other inclusion. Let  $G$  be a graph of  $k$ -treedepth at most  $t$  and let  $(T, (W_x \mid x \in V(T)))$  be a  $k$ -dismantable tree decomposition of  $G$ , which exists by Observation 11. We want to show that  $G \in \overline{\mathbf{S}}_k(\mathbf{A}(\{\text{td}_k \leq t - 1\}))$ . We proceed by induction on  $|V(G)| + |V(T)|$ . If  $V(G) = \emptyset$ , then the result is clear. Now assume  $V(G) \neq \emptyset$ . By the definition of  $k$ -dismantable tree decompositions, one of the following holds.

**Case 1.** There is a vertex  $v \in V(G)$  such that  $v \in W_x$  for every  $x \in V(T)$ , and  $(T, (W_x \setminus \{v\} \mid x \in V(T)))$  is  $k$ -dismantable. Then by Observation 11,  $\text{td}_k(G - v) \leq t - 1$  and so  $G \in \mathbf{A}(\{\text{td}_k \leq t - 1\}) \subseteq \overline{\mathbf{S}}_k(\mathbf{A}(\{\text{td}_k \leq t - 1\}))$ .

**Case 2.** There is an edge  $xy \in E(T)$  such that  $|W_x \cap W_y| < k$  and the tree decompositions  $\mathcal{D}_{x|y} = (T_{x|y}, (W_z \mid z \in V(T_{x|y})))$  and  $\mathcal{D}_{y|x} = (T_{y|x}, (W_z \mid z \in V(T_{y|x})))$  are  $k$ -dismantable. Let  $G_{x|y}$  (resp.  $G_{y|x}$ ) be the graph  $G[\bigcup_{z \in V(T_{x|y})} W_z] \cup \binom{W_x \cap W_y}{2}$  (resp.  $G[\bigcup_{z \in V(T_{y|x})} W_z] \cup \binom{W_x \cap W_y}{2}$ ). The  $k$ -dismantable tree decompositions  $\mathcal{D}_{x|y}$  and  $\mathcal{D}_{y|x}$  witness the fact that respectively  $G_{x|y}$  and  $G_{y|x}$  have  $k$ -treedepth at most  $t$ . By the induction hypothesis, we deduce that  $G_{x|y}, G_{y|x} \in \overline{\mathbf{S}}_k(\mathbf{A}(\{\text{td}_k \leq t - 1\}))$ . Since  $G$  is a  $(< k)$ -clique-sum of  $G_{x|y}$  and  $G_{y|x}$ , this implies that  $G \in \overline{\mathbf{S}}_k(\mathbf{A}(\{\text{td}_k \leq t - 1\}))$ . This proves (1), and concludes the proof of the lemma.  $\square$

Similarly, for every positive integer  $k$ , for every graph  $G$  and for every nonempty set  $S \subseteq V(G)$ , we denote by  $\text{td}_k(G, S)$  the integer 1 plus the minimum width of a  $k$ -dismantable tree decomposition of  $(G, S)$ .

**Lemma 13.** Let  $m, t, k$  be positive integers. For every graph  $G$  and for every  $S_1, \dots, S_m \subseteq V(G)$ , if  $S = \bigcup_{i \in [m]} S_i$ , then

(a)  $\text{tw}(G, S) + 1 \leq \sum_{i \in [m]} (\text{tw}(G, S_i) + 1)$ , and

(b)  $\text{td}_k(G, S) \leq \sum_{i \in [m]} \text{td}_k(G, S_i)$ .

*Proof.* Since for every  $S \subseteq V(G)$ ,  $\text{td}_{|V(G)|}(G, S) = \text{tw}(G, S) + 1$ , it is enough to show the second item. We proceed by induction on  $m$ . The result is clear for  $m = 1$ . Now suppose  $m > 1$  and  $\text{td}_k(G, \bigcup_{i \in [m-1]} S_i) \leq \sum_{i \in [m-1]} \text{td}_k(G, S_i)$ . Let  $\mathcal{D} = (T, (W_x \mid x \in V(T)))$  be a  $k$ -dismantlable tree decomposition of  $(G, \bigcup_{i \in [m-1]} S_i)$  of width less than  $\sum_{i \in [m-1]} \text{td}_k(G, S_i)$ . For every connected component  $C$  of  $G - \bigcup_{i \in [m-1]} S_i$ , we have  $\text{td}_k(C, S_m \cap V(C)) \leq \text{td}_k(G, S_m)$ . Let  $x_C \in V(T)$  be such that  $N_G(V(C)) \subseteq W_{x_C}$ . Hence there is a  $k$ -dismantlable tree decomposition  $(T_C, (W_x^C \mid x \in V(T_C)))$  of  $(C, S_m \cap V(C))$  of width at most  $\text{td}_k(G, S_m) - 1$ . We suppose that the trees  $T_C$  for  $C$  connected component of  $G - \bigcup_{i \in [m-1]} S_i$  and  $T$  are pairwise disjoint. Let  $T'$  be the tree obtained from the union of  $T$  with all the  $T_C$ , by adding an edge between  $x_C$  and an arbitrary vertex in  $T_C$ , for each connected component  $C$  of  $G - \bigcup_{i \in [m-1]} S_i$ . For every  $x \in V(T)$ , let  $W'_x = W_x$ , and for every  $x \in V(T_C)$ , let  $W'_x = W_x^C \cup W_{x_C}$ , for each connected component  $C$  of  $G - \bigcup_{i \in [m-1]} S_i$ . See Figure 4. Then  $(T', (W'_x \mid x \in V(T')))$  is a  $k$ -dismantlable tree decomposition of  $(G, S)$  of width less than  $\text{td}_k(G, S_m) + \sum_{i \in [m-1]} \text{td}_k(G, S_i)$ . This proves the lemma.  $\square$

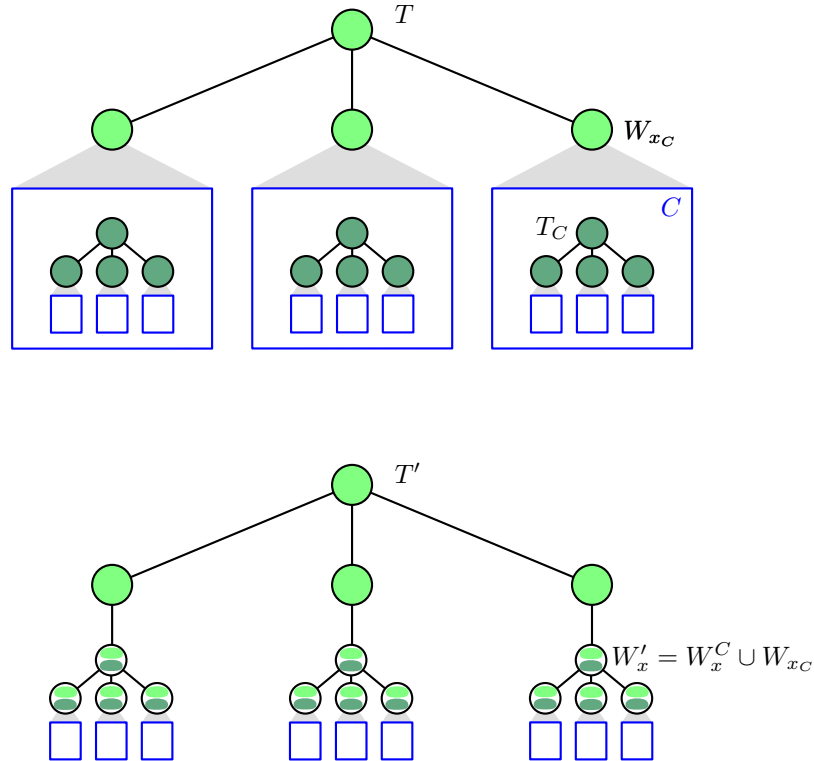

Figure 4: Illustration for the proof of Lemma 13.

### 3 $\{T \square P_\ell \mid \ell \geq 1\}$ has unbounded $k$ -treedepth

In this section, we prove that graphs of the form  $T \square P_\ell$  for some tree  $T$  on  $k$  vertices have unbounded  $k$ -treedepth when  $\ell$  tends to  $+\infty$ . This proves the “only if” part of Theorem 1.

**Proposition 14.** *For every tree  $S$ , for every positive integer  $N$ , there is a positive integer  $\ell$  such that*

$$\text{td}_k(S \square P_\ell) > N.$$

*Proof.* Fix a tree  $S$  on  $k$  vertices. Suppose for a contradiction that there exists a positive integer  $N$  such that  $\text{td}_k(S \square P_\ell) \leq N$  for every positive integer  $\ell$ . By taking  $N$  minimal, we can assume that, for some positive integer  $\ell_0$ ,

$$\text{td}_k(S \square P_{\ell_0}) = N$$

for every  $\ell \geq \ell_0$ .

Consider  $G = S \square P_{(2\ell_0+2)N}$ . We denote by  $R_1, \dots, R_k$  the copies of  $P_{(2\ell_0+1)N}$  in  $G$ , that is the subgraphs  $G[\{(x, i) \mid i \in [(2\ell_0+2)N]\}]$  for  $x \in V(S)$ ; and by  $C_1, \dots, C_{(2\ell_0+2)N}$  the copies of  $S$  in  $G$ , that is the subgraphs  $G[\{(x, i) \mid x \in V(S)\}]$  for  $i \in [(2\ell_0+2)N]$ . By hypothesis  $\text{td}_k(G) = N$ , and so by Observation 11,  $G$  admits a  $k$ -dismantable tree decomposition  $\mathcal{D} = (T, (W_x \mid x \in V(T)))$  of width  $N - 1$ .

For every  $x \in V(T)$ , the bag  $W_x$  has size at most  $N$ , and so intersects at most  $N$  of the subgraphs  $C_i$  for  $i \in [(2\ell_0+2)N]$ . Therefore, by Lemma 10, there are indices  $1 \leq i_1 < \dots < i_{2\ell_0+2} \leq (2\ell_0+2)N$  such that  $C_{i_1}, \dots, C_{i_{2\ell_0+2}}$  have pairwise vertex disjoint projections on  $T$ , that is for every distinct  $j, j' \in [2\ell_0+2]$ ,  $T_j = T[\{x \in V(T) \mid W_x \cap C_{i_j} \neq \emptyset\}]$  and  $T_{j'} = T[\{x \in V(T) \mid W_x \cap C_{i_{j'}} \neq \emptyset\}]$  are vertex-disjoint. For every  $a \in [k]$  and  $j \in [2\ell_0+1]$ , let  $R_{a,j}$  be the subpath of  $R_a$  with first vertex in  $C_{i_j}$  and last vertex in  $C_{i_{j+1}}$ . Moreover, let  $u_{a,j}$  be the last vertex belonging to  $\bigcup_{x \in V(T_j)} W_x \cap V(R_{a,j})$  along  $R_{a,j}$ . Note that for every  $j \in [2\ell_0+1]$ ,  $C'_j = \{u_{a,j} \mid a \in [k]\}$  is included in a bag of  $\mathcal{D}$ , namely  $W_{z_j}$  where  $z_j$  is the first node of the (unique) path from  $V(T_j)$  to  $V(T_{j+1})$  in  $T$ . Moreover, the vertices  $u_{a,j}$  for  $a \in [k]$  and  $j \in [2\ell_0+1]$  are pairwise distinct.

Let  $F$  be the forest obtained from  $T$  by removing every edge  $xy \in E(T)$  such that  $|W_x \cap W_y| < k$ . We claim that  $\{z_j \mid j \in [2\ell_0+1]\}$  is in a single connected component of  $F$ . Indeed, otherwise there is a cut of size less than  $k$  between  $W_{z_j}$  and  $W_{z_{j'}}$  in  $G$ , for some distinct  $j, j' \in [2\ell_0+1]$ . But this is a contradiction since  $R_1, \dots, R_k$  induce  $k$  vertex-disjoint paths from  $C'_j \subseteq W_{z_j}$  to  $C'_{j'} \subseteq W_{z_{j'}}$ . Let  $T'$  be this connected component.

Let  $\widehat{G}$  be the graph with vertex set  $\bigcup_{z \in V(T')} W_z$  and edge set  $\bigcup_{z \in V(T')} \binom{W_z}{2}$ . For every  $a \in [k]$ , let  $r_{a,1}, \dots, r_{a,m_a}$  be the vertices of  $V(R_a) \cap V(\widehat{G})$ , in this order along  $R_a$ . Observe that  $\widehat{R}_a = (r_{a,1}, \dots, r_{a,m_a})$  is a path in  $\widehat{G}$ . Moreover, for every  $a \in [k]$ ,  $\widehat{R}_a$  intersects each of  $C'_1, \dots, C'_{2\ell_0+1}$  in this order along  $\widehat{R}_a$ . Since  $C'_j$  induces a clique in  $\widehat{G}$  for every  $j \in [2\ell_0+1]$ , we deduce that there is a model of a  $K_k \square P_{2\ell_0+1}$  in  $\widehat{G}$ . Moreover,  $\widehat{G}$  has a  $k$ -dismantable tree decomposition  $\mathcal{D}' = (T', (W_x \mid x \in V(T')))$  of width less than  $N$  and such that every adhesion has size at least  $k$ . It follows that there is a vertex  $v \in V(\widehat{G})$  such that  $v \in W_x$  for every  $x \in V(T')$  and  $(T', (W_x \setminus \{v\} \mid x \in V(T')))$  is a  $k$ -dismantable tree decomposition. This implies that  $\text{td}_k(\widehat{G} - v) < N$ . But since  $\widehat{G}$  contains a model of  $K_k \square P_{2\ell_0+1}$ ,  $\widehat{G} - v$  contains a model of  $K_k \square P_{\ell_0}$ . By Lemma 12, we deduce that

$$\text{td}_k(S \square P_{\ell_0}) \leq \text{td}_k(K_k \square P_{\ell_0}) \leq \text{td}_k(\widehat{G} - v) < N,$$

contradicting the definition of  $\ell_0$ . This proves the lemma.  $\square$

## 4 Finding a $k$ -ladder

In this section, we show how to extract a graph of the form  $T \square P_\ell$  with  $T$  a tree on  $k$  vertices, from a graph having  $k$  disjoint paths  $Q_1, \dots, Q_k$ , and sufficiently many pairwise vertex-disjoint connected subgraphs intersecting all the  $Q_i$ s.

Let  $k, \ell$  be two positive integers. A  $k$ -ladder of length  $\ell - 1$  is a graph  $H$  with vertex set  $[k] \times [\ell]$  such that

- (i) for every  $i \in [k]$ ,  $R_i = H[\{(i, j) \mid j \in [\ell]\}]$  is a path with ordering  $(i, 1), \dots, (i, \ell)$ , and
- (ii) for every  $j \in [\ell]$ ,  $C_j = H[\{(i, j) \mid i \in [k]\}]$  is connected.

See Figure 5. We call  $R_1, \dots, R_k$  the **rows** of  $H$ , and  $C_1, \dots, C_\ell$  its **columns**.

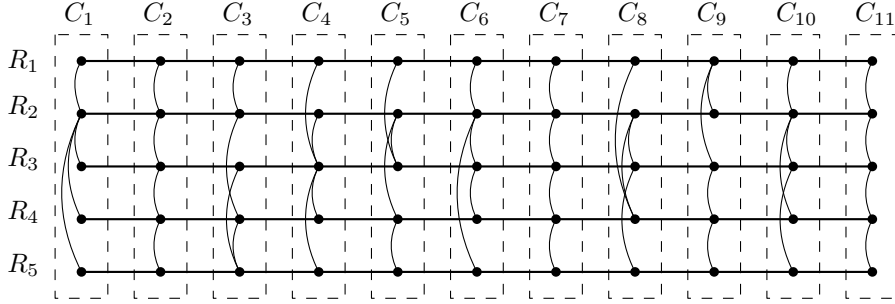

Figure 5: A 5-ladder of length 10.

Since every  $C_i$  is connected, we can assume without loss of generality that they are trees. Then, using Cayley's formula stating that there are  $k^{k-2}$  labelled trees on  $k$  vertices, we deduce the following observation.

**Observation 15.** *For every  $k, \ell$ , if  $H$  is a  $k$ -ladder of length  $k^{k-2}(\ell - 1) + 1$ , then there is a tree  $T$  on  $k$  vertices such that  $T \square P_\ell$  is a minor of  $H$ .*

Hence it suffices to find a long enough  $k$ -ladder as a minor to find a minor of the form  $T \square P_\ell$  for some tree  $T$  on  $k$  vertices. Our main tool to do so is the following lemma, which is the main result of this section.

**Lemma 16.** *There is a function  $f_{16}: \mathbb{N}^2 \rightarrow \mathbb{N}$  such that the following holds. Let  $k$  be a positive integer, let  $G$  be a graph, and let  $Q_1, \dots, Q_k$  be  $k$  vertex-disjoint paths in  $G$ . If there exists  $f_{16}(k, \ell)$  pairwise vertex-disjoint connected subgraphs in  $G$  each intersecting  $V(Q_i)$  for every  $i \in [k]$ , then  $G$  has a  $k$ -ladder of length  $\ell$  as a minor.*

Together with Observation 15, this lemma implies Lemma 5. To core of the proof of Lemma 16 is the following intermediary result.

**Lemma 17.** *There is a function  $f_{17}: \mathbb{N}^2 \rightarrow \mathbb{N}$  such that the following holds. Let  $G$  be a graph, let  $t, \ell$  be positive integers, let  $P$  be a path in  $G$ , and let  $A_1, \dots, A_{f_{17}(t, \ell)}$  be pairwise vertex-disjoint connected subgraphs of  $G$  such that for every  $i \in [f_{17}(t, \ell)]$ ,  $1 \leq |V(A_i) \cap V(P)| \leq 2t - 1$ . Then there are subgraphs  $B_1, \dots, B_\ell$  in  $\{A_i\}_{i \in [f_{17}(t, \ell)]}$ , a subpath of  $P$  of the form  $P[\text{init}(P), b]$ , and for every  $j \in [\ell]$  a subpath  $P[a_j, b_j]$  of  $P[\text{init}(P), b]$ , such that*

- (a)  $V(B_j) \cap V(P[\text{init}(P), b]) \neq \emptyset$  for every  $j \in [\ell]$ ,
- (b)  $V(B_j) \cap V(P[\text{init}(P), b]) \subseteq V(P[a_j, b_j])$  for every  $j \in [\ell]$ , and

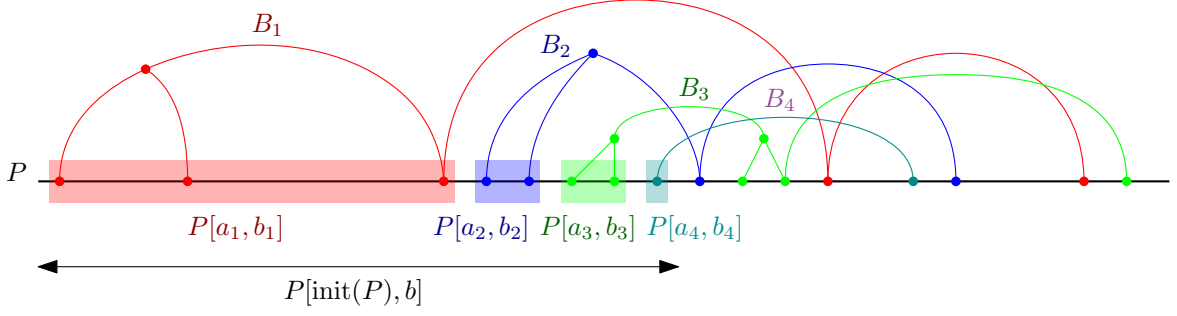

Figure 6: Illustration for Lemmas 17 and 19 with  $\ell = 4$ . There is a subpath  $P[\text{init}(P), b]$  such that each  $B_j$  has a “private” interval  $P[a_j, b_j]$  that contains  $V(B_j) \cap V(P[\text{init}(P), b])$  and is disjoint from  $V(P[a_{j'}, b_{j'}])$  for every  $j' \neq j$ .

(c)  $V(P[a_j, b_j]) \cap V(P[a_{j'}, b_{j'}]) = \emptyset$  for every distinct  $j, j' \in [\ell]$ .

Figure 6 gives an illustration for the outcome of this lemma.

*Proof.* Let  $f_{17}(t, \cdot)$  be the function defined inductively by  $f_{17}(t, 1) = 1$  and  $f_{17}(t, \ell) = 1 + (2t - 1)f_{17}(t, \ell - 1)$  for every  $\ell \geq 2$ . We proceed by induction on  $\ell$ . If  $\ell = 1$ , then take for  $B_1 = A_1$  and  $P[\text{init}(P), b] = P[a_1, b_1] = P$ .

Now suppose  $\ell > 1$ . Without loss of generality  $A_1$  is such that the first vertex along  $P$  in  $\bigcup_{i \in [f_{17}(t, \ell)]} V(A_i)$  belongs to  $A_1$ . Let  $x_1, \dots, x_r$  be the vertices in  $V(A_1) \cap V(P)$ , in this order along  $P$ . Note that  $r \leq 2t - 1$  by hypothesis. Let  $x_{r+1}$  be the last vertex of  $P$ . For every  $s \in [r]$ , let  $I_s$  be the set of indices  $j \in \{2, \dots, f_{17}(k, \ell)\}$  such that the first vertex in  $V(A_j)$  along  $P$  belongs to  $P[x_s, x_{s+1}]$ . By the pigeonhole principle, there is an integer  $s \in [r]$  such that  $|I_s| \geq \frac{f_{17}(t, \ell) - 1}{2t - 1} = f_{17}(t, \ell - 1)$ .

Hence by the induction hypothesis applied to any family  $\{A'_1, \dots, A'_{f_{17}(k, \ell - 1)}\} \subseteq \{A_j\}_{j \in I_s}$  and

$$P' = \begin{cases} P[x_s, x_{s+1}[ & \text{if } s < r, \\ P[x_s, x_{s+1}] & \text{if } s = r, \end{cases}$$

there are subgraphs  $B_2, \dots, B_{\ell'}$  in  $\{A'_i\}_{i \in [f_{17}(t, \ell - 1)]}$  and a subpath  $P[x_s, b']$  of  $P'$  such that for every  $j \in \{2, \dots, \ell'\}$ , there is a subpath  $P[a_j, b_j]$  of  $P[x_s, b']$  such that

- (a')  $V(B_j) \cap V(P[\text{init}(P), b]) \neq \emptyset$ , and
- (b')  $V(B_j) \cap V(P[\text{init}(P), b]) \subseteq V(P[a_j, b_j])$ , and
- (c')  $V(P[a_{j'}, b_{j'}]) \cap V(P[a_{j''}, b_{j''}]) = \emptyset$  for every distinct  $j', j'' \in \{2, \dots, \ell'\} \setminus \{j\}$ .

Then for  $B_1 = A_1$ ,  $P[\text{init}(P), b] = P[\text{init}(P), b']$  and  $P[a_1, b_1] = P[\text{init}(P), x_s]$ , this proves the lemma.  $\square$

The following simple lemma will be useful.

**Lemma 18.** *For every positive integer  $k$ , and for every tree  $T$  of at least  $(k - 1)(k - 2) + 2$  vertices, at least one of the following holds*

- (1)  $T$  has at least  $k$  leaves, or
- (2)  $T$  has a path on  $k$  vertices.



*Proof.* If  $k = 1$  then the result is clear. Now assume  $k \geq 2$ . Root  $T$  on an arbitrary vertex  $r$ , and suppose that  $T$  has at most  $k - 1$  leaves. Then for every leaf  $x$ , consider the path  $T[x, r[$  be the path from  $x$  to  $r$  in  $T$ , minus  $r$ . Since  $\bigcup_{x \text{ leaf}} V(T[x, r[)$  covers  $V(T - r)$ , by the pigeon hole principle, there is a leaf  $x$  such that  $|V(T[x, r[)| \geq k - 1$  and so  $|V(T[x, r])| \geq k$ .  $\square$

We now show that the condition  $|V(A_i) \cap V(P)| \leq 2t - 1$  in Lemma 17 can be removed, assuming that  $G$  has bounded treewidth.

**Lemma 19.** *There is a function  $f_{19}: \mathbb{N}^2 \rightarrow \mathbb{N}$  such that the following holds. Let  $t, \ell$  be positive integers, and let  $G$  be a graph with  $\text{tw}(G) < t$ . If  $P$  is a path in  $G$ , and if  $\{A_1, \dots, A_{f_{19}(t, \ell)}\}$  is a family of pairwise vertex-disjoint connected subgraphs of  $G$ , all intersecting  $V(P)$ , then there exists  $\ell$  subgraphs  $B_1, \dots, B_\ell$  among  $\{A_1, \dots, A_{f_{19}(t, \ell)}\}$  and a subpath of  $P$  of the form  $P[\text{init}(P), b]$  such that for every  $j \in [\ell]$ , there is a subpath  $P[a_j, b_j]$  of  $P[\text{init}(P), b]$  such that*

- (a)  $V(B_j) \cap V(P[\text{init}(P), b]) \subseteq V(P[a_j, b_j])$ , and
- (b)  $V(P[a_j, b_j]) \cap V(P[a_{j'}, b_{j'}]) = \emptyset$  for every  $j' \in [\ell] \setminus \{j\}$ .

*Proof.* Let  $f_{19}(t, \ell) = t \max\{2, f_{17}(t, \ell)\}^2$  where  $f_{17}$  is as in Lemma 17. We can assume that if  $u, v \in V(P) \cap V(A_i)$  are distinct and in this order along  $P$ , then  $P[u, v]$  intersect  $A_j$  for some  $j \neq i$ , for every  $i \in [f_{19}(t, \ell)]$ . Otherwise we just contract  $P[u, v]$  into a single vertex.

Consider now a tree decomposition  $(T, (W_x \mid x \in V(T)))$  of  $G$  of width less than  $t$ . Since  $A_1, \dots, A_{f_{19}(t, \ell)}$  are pairwise vertex-disjoint, every set of vertices intersecting all of them must have size at least  $f_{19}(t, \ell)$ . Consider now for every  $i \in [f_{19}(t, \ell)]$  the projection  $T_i$  of  $A_i$  on  $T$ . By Lemma 10, the family  $(T_i)_{i \in [f_{19}(t, \ell)]}$  contains  $N = \frac{f_{19}(t, \ell)}{t} = \max\{2, f_{17}(k, \ell)\}^2$  pairwise vertex-disjoint subtrees  $T_{i_1}, \dots, T_{i_N}$ .

Consider now the tree  $T'$  obtained from  $T$  by contracting every vertex outside  $\bigcup_{j \in [N]} V(T_{i_j})$  with one of its closest vertex in  $\bigcup_{j \in [N]} V(T_{i_j})$ , and by contracting  $T_{i_j}$  into a single node  $x_j$  for each  $j \in [N]$ . Hence  $V(T') = \{x_j \mid j \in [N]\}$ . By Lemma 18,  $T'$  has either  $\sqrt{N} = f_{17}(k, \ell)$  leaves or a path with  $\sqrt{N} = f_{17}(k, \ell)$  vertices. Let  $I$  be a subset of  $[N]$  of size  $\sqrt{N}$  such that  $x_j$  for  $j \in I$  is a leaf in  $T'$ , or such that a permutation of  $(x_j)_{j \in I}$  is a path in  $T'$ . We claim that

$$\text{for every } j \in I, \text{ the number of pairs } u, v \in V(P) \text{ in this order along } P \text{ such that } u \in V(A_{i_j}), V(P[u, v]) \cap \left( \bigcup_{j' \in I} V(A_{i_{j'}}) \right) = \emptyset, \text{ and } v \in \bigcup_{j' \in I \setminus \{j\}} V(A_{i_{j'}}), \text{ is at most } 2(t - 1). \quad (2)$$

Indeed, if  $x_j$  is a leaf, then every time  $P$  leaves  $A_{i_j}$ ,  $P$  crosses the adhesion between the root of  $T_{i_j}$  and its unique neighbor out of  $V(T_{i_j})$ , which have size at most  $t - 1$ . And if a permutation of  $(x_{j'})_{j' \in I}$  is a path in  $T'$ , then every time  $P$  leaves  $A_{i_j}$ ,  $P$  must cross one of the at most two adhesions neighboring  $T_{i_j}$  and leading to another  $T_{i_{j'}}$  for some  $j' \in I \setminus \{j\}$ . Since these adhesions have size at most  $t - 1$ , this proves (2).

Then contract repeatedly every edge of  $P$  that intersect at most one of the sets  $V(A_{i_j})$  for  $j \in I$ . Let  $G'$  be the resulting minor of  $G$ , let  $P'$  be the path in  $G'$  induced by  $P$ , and for every  $j \in I$ , let  $A'_j$  be the connected subgraph of  $G'$  inherited from  $A_{i_j}$ . Then  $|V(P') \cap A'_j| \leq 2t - 1$  for every  $j \in I$ . Hence we can apply Lemma 17 to  $G', P', \{A_{i_j} \mid j \in I\}$ . This is possible since  $|I| = \sqrt{N} = g(t, \ell)$ . We obtain subgraphs  $B'_1, \dots, B'_\ell$  of  $G'$  and a subpath  $P'[\text{init}(P'), b']$  of  $P'$  corresponding respectively to subgraphs  $B_1, \dots, B_\ell$  of  $G$  and a subpath  $P[\text{init}(P), b]$  of  $P$  as desired. This proves the lemma.  $\square$

To deduce Lemma 16, we will use the celebrated Erdős-Szekeres Theorem.

**Theorem 20** (Erdős Szekeres [ES35]). *For every integers  $r, s$ , for every permutation  $\sigma$  of  $[(r-1)(s-1)+1]$ , either there is a set  $I \subseteq [(r-1)(s-1)+1]$  of size  $r$  such that  $\sigma|_I$  is increasing, or there is a set  $D \subseteq [(r-1)(s-1)+1]$  of size  $s$  such that  $\sigma|_D$  is decreasing.*

*Proof of Lemma 16.* Let  $t = \max\{2, f_9(\max\{k, \ell\})\}$ . If  $\text{tw}(G) \geq t$ , then the  $k \times \ell$  grid is a minor of  $G$  by Theorem 9, and so  $G$  contains a  $k$ -ladder of length  $\ell$  as a minor. Now assume that  $\text{tw}(G) < t$ . For every  $i \in \{0, \dots, k\}$ , let

$$f_{i,k}(\ell) = \begin{cases} \ell^{2^{k-1}} & \text{if } i = 0, \\ f_{19}(t, f_{i-1,k}(\ell)) & \text{if } i \geq 1, \end{cases}$$

where  $f_{19}$  is as in Lemma 19, and take  $f_{16}(k, \ell) = f_{k,k}(\ell)$ .

Let  $G$  be a graph, Let  $Q_1, \dots, Q_k$  in  $G$  be  $k$  disjoint paths in  $G$ , and let  $A_1, \dots, A_{f_{16}(k,\ell)}$  be pairwise disjoint connected subgraphs in  $G$  each intersecting  $V(Q_i)$  for every  $i \in [k]$ , By applying Lemma 19 successively on the paths  $Q_1, \dots, Q_k$  and contracting the subpaths of the form  $Q_i[a_j, b_j]$ , we obtain a minor  $G'$  of  $G$ , connected subgraphs  $B'_1, \dots, B'_{\ell^{2^{k-1}}}$  of  $G'$ , and paths  $Q'_1, \dots, Q'_k$  in  $G'$  such that

$$|V(B_j) \cap V(Q'_a)| = 1$$

for every  $j \in [\ell^{2^{k-1}}]$  and  $a \in [k]$ . For every  $j \in [\ell^{2^{k-1}}]$  and  $a \in [k]$ , let  $u_{j,a}$  be the unique vertex in  $V(B_j) \cap V(Q'_a)$ . Finally, by applying Theorem 20 (Erdős-Szekeres Theorem)  $k-1$  times, there are  $\ell$  distinct indices  $j_1, \dots, j_\ell$  in  $\{1, \dots, \ell^{2^{k-1}}\}$  such that the orderings of  $(u_{j_i,a})_{i \in [k]}$  along  $Q'_a$  for  $a \in [k]$  are pairwise identical or reverse of each other. By possibly replacing  $Q'_{j_i}$  by its reverse for every  $j \in [\ell]$ , and by contracting some edges, we obtain a  $k$ -ladder of length  $\ell$  as a minor of  $G'$  with rows inherited from  $Q'_1, \dots, Q'_k$  and columns inherited from  $B_{j_1}, \dots, B_{j_\ell}$ . This proves the lemma.  $\square$

## 5 Nice pairs

In order to show that every graph  $G$  excluding all the  $k$ -ladders of length  $\ell$  as minors have bounded  $k$ -treedepth, we need to find a decomposition of  $G$  into graphs  $G_1, \dots, G_m$ , such that  $G$  is a  $(< k)$ -clique-sum of  $G_1, \dots, G_m$ . Typically,  $G_i$  is the ‘‘torso’’ of a bag in a suitable tree decomposition. The main issue with this approach is that we then need to decompose each  $G_i$ , while  $G_i$  is not necessarily a minor of  $G$  (since we possibly added some cliques). The solution we develop in this section is to force  $G_i$  to be ‘‘nice’’ in  $G$ , which roughly means that the cliques added to  $G[V(G_i)]$  to obtain  $G_i$  do not increase the connectivity between any two subsets of  $V(G_i)$ . In this section, we define this notion of ‘‘nice’’ sets, and we prove several properties on them. In the following section, we will find tree decompositions that will enable us to decompose our graph into nice sets in the final proof.

Let  $G$  be a graph. A **good pair** in  $G$  is a pair  $(U, \mathcal{B})$  where  $U$  is a non-empty subset of  $V(G)$ , and  $\mathcal{B}$  is a family of subsets of  $V(G)$  such that

- (g1)  $G = \bigcup_{B \in \mathcal{B} \cup \{U\}} G[B]$ , and
- (g2) the sets  $B \setminus U$  for  $B \in \mathcal{B}$  are pairwise disjoint.

Equivalently,  $\mathcal{B} \cup \{U\}$  is the family of the bags of a tree decomposition indexed by a star whose center bag is  $U$ . Then, we say that  $(U, \mathcal{B})$  is a **nice pair** in  $G$  if it is a good pair in  $G$  and

- (g3) for every  $B \in \mathcal{B}$ , for every  $i \geq 0$ , for every  $Z_1, Z_2 \subseteq U \cap B$  both of size  $i$ , there are  $i$  disjoint  $(Z_1, Z_2)$ -paths in  $G[B] \setminus \binom{B \cap U}{2}$ .

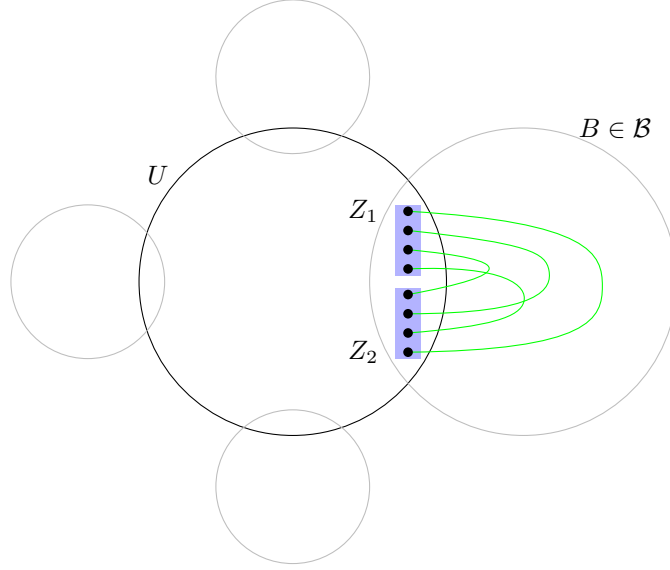

Figure 7: A good pair  $(U, \mathcal{B})$  in  $G$  is nice if for every  $B \in \mathcal{B}$ , for every  $i \geq 0$ , for every  $Z_1, Z_2 \subseteq U \cap B$  both of size  $i$ , there are  $i$  disjoint  $(Z_1, Z_2)$ -paths in  $G[B] \setminus \binom{U \cap B}{2}$ . This property implies that the maximum number of pairwise disjoint paths between two given subsets of  $U$  is the same in  $G$  and in  $\text{torso}_G(U, \mathcal{B})$ . See Lemma 24.

See Figure 7.

In practice, we will build good pairs from tree decompositions as follows. If  $(T, (W_x \mid x \in V(T)))$  is a tree decomposition of a graph  $G$ , and if  $R$  is a subtree of  $T$ , then  $(U, \mathcal{B})$  for  $U = \bigcup_{x \in V(R)} W_x$  and  $\mathcal{B} = \{\bigcup_{x \in V(S)} W_x \mid S \text{ connected component of } T - V(R)\}$  is a good pair in  $G$ . To ensure that  $(U, \mathcal{B})$  is a nice pair, we will need further assumptions on the tree decomposition. Finding such decompositions will be the goal of Section 6, but for now, we prove some properties on nice pairs.

First we give some notation. Let  $G$  be a graph and let  $(U, \mathcal{B})$  be a good pair in  $G$ . The **torso of  $U$  in  $G$  with respect to  $\mathcal{B}$** , denoted by  $\text{torso}_G(U, \mathcal{B})$ , is the graph with vertex set  $U$  and edge set  $E(G[U]) \cup \bigcup_{B \in \mathcal{B}} \binom{U \cap B}{2}$ .

**Lemma 21.** *Let  $G$  be a graph and let  $(U, \mathcal{B})$  be a nice pair in  $G$ . Then for every  $X \subseteq U$ , there exists a nice pair in  $G - X$  of the form  $(U \setminus X, \mathcal{B}')$  with  $\text{torso}_{G-X}(U \setminus X, \mathcal{B}') = \text{torso}_G(U, \mathcal{B}) - X$ .*

*Proof.* We claim that  $(U \setminus X, \{B \setminus X \mid B \in \mathcal{B}\})$  is nice in  $G - X$ . First, (g1) and (g2) of the definition of good pair clearly hold, and so  $(U \setminus X, \{B \setminus X \mid B \in \mathcal{B}\})$  is a good pair.

Consider now  $B \in \mathcal{B}$ , a positive integer  $i$ , and two sets  $Z_1, Z_2 \subseteq (U \setminus X) \cap (B \setminus X)$  both of size  $i$ . Let  $Z_0 = B \cap U \cap X$ . Since  $(U, \mathcal{B})$  is a nice pair, there are  $i + |Z_0|$  disjoint  $(Z_0 \cup Z_1, Z_0 \cup Z_2)$ -paths in  $G[B] \setminus \binom{B \cap U}{2}$ . Note that  $B \cap U = (U \setminus X) \cap (B \setminus X) \cup Z_0$ . Hence there are  $i$  disjoint  $(Z_1, Z_2)$ -paths in  $G[(U \setminus X) \cap (B \setminus X)] \setminus \binom{(U \setminus X) \cap (B \setminus X)}{2}$ . This proves that  $(U \setminus X, \{B \setminus X \mid B \in \mathcal{B}\})$  is a nice pair in  $G - X$ . Finally, by definition of torso,  $\text{torso}_G(U \setminus X, \{B \setminus X \mid B \in \mathcal{B}\}) = \text{torso}_G(U, \mathcal{B}) - X$ .  $\square$

**Lemma 22.** *Let  $G$  be a graph and let  $(U, \mathcal{B})$  be a nice pair in  $G$ . For every  $B \in \mathcal{B}$ ,  $(V(G) \setminus (B \setminus U), \{B\})$  is a nice pair in  $G$ .*

*Proof.* Clearly,  $(V(G) \setminus (B \setminus U), \{B\})$  is a good pair in  $G$ . Moreover, for every  $i \geq 0$ , for every  $Z_1, Z_2 \subseteq U \cap B$  both of size  $i$ , there are  $i$  disjoint  $(Z_1, Z_2)$ -paths in  $G[B] \setminus \binom{B \cap U}{2}$ . Hence  $(V(G) \setminus (B \setminus U), \{B\})$  is a nice pair in  $G$ .  $\square$

**Lemma 23.** *Let  $k'$  be a positive integer. Let  $G$  be a graph and let  $(U, \mathcal{B})$  be a good pair in  $G$ . For every  $Z_1, Z_2 \subseteq U$  with  $|Z_1| = |Z_2| = k'$  such that there are  $k'$  disjoint  $(Z_1, Z_2)$ -paths  $Q_1, \dots, Q_{k'}$  in  $G$ , there are  $k'$  disjoint  $(Z_1, Z_2)$ -paths  $\widehat{Q}_1, \dots, \widehat{Q}_{k'}$  in  $\text{torso}_G(U, \mathcal{B})$ . Moreover  $\bigcup_{i \in [k']} V(Q_i) \cap U = \bigcup_{i \in [k']} V(\widehat{Q}_i)$ .*

*Proof.* Let  $Z_1, Z_2 \subseteq U$  with  $|Z_1| = |Z_2| = k'$  and let  $Q'_1, \dots, Q'_{k'}$  be  $k'$  disjoint  $(Z_1, Z_2)$ -paths in  $G$ . Let  $a \in [k']$  and let  $q_{a,1}, \dots, q_{a,\ell_a}$  be the vertices in  $V(Q_a) \cap U$  in this order along  $Q_a$ . Then, for every  $i \in [\ell_a - 1]$ , either  $q_{a,i}q_{a,i+1}$  is an edge of  $G$ , or there exists  $B \in \mathcal{B}$  such that  $q_{a,i}q_{a,i+1} \in B$ . In both cases  $q_{a,i}q_{a,i+1}$  is an edge in  $\text{torso}_G(U, \mathcal{B})$ . Hence  $\widehat{Q}_a = (q_{a,1}, \dots, q_{a,\ell_a})$  is a path in  $\text{torso}_G(U, \mathcal{B})$  with  $V(\widehat{Q}_a) = V(Q_a) \cap U$ , and so  $(\widehat{Q}_1, \dots, \widehat{Q}_{k'})$  is as claimed.  $\square$

The following lemma, which is the key property of nice pairs, informally says that if  $(U, \mathcal{B})$  is nice, then the reciprocal of the previous lemma also holds.

**Lemma 24.** *Let  $k'$  be a positive integer. Let  $G$  be a graph and let  $(U, \mathcal{B})$  be a nice pair in  $G$ . For every  $Z_1, Z_2 \subseteq U$  with  $|Z_1| = |Z_2| = k'$  such that there are  $k'$  disjoint  $(Z_1, Z_2)$ -paths  $Q_1, \dots, Q_{k'}$  in  $\text{torso}_G(U, \mathcal{B})$ , there are  $k'$  disjoint  $(Z_1, Z_2)$ -paths  $Q'_1, \dots, Q'_{k'}$  in  $G$ . Moreover  $\bigcup_{i \in [k']} V(Q'_i) \cap U \subseteq \bigcup_{i \in [k']} V(Q_i)$ .*

*Proof.* We proceed by induction on  $|\mathcal{B}|$ . If  $\mathcal{B} = \emptyset$ , then  $\text{torso}_G(U, \mathcal{B}) = G$  and the result is clear. Now assume that  $\mathcal{B} \neq \emptyset$  and consider some  $B \in \mathcal{B}$ . Note that  $(U, \mathcal{B} \setminus \{B\})$  is a nice pair in  $G' = \text{torso}_G(V(G) \setminus B, \{B\})$ . Hence by the induction hypothesis applied to  $(U, \mathcal{B} \setminus \{B\})$  in  $G'$ , there are  $k'$  disjoint  $(Z_1, Z_2)$ -paths  $Q''_1, \dots, Q''_{k'}$  in  $G'$  with  $\bigcup_{i \in [k']} V(Q''_i) \cap U \subseteq \bigcup_{i \in [k']} V(Q_i)$ . Without loss of generality, assume that among  $Q''_1, \dots, Q''_{k'}$ , the paths intersecting  $U \cap B$  in at least one vertex are  $Q''_1, \dots, Q''_r$ . By taking these paths induced in  $G'$ , we can assume that  $V(Q''_i) \cap N_G(V(B)) = \{z_1^i, z_2^i\}$  for some possibly equal  $z_1^i, z_2^i \in U \cap B$ , for every  $i \in [r]$ . Moreover, we assume that if  $z_1^i \neq z_2^i$ , then  $z_1^i$  is in the connected component of the end point of  $Q''_i$  belonging to  $Z_1$  in  $Q''_i - z_1^i z_2^i$  (and so  $z_2^i$  is in the connected component of the end point of  $Q''_i$  belonging to  $Z_2$  in  $Q''_i - z_1^i z_2^i$ ). Let  $Z'_1 = \{z_1^i \mid i \in [r]\}$ ,  $Z'_2 = \{z_2^i \mid i \in [r]\}$ , and  $Z'_0 = (U \cap B) \setminus (Z'_1 \cup Z'_2)$ . By hypothesis, there are  $r + |Z'_0|$  pairwise disjoint  $(Z'_0 \cup Z'_1, Z'_0 \cup Z'_2)$ -paths  $Q'_1, \dots, Q'_r, (\{u\})_{u \in Z'_0}$  in  $G[B] \setminus \binom{B \cap U}{2}$ . Hence the union of  $Q'_1, \dots, Q'_r$  with  $Q''_1 - z_1^1 z_2^1, \dots, Q''_r - z_1^r z_2^r$ , together with  $Q''_{r+1}, \dots, Q''_{k'}$ , yields  $k'$  pairwise vertex-disjoint  $(Z_1, Z_2)$ -paths in  $G$ . Moreover  $\bigcup_{i \in [k']} V(Q'_i) \cap U \subseteq \bigcup_{i \in [k']} V(Q_i)$ . This proves the lemma.  $\square$

The following lemma informally says that a nice pair in the torso of a nice pair in  $G$ , is itself a nice pair in  $G$ .

**Lemma 25.** *Let  $G$  be a graph and let  $(U, \mathcal{B})$  be a nice pair in  $G$ . If  $(U', \mathcal{B}')$  is a nice pair in  $\text{torso}_G(U, \mathcal{B})$ , then there exists  $\mathcal{B}''$  such that  $(U', \mathcal{B}'')$  is a nice pair in  $G$ , and  $\text{torso}_G(U', \mathcal{B}'') = \text{torso}_{\text{torso}_G(U, \mathcal{B})}(U', \mathcal{B}')$ .*

*Proof.* We proceed by induction on  $|\mathcal{B}|$ . If  $\mathcal{B}$  is empty, then  $\text{torso}_G(U, \mathcal{B}) = G$  and so  $(U', \mathcal{B}')$  is a nice pair in  $G$  with  $\text{torso}_G(U', \mathcal{B}') = \text{torso}_{\text{torso}_G(U, \mathcal{B})}(U', \mathcal{B}')$ . Now suppose that  $\mathcal{B} \neq \emptyset$ .

Consider a member  $B$  of  $\mathcal{B}$ . Let  $G' = \text{torso}_G(V(G) \setminus (B \setminus U), \{B\})$ . Observe that  $(U, \mathcal{B} \setminus \{B\})$  is a nice pair in  $G'$ . Hence, by the induction hypothesis, there is a nice pair in  $G'$  of the form  $(U', \mathcal{B}''_0)$  with  $\text{torso}_{G'}(U', \mathcal{B}''_0) = \text{torso}_{\text{torso}_{G'}(U, \mathcal{B} \setminus \{B\})}(U', \mathcal{B}')$ . By definition of  $G'$ , the set  $B \cap U$  induces a clique in  $G'$ . As  $\{U'\} \cup \mathcal{B}''_0$  is the family of the bags of a tree decomposition of  $G'$ , this implies that there exists  $B''_0 \in \mathcal{B}''_0 \cup \{U'\}$  such that  $B \cap U \subseteq B''_0$ .

First suppose that  $B''_0 \neq U$ . Let

$$B''_1 = B \cup B''_0$$

and

$$\mathcal{B}'' = \mathcal{B}_0'' \setminus \{B_0''\} \cup \{B_1''\}.$$

By construction,  $\text{torso}_G(U', \mathcal{B}'') = \text{torso}_{G'}(U', \mathcal{B}_0'') = \text{torso}_{\text{torso}_G(U, \mathcal{B})}(U', \mathcal{B}')$ . It remains to show that  $(U', \mathcal{B}'')$  is a nice pair in  $G$ . Observe that (g1) holds since  $G' = \bigcup_{B' \in \mathcal{B}_0'' \cup \{U'\}} G'[B']$ . Moreover, (g2) holds since  $B$  is disjoint from  $B' \setminus U$  for all  $B' \in \mathcal{B}_0'' \setminus \{B_0''\}$ . We now prove (g3). Let  $B'' \in \mathcal{B}''$ ,  $i \geq 0$ , and  $Z_1, Z_2 \subseteq B'' \cap U'$  both of size  $i$ . By possibly replacing  $Z_a$  by  $Z_a \cup (B'' \cap U' \setminus (Z_1 \cup Z_2))$  for each  $a \in \{1, 2\}$  and increasing  $i$  accordingly, we now assume that  $Z_1 \cup Z_2 = B'' \cap U'$ . If  $B'' \neq B_1''$ , then there are  $i$  disjoint  $(Z_1 \cap B_0'', Z_2 \cap B_0'')$ -paths in  $G'[B''] \setminus \binom{B'' \cap U'}{2} = G[B''] \setminus \binom{B'' \cap U'}{2}$  since  $(U', \mathcal{B}_0'')$  is a nice pair in  $G'$ . If  $B'' = B_1''$ , then there are  $|Z_1 \cap B_0''|$  disjoint  $(Z_1, Z_2)$ -paths  $Q_1, \dots, Q_i$  in  $G'[B_1''] \setminus \binom{B_1'' \cap U'}{2}$  since  $(U', \mathcal{B}_0'')$  is a nice pair in  $G'$ . Without loss of generality, suppose that among  $Q_1, \dots, Q_i$ , the paths  $Q_1, \dots, Q_j$ , are the ones intersecting  $B$ . We can assume that these paths are induced in  $G'[B_1''] \setminus \binom{B_1'' \cap U'}{2}$ . In particular, for every  $a \in [j]$ ,  $Q_a$  intersects  $B$  in at most two vertices (because  $Z_1 \cup Z_2 = B_1'' \cap U'$ ). For every  $a \in [j]$ , let  $z_1^a, z_2^a$  be respectively the first and last vertex of  $Q_a$  in  $U \cap B$ . Since  $(U, \mathcal{B})$  is a nice pair in  $G$ , there are  $j$  disjoint  $(\{z_1^a \mid a \in [j]\}, \{z_2^a \mid a \in [j]\})$ -paths in  $G[B] \setminus \binom{U \cap B}{2}$ . Combining these paths with  $Q_1, \dots, Q_i$ , we obtain  $i$  disjoint  $(Z_1, Z_2)$ -paths in  $G[B \cup B_0''] \setminus \binom{(B \cup B_0'') \cap U'}{2}$ .

Now assume  $B_0'' = U$ . Let

$$\mathcal{B}'' = \mathcal{B}_0'' \cup \{B\}.$$

By construction of  $G'$ ,  $\text{torso}_G(U', \mathcal{B}'') = \text{torso}_{G'}(U', \mathcal{B}_0'') = \text{torso}_{\text{torso}_G(U, \mathcal{B})}(U', \mathcal{B}')$ . It remains to show that  $(U', \mathcal{B}'')$  is a nice pair in  $G$ . Observe that (g1) holds since  $G \subseteq G' \cup G[B]$  and  $G' = \bigcup_{B' \in \mathcal{B}' \cup \{U'\}} G'[B']$ . Moreover, (g2) holds since  $B$  is disjoint from all  $B'' \setminus U$  for  $B'' \in \mathcal{B}_0''$ . We now prove (g3). Let  $B'' \in \mathcal{B}''$ ,  $i \geq 0$ , and  $Z_1, Z_2 \subseteq B'' \cap U'$  both of size  $i$ . If  $B'' \neq B$ , then there are  $i$  disjoint  $(Z_1 \cap B_0'', Z_2 \cap B_0'')$ -paths in  $G'[B''] \setminus \binom{B'' \cap U'}{2} = G[B''] \setminus \binom{B'' \cap U'}{2}$  since  $(U', \mathcal{B}_0'')$  is a nice pair in  $G'$ . If  $B'' = B$ , then there are  $|Z_1 \cap B_0''|$  disjoint  $(Z_1, Z_2)$ -paths  $Q_1, \dots, Q_i$  in  $G[B] \setminus \binom{B \cap U'}{2}$  since  $(U, \mathcal{B})$  is a nice pair in  $G$ . Hence (g3) holds. This concludes the proof of the lemma.  $\square$

## 6 Finding a suitable tree decomposition

In this section, we prove the existence of “well connected” tree decompositions, that will be used to decompose a graph into nice pairs in the final proof of Theorem 1. This is inspired by the seminal result of Thomas [Tho90], which asserts that every graph  $G$  admits a tree decomposition  $(T, (W_x \mid x \in V(T)))$  of width  $\text{tw}(G)$  which is *lean*, that is such that for every  $x_1, x_2 \in V(T)$ , for every  $Z_1 \subseteq W_{x_1}$  and  $Z_2 \subseteq W_{x_2}$  of same size  $i$ , either there are  $i$  disjoint  $(Z_1, Z_2)$ -paths in  $G$ , or there exists  $z_1 z_2 \in E(T[x_1, x_2])$  such that  $|W_{z_1} \cap W_{z_2}| < i$ . Hence the connectivity between two bags is witnessed by the smallest adhesion between them. Here we prove analogous results for tree decompositions of  $(G, S)$ , with some additional properties. The techniques we use are strongly inspired by the short proof of Thomas’ theorem by Bellenbaum and Diestel [BD02].

First we start by defining a potential function on a tree decomposition. Let  $k$  be a positive integer, let  $G$  be a graph, and let  $S \subseteq V(G)$ . Let  $\mathcal{D} = (T, (W_x \mid x \in V(T)))$  be a tree decomposition of  $(G, S)$ . For every positive integer  $i$ , let  $s_i(\mathcal{D}) = |\{x \in V(T) \mid |W_x| = i\}|$ , that is the number of bags of size  $i$  in  $\mathcal{D}$ , and let

$$s_i^{(k)}(\mathcal{D}) = \begin{cases} |\{x \in V(T) \mid |W_x| = i\}| & \text{if } i > \frac{3}{2}(k-1), \\ |\{x \in V(T) \mid |W_x| = i \text{ and } \exists y \in N_T(x), |W_x \cap W_y| \geq k\}| & \text{if } i \leq \frac{3}{2}(k-1). \end{cases}$$

Then, let

$$s(\mathcal{D}) = (s_{|V(G)|}(\mathcal{D}), \dots, s_0(\mathcal{D}))$$

and

$$s^{(k)}(\mathcal{D}) = (s_{|V(G)|}^{(k)}(\mathcal{D}), \dots, s_0^{(k)}(\mathcal{D})).$$

We will consider these tuples in the lexicographic order. The following lemma shows how to improve  $\mathcal{D}$  by reducing  $s(\mathcal{D})$  or  $s^{(k)}(\mathcal{D})$  if some connectivity property is not satisfied. Its proof follows step by step Bellenbaum and Diestel's argument [BD02].

**Lemma 26.** *Let  $a$  be a positive integer. Let  $G$  be a graph and let  $S$  be a nonempty subset of  $V(G)$ . Let  $\mathcal{D} = (T, (W_x \mid x \in V(T)))$  be a tree decomposition of  $(G, S)$  of adhesion at most  $a$ . If there exists a positive integer  $i$ , two vertices  $x_1, x_2 \in V(T)$ , and two sets  $Z_1 \subseteq W_{x_1}, Z_2 \subseteq W_{x_2}$  with  $|Z_1| = |Z_2| = i$  such that there are no  $i$  disjoint  $(Z_1, Z_2)$ -paths in  $G$ , but  $|W_z \cap W_{z'}| \geq i$  for every  $zz' \in E(T[x_1, x_2])$ , then there exist  $S' \subseteq V(G)$  with  $S \subseteq S'$  and a tree decomposition  $\mathcal{D}' = (T', (W'_z \mid z \in V(T'))) of  $(G, S')$  of adhesion at most  $\max\{a, i - 1\}$  such that  $s(\mathcal{D}')$  is smaller than  $s(\mathcal{D})$  for the lexicographic order. More precisely, there exist  $z \in V(T[x_1, x_2])$  and  $j_0 \in \{|W_z|, \dots, |V(G)|\}$  such that$*

- (a)  $s_j(\mathcal{D}') \leq s_j(\mathcal{D})$  for every  $j \in \{j_0, \dots, |V(G)|\}$ ;
- (b)  $s_{j_0}(\mathcal{D}') < s_{j_0}(\mathcal{D})$ ; and
- (c) if  $x_1 = x_2$ , then there are adjacent vertices  $z_1, z_2$  in  $T'$  such that  $Z_1 \subseteq W'_{z_1}, Z_2 \subseteq W'_{z_2}$ , and  $W'_{z_1} \cap W'_{z_2}$  is a minimum  $(Z_1, Z_2)$ -cut in  $G$ . In particular  $|W'_{z_1} \cap W'_{z_2}| < i$ .

Moreover, for every positive integer  $k$ , if  $|W_z| > \frac{3}{2}(k - 1)$  or  $\exists z' \in N_T(z), |W_z \cap W_{z'}| \geq k$ , then there exists  $j_1 \in \{|W_z|, \dots, |V(G)|\}$  such that

- (d)  $s_j^{(k)}(\mathcal{D}') \leq s_j^{(k)}(\mathcal{D})$  for every  $j \in \{j_1, \dots, |V(G)|\}$ ; and
- (e)  $s_{j_1}^{(k)}(\mathcal{D}') < s_{j_1}^{(k)}(\mathcal{D})$ .

*Proof.* Let  $x_1, x_2 \in V(T)$  and let  $Z_1 \subseteq W_{x_1}, Z_2 \subseteq W_{x_2}$  with  $|Z_1| = |Z_2| = i$  such that there are no  $i$  disjoint  $(Z_1, Z_2)$ -paths in  $G$  but  $|W_z \cap W_{z'}| \geq i$  for every  $zz' \in E(T[x_1, x_2])$ . Let  $(x'_1, x'_2)$  be such a pair of vertices in  $V(T[x_1, x_2])$  with  $\text{dist}_T(x'_1, x'_2)$  minimum. For simplicity, assume that  $x'_1 = x_1$  and  $x'_2 = x_2$ . For every  $u \in V(G)$ , let  $z_u \in V(T)$  be such that  $u \in W_{z_u}$  if  $u \in S$ , and otherwise such that  $W_{z_u}$  contains the neighborhood of the connected component of  $u$  in  $G - S$ . In both cases, pick such a  $z_u$  with  $\text{dist}_T(z_u, V(T[x_1, x_2]))$  minimum. Since there are no  $i$  disjoint  $(Z_1, Z_2)$ -paths in  $G$ , by Menger's Theorem, there exists a set  $X \subseteq V(G)$  of size at most  $i - 1$  such that every  $(Z_1, Z_2)$ -path in  $G$  intersects  $X$ . Take such a set  $X$  of minimum size, and if equality, take the one minimizing  $\sum_{u \in X} d_u$ , where

$$d_u = \begin{cases} \text{dist}_T(z_u, V(T[x_1, x_2])) & \text{if } u \in S, \\ \text{dist}_T(z_u, V(T[x_1, x_2])) + 1 & \text{otherwise,} \end{cases}$$

for every  $u \in X$ .

Let  $C_1$  be the union of all the connected components of  $G - X$  that intersect  $Z_1$ , and let  $C_2 = G - (X \cup V(C_1))$ . Let  $G_1 = G[V(C_1) \cup X]$  and  $G_2 = G[V(C_2) \cup X]$ . By Menger's Theorem, there is a family  $(P_u \mid u \in X)$  of pairwise disjoint  $(Z_1, Z_2)$ -paths in  $G$  such that  $u \in V(P_u)$  for

every  $u \in X$ . For every  $u \in X$ ,  $P_u$  is the union of two paths  $P_u^1 \subseteq G - V(C_1)$  and  $P_u^2 \subseteq G - V(C_2)$  meeting in exactly one vertex, namely  $u$ . For each  $a \in \{1, 2\}$ , let  $T^a$  be a copy of  $T$  with vertex set  $\{z^a \mid z \in V(T)\}$  and edge set  $\{z_1^a z_2^a \mid z_1 z_2 \in E(T)\}$ , and let  $\mathcal{D}_a = (T^a, (W_{z^a}^a \mid z^a \in V(T^a)))$  be the tree decomposition of  $(G_a, (S \cap V(G_a)) \cup X)$  defined by

$$W_{z^a}^a = (W_z \cap V(G_a)) \cup \{u \in X \mid z \in V(T[z_u, x_{3-a}])\}$$

for every  $z \in V(T)$ .

Finally, let  $S' = S \cup X$ ,  $T' = T^1 \cup T^2 \cup \{x_1^2 x_2^1\}$ , and let  $W'_{z^a} = W_{z^a}^a$  for every  $z \in V(T)$  and for every  $a \in \{1, 2\}$ . We claim that  $\mathcal{D}' = (T', (W'_z \mid z \in V(T')))$  satisfies the outcome of the lemma. First, observe that  $\mathcal{D}'$  is a tree decomposition of  $(G, S')$ . Then, we claim that following property holds.

$$\text{For all } z \in V(T) \text{ and } a \in \{1, 2\}, |W_{z^a}^a| \leq |W_z|. \quad (3)$$

To see this, observe that for every  $u \in W_{z^a}^a \setminus W_z$ , we have  $u \in X$  and  $W_z \cap V(P_u) \neq \emptyset$ . By mapping  $u$  to a vertex in  $W_z \cap V(P_u)$ , we obtain an injection from  $W_{z^a}^a \setminus W_z$  to  $W_z \setminus W_{z^a}^a$ . This shows that  $|W_{z^a}^a \setminus W_z| \leq |W_z \setminus W_{z^a}^a|$  and so  $|W_{z^a}^a| = |W_{z^a}^a \setminus W_z| + |W_{z^a}^a \cap W_z| \leq |W_z \setminus W_{z^a}^a| + |W_{z^a}^a \cap W_z| = |W_z|$ .

The same argument also proves the following.

$$\text{For all } z_1 z_2 \in E(T) \text{ and } a \in \{1, 2\}, |W_{z_1^a}^a \cap W_{z_2^a}^a| \leq |W_{z_1} \cap W_{z_2}|. \quad (4)$$

In particular,  $\mathcal{D}'$  has adhesion at most  $\max\{a, i-1\}$ . We now investigate the equality case in (3).

$$\text{For all } z \in V(T) \text{ and } a \in \{1, 2\}, \text{ if } |W_{z^a}^a| = |W_z|, \text{ then } W_{z^{3-a}}^{3-a} \subseteq X. \quad (5)$$

Suppose for a contradiction that  $|W_{z^a}^a| = |W_z|$  and  $W_{z^{3-a}}^{3-a} \not\subseteq X$  for some  $z \in V(T)$  and  $a \in \{1, 2\}$ . Then  $W_z$  intersects  $V(C_{3-a})$ , and every  $z \in W_z \cap V(C_{3-a})$  corresponds to a vertex  $v \in X$  such that  $z \in V(T[z_v, x_{3-a}])$ . Let  $Y = W_{z^a}^a \setminus W_z$  be the set of all these vertices. Then let

$$X' = (X \setminus Y) \cup (W_z \cap V(C_{3-a})).$$

Note that  $|X'| = |X| < i$ . We claim that  $X'$  intersects every  $(Z_a \cup W_z, Z_{3-a})$ -path in  $G$ . Let  $Q$  be a  $(Z_a \cup W_z, Z_{3-a})$ -path in  $G$ . Suppose for a contradiction that  $V(Q) \cap X' = \emptyset$ . Since  $V(Q) \cap (X \cup (W_z \cap V(C_{3-a}))) \neq \emptyset$ , we have  $V(Q) \cap X \neq \emptyset$ , and so  $V(Q) \cap Y \neq \emptyset$ . Let  $u_0$  be the last vertex of  $Y \cap V(Q)$  along  $Q$ . Then the subpath  $Q[u_0, \text{term}(Q)]$  of  $Q$  is included in  $C_{3-a}$ , and  $Q[u_0, \text{term}(Q)]$  is a  $(W_{z_{u_0}}, W_{x_{3-a}})$ -path. Since  $z \in V(T[z_{u_0}, x_{3-a}])$ ,  $Q[u_0, \text{term}(Q)]$  intersects  $W_z$ . As  $u_0 \notin W_z$ ,  $Q$  intersects  $W_z$  in  $V(C_{3-a})$ , and so  $V(Q) \cap X' \neq \emptyset$ . This proves that  $X'$  intersects every  $(Z_a \cup W_z, Z_{3-a})$ -path in  $G$ .

If  $z \in V(T[x_a, x_{3-a}])$ , then take any  $Z \subseteq W_z$  of size  $i$ . Then  $X'$  intersects every  $(Z, Z_{3-a})$ -path in  $G$ , and so there are no  $i$  disjoint  $(Z, Z_{3-a})$ -paths in  $G$ . Therefore, the pair  $(z, x_{3-a})$  contradicts the minimality of  $\text{dist}_T(x_1, x_2)$ . Now suppose  $z \notin V(T[x_a, x_{3-a}])$ . We claim that  $d_{u'} < d_u$  for every  $u' \in X' \setminus X$  and for every  $u \in X \setminus X' = Y$ . Indeed,  $z \in V(T[z_u, x_{3-a}])$  by definition of  $W_{z^a}^a$ , and as  $z \notin V(T[x_a, x_{3-a}])$ ,  $z$  lies on the path from  $z_u$  to  $x_{3-a}$  in  $T$ . For both cases  $u \in S$  and  $u \notin S$ , this implies that  $d_u > \text{dist}_T(z, V(T[x_1, x_2]))$ . On the other hand, since  $u' \in W_z$  and  $z_{u'}$  is such that  $u' \in W_{z_{u'}}$  and  $\text{dist}_T(z_{u'}, V(T[x_1, x_2]))$  is minimum, we have  $d_{u'} \leq \text{dist}(z, V(T[x_1, x_2]))$ . It follows that  $d_u > \text{dist}_T(z, V(T[x_1, x_2])) \geq d_{u'}$  as claimed. Since  $X' \setminus X$  and  $X \setminus X'$  are nonempty, this contradicts the minimality of  $\sum_{u \in X} d_u$ . This proves (5).

We now prove the following property.

$$\text{There exists } z \in V(T[x_1, x_2]) \text{ such that } |W_{z_1}^1|, |W_{z_2}^2| < |W_z|. \quad (6)$$

By (5), it is enough to find  $z \in V(T[x_1, x_2])$  such that  $W_z$  intersects both  $V(C_1)$  and  $V(C_2)$ . Suppose for a contradiction that for every  $z \in V(T[x_1, x_2])$ ,  $W_z \setminus X \subseteq V(C_1)$  or  $W_z \setminus X \subseteq V(C_2)$ .

Then there is an edge  $zz'$  in  $T[x_1, x_2]$  such that  $W_z \setminus X \subseteq V(C_1)$  and  $W_{z'} \setminus X \subseteq V(C_2)$ . It follows that  $W_z \cap W_{z'} \subseteq X$  and so  $|W_z \cap W_{z'}| < i$ , a contradiction. This proves (6).

To conclude, fix  $z$  as in (6). Let  $j_0 \in \{|W_z|, \dots, |V(G)|\}$  be maximum such that there exists  $z' \in V(T)$  satisfying  $|W_{z'}| = j_0$  and  $|W_{z'_1}^1|, |W_{z'_2}^2| < |W_{z'}|$ . Then, since  $|W_z| \geq |X| + 1$ , (3) and (5) imply that  $s_j(\mathcal{D}') \leq s_j(\mathcal{D})$  for every  $j \in \{j_0, \dots, |V(G)|\}$ , and  $s_{j_0}(\mathcal{D}') \leq s_{j_0}(\mathcal{D})$ . This proves (a) and (b). Finally, if  $x_1 = x_2$ , then (c) follows from the definition of  $\mathcal{D}'$  for  $z_1 = x_1^2$  and  $z_2 = x_1^2$ . This proves the first part of the lemma.

We now prove the ‘‘moreover’’ part. Suppose that  $|W_z| > \frac{3}{2}(k-1)$  or  $\exists z' \in N_T(z), |W_z \cap W_{z'}| \geq k$ . Then let  $j_1 \in \{|W_z|, \dots, |V(G)|\}$  be maximum such that there exists  $z'' \in V(T)$  satisfying  $|W_{z''}| = j_1$ ,  $|W_{z''_1}^1|, |W_{z''_2}^2| < |W_{z''}|$ , and  $|W_{z''}| > \frac{3}{2}(k-1)$  or  $\exists z' \in N_T(z''), |W_{z''} \cap W_{z'}| \geq k$ . Just as before, (3), (4) and (5) imply that  $s_j^{(k)}(\mathcal{D}') \leq s_j^{(k)}(\mathcal{D})$  for every  $j \in \{j_1, \dots, |V(G)|\}$ , and  $s_{j_1}^{(k)}(\mathcal{D}') < s_{j_1}^{(k)}(\mathcal{D})$ . This proves (d) and (e).  $\square$

As a first application of this lemma, we show the following version of a result of Cygan, Komosa, Lokshtanov, Pilipczuk, Pilipczuk, Saurabh, and Wahlström [CKL<sup>+</sup>20].

**Theorem 27.** *Let  $k$  be a positive integer and let  $G$  be a graph. There is a tree decomposition  $(T, (W_x \mid x \in V(T)))$  of  $G$  of adhesion at most  $k-1$  such that*

- (a) *for every integer  $i$  with  $1 \leq i \leq k$ , for every  $x \in V(T)$ , for every  $Z_1, Z_2 \subseteq W_x$  with  $|Z_1| = |Z_2| = i$ , there are  $i$  pairwise disjoint  $(Z_1, Z_2)$ -paths in  $G$ ; and*
- (b) *if  $G$  is connected, then for every edge  $x_1x_2 \in E(T)$ ,  $\bigcup_{z \in V(T_{x_2|x_1})} W_z$  induces a connected subgraph of  $G$ .*

*Proof.* Let  $\mathcal{D} = (T, (W_x \mid x \in V(T)))$  be a tree decomposition of  $G$  of adhesion less than  $k$ . Note that such a tree decomposition always exists since the tree decomposition of  $G$  with a single bag  $V(G)$  has adhesion less than  $k$ . We take such a tree decomposition  $\mathcal{D}$  such that  $s(\mathcal{D})$  is minimum for the lexicographic order.

First we show (a). Suppose for a contradiction that there exists  $i$  with  $1 \leq i \leq k$ ,  $x \in V(T)$ , and  $Z_1, Z_2 \subseteq W_x$  with  $|Z_1| = |Z_2| = i$ , such that there are no  $i$  pairwise disjoint  $(Z_1, Z_2)$ -paths in  $G$ . Then by Lemma 26 applied for  $S = V(G)$ , there exists  $\mathcal{D}'$  a tree decomposition of  $G$  of adhesion at most  $\max\{k-1, i-1\} = k-1$  such that  $s(\mathcal{D}')$  is smaller than  $s(\mathcal{D})$  for the lexicographic order. This contradicts the minimality of  $s(\mathcal{D})$  and so (a) holds.

Now suppose that (b) does not hold. Then  $G$  is connected and there is an edge  $x_1x_2 \in E(T)$  such that  $G' = G \left[ \bigcup_{z \in V(T_{x_2|x_1})} W_z \right]$  is not connected. Let  $C_1$  be a connected component of  $G'$  and let  $C_2 = G' - V(C_1)$ . For each  $a \in \{1, 2\}$ , let  $T^a$  be a copy of  $T_{x_2|x_1}$  with vertex set  $\{z^a \mid z \in V(T_{x_2|x_1})\}$  and edge set  $\{z_1^a z_2^a \mid z_1 z_2 \in E(T_{x_2|x_1})\}$ . Then, for every  $z \in V(T_{x_2|x_1})$ , let  $W'_{z^a} = W_z \cap V(C_a)$ , and for every  $z \in V(T_{x_1|x_2})$ , let  $W'_z = W_z$ . Finally, for  $T' = T_{x_1|x_2} \cup T^1 \cup T^2 \cup \{x_1x_2^1, x_1x_2^2\}$ ,  $\mathcal{D}' = (T', (W'_z \mid z \in V(T')))$  is a tree decomposition of  $G$  of adhesion at most  $k-1$ . We now prove that  $s(\mathcal{D}')$  is smaller than  $s(\mathcal{D})$ , which contradicts the minimality of  $s(\mathcal{D})$  and so proves the theorem. To do so, consider  $z_0 \in V(T_{x_2|x_1})$  be such that  $W_{z_0}$  intersects both  $V(C_1)$  and  $V(C_2)$ , and  $|W_{z_0}|$  is maximum under this property. This is well-defined because  $W_{x_2}$  intersects both  $V(C_1)$  and  $V(C_2)$  since  $G$  is connected. Now, for every  $z \in V(T_{x_2|x_1})$ , if  $|W_z| > |W_{z_0}|$ , then by maximality of  $|W_{z_0}|$ , one of  $W'_{z_1}$  and  $W'_{z_2}$  is empty, and the other one is  $W_z$ . Moreover, if  $|W_z| = |W_{z_0}|$ , then either one of  $W'_{z_1}$  and  $W'_{z_2}$  is empty, and the other one is  $W_z$ ; or  $W_z$  intersects both  $V(C_1)$  and  $V(C_2)$ , and it follows that  $|W'_{z_1}|, |W'_{z_2}| < |W_z| = |W_{z_0}|$ . This second case occurs at least once for  $z = z_0$ . Altogether, this implies that  $s_j(\mathcal{D}') \leq s_j(\mathcal{D})$  for every  $j \in \{|W_{z_0}| + 1, \dots, |V(G)|\}$ , and  $s_{|W_{z_0}|}(\mathcal{D}') < s_{|W_{z_0}|}(\mathcal{D})$ . Therefore,  $s(\mathcal{D}')$  is smaller than  $s(\mathcal{D})$  for the lexicographic order. This contradicts the minimality of  $s(\mathcal{D})$  and so (b) holds.  $\square$



We can now show the main result of this section.

**Lemma 28.** *Let  $k, a, t$  be positive integers with  $a \geq k$ . Let  $G$  be a graph and let  $S \subseteq V(G)$ . If there exists a tree decomposition of  $(G, S)$  of width less than  $t$  and adhesion at most  $a$ , then there exists  $S' \subseteq V(G)$  with  $S \subseteq S'$  and  $\mathcal{D} = (T, (W_x \mid x \in V(T)))$  a tree decomposition of  $(G, S')$  such that*

- (a)  $\mathcal{D}$  has adhesion at most  $a$ ;
- (b)  $\mathcal{D}$  has width less than  $\max\{t, \frac{3}{2}(k-1)\}$ ;
- (c) for every  $x_1, x_2 \in V(T)$ , for every  $Z_1 \subseteq W_{x_1}$  and  $Z_2 \subseteq W_{x_2}$  both of size  $k$ , either
  - (i) there are  $k$  disjoint  $(Z_1, Z_2)$ -paths in  $G$ ,
  - (ii) there exists  $z_1, z_2 \in E(T[x_1, x_2])$  with  $|W_{z_1} \cap W_{z_2}| < k$ , or
  - (iii)  $x_1 = x_2$ ,  $|W_{x_1}| \leq \frac{3}{2}(k-1)$ , and  $|W_{x_1} \cap W_y| < k$  for every  $y \in N_T(x_1)$ ;
- (d) for every  $x_1 x_2 \in E(T)$  with  $|W_{x_1} \cap W_{x_2}| < k$ , if there exists  $x_3 \in N_T(x_2)$  such that  $|W_{x_2} \cap W_{x_3}| \geq k$ , then for every positive integer  $i$ , for every  $Z_1, Z_2 \subseteq W_{x_1} \cap W_{x_2}$  both of size  $i$ , there are  $i$  disjoint  $(Z_1, Z_2)$ -paths in

$$G \left[ \bigcup_{z \in V(T_{x_2|x_1})} W_z \cup \bigcup_{C \in \mathcal{C}(x_2|x_1)} V(C) \right] \setminus \binom{W_{x_1} \cap W_{x_2}}{2}$$

where  $\mathcal{C}(x_2 \mid x_1)$  is the family of all the components  $C$  of  $G - S'$  such that  $N_G(V(C)) \subseteq \bigcup_{z \in V(T_{x_2|x_1})} W_z$  and  $N_G(V(C)) \not\subseteq W_{x_1} \cap W_{x_2}$ .

See Figure 8 for an illustration of (d).

*Proof.* Let  $S' \subseteq V(G)$  containing  $S$  and  $\mathcal{D}' = (T, (W_x \mid x \in V(T)))$  be a tree decomposition of  $(G, S')$  of adhesion at most  $a$  and width less than  $\max\{t, \frac{3}{2}(k-1)\}$ . Consider such a pair  $(S', \mathcal{D}')$  such that  $s^{(k)}(\mathcal{D}') = (s_{|V(G)|}^{(k)}(\mathcal{D}'), \dots, s_0^{(k)}(\mathcal{D}'))$  is minimum for the lexicographic order. We claim that  $\mathcal{D}'$  satisfies (a)-(d). By definition, (a) and (b) hold.

Now suppose that (c) does not hold: there exist  $x_1, x_2 \in V(T)$ ,  $Z_1 \subseteq W_{x_1}$  and  $Z_2 \subseteq W_{x_2}$  both of size  $k$ , such that

- (i) there are no  $k$  disjoint  $(Z_1, Z_2)$ -paths in  $G$ ;
- (ii) for every  $z_1, z_2 \in E(T[x_1, x_2])$ ,  $|W_{z_1} \cap W_{z_2}| \geq k$ ; and
- (iii)  $x_1 \neq x_2$ , or  $|W_{x_1}| > \frac{3}{2}(k-1)$ , or there exists  $y \in N_T(x_1)$  such that  $|W_{x_1} \cap W_y| \geq k$ .

Then by Lemma 26, there exists a set  $S'' \subseteq V(G)$  containing  $S'$  (and so  $S$ ) and a tree decomposition  $\mathcal{D}''$  of  $(G, S'')$  of adhesion at most  $\max\{a, k-1\} = a$  such that 26.(a)-26.(e) hold. If  $x_1 \neq x_2$ , then, since  $z \in V(T[x_1, x_2])$ , this implies that  $z$  has a neighbor  $z'$  with  $|W_{z'} \cap W_z| \geq k$ . Hence, by 26.(d) and 26.(e),  $s^{(k)}(\mathcal{D}'')$  is smaller than  $s^{(k)}(\mathcal{D}')$  for the lexicographic order, a contradiction. Now suppose  $x_1 = x_2$ . If  $|W_{x_1}| > \frac{3}{2}(k-1)$ , then again by 26.(d) and 26.(e),  $s^{(k)}(\mathcal{D}'')$  is smaller than  $s^{(k)}(\mathcal{D}')$  for the lexicographic order, a contradiction. Now suppose  $|W_{x_1}| \leq \frac{3}{2}(k-1)$ . This implies that there exists  $y \in N_T(x_1)$  such that  $|W_{x_1} \cap W_y| \geq k$ . Then again by 26.(d) and 26.(e),  $s^{(k)}(\mathcal{D}'')$  is smaller than  $s^{(k)}(\mathcal{D}')$  for the lexicographic order, a contradiction. This proves that (c) holds.

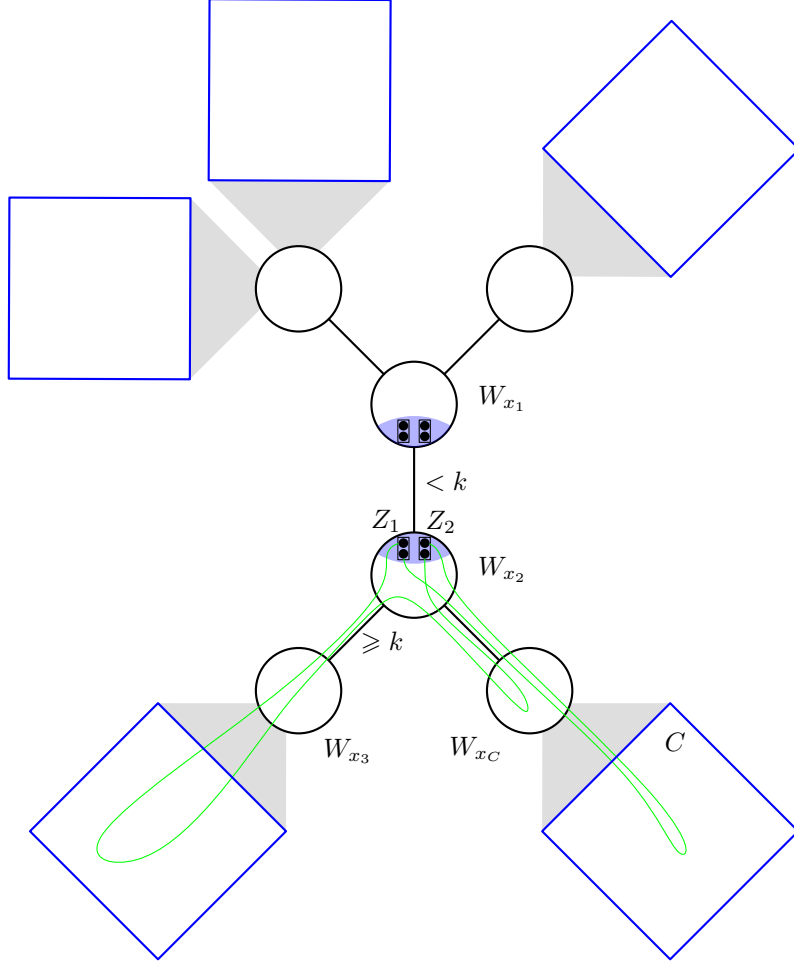

Figure 8: Illustration for Item (d) in Lemma 28.

Now suppose that (d) does not hold. Hence there exist  $x_1 x_2 \in E(T)$  with  $|W_{x_1} \cap W_{x_2}| < k$ ,  $x_3 \in N_T(x_2)$  with  $|W_{x_2} \cap W_{x_3}| \geq k$ , a positive integer  $i$ , and two sets  $Z_1, Z_2 \subseteq W_{x_1} \cap W_{x_2}$  both of size  $i$ , such that there are no  $i$  disjoint  $(Z_1, Z_2)$ -paths in  $G_0 = G \left[ \bigcup_{z \in V(T_{x_2|x_1})} (W_z \cup \bigcup_{C \in \mathcal{C}, N_G(V(C)) \subseteq W_z, N_G(V(C)) \not\subseteq W_{x_1} \cap W_{x_2}} V(C)) \right] \setminus (W_{x_1} \cap W_{x_2})$ . By possibly replacing  $Z_a$  by  $Z_a \cup ((W_{x_1} \cap W_{x_2}) \setminus (Z_1 \cup Z_2))$  for every  $a \in \{1, 2\}$ , and  $i$  by  $i + |((W_{x_1} \cap W_{x_2}) \setminus (Z_1 \cup Z_2))|$ , we assume that  $Z_1 \cup Z_2 = W_{x_1} \cap W_{x_2}$ .

We call Lemma 26 on  $G_0$ ,  $S_0 = V(G_0) \cap S'$ , the tree decomposition  $\mathcal{D}_0 = (T_{x_2|x_1}, (W_z \mid x \in V(T_{x_2|x_1})))$ ,  $x_2, x_2, Z_1, Z_2$ . We deduce that there exists  $S'_0 \subseteq V(G_0)$  with  $S_0 \subseteq S'_0$  and a tree decomposition  $\mathcal{D}'_0 = (T_0, (W'_z \mid z \in V(T'_0)))$  of  $(G_0, S'_0)$  of adhesion at most  $\max\{a, i - 1\}$  such that

26.(c) there are adjacent vertices  $z_1, z_2$  in  $T'_0$  such that  $Z_1 \subseteq W'_{z_1}$ ,  $Z_2 \subseteq W'_{z_2}$ , and  $W'_{z_1} \cap W'_{z_2}$  is a minimum  $(Z_1, Z_2)$ -cut in  $G$ . In particular  $|W'_{z_1} \cap W'_{z_2}| < i$ .

Moreover, there exists  $j_1 \in \{|W_{x_2}|, \dots, |V(G)|\}$  such that

26.(d)  $s_j^{(k)}(\mathcal{D}'_0) \leq s_j^{(k)}(\mathcal{D}_0)$  for every  $j \in \{j_1, \dots, |V(G)|\}$ ; and

26.(e)  $s_{j_1}^{(k)}(\mathcal{D}'_0) < s_{j_1}^{(k)}(\mathcal{D}_0)$ .

Now let  $T_1$  be obtained from  $T_0$  by subdividing once the edge  $z_1, z_2$ . Let  $z_0$  be the resulting new vertex. Then let  $W'_{z_0} = Z_1 \cup Z_2 \cup (W'_{z_1} \cap W'_{z_2})$ . Since  $W'_{z_1} \cap W'_{z_2}$  is a minimum  $(Z_1, Z_2)$ -cut, we have

$$|(W'_{z_1} \cap W'_{z_2}) \setminus (Z_1 \cap Z_2)| \leq \min\{|Z_1 \setminus Z_2|, |Z_2 \setminus Z_1|\} \leq \frac{k-1}{2}.$$

This implies that  $|W'_{z_0}| \leq \frac{3}{2}(k-1)$ . Moreover,

$$\begin{aligned} |W'_{z_0} \cap W'_{z_a}| &= |(W'_{z_1} \cap W'_{z_2}) \cup Z_a| \\ &\leq |(W'_{z_1} \cap W'_{z_2}) \setminus (Z_1 \cap Z_2)| + |Z_a| \\ &\leq |Z_{3-a} \setminus Z_a| + |Z_a| \\ &= |Z_1 \cup Z_2| < k \end{aligned}$$

for every  $a \in \{1, 2\}$ . Then let  $S'' = (S' \setminus V(G_0)) \cup S'_0$ , and let  $\mathcal{D}'' = (T'', (W''_z \mid z \in V(T''))) where  $V(T'') = V(T_{x_1|x_2}) \cup V(T_1)$ ,  $E(T'') = E(T_{x_1|x_2}) \cup E(T_1) \cup \{x_1 z_0\}$ ,  $W''_z = W_z$  for every  $z \in V(T_{x_1|x_2})$ , and  $W''_z = W'_z$  for every  $z \in V(T_1)$ . See Figure 9. Then  $\mathcal{D}''$  is a tree decomposition of  $(G, S'')$  of adhesion at most  $\max\{a, i-1\}$  and width less than  $\max\{t, \frac{3}{2}(k-1)\}$ . Moreover, since every neighbor  $z$  of  $z_0$  is such that  $|W''_{z_0} \cap W''_z| < k$ , the bag  $W''_{z_0}$  will not be counted in  $s^{(k)}(\mathcal{D}'')$ , and it follows that  $s_j^{(k)}(\mathcal{D}'') \leq s_j^{(k)}(\mathcal{D}')$  for every  $j \in \{j_1, \dots, |V(G)|\}$  and  $s_{j_1}^{(k)}(\mathcal{D}'') < s_{j_1}^{(k)}(\mathcal{D}')$ . Therefore,  $s^{(k)}(\mathcal{D}'')$  is smaller than  $s^{(k)}(\mathcal{D}')$  for the lexicographic order, a contradiction. This proves that (d) holds.  $\square$$

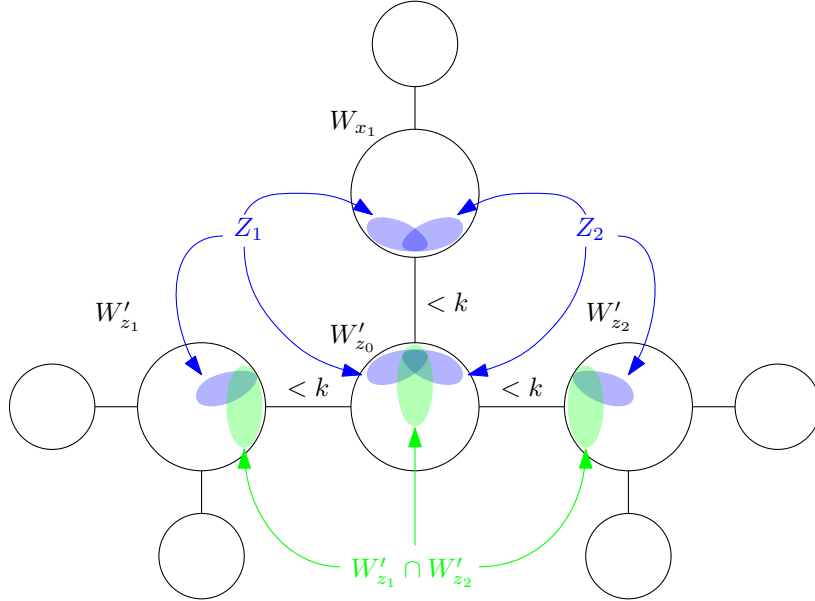

Figure 9: Construction of  $\mathcal{D}''$  in the proof of Lemma 28.

## 7 Graphs excluding all $k$ -ladders of length $\ell$ have bounded $k$ -treedepth

In this section, we prove the “if” part of Theorem 1, that is the fact that graphs excluding all  $k$ -ladders of length  $\ell$  as minors have bounded  $k$ -treedepth. To do so, we will prove the following statement by induction.

**Theorem 29.** *There is a function  $f_{29}: \mathbb{N}^4 \rightarrow \mathbb{N}$  such that the following holds. Let  $k, \ell, a, t$  be positive integers. For every graph  $G$  that does not contain any  $k$ -ladder of length  $\ell$  as a minor, for every nice pair  $(U, \mathcal{B})$  in  $G$ , if  $S \subseteq U$  is such that there is a tree decomposition of  $(\text{torso}_G(U, \mathcal{B}), S)$  of adhesion at most  $a$  and width less than  $t$ , then there exists  $S'$  with  $S \subseteq S' \subseteq U$  such that*

$$\text{td}_k(\text{torso}_G(U, \mathcal{B}), S') \leq f_{29}(k, \ell, t, a).$$

To deduce Theorem 1, observe that Proposition 14 implies that every minor-closed class of graphs of bounded  $k$ -treedepth excludes  $T \square P_\ell$  for every tree  $T$  on  $k$  vertices, for some integer  $\ell$ . For the other direction, if  $\mathcal{C}$  is a minor-closed class of graphs that does not contain  $T \square P_\ell$  for every tree  $T$  on  $k$  vertices, then Observation 15 implies that no graph in  $\mathcal{C}$  contains a  $k$ -ladder of length  $k^{k-2}(\ell - 1) + 1$  as a minor, and Theorem 9 implies that every graph in  $G$  has treewidth less than  $f_9(\max\{k, \ell\})$ . Hence Theorem 29 applied for  $U = S = V(G)$  and  $\mathcal{B} = \emptyset$  implies that a graph in such a class has  $k$ -treedepth at most  $f_{29}(k, k^{k-2}(\ell - 1) + 1, f_9(\max\{k, \ell\}), f_9(\max\{k, \ell\}))$ .

Before showing Theorem 29, we give some notation and prove a key lemma. Let  $G$  be a graph, let  $X \subseteq V(G)$  and let  $u \in V(G)$ . The **projection** of  $u$  on  $X$  is the set

$$\Pi_G(X, u) = \begin{cases} \{u\} & \text{if } u \in X \\ N_G(V(C)) & \text{if } u \notin X \text{ and } C \text{ is the connected component of } u \text{ in } G - X. \end{cases}$$

Moreover, for every  $A \subseteq V(G)$ , let  $\Pi_G(X, A) = \bigcup_{u \in A} \Pi_G(X, u)$ . Observe that for every connected subgraph  $H$  of  $G - \Pi_G(X, A)$  intersecting  $X$ ,  $V(H)$  is disjoint from  $A$ .

The following lemma is inspired by Huynh, Joret, Micek, Seweryn, Wollan's proof for the case  $k = 2$  [HJM<sup>+</sup>21].

**Lemma 30.** *There is a function  $f_{30}: \mathbb{N}^3 \rightarrow \mathbb{N}$  such that the following holds. Let  $k, \ell, c$  be positive integers. Let  $G$  be a connected graph that does not contain any  $k$ -ladder of length  $\ell$  as a minor, let  $(U, \mathcal{B})$  be a nice pair in  $G$ , and let  $R \subseteq U$  with  $|R| \leq c$ . There is a set  $Z \subseteq U$  with  $R \subseteq Z$  such that*

- (a) *for every connected component  $C$  of  $\text{torso}_G(U, \mathcal{B}) - Z$ ,  $R$  is connected in  $\text{torso}_G(U, \mathcal{B}) - V(C)$ ; and*
- (b)  $\text{td}_k(\text{torso}_G(U, \mathcal{B}), Z) \leq f_{30}(k, \ell, c)$ .

*Proof.* Let

$$f_{30}(k, \ell, c) = c + (c - 1) \cdot \max \left\{ 2(k - 1) + (2k - 1)(k - 1), \right. \\ \left. 2(k - 1) + t \cdot (f_{16}(k, \ell) \cdot f_9(\max\{k, \ell\}) + 2k) \right\}.$$

Let  $G$  be a connected graph that does not contain any  $k$ -ladder of length  $\ell$ , let  $(U, \mathcal{B})$  be a nice pair in  $G$ , and let  $R \subseteq U$  with  $|R| \leq c$ . Fix an ordering  $r_1, \dots, r_{|R|}$  of  $R$ . Note that since  $G$  is connected,  $\text{torso}_G(U, \mathcal{B})$  is connected by Lemma 24. By Theorem 27 applied to  $\text{torso}_G(U, \mathcal{B})$ , there is a tree decomposition  $(T, (W_x \mid x \in V(T)))$  of  $\text{torso}_G(U, \mathcal{B})$  of adhesion at most  $k - 1$  such that

- 27.(a) for every integer  $i$  with  $1 \leq i \leq k$ , for every  $x \in V(T)$ , for every  $Z_1, Z_2 \subseteq W_x$  with  $|Z_1| = |Z_2| = i$ , there are  $i$  pairwise disjoint  $(Z_1, Z_2)$ -paths in  $\text{torso}_G(U, \mathcal{B})$ ; and
- 27.(b) for every edge  $x_1x_2 \in E(T)$ , the set  $\bigcup_{z \in V(T_{x_1|x_2})} W_z$  induces a connected subgraph of  $\text{torso}_G(U, \mathcal{B})$ .

Fix some  $i \in [|R| - 1]$ . We will build a set  $Z_i \subseteq V(G)$  containing  $r_i$  and  $r_{i+1}$  such that

- (a1) for every connected component  $C$  of  $G - Z_i$ ,  $r_i$  and  $r_{i+1}$  are connected in  $\text{torso}_G(U, \mathcal{B}) - V(C)$ ; and
- (a2)  $\text{td}_k(\text{torso}_G(U, \mathcal{B}), Z_i) \leq \max\{2(k-1) + (2k-1)(k-1), 2(k-1) + t \cdot (f_{16}(k, \ell) \cdot f_9(\max\{k, \ell\}) + 2k)\}$ .

Let  $x_1, x_2 \in V(T)$  be such that  $r_i \in W_{x_1}$  and  $r_{i+1} \in W_{x_2}$ . Consider some  $y \in V(T[x_1, x_2])$ . We will build a set  $Z_{i,y} \subseteq W_y$  such that

- (b1) for every connected component  $C$  of  $\text{torso}_G(U, \mathcal{B}) - Z_{i,y}$  intersecting  $W_y$ ,  $r_i$  and  $r_{i+1}$  are connected in  $\text{torso}_G(U, \mathcal{B}) - V(C)$ ;
- (b2)  $|Z_{i,y}| \leq \max\{2(k-1) + (2k-1)(k-1), 2(k-1) + t \cdot (f_{16}(k, \ell) \cdot f_9(\max\{k, \ell\}) + 2k)\}$ ; and
- (b3)  $Z_{i,y}$  contains the adhesions of  $y$  with its neighbors in  $T[x_1, x_2]$ , that is  $W_y \cap W_{y'} \subseteq Z_{i,y}$  for every  $y' \in N_{T[x_1, x_2]}(y)$ .

Let  $A_1$  be the adhesion of  $W_y$  with its predecessor in  $T[x_1, x_2]$  if  $y \neq x_1$ , and let  $A_1 = \{r_i\}$  if  $y = x_1$ . Similarly, let  $A_2$  be the adhesion of  $W_y$  with its successor in  $T[x_1, x_2]$  if  $y \neq x_2$ , and let  $A_2 = \{r_{i+1}\}$  if  $y = x_2$ . Let  $Q$  be a path from  $A_1$  to  $A_2$  in  $\text{torso}_G(U, \mathcal{B})$ . Such a path exists by 27.(a).

If  $|V(Q) \cap W_y| < 2k$ , then let

$$Z_{i,y} = A_1 \cup A_2 \cup \Pi_{\text{torso}_G(U, \mathcal{B})}(W_y, V(Q)).$$

Note that  $|Z_{i,y}| \leq 2(k-1) + (2k-1)(k-1)$ , and for every connected component  $C$  of  $\text{torso}_G(U, \mathcal{B}) - Z_{i,y}$  intersecting  $W_y$ ,  $V(C)$  is disjoint from  $V(Q)$ . Hence (b1), (b2), and (b3) hold by construction.

Now suppose that  $|V(Q) \cap W_y| \geq 2k$ . Let  $B_1$  be the vertex set of the shortest prefix of  $Q$  containing  $k$  vertices of  $W_y$ , and let  $B_2$  be the vertex set of the shortest suffix of  $Q$  containing  $k$  vertices in  $W_y$ . By 27.(a), there are  $k$  pairwise vertex-disjoint  $(B_1 \cap W_y, B_2 \cap W_y)$ -paths in  $\text{torso}_G(U, \mathcal{B})$ . By Lemma 24, there are  $k$  pairwise vertex-disjoint  $(B_1, B_2)$ -paths  $Q_1, \dots, Q_k$  in  $G$ . Let  $\mathcal{F}$  be the family of all the connected subgraphs  $H$  of  $G$  such that  $V(H) \cap Q_j \neq \emptyset$  for every  $j \in [k]$ . By Lemma 16, there are no  $f_{16}(k, \ell)$  pairwise vertex-disjoint members of  $\mathcal{F}$ . Hence by Lemma 10 and Theorem 9, there is a set  $Z_{i,y}^0 \subseteq V(G)$  of size at most  $f_{16}(k, \ell) \cdot f_9(\max\{k, \ell\})$  that intersects every member of  $\mathcal{F}$ . Then let

$$Z_{i,y} = A_1 \cup A_2 \cup \Pi_G(W_y, Z_{i,y}^0 \cup B_1 \cup B_2).$$

See Figure 10.

Note that (b3) holds by construction, and  $Z_{i,y} \subseteq W_y$ . Moreover, for every vertex  $u$  of  $G$ ,  $|\Pi_G(W_y, u)| \leq t$  since  $t \geq 1$  and for every connected component  $C$  of  $G - U$ ,  $N_G(V(C))$  induces a clique in  $\text{torso}_G(U, \mathcal{B})$ , and so has size at most  $t$ . It follows that

$$|Z_{i,y}| \leq 2(k-1) + t \cdot (f_{16}(k, \ell) \cdot f_9(\max\{k, \ell\}) + 2k),$$

which proves (b2). Consider now a connected component  $C$  of  $\text{torso}_G(U, \mathcal{B}) - Z_{i,y}$  intersecting  $W_y$ . Let  $C'$  be the connected component of  $G - Z_{i,y}$  containing  $V(C)$ . Then  $V(C')$  is disjoint from  $Z_{i,y}^0 \cup B_1 \cup B_2$ . In particular,  $C' \notin \mathcal{F}$  and so  $V(C')$  is disjoint from  $Q_j$  for some  $j \in [k]$ . Fix such a  $j \in [k]$ . By Lemma 23, there exists a path  $\widehat{Q}_j$  from  $\text{init}(Q_j)$  to  $\text{term}(Q_j)$  in  $\text{torso}_G(U, \mathcal{B})$  with vertex set  $V(Q_j) \cap U$ . Hence  $\widehat{Q}_j$  is a path from  $B_1$  to  $B_2$  in  $\text{torso}_G(U, \mathcal{B}) - V(C)$ . Extending it using  $G[B_1]$  and  $Q[B_2]$ , we obtain a path from  $A_1$  to  $A_2$  in  $\text{torso}_G(U, \mathcal{B}) - V(C)$ . If  $y = x_1$ , then

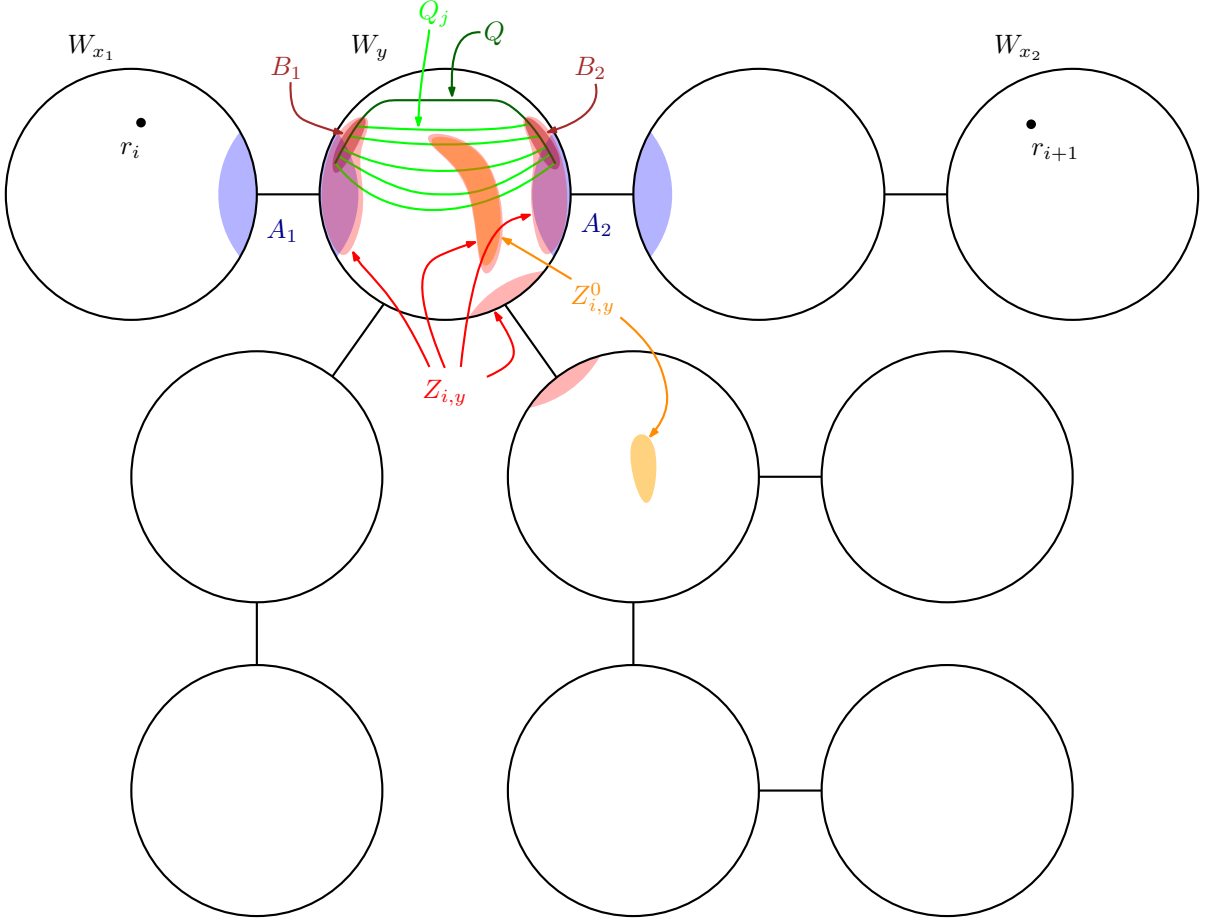

Figure 10: Illustration for the proof of Lemma 30. For sake of clarity, we assume here that  $U = V(G)$ , and  $Q$ ,  $B_1$ , and  $B_2$  are drawn inside  $W_y$ , but in general this is not the case, and so  $Z_{i,y}$  contains only the projection of  $B_1 \cup B_2$  on  $W_y$ .

recall that  $A_1 = \{r_i\}$ . If  $y \neq x_1$ , let  $y'$  the predecessor of  $y$  along  $T[x_1, x_2]$ . Then  $\bigcup_{z \in V(T_{y'/y})} W_z$  induces a connected subgraph of  $\text{torso}_G(U, \mathcal{B})$ , and this subgraph is disjoint from  $V(C)$  and contains  $r_i$ . In both cases, there is path from  $r_i$  to every vertex in  $A_1$  in  $\text{torso}_G(U, \mathcal{B}) - V(C)$ . Similarly, there is a path between  $r_{i+1}$  and every vertex in  $A_2$  in  $\text{torso}_G(U, \mathcal{B}) - V(C)$ . We deduce that there is a path from  $r_i$  to  $r_{i+1}$  in  $\text{torso}_G(U, \mathcal{B}) - V(C)$ . This proves (b1).

Now let

$$Z_i = \bigcup_{y \in V(T[x_1, x_2])} Z_{i,y}.$$

By (b3),  $(T[x_1, x_2], (Z_{i,y} \mid y \in V(T[x_1, x_2])))$  is a tree decomposition (and even a path decomposition) of  $(\text{torso}_G(U, \mathcal{B}) - R, Z_i)$  of adhesion at most  $k - 1$  and of width less than  $\max \{2(k - 1) + (2k - 1)(k - 1), 2(k - 1) + (k - 1) \cdot (f_{16}(k, \ell) \cdot f_9(\max\{k, \ell\}) + 2k - 1)\}$ . Hence

$$\text{td}_k(\text{torso}_G(U, \mathcal{B}) - R, Z_i) \leq \max \left\{ 2(k - 1) + (2k - 1)(k - 1), \right. \\ \left. 2(k - 1) + t \cdot (f_{16}(k, \ell) \cdot f_9(\max\{k, \ell\}) + 2k - 1) \right\},$$

and so (a1) holds. Moreover, for every connected component  $C$  of  $\text{torso}_G(U, \mathcal{B}) - R - Z_i$ , if  $V(C)$  intersects  $W_y$  for some  $y \in V(T[x_1, x_2])$ , then by (b1), there is a path from  $r_i$  to  $r_{i+1}$

in  $\text{torso}_G(U, \mathcal{B}) - V(C)$ . Otherwise, there is an edge  $yy' \in E(T)$  with  $y \in V(T[x_1, x_2])$  and  $y' \notin V(T[x_1, x_2])$  such that  $V(C) \subseteq \bigcup_{z \in V(T_{y'|y})} W_z \setminus W_y$ . Then, since  $\bigcup_{z \in V(T_{y'|y})} W_z$  induces a connected subgraph of  $\text{torso}_G(U, \mathcal{B})$  which contains  $r_i$  and  $r_{i+1}$  and is disjoint from  $V(C)$ , there is a path from  $r_i$  to  $r_{i+1}$  in  $\text{torso}_G(U, \mathcal{B}) - V(C)$ . Therefore, (a1) holds.

Finally, let

$$Z = R \cup \bigcup_{i \in [|R| - 1]} Z_i.$$

Then for every connected component  $C$  of  $\text{torso}_G(U, \mathcal{B}) - Z$  for every  $i \in [|R| - 1]$ ,  $C$  is disjoint from  $Z_i$  and so by (a1), there is a path from  $r_i$  to  $r_{i+1}$  in  $\text{torso}_G(U, \mathcal{B}) - V(C)$ . Therefore,  $R$  is connected in  $\text{torso}_G(U, \mathcal{B}) - V(C)$ , which proves (a). Moreover, by Lemma 13,

$$\begin{aligned} \text{td}_k(\text{torso}_G(U, \mathcal{B}), Z) &\leq |R| + (|R| - 1) \cdot \max \{2(k - 1) + (2k - 1)(k - 1), \\ &\quad t \cdot f_{16}(k, \ell) \cdot f_9(\max\{k, \ell\}) + 2k\} \\ &\leq f_{30}(k, \ell, c), \end{aligned}$$

and so (b) holds. This proves the lemma.  $\square$

We can now give the proof of Theorem 29.

*Proof of Theorem 29.* Let  $k, \ell$  be fixed positive integers. We proceed by induction on  $a$ . If  $a \leq k - 1$ , then  $(\text{torso}_G(U, \mathcal{B}), S)$  has a tree decomposition of width less than  $t$  and adhesion at most  $k - 1$ , and so  $\text{td}_k(\text{torso}_G(U, \mathcal{B}), S) \leq t \leq f_{29}(k, \ell, t, a)$  for  $f_{29}(k, \ell, t, a) = t$ . Now suppose  $a \geq k$ , and that the result holds for  $a - 1$ .

First, we prove the following claim.

**Claim 30.1.** *There is a function  $f_{30.1}: \mathbb{N}^4 \rightarrow \mathbb{N}$  such that the following holds. Let  $\ell', c, c'$  be positive integers. Let  $G$  be a graph that does not contain any  $k$ -ladder of length  $\ell$  as a minor. Let  $(U, \mathcal{B})$  be a nice pair in  $G$ . Let  $S \subseteq U$  be such that there is a tree decomposition of  $(\text{torso}_G(U, \mathcal{B}), S)$  of adhesion at most  $a$  and width less than  $t$ . Let  $(V_0, \dots, V_{\ell'})$  be a path partition of  $\text{torso}_G(U, \mathcal{B})$  such that*

- (a)  $N_{\text{torso}_G(U, \mathcal{B})}(V_i) \cap V_{i-1}$  is connected in  $\text{torso}_G(U, \mathcal{B})[(N_{\text{torso}_G(U, \mathcal{B})}(V_i) \cap V_{i-1}) \cup V_i]$ , for every  $i \in [\ell' - 1]$ ;
- (b)  $|N_{\text{torso}_G(U, \mathcal{B})}(V_{\ell'})| \leq c$ ; and
- (c) for every  $W \subseteq V_{\ell'}$ , either
  - (i) there are  $k$  disjoint  $(V_0, W)$ -paths in  $\text{torso}_G(U, \mathcal{B})$ , or
  - (ii)  $\text{td}_k(\text{torso}_G(U, \mathcal{B})[W], S \cap W) \leq c'$ .

Then there exists  $S' \subseteq V_{\ell'}$  with  $S \cap V_{\ell'} \subseteq S'$  such that

$$\text{td}_k(\text{torso}_G(U, \mathcal{B})[V_{\ell'}], S') \leq f_{30.1}(t, \ell', c, c').$$

Before proving it, we motivate the statement of this claim. Its proof will consist in a downward induction on  $\ell'$ . The path partition  $(V_0, \dots, V_{\ell'})$  will ensure that the induction will eventually stop: if this path partition is long enough, and if we have  $k$  disjoint paths from  $V_0$  to  $V_{\ell'}$ , then we will find a long  $k$ -ladder by Lemma 16, since each part is morally connected by (a). The problem with this approach is that there are graphs, even with large  $k$ -treedepth, that have no path partition with more than 3 parts. This is for example the case when there is a universal

vertex. But in this specific case, removing the universal vertex will decrease the treewidth by one. In general, we will use the fact mentioned in Section 1 that for every graph  $G$ , for every  $u \in V(G)$ , there exists  $S \subseteq V(G) \setminus \{u\}$  containing  $N_G(u)$  with  $\text{tw}(G - u, S) < \text{tw}(G)$ . Hence, by induction, we can decompose a superset of  $N_G(u)$  in  $G - u$ , which will enable us to construct a path partition. This is why we are working in the setting of decomposition “focused” on a subset  $S$  of vertices.

*Proof of the claim.* Let  $L = f_{16}(k, \ell)$ , where  $f_{16}$  is the function from Lemma 16. If  $\ell' \geq 2L$  then let

$$f_{30.1}(t, \ell', c, c') = c'.$$

Otherwise, if  $\ell' < 2L$ , let

$$\begin{aligned} f_{30.1}(t, \ell', c, c') &= f_{30}(k, \ell, c) \\ &\quad + c \cdot (t + 1) \\ &\quad + c \cdot f_{29}(k, \ell, t - 1, a - 1) + \\ &\quad + f_{30.1}(t, \ell' + 1, \\ &\quad \quad f_{30}(k, \ell, c) + c \cdot (t + 1) + f_{29}(k, \ell, t - 1, a - 1), c'). \end{aligned}$$

We proceed by induction on  $(2L - \ell', |V_{\ell'}|)$ , in the lexicographic order. Let  $\mathcal{D}_0 = (T_0, (W_x^0 \mid x \in V(T_0)))$  be a tree decomposition of  $(\text{torso}_G(U, \mathcal{B}), S)$  of adhesion at most  $a$  and width less than  $t$ . If  $\ell' \geq 2L$ , then, by (c), either

- (i) there are  $k$  disjoint  $(V_0, V_{2L})$ -paths in  $\text{torso}_G(U, \mathcal{B})$ , or
- (ii)  $\text{td}_k(\text{torso}_G(U, \mathcal{B})[V_{2L}], S \cap V_{2L}) \leq c'$ .

In the second case we are done. Now assume that there are  $k$  disjoint  $(V_0, V_{2L})$ -paths in  $\text{torso}_G(U, \mathcal{B})$ . By Lemma 24, there are  $k$  disjoint  $(V_0, V_{2L})$ -paths  $Q_1, \dots, Q_k$  in  $G$ . Moreover, since  $(V_0, \dots, V_{2L})$  is a path partition of  $\text{torso}_G(U, \mathcal{B})$ , every  $(V_0, V_{2L})$ -path in  $G$  intersects  $N_{\text{torso}_G(U, \mathcal{B})}(V_i) \cap V_{i-1}$  for every  $i \in [2L]$ . For every  $i \in [2L]$ ,  $N_{\text{torso}_G(U, \mathcal{B})}(V_i) \cap V_{i-1}$  is connected in  $\text{torso}_G(U, \mathcal{B})[(N_{\text{torso}_G(U, \mathcal{B})}(V_i) \cap V_{i-1}) \cup V_i]$  by (a). Let  $C_i$  be the vertex set of the connected component of  $\text{torso}_G(U, \mathcal{B})[(N_G(V_i) \cap V_{i-1}) \cup V_i]$  containing  $N_G(V_i) \cap V_{i-1}$ . Let  $\mathcal{C}_i$  be the family of all the members  $B$  of  $\mathcal{B}$  with  $B \cap V(C_i) \neq \emptyset$ . Note that  $\bigcup C_i$  and  $\bigcup C_j$  are disjoint for every  $i, j \in [2L]$  with  $|i - j| \geq 2$ , because  $B \cap U$  induces a clique in  $\text{torso}_G(U, \mathcal{B})$ , for every  $B \in \mathcal{B}$ . Moreover,  $N_{\text{torso}_G(U, \mathcal{B})}(V_i) \cap V_{i-1}$  is connected in  $G[C_i \cup \bigcup \mathcal{C}_i]$ . Let  $C'_i$  be the connected component of  $G[C_i \cup \bigcup \mathcal{C}_i]$  containing  $N_G(V_i) \cap V_{i-1}$ . Then  $C'_1, C'_3, \dots, C'_{2L-1}$  is a family of  $L$  pairwise disjoint connected subgraphs of  $G$ , each of them intersecting  $V(Q_j)$  for every  $j \in [k]$ . By Lemma 24, Lemma 16, and the definition of  $L$ , this implies that  $G$  contains a  $k$ -ladder of length  $\ell$  as a minor, a contradiction.

Now suppose  $\ell' < 2L$ . If  $\text{torso}_G(U, \mathcal{B})[V_{\ell'}]$  is not connected, then let  $\mathcal{C}$  be the family of all the connected components of  $G[V_{\ell'}]$ . For every  $C \in \mathcal{C}$ , we call induction on the path partition  $(V_0, \dots, V_{\ell'-2}, V_{\ell'-1} \cup (V_{\ell'} \setminus V(C)), V(C))$ . We deduce that there exists  $S'_C \subseteq V(C)$  containing  $S \cap V(C)$  such that  $\text{td}_k(C, S'_C) \leq f_{30.1}(t, \ell', c, c')$ . Then for  $S' = \bigcup_{C \in \mathcal{C}} S'_C$ , we have  $\text{td}_k(\text{torso}_G(U, \mathcal{B})[V_{\ell'}], S') \leq f_{30.1}(t, \ell', c, c')$ . Now assume that  $\text{torso}_G(U, \mathcal{B})[V_{\ell'}]$  is connected.

A general picture of the following proof is provided in Figure 11. Let  $X = V_1 \cup \dots \cup V_{\ell'-2} \cup (V_{\ell'-1} \setminus N_{\text{torso}_G(U, \mathcal{B})}(V_{\ell'}))$ , and let  $U' = U \setminus X$ . Note that  $U' = N_{\text{torso}_G(U, \mathcal{B})}(V_{\ell'}) \cup V_{\ell'}$ . By Lemma 21, there exists a nice pair  $(U', \mathcal{B}')$  in  $G - X$  with

$$\text{torso}_{G-X}(U', \mathcal{B}') = \text{torso}_G(U, \mathcal{B}) - X = \text{torso}_G(U, \mathcal{B})[N_{\text{torso}_G(U, \mathcal{B})}(V_{\ell'}) \cup V_{\ell'}].$$



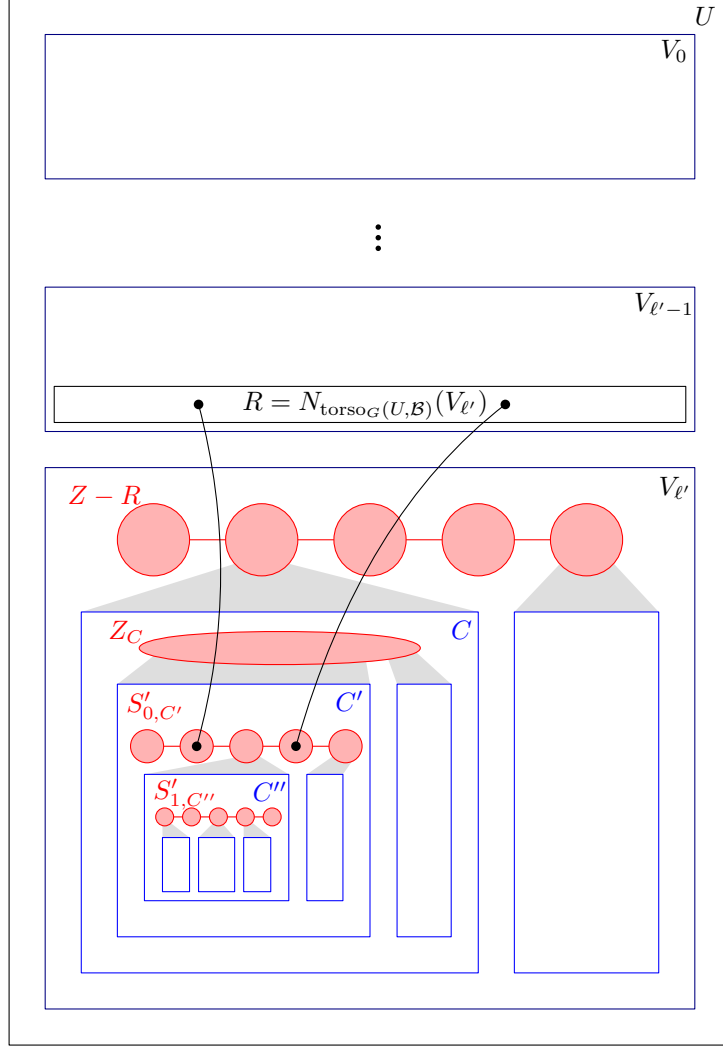

Figure 11: Illustration for the proof of Claim 30.1. First we remove the set  $Z$  given by Lemma 30 to ensure that  $R$  is connected in  $\text{torso}_{G'}(U', \mathcal{B}') - V(C)$  for every connected component  $C$  of  $\text{torso}_{G'}(U', \mathcal{B}') - Z$ . Fix a connected component  $C$  of  $\text{torso}_{G'}(U', \mathcal{B}')$ . Then, we remove  $Z_C$  to ensure that connected components of  $C - Z_C$  are either disjoint from  $S$  (and so we are done), or have their neighborhood included in  $S$ . Fix a connected component  $C'$  of  $C - Z_C$  which intersects  $S$ . We want to call induction on  $\ell'$  by considering the partition  $(V_0, \dots, V_{\ell-1}, V_{\ell'} \setminus V(C'), V(C'))$ . However, this might be not a path partition, since  $V(C')$  can have neighbors in  $R$ . Hence we need to decompose  $N_{\text{torso}_{G'}(U', \mathcal{B}')} (u) \cap V(C')$  for every  $u \in R$ . This is done by calling induction on  $a$ , the adhesion of the given tree decomposition of  $(\text{torso}_G(U, \mathcal{B}), S)$ . Now that the neighborhood of  $R$  is covered by a set  $S'_{0, C'}$ , we can indeed call induction on  $\ell'$ , which yields  $S'_{1, C''}$  for each component  $C''$  of  $C' - S'_{0, C'}$  intersecting  $S$ . Then, combining the  $k$ -dismantable tree decompositions obtained at each step, we deduce the claim.

Moreover,  $U'$  induces a connected subgraph of  $\text{torso}_G(U, \mathcal{B})$  disjoint from  $X$ , and so by Lemma 24,  $U'$  is connected in  $G - X$ . Let  $G'$  be the connected component of  $G - X$  containing  $U'$ . By possibly replacing every member  $B$  of  $\mathcal{B}'$  by  $B \cap V(G')$ , we can assume that  $\bigcup \mathcal{B}' \subseteq V(G')$ . Then,  $(U', \mathcal{B}')$  is a nice pair in  $G'$ . By Lemma 30 applied to  $R = N_{\text{torso}_G(U, \mathcal{B})}(V_{\ell'})$ , there is a set  $Z \subseteq U'$  containing  $R$  such that

30.(a) for every connected component  $C$  of  $\text{torso}_{G'}(U', \mathcal{B}') - Z$ ,  $R$  is connected in  $\text{torso}_{G'}(U', \mathcal{B}') - V(C)$ ; and

30.(b)  $\text{td}_k(\text{torso}_{G'}(U', \mathcal{B}'), Z) \leq f_{30}(k, \ell, c)$ .

Let  $\mathcal{D}_Z = (T_Z, (W_x^Z \mid x \in V(T_Z)))$  be a  $k$ -dismantable tree decomposition of  $(\text{torso}_{G'}(U', \mathcal{B}'), Z)$  of width less than  $f_{30}(k, \ell, c)$ .

Recall that  $\text{torso}_{G'}(U', \mathcal{B}') - Z = \text{torso}_G(U, \mathcal{B}) - (X \cup Z)$ . Fix a connected component  $C$  of  $\text{torso}_G(U, \mathcal{B}) - (X \cup Z)$ . For every  $u \in (N_{\text{torso}_G(U, \mathcal{B})}(V(C)) \cap R) \setminus S$ , let  $C_u$  be the connected component of  $u$  in  $\text{torso}_G(U, \mathcal{B}) - S$ . Since  $\mathcal{D}_0$  is a tree decomposition of  $(\text{torso}_G(U, \mathcal{B}), S)$ , there exists  $x_u \in V(T_0)$  such that  $N_{\text{torso}_G(U, \mathcal{B})}(V(C_u)) \subseteq W_{x_u}^0$ . Now let

$$Z_C = \bigcup_{u \in (N_{\text{torso}_G(U, \mathcal{B})}(V(C)) \cap R) \setminus S} (W_{x_u}^0 \cap V(C)).$$

Note that  $Z_C \subseteq V(C) \cap S$  and  $|Z_C| \leq c \cdot (t + 1)$ . Now, for every connected component  $C'$  of  $C - Z_C$ , either  $V(C') \cap S = \emptyset$ , or  $N_{\text{torso}_G(U, \mathcal{B})}(V(C')) \cap R \subseteq S$ . Let  $\mathcal{C}_C$  be the family of all the connected components of  $C - Z_C$  intersecting  $S$ . Fix  $C' \in \mathcal{C}_C$ , and consider some vertex  $u \in N_{\text{torso}_G(U, \mathcal{B})}(V(C')) \cap R$ . Recall that  $u \in S$ . Let  $T_{0,u}$  be the subtree of  $T_0$  induced by  $\{x \in V(T_0) \mid u \in W_x^0\}$ , and let  $S_u = \bigcup_{x \in V(T_{0,u})} W_x^0 \cap V(C')$ . Then  $(T_{0,u}, (W_x^0 \cap V(C') \mid x \in V(T_{0,u})))$  is a tree decomposition of  $(C', S_u)$  of width less than  $t - 1$  and adhesion at most  $a - 1$  since  $u \in W_x^0 \setminus V(C')$  for every  $x \in V(T_{0,u})$ . Moreover, by Lemma 21, since  $V(C') = U \setminus (U \setminus V(C'))$ , there is a nice pair in  $G - (U \setminus V(C'))$  of the form  $(V(C'), \mathcal{B}_{C'})$  such that  $C' = \text{torso}_G(U, \mathcal{B}) - (U \setminus V(C')) = \text{torso}_G(V(C'), \mathcal{B}_{C'})$ . Hence, by the induction hypothesis applied to  $G - (U \setminus V(C'))$ ,  $V(C'), \mathcal{B}_{C'}, S_u$ , there exists  $S'_u \subseteq V(C')$  with  $S_u \subseteq S'_u$  such that

$$\text{td}_k(C', S'_u) \leq \text{td}_k(\text{torso}_{G - (U \setminus V(C'))}(V(C'), \mathcal{B}_{C'}), S'_u) \leq f_{29}(k, \ell, t - 1, a - 1).$$

Let

$$S'_{0,C'} = \bigcup_{u \in N_{\text{torso}_G(U, \mathcal{B})}(V(C')) \cap R} S'_u.$$

Then, by Lemma 13,

$$\text{td}_k(C', S'_{0,C'}) \leq c \cdot f_{29}(k, \ell, t - 1, a - 1).$$

Consider now a connected component  $C''$  of  $C' - S'_{0,C'}$  with  $V(C'') \cap S \neq \emptyset$ . Since  $C''$  is disjoint from  $\bigcup_{u \in N_{\text{torso}_{G'}(U', \mathcal{B}')} (V(C')) \cap R} S_u$ , this implies that there is no edge between  $R$  and  $V(C'')$  in  $\text{torso}_G(U, \mathcal{B})$ . Moreover,

$$|N_{\text{torso}_G(U, \mathcal{B})}(V(C''))| \leq c \cdot f_{30}(k, \ell, c) + c \cdot (t + 1) + f_{29}(k, \ell, t - 1, a - 1).$$

Then  $(V_0, \dots, V_{\ell-1}, V_{\ell} \setminus V(C''), V(C''))$  is a path partition of  $\text{torso}_G(U, \mathcal{B})$ . By the properties of  $Z$ ,  $R = N_{\text{torso}_G(U, \mathcal{B})}(V_{\ell'})$  is connected in  $\text{torso}_{G'}(U', \mathcal{B}') - V(C'') = \text{torso}_G(U, \mathcal{B}) - X - V(C'') = \text{torso}_G(U, \mathcal{B}) [N_{\text{torso}_G(U, \mathcal{B})}(V_{\ell'}) \cup (V_{\ell'} \setminus V(C''))]$ . Hence  $(V_0, \dots, V_{\ell-1}, V_{\ell'} \setminus V(C''), V(C''))$  satisfies the hypothesis of the claim for the parameters  $(k, \ell, t, a, \ell' + 1, f_{30}(k, \ell, c) + c \cdot (t + 1) + f_{29}(k, \ell, t - 1, a - 1))$ .

$1, a - 1), c')$ . Hence, by induction on  $\ell'$ , there exists  $S'_{1,C''} \subseteq V(C'')$  with  $S \cap V(C'') \subseteq S'_{1,C''}$  such that

$$\text{td}_k(C'', S'_{1,C''}) \leq f_{30.1}(t, \ell' + 1, f_{30}(k, \ell, c) + c \cdot (t + 1) + f_{29}(k, \ell, t - 1, a - 1), c').$$

Now, let

$$S'_{C'} = S'_{0,C'} \cup \bigcup_{\substack{C'' \text{ connected components of } C' - S'_{0,C'} \\ V(C'') \cap S \neq \emptyset}} S'_{1,C''}.$$

Then, by Lemma 13,

$$\begin{aligned} \text{td}_k(C', S'_{C'}) &\leq \text{td}_k(C', S'_{0,C'}) + \max_{\substack{C'' \text{ connected components of } C' - S'_{0,C'} \\ V(C'') \cap S \neq \emptyset}} \text{td}_k(C'', S'_{1,C''}) \\ &\leq c \cdot f_{29}(k, \ell, t - 1, a - 1) + \\ &\quad + f_{30.1}(t, \ell' + 1, \\ &\quad \quad f_{30}(k, \ell, c) + c \cdot (t + 1) + f_{29}(k, \ell, t - 1, a - 1), c'). \end{aligned}$$

Now let

$$S_C = Z_C \cup \bigcup_{C' \in \mathcal{C}_C} S'_{C'}.$$

Then, by Lemma 13,

$$\begin{aligned} \text{td}_k(C, S_C) &\leq |Z_C| + \max_{C' \in \mathcal{C}_C} \text{td}_k(C', S'_{C'}) \\ &\leq c \cdot (t + 1) + c \cdot f_{29}(k, \ell, t - 1, a - 1) + \\ &\quad + f_{30.1}(t, \ell' + 1, \\ &\quad \quad f_{30}(k, \ell, c) + c \cdot (t + 1) + f_{29}(k, \ell, t - 1, a - 1), c'). \end{aligned}$$

Finally, let

$$S' = Z \cup \bigcup_{\substack{C \text{ connected component of} \\ \text{torso}_{G'}(U', \mathcal{B}') - Z}} S_C.$$

Recall that  $\text{torso}_{G'}(U', \mathcal{B}') - Z = \text{torso}_G(U, \mathcal{B}) - X - Z = \text{torso}_G(U, \mathcal{B})[V_{\ell'}] - Z$ . Then, by Lemma 13,

$$\begin{aligned} \text{td}_k(\text{torso}_G(U, \mathcal{B})[V_{\ell'}], S') &\leq \text{td}_k(\text{torso}_G(U, \mathcal{B})[V_{\ell'}], Z) + \max_{\substack{C \text{ connected component of} \\ \text{torso}_{G'}(U', \mathcal{B}') - Z}} \text{td}_k(C, S_C) \\ &\leq f_{30}(k, \ell, c) \\ &\quad + c \cdot (t + 1) \\ &\quad + c \cdot f_{29}(k, \ell, t - 1, a - 1) + \\ &\quad + f_{30.1}(t, \ell' + 1, \\ &\quad \quad f_{30}(k, \ell, c) + c \cdot (t + 1) + f_{29}(k, \ell, t - 1, a - 1), c') \\ &\leq f_{30.1}(t, \ell', c, c'). \end{aligned}$$

Since  $S \cap V_{\ell'} \subseteq S'$ , this proves the claim.  $\diamond$

We now define  $f_{29}(k, \ell, t, a)$  by

$$f_{29}(k, \ell, t, a) = \max \left\{ t, \frac{3}{2}(k-1), 2k-1 + f_{30.1} \left( \max \left\{ t, \frac{3}{2}(k-1) \right\}, 1, k, \max \left\{ t, \frac{3}{2}(k-1) \right\} \right) \right\}.$$

Let  $G$  be a graph that does not contain any  $k$ -ladder of length  $\ell$  as a minor, let  $(U, \mathcal{B})$  be a nice pair in  $G$ , and let  $S \subseteq U$  be such that there is a tree decomposition of  $(\text{torso}_G(U, \mathcal{B}), S)$  of adhesion at most  $a$  and width less than  $t$ . To deduce the theorem, we will decompose  $\text{torso}_G(U, \mathcal{B})$  into nice pairs using Lemma 28. By Lemma 28 applied to  $\text{torso}_G(U, \mathcal{B})$  and  $S$ , there exists  $S'_0 \subseteq U$  containing  $S$  and  $\mathcal{D} = (T, (W_x \mid x \in V(T)))$  a tree decomposition of  $(\text{torso}_G(U, \mathcal{B}), S'_0)$  such that if  $\mathcal{C}$  is the family of all the connected components of  $\text{torso}_G(U, \mathcal{B}) - S'_0$ , then

28.(a)  $\mathcal{D}$  has adhesion at most  $a$ ;

28.(b)  $\mathcal{D}$  has width less than  $\max \left\{ t, \frac{3}{2}(k-1) \right\}$ ;

28.(c) for every  $x_1, x_2 \in V(T)$ , for every  $Z_1 \subseteq W_{x_1}$  and  $Z_2 \subseteq W_{x_2}$  both of size  $k$ , either

- (i) there are  $k$  disjoint  $(Z_1, Z_2)$ -paths in  $G$ ,
- (ii) there exists  $z_1, z_2 \in E(T[x_1, x_2])$  with  $|W_{z_1} \cap W_{z_2}| < k$ , or
- (iii)  $x_1 = x_2$ ,  $|W_{x_1}| \leq \frac{3}{2}(k-1)$  and  $|W_{x_1} \cap W_y| < k$  for every  $y \in N_T(x_1)$ ; and

28.(d) for every  $x_1 x_2 \in E(T)$  with  $|W_{x_1} \cap W_{x_2}| < k$ , if there exists  $x_3 \in N_T(x_2)$  such that  $|W_{x_2} \cap W_{x_3}| \geq k$ , then for every positive integer  $i$ , for every  $Z_1, Z_2 \subseteq W_{x_1} \cap W_{x_2}$  both of size  $i$ , there are  $i$  disjoint  $(Z_1, Z_2)$ -paths in

$$\text{torso}_G(U, \mathcal{B}) \left[ \bigcup_{z \in V(T_{x_2|x_1})} W_z \cup \bigcup_{C \in \mathcal{C}(x_2|x_1)} V(C) \right] \setminus \binom{W_{x_1} \cap W_{x_2}}{2},$$

where  $\mathcal{C}(x_2 \mid x_1)$  is the family of all the components  $C \in \mathcal{C}$  such that  $N_{\text{torso}_G(U, \mathcal{B})}(V(C)) \subseteq \bigcup_{z \in V(T_{x_2|x_1})} W_z$  and  $N_{\text{torso}_G(U, \mathcal{B})}(V(C)) \not\subseteq W_{x_1} \cap W_{x_2}$ .

For every connected component  $C \in \mathcal{C}$ , fix  $x_C \in V(T)$  such that  $N_{\text{torso}_G(U, \mathcal{B})}(V(C)) \subseteq W_{x_C}$ .

Let  $E_{<k}$  be the set of all the edges  $zz'$  of  $T$  such that  $|W_z \cap W_{z'}| < k$ . If  $E_{<k} = E(T)$ , then  $\mathcal{D}$  has adhesion at most  $k-1$  and so it is a  $k$ -dismantable tree decomposition of  $(\text{torso}_G(U, \mathcal{B}), S')$  of width less than  $\max \left\{ t, \frac{3}{2}(k-1) \right\}$ . This implies that  $\text{td}_k(\text{torso}_G(U, \mathcal{B}), S'_0) \leq \max \left\{ t, \frac{3}{2}(k-1) \right\} \leq f_{29}(k, \ell, t, a)$ .

Now suppose  $E_{<k} \neq E(T)$ . We root  $T$  on a vertex  $r$  which is incident to an edge in  $E(T) \setminus E_{<k}$ . Let  $T_1, \dots, T_m$  be all the connected components of  $T \setminus E_{<k}$  that contain at least one edge.

Consider some  $i \in [m]$ . Let  $A_i$  be the adhesion between the root of  $T_i$  and its parent if  $r \notin V(T_i)$ , or the empty set if  $r \in V(T_i)$ . Let  $T'_i$  be the connected component containing  $T_i$  in  $T - \bigcup_{j \in [m], j \neq i} V(T_j)$ , see Figure 12. Then let  $T''_i$  be the subtree of  $T'_i$  rooted on the root of  $T_i$ . Let

$$U_i = \bigcup_{z \in V(T'_i)} \left( W_z \cup \bigcup_{C \in \mathcal{C}, N_{\text{torso}_G(U, \mathcal{B})}(V(C)) \subseteq W_z} V(C) \right),$$

and let  $\mathcal{B}_i$  be the family all of the sets

$$\bigcup_{z \in V(S)} \left( W_z \cup \bigcup_{\substack{C \in \mathcal{C}, N_{\text{torso}_G(U, \mathcal{B})}(V(C)) \subseteq W_z, \\ N_{\text{torso}_G(U, \mathcal{B})}(V(C)) \not\subseteq U_i}} V(C) \right)$$

for  $S$  connected component of  $T - T'_i$ .

Let

$$V_i = \bigcup_{z \in V(T''_i)} W_z \cup \bigcup_{C \in \mathcal{C}, x_C \in V(T''_i)} V(C)$$

and let  $\mathcal{B}''_i$  be the family of all the sets

$$\bigcup_{z \in V(S)} \left( W_z \cup \bigcup_{\substack{C \in \mathcal{C}, N_{\text{torso}_G(U, \mathcal{B})}(V(C)) \subseteq W_z, \\ x_C \notin V(T''_i)}} V(C) \right)$$

for  $S$  connected component of  $T - T''_i$ . Then let  $G_i = \text{torso}_{\text{torso}_G(U, \mathcal{B})}(V_i, \mathcal{B}''_i)$ . Observe that  $G$  can be obtained by ( $< k$ )-clique-sums of  $G_1, \dots, G_m$ , and  $V(G_i) \cap V(G_j) \subseteq S$  for every distinct  $i, j \in [m]$ . Hence it remains to bound  $\text{td}_k(G_i, S'_0 \cap V(G_i))$  for every  $i \in [m]$ .

By construction,  $(U_i, \mathcal{B}_i)$  is a good pair in  $\text{torso}_G(U, \mathcal{B})$ . Moreover, for every connected component  $S$  of  $T - T'_i$ , if the edge between  $T'_i$  and  $S$  is  $x_1x_2$  with  $x_1 \in V(T'_i)$ , then  $|W_{x_1} \cap W_{x_2}| < k$  and  $x_2$  belongs to some  $T_j$  for  $j \in [m] \setminus \{i\}$ , which implies that  $x_2$  has a neighbor  $x_3$  with  $|W_{x_2} \cap W_{x_3}| \geq k$ . By 28.(d), this implies that for every positive integer  $i$ , for every  $Z_1, Z_2 \subseteq W_{x_1} \cap W_{x_2}$  both of size  $i$ , there are  $i$  disjoint  $(Z_1, Z_2)$ -paths in  $\text{torso}_G(U, \mathcal{B}) \left[ \bigcup_{z \in V(T_{x_2|x_1})} W_z \cup \bigcup_{C \in \mathcal{C}(x_2 \cup x_1)} V(C) \right] \setminus (W_{x_1} \cap W_{x_2})$ . This implies that  $(U_i, \mathcal{B}_i)$  is a nice pair in  $\text{torso}_G(U, \mathcal{B})$ . Now, since  $(U, \mathcal{B})$  is a nice pair in  $G$ , we deduce by Lemma 25 that there exists  $\mathcal{B}'_i$  such that  $(U_i, \mathcal{B}'_i)$  is a nice pair in  $G$  and  $\text{torso}_G(U_i, \mathcal{B}'_i) = \text{torso}_{\text{torso}_G(U, \mathcal{B})}(U_i, \mathcal{B}_i)$ . Now, observe that  $G_i \subseteq \text{torso}_G(U_i, \mathcal{B}'_i) \cup \binom{A_i}{2}$ . Hence, to bound  $\text{td}_k(G_i, S'_0 \cap V(G_i))$ , it is enough to bound the  $k$ -treedepth of  $\text{td}_k(\text{torso}_G(U_i) \cup \binom{A_i}{2}, S'_0 \cap U_i)$ . To do so, we will apply Claim 30.1.

Let  $V_0$  be a subset of  $k$  vertices of the bag of the root of  $T_i$ . Observe that for every  $W \subseteq U_i$ , if there are no  $k$  disjoint  $(V_0, W)$ -paths in  $\text{torso}_G(U_i, \mathcal{B}'_i)$ , then by Lemma 24 and 28.(c),  $|W \cap W_z| < k$  for every  $z \in V(T_i)$ . This implies that  $|W_z \cap W_{z'} \cap W| < k$  for every  $zz' \in E(T'_i)$ , and so  $(T'_i, (W_z \cap W \mid z \in V(T'_i)))$  is a tree decomposition of  $(\text{torso}_G(U_i, \mathcal{B}'_i)[W], S'_0 \cap W)$  of adhesion at most  $k - 1$  and width less than  $\max\{t, \frac{3}{2}(k - 1)\}$ . This proves that  $\text{td}_k(\text{torso}_G(U_i, \mathcal{B}'_i)[W], S'_0 \cap W) \leq \max\{t, \frac{3}{2}(k - 1)\}$ . Hence, by Claim 30.1 applied to the path partition  $(V_0, U_i \setminus V_0)$ ,  $\ell' = 1$ ,  $c = k$ ,  $c' = \max\{t, \frac{3}{2}(k - 1)\}$ ,  $V_1 = U_i \setminus V_0$ , there exists  $S'_{0,i} \subseteq U_i \setminus V_0$  with  $S'_0 \cap (U_i \setminus V_0) \subseteq S'_{0,i}$  such that

$$\text{td}_k(\text{torso}_G(U_i, \mathcal{B}'_i)[U_i \setminus V_0], S'_{0,i}) \leq f_{30.1}(\max\{t, \frac{3}{2}(k - 1)\}, 1, k, \max\{t, \frac{3}{2}(k - 1)\}).$$

Let  $S'_i = (S'_{0,i} \cup V_0) \cap V(G_i)$ . Then

$$\begin{aligned} \text{td}_k(G_i, S'_i) &\leq \text{td}_k(\text{torso}_G(U_i, \mathcal{B}'_i), S'_{0,i} \cup V_0) + |A_i| \\ &\leq |V_0| + \text{td}_k(\text{torso}_G(U_i, \mathcal{B}'_i)[U_i \setminus V_0], S'_{0,i}) + |A_i| \\ &\leq k + f_{30.1}(\max\{t, \frac{3}{2}(k - 1)\}, 1, k, \max\{t, \frac{3}{2}(k - 1)\}) + (k - 1) \\ &\leq f_{29}(k, \ell, t, a). \end{aligned}$$

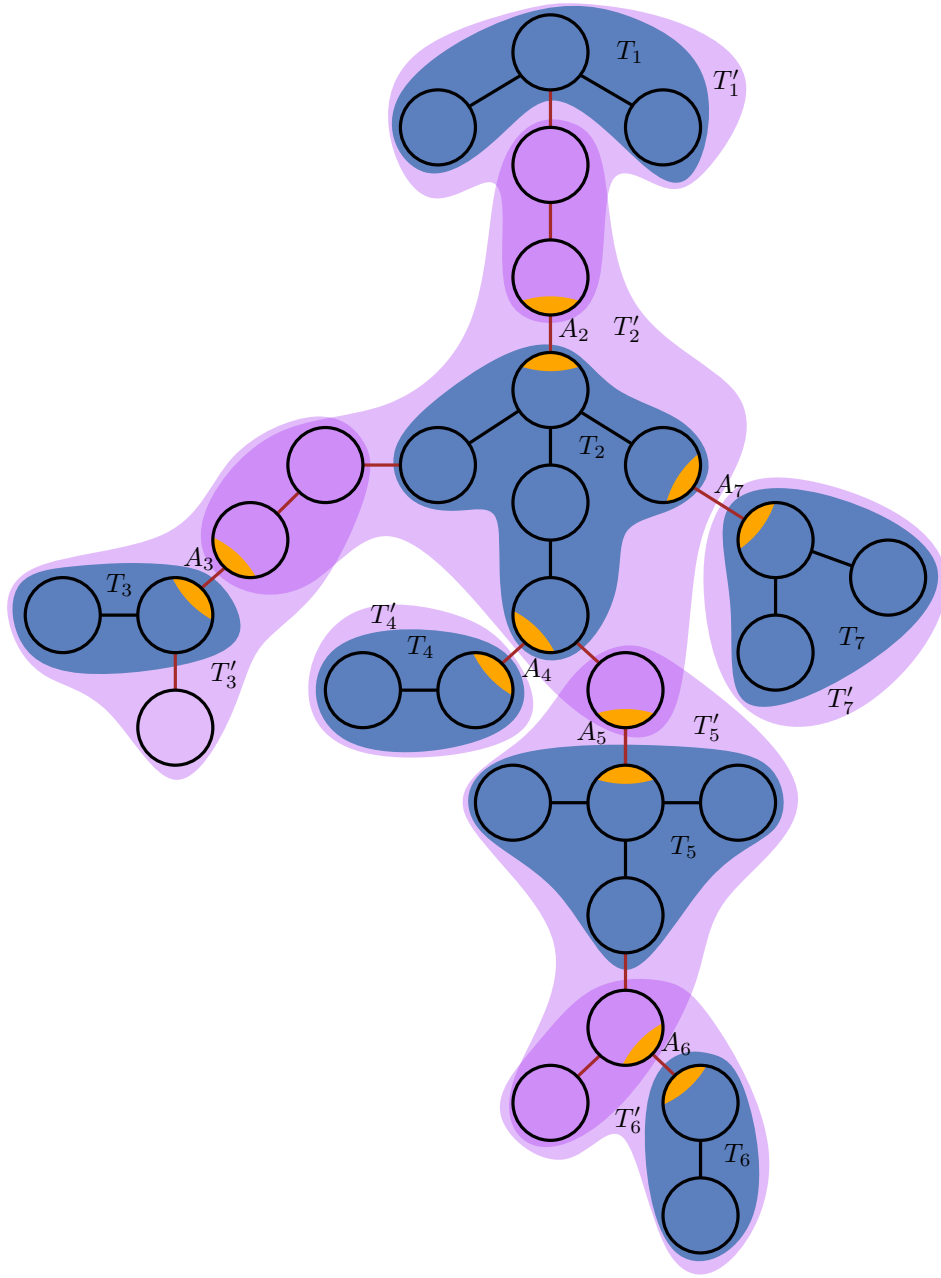

Figure 12: Application of Lemma 28 in the proof of Theorem 29. This yields a tree decomposition of  $(\text{torso}_G(U, \mathcal{B}), S'_0)$  for some  $S'_0 \subseteq U$  containing  $S$ . For sake of clarity, the connected components of  $\text{torso}_G(U, \mathcal{B}) - S'_0$  are not depicted. We want to decompose  $\text{torso}_G(U, \mathcal{B})$  using this tree decomposition as a clique sum of some “nice”  $G_1, \dots, G_m$ . To do so, we rely on the “well-connected” adhesions given by 28.(d). In orange are depicted the clique-sums we will perform. In black are depicted the edge  $zz' \in E(T)$  with  $|W_z \cap W_{z'}| \geq k$ , and in brown those for which  $|W_z \cap W_{z'}| < k$ . By the properties of the tree decomposition, and in particular 28.(d), the sets  $U_i = \bigcup_{z \in V(T'_i)} W_z \cup \bigcup_{C \in \mathcal{C}, x_C \in V(T'_i)} V(C)$  are in suitable nice pairs  $(U_i, \mathcal{B}'_i)$  in  $G$ , and so we can apply Claim 30.1 to decompose them.

Let  $\mathcal{D}_i = (T_i, (W_z \mid z \in V(T_i)))$  be a  $k$ -dismantlable tree decomposition of  $(G_i, S'_i)$  of width less than  $f_{29}(k, \ell, t, a)$ .

Finally, let

$$S' = \bigcup_{i \in [m]} S'_i.$$

Let  $(i_1, j_1), \dots, (i_{m-1}, j_{m-1})$  be all the pairs of distinct indices  $i, j \in [m]$  such that there is an edge between  $V(T'_j)$  and  $V(T_i)$  in  $T$ , with the root of  $T_i$  being closer from  $r$  in  $T$  than the root of  $T_j$ . Note that for every  $a \in [m-1]$ ,  $A_{i_a} = V(G_{i_a}) \cap V(G_{j_a})$  induces a clique in both  $G_{i_a}$  and  $G_{j_a}$ , and  $A_{i_a} \subseteq S'$ . This implies that there exists  $z_a \in V(T_{i_a})$  and  $z'_a \in V(T_{j_a})$  such that  $V(G_{i_a}) \cap V(G_{j_a}) \subseteq W_{z_a}^{i_a}, W_{z'_a}^{j_a}$ . Now, let  $T' = \left( \bigcup_{i \in [m]} T_i \right) \cup \{z_a z'_a \mid a \in [m-1]\}$  and  $S' = \bigcup_{i \in [m]} (S'_i \cap V(G_i))$ . Then,  $S \subseteq S'_0 \subseteq S'$  and  $(T', (W_x \mid x \in V(T')))$  is a  $k$ -dismantlable tree decomposition of  $(G, S')$  of width less than  $f_{29}(k, \ell, t, a)$ . This proves the theorem.  $\square$

## 8 $k \times \ell$ grid minor of long $(2k-1)$ -ladders

In this section, we show how to find a  $k \times \ell$  grid in  $T \square P_L$  for any tree  $T$  on  $2k-1$  vertices, and some large enough integer  $L$ . Together with Theorem 1, this implies Corollary 2.

**Lemma 31.** *Let  $k, \ell$  be positive integers. For every tree  $T$  on  $2k-1$  vertices, there exists an integer  $L$  such that the  $k \times \ell$  grid is a minor of  $T \square P_L$ .*

First, let us introduce some notation. Given two graphs  $H, G$ , we write  $H \sqsubseteq G$  if there is a sequence  $\varphi_1, \dots, \varphi_m$  of injective functions from  $V(H)$  to  $V(G)$  such that

- (i) for every  $i \in [m-1]$ ,  $\varphi_i$  and  $\varphi_{i+1}$  differs on exactly one vertex  $x \in V(H)$ , and  $\varphi_i(x)\varphi_{i+1}(x)$  is an edge in  $G$ ; and
- (ii) for every  $xy \in E(H)$ , there exists  $i \in [m]$  such that  $\varphi_i(x)\varphi_i(y) \in E(G)$ .

Less formally, we can see the vertices of  $H$  as tokens placed on the vertices of  $G$ , and we successively move these tokens along the edges of  $G$  in such a way that every edge of  $H$  is such that the corresponding tokens are adjacent in  $G$  at least once in this sequence. See Figure 13.

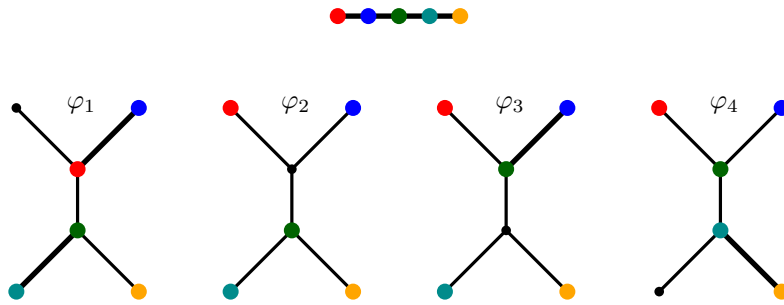

Figure 13: A sequence  $(\varphi_1, \varphi_2, \varphi_3, \varphi_4)$  witnessing that  $P_5 \sqsubseteq T$ , where  $T$  is the tree on 6 vertices having two internal vertices of degree 3. Informally, we place the vertices of  $P_5$  as token on the graph  $T$ , and we move them one by one in such a way that for every edge  $xy$  of  $P_5$ , the tokens of  $x$  and  $y$  are adjacent in  $T$  at least once. The fat edges represent these realizations  $\varphi_i(x)\varphi_i(y) \in E(T)$  of the edges  $xy \in E(P_5)$ .

This definition is motivated by the following observation.

**Observation 32.** Let  $G, H$  be two graphs. If  $H \sqsubseteq G$ , then for every positive integer  $\ell$ , there exists a positive integer  $L$  such that  $H \square P_\ell$  is a minor of  $G \square P_L$ .

*Proof.* Since  $H \sqsubseteq G$ , there is a sequence  $\varphi_1, \dots, \varphi_m$  of injective functions from  $V(H)$  to  $V(G)$  such that

- (i) for every  $i \in [m-1]$ ,  $\varphi_i$  and  $\varphi_{i+1}$  differs on exactly one vertex  $x \in V(H)$ , and  $\varphi_i(x)\varphi_{i+1}(x)$  are adjacent in  $G$ ; and
- (ii) for every  $xy \in E(H)$ , there exists  $i \in [m]$  such that  $\varphi_i(x)\varphi_i(y) \in E(G)$ .

Let  $L = \ell \cdot (2m-1)$ . We label the vertices of  $G \square P_L$  by  $(x, i)$  for  $x \in V(G)$  and  $i \in [L]$ . For every  $x \in V(H)$ , let  $B_x^0 = \{(\varphi_i(x), i) \mid i \in [m]\} \cup \{(\varphi_i(x), i+1) \mid i \in [m-1], \varphi_i(x) \neq \varphi_{i+1}(x)\}$ . Then let  $B_x^1 = B_x^0 \cup \{(u, 2m-i) \mid (u, i) \in B_x^0\}$ , and finally  $B_{(x,j)} = \{(u, i+(2m-1)(j-1)) \mid (u, i) \in B_x^1\}$  for every  $j \in [\ell]$ . See Figure 14. It is not hard to check that  $(G \square P_L)[B_{(x,j)}]$  is connected, that the sets  $(B_{(x,j)})_{x \in V(H), j \in [\ell]}$  are pairwise disjoint, and for every  $xy \in E(H)$ , there is an edge between  $B_{(x,j)}$  and  $B_{(y,j)}$  in  $G \square P_L$ , for every  $j \in [\ell]$ . Moreover, there is an edge between  $B_{(x,j)}$  and  $B_{(x,j+1)}$  in  $G \square P_L$  for every  $j \in [\ell-1]$ . Hence  $(B_{(x,j)} \mid (x, j) \in V(H \square P_\ell))$  is a model of  $H \square P_\ell$  in  $G \square P_L$ . This proves the observation.  $\square$

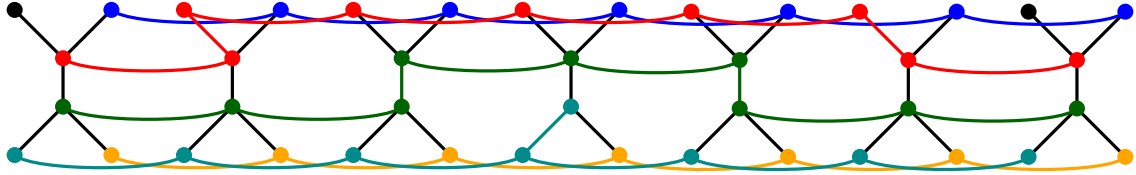

Figure 14: Illustration for Observation 32. Using the sequence  $(\varphi_1, \dots, \varphi_4)$  given in Figure 13, we construct a model of  $P_5 \square P_\ell$  in  $T \square P_{7 \cdot \ell}$  by gluing together  $\ell$  copies of the model  $(B_x^1 \mid x \in V(P_5))$  depicted here. For sake of clarity, some edges of  $T \square P_7$  which are not used by this model are not depicted.

Using Observation 32, it is enough to show the following to prove Lemma 31.

**Lemma 33.** For every positive integer  $k$ , for every tree  $T$  on  $2k-1$  vertices,  $P_k \sqsubseteq T$ .

*Proof.* Let  $P = (u_0, \dots, u_p)$  be a longest path in  $T$ . If  $p \geq k-1$ , then set  $m = 1$  and  $\varphi_1(i) = u_{i-1}$ , for every vertex  $i$  of the path  $P_k = (1, \dots, k)$ , and it follows that  $P_k \sqsubseteq T$ . Now we assume that  $p \leq k-2$ , and so  $|V(T) \setminus V(P)| \geq k$ . Let  $\varphi_0$  be any injection from  $[k] = V(P_k)$  to  $V(T) \setminus V(P)$ . We claim that it is enough to show that for every distinct  $x, y \in [k] = V(P_k)$ , there is a sequence  $(\varphi_1^{x,y}, \dots, \varphi_{m_{x,y}}^{x,y})$  of injections from  $[k]$  to  $V(T)$  such that

- (i) for every  $i \in [m_{x,y} - 1]$ ,  $\varphi_i^{x,y}$  and  $\varphi_{i+1}^{x,y}$  differs on exactly one vertex  $x \in V(H)$ , and  $\varphi_i^{x,y}(x)\varphi_{i+1}^{x,y}(x)$  are adjacent in  $G$ ; and
- (ii)  $\varphi_{m_{x,y}}^{x,y}(x)\varphi_{m_{x,y}}^{x,y}(y) \in E(T)$ ;
- (iii)  $\varphi_1^{x,y} = \varphi_0$ .

Indeed, the sequence  $\varphi_1^{1,2}, \dots, \varphi_{m_{1,2}-1}^{1,2}, \varphi_{m_{1,2}}^{1,2}, \varphi_{m_{1,2}-1}^{1,2}, \dots, \varphi_2^{1,2}, \varphi_1^{2,3}, \dots, \dots, \varphi_{m_{(k-1),k}}^{(k-1),k}$  then witnesses that  $P_k \sqsubseteq T$ . Note that this argument also yields  $K_k \sqsubseteq T$ .

For sake of clarity, we fix  $x, y \in [k] = V(P_k)$  distinct, and we will write  $\varphi_i$  for  $\varphi_i^{x,y}$ . First set  $\varphi_1 = \varphi_0$ . Let  $u_i$  (resp.  $u_j$ ) be the vertex of  $P$  closest to  $x$  (resp.  $y$ ). Without loss of



generality, assume that  $i \leq j$ . By maximality of  $P$ ,  $|V(P[u_0, u_i])| \geq |V(T[\varphi_0(x), u_i])|$  and  $|V(P[u_j, u_p])| \geq |V(T[\varphi_0(y), u_j])|$ .

Then we move the vertices of  $\varphi_0([k]) \cap V(T[\varphi_0(x), u_i])$  into  $\{u_0, \dots, u_{i-1}\}$  by a sequence  $\varphi_1, \dots, \varphi_{m_0}$  satisfying (i) and such that  $\varphi_{m_0}(x) = u_{i-1}$ , and the vertices not in  $T[\varphi_0(x), u_i]$  are not moved. Then, we move the vertices of  $\varphi_0([k]) \cap V(T[\varphi_0(y), u_j])$  into  $\{u_{j+1}, \dots, u_p\}$  by a sequence  $\varphi_{m_0+1}, \dots, \varphi_{m_1}$  satisfying (i) and such that  $\varphi_{m_1}(y) = u_{j+1}$ , and the vertices not in  $T[\varphi_0(y), u_j]$  are not moved. Finally, we move  $y$  from  $u_{j+1}$  to  $u_i$  by a sequence  $\varphi_{m_1+1}, \dots, \varphi_m$  satisfying (i) and such that  $\varphi_i(z) = \varphi_{m_1}(z)$  for every  $z \in [k] \setminus \{y\}$ . This sequence is depicted on Figure 15. Then  $\varphi_m(x)\varphi_m(y) = u_{j-1}u_j$  is an edge of  $T$ , and so  $\varphi_1, \dots, \varphi_m$  is as claimed. This proves the lemma.  $\square$

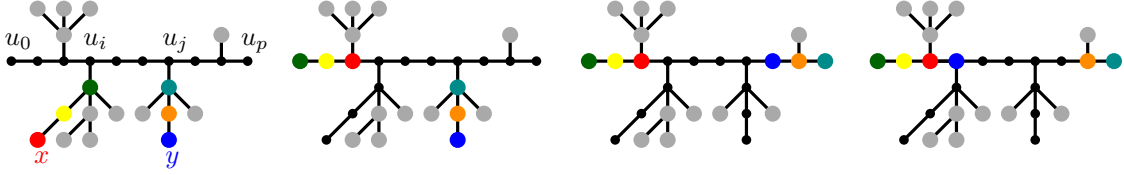

Figure 15: The main steps in the sequence given in the proof of Lemma 33 to make adjacent the red token  $x$  and the blue token  $y$ . In gray are depicted the tokens which are not moved.

## 9 Conclusion

To conclude, we describe a large family of parameters including treewidth,  $k$ -treedepth, and other classical minor-monotone parameters bigger than treewidth. The  $k$ -treedepth describes how a graph can be built by alternatively adding a vertex and doing some ( $< k$ )-clique-sums. Another similar example is the vertex cover number, which describes how a graph can be built by adding a vertex, doing some disjoint union (thus obtaining every edgeless graph), and adding some vertices. In these two examples, the value of the obtained parameter is given by the number of times a vertex is added (minus one in the case of the vertex cover number). We propose to define a parameter for every such sequence of vertex additions and ( $< k$ )-clique-sums.

Let  $\Sigma = \{a\} \cup \{s_k \mid k \geq 1\}$  be an alphabet. We denote by  $\varepsilon$  the empty word in  $\Sigma^*$ . Intuitively, the letter  $a$  corresponds to a vertex addition and the letter  $s_k$  to ( $< k$ )-clique-sums. We will identify regular expressions over  $\Sigma$  with their corresponding languages. For every  $w \in \Sigma^*$ , we define  $p_w$  as the graph parameter taking values in  $\mathbb{N}_{\geq 0} \cup \{+\infty\}$  defined inductively as follows. For every graph  $G$ , for every  $w \in \Sigma^*$ , for every positive integer  $k$ ,

$$p_\varepsilon(G) = \begin{cases} 0 & \text{if } G = \emptyset, \\ +\infty & \text{otherwise,} \end{cases}$$

$$p_{wa}(G) = \min(\{p_w(G)\} \cup \{p_w(G - u) + 1 \mid u \in V(G)\}),$$

$$p_{ws_k}(G) = \min(\{p_w(G)\} \cup \{\max\{p_{ws_k}(G_1), p_{ws_k}(G_2)\} \mid (G_1, G_2)\})$$

where in the last case,  $(G_1, G_2)$  ranges over all the pairs of graphs such that  $G$  is a ( $< k$ )-clique-sum of  $G_1$  and  $G_2$  with  $|V(G_1)|, |V(G_2)| > |V(G_1) \cap V(G_2)|$ . Less formally, we read from left to right  $w$  as follows. When reading the letter  $a$ , we can add a vertex (with arbitrary neighborhood) to a previously obtained graph, and when reading the letter  $s_k$ , we can make arbitrarily many ( $< k$ )-clique-sums of previously obtained graphs. Then  $p_w(G)$  is the minimum number of times

we add a vertex (when reading the letter  $a$ ) in such a construction of  $G$ . If it is not possible to construct  $G$  this way, then  $p_w(G) = +\infty$ . Now, for every  $L \subseteq \Sigma^*$ , let

$$p_L(G) = \min_{w \in L} p_w(G),$$

with the convention  $\min \emptyset = +\infty$ . An induction as in the proof of Lemma 12 shows that for every  $L \subseteq \Sigma^*$ , the parameter  $p_L$  is minor-monotone. Note that  $p_L(G) \geq \text{tw}(G) + 1$  for every graph  $G$ , for every  $L \subseteq \Sigma^*$ . We denote by  $s_{+\infty}$  the language  $\{s_k \mid k \geq 1\}$ . Several classical minor-monotone graph parameters are of the form  $p_L$  for  $L \subseteq \Sigma^*$ : for every graph  $G$  with at least one edge, for every positive integer  $k$ ,

$$\begin{aligned} p_{a^*}(G) &= |V(G)|, \\ p_{a^*s_1}(G) &= \max_{\substack{C \text{ connected} \\ \text{component of } G}} |V(C)|, \\ p_{a^*s_2}(G) &= \max_{B \text{ block of } G} |V(B)|, \\ p_{a^*s_k}(G) &= \text{tw}_k(G) + 1, \end{aligned}$$

where  $\text{tw}_k(G)$  is the  $k$ -treewidth of  $G$  [GJ16], which is the minimum width of a tree decomposition of  $G$  of adhesion less than  $k$ ,

$$\begin{aligned} p_{a^*s_{+\infty}}(G) &= \text{tw}(G) + 1, \\ p_{(as_k)^*}(G) &= \text{td}_k(G), \\ p_{(as_1)^*s_2}(G) &= \max_{B \text{ block of } G} \text{td}(B), \\ p_{as_1a^*}(G) &= \text{vc}(G) + 1, & \text{where } \text{vc}(G) \text{ is the vertex cover number of } G, \\ p_{a^2s_2a^*}(G) &= \text{fvs}(G) + 2, & \text{where } \text{fvs}(G) \text{ is the feedback vertex set number of } G. \end{aligned}$$

The last two examples follows from the following property: for every graph  $G$ ,

$$p_{as_1}(G) = \begin{cases} 0 & \text{if } G = \emptyset, \\ 1 & \text{if } E(G) = \emptyset \text{ and } V(G) \neq \emptyset, \\ +\infty & \text{if } E(G) \neq \emptyset \end{cases}$$

and

$$p_{a^2s_2}(G) = \begin{cases} 0 & \text{if } G = \emptyset, \\ 1 & \text{if } E(G) = \emptyset \text{ and } V(G) \neq \emptyset, \\ 2 & \text{if } E(G) \neq \emptyset \text{ and } G \text{ is a forest,} \\ +\infty & \text{otherwise.} \end{cases}$$

Another noteworthy example is  $p_{a^2s_2(as_1)^*}$  which is (two plus) the elimination distance to a forest, a parameter used in the context of parameterized complexity, see [DJ24].

**Problem 34.** *Given a language  $L \subseteq \Sigma^*$ , characterize classes of graphs having bounded  $p_L$  in terms of excluded minors.*

There is little hope that a general answer can be given to this problem. Indeed, for every nonnegative integer  $k$ , for every graph  $G$ ,

$$p_{a^{k+1}s_{+\infty}}(G) = \begin{cases} \text{tw}(G) + 1 & \text{if } \text{tw}(G) \leq k \\ +\infty & \text{otherwise} \end{cases}$$

and so a class of graphs has bounded  $p_{a^{k+1}s+\infty}$  if and only if it excludes all the minimal obstructions to treewidth at most  $k$ , which have not been determined yet, even for  $k = 4$  (see [Ram97]). Nonetheless, as highlighted in [PPT23a, PPT23b], the problem of determining universal obstructions for some general families of graph parameters is a challenging line of research.

An important observation is that it is enough to consider only very specific languages  $L \subseteq \Sigma^*$ , namely the downward closed languages under a specific order  $\preceq^*$  on  $\Sigma^*$ , that we now define. Let  $\preceq$  be the order on  $\Sigma$  whose relations are  $a \preceq a$  and  $s_i \preceq s_j$  for every positive integers  $i, j$  with  $i \leq j$ , and let  $\preceq^*$  be the order on  $\Sigma^*$  defined by, for all  $x_1, \dots, x_\ell, y_1, \dots, y_m \in \Sigma$ ,  $x_1 \dots x_\ell \preceq^* y_1 \dots y_m$  if and only if there exist  $1 \leq i_1 < \dots < i_\ell \leq m$  such that  $x_j \preceq y_{i_j}$  for every  $j \in [\ell]$ . It follows from the definition that  $p_w(G) \geq p_{w'}(G)$  for every graph  $G$  and for every  $w, w' \in \Sigma^*$  with  $w \preceq^* w'$ . Hence, for every  $L \subseteq \Sigma^*$ ,  $p_L = p_{\downarrow L}$ , where  $\downarrow L$  is the language  $\{u \in \Sigma^* \mid \exists w \in L, u \preceq^* w\}$ . Moreover, by Higman's Lemma [Hig52],  $(\Sigma^*, \preceq^*)$  is a well-quasi-ordering. Hence for every  $L \subseteq \Sigma^*$ , there exists a finite set  $F \subseteq \Sigma^*$  (namely the set of all the minimal elements of  $\Sigma^* \setminus \downarrow L$ ) such that  $\downarrow L = \{w \in \Sigma^* \mid \forall u \in F, u \not\preceq^* w\}$ . In particular,  $p_L$  is computable for every fixed  $L \subseteq \Sigma^*$ .

## Acknowledgements.

Thanks to Frédéric Havet for his comments on an earlier version of this work. I am also grateful to Gwenaël Joret and Piotr Micek for helpful discussions, and to Jędrzej Hodor for a suggestion of notation.

## References

- [BCE<sup>+</sup>19] Therese Biedl, Erin Wolf Chambers, David Eppstein, Arnaud De Mesmay, and Tim Ophelders. Homotopy height, grid-major height and graph-drawing height. In *Graph Drawing and Network Visualization*, page 468–481. Springer International Publishing, 2019. [arXiv:1908.05706](https://arxiv.org/abs/1908.05706).
- [BD02] Patrick Bellenbaum and Reinhard Diestel. Two short proofs concerning tree-decompositions. *Combinatorics, Probability and Computing*, 11(6):541–547, 2002.
- [CC16] Chandra Chekuri and Julia Chuzhoy. Polynomial bounds for the Grid-Minor Theorem. *Journal of the ACM*, 63(5):1–65, 2016. [arXiv:1305.6577](https://arxiv.org/abs/1305.6577).
- [CKL<sup>+</sup>20] Marek Cygan, Paweł Komosa, Daniel Lokshantov, Marcin Pilipczuk, Michał Pilipczuk, Saket Saurabh, and Magnus Wahlström. Randomized contractions meet lean decompositions. *ACM Transactions on Algorithms*, 17(1):1–30, 2020. [arXiv:1810.06864](https://arxiv.org/abs/1810.06864).
- [CT21] Julia Chuzhoy and Zihan Tan. Towards tight(er) bounds for the excluded grid theorem. *Journal of Combinatorial Theory, Series B*, 146:219–265, 2021. [arXiv:1901.07944](https://arxiv.org/abs/1901.07944).
- [DHH<sup>+</sup>24] Vida Dujmović, Robert Hickingbotham, Jędrzej Hodor, Gwenaël Joret, Hoang La, Piotr Micek, Pat Morin, Clément Rambaud, and David R. Wood. The Grid-Minor Theorem revisited. In *Proceedings of the 2024 Annual ACM-SIAM Symposium on Discrete Algorithms (SODA)*, page 1241–1245. Society for Industrial and Applied Mathematics, 2024. [arXiv:2307.02816](https://arxiv.org/abs/2307.02816).
- [Die17] Reinhard Diestel. *Graph Theory*. Springer Berlin Heidelberg, 2017.

- [DJ24] David J.C. Dekker and Bart M.P. Jansen. Kernelization for feedback vertex set via elimination distance to a forest. *Discrete Applied Mathematics*, 346:192–214, 2024. [arXiv:2206.04387](#).
- [Erd18] Joshua Erde. A unified treatment of linked and lean tree-decompositions. *Journal of Combinatorial Theory, Series B*, 130:114–143, 2018. [arXiv:1703.03756](#).
- [ES35] Paul Erdős and George Szekeres. A combinatorial problem in geometry. *Compositio Mathematica*, 2:463–470, 1935.
- [GJ16] Jim Geelen and Benson Joeris. A generalization of the Grid Theorem. *arXiv preprint*, 2016. [arXiv:1609.09098](#).
- [Hig52] Graham Higman. Ordering by divisibility in abstract algebras. *Proceedings of the London Mathematical Society*, s3-2(1):326–336, 1952.
- [HJM<sup>+</sup>21] Tony Huynh, Gwenaél Joret, Piotr Micek, Michał T. Seweryn, and Paul Wollan. Excluding a ladder. *Combinatorica*, 42(3):405–432, 2021. [arXiv:2002.00496](#).
- [HLMR24a] Jędrzej Hodor, Hoang La, Piotr Micek, and Clément Rambaud. Quickly excluding an apex-forest. *arXiv preprint*, 2024. [arXiv:2404.17306](#).
- [HLMR24b] Jędrzej Hodor, Hoang La, Piotr Micek, and Clément Rambaud. Weak coloring numbers of minor-closed graph classes. *arXiv preprint*, 2024. [arXiv:2407.04588](#).
- [NOdM12] Jaroslav Nešetřil and Patrice Ossona de Mendez. *Sparsity: Graphs, Structures, and Algorithms*. Springer Berlin Heidelberg, 2012.
- [PPT23a] Christophe Paul, Evangelos Protopapas, and Dimitrios M. Thilikos. Graph parameters, universal obstructions, and WQO. *arXiv preprint*, 2023. [arXiv:2304.03688](#).
- [PPT23b] Christophe Paul, Evangelos Protopapas, and Dimitrios M. Thilikos. An overview of universal obstructions for graph parameters. *arXiv preprint*, 2023. [arXiv:2304.14121](#).
- [Ram97] Siddharthan Ramachandramurthi. The structure and number of obstructions to treewidth. *SIAM Journal on Discrete Mathematics*, 10(1):146–157, 1997.
- [RS] Neil Robertson and Paul Seymour. Graph width and well-quasi-ordering. unpublished.
- [RS86] Neil Robertson and Paul Seymour. Graph minors. V. Excluding a planar graph. *Journal of Combinatorial Theory, Series B*, 41(1):92–114, 1986.
- [Tho90] Robin Thomas. A menger-like property of tree-width: The finite case. *Journal of Combinatorial Theory, Series B*, 48(1):67–76, 1990.