

This is a preprint of a paper whose final and definite form is published in 'Evolution Equations and Control Theory' at <http://dx.doi.org/10.3934/eect.2025018>.

---

## FRACTIONAL DIFFERENTIAL EQUATIONS OF A REACTION-DIFFUSION SIR MODEL INVOLVING THE CAPUTO-FRACTIONAL TIME-DERIVATIVE AND A NONLINEAR DIFFUSION OPERATOR

ACHRAF ZINIHI<sup>✉\*1</sup>, MOULAY RCHID SIDI AMMI<sup>✉1</sup>  
AND DELFIM F. M. TORRES<sup>✉2</sup>

<sup>1</sup>Department of Mathematics, MAIS Laboratory,  
AMNEA Group, Faculty of Sciences and Technics,  
Moulay Ismail University of Meknes, Errachidia 52000, Morocco

<sup>2</sup>Center for Research and Development in Mathematics and Applications (CIDMA),  
Department of Mathematics, University of Aveiro, 3810-193 Aveiro, Portugal

(Communicated by Arran Fernandez)

**ABSTRACT.** The main aim of this study is to analyze a fractional parabolic SIR epidemic model of a reaction-diffusion, by using the nonlocal Caputo fractional time-fractional derivative and employing the  $p$ -Laplacian operator. The immunity is imposed through the vaccination program, which is regarded as a control variable. Finding the optimal control pair that reduces the number of sick people, the associated vaccination, and treatment expenses across a constrained time and space is our main study. The existence and uniqueness of the nonnegative solution for the spatiotemporal SIR model are established. It is also demonstrated that an optimal control exists. In addition, we obtain a description of the optimal control in terms of state and adjoint functions. Then, the optimality system is resolved by a discrete iterative scheme that converges after an appropriate test, similar to the forward-backward sweep method. Finally, numerical approximations are given to show the effectiveness of the proposed control program, which provides meaningful results using different values of the fractional order and  $p$ , respectively the order of the Caputo derivative and the  $p$ -Laplacian operators.

**1. Introduction.** Fractional calculus is an ancient subject that arose as a result of a relevant question that l'Hôpital asked Leibniz in a letter about the possible meaning of a derivative of order 0.5 [26]. Recently, many researchers have focused their attention on modeling real phenomena using fractional derivatives. The dynamics of these problems were modeled and studied using the concept of fractional derivatives. Such problems arise, for example, in biology, epidemiology, physics, ecology, engineering, and various other areas of applied science [22, 29].

In the literature of fractional calculus, systems that use fractional derivatives can exhibit a more believable behavior [18, 32, 40]. Fractional derivatives have many

---

2020 *Mathematics Subject Classification.* Primary: 26A33, 49J20; Secondary: 47J05, 34K37, 65D15.

*Key words and phrases.* Fractional differential equations, epidemic model, Caputo fractional derivatives,  $p$ -Laplacian operator, optimal control, numerical approximations.

\*Corresponding author: Achraf Zinihi.

different definitions [18], the most well-known being the Riemann–Liouville and the Caputo fractional derivatives. The first is not always relevant for modeling biological and physical systems, due to the fact that the fractional derivative of a constant is different from zero. Moreover, initial conditions of Cauchy problems are represented through fractional derivatives. In contrast, Caputo derivatives offer an alternative where initial conditions are presented as in the classical integer-order case and a constant’s fractional derivative is zero [10, 18].

Fractional derivatives that possess a nonsingular kernel have also generated a large interest from researchers. This is due to nonsingular memory and also for not obeying the algebraic standards of bonding and switching the Mittag–Leffler function. The Caputo–Fabrizio fractional time-derivative in the Caputo sense is sometimes preferred for modeling biological, physical, or chemical dynamic systems, by describing diffusion and heterogeneity phenomena at various scales in a clear and concise manner [24, 33].

Mathematical models play an important role in modeling epidemiological phenomena to describe the dynamic behavior of these phenomena, analyzing them, and combating their spread, especially infectious diseases [4, 14, 34, 45]. The SIR epidemic model presented by [21] is the first mathematical model and one of the most significant pandemic models since its birth in 1927. The population in this model is divided into three compartments for the pathological condition. In the first category, susceptible individuals  $S$  represent those who have not yet contracted the disease but are at risk of doing so. Infected individuals  $I$  describe the persons who have contracted the disease and are able to spread it to those who are susceptible. The third and last compartment are the recovered, denoted by  $R$ , that represents individuals who have acquired immunity and become immune to the disease. Recently, the classic SIR model was adopted to design many infectious diseases, such as those spread from coronaviruses [3, 7, 12, 20, 30].

A series of statistical studies, in several parts of the world, have confirmed that the movement of individuals has a significant negative impact on the spread of diseases. One can support this idea by mentioning the SARS-CoV-2 virus that killed thousand of people, as the COVID-19 pandemic has led to disturbance problems and crises in most areas in the world [15]. A statistical analysis on the Ebola virus in Western Africa has addressed how the geographical effect has affected the disease’s transmission in this area [25]. According to a different study, the prevalence of H1N1, a subtype of influenza  $A$  virus, an infectious viral disease that causes upper respiratory tract infections and, in some cases, also lower respiratory tract inflammation, and results in symptoms such as chills, nasal secretions, low appetite, and fever, is very sensitive to people’s mobility [9].

Today’s mobility of individuals is increasingly affecting the spread of diseases, because of the high urban population density and abundance of transportation options (high number of means of transport), as a result of scientific and technological development, and the need for people’s mobility for various reasons, including studying, tourism, trade, work, etc. Therefore, the spatial factor plays an important role in disease transmission. To include the spatial effect in our biological system, and taking into account recent works that used PDEs to model the mobility of people, the symbol  $(x, t)$  in our model describes spatial diffusion on time  $t$  and space  $x$  [13, 28, 36, 41, 43].

In recent years, there has been a growing interest in incorporating fractional calculus and nonlinear operators into mathematical models to provide more accurate

and realistic descriptions of complex phenomena. When considering the SIR epidemic model, utilizing the Caputo fractional time-derivative and the  $p$ -Laplacian operator can offer several motivations. Unlike the traditional SIR model, the Caputo ( $\mathcal{C}$ , for short) fractional derivative allows us to account for nonlocal and long-range interactions, mirroring the complex and interconnected nature of real-world epidemics. It introduces memory effects, capturing the influence of past infections on current transmission probabilities, which is crucial for diseases with varying infection histories. This approach also accommodates anomalous diffusion patterns often observed in epidemiology, providing a more versatile framework to model outbreaks. By embracing the  $\mathcal{C}$ -fractional derivative, we can better predict long-term epidemic trends, improve parameter estimation, and contribute to more accurate and adaptable epidemiological modeling that can help shape effective public health strategies in an ever-evolving landscape of infectious diseases. Secondly, the diffusion operator, which is a nonlinear generalization of the Laplace operator, offers advantages when modeling the interactions between infected and susceptible individuals. The  $p$ -Laplacian operator considers the heterogeneity and nonlinearity inherent in epidemic dynamics. In the context of the SIR model, it allows for a more realistic representation of the varying susceptibility and infectiousness levels among individuals, leading to a better understanding of the overall epidemic behavior. Furthermore, the combined use of the  $\mathcal{C}$ -fractional time-derivative and the diffusion operator into the SIR model can provide insights into the long-term behavior and stability of the system. Fractional calculus provides a broader perspective on the dynamics, allowing for the analysis of fractional order differential equations. This can help to reveal novel phenomena and uncover additional aspects of the epidemic spread that are not captured by traditional integer-order models. The inclusion of the second operator further enhances the model's ability to capture complex interactions and nonlinear effects, potentially leading to more accurate predictions and control strategies for epidemic outbreaks. In summary, the introduction of the  $\mathcal{C}$ -fractional time-derivative and the specific diffusion operator into the SIR epidemic model provides a multitude of compelling motivations. These modifications enable the consideration of memory effects, capture nonlinear interactions, and provide a deeper understanding of the long-term behavior of epidemics. By embracing these advanced mathematical tools, researchers can enhance the accuracy and realism of their models, ultimately contributing to improved strategies for mitigating and controlling infectious diseases. Nevertheless, several challenges have arisen during the course of our study. The nonlinearity introduced by the second operator has made it considerably challenging to establish the existence of a solution for our problem. Furthermore, we have encountered significant difficulties in formulating the adjoint system associated with our proposed problem and, subsequently, in deriving optimality conditions. Additionally, the discretization of the problem for obtaining numerical results has presented its own set of challenges.

In the existing literature, several studies have explored FDEs or ODEs for epidemic modeling, but they typically do not incorporate PDEs to model spatial dynamics. While some works combine fractional derivatives with PDEs, they usually involve linear operators, which limit their ability to capture the complex, nonlinear dynamics observed in epidemic spread. For instance, studies like [3, 8, 16, 27, 44] focus on FDE/ODE models, and others, such as [17, 36, 37, 43] discuss PDE-based approaches without the inclusion of fractional time derivatives or the  $p$ -Laplacian operator. In contrast, our approach uniquely combines fractional time derivatives

with a PDE framework, using the  $p$ -Laplacian operator to model the spatial and temporal dynamics of disease spread more effectively. This combination allows us to capture important features such as spatial heterogeneities and memory effects, which are not adequately addressed in traditional models that rely solely on ODEs or linear operators. Our work, therefore, offers a novel perspective by integrating these components to better simulate the real-world spread of infectious diseases.

Due to the diverse nature of these operators, numerous scholars and experts have contributed to the scientific literature in various domains. These include, but are not limited to, the fields of biology [37, 43], quantum theory [35], and continuum mechanics [6]. This widespread interest and application in different scientific disciplines underline the broad and versatile impact of these operators on the research landscape. As an illustration, it is worth noting that Tao and Li considered a chemotaxis-Stokes system with slow  $p$ -Laplacian diffusion, with  $\Omega$  a bounded smooth domain in  $\mathbb{R}^3$  [39]. Authors in [37] analyzed a reaction-diffusion SIR epidemic model, formulated as a parabolic system of partial differential equations with the integration of the  $p$ -Laplacian operator, underscoring the critical role of vaccination distribution as a means to induce immunity. The central focus of their research is to develop an optimal control strategy, meticulously designed to curtail both the spread of infection and the cost associated with vaccination within a defined spatiotemporal framework. This leads to many questions to be discussed in this work, such as:

- (i) What relation can be observed between the diffusion factor  $p$  and the fractional order of differentiation  $\alpha$ ?
- (ii) During a period of vaccination, has the spread of the infection been successfully contained?

In this work, we introduce a novel approach to address an optimal control problem involving reaction-diffusion systems. Additionally, we explore its potential application in the field of surveillance, where we integrate the spatial behavior of the population and the control term that represents the vaccination program. This is a powerful tool that can prevent and control the infection's spread. Our principal motivation is to investigate and analyze the impact of a vaccination program on infection-related disease transmission, in the context of our more accurate model that accounts spatial diffusion.

The paper is organized as follows. Crucial definitions related to  $\mathcal{C}$ -fractional calculus, the  $p$ -Laplacian operator, and their fundamental properties, are given in Section 2. Section 3 introduces the fractional optimal control of the SIR model in the context of reaction-diffusion while, in Sections 4 and 5, we establish the existence and uniqueness of a nonnegative solution and we prove the existence of an optimal solution for our proposed model. Furthermore, Section 6 is dedicated to establish necessary optimality conditions. Before closing the present study, insightful numerical approximations that elucidate the relationship between variations in  $p$  and  $\alpha$  and the disease's propagation, are explained in Section 7. Finally, we provide a concise summary of our study in Section 8.

**2. Notations and preliminaries.** In this section we recall some definitions and properties about the fractional integral, the  $\mathcal{C}$ -fractional time-derivative, and the  $p$ -Laplacian operator, that are needed in the sequel. Let  $\mathcal{T} > 0$ ,  $f \in H^1(0, \mathcal{T})$ ,  $\alpha \in (0, 1)$ ,  $p \geq 2$ , and  $\Omega$  denote a bounded and fixed domain of  $\mathbb{R}^2$  with a smooth boundary referred to as  $\partial\Omega$ .

**Definition 2.1** (See [22]). If  $\omega \in \mathbb{C}$  is such that  $Re(\omega) > 0$ , then the Gamma function is given by

$$\Gamma(\omega) := \int_0^{+\infty} e^{-t} t^{\omega-1} dt.$$

**Definition 2.2** (See [22]).

- (a) The  $\mathcal{C}$ -fractional derivative of  $f$  with base point 0 of order  $\alpha$  is defined at point  $t$  by

$${}^{\mathcal{C}}\mathcal{D}_t^\alpha f(t) = \frac{1}{\Gamma(1-\alpha)} \int_0^t (t-y)^{-\alpha} f'(y) dy. \quad (1)$$

- (b) The backward  $\mathcal{C}$ -fractional derivative with base point  $\mathcal{T}$ , is defined by

$${}_{\mathcal{T}}^{\mathcal{C}}\mathcal{D}_t^\alpha f(t) = \frac{-1}{\Gamma(1-\alpha)} \int_t^{\mathcal{T}} (y-t)^{-\alpha} f'(y) dy. \quad (2)$$

**Remark 2.3.** If we let  $\alpha \rightarrow 1$  in (1), then we obtain the usual derivative  $\partial_t$ .

**Definition 2.4** (See [22]). The fractional integral operator with base point 0 is written as

$$I^\alpha f(t) = \frac{1}{\Gamma(\alpha)} \int_0^t (t-y)^{\alpha-1} f(y) dy. \quad (3)$$

**Lemma 2.5** (See [1]). Let  $\varphi : [0, \mathcal{T}] \rightarrow L^2(\Omega)$ . Assume that there exists the fractional derivative of  $\varphi$  in the Caputo sense. Then

$$({}^{\mathcal{C}}\mathcal{D}_t^\alpha \varphi(t), \varphi(t))_{L^2(\Omega)} \geq \frac{1}{2} {}^{\mathcal{C}}\mathcal{D}_t^\alpha \|\varphi(t)\|_{L^2(\Omega)}^2. \quad (4)$$

**Remark 2.6.** Let  $g \in H^1(0, T)$ . If  $f \geq g$ , then

$$I^\alpha f(t) \geq I^\alpha g(t). \quad (5)$$

**Lemma 2.7** (See [22]). One has

$$I^\alpha ({}^{\mathcal{C}}\mathcal{D}_t^\alpha f(t)) = f(t) - f(0). \quad (6)$$

The last part of this section is about the  $p$ -Laplacian operator. Recall that the constant  $k$  may change in each mathematical expression. Let  $\psi$  be a function defined on  $\mathbb{R}^2 \rightarrow \mathbb{R}^2$  by

$$\psi(w) = |w|^{p-2} w, \quad \forall w \in \mathbb{R}^2.$$

The  $p$ -Laplacian operator is written as

$$\Delta_p : \begin{array}{l} W_0^{1,p}(\Omega) \longrightarrow W^{-1,p'}(\Omega) \\ u \longrightarrow \Delta_p u = \operatorname{div}(\psi(\nabla u)) : \end{array} \quad \begin{array}{l} W_0^{1,p}(\Omega) \longrightarrow \mathbb{R} \\ v \longrightarrow \langle \Delta_p u, v \rangle, \end{array}$$

where  $\langle \cdot, \cdot \rangle$  is the duality product between  $W_0^{1,p}(\Omega)$  and  $W^{-1,p'}(\Omega)$ . Besides, by the Green formula, and with the homogeneous boundary conditions, we have

$$\langle -\Delta_p u, v \rangle = \int_{\Omega} |\nabla u|^{p-2} \nabla u \cdot \nabla v dx$$

and

$$\|\Delta_p u\|_{W^{-1,p'}(\Omega)} = \|u\|_{W_0^{1,p}(\Omega)}.$$

**3. Mathematical model.** Numerous studies in the epidemiological literature have utilized optimal control theory to examine how vaccination and treatment affect the spread of infectious diseases [27, 38, 42]. The mentioned strategies are used to reduce the spread of the pandemic or to gain lasting immunity in individuals, by analyzing likely the consequences of the vaccine given to vulnerable individuals and the treatment provided to infected people. We assume that the total population  $N$  comprises three subgroups: Susceptible, Infectious, and Removed individuals. Having introduced these three compartments, a reaction-diffusion SIR epidemic model can be constructed as follows:

$$\begin{cases} {}^c\mathcal{D}_t^\alpha S = \lambda_1 \Delta_p S + \beta N - \mu SI - \xi S, \\ {}^c\mathcal{D}_t^\alpha I = \lambda_2 \Delta_p I + \mu SI - (\xi + \kappa)I, \\ {}^c\mathcal{D}_t^\alpha R = \lambda_3 \Delta_p R + \kappa I - \xi R, \end{cases} \quad (x, t) \in \Omega_{\mathcal{T}}, \quad (7)$$

where  ${}^c\mathcal{D}_t^\alpha$  is the  $\mathcal{C}$ -fractional derivative with base point 0 of order  $\alpha$  and  $\mathcal{T} > 0$ . Table 1 provides the transmission coefficients relevant to the SIR model.

TABLE 1. Transmission coefficients.

$\beta$	Birth rate	$\xi$	Natural mortality rate
$\mu$	Effective contact rate	$\kappa$	Removal rate

The term  $\mu SI$  describes the number of individuals at risk of contracting the disease (newly infected people) that are being infected by persons from category  $I$ , and  $\kappa I$  models the infected individuals that recover without intervention. As highlighted in Section 1, it is crucial to consider the spatial dimension when studying disease propagation. To describe this effect, we introduce specific terms that characterize spatial diffusion. This will involve the inclusion of diffusion operators, denoted as  $\Delta_p S$ ,  $\Delta_p I$ , and  $\Delta_p R$ , with  $\lambda_1, \lambda_2, \lambda_3 > 0$  representing the diffusion coefficients for the susceptible, infected, and recovered populations, respectively. Taking into account the assumptions outlined above, we get the mathematical model (7).

In the sequel we introduce a control function  $u$  (vaccination), assuming that all susceptible individuals that are vaccinated are transferred directly to the category that has been removed, as depicted in Figure 1.

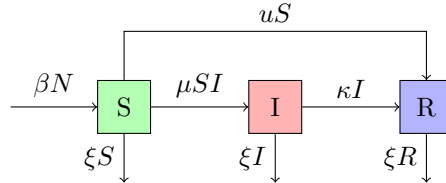

FIGURE 1. Visual representation of the control system (8).

Mathematically, we obtain the control system defined by

$$\begin{cases} {}^c\mathcal{D}_t^\alpha S = \lambda_1 \Delta_p S + \beta N - \mu SI - \xi S - uS, \\ {}^c\mathcal{D}_t^\alpha I = \lambda_2 \Delta_p I + \mu SI - (\xi + \kappa)I, \\ {}^c\mathcal{D}_t^\alpha R = \lambda_3 \Delta_p R + \kappa I - \xi R + uS, \end{cases} \quad \text{in } \Omega_{\mathcal{T}} = \Omega \times [0, \mathcal{T}], \quad (8)$$

with the Neumann boundary conditions

$$\nabla S \cdot \vec{n} = \nabla I \cdot \vec{n} = \nabla R \cdot \vec{n} = 0, \quad \text{on } \partial\Omega_{\mathcal{T}} = \partial\Omega \times [0, \mathcal{T}]. \quad (9)$$

These conditions are influenced by the normal  $\vec{n}$  to the boundary  $\partial\Omega$ , and

$$S(x, 0) = S_0, \quad I(x, 0) = I_0, \quad R(x, 0) = R_0, \quad \text{in } \Omega. \quad (10)$$

According to the no-flux boundary conditions, there is no emigration, and system (8)–(10) is self-contained and features all dynamic interactions across borders, while the initial conditions are considered positive for biological reasons.

We now introduce an optimal control problem: to minimize the objective functional

$$\mathcal{J}(S, I, R, u) = \|I(\cdot, \mathcal{T})\|_{L^2(\Omega)}^2 + \|I\|_{L^2(\Omega_{\mathcal{T}})}^2 + \eta \|u\|_{L^2(\Omega_{\mathcal{T}})}^2, \quad (11)$$

where  $\eta$  is a weight constant used to control the vaccination rate, and

$$u \in U_{ad} = \{v \in L^\infty(\Omega_{\mathcal{T}}) / \|v\|_{L^\infty(\Omega_{\mathcal{T}})} < 1 \text{ and } v > 0\}. \quad (12)$$

We choose the norms  $\|\cdot\|_{L^2(\Omega_{\mathcal{T}})}$  and  $\|\cdot\|_{L^2(\Omega)}$  in (11) because the associated spaces are Hilbert spaces, which will allow us to explore, in Section 6, the differentiability aspects of  $\mathcal{J}$  in Gâteaux sense, based on the scalar products defined in the previously introduced Hilbert spaces.

Let  $\nu = (\nu_1, \nu_2, \nu_3) = (S, I, R)$ ,  $\nu^0 = (\nu_1^0, \nu_2^0, \nu_3^0) = (S_0, I_0, R_0)$ , and  $\lambda = (\lambda_1, \lambda_2, \lambda_3)$ . Put  $\mathcal{W}(\Omega) = \left(W_0^{1,p}(\Omega)\right)^3$  with  $\mathcal{W}'(\Omega)$  its dual and  $\mathcal{H}(\Omega) = (L^2(\Omega))^3$ . We consider the vector function  $\Psi$  defined by

$$\Psi(\nu(t)) = (\Psi_1(\nu(t)), \Psi_2(\nu(t)), \Psi_3(\nu(t))),$$

with  $\nu(t)(\cdot) = \nu(t, \cdot)$  and

$$\begin{cases} \Psi_1(\nu(t)) = \beta(\nu_1 + \nu_2 + \nu_3) - \mu\nu_1\nu_2 - (\xi + u)\nu_1, \\ \Psi_2(\nu(t)) = \mu\nu_1\nu_2 - (\xi + \kappa)\nu_2, \\ \Psi_3(\nu(t)) = \kappa\nu_2 - \xi\nu_3 + u\nu_1. \end{cases} \quad t \in [0, \mathcal{T}], \quad (13)$$

Let  $\mathcal{L}$  be the nonlinear operator

$$\mathcal{L} : \begin{array}{l} D(\mathcal{L}) \subset \mathcal{W}(\Omega) \rightarrow \mathcal{W}'(\Omega) \\ y \rightarrow -\lambda \Delta_p y \end{array}, \quad (14)$$

$$D(\mathcal{L}) = \left\{ \omega \in \mathcal{W}(\Omega) / \nabla \omega_i \cdot \vec{n} = 0 \text{ on } \partial\Omega, i = 1, 2, 3 \right\}.$$

Then (8)–(10) can be rewritten in the form

$$\begin{cases} {}^c \mathcal{D}_t^\alpha \nu(t) + \mathcal{L}\nu(t) = \Psi(\nu(t)), \\ \nu(0) = \nu^0. \end{cases} \quad t \in [0, \mathcal{T}]. \quad (15)$$

**4. Existence and uniqueness of solution.** In this section, we establish the existence and uniqueness of a solution to the nonlinear fractional system (8)–(10). For that we apply the Faedo–Galerkin method.

To prove the existence of a solution for system (15), we commence by introducing the crucial notion of weak solution.

**Definition 4.1.** We say that  $\nu$  is a weak solution for problem (15) if it satisfies the initial condition  $\nu(0) = \nu^0$  and the following equality:

$$\langle {}^c \mathcal{D}_t^\alpha \nu, \varphi \rangle + \langle \mathcal{L}\nu, \varphi \rangle - \langle \Psi(\nu), \varphi \rangle = 0, \quad \forall \varphi \in L^p(0, \mathcal{T}; \mathcal{W}(\Omega)).$$

**Lemma 4.2** (See [19]). *If  $\nu, \varphi \in C^\infty(\Omega_{\mathcal{T}})$ , then*

$$\begin{aligned} \int_0^{\mathcal{T}} ({}^c\mathcal{D}_t^\alpha \nu) \varphi dt &= \int_0^{\mathcal{T}} \nu ({}^c_{\mathcal{T}}\mathcal{D}_t^\alpha \varphi) dt + \frac{1}{\Gamma(1-\alpha)} \varphi(x, \mathcal{T}) \int_0^{\mathcal{T}} \nu(t) (\mathcal{T}-t)^{-\alpha} dt \\ &\quad - \frac{1}{\Gamma(1-\alpha)} \nu(x, 0) \int_0^{\mathcal{T}} \varphi(t) t^{-\alpha} dt. \end{aligned}$$

Our first result asserts the existence of a weak solution for problem (15).

**Theorem 4.3.** *Let  $\nu^0 \in L^2(\Omega)$ . Problem (15) possesses at least one weak solution within the spaces  $L^\infty(0, \mathcal{T}; \mathcal{H}(\Omega)) \cap L^p(0, \mathcal{T}; \mathcal{W}(\Omega))$ .*

*Proof.* Consider a basis  $\{e_j\}_{j \in \mathbb{N}}$  belonging to the space  $\mathcal{W}(\Omega)$ , where each  $e_j$  is a smooth function defined in  $\Omega$ . We aim to prove that the finite-dimensional approximation solutions  $(\vartheta_m(t))_{m \in \mathbb{N}}$  converge to the exact one, where

$$\vartheta_m(t) = \sum_{j=1}^m \omega_j(t) e_j.$$

These approximated solutions correspond to the solutions of the following approximate system:

$$\begin{cases} \langle {}^c\mathcal{D}_t^\alpha \vartheta_m, e_j \rangle + \langle \mathcal{L} \vartheta_m, e_j \rangle = \langle \Psi(\vartheta_m), e_j \rangle, & t > 0, \quad j = 1, \dots, m, \\ \vartheta_m(0) = \sum_{j=1}^m \omega_j(0) e_j =: \vartheta_m^0, \end{cases} \quad (16)$$

where  $\omega_j(t) = \omega_m^j(t)$ . Since  $\mathcal{L}$  is a bounded operator and the determinant  $\det(\langle e_j, e_l \rangle)_{j \neq l}$  is nonzero (due to  $\{e_j\}_{j \in \mathbb{N}}$  forming a basis of  $\mathcal{W}(\Omega)$ ), coupled with the continuity of  $\Psi$  as a function, it follows, based on the results of [2, 11], that problem (16) possesses at least one local solution within the interval  $[0, \mathcal{T}_m)$ , where  $\mathcal{T}_m > 0$ . In addition, (16) can be rewritten in the form

$${}^c\mathcal{D}_t^\alpha \omega_k(t) = -\lambda \int_{\Omega} |\nabla \vartheta_m|^{p-2} \nabla \vartheta_m \cdot \nabla e_k dx + \int_{\Omega} \Psi(\vartheta_m) e_k dx =: G_k(t) \quad (17)$$

with  $1 \leq k \leq m$ . By applying the fractional integral (6) to (17), we obtain

$$\omega_k(t) = \omega_k(0) + \frac{1}{\Gamma(\alpha)} \int_0^t (t-s)^{\alpha-1} G_k(s) ds. \quad (18)$$

We proceed by showing the extensibility of this approximate solution over the entire temporal interval  $[0, \mathcal{T}]$ . To achieve this, we multiply equation (16) by  $\omega_i(t)$ , sum up over  $i = 1, \dots, m$ , and employ the Green formula alongside (4), yielding

$$\frac{1}{2} {}^c\mathcal{D}_t^\alpha \|\vartheta_m\|_{\mathcal{H}(\Omega)}^2 + \lambda \int_{\Omega} |\nabla \vartheta_m|^p dx \leq \int_{\Omega} \Psi(\vartheta_m) \vartheta_m dx. \quad (19)$$

Using (5) and (6), we get

$$\begin{aligned} \|\vartheta_m(t)\|_{\mathcal{H}(\Omega)}^2 &\leq \|\vartheta_m(0)\|_{\mathcal{H}(\Omega)}^2 - \frac{2\lambda}{\Gamma(\alpha)} \int_0^t \int_{\Omega} (t-s)^{\alpha-1} |\nabla \vartheta_m(s)|^p dx ds \\ &\quad + \frac{2}{\Gamma(\alpha)} \int_0^t \int_{\Omega} (t-s)^{\alpha-1} \Psi(\vartheta_m(s)) \vartheta_m(s) dx ds. \end{aligned} \quad (20)$$

Starting from equation (16), we derive the following relationship:

$${}^c\mathcal{D}_t^\alpha N_m = \mathcal{L} \vartheta_m^1 + \mathcal{L} \vartheta_m^2 + \mathcal{L} \vartheta_m^3 + \beta N_m - \xi N_m,$$



where  $N_m = \vartheta_m^1 + \vartheta_m^2 + \vartheta_m^3$ . Given that  $\mathcal{L}$  is a bounded operator, we can establish the existence of a constant  $C$  such that

$${}^c\mathcal{D}_t^\alpha \|N_m\|_{L^2(\Omega)} \leq (C + \beta - \xi) \|N_m\|_{L^2(\Omega)}.$$

Utilizing (5) and (6), we can obtain that

$$\|N_m\|_{L^2(\Omega)} \leq \|N_m^0\|_{L^2(\Omega)} + \frac{C + \beta - \xi}{\Gamma(\alpha)} \int_0^t (t-s)^{\alpha-1} \|N_m(s)\|_{L^2(\Omega)} ds.$$

Applying the Gronwall inequality, we conclude with

$$\begin{aligned} \|N_m\|_{L^2(\Omega)} &\leq \|N_m^0\|_{L^2(\Omega)} \exp \left[ \frac{C + \beta - \xi}{\Gamma(\alpha)} \int_0^t (t-s)^{\alpha-1} ds \right] \\ &\leq \|N_m^0\|_{L^2(\Omega)} \exp \left[ \frac{C + \beta - \xi}{\Gamma(\alpha)} \frac{t^\alpha}{\alpha} \right] < \infty. \end{aligned}$$

This establishes the boundedness of  $(\vartheta_m)_m$  within  $\mathcal{H}(\Omega)$ . In other words, the second term  $\Psi$  is a member of  $\mathcal{H}(\Omega)$  with respect to  $t \in [0, T_m)$ . Consequently, by (20), there exist positive constants  $c_1$  and  $c_2$  that allow us to express the inequality

$$\|\vartheta_m(t)\|_{\mathcal{H}(\Omega)}^2 \leq \|\vartheta_m(0)\|_{\mathcal{H}(\Omega)}^2 + c_1 t + c_2. \quad (21)$$

Accordingly, we can confidently broaden the scope of our approximate solution to encompass the entirety of the temporal interval  $[0, \mathcal{T}]$ . As a result, we obtain that

$$\|\vartheta_m\|_{L^\infty(0, \mathcal{T}; \mathcal{H}(\Omega))} \leq c. \quad (22)$$

Given that  $W_0^{1,p}(\Omega)$  is compactly embedded in  $L^p(\Omega) \subseteq L^2(\Omega)$ , we deduce that the sequence  $(\vartheta_m^i)_{i=1,2,3}$  is also compact within  $L^2(\Omega)$ . Considering now the inequality (22), and knowing that  $\mathcal{L}$  is a bounded operator, we establish the existence of a subsequence  $(\vartheta_m)$ , denoted again as  $(\vartheta_m)$ , such that the following weak convergence relations hold:

$$\begin{aligned} \vartheta_m &\rightharpoonup \nu \text{ weak-star in } L^\infty(0, \mathcal{T}; \mathcal{H}(\Omega)), \\ \mathcal{L}\vartheta_m &\rightharpoonup \chi \text{ weakly in } L^{p'}(0, \mathcal{T}; \mathcal{W}'(\Omega)), \\ \vartheta_m &\rightharpoonup \nu \text{ weakly in } L^p(0, \mathcal{T}; \mathcal{W}(\Omega)), \\ \vartheta_m &\longrightarrow \nu \text{ strongly in } \mathcal{H}(\Omega_{\mathcal{T}}), \\ \vartheta_m &\longrightarrow \nu \text{ a.e. in } \mathcal{H}(\Omega_{\mathcal{T}}). \end{aligned} \quad (23)$$

Expressing  $\vartheta_m^1 \vartheta_m^2 - \nu_1 \nu_2$  as  $(\vartheta_m^1 - \nu_1) \vartheta_m^2 + \nu_1 (\vartheta_m^2 - \nu_2)$ , and considering the convergences (23), we can utilize (22) to conclude that  $\vartheta_m^1 \vartheta_m^2 \rightharpoonup \nu_1 \nu_2$  weakly in  $L^p(0, \mathcal{T}; W_0^{1,p}(\Omega))$ . This implies that

$$\Psi(\vartheta_m) \rightharpoonup \Psi(\nu) \text{ weakly in } L^p(0, \mathcal{T}; \mathcal{W}(\Omega)). \quad (24)$$

Note that the space  $D'(\Omega_{\mathcal{T}})$  is the dual of  $C_0^\infty(\Omega_{\mathcal{T}})$ . If  $\varphi \in C_0^\infty(\Omega_{\mathcal{T}})$ , then

$$\begin{aligned} \int_0^{\mathcal{T}} \int_\Omega \vartheta_m ({}^c\mathcal{D}_t^\alpha \varphi) dx dt &\longrightarrow \int_0^{\mathcal{T}} \int_\Omega \nu ({}^c\mathcal{D}_t^\alpha \varphi) dx dt, \\ \int_\Omega \varphi(x, \mathcal{T}) \int_0^{\mathcal{T}} \vartheta_m(t) (\mathcal{T} - t)^{-\alpha} dt dx &\longrightarrow \int_\Omega \varphi(x, \mathcal{T}) \int_0^{\mathcal{T}} \nu(t) (\mathcal{T} - t)^{-\alpha} dt dx, \end{aligned}$$

and

$$\frac{1}{\Gamma(1-\alpha)} \vartheta_m(x, 0) \int_0^{\mathcal{T}} \varphi(t) t^{-\alpha} dt \longrightarrow \frac{1}{\Gamma(1-\alpha)} \nu(x, 0) \int_0^{\mathcal{T}} \varphi(t) t^{-\alpha} dt.$$

By Lemma 4.2, and according to the initial conditions of (16), we find that

$${}^c\mathcal{D}_t^\alpha \vartheta_m \rightharpoonup {}^c\mathcal{D}_t^\alpha \nu \text{ weakly in } D'(\Omega_T). \quad (25)$$

The remaining step is to prove that  $\mathcal{L}\nu = \chi$ . Recall that  $\mathcal{L}$  is of type  $M$ , that is, if  $\vartheta_m \rightharpoonup \nu$ ,  $\mathcal{L}\vartheta_m \rightharpoonup \chi$ , and  $\limsup_{m \rightarrow \infty} \langle \mathcal{L}\vartheta_m, \vartheta_m \rangle \leq \chi(\nu)$ , then  $\mathcal{L}\nu = \chi$ . Hence, we have

$$\limsup_{m \rightarrow \infty} \langle \mathcal{L}\vartheta_m, \vartheta_m \rangle \leq \langle \chi, \nu \rangle.$$

Due to the monotonicity of  $\mathcal{L}$ , we can observe that for all  $\vartheta_m, \omega \in D(\mathcal{L})$

$$\begin{aligned} D_m &= \int_0^T \langle \mathcal{L}\vartheta_m - \mathcal{L}\omega, \vartheta_m - \omega \rangle dt \\ &= \int_0^T \langle \mathcal{L}\vartheta_m, \vartheta_m \rangle dt - \int_0^T \langle \mathcal{L}\vartheta_m, \omega \rangle dt - \int_0^T \langle \mathcal{L}\omega, \vartheta_m - \omega \rangle dt \geq 0. \end{aligned}$$

Therefore, we conclude that

$$\begin{aligned} \limsup_{m \rightarrow \infty} D_m &\leq \int_0^T \langle \chi, \nu \rangle dt - \int_0^T \langle \chi, \omega \rangle dt - \int_0^T \langle \mathcal{L}\omega, \nu - \omega \rangle dt \\ &\leq \int_0^T \langle \chi - \mathcal{L}\omega, \nu - \omega \rangle dt. \end{aligned}$$

Finally, we establish that

$$\int_0^T \langle \chi - \mathcal{L}\omega, \nu - \omega \rangle dt \geq 0.$$

Considering  $\delta > 0$ , we set  $\omega = \nu - \delta h \in D(\mathcal{L})$ . Since  $\mathcal{L}$  is hemicontinuous, that is, the function  $t \mapsto \langle \mathcal{L}(\nu_1 + t\nu_2), \nu_3 \rangle$  is continuous of  $\mathbb{R} \rightarrow \mathbb{R}$  for all  $\nu_1, \nu_2, \nu_3 \in W_0^{1,p}(\Omega)$ , we can state that

$$\delta \int_0^T \langle \chi - \mathcal{L}(\nu - \delta h), h \rangle dt \geq 0.$$

Consequently,

$$\langle \chi - \mathcal{L}(\nu - \delta h), h \rangle \geq 0.$$

As we let  $\delta \rightarrow 0$ , we find that

$$\langle \chi - \mathcal{L}\nu, h \rangle \geq 0, \quad \forall h \in D(\mathcal{L}),$$

and, subsequently,

$$\chi = \mathcal{L}\nu. \quad (26)$$

The proof is complete.  $\square$

We now prove uniqueness of solution.

**Theorem 4.4.** *A weak solution  $\nu$  of (15) is unique.*

*Proof.* Consider two weak solutions to problem (16),  $v$  and  $\bar{v}$ . Let us denote their difference by  $\omega = v - \bar{v}$ . We have

$${}^c\mathcal{D}_t^\alpha \omega + (\mathcal{L}v - \mathcal{L}\bar{v}) = (\Psi(v) - \Psi(\bar{v})),$$

with its associate initial data  $\omega^0 = v^0 - \bar{v}^0$ . Multiplying this equation by  $\omega$ , we obtain that

$$\langle {}^c\mathcal{D}_t^\alpha \omega, \omega \rangle + \langle \mathcal{L}v - \mathcal{L}\bar{v}, v - \bar{v} \rangle = \langle \Psi(v) - \Psi(\bar{v}), v - \bar{v} \rangle.$$

As stated in Theorem 4.3,  $\nu$  is constrained within the space  $\mathcal{H}(\Omega)$ . Thus, function  $\Psi$  is Lipschitz continuous in  $\nu$  uniformly with respect to  $t \in [0, \mathcal{T}]$  and the operator  $\mathcal{L}$  is monotone [5, 36, 37]. By (4), we get

$${}^c\mathcal{D}_t^\alpha \|\omega(t)\|_{\mathcal{H}(\Omega)}^2 \leq C \|\omega(t)\|_{\mathcal{H}(\Omega)}^2.$$

Using (5) and (6), we have

$$\|\omega(t)\|_{\mathcal{H}(\Omega)}^2 \leq \|\omega^0\|_{\mathcal{H}(\Omega)}^2 + \frac{C}{\Gamma(\alpha)} \int_0^t (t-s)^{\alpha-1} \|\omega(s)\|_{\mathcal{H}(\Omega)}^2 ds.$$

According to Gronwall's inequality, we conclude that

$$\|\omega(t)\|_{\mathcal{H}(\Omega)}^2 \leq \|\omega^0\|_{\mathcal{H}(\Omega)}^2 \exp \left[ \frac{C}{\Gamma(\alpha)} \int_0^t (t-s)^{\alpha-1} ds \right],$$

which completes the proof.  $\square$

**Theorem 4.5.** *The solution of (8)–(10) is positive.*

*Proof.* We begin by establishing the nonnegativity of  $I$ . Let us express  $I$  as the difference of its positive and negative components:

$$I = I^+ - I^-,$$

where

$$I^+(x, t) = \sup\{I(x, t), 0\} \quad \text{and} \quad I^-(x, t) = \sup\{-I(x, t), 0\}.$$

Now, by multiplying the second equation of the system (8)–(10) by  $I^-$ , and integrating over  $\Omega$ , we can use (4) to derive the inequality

$$\frac{1}{2} {}^c\mathcal{D}_t^\alpha \|I^-\|_{L^2(\Omega)}^2 + \lambda \int_{\Omega} |\nabla I|^{p-2} (\nabla I^-)^2 dx \leq \mu \int_{\Omega} S(I^-)^2 dx + (\xi + \kappa) \int_{\Omega} (I^-)^2 dx.$$

In simpler terms,

$$\frac{1}{2} {}^c\mathcal{D}_t^\alpha \|I^-\|_{L^2(\Omega)}^2 \leq \mu \int_{\Omega} S(I^-)^2 dx \leq \mu N \int_{\Omega} (I^-)^2 dx.$$

Utilizing (5) and (6), we can further simplify the inequality to

$$\|I^-\|_{L^2(\Omega)}^2 \leq \|I_0^-\|_{L^2(\Omega)}^2 + \frac{2\mu N}{\Gamma(\alpha)} \int_0^t (t-y)^{\alpha-1} \|I^-(y)\|_{L^2(\Omega)}^2 dy.$$

By applying Gronwall's inequality, we deduce that

$$\|I^-\|_{L^2(\Omega)}^2 \leq \|I_0^-\|_{L^2(\Omega)}^2 \exp \left[ \frac{2\mu N}{\Gamma(\alpha)} \int_0^t (t-y)^{\alpha-1} dy \right].$$

This implies that  $I^-$  must be zero and, therefore,  $I$  is positive. The same reasoning applies to  $R$ . By multiplying the third equation of (8)–(10) by  $R^-$ , one obtains

$$\begin{aligned} & \frac{1}{2} {}^c\mathcal{D}_t^\alpha \|R^-\|_{L^2(\Omega)}^2 + \lambda \int_{\Omega} |\nabla R|^{p-2} (\nabla R^-)^2 dx \\ & \leq \kappa \int_{\Omega} IR^- dx - \xi \int_{\Omega} (R^-)^2 dx + \int_{\Omega} uSR^- dx. \end{aligned}$$

This can be simplified as

$${}^c\mathcal{D}_t^\alpha \|R^-\|_{L^2(\Omega)}^2 \leq 2\kappa \int_{\Omega} IR^- dx + 2 \int_{\Omega} uSR^- dx.$$

As  $u$  belongs to  $U_{ad}$ , by the Cauchy–Schwarz inequality, there exists a constant  $C$  such that

$${}^c\mathcal{D}_t^\alpha \|R^-\|_{L^2(\Omega)}^2 \leq 2\kappa \|I\|_{L^2(\Omega)} \|R^-\|_{L^2(\Omega)} + 2C \|S\|_{L^2(\Omega)} \|R^-\|_{L^2(\Omega)}.$$

Because  $L^2(\Omega) \subset L^1(\Omega)$ , there exists a constant  $C$  such that

$${}^c\mathcal{D}_t^\alpha \|R^-\|_{L^2(\Omega)}^2 \leq C \left( \|I\|_{L^2(\Omega)}^2 + \|S\|_{L^2(\Omega)}^2 \right) \|R^-\|_{L^2(\Omega)}^2.$$

Now, with the help of (5) and (6), we can state that

$$\begin{aligned} & \|R^-\|_{L^2(\Omega)}^2 \\ & \leq \|R_0^-\|_{L^2(\Omega)}^2 \\ & \quad + \frac{C}{\Gamma(\alpha)} \int_0^t (t-y)^{\alpha-1} \left( \|I(y)\|_{L^2(\Omega)}^2 + \|S(y)\|_{L^2(\Omega)}^2 \right) \|R^-(y)\|_{L^2(\Omega)}^2 dy. \end{aligned}$$

Therefore,

$$\begin{aligned} & \|R^-\|_{L^2(\Omega)}^2 \\ & \leq \|R_0^-\|_{L^2(\Omega)}^2 \exp \left[ \frac{C}{\Gamma(\alpha)} \int_0^t (t-y)^{\alpha-1} \left( \|I(y)\|_{L^2(\Omega)}^2 + \|S(y)\|_{L^2(\Omega)}^2 \right) dy \right]. \end{aligned}$$

This leads to the conclusion that  $R^-$  must be zero and, consequently,  $R$  is nonnegative. Using the same methodology, we can establish that  $S$  is also positive.  $\square$

**5. Existence of an optimal solution.** To demonstrate the existence of an optimal control using the technique of minimizing sequences we make use of Lemma 5.1. Before, we recall the definition of the Mittag–Leffler function  $E_\alpha$ . Let  $\omega \in \mathbb{C}$  such that  $Re(\omega) > 0$ . Then,

$$E_\alpha(\omega) = \sum_{k=0}^{\infty} \frac{\omega^k}{\Gamma(\alpha k + 1)}. \quad (27)$$

**Lemma 5.1** (See [36]). *Let  $\omega \in L^\infty(0, \mathcal{T}; L^2(\Omega)) \cap H^1(0, \mathcal{T}; L^1(\Omega))$ , where  $b > 0$ . There exists a constant  $k > 0$  such that*

$$\frac{k}{E_\alpha(-\gamma \mathcal{T}^\alpha)} \|\omega\|_{L^\infty(0, \mathcal{T}; L^1(\Omega))} \geq \|\partial_t \omega\|_{L^1(0, \mathcal{T}; L^1(\Omega))},$$

where  $E_\alpha$  is the Mittag–Leffler function (27).

The primary result of this section can now be formulated and proved as follows.

**Theorem 5.2.** *Model (8)–(10) admits at least one optimal solution  $\nu^*(u^*)$  in  $(L^\infty(\Omega_{\mathcal{T}}))^3$  that minimizes (11).*

*Proof.* Let  $((\nu^n, u^n))_k$  be such that

$$\mathcal{J}(\nu^*, u^*) = \inf \{ \mathcal{J}(\nu, u) \} = \lim_{n \rightarrow \infty} \mathcal{J}(\nu^n, u^n),$$

where  $\nu^n = (\nu_i^n)_{i=1,2,3}$  and  $u^n \in U_{ad}$ . The pair  $(\nu^n, u^n)$  satisfies system

$$\begin{cases} {}^c\mathcal{D}_t^\alpha \nu_1^n = \mathcal{L}\nu_1^n + \mu(\nu_1^n + \nu_2^n + \nu_3^n) - \beta\nu_1^n \nu_2^n - \xi\nu_1^n - u^n \nu_1^n, \\ {}^c\mathcal{D}_t^\alpha \nu_2^n = \mathcal{L}\nu_2^n + \beta\nu_1^n \nu_2^n - (\xi + \kappa)\nu_2^n, \\ {}^c\mathcal{D}_t^\alpha \nu_3^n = \mathcal{L}\nu_3^n + \kappa\nu_2^n - \xi\nu_3^n + u^n \nu_1^n, \end{cases} \quad \text{in } \Omega_{\mathcal{T}}, \quad (28)$$

with the conditions

$$\nabla \nu_i^n \cdot \vec{n} = 0, \quad \text{on } \partial\Omega_{\mathcal{T}}, \quad i = 1, 2, 3, \quad (29)$$

and

$$\nu_i^n(0) = \nu_i^0, \quad \text{in } \Omega, \quad i = 1, 2, 3. \quad (30)$$

Let  $i \in \{1, 2, 3\}$ . According to Theorem 4.3, the sequence  $(\nu_i^n)$  is bounded in  $L^\infty(0, \mathcal{T}; \mathcal{H}(\Omega))$  and in  $L^p(0, \mathcal{T}; \mathcal{W}(\Omega))$ . Hence, there exists a positive constant  $c$  such that

$$\|{}^c\mathcal{D}_t^\alpha \nu_i^n - \mathcal{L}\nu_i^n\|_{L^2(\Omega_{\mathcal{T}})} \leq c.$$

As a result, there exists a subsequence of  $(\nu^n)$ , still denoted as  $(\nu^n)$ , such that

$$\begin{aligned} {}^c\mathcal{D}_t^\alpha \nu^n - \mathcal{L}\nu^n &\rightharpoonup \phi \text{ weakly in } \mathcal{H}(\Omega_{\mathcal{T}}), \\ \nu^n &\rightharpoonup \nu^* \text{ weakly in } L^p(0, \mathcal{T}; \mathcal{W}(\Omega)). \end{aligned}$$

By utilizing (23), (25), and (26), we deduce that

$$\phi = {}^c\mathcal{D}_t^\alpha \nu^* - \mathcal{L}\nu^*.$$

Let us now define the space

$$E = \left\{ w \in L^p(0, \mathcal{T}; W_0^{1,p}(\Omega)) / \partial_t w \in L^1(0, \mathcal{T}; L^1(\Omega)) \right\}.$$

Since  $W_0^{1,p}(\Omega)$  is compactly embedded in  $L^p(\Omega) \subseteq L^2(\Omega)$ , it follows that  $(\nu_i^n)$  is compact in  $L^2(\Omega)$ . By applying Lemma 5.1, we conclude that  $(\partial_t \nu_i^n)$  is bounded in  $L^1(0, \mathcal{T}; L^1(\Omega))$ . Using the classical Aubin argument [31], we establish the compact embedding of the space  $E$  in  $L^2(\Omega_{\mathcal{T}})$ . Therefore, there exists a subsequence of  $(\nu^n)$ , denoted as  $(\nu^n)$ , such that

$$\begin{aligned} \nu^n &\rightharpoonup \nu^* \text{ weakly in } \mathcal{H}(\Omega_{\mathcal{T}}) \text{ and in } L^\infty(0, \mathcal{T}; \mathcal{H}(\Omega)), \\ \nu^n &\longrightarrow \nu^* \text{ strongly in } \mathcal{H}(\Omega_{\mathcal{T}}), \\ \nu^n &\longrightarrow \nu^* \text{ a.e. in } \mathcal{H}(\Omega_{\mathcal{T}}), \\ \nu^n(T) &\longrightarrow \nu^*(T) \text{ in } \mathcal{H}(\Omega_{\mathcal{T}}). \end{aligned}$$

Writing  $\nu_1^n \nu_2^n - \nu_1^* \nu_2^* = (\nu_1^n - \nu_1^*) \nu_2^n + \nu_1^* (\nu_2^n - \nu_2^*)$ , and by leveraging the convergence  $\nu_i^n \longrightarrow \nu_i^*$  in  $L^2(\Omega_{\mathcal{T}})$  and the boundedness of  $(\nu_1^n), (\nu_2^n)$  in  $L^\infty(\Omega_{\mathcal{T}})$ , we conclude that  $\nu_1^n \nu_2^n \longrightarrow \nu_1^* \nu_2^*$  in  $L^2(\Omega_{\mathcal{T}})$ . Additionally, we have  $u^n \rightarrow u^*$  in  $L^2(\Omega_{\mathcal{T}})$  on a subsequence of  $(u^n)$  denoted again as  $(u^n)$ . Utilizing the closeness and convexity of  $U_{ad}$  in  $L^2(\Omega_{\mathcal{T}})$ , we conclude that  $U_{ad}$  is weakly closed. Therefore,  $u^* \in U_{ad}$ . In a similar manner,  $u^n \nu_1^n \longrightarrow u^* \nu_1^*$  in  $L^2(\Omega_{\mathcal{T}})$ . Afterwards, we take the limit in the system satisfied by  $\nu^n$  as  $n \rightarrow \infty$ , finding that  $(\nu^*, u^*)$  is an optimal solution of (8)–(12).  $\square$

**6. Necessary optimality conditions.** To establish necessary optimality conditions, consider  $\nu^*(u^*)$  an optimal solution and  $u^\varepsilon = u^* + \varepsilon u \in U_{ad}$  with  $u \in U_{ad}$ . Let  $\nu^\varepsilon = (\nu_i^\varepsilon)_{i=1,2,3} = (\nu_1, \nu_2, \nu_3)(u^\varepsilon)$  and  $\nu^* = (\nu_i^*)_{i=1,2,3} = (\nu_1, \nu_2, \nu_3)(u^*)$  be solutions of (8)–(10). By subtracting the system associated with  $\nu^*$  from the one corresponding to  $\nu^\varepsilon$ , and noting that  $\nu_i^\varepsilon = \nu_i^* + \varepsilon y_i^\varepsilon$  for any  $i = 1, 2, 3$ , we obtain that

$${}^c\mathcal{D}_t^\alpha y_i^\varepsilon = \lambda \frac{\Delta_p \nu^\varepsilon - \Delta_p \nu^*}{\varepsilon} + \frac{\Psi(\nu^\varepsilon) - \Psi(\nu^*)}{\varepsilon}, \quad (x, t) \in \Omega_{\mathcal{T}}, \quad (31)$$

with

$$\nabla y_i^\varepsilon \cdot \vec{n} = 0, \quad (x, t) \in \Sigma_T, \quad (32)$$

and

$$y_i^\varepsilon(x, 0) = 0 \quad x \in \Omega. \quad (33)$$

A straightforward calculation yields

$$\frac{\Psi(\nu^\varepsilon) - \Psi(\nu^*)}{\varepsilon} = \mathcal{N}_\varepsilon y^\varepsilon + \mathcal{F}u,$$

with

$$\mathcal{N}_\varepsilon = \begin{pmatrix} \beta - \mu\nu_2^\varepsilon - \xi - u^\varepsilon & -\mu\nu_1^* + \beta & \beta \\ \mu\nu_2^\varepsilon & \mu\nu_1^* - \xi - \kappa & 0 \\ u^\varepsilon & \kappa & -\xi \end{pmatrix} \quad \text{and} \quad \mathcal{F} = \begin{pmatrix} -\nu_1^* \\ 0 \\ \nu_1^* \end{pmatrix}.$$

On the other hand,

$$\begin{aligned} \Delta_p \nu^\varepsilon - \Delta_p \nu^* &= \operatorname{div}(\psi(\nabla \nu^\varepsilon)) - \operatorname{div}(\psi(\nabla \nu^*)) \\ &= \psi'(\nabla \nu^\varepsilon) \Delta \nu^\varepsilon - \psi'(\nabla \nu^*) \Delta \nu^* \\ &= \psi'(\nabla \nu^\varepsilon) (\Delta \nu^\varepsilon - \Delta \nu^*) + (\psi'(\nabla \nu^\varepsilon) - \psi'(\nabla \nu^*)) \Delta \nu^*. \end{aligned}$$

Then,

$$\frac{1}{\varepsilon} (\Delta_p \nu^\varepsilon - \Delta_p \nu^*) = \psi'(\nabla \nu^\varepsilon) \frac{\Delta \nu^\varepsilon - \Delta \nu^*}{\varepsilon} + \frac{\psi'(\nabla \nu^\varepsilon) - \psi'(\nabla \nu^*)}{\varepsilon} \Delta \nu^*.$$

Applying the mean value theorem, we can find  $\theta_\varepsilon$  such that

$$\frac{1}{\varepsilon} (\Delta_p \nu^\varepsilon - \Delta_p \nu^*) = \psi'(\nabla \nu^\varepsilon) \Delta y^\varepsilon + \psi''(\theta_\varepsilon) \frac{\nabla \nu^\varepsilon - \nabla \nu^*}{\varepsilon} \Delta \nu^*.$$

Since  $y_i^\varepsilon, \nu_i^\varepsilon$  are bounded in  $L^p(0, \mathcal{T}; W_0^{1,p}(\Omega))$ , uniformly with respect to  $\varepsilon$ ,  $\psi$  is a regular function. Thus,

$$\begin{aligned} \lim_{\varepsilon \rightarrow 0} \frac{\Delta_p \nu^\varepsilon - \Delta_p \nu^*}{\varepsilon} &= \psi'(\nabla \nu^*) \Delta y + \psi''(\nabla \nu^*) \Delta \nu^* \nabla y \\ &= \psi'(\nabla \nu^*) \nabla \cdot \nabla y + \operatorname{div}(\psi'(\nabla \nu^*)) \nabla y \\ &= \operatorname{div}(\psi'(\nabla \nu^*) \nabla y). \end{aligned}$$

On the other hand, the elements of the matrix  $\mathcal{N}_\varepsilon$  are also uniformly bounded with respect to  $\varepsilon$ . We can now proceed to the limit in (31)–(33) as  $\varepsilon \rightarrow 0$ . Considering (28), we arrive at

$$\begin{cases} {}^c \mathcal{D}_t^\alpha y = \lambda \operatorname{div}(\psi'(\nabla \nu^*) \nabla y) + \mathcal{N}y + \mathcal{F}u, & \text{in } \Omega_{\mathcal{T}} \\ (\nabla y_i \cdot \vec{n})_{1 \leq i \leq 3} = 0, & \text{on } \Sigma_{\mathcal{T}}, \\ y(x, 0) = 0, & \text{in } \Omega, \end{cases} \quad (34)$$

where

$$\mathcal{N} = \begin{pmatrix} \beta - \mu\nu_2^* - \xi - u^* & -\mu\nu_1^* + \beta & \beta \\ \mu\nu_2^* & \mu\nu_1^* - \xi - \kappa & 0 \\ u^* & \kappa & -\xi \end{pmatrix}.$$

Applying the theory of fractional differential equations, it follows that system (34) admits a solution [23, 29]. This allows us to derive the adjoint problem associated with the variable  $y$ . We introduce the adjoint vector, denoted as  $\rho = (\rho_1, \rho_2, \rho_3)$ , defined by

$$\int_0^{\mathcal{T}} \int_{\Omega} ({}^c \mathcal{D}_t^\alpha y - \lambda \operatorname{div}(\psi'(\nabla \nu^*) \nabla y)) \rho dx dt = \int_0^{\mathcal{T}} \int_{\Omega} (\mathcal{N}y + \mathcal{F}u) \rho dx dt.$$

Because of

$$\begin{aligned} \int_{\Omega} \operatorname{div}(\psi'(\nabla \nu^*) \nabla y) \rho dx &= - \int_{\Omega} \psi'(\nabla \nu^*) \nabla y \cdot \nabla \rho dx + \int_{\partial \Omega} \rho \psi'(\nabla \nu^*) \nabla y \cdot \vec{n} d\sigma \\ &= - \int_{\Omega} \psi'(\nabla \nu^*) \nabla y \cdot \nabla \rho dx \\ &= \int_{\Omega} y \operatorname{div}(\psi'(\nabla \nu^*) \nabla \rho) dx - \int_{\partial \Omega} y \psi'(\nabla \nu^*) \nabla \rho \cdot \vec{n} d\sigma \\ &= \int_{\Omega} y \operatorname{div}(\psi'(\nabla \nu^*) \nabla \rho) dx, \end{aligned}$$

and Lemma 4.2, we have

$$\int_0^{\mathcal{T}} ({}^c \mathcal{D}_t^\alpha y) \rho dt = \int_0^{\mathcal{T}} y ({}^c \mathcal{D}_t^\alpha \rho) dt + \frac{1}{\Gamma(1-\alpha)} \rho(x, \mathcal{T}) \int_0^{\mathcal{T}} y(t)(\mathcal{T}-t)^{-\alpha} dt.$$

As a result, the dual system, corresponding to (8)–(10), can be expressed as

$$\begin{cases} {}^c \mathcal{D}_t^\alpha \rho - \lambda \operatorname{div}(\psi'(\nabla \nu^*) \nabla \rho) - \mathcal{N} \rho = \mathcal{M}^* \mathcal{M} \nu^*, & \text{in } \Omega_{\mathcal{T}} \\ \nabla \rho_i \cdot \vec{n} = 0, \quad i = 1, 2, 3, & \text{on } \Sigma_{\mathcal{T}}, \\ \rho(x, \mathcal{T}) = \mathcal{M}^* \mathcal{M} \nu^*(x, \mathcal{T}), & \text{in } \Omega, \end{cases} \quad (35)$$

with  $\mathcal{M}$  the matrix defined by

$$\mathcal{M} = \begin{pmatrix} 0 & 0 & 0 \\ 0 & 1 & 0 \\ 0 & 0 & 0 \end{pmatrix}.$$

By [23, 29], system (35) has a solution.

The following theorem establishes necessary optimality conditions for  $u^*$ .

**Theorem 6.1.** *If  $u^*$  is a solution of our optimal control problem, then*

$$\begin{aligned} u^* &= \min \left\{ 1, \max \left( -\frac{1}{\eta} \mathcal{F}^* \rho, 0 \right) \right\} \\ &= \min \left\{ 1, \max \left( 0, -\frac{\nu_1^*}{\eta} (\rho_1 - \rho_3) \right) \right\}, \end{aligned} \quad (36)$$

where  $(\nu^*, u^*)$  is solution of (8)–(12) and  $\rho$  is a solution of (35).

*Proof.* Let us assume  $(\nu^*, u^*)$  to be an optimal solution to (8)–(12). This allows us to state the following:

$$\begin{aligned} \mathcal{J}(\nu^*, u^*) &= \|\nu_2^*\|_{L^2(\Omega_{\mathcal{T}})}^2 + \|\nu_2^*(\cdot, \mathcal{T})\|_{L^2(\Omega)}^2 + \eta \|u^*\|_{L^2(\Omega_{\mathcal{T}})}^2 \\ &= \int_0^{\mathcal{T}} \|\mathcal{M} \nu^*\|_{\mathcal{H}(\Omega)}^2 dt + \|\mathcal{M} \nu^*(\cdot, \mathcal{T})\|_{\mathcal{H}(\Omega)}^2 + \eta \|u^*\|_{L^2(\Omega_{\mathcal{T}})}^2. \end{aligned}$$

For a sufficiently small  $\varepsilon > 0$ , considering that the minimum of the objective functional is achieved at  $u^*$ , the inequality

$$\frac{\mathcal{J}(u^* + \varepsilon w) - \mathcal{J}(u^*)}{\varepsilon} \geq 0$$

is equivalent to

$$\int_0^{\mathcal{T}} (F^* \rho + \eta u^*, w)_{L^2(\Omega)} dt \geq 0, \quad \forall w \in U_{ad}.$$

Since  $\mathcal{H}(\Omega)$  and  $L^2(\Omega_{\mathcal{T}})$  are Hilbert spaces, then

$$\begin{aligned} &\mathcal{J}'(\nu^*, u^*)(w) \\ &= \lim_{\varepsilon \rightarrow 0} \frac{1}{\varepsilon} (\mathcal{J}(\nu^\varepsilon, u^\varepsilon) - \mathcal{J}(\nu^*, u^*)) \\ &= \lim_{\varepsilon \rightarrow 0} \frac{1}{\varepsilon} \left( \int_0^{\mathcal{T}} \int_{\Omega} ((\nu_2^\varepsilon)^2 - (\nu_2^*)^2) dx dt + \int_{\Omega} ((\nu_2^\varepsilon(x, \mathcal{T}))^2 - (\nu_2^*(x, \mathcal{T}))^2) dx \right. \\ &\quad \left. + \eta \int_0^{\mathcal{T}} \int_{\Omega} ((u^\varepsilon)^2 - (u^*)^2) dx dt \right) \end{aligned}$$

$$= \lim_{\varepsilon \rightarrow 0} \left( \int_0^{\mathcal{T}} \int_{\Omega} \left( \frac{\nu_2^\varepsilon - \nu_2^*}{\varepsilon} \right) (\nu_2^\varepsilon + \nu_2^*) dx dt + \int_{\Omega} \left( \frac{\nu_2^\varepsilon - \nu_2^*}{\varepsilon} \right) (\nu_2^\varepsilon + \nu_2^*) (x, \mathcal{T}) dx \right. \\ \left. + \eta \int_0^{\mathcal{T}} \int_{\Omega} (\varepsilon w^2 + 2wu^*) dx dt \right).$$

Because  $\nu_2^\varepsilon \rightarrow \nu_2^*$  belongs to  $L^2(\Omega_{\mathcal{T}})$  and  $\nu_2^\varepsilon, \nu_2^* \in L^\infty(\Omega_{\mathcal{T}})$ , then

$$\mathcal{J}'(\nu^*, u^*)(w) = 2 \int_0^{\mathcal{T}} \int_{\Omega} (\nu_2^*) \nu' (u^*) w dx dt \\ + 2 \int_{\Omega} ((\nu_2^*) \nu' (u^*) w) (x, \mathcal{T}) dx + 2\eta \int_0^{\mathcal{T}} \int_{\Omega} wu^* dx dt.$$

This is the same as

$$\mathcal{J}'(\nu^*, u^*)(w) = 2 \int_0^{\mathcal{T}} (\mathcal{M}\nu^*, \mathcal{M}y)_{\mathcal{H}(\Omega)} dt \\ + 2 (\mathcal{M}\nu^*(x, \mathcal{T}), \mathcal{M}y(x, \mathcal{T}))_{\mathcal{H}(\Omega)} + 2\eta \int_0^{\mathcal{T}} (u^*, w)_{L^2(\Omega)} dt,$$

where  $y = \nu' (u^*) w$  represents the unique solution of (34) related to  $w$ . By using (34) and (35), we get

$$\int_0^{\mathcal{T}} (\mathcal{M}\nu^*, \mathcal{M}y)_{\mathcal{H}(\Omega)} dt + (\mathcal{M}\nu^*(x, \mathcal{T}), \mathcal{M}y(x, \mathcal{T}))_{\mathcal{H}(\Omega)} \\ = \int_0^{\mathcal{T}} (\mathcal{M}^* \mathcal{M}\nu^*, y)_{\mathcal{H}(\Omega)} dt + (\mathcal{M}^* \mathcal{M}\nu^*(x, \mathcal{T}), y(x, \mathcal{T}))_{\mathcal{H}(\Omega)} \\ = \int_0^{\mathcal{T}} (\mathcal{C}_{\mathcal{T}} \mathcal{D}_t^\alpha \rho - \lambda \operatorname{div} (\psi'(\nabla \nu^*) \nabla \rho) - \mathcal{N}\rho, y)_{\mathcal{H}(\Omega)} dt \\ + (\mathcal{M}^* \mathcal{M}\nu^*(x, \mathcal{T}), y(x, \mathcal{T}))_{\mathcal{H}(\Omega)} \\ = \int_0^{\mathcal{T}} (\rho, \mathcal{C} \mathcal{D}_t^\alpha y - \lambda \operatorname{div} (\psi'(\nabla \nu^*) \nabla y) - \mathcal{N}y)_{\mathcal{H}(\Omega)} dt,$$

that is,

$$\int_0^{\mathcal{T}} (\mathcal{M}\nu^*, \mathcal{M}y)_{\mathcal{H}(\Omega)} dt + (\mathcal{M}\nu^*(x, \mathcal{T}), \mathcal{M}y(x, \mathcal{T}))_{\mathcal{H}(\Omega)} \\ = \int_0^{\mathcal{T}} (\rho, \mathcal{F}w)_{\mathcal{H}(\Omega)} dt \\ = \int_0^{\mathcal{T}} (\mathcal{F}^* \rho, w)_{L^2(\Omega)} dt,$$

and

$$\mathcal{J}'(\nu^*, u^*)(w) = 2 \int_0^{\mathcal{T}} (\mathcal{F}^* \rho + \eta u^*, w)_{L^2(\Omega)} dt.$$

With the Gâteaux differentiability of  $\mathcal{J}$  at  $u^*$  and the convexity of  $U_{ad}$ , we can affirm that

$$0 \leq \mathcal{J}'(\nu^*, u^*)(\phi - u^*)$$

holds for all  $\phi \in U_{ad}$ . Therefore, we can state that

$$u^* = \min \left\{ 1, \max \left( -\frac{1}{\eta} \mathcal{F}^* \rho, 0 \right) \right\}$$



$$= \min \left\{ 1, \max \left( 0, -\frac{\nu_1^*}{\eta} (\rho_1 - \rho_3) \right) \right\}.$$

The proof is complete.  $\square$

While our study provides a thorough analysis of the fractional spatiotemporal SIR model, including the derivation of necessary optimality conditions for the associated control problem, the derivation of sufficient conditions for optimality remains an open question. Sufficient conditions often require additional structural properties of the objective functional or state dynamics. For example, strict convexity of the objective functional

$$\mathcal{J}(u) = \|I(\cdot, \mathcal{T})\|_{L^2(\Omega)}^2 + \|I\|_{L^2(\Omega_{\mathcal{T}})}^2 + \eta \|u\|_{L^2(\Omega_{\mathcal{T}})}^2,$$

requires verifying that

$$\frac{\partial^2 \mathcal{J}}{\partial u^2} > 0 \quad \text{for all admissible } u \in U_{\text{ad}}.$$

Similarly, monotonicity properties of the state operator  $\mathcal{A}[S, I, R, u]$  defined by

$$\mathcal{A}[S, I, R, u] = \begin{bmatrix} {}^c\mathcal{D}_t^\alpha S - \lambda_1 \Delta_p S - \beta N + \mu SI + \xi S + uS \\ {}^c\mathcal{D}_t^\alpha I - \lambda_2 \Delta_p I - \mu SI + (\xi + \kappa)I \\ {}^c\mathcal{D}_t^\alpha R - \lambda_3 \Delta_p R - \kappa I + \xi R - uS \end{bmatrix},$$

governing the dynamics, such as

$$\langle \mathcal{A}[S_1, I_1, R_1, u] - \mathcal{A}[S_2, I_2, R_2, u], S_1 - S_2 \rangle \geq 0,$$

might provide additional insights into sufficient conditions for optimality.

However, these properties are not immediately evident in our current framework involving fractional derivatives and the  $p$ -Laplacian operator. Addressing this limitation would include exploring the functional properties of the system in greater depth and potentially imposing additional constraints or regularity assumptions. Future research could focus on establishing such conditions, providing stronger guarantees for the optimality of the control program.

**7. Numerical results.** The primary objective of this section is to present approximate and numerical results to our fractional model. Therefore, whether in the absence of a vaccination program or in its presence, we study the impact of the  $\alpha$ -order derivation and the coefficient of diffusion  $p$  on the spatial spread of infection over 80 days.

In the following, we presume that the illness begins in the sub-domain  $\Omega_0 = \text{cell}(11, 11)$  when the disease is born in the middle of  $\Omega$ , where  $\Omega$  symbolizes an urban area inhabited by the individuals under examination, covering a  $21\text{km} \times 21\text{km}$  square grid of spatial extent. Except for the sub-domain  $\Omega_0$  of  $\Omega$ , we assume that all susceptible individuals are homogeneously and uniformly distributed at  $t = 1$  with 50 in each  $1\text{km} \times 1\text{km}$  cell, where we introduce 10 infected individuals in  $\Omega_0$  while maintaining 40 susceptible individuals in the same area.

Due to the unavailability of real-world data in this study, we have selected parameter values based on previous works [3, 12, 36, 37, 45], which qualitatively represent the dynamics of disease spread. These values are chosen to capture the general progression of an epidemic, while respecting realistic assumptions about the relationships between the parameters, as observed in real-world scenarios. For example, certain rates, such as transmission or recovery rates, are expected to be larger or smaller depending on biological or intervention-related processes. The parameters

in the SIR model reflect these various processes, and their interrelationships offer valuable insights into the dynamics of disease spread. A summary of the parameter values and initial conditions used in our simulations can be found in Table 2.

TABLE 2. Initial conditions and parameters values.

Symbol	Description	Unit	Value
$S_0(x, y)$	Initial susceptible individuals	$people \cdot km^{-2}$	50 for $(x, y) \notin \Omega_0$ 40 for $(x, y) \in \Omega_0$
$I_0(x, y)$	Initial infected individuals	$people \cdot km^{-2}$	0 for $(x, y) \notin \Omega_0$ 10 for $(x, y) \in \Omega_0$
$R_0(x, y)$	Initial recovered individuals	$people \cdot km^{-2}$	0 for $(x, y) \in \Omega$
$\lambda_1 = \lambda_2 = \lambda_3$	Diffusion coefficient	$km^2 \cdot day^{-1}$	0.1
$\beta$	Birth rate	$day^{-1}$	0.02
$\xi$	Natural death rate	$day^{-1}$	0.03
$\mu$	Transmission rate	$(people \cdot day)^{-1} km^2$	0.9
$\kappa$	Recovery rate	$day^{-1}$	0.04
$\mathcal{T}$	Final time	$day$	80

**7.1. Forward-backward sweep method algorithm.** The approach we apply is founded on an iterative discrete scheme similar to the forward-backward sweep method. To resolve our fractional system (8)–(12), we have used MatLab. Systems (8) and (35) are numerically integrated by using an explicit finite difference method to approximate the left-right  $\mathcal{C}$ -fractional derivatives. By applying a forward approach in time, we solve the state problem, and a backward approach in time solves the dual system according to the transversality conditions. The preceding discussion can be succinctly summarized in the algorithm organigram depicted in Figure 2.

**7.2. Numerical findings without a vaccination program.** Our numerical results, obtained by varying the values of  $p$  and  $\alpha$ , without implementing a vaccination strategy, are depicted in Figures 3, 4, and 5. These figures illustrate the progression of the epidemic from the first day to the last, revealing a consistent pattern of susceptible citizens spreading from the center of  $\Omega$  to its periphery, with infected citizens multiplying rapidly. In Figure 3, for the case of  $\alpha = 1$  and  $p \in \{15, 10, 5\}$ , we observe that on the final day, there are approximately 50 infected individuals per cell. This implies that the epidemic takes 80 days to fully cover all  $\Omega$ . Contrary, as depicted in Figures 4 and 5, it takes more than 80 days for the pandemic to spread and encompass the entire region when  $\alpha \in \{0.95, 0.9\}$  and  $p \in \{15, 10, 5\}$ . In these scenarios, there are approximately 43 infected individuals per cell.

**7.3. Numerical findings with a vaccination program.** Now, the vaccination program is initiated from the first day of the simulation. In this scenario, we assess the evolution of infection prevalence over an 80-days period, during which susceptible individuals move to the category of recovered. Maintaining the same parameter configurations as presented in Section 7.2, Figure 6 portrays the distribution of 30 infected citizens per grid cell and 17 recovered individuals per cell in the center of  $\Omega$ . In contrast, Figures 7 and 8 illustrate an environment where the central region of  $\Omega$  contains approximately 5 susceptible persons, 33 infected individuals, and 12 recovered per cell. For a comprehensive visualization of the epidemic dynamics, under various parameter settings,  $p \in \{15, 10, 5\}$  and  $\alpha \in \{1, 0.95, 0.9\}$ , Figure 9 provides videos, showcasing the spread of the epidemic over a 80-days period during the implementation of the vaccination strategy.

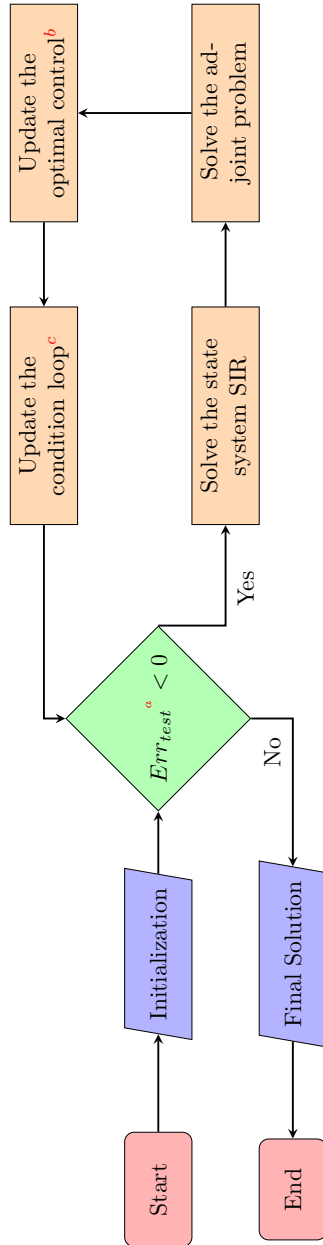
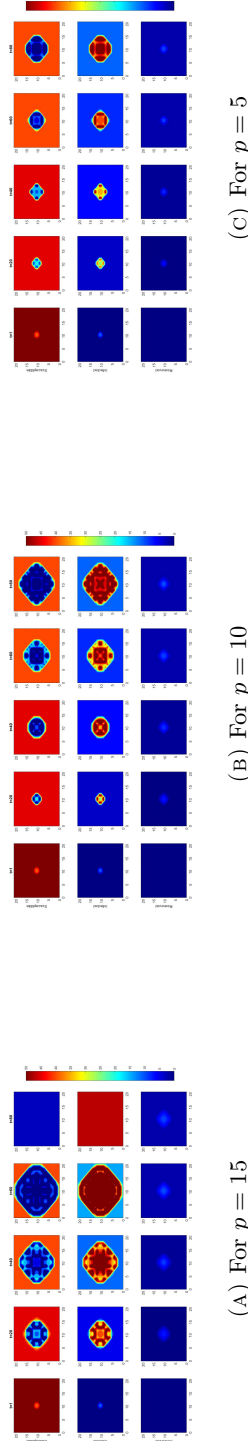

FIGURE 2. Algorithm organigram for the proposed SIR epidemic model.

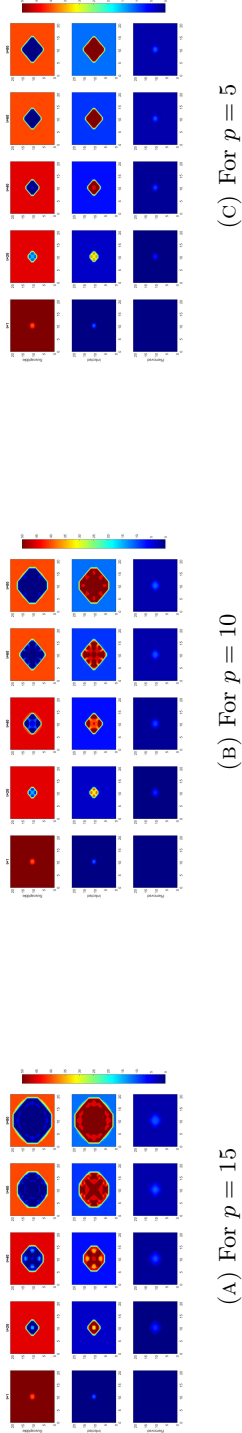
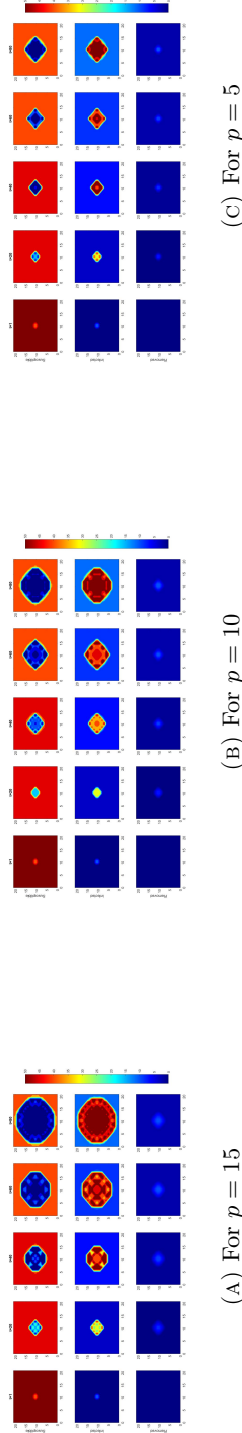
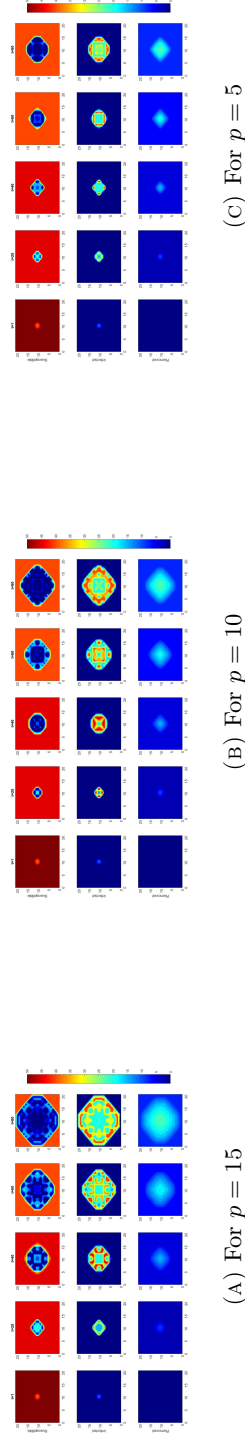

 FIGURE 3. Numerical findings of (8)–(10) without vaccination program for  $\alpha = 1$ .

Let  $S = \{x_i = 1 + i\delta_x / i = 0, \dots, N_x - 1\}$  be a uniform subdivision on  $[1, \mathcal{T}]$  where  $N_x$  and  $\delta_x$  are the numbers and the step size of this subdivision, respectively. The number of steps in time is  $N_t$ , with the step time denoted by  $\delta_t$ ;  $\delta$  is the tolerance, and its value is  $10^{-3}$  and  $Err_{test} = -1$ .

<sup>a</sup>Condition of the “while” loop.

<sup>b</sup>Using equation (36), update the optimal control  $u$ .

<sup>c</sup> $Err_{test} = \min \{\psi_1, \psi_2, \psi_3, \psi_4, \psi_5, \psi_6, \psi_7\}$ , where  $\psi_1 = \delta \|S\| - \|S - S_{old}\|$ ,  $\psi_2 = \delta \|I\| - \|I - I_{old}\|$ ,  $\psi_3 = \delta \|R\| - \|R - R_{old}\|$ ,  $\psi_4 = \delta \|\rho_1\| - \|\rho_1 - \rho_{old1}\|$ ,  $\psi_5 = \delta \|\rho_2\| - \|\rho_2 - \rho_{old2}\|$ ,  $\psi_6 = \delta \|\rho_3\| - \|\rho_3 - \rho_{old3}\|$ , and  $\psi_7 = \delta \|u\| - \|u - u_{old}\|$ .

FIGURE 4. Numerical findings of (8)–(10) without vaccination program for  $\alpha = 0.95$ .FIGURE 5. Numerical findings of (8)–(10) without vaccination program for  $\alpha = 0.9$ .FIGURE 6. Numerical findings of (8)–(10) with vaccination program for  $\alpha = 1$ .

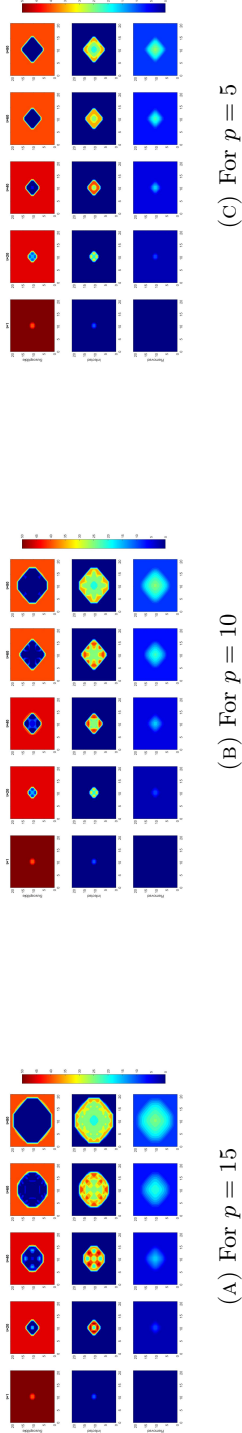

FIGURE 7. Numerical findings of (8)–(10) with vaccination program for  $\alpha = 0.95$ .

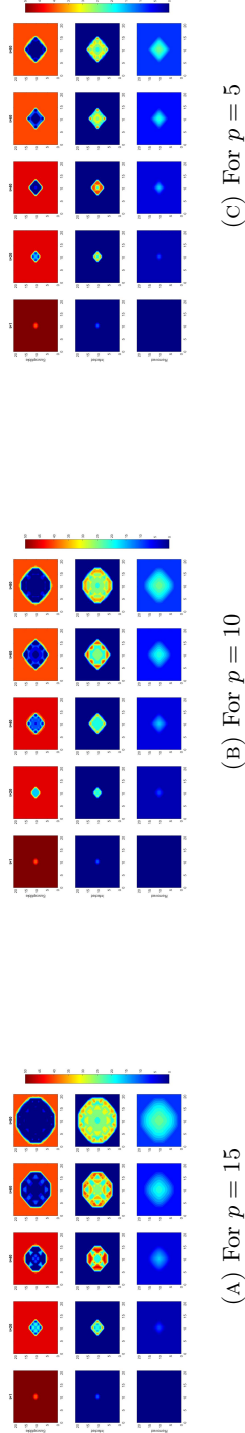

FIGURE 8. Numerical findings of (8)–(10) with vaccination program for  $\alpha = 0.9$ .

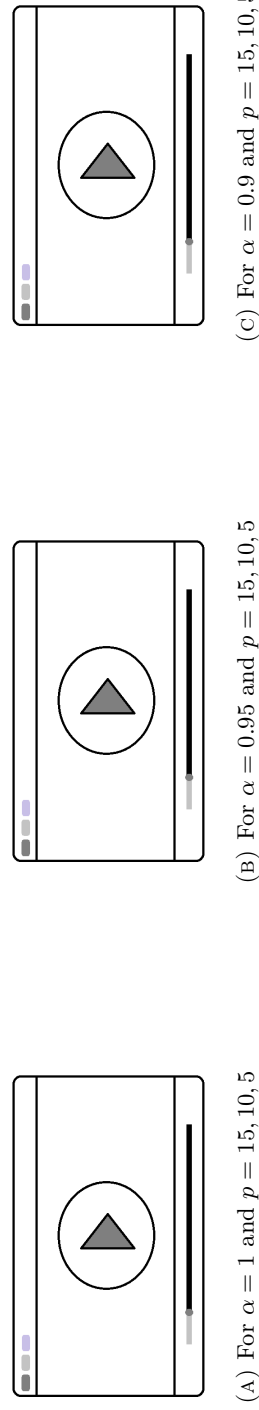

FIGURE 9. System dynamics (Videos) with vaccination strategy in 80 days.

**8. Conclusion.** In this research work, we have introduced a new innovative application of spatiotemporal models within the framework of optimal control theory. Our approach involves the modeling of interactions among the three compartments through a system of fractional equations, utilizing the Caputo fractional derivative and the  $p$ -Laplacian operator. We claim that our study has the potential to yield more realistic models for the spread of diseases in specific scenarios. One of the key contributions is the establishment of the existence and uniqueness of a solution for our biological system, as well as the derivation of an optimal control program. We have characterized the optimal control by making use of the associated state and adjoint variables, shedding light on the effective management of the disease spread. Moreover, as part of our illustrative applications, we have conducted extensive simulations to observe how infectious diseases propagate and how they can be controlled. The results of these simulations clearly demonstrate that an increase in the value of  $p$  or the choice of integer values for  $\alpha$  leads to a more rapid spread of the disease. Notably, our research highlights that the implementation of a vaccination strategy is highly successful in controlling the spread of infections during the designated time frame. These findings are of considerable significance for public health and epidemiological research, as they contribute to our understanding of how different parameters influence the dynamics of infectious diseases.

In this study, we focused on the SIR model as a foundational framework to investigate the impact of fractional operators and the  $p$ -Laplacian within a reaction-diffusion system. While the SIR model is widely regarded as a benchmark for studying epidemic dynamics, we acknowledge that more complex models, such as the SEIR/SIQR models or multi-compartmental systems, may capture additional epidemiological features. Incorporating such models could provide deeper insights into specific scenarios, such as latent infection stages or age-structured populations. Extending our analysis to these more intricate frameworks would be a valuable direction for future research. It could further demonstrate the versatility and applicability of fractional reaction-diffusion systems in epidemiology.

**Acknowledgments.** The authors express their appreciation to the reviewers for their valuable, constructive comments, and suggestions.

#### Declarations.

**Funding.** This work is part of Zinihi's PhD thesis done under the financial support of CNRST as part of the PASS program. Torres was supported by Fundação para a Ciência e a Tecnologia (FCT), within project number UIDB/04106/2020 (CIDMA).

**Data availability.** All information analyzed or generated, which would support the results of this work are available in this article. No data was used for the research described in the article.

**Conflict of interest.** The authors declare that there are no problems or conflicts of interest between them that may affect the study in this paper

#### REFERENCES

- [1] A. A. Alikhanov, [A priori estimates for solutions of boundary value problems for fractional-order equations](#), *Differential Equations*, **46** (2010), 660-666.
- [2] R. Almeida, A. B. Malinowska and M. T. T. Monteiro, [Fractional differential equations with a Caputo derivative with respect to a kernel function and their applications](#), *Mathematical Methods in the Applied Sciences*, **41** (2018), 336-352.

- [3] A. S. Alshomrani, M. Z. Ullah and B. Baleanu, [Caputo SIR model for COVID-19 under optimized fractional order](#), *Advances in Difference Equations*, (2021), Paper No. 185, 17 pp.
- [4] N. T. J. Bailey, *The Mathematical Theory of Infectious Diseases and its Applications*, Charles Griffin & Company Ltd, 5a Crendon Street, High Wycombe, Bucks HP13 6LE., 1975.
- [5] V. Barbu, *Mathematical Methods in Optimization of Differential Systems*, Springer Netherlands, 1994.
- [6] J. Borggaard, T. Iliescu and J. P. Roop, [Two-level discretization of the navier-stokes equations with r-Laplacian subgrid-scale viscosity](#), *Numerical Methods for Partial Differential Equations*, **28** (2011), 1056-1078.
- [7] D. Calvetti and E. Somersalo, [Post-pandemic modeling of COVID-19: Waning immunity determines recurrence frequency](#), *Mathematical Biosciences*, **365** (2023), 109067, 8 pp.
- [8] X. Cui, D. Xue and F. Pan, [Dynamic analysis and optimal control for a fractional-order delayed SIR epidemic model with saturated treatment](#), *The European Physical Journal Plus*, **137** (2022), article number 586.
- [9] A. C. C. da Costa, C. T. Codeço, E. T. Krainski, M. F. C. Gomes and A. A. Nobr, [Spatiotemporal diffusion of influenza A \(H1N1\): Starting point and risk factors](#), *PLOS ONE*, **13** (2018), e0202832.
- [10] K. Diethelm, [A fractional calculus based model for the simulation of an outbreak of dengue fever](#), *Nonlinear Dynamics*, **71** (2013), 613-619.
- [11] K. Diethelm, *The Analysis of Fractional Differential Equations: An Application-Oriented Exposition Using Differential Operators of Caputo Type*, Springer Berlin Heidelberg, 2010.
- [12] Y. Ding and H. Schellhorn, [Optimal control of the SIR model with constrained policy, with an application to COVID-19](#), *Mathematical Biosciences*, **344** (2022), 108758, 15 pp.
- [13] R. Ducasse and S. Nordmann, [Propagation properties in a multi-species SIR reaction-diffusion system](#), *Journal of Mathematical Biology*, **87** (2023), Paper No. 16, 33 pp.
- [14] S. Elgart, [A perturbative approach to the analysis of many-compartment models characterized by the presence of waning immunity](#), *Journal of Mathematical Biology*, **87** (2023), Paper No. 61, 32 pp.
- [15] H. Fu, M. Hereward, S. MacFeely, A. Me and J. Wilmoth, [How COVID-19 is changing the world: A statistical perspective from the committee for the coordination of statistical activities](#), *Statistical Journal of the IAOS*, **36** (2020), 851-860.
- [16] N. M. Gatto and H. Schellhorn, [Optimal control of the SIR model in the presence of transmission and treatment uncertainty](#), *Mathematical Biosciences*, **333** (2021), 108539, 11 pp.
- [17] F. Ge and Y. Chen, [Optimal vaccination and treatment policies for regional approximate controllability of the time-fractional reaction-diffusion SIR epidemic systems](#), *ISA Transactions*, **115** (2021), 143-152.
- [18] R. Gorenflo, F. Mainardi and I. Podlubny, *Fractional differential equations*, *Academic Press*, **8** (1999), 683-699.
- [19] F. Jarad and T. Abdeljawad, [Variational principles in the frame of certain generalized fractional derivatives](#), *Discrete & Continuous Dynamical Systems - S*, **13** (2020), 695-708.
- [20] C. Ji, D. Jiang and N. Shi, [The behavior of an SIR epidemic model with stochastic perturbation](#), *Stochastic Analysis and Applications*, **30** (2012), 755-773.
- [21] W. O. Kermack and A. G. McKendrick, [A contribution to the mathematical theory of epidemics](#), *Proceedings of the Royal Society A*, **115** (1927), 700-721.
- [22] A. A. Kilbas, H. M. Srivastava and J. J. Trujillo, *Theory and Applications of Fractional Differential Equations*, volume 204, Elsevier, 2006.
- [23] H. Khan, J. F. Gómez-Aguilar, A. Khan and T. S. Khan, [Stability analysis for fractional order advection-reaction diffusion system](#), *Physica A: Statistical Mechanics and its Applications*, **521** (2019), 737-751.
- [24] T. Khan, R. Ullah, G. Zaman and J. Alzabut, [A mathematical model for the dynamics of SARS-CoV-2 virus using the Caputo-Fabrizio operator](#), *Mathematical Biosciences and Engineering*, **18** (2021), 6095-6116.
- [25] A. M. Kramer, J. T. Pulliam, L. W. Alexander, A. W. Park, P. Rohani and J. M. Drake, [Spatial spread of the west africa Ebola epidemic](#), *Royal Society Open Science*, **3** (2016), 160294.
- [26] G. W. Leibniz, Letter from Hanover, Germany to GFA L'Hospital, september 30, 1695. *Mathematische Schriften*, **2** (1849), 301-302.



- [27] A. P. Lemos-Paião, H. Maurer, C. J. Silva and D. F. M. Torres, [A SIQRB delayed model for cholera and optimal control treatment](#), *Mathematical Modelling of Natural Phenomena*, **17** (2022), Paper No. 25, 23 pp. [arXiv:2206.12688](#)
- [28] Z. Lu, Y. Yu, G. Ren, C. Xu and X. Meng, [Global dynamics for a class of reaction-diffusion multigroup SIR epidemic models with time fractional-order derivatives](#), *Nonlinear Analysis: Modelling and Control*, **27** (2022), 142-162.
- [29] C. Milici, G. Drăgănescu and J. T. Machado, *Introduction to Fractional Differential Equations*, Springer International Publishing, 2019.
- [30] A. Mouaouine, A. Boukhouima, K. Hattaf and N. Yousfi, [A fractional order SIR epidemic model with nonlinear incidence rate](#), *Advances in Difference Equations*, 2018, Paper No. 160, 9 pp.
- [31] A. Moussa, [Some variants of the classical Aubin–Lions lemma](#), *Journal of Evolution Equations*, **16** (2015), 65-93.
- [32] T. B. Ngoc, N. H. Tuan, R. Sakthivel and D. O’Regan, [Analysis of nonlinear fractional diffusion equations with a Riemann–Liouville derivative](#), *Evolution Equations and Control Theory*, **11** (2022), 439-455.
- [33] K. M. Owolabi, [Analysis and numerical simulation of cross reaction–diffusion systems with the Caputo–Fabrizio and Riesz operators](#), *Numerical Methods for Partial Differential Equations*, **39** (2021), 1915-1937.
- [34] I. J. Rao and M. L. Brandeau, [Optimal allocation of limited vaccine to control an infectious disease: Simple analytical conditions](#), *Mathematical Biosciences*, **337** (2021), 108621, 9 pp.
- [35] S. Saha Ray, [An investigation on reliable analytical and numerical methods for the Riesz fractional nonlinear Schrödinger equation in quantum mechanics](#), *Numerical Methods for Partial Differential Equations*, **34** (2017), 1598-1613.
- [36] M. R. Sidi Ammi, M. Tahiri and D. F. M. Torres, [Necessary optimality conditions of a reaction-diffusion SIR model with ABC fractional derivatives](#), *Discrete & Continuous Dynamical Systems - S*, **15** (2022), 621-637. [arXiv:2106.15055](#)
- [37] M. R. Sidi Ammi, A. Zinihi, A. A. Raezah and Y. Sabbar, [Optimal control of a spatiotemporal \*STR\* model with reaction–diffusion involving \*p\*-Laplacian operator](#), *Results in Physics*, **52** (2023), 106895.
- [38] P. T. Sowndarrajan, L. Shangganesh, A. Debbouche and D. F. M. Torres, [Optimal control of a heroin epidemic mathematical model](#), *Optimization*, **71** (2022), 3107-3131. [arXiv:2111.05906](#)
- [39] W. Tao and Y. Li, [Boundedness of weak solutions of a chemotaxis-Stokes system with slow \*p\*-Laplacian diffusion](#), *Journal of Differential Equations*, **268** (2020), 6872-6919.
- [40] L. C. Torres and C. G. Gal, [Control of fractional in-time Schrodinger equations via comprehensive Caputo derivative strategies](#), *Evolution Equations and Control Theory*, **13** (2024), 1311–1331.
- [41] C. Walker, [Well-posedness and stability analysis of an epidemic model with infection age and spatial diffusion](#), *Journal of Mathematical Biology*, **87** (2023), Paper No. 52, 46 pp.
- [42] H. Zine, A. El Adraoui and D. F. M. Torres, [Mathematical analysis, forecasting and optimal control of HIV/AIDS spatiotemporal transmission with a reaction diffusion SICA model](#), *AIMS Mathematics*, **7** (2022), 16519-16535. [arXiv:2207.02527](#)
- [43] A. Zinihi, M. R. Sidi Ammi and A. Bachir, [Impact of quarantine measures on the global stability of an epidemiological model](#), *Journal of Dynamics and Games*, (2024).
- [44] A. Zinihi, M. R. Sidi Ammi, A. Bachir and P. Debnath, [Existence of solutions for a q-fractional p-laplacian SIR model](#), *Journal of Applied Analysis*, 2024.
- [45] A. Zinihi, M. R. Sidi Ammi and M. Ehrhardt, [Mathematical modeling and Hyers-Ulam stability for a nonlinear epidemiological model with  \$\Phi\_p\$  operator and Mittag-Leffler kernel](#), *Advances in Applied Mathematics and Mechanics*, 2024.

Received October 2024; revised January 2025; early access February 2025.