

# REDUCTIONS IN LOCAL CERTIFICATION

LOUIS ESPERET AND SÉBASTIEN ZEITOUN

ABSTRACT. Local certification is a topic originating from distributed computing, where a prover tries to convince the vertices of a graph  $G$  that  $G$  satisfies some property  $\mathcal{P}$ . To convince the vertices, the prover gives a small piece of information, called certificate, to each vertex, and the vertices then decide whether the property  $\mathcal{P}$  is satisfied by just looking at their certificate and the certificates of their neighbors. When studying a property  $\mathcal{P}$  in the perspective of local certification, the aim is to find the optimal size of the certificates needed to certify  $\mathcal{P}$ , which can be viewed as a measure of the local complexity of  $\mathcal{P}$ .

A certification scheme is considered to be efficient if the size of the certificates is polylogarithmic in the number of vertices. While there have been a number of meta-theorems providing efficient certification schemes for general graph classes, the proofs of the lower bounds on the size of the certificates are usually very problem-dependent.

In this work, we introduce a notion of hardness reduction in local certification, and show that we can transfer a lower bound on the certificates for a property  $\mathcal{P}$  to a lower bound for another property  $\mathcal{P}'$ , via a (local) hardness reduction from  $\mathcal{P}$  to  $\mathcal{P}'$ . We then give a number of applications in which we obtain polynomial lower bounds for many classical properties using such reductions.

## 1. INTRODUCTION

The main focus of the paper is on *local certification*, which is a field at the intersection of distributed computing, graph theory, and complexity studying how the vertices of a graph  $G$  can be convinced that  $G$  satisfies some given property  $\mathcal{P}$ , even if each vertex of  $G$  only has a very local view of the graph (for instance, if it can only interact with its neighbors). More precisely, a *proof labeling scheme* for a property  $\mathcal{P}$  in a graph  $G$  works as follows:

- (1) a prover assigns (short) certificates to the vertices of the graph  $G$ ;
- (2) each vertex  $v$  checks its *local view* (its certificate and the certificates of its neighbors),
- (3) based only on its local view, each vertex must decide whether  $G$  satisfies the given property  $\mathcal{P}$ .

If the graph indeed satisfies  $\mathcal{P}$ , all vertices must accept the instance. If the graph does not satisfy  $\mathcal{P}$ , then for any possible assignment of certificates, at least one vertex must reject the instance. For  $n \in \mathbb{N}$ , the *local complexity* of  $\mathcal{P}$  is the minimum  $f(n)$  such that for every  $n$ -vertex graph  $G$ , the property  $\mathcal{P}$  can be locally certified in  $G$  with certificates of at most  $f(n)$  bits per vertex. We can also study more generally the local complexity of a property  $\mathcal{P}$  within a graph class  $\mathcal{C}$ , by which we mean that the minimum above is taken over all  $n$ -vertex graphs from  $\mathcal{C}$ .

---

The authors are partially supported by the French ANR Project TWIN-WIDTH (ANR-21-CE48-0014-01), and by LabEx PERSYVAL-lab (ANR-11-LABX-0025).

Note that every property has local complexity  $O(n^2)$ : it suffices to write the adjacency matrix of the graph in the certificate of each vertex. By doing so, each vertex knows the whole graph and is able to decide whether the property is satisfied or not [14]. On the other hand, a counting argument shows that some properties involving symmetries have local complexity  $\Omega(n^2)$ . The original work of Göös and Suomela [14] identified three natural ranges of local complexity for graph classes:

- $\Theta(1)$ : this includes  $k$ -colorability for fixed  $k$ , and in particular bipartiteness;
- $\Theta(\log n)$ : this includes non-bipartiteness, acyclicity; planarity [9] and more generally bounded genus [10, 6];
- $\Theta(\text{poly}(n))$ : this includes non-3-colorability [14], unit-distance graphs, unit-disk graphs, and 1-planar graphs [3], as well as problems involving symmetries [14].

Many of the results mentioned above (either lower bounds or upper bounds) are proved using rather ad-hoc arguments that do not seem to be applicable to a large number of graph properties at once. On the other hand, a number of positive results (upper bounds on the local complexity) have been obtained via so-called “meta-theorems”, that is theorems applicable to a wide range of problems and graph classes. It was proved in [12] that any graph class of bounded treewidth which is expressible in monadic second order logic has local complexity  $O(\log^2 n)$  (this implies in particular that for any fixed  $k$ , the class of graphs of treewidth at most  $k$  has local complexity  $O(\log^2 n)$ ). Similar meta-theorems involving graph properties expressible in first-order logic were proved for graphs of bounded treedepth [8] and graphs of bounded cliquewidth [11]. Another type of meta-theorem was obtained in [17]: any property that can be decided in linear time has an *interactive* proof labeling scheme with compact certificates (in this setting several rounds of interactions are allowed between the prover and the vertices).

Distributed algorithms in graphs are considered to be efficient if they run in a polylogarithmic number of rounds. Therefore, the class of all properties whose local complexity is polylogarithmic in the size of the graph can be seen as a distributed analogue of the class NP. However, a major feature of NP has so far been missing in the toolbox of local certification: the possibility of doing hardness reductions. The purpose of this paper is to introduce a framework allowing to use classical NP-hardness reductions to prove automatic lower bounds on the local complexity of graph properties. Our techniques apply whenever the reduction is sufficiently local. In particular, using the result of Göös and Suomela [14] stating that non-3-colorability has local complexity  $\Omega(n^2/\log n)$ , we prove that a number of classical coNP-hard problems have polynomial local complexity. The table in Figure 1 sums up our lower bounds.

Note that most of the lower bounds in the table of Figure 1 hold in a bounded-degree graph class (so in general graphs too). However, in a bounded-degree graph class, every property has local complexity  $O(n \log n)$ . Indeed,  $O(n \log n)$  bits are sufficient to encode all the edges of a bounded-degree graph (using adjacency lists), and we can just write the description of the whole graph in the certificate of every vertex. Thus, most of the results above in bounded-degree classes are optimal (within a polylogarithmic factor). The two exceptions are the local complexity of non-3-colorability in planar graphs of maximum degree 4, and the local complexity of non-hamiltonicity in graphs of maximum degree 4. We believe that in both cases

Property $\mathcal{P}$	Class of graphs $\mathcal{C}$	Lower bound for $\mathcal{P}$ in $\mathcal{C}$	Theorem
Non-3-colorability	Planar graphs with $\Delta \leq 4$	$\Omega\left(\frac{\sqrt{n}}{\log^2 n}\right)$	3.3
Non- $k$ -colorability ( $k \geq 4$ )	General graphs	$\Omega\left(\frac{n^2}{\log n}\right)$	4.1
Non- $k$ -colorability ( $k \geq 3$ )	Graphs with $\Delta \leq k + \lceil \sqrt{k} \rceil - 1$	$\Omega\left(\frac{n}{\log n}\right)$	7.1
Domatic number at most 2	Graphs with $\Delta \leq 8$	$\Omega\left(\frac{n}{\log n}\right)$	5.4
Non-existence of a cubic subgraph	Graphs with $\Delta \leq 7$	$\Omega\left(\frac{n}{\log n}\right)$	5.5
Non-existence of a partition in $k$ acyclic subgraphs ( $k \geq 3$ )	General graphs	$\Omega\left(\frac{n}{\log n}\right)$	5.9
Existence of a monochromatic triangle in every 2-edge-coloring	Graphs with $\Delta \leq 40$	$\Omega\left(\frac{n}{\log n}\right)$	5.10
Non-existence of a Hamiltonian cycle	Graphs with $\Delta \leq 4$	$\Omega\left(\frac{\sqrt{n}}{\log n}\right)$	6.5
Chromatic index equal to $\Delta + 1$	Cubic graphs	$\Omega\left(\frac{n}{\log n}\right)$	6.6

FIGURE 1. Summary of our lower bounds. In this table,  $\Delta$  denotes the maximum degree.

the local complexity should be linear. For the non-existence of a partition into  $k$  acyclic subgraphs, we only have a quasi-linear lower bound, which holds in general graphs. This is probably also not optimal (because in general graphs the universal upper bound is  $O(n^2)$ ). Finally, note also that, except for  $k$ -colorability, our quasi-linear lower bounds that holds in bounded-degree classes remain quasi-linear in general graphs. Again, this is probably not optimal: an interesting open problem would be to determine whether each of them can be improved to quadratic in general graphs.

As alluded to above, in the distributed world “efficient” usually means logarithmic or polylogarithmic. From this point of view, our results show that all these problems have very high local complexity. On the other hand, it turns out that the complement problems all have very low local complexity (either constant or logarithmic).

**Organization of the paper.** We start with some preliminary definitions on graphs and local certification in Section 2. In Section 3, we describe the lower bound on the local complexity of non-3-colorability by Göös and Suomela [14], and explain how to deduce lower bounds in the more specific cases of graphs with maximum degree at most 4, and planar graphs. These lower bounds will be crucial in the remainder of the paper, as all problems we consider will be reduced to one of these problems (directly or indirectly).

In Section 4, we then present as a motivating example a local reduction between non-3-colorability and non- $k$ -colorability, and discuss the main features we expect of

a local reduction. This motivates the general definition of a local reduction between problems that we present in Section 5, together with a number of applications that give polynomial lower bounds for several coNP-hard problems.

Then, in Section 6, we present a variant of our general reduction theorem which allows us to do local reductions from 3-SAT. This is motivated by the fact that it is sometimes much more convenient to do an NP-hardness reduction from 3-SAT rather than from 3-colorability. To illustrate this, we give two applications, for problems having well-known NP-completeness reductions from 3-SAT.

In Section 7, we present a small variant of our general reduction theorem (namely, we give a relaxation of one of the conditions needed to apply it, that holds for properties on bounded-degree graph classes). We present again a direct application. Finally, in Section 8, we show that there is no hope for a much more general theorem stating that any coNP-hard problem has polynomial local complexity: more precisely, we give an example of a coNP-hard problem that has only logarithmic local complexity. We also show that our reduction framework applies not only to coNP-hard problems, by giving examples of reductions showing polynomial lower bounds on the local complexity of some properties that are in P.

## 2. PRELIMINARIES

**2.1. Graphs.** In this paper, graphs are assumed to be simple, loopless, undirected, and connected. The *distance* between two vertices  $u$  and  $v$  in a graph  $G$ , denoted by  $d_G(u, v)$  is the minimum length of a path between  $u$  and  $v$  (that is, its number of edges). The *neighborhood* of a vertex  $v$  in a graph  $G$ , denoted by  $N_G(v)$  (or  $N(v)$  if clear from the context), is the set of vertices at distance exactly 1 from  $v$ . The *closed neighborhood* of  $v$ , denoted by  $N_G[v] := \{v\} \cup N_G(v)$ , is the set of vertices at distance at most 1 from  $v$ . For a set  $S$  of vertices of  $G$ , we define  $N_G[S] := \bigcup_{v \in S} N_G[v]$ . Finally, for every  $k \geq 1$ , we define  $N_G^k[v]$  as the set of vertices at distance at most  $k$  from  $v$  (in particular, we have  $N_G^1[v] = N_G[v]$ ).

**2.2. Local certification.** In all the  $n$ -vertex graphs  $G$  that we consider, the vertices of  $G$  are assumed to be assigned distinct (but otherwise arbitrary) identifiers  $(\text{id}(v))_{v \in V(G)}$  from a set  $\{1, \dots, \text{poly}(n)\}$ . This is a standard assumption in local certification, which is necessary if we want to be able to distinguish a graph from its universal cover (and thus prove any meaningful result). When we refer to a subgraph  $H$  of a graph  $G$ , we implicitly refer to the corresponding labeled subgraph of  $G$ . Note that the identifiers of each of the vertices of  $G$  can be stored using  $O(\log n)$  bits.

We follow the terminology introduced by Göös and Suomela [14].

**Proofs and provers.** A *proof* for a graph  $G$  is a function  $P : V(G) \rightarrow \{0, 1\}^*$  (as  $G$  is a labeled graph, the proof  $P$  is allowed to depend on the identifiers of the vertices of  $G$ ). The binary words  $P(v)$  are called *certificates*. The *size* of  $P$  is the maximum size of a certificate  $P(v)$ , for  $v \in V(G)$ . A *prover* for a graph class  $\mathcal{G}$  is a function that maps every  $G \in \mathcal{G}$  to a proof for  $G$ .

**Local verifiers.** A *verifier*  $\mathcal{A}$  is a function that takes a graph  $G$ , a proof  $P$  for  $G$ , and a vertex  $v \in V(G)$  as inputs, and outputs an element of  $\{0, 1\}$ . We say that  $v$  *accepts* the instance if  $\mathcal{A}(G, P, v) = 1$  and that  $v$  *rejects* the instance if  $\mathcal{A}(G, P, v) = 0$ .

Consider a graph  $G$ , a proof  $P$  for  $G$ , and a vertex  $v \in V(G)$ . We denote by  $G[v]$  the subgraph of  $G$  induced by  $N[v]$ , the closed neighborhood of  $v$ , and similarly we denote by  $P[v]$  the restriction of  $P$  to  $N[v]$ .

A verifier  $\mathcal{A}$  is *local* if for any  $v \in G$ , the output of  $v$  only depends on its identifier and  $P[v]$ .

We note that there is a small difference here with the original setting of Göös and Suomela [14], where the verifier was allowed to depend on  $G[v]$  as well (so vertices have the knowledge of the subgraph induced by their neighborhood). Lower bounds in the setting of Göös and Suomela imply lower bounds in our setting, but the converse does not hold in general. However, in the case of bounded degree graphs (which is the setting of most of our results) the two models are very close, as encoding the subgraphs induced by each neighborhood can be done at an extra cost of  $O(\log n)$  bits per vertex. See also Section 7, for the use of a similar idea, in a related context.

Since the lower bounds of Göös and Suomela [14] on non-3-colorability hold in their stronger setting, all the lower bounds we deduce from it in this paper also hold in their setting (this is the case of all the results of the paper, except those in the final section on the exclusion of subgraphs). Since our goal was to design a general framework for reductions in local certification, we have preferred to work with the weaker setting, which applies more broadly (see [7] for an overview of the different models of local certification).

**Proof labeling schemes.** A *proof labeling scheme* for a graph class  $\mathcal{G}$  is a prover-verifier pair  $(\mathcal{P}, \mathcal{A})$  where  $\mathcal{A}$  is local, with the following properties.

**Completeness:** If  $G \in \mathcal{G}$ , then  $P := \mathcal{P}(G)$  is a proof for  $G$  such that for any vertex  $v \in V(G)$ ,  $\mathcal{A}(G, P, v) = 1$ .

**Soundness:** If  $G \notin \mathcal{G}$ , then for every proof  $P'$  for  $G$ , there exists a vertex  $v \in V(G)$  such that  $\mathcal{A}(G, P', v) = 0$ .

In other words, upon looking at its closed neighborhood (labeled by the identifiers and certificates), the local verifier of each vertex of a graph  $G \in \mathcal{G}$  accepts the instance, while if  $G \notin \mathcal{G}$ , for every possible choice of certificates, the local verifier of at least one vertex rejects the instance.

The *complexity* of the proof labeling scheme is the maximum size of a proof  $P = \mathcal{P}(G)$  for an  $n$ -vertex graph  $G \in \mathcal{G}$ , and the *local complexity* of  $\mathcal{G}$  is the minimum complexity of a proof labeling scheme for  $\mathcal{G}$ . If we say that the complexity is  $O(f(n))$ , for some function  $f$ , the  $O(\cdot)$  notation refers to  $n \rightarrow \infty$ . See [7, 14] for more details on proof labeling schemes and local certification in general.

We implicitly identify every graph property  $\mathcal{P}$ , for instance 3-colorability, or non-3-colorability, with the class of all graphs that satisfy  $\mathcal{P}$ .

### 3. NON-3-COLORABILITY

In what follows, we will use the following result, proved by Göös and Suomela in [14]:

**Theorem 3.1** ([14]). *Non-3-colorability has local complexity  $\Omega(n^2/\log n)$ .*

Since we will use several variants of this result, we give a short description of their construction. For any integer  $k$ , and any two subsets  $A \subseteq [2^k]^2$  and  $B \subseteq [2^k]^2$ , Göös and Suomela construct a graph  $G_{A,B}$  on  $n = \Theta(2^k)$  vertices such that:

- (1)  $G_{A,B}$  can be partitioned into two parts  $V_A$  (such that  $G_{A,B}[V_A]$  depends only on  $A$ ) and  $V_B$  (such that  $G_{A,B}[V_B]$  depends only on  $B$ ).
- (2)  $V_A$  contains a set  $S_A = a_1, \dots, a_s$  of  $\Theta(\log n)$  special vertices, and  $V_B$  contains a set  $S_B = b_1, \dots, b_s$  of  $\Theta(\log n)$  special vertices.
- (3) Each edge between  $V_A$  and  $V_B$  in  $G_{A,B}$  connects a vertex of  $S_A$  to a vertex of  $S_B$ , there are at most  $O(k)$  such edges, and the subgraph of  $G_{A,B}$  induced by the special vertices  $S_A \cup S_B$  is independent of the choice of  $A$  and  $B$ .
- (4)  $G_{A,B}$  is 3-colorable if and only if  $A \cap B \neq \emptyset$ .

Given labelings of two graphs  $G_{A,B}$  and  $G_{C,D}$ , we say that the *labelings agree on their special vertices*, if for every  $1 \leq i \leq s$  the label of  $a_i$  in  $G_{A,B}$  coincides with the label of  $a_i$  in  $G_{C,D}$ , and the label of  $b_i$  in  $G_{A,B}$  coincides with the label of  $b_i$  in  $G_{C,D}$ .

Göös and Suomela [14] observed that since there are only  $O(\log n)$  special vertices, if non-3-colorability can be certified locally with certificates of size  $o(n^2 / \log n)$ , the total number of bits of certificates assigned to the special vertices is  $o(n^2)$ . Since there are  $2^{(2^k)^2} = 2^{\Omega(n^2)}$  choices for the sets  $A$ , it follows from the pigeonhole principle that there exist two distinct sets  $A, B$  such that the certificates of  $G_{A,\bar{A}}$  and  $G_{B,\bar{B}}$  agree on their special vertices. As  $G_{A,\bar{A}}$  and  $G_{B,\bar{B}}$  are both non-3-colorable, in any local certification scheme for 3-non-colorability in these two graphs, each vertex accepts the instance upon reading its local view (i.e., the certificates of its closed neighborhood).

Note that at least one of  $A \cap \bar{B}$  and  $\bar{A} \cap B$  is non-empty, say  $A \cap \bar{B} \neq \emptyset$  by symmetry. Consider the graph  $G_{A,\bar{B}}$ , and assign to the vertices of  $V_A$  their certificates in  $G_{A,\bar{A}}$ , and to the vertices of  $V_{\bar{B}}$  their certificate in  $G_{B,\bar{B}}$ . Observe that the local view of each vertex of  $G_{A,\bar{B}}$  is the same as in  $G_{A,\bar{A}}$  or  $G_{B,\bar{B}}$ , and thus each vertex accepts the instance. Since  $G_{A,\bar{B}}$  is 3-colorable (because  $A \cap \bar{B} \neq \emptyset$ ), we obtain a contradiction.

We now deduce the following variant of the previous result, which will be crucial in most of our arguments.

**Theorem 3.2.** *Non-3-colorability of graphs of maximum degree 4 has local complexity  $\Omega(n / \log n)$ .*

*Proof.* For a graph  $G$ , we construct a new graph  $f(G)$  of maximum degree 4 such that  $G$  is 3-colorable if and only if  $f(G)$  is 3-colorable (this is a classical construction [13]). The graph  $f(G)$  is constructed as follows: for every vertex  $u$  of degree  $d$  in  $G$ , we consider the graph  $G_u$  depicted in Figure 2, where the  $d$  white vertices are indexed by the neighbors of  $u$  in  $G$ . Observe that in any 3-coloring of  $G_u$ , all the white vertices receive the same color. The graph  $f(G)$  is obtained by taking the disjoint union of all graphs  $G_u$ , for  $u \in V(G)$ , and adding, for every edge  $uv \in E(G)$ , an edge between the vertex of  $G_u$  indexed by  $v$  and the vertex of  $G_v$  indexed by  $u$ . Note that  $f(G)$  has maximum degree 4 and is 3-colorable if and only if  $G$  is 3-colorable. As each graph  $G_u$  contains at most  $8d_G(u)$  vertices,  $f(G)$  contains at most  $16|E(G)| \leq 8|V(G)|^2$  vertices.

For any integer  $k$ , and any two subsets  $A \subseteq [2^k]^2$  and  $B \subseteq [2^k]^2$ , we consider the graph  $G_{A,B}$  of Göös and Suomela [14] introduced above, and we let  $H_{A,B} = f(G_{A,B})$ . Note that  $H_{A,B}$  contains  $n = \Theta(2^{2k})$  vertices, and moreover:

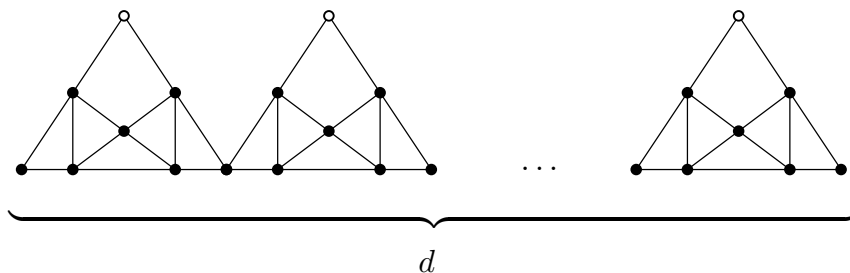

 FIGURE 2. The graph  $G_u$ .

- (1)  $H_{A,B}$  can be partitioned into two parts  $V_A$  (such that  $H_{A,B}[V_A]$  depends only on  $A$ ) and  $V_B$  (such that  $H_{A,B}[V_B]$  depends only on  $B$ ).
- (2)  $V_A$  contains a set  $S_A$  of  $\Theta(\log n)$  special vertices, and  $V_B$  contains a set  $S_B$  of  $\Theta(\log n)$  special vertices.
- (3) Each edge between  $V_A$  and  $V_B$  in  $G_{A,B}$ , connects a vertex of  $S_A$  to a vertex of  $S_B$ , and the subgraph of  $G_{A,B}$  induced by the special vertices  $S_A \cup S_B$  is independent of the choice of  $A$  and  $B$ .
- (4)  $G_{A,B}$  is 3-colorable if and only if  $A \cap B \neq \emptyset$ .

The fact that the sets  $S_A$  and  $S_B$  still have size  $O(\log n)$  in  $H_{A,B}$  follows from item 3 in the properties of  $G_{A,B}$  (the fact that there are only  $O(\log n)$  edges with one endpoint in  $S_A$  and one endpoint in  $S_B$ ).

As above, if non-3-colorability can be certified locally with certificates of size  $o(n/\log n)$  in graphs of maximum degree 4, the total number of bits of certificates assigned to the special vertices of  $H_{A,B}$  is  $o(n)$ . Since there are  $2^{(2^k)^2} = 2^{\Omega(n)}$  choices for the sets  $A$ , it follows from the pigeonhole principle that there exist two distinct sets  $A, B$  such that the certificates of  $G_{A,\bar{A}}$  and  $G_{B,\bar{B}}$  agree on their special vertices. We then obtain a contradiction using the same fooling set argument as above.  $\square$

Using a classical uncrossing technique we obtain the following variant for planar graphs (of bounded degree).

**Theorem 3.3.** *Non-3-colorability of planar graphs of maximum degree 4 has local complexity  $\Omega(\sqrt{n}/\log^2 n)$ .*

*Proof.* We start with the graph  $H_{A,B}$  constructed in the proof of Theorem 3.2, and draw it in the plane with  $V_A$  inside a region  $R_A$ ,  $V_B$  inside a region  $R_B$  disjoint from  $R_A$ , with the vertices of  $S_A$  lying on the boundary of  $R_A$  and the vertices  $S_B$  lying on the boundary of  $R_B$ . Moreover we make sure that the bipartite graph induced by the edge  $E(S_A, S_B)$  with one endpoint in  $S_A$  and the other in  $S_B$  is drawn outside of the interior of  $R_A$  and  $R_B$  (so that the edges between  $S_A$  and  $S_B$  do not cross any other edge of  $H_{A,B}[V_A]$  and  $H_{A,B}[V_B]$ ), see Figure 3. We call crossings between edges of  $E(S_A, S_B)$  *special crossings*.

We then use uncrossing gadgets introduced in [13] (see Figure 4 for an illustration). Let  $P_{A,B}$  be the resulting planar graph (which is 3-colorable if and only if  $A \cap B \neq \emptyset$ ). Note that the number of vertices of  $P_{A,B}$  is equal to the number of vertices of  $H_{A,B}$  plus a constant number of vertices per crossing. As  $H_{A,B}$  has  $n = \Theta(2^{2k})$  vertices and maximum degree 4, it has  $\Theta(2^{2k})$  edges and thus at most  $O(2^{4k})$  edge crossings. It follows that the planar graph  $P_{A,B}$  has  $O(2^{4k})$  vertices. Note that  $P_{A,B}$  has maximum degree  $4 \cdot 3 = 12$ , as  $H_{A,B}$  has maximum degree 4.

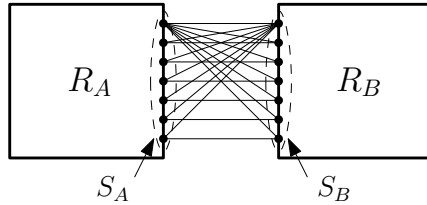

FIGURE 3. Drawing  $H_{A,B}$  in the plane before the addition of uncrossing gadgets.

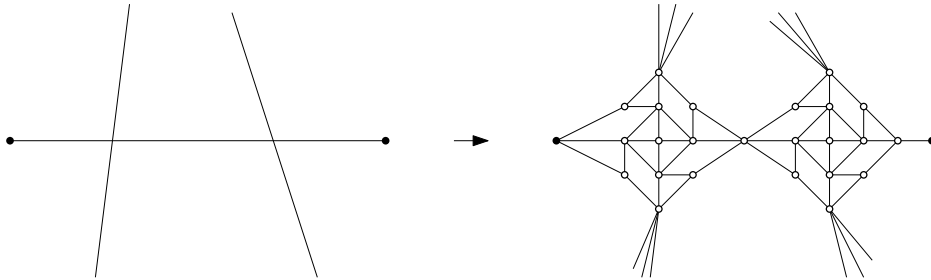

FIGURE 4. Uncrossing gadgets.

As  $S_A$  and  $S_B$  have size  $O(\log n)$  in  $H_{A,B}$  and this graph has maximum degree 4,  $E(S_A, S_B)$  contains  $O(\log n)$  edges, and thus there are  $O(\log^2 n)$  special crossings. It follows that there are  $O(\log^2 n)$  special vertices in  $P_{A,B}$  (as each new crossing of  $H_{A,B}$  creates a constant number of new vertices in  $P_{A,B}$ ).

We now consider  $P'_{A,B} = f(P_{A,B})$  (the graph obtained from  $P_{A,B}$  by applying the maximum degree 4 reduction of the proof of Theorem 3.2). This graph is a planar graph with maximum degree 4, is 3-colorable if and only if  $A \cap B \neq \emptyset$ , has  $n = O(2^{4k})$  vertices, but only contains  $O(\log^2 n)$  special vertices. There are  $2^{(2^k)^2} = 2^{2^{2k}} = 2^{\Omega(\sqrt{n})}$  choices for the set  $A$ , so if we can locally certify non-3-colorability with certificates of size  $o(n^{1/2}/\log^2 n)$  then the total number of bits of certificates assigned to the special vertices is  $o(n^{1/2})$  and thus there are two distinct sets  $A, B$  such that the certificates of  $P'_{A,\bar{A}}$  and  $P'_{B,\bar{B}}$  agree on their special vertices. We then obtain a contradiction using the same fooling set argument as above.  $\square$

*Remark 3.4.* A closer inspection of the construction of Göös and Suomela [14] yields that the subgraph between the special vertices  $S_A$  and  $S_B$  can be drawn in the plane with just  $O(\log n)$  crossings (instead of  $O(\log^2 n)$  in the proof above). This implies that the lower bound on the size of the certificates in Theorem 3.3 can be increased to  $\Omega(n^{1/2}/\log n)$ . As we do not believe that the exponent  $1/2$  is best possible we omit the details.

#### 4. NON- $k$ -COLORABILITY

In this section we explain how to obtain a  $\Omega(n^2/\log n)$  lower bound on the local complexity of non- $k$ -colorability, for every  $k > 3$ , using the results of the previous section. This will also be a direct consequence of our main reduction result, Theorem 5.2, but since the statement of this theorem is quite technical we prefer to illustrate the main ideas of the proof with this simple example before actually stating the theorem.



So let us prove that at least  $\Omega(n^2/\log n)$  bits are necessary to locally certify non- $k$ -colorability for every  $k \geq 4$ . Assume that there is a proof labeling scheme of complexity  $f(n)$  for this problem, and consider a graph  $G$  for which we wish to certify that  $G$  is not 3-colorable. The main idea will be to simulate locally the construction of a graph  $G'$ , so that  $G'$  is  $k$ -colorable if and only if  $G$  is 3-colorable, use the local certificates of non- $k$ -colorability of  $G'$  and assign them to the vertices of  $G$ , in such a way that  $G$  can also simulate the verification of the certificates of  $G'$ .

**First attempt.** We start by defining the graph  $G'$  as the graph obtained from  $G$  by adding  $k - 3$  universal vertices (such a graph  $G'$  is  $k$ -colorable if and only if  $G$  is 3-colorable).

Given a proof labeling scheme for non- $k$ -colorability in  $G'$ , our goal is to assign to each vertex  $u \in V(G)$  the list of certificates of a subset  $C_u$  of vertices of  $G'$ , together with their identifiers, in such a way that  $u$  can simulate the verification procedure of a subset  $V_u$  of vertices of  $G'$ . In this case, our choice for  $C_u$  and  $V_u$  is the following: for any  $u \in V(G)$ , we set  $C_u = V(G')$  (that is, we assign to each vertex of  $G$  the list of the certificates of all the vertices of  $G'$  together with their identifier), and  $V_u$  consists of  $u$  together with the  $k - 3$  universal vertices of  $G'$ . This allows each vertex  $u \in V(G)$  to simulate the verification process of the corresponding vertex in  $G'$ , since its local view in  $G'$  consists of its neighbors in  $G$ , together with the universal vertices. Each vertex  $u \in V(G)$  also simulates the verification of the  $k - 3$  universal vertices (whose local view is the whole graph). Now each vertex  $u \in V(G)$  accepts the instance if and only if it would have accepted the instance in  $G'$  and each of the universal vertices would also have accepted the instance in  $G'$ . The size of the certificates is at most  $n$  times the size of the certificates for non- $k$ -colorability, so by Theorem 3.1 this shows that non- $k$ -colorability requires certificates of size  $\frac{1}{n} \cdot \Omega(n^2/\log n) = \Omega(n/\log n)$ .

It immediately feels that adding universal vertices is very far from being a local operation, and that this should be avoided as far as possible. Let us now consider a second (more local) way of defining the graph  $G'$ .

**Second attempt.** The new graph  $G'$  is obtained from the disjoint union of two graphs  $G_0$  and  $G_1$  defined as follows. The graph  $G_0$  is an isomorphic copy of  $G$ . The graph  $G_1$  is obtained from the graph  $G$  by replacing each vertex  $u$  by a clique of size  $k$  with vertices numbered from 1 to  $k$ . We denote this clique by  $K_u$ , and for any  $1 \leq i \leq k$ , the vertex numbered  $i$  in  $K_u$  is denoted by  $K_u[i]$ . Finally, each edge  $uv$  of  $G$  is replaced by an antimatching between  $K_u$  and  $K_v$  in  $G_1$  (that is, for any  $i \neq j$  we add an edge between  $K_u[i]$  and  $K_v[j]$  in  $G_1$ ). The edges between  $G_0$  and  $G_1$  are the following: for each  $u \in V(G_0)$ , we put an edge between  $u$  and  $K_u[i]$  for every  $i \in \{4, \dots, k\}$ . We can define an identifier for each vertex of  $G'$  describing whether it belongs to  $G_0$ , or to  $G_1$  (and its number from  $\{1, \dots, k\}$  in the latter the case), together with the identifier of the corresponding vertex in  $G$ . All this information can be encoded on  $O(\log n)$  bits.

It is straightforward to show that  $G$  is 3-colorable if and only if  $G'$  is  $k$ -colorable: indeed, the antimatchings enforce that, in any  $k$ -coloring of  $G'$ , for each  $i \in \{1, \dots, k\}$  the vertices from  $\{K_v[i] : v \in V(G)\}$  all have the same color, and thus there are only three possible remaining colors for the vertices of  $G_0$ , which is an isomorphic copy of  $G$ .

For every  $u \in V(G)$ , we define  $V_u := C_u$  as being the union of the copy of  $u$  in  $G_0$  and the clique  $K_u$  in  $G_1$  (as above,  $C_u$  is the list of vertices of  $G'$  whose certificate will be given to  $u$  and  $V_u$  is the set of vertices of  $G'$  whose verification process will be simulated by  $u$ ). See Figure 4 for an example. Note that these lists of certificates are enough for each vertex  $u$  of  $V(G)$  to simulate the verification process of  $V_u$ , as for any neighbor  $w$  of a vertex  $v \in V_u$  in  $G'$ , the certificate of  $w$  in  $G'$  will be contained in the certificate assigned to some neighbor of  $u$  in  $G$ .

Finally, let us compute the size of certificates in the resulting proof labeling scheme for non-3-colorability, assuming the local complexity of non- $k$ -colorability is  $f(n)$ . If  $G$  has  $n$  vertices, then  $G'$  has  $(k+1)n$  vertices. So the size of the certificate assigned to each vertex of  $G$  is  $(k+1)(O(\log n) + f((k+1)n))$ . As  $k$  is constant, it follows from Theorem 3.1 that non- $k$ -colorability requires certificates of size  $\Omega(n^2/\log n)$ , as desired. Note also that, if  $G$  has maximum degree 4, then  $G'$  has maximum degree  $5k - 4$ . Thus, it follows from Theorem 3.2 that non- $k$ -colorability requires certificates of size  $\Omega(n/\log n)$  in graphs of maximum degree  $5k - 4$ .

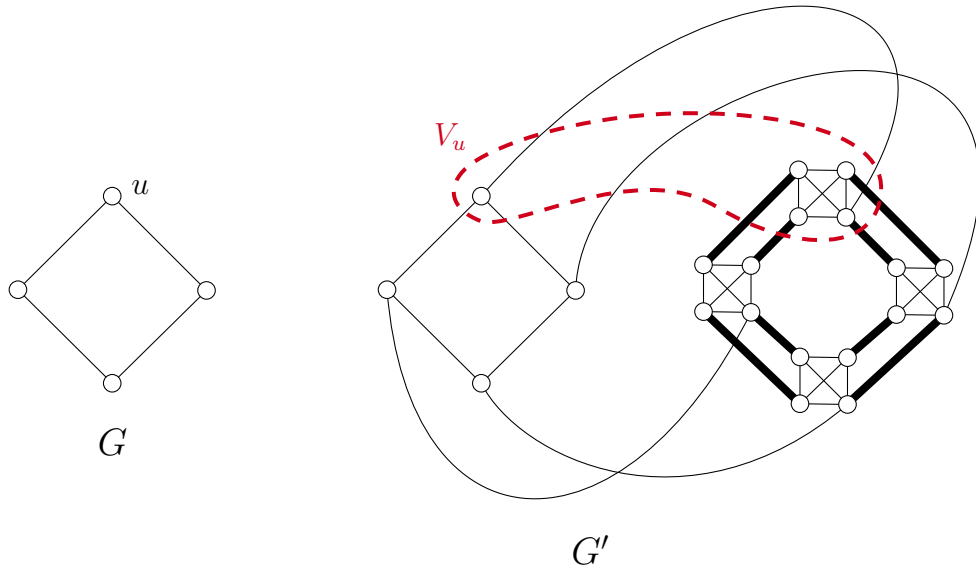

FIGURE 5. The graph  $G'$  when  $k = 4$  and  $G$  is a cycle of length 4. The thick double edges between the cliques represent the antimatchings.

We have thus proved the following extension of Theorems 3.1 and 3.2.

**Theorem 4.1.** *For any fixed  $k \geq 3$ , non- $k$ -colorability has local complexity at least  $\Omega(n^2/\log n)$  in general graphs, and at least  $\Omega(n/\log n)$  in graphs of maximum degree  $5k - 4$ .*

*Remark 4.2.* In Section 7, we will prove that non- $k$ -colorability has local complexity at least  $\Omega(n/\log n)$  even in graphs of maximum degree  $k + \lceil \sqrt{k} \rceil - 1$  (see Theorem 7.1).

In the next section, we identify the key components of the proof above and explain how it can be used to define a general class of local reductions between graph

problems. In particular we formalize the necessary and sufficient conditions on the sets  $V_u$  and  $C_u$  allowing the local simulation of the verification process, and show how the relative sizes of these two sets influence the relation between the local complexities of the two problems.

### 5. REDUCTIONS FROM $\mathcal{P}$ TO $\mathcal{P}'$

Let  $\mathcal{C}, \mathcal{C}'$  be two graph classes, and  $\mathcal{P}, \mathcal{P}'$  be two graph properties on  $\mathcal{C}, \mathcal{C}'$  respectively. Let  $\alpha, \beta : \mathbb{N} \rightarrow \mathbb{N}$ , with  $\beta(n) \geq n$  for every integer  $n$ .

We say that there exists a *local reduction* from  $\mathcal{P}$  to  $\mathcal{P}'$  with local expansion  $\alpha$  and global expansion  $\beta$  if there exists a function  $f_{\mathcal{P}, \mathcal{P}'}$  which takes as input a graph  $G \in \mathcal{C}$  with  $n$  vertices and unique identifiers in  $\{1, \dots, n\}$ <sup>1</sup>, and outputs a graph (with unique identifiers)  $G' = f_{\mathcal{P}, \mathcal{P}'}(G) \in \mathcal{C}'$  having at most  $\beta(n)$  vertices, such that the following properties are satisfied for all  $G$ :

- (R1) the identifiers of  $G'$  are written on  $O(\log n)$  bits,
- (R2)  $G$  satisfies  $\mathcal{P}$  if and only if  $G'$  satisfies  $\mathcal{P}'$ ,
- (R3) for every vertex  $u$  of  $G$ , there exist two sets  $C_u, V_u \subseteq V(G')$ , such that, for every  $u \in V(G)$ , the following properties are satisfied:
  - (a)  $V_u \subseteq C_u$ ,
  - (b)  $\bigcup_{v \in V(G)} V_v = V(G')$ ,
  - (c)  $|C_u| \leq \alpha(n)$ ,
  - (d) for every  $t \in V(G')$ , the subgraph of  $G$  induced by  $\{v \in V(G) \mid t \in C_v\}$  is connected,
  - (e) for every  $t \in V_u$ ,  $N_{G'}[t]$  is included in  $\bigcup_{v \in N_G[u]} C_v$ ,
  - (f)  $V_u$  and its neighborhood (resp.  $C_u$ ) only depend on the identifiers of the vertices in  $N_G[u]$ . In other words: if  $H$  is another  $n$ -vertex graph from  $\mathcal{C}$  with unique identifiers in  $\{1, \dots, n\}$ , and if the subgraph with identifiers formed by  $u$  and its adjacent edges is the same in  $G$  and  $H$ , then the sets  $V_u$  and the subgraphs with identifiers formed by the vertices in  $V_u$  and their adjacent edges in  $G'$  and  $H' = f_{\mathcal{P}, \mathcal{P}'}(H)$  are the same (resp. the sets  $C_u$  are the same in  $G'$  and  $H'$ ).

Let us elaborate on the different parts of the definition of a local reduction, in view of the results from the previous section. Condition (R1) says that there is no significant blow-up in the size of  $G'$  compared to that of  $G$  ( $G'$  has size polynomial in that of  $G$ ). It also states implicitly that there is a way to describe the identifiers of  $G'$  as a function of the identifiers of  $G$ . Condition (R2) is the underlying principle of a reduction. In condition (R3), the set  $V_u$  again stands for the subsets of vertices of  $G'$  whose verification in  $G'$  will be simulated by the vertex  $u$  of  $G$ , and  $C_u$  corresponds to the set of vertices of  $G'$  whose certificates will be given to  $u$ . It is reasonable to require that  $u$  is given the certificates of the vertices it is supposed to simulate (that is  $V_u \subseteq C_u$ , according to (R3a)). It is not strictly necessary, as  $u$  could also find the certificates of some vertices of  $V_u$  in the certificates assigned to its neighbors in  $G$ , but assuming  $V_u \subseteq C_u$  makes some of our arguments simpler. Condition (R3b) simply says that every vertex of  $G'$  has to be simulated by at least one vertex of  $G$ . Condition (R3d) is necessary to make sure that if the certificate of  $t$  in  $G'$  is

<sup>1</sup>We emphasize that the range of identifiers is more restricted than in the definition of local certification, where they were assumed to be in  $\{1, \dots, n^c\}$ , for some  $c \geq 1$ . This is just to make the applications of our framework easier (but we will show that we do not lose any level of generality).

given to several vertices of  $G$ , then all these vertices are given the same certificate. Condition (R3e) is simply saying that in order to simulate the verification process of every vertex of  $V_u$  in  $G'$ ,  $u$  has all the required certificates in its neighborhood in  $G$ . Finally, condition (R3f) makes sure  $u$  can reconstruct the local views of all vertices of  $V_u$  in  $G'$ , only based on its local view in  $G$ .

It is perhaps useful to comment on the local and global expansion functions  $\alpha$  and  $\beta$ . In the first attempt in Section 4, the global expansion was reasonable (the size of  $G'$  was linear in the size of  $G$ ), but the local expansion was maximal, as  $C_u$  was the set of all vertices. In our second attempt, the global expansion was still reasonable (the size of  $G'$  was again linear in the size of  $G$ ), but the local expansion was bounded by a constant.

*Remark 5.1.* From the definition of a local reduction, we can make the following observations:

- Every local reduction from  $\mathcal{P}$  to  $\mathcal{P}'$  with local expansion  $\alpha$  has global expansion at most  $n\alpha(n)$ . This follows from properties (R3a), (R3b) and (R3c). In particular, for every  $\delta > 0$ , every local reduction with local expansion  $O(n^\delta)$  has global expansion  $O(n^{\delta+1})$ .
- The definition of local reduction is symmetric between properties and their complement. In other words: there exists a local reduction from  $\mathcal{P}$  to  $\mathcal{P}'$  if and only if there exists a local reduction from  $\overline{\mathcal{P}}$  to  $\overline{\mathcal{P}'}$ , the local and global expansions are the same, and we have  $f_{\mathcal{P},\mathcal{P}'} = f_{\overline{\mathcal{P}},\overline{\mathcal{P}'}}$ .

We now prove that, as expected, whenever we have a local reduction from a problem  $\mathcal{P}$  to a problem  $\mathcal{P}'$ , any local certification scheme for  $\mathcal{P}'$  can be turned into a local certification scheme for  $\mathcal{P}$ . This implies that lower bounds on the local complexity of  $\mathcal{P}$  can be used to prove lower bounds on the local complexity of  $\mathcal{P}'$ , assuming the local and global expansion factors in the local reduction are not too large.

**Theorem 5.2.** *Assume that:*

- *there exists a certification scheme for  $\mathcal{P}'$  with certificates of size  $s(n)$ , where  $s : \mathbb{N} \rightarrow \mathbb{N}$  is an increasing function satisfying  $s(n) = \Omega(\log n)$ , and*
- *there exists a local reduction from  $\mathcal{P}$  to  $\mathcal{P}'$  with local expansion  $\alpha$  and global expansion  $\beta$ .*

*Then there exists a certification scheme for  $\mathcal{P}$  with certificates of size  $O(\alpha(n) \cdot s(\beta(n)))$ .*

Before proving Theorem 5.2, let us give the following immediate corollary (which is the result that we will use in practice to prove lower bounds).

**Corollary 5.3.** *Let  $\mathcal{P}$  be a graph property (on some graph class  $\mathcal{C}$ ) and let  $k \geq 3$ .*

- (1) *If there exists a local reduction from  $k$ -colorability (in general graphs) to  $\mathcal{P}$  with local expansion  $O(n^\delta)$  for some  $0 \leq \delta < 2$ , and global expansion  $O(n^\gamma)$ , then  $\overline{\mathcal{P}}$  has local complexity  $\Omega(n^{(2-\delta)/\gamma} / \log n)$ . In particular, since  $\gamma \leq \delta + 1$ ,  $\overline{\mathcal{P}}$  has local complexity  $\Omega(n^{\frac{3}{\delta+1}-1} / \log n)$ .*
- (2) *If there exists a local reduction from  $k$ -colorability in graphs of maximum degree  $k + \lceil \sqrt{k} \rceil - 1$  to  $\mathcal{P}$  with local expansion  $O(n^\delta)$  for some  $0 \leq \delta < 1$ , and global expansion  $O(n^\gamma)$ , then  $\overline{\mathcal{P}}$  has local complexity  $\Omega(n^{(1-\delta)/\gamma} / \log n)$ . In particular, since  $\gamma \leq \delta + 1$ ,  $\overline{\mathcal{P}}$  has local complexity  $\Omega(n^{\frac{2}{\delta+1}-1} / \log n)$ .*

*Proof.* (1) By contradiction, assume that there exists a certification scheme for  $\overline{\mathcal{P}}$  with certificates of size  $o(n^{(2-\delta)/\gamma}/\log n)$ . By Theorem 5.2, there exists a certification scheme for non- $k$ -colorability with certificates of size

$$o\left(n^\delta \cdot \frac{(n^\gamma)^{(2-\delta)/\gamma}}{\log n}\right) = o\left(\frac{n^2}{\log n}\right),$$

which contradicts Theorem 4.1

- (2) By contradiction, assume that there exists a certification scheme for  $\overline{\mathcal{P}}$  with certificates of size  $o(n^{(1-\delta)/\gamma}/\log n)$ . By Theorem 5.2, there exists a certification scheme for non- $k$ -colorability in graphs of maximum degree  $k + \lceil \sqrt{k} \rceil - 1$  with certificates of size  $o\left(n^\delta \cdot \frac{(n^\gamma)^{(1-\delta)/\gamma}}{\log n}\right) = o\left(\frac{n}{\log n}\right)$ , which contradicts Theorem 4.1 and Remark 4.2.  $\square$

*Proof of Theorem 5.2.* Let  $G \in \mathcal{C}$  be an  $n$ -vertex graph in which the vertices are given unique identifiers on  $O(\log n)$  bits. First, using a renaming technique from [2], we can assume that the unique identifiers  $(\text{id}(u))_{u \in V(G)}$  of  $G$  are in  $\{1, \dots, n\}$ , at a cost of  $O(\log n)$  additional bits per certificates. Since  $s(n) = \Omega(\log n)$  and  $\beta(n) \geq n$ , we have  $\log n = O(\alpha(n) \cdot s(\beta(n)))$ , so it does not affect the final bound. We also assume that every vertex knows  $n$  (because it can also be certified at a cost of  $O(\log n)$  bits in the certificates using a spanning tree, see [7] for more details).

**Certification.** The certification of  $\mathcal{P}$  for  $G$  consists in the following. The certificate given by the prover to each vertex consists in a table. For every  $u \in V(G)$ , we will denote this table by  $\text{Table}(u)$ . To construct this table, the prover first computes the graph  $G' = f_{\mathcal{P}, \mathcal{P}'}(G)$ , and for every vertex  $u \in V(G)$ , it determines the sets  $C_u$  and  $V_u$ . The entries of  $\text{Table}(u)$  are indexed by the identifiers in  $G'$  of the vertices in  $C_u$ . For every  $t \in C_u$ , we will denote by  $\text{Table}(u)[t]$  the entry of  $\text{Table}(u)$  indexed by the identifier of  $t$ . The prover writes in  $\text{Table}(u)[t]$  the certificate that  $t$  would get in the certification scheme for  $\mathcal{P}'$  in  $G'$ .

Let us show that these certificates have size  $O(\alpha(n) \cdot s(\beta(n)))$ . By definition of global expansion, the graph  $G'$  has at most  $\beta(n)$  vertices. Thus, each certificate (corresponding to the proof labeling scheme for  $\mathcal{P}'$  in  $G'$ ) written in  $\text{Table}(u)$  has size at most  $s(\beta(n))$ . Since this table has at most  $\alpha(n)$  entries (one for each vertex in  $C_u$ ), its size is  $O(\alpha(n) \cdot s(\beta(n)))$ .

**Verification.** The verification procedure of each vertex  $u \in V(G)$  consists in the following steps. At each step, if the verification fails, the procedure stops and  $u$  rejects the instance.

- (1) First, by condition (R3f),  $u$  can compute the identifiers of all the vertices in  $C_u$ . It checks that every vertex in  $C_u$  has exactly one entry in  $\text{Table}(u)$ , and conversely that every entry in  $\text{Table}(u)$  is indexed with the identifier of a vertex in  $C_u$ .
- (2) Then,  $u$  checks that, for every  $t \in C_u$  and every  $v \in N_G[u]$  having an entry indexed by  $t$  in  $\text{Table}(v)$ , we have  $\text{Table}(u)[t] = \text{Table}(v)[t]$ .
- (3) Finally,  $u$  does the following. By condition (R3f),  $u$  can compute the set  $V_u$  and the subgraph (with identifiers) of  $G'$  formed by  $V_u$  and the adjacent edges. In particular, for every  $t_0 \in V_u$ ,  $u$  can compute the subgraph of  $G'$  formed by  $t_0$  and its incident edges.

Let  $t_0 \in V_u$ . Since  $V_u \subseteq C_u$ ,  $u$  can determine the certificate that  $t_0$  would have in the certification scheme for  $\mathcal{P}'$  in  $G'$ , because it is written in  $\text{Table}(u)[t_0]$ . Moreover, by condition (R3e), every neighbor  $t$  of  $t_0$  in  $G'$  is in  $\bigcup_{v \in N_G[u]} C_v$ , so  $u$  can also determine the certificate of  $t$  because it is written in  $\text{Table}(v)[t]$  for some  $v \in N_G[u]$ .

Thus, for all  $t_0 \in V_u$ ,  $u$  can recover the certificates of all the vertices in  $N_{G'}[t_0]$ , so  $u$  can compute the local view of  $t_0$  in  $G'$ , and can apply the verification procedure of the proof labeling scheme for  $\mathcal{P}'$  in  $G'$ . If this fails for some  $t_0 \in V_u$ , then  $u$  rejects.

(4) If  $u$  did not reject at any previous step,  $u$  accepts the instance.

Let us prove that this proof labeling scheme for  $\mathcal{P}$  is correct, by proving its completeness and its soundness.

**Completeness.** Assume that  $G$  satisfies  $\mathcal{P}$  (and thus  $G'$  satisfies  $\mathcal{P}'$ ), and let us prove that with the assignment of the certificates described above, every vertex accepts the instance. First, no vertex can reject at steps (i) or (ii), because the prover correctly wrote in  $\text{Table}(u)$  the list of the certificates that all the vertices in  $C_u$  would receive in the proof labeling scheme for  $\mathcal{P}'$  in  $G'$ . Let us look at step (iii). Since  $G'$  satisfies  $\mathcal{P}'$ , all the vertices of  $G'$  accept the instance in the labeling scheme for  $\mathcal{P}'$  in  $G'$ . Hence, all the vertices in  $V_u$  accept, and so  $u$  cannot reject the instance at step (iii). Finally, since it did not reject before,  $u$  accepts the instance at step (iv).

**Soundness.** Assume now that all the vertices of  $G$  accept the instance given some assignment of certificates, and let us show that in this case  $G$  satisfies  $\mathcal{P}$ . By property 2 of the definition of a local reduction, it is enough to prove that  $G'$  satisfies  $\mathcal{P}'$ . By property (R3f), every vertex  $u$  can indeed compute the sets  $C_u$ ,  $V_u$ , and the subgraph of  $G'$  formed by the vertices in  $V_u$  and their incident edges. Since  $u$  did not reject the instance at step (i),  $\text{Table}(u)$  has exactly one entry for each vertex  $t \in C_u$ .

To prove that  $G'$  satisfies  $\mathcal{P}'$ , it is sufficient to show that there exists an assignment of certificates to the vertices of  $G'$  such that the verification procedure for  $\mathcal{P}'$  accepts at every vertex. Let  $t \in V(G')$ . By property (R3a) and (R3b), there exists  $u \in V(G)$  such that  $t \in C_u$ . Let us show that, for every other vertex  $w \in V(G)$  such that  $t \in C_w$ , we have  $\text{Table}(u)[t] = \text{Table}(w)[t]$ . By property (R3d), the subgraph of  $G$  induced by the set  $\{v \in V(G) \mid t \in C_v\}$  is connected. So there exists a path  $u_1, \dots, u_k$  in  $G$  such that  $u_1 = u$ ,  $u_k = w$ , and  $t \in C_{u_i}$  for every  $i \in \{1, \dots, k\}$ . For every  $i \in \{1, \dots, k-1\}$ , since  $u_i$  did not reject at step (ii) of the verification procedure, we have  $\text{Table}(u_i)[t] = \text{Table}(u_{i+1})[t]$ . This implies  $\text{Table}(u)[t] = \text{Table}(w)[t]$ .

Hence, for every  $t \in V(G')$ , we can define  $c(t)$  as the certificate of  $t$  written in  $\text{Table}(u)[t]$  for all the vertices  $u \in V(G)$  such that  $t \in C_u$ . By the previous discussion,  $c(t)$  exists and is well defined. Let us show that with the certificate assignment  $c$ , all the vertices in  $G'$  accept the instance. Let  $t \in V(G')$ , and let  $u \in V(G)$  such that  $t \in V_u$  (such a vertex  $u$  exists by property (R3b)). At step (iii),  $u$  computes the view of  $t$  in  $G'$ , with the certificate assignment  $c$ . Then,  $u$  simulates the verification procedure of  $t$  (in the certification scheme for  $\mathcal{P}'$  in  $G'$ ). Since  $u$  accepts, then  $t$  must accept with the certificates given by  $c$ . Since this is the case for every  $t \in V(G')$ , this shows that  $G'$  satisfies  $\mathcal{P}'$ , and thus  $G$  satisfies  $\mathcal{P}$ , which concludes the proof.  $\square$

We now explain how our local reduction framework, namely Theorem 5.2 and Corollary 5.3, can be combined with the lower bounds for non-3-colorability from



Section 3 to provide optimal (or close to optimal) lower bounds on the local complexity of a number of coNP-hard problems.

All the problems that we study later in this section are mentioned in the book by Garey and Johnson [13], but the reference for each of them is either an unpublished result or a personal communication. Thus, we present here some reductions that we found, which are maybe the same as the ones cited in [13], but to our knowledge, these reductions do not appear in any prior publication. Note that, for the problem of determining whether there exists a cubic subgraph, some reductions were already published (see e.g. [19, 20]), but to our knowledge they are all different from the one we present here (we do not use these previous reductions here, because they are not sufficiently local).

**5.1. Domatic number.** A *dominating set* in a graph  $G$  is a subset  $S$  of vertices such that every vertex of  $G$  is in  $S$  or is adjacent to a vertex of  $S$ . The *domatic number* of a graph  $G$  is the maximum integer  $k$  such that the vertex set of  $G$  can be partitioned into  $k$  dominating sets.

**Theorem 5.4.** *The property of having domatic number at most two has local complexity  $\Omega(n/\log n)$ , even in graphs of maximum degree at most 8.*

*Proof.* Let  $\mathcal{P}$  be the property of having domatic number at least 3. We will show that there exists a local reduction from 3-colorability in graphs of maximum degree 4 to  $\mathcal{P}$  with local expansion  $O(1)$ , and the result will follow from Corollary 5.3. Let  $G$  be a graph of maximum degree at most 4, with  $n$  vertices having unique identifiers in  $\{1, \dots, n\}$ .

The construction of the graph  $G' = f_{3\text{-col}, \mathcal{P}}(G)$  is the following. For each edge  $uv \in E(G)$ , we add a new vertex  $w$  connected only to  $u$  and  $v$  (see Figure 6).

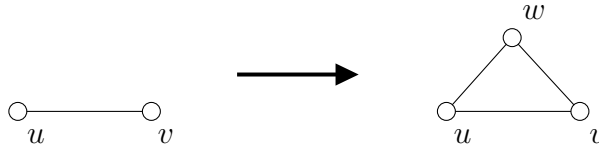
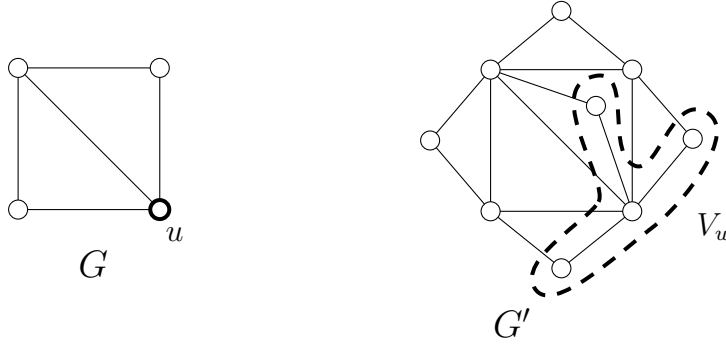

FIGURE 6. The reduction from 3-colorability to domatic number at least 3.

The identifier of each vertex in  $G'$  indicates if it is a vertex of  $G$  (and which one), or a vertex added for an edge of  $G$  (and which edge). This information can be encoded on  $O(\log n)$  bits.

For each vertex  $u$  of  $G$ , we define  $C_u := V_u$  as the set containing  $u$  and all the vertices corresponding to an edge  $uv$  in  $G$  (see Figure 7).

Let us show that  $G$  admits a proper 3-coloring if and only if the domatic number of  $G'$  is at least 3. Assume that  $G$  is 3-colorable. Then, we create a partition of the vertices of  $G'$  in the following way: we keep the partition into color classes, and for each new vertex  $w$  corresponding to an edge  $uv$  of  $G$ , we assign it to the part to which neither  $u$  nor  $v$  belongs to. See Figure 8 for an example. Each part of the partition is a dominating set: indeed, each vertex of  $G'$  belongs to some triangle formed by two original adjacent vertices of  $G$  and the new vertex corresponding to the edge, and by construction, each of the three parts of the partition dominates this triangle. Conversely, assume that the vertices of  $G'$  can be partitioned into at least 3 dominating sets. Then, we obtain a proper 3-coloring of  $G$  by restricting this

FIGURE 7. Some graphs  $G$  and  $G' = f_{3\text{-col},\mathcal{P}}(G)$ .

partition to the original vertices of  $G$ : indeed, let  $uv$  be an edge of  $G$ , and  $w$  be the vertex of  $G'$  corresponding to this edge. Since there are only three vertices in  $N[w]$  (which are  $u$ ,  $v$  and  $w$ ), these 3 vertices are in different parts of the partition and the partition consists of exactly 3 dominating sets (otherwise, some part does not dominate  $w$ ). In particular,  $u$  and  $v$  are in different parts, and the corresponding 3-coloring of  $G$  is indeed proper.

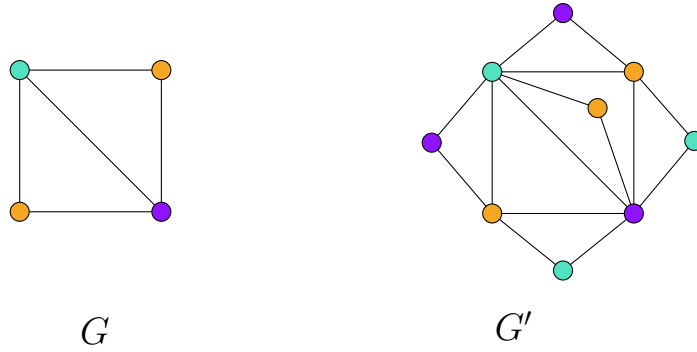
FIGURE 8. The transformation from a proper 3-coloring of  $G$  to a partition in 3 dominating sets of  $G' = f_{3\text{-col},\mathcal{P}}(G)$ . In the drawing of  $G'$ , the colors correspond to the parts of the partition.

Finally, let us show that the conditions of the definition of local reduction are satisfied. We have already seen that (R1) and (R2) both hold. Properties (R3a), (R3b), (R3e) and (R3f) simply follow from the definition of  $V_u$  and  $C_u$ . For (R3c), since  $G$  has maximum degree at most 4, for all  $u \in V(G)$  we have  $|C_u| \leq 5$  and thus  $|C_u| = O(1)$ . For (R3d), if  $C_u \cap C_v \neq \emptyset$ , then  $u$  and  $v$  are neighbors. So all conditions of a local reduction are verified, and Corollary 5.3 gives us a lower bound of order  $\Omega(n/\log n)$  on the local complexity of the problem. Since  $G$  has maximum degree at most 4,  $G' = f_{3\text{-col},\mathcal{P}}(G)$  has maximum degree at most 8. So this lower bound holds even for graphs of maximum degree at most 8.  $\square$

**5.2. Cubic subgraph.** Let  $G$  and  $H$  be two graphs. We say that  $H$  is a *subgraph* (resp. *induced subgraph*) of  $G$  if  $H$  can be obtained from  $G$  by deleting vertices and edges (resp. vertices only). A graph is *cubic* if all its vertices have degree 3.

**Theorem 5.5.** *The local complexity of the property of not containing a cubic subgraph is  $\Omega(n/\log n)$ , even in graphs of maximum degree at most 7.*

*Proof.* Let  $\mathcal{P}$  be the property of having a cubic subgraph. We will show that there is a local reduction from 3-colorability in graphs of maximum degree at most 4 to  $\mathcal{P}$  with local expansion  $O(1)$ . The result will then follow from Corollary 5.3. Let  $G$  be a graph of maximum degree at most 4, with  $n$  vertices having unique identifiers in  $\{1, \dots, n\}$ .

Let us describe the graph  $G' = f_{3\text{-col}, \mathcal{P}}(G)$ . First, we define a *linking component with  $d$  outputs*. It consists in a cycle of length  $2d + 1$ , and for  $d$  pairs of consecutive vertices, we add a new vertex linked to both vertices of this pair, to form a triangle. The vertex of the cycle which does not belong to these pairs is called the *root*. The vertices which are not in the cycle are called the *terminals*. The remaining vertices are called the *internal vertices*. Note that all internal vertices have degree 3. See Figure 9 for an example.

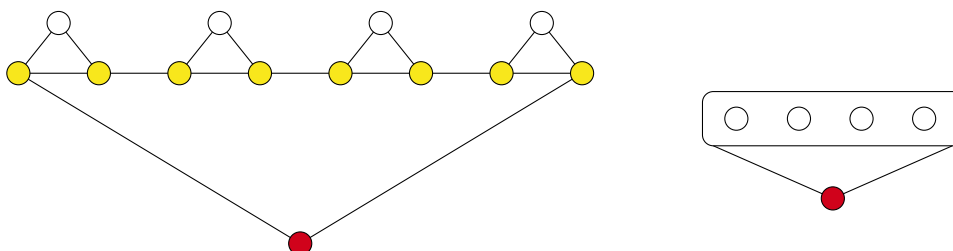

FIGURE 9. A linking-component with four outputs, and its symbolic representation. The red vertex is the root. The white vertices are the terminals. The yellow vertices are the internal vertices (and do not appear in the symbolic representation).

Then, we define an *tag*, represented on Figure 10 (this gadget has already been used in [19] in a different reduction, which was not sufficiently local for our purposes). A tag has only one vertex of degree 1, that we call the *root*. All the other vertices have degree 3, and we call them the *internal vertices*.

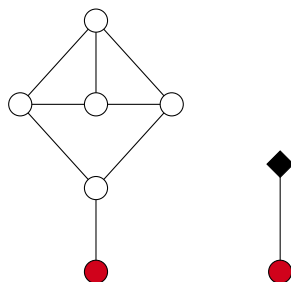

FIGURE 10. A tag, and its symbolic representation. The red vertex is the root.

The graph  $G' = f_{3\text{-col}, \mathcal{P}}(G)$  is constructed as follows. For every vertex  $u \in V(G)$  of degree  $d$  (with  $d \in \{1, 2, 3, 4\}$ ), we create one tag and three linking-components with  $d$  outputs associated to  $u$ , and we merge all the four roots into a single root vertex. We number from 1 to 3 the linking-components of  $u$ . In each of the three linking components, we associate one terminal to each neighbor of  $u$ . For each  $v \in N(u)$ , we denote by  $L_u[i, v]$  the terminal of the  $i$ -th linking component of  $u$  associated to  $v$ . For each  $i, j \in \{1, 2, 3\}$  such that  $i \neq j$ , and for all  $v \in N(u)$ , we put an edge between  $L_u[i, v]$  and  $L_v[j, u]$ . These edges are called the *connecting edges*. Note that since

$G$  has maximum degree at most 4,  $G'$  has maximum degree at most 7. For each  $u \in V(G)$ , we define  $C_u := V_u$  as the set of vertices which are in the three linking components and in the tag corresponding to  $u$ . Finally, the identifier of every vertex of  $G'$  indicates if it belongs to a tag or a linking component, to which vertex of  $G$  is it associated, and which vertex it is precisely in this tag or linking component. All this information can be encoded on  $O(\log n)$  bits. See Figure 11 for an example of this reduction.

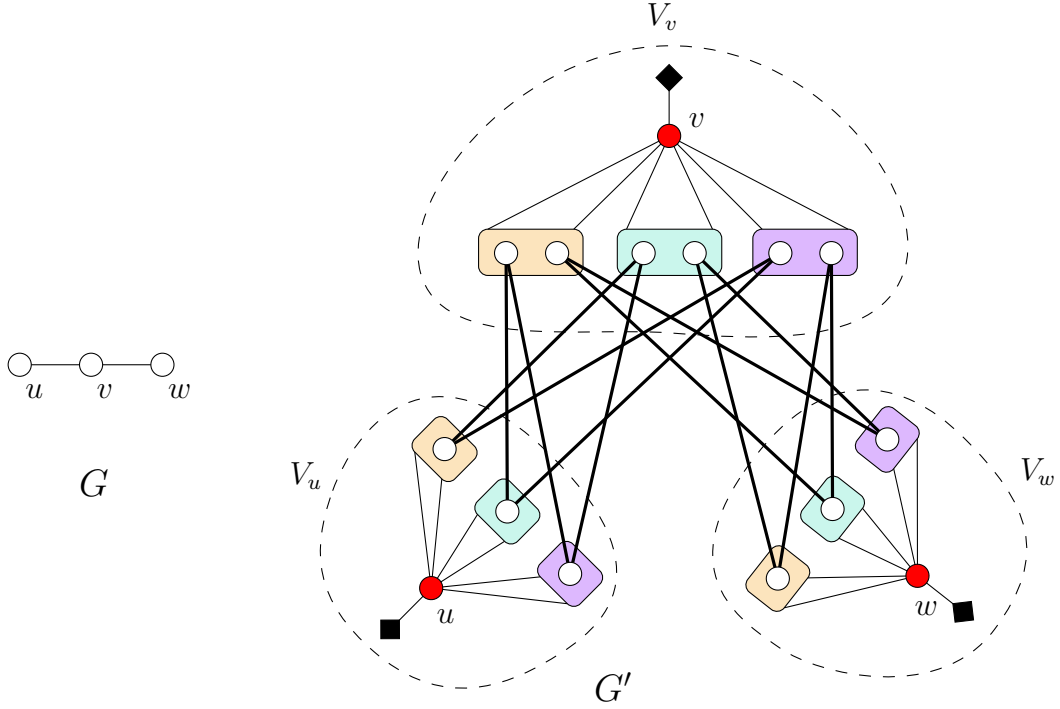

FIGURE 11. The graph  $G' = f_{3\text{-col}, \mathcal{P}}(G)$ , where  $G$  is a path on three vertices. The red vertices are the roots. The thick edges are the connecting edges. The colors of the linking components represent their number.

Let us prove that  $G$  is 3-colorable if and only if  $G'$  has a cubic subgraph. First, assume that  $G$  is 3-colorable, and let  $c : V(G) \rightarrow \{1, 2, 3\}$  be a proper 3-coloring of  $G$ . Let us describe a cubic subgraph of  $G'$ . In fact, it will be an induced subgraph: for this reason, we just describe the subset  $S \subseteq V(G')$  which defines it. For each vertex  $u \in V(G)$ , we put in  $S$  all the vertices from its tag, and all the vertices from its  $c(u)$ -th linking component. Let us prove that the subgraph of  $G'$  induced by  $S$  is cubic. We already know that all the internal vertices of the tags and linking components have degree 3. In  $G'[S]$ , each root also has degree 3, because its tag and exactly one of its linking components is included in  $S$ . Finally, for every  $u \in V(G)$ , let us show that all the terminals of the  $c(u)$ -th linking component of  $u$  also have degree 3. Let  $v$  be a neighbor of  $u$  in  $G$ . The vertex  $L_u[c(u), v]$  has already two neighbors inside the  $c(u)$ -th linking component of  $u$ . Moreover, since  $c$  is a proper coloring of  $G$ , we have  $c(u) \neq c(v)$ . By definition of  $G'$ , there is an edge between  $L_u[c(u), v]$  and  $L_v[c(v), u]$ , so  $L_u[c(u), v]$  has indeed degree 3 in  $G'[S]$ , which is thus a cubic (induced) subgraph of  $G'$ .

Conversely, assume that  $G'$  has a cubic subgraph, and let us prove that  $G$  is 3-colorable. Let  $H$  be a cubic subgraph of  $G'$ . We will need the following lemma.

**Lemma 5.6.** *For every vertex  $u \in V(G)$ ,  $H$  contains all the vertices and edges of the tag and exactly one linking component associated to it, and no other vertices in the two other linking components sharing the same root.*

Lemma 5.6 will itself be proved using the following claim.

**Claim 5.7.** *The following holds.*

- (1) *If  $V(H)$  contains an internal vertex of a linking component (resp. of a tag), then  $H$  contains all the vertices and edges of this linking component (resp. of this tag).*
- (2) *If  $V(H)$  contains a root vertex, then  $H$  contains all the vertices and edges of the tag adjacent to it, and all the vertices and edges of exactly one linking component adjacent to it.*
- (3) *If  $V(H)$  contains a terminal vertex of some linking component, then  $H$  contains all the vertices and edges of this linking component.*

*Proof of Claim 5.7.* (1) Assume that  $V(H)$  contains an internal vertex  $t$  of some linking component. Since  $t$  has degree 3, and  $H$  is cubic,  $H$  contains all the three edges adjacent to  $t$ , and all its three neighbors. Since some of the neighbors of  $t$  are also internal vertices, we can apply the same argument for them. Finally, we obtain that  $H$  contains all the internal vertices of this linking component, all the edges adjacent to them, and all their neighbors. Thus, it contains all the vertices and edges of the linking component. The same proof also holds for the tags.

- (2) Assume that  $V(H)$  contains a root vertex  $t$ . This vertex  $t$  has two neighbors in every adjacent linking component, and one neighbor in the tag. Since  $t$  has degree 3 in  $H$ ,  $H$  should contain exactly one linking component adjacent to it, and the tag (by (1), all the linking component and the tag are in  $H$ ).
- (3) Assume that  $V(H)$  contains a terminal vertex  $t$  of some linking component. Since  $t$  is adjacent to only two connecting edges,  $H$  contains at least one edge adjacent to  $t$  which is in the linking component. It contains also the other endpoint of this edge, which is an internal vertex, so by (1) it contains the whole linking component.  $\square$

*Proof of Lemma 5.6.* By (1), (2), and (3) of Claim 5.7, for every  $u \in V(G)$ , if  $H \cap V_u \neq \emptyset$ , then  $H$  contains a whole linking component associated to  $u$ , it contains also the whole tag sharing the same root, and it has no other vertex from the two others linking components sharing the same root. Thus, to prove Lemma 5.6, we just have to show that  $H \cap V_u \neq \emptyset$  for all  $u \in V(G)$ . Since  $G$  is connected, we just have to show that  $H \cap V_u \neq \emptyset$  implies  $H \cap V_v \neq \emptyset$  for every vertex neighbor  $v$  of  $u$  in  $G$ . So let  $u \in V(G)$  such that  $H \cap V_u \neq \emptyset$ . Let  $v$  be a neighbor of  $u$ , and let  $i \in \{1, 2, 3\}$  such that  $H$  contains a vertex in the  $i$ -th linking component associated to  $u$ . Then,  $L_u[i, v] \in V(H)$ , and since it has degree 3 in  $H$  but only two neighbors in this linking component, then  $H$  contains some connecting edge adjacent to  $L_u[i, v]$ , which has  $L_v[j, u]$  as the other endpoint, for some  $j \in \{1, 2, 3\} \setminus \{i\}$ . So  $H \cap V_j \neq \emptyset$ , which concludes the proof.  $\square$

Using Lemma 5.6, we will show that  $G$  is 3-colorable. By Lemma 5.6, for every  $u \in V(G)$ ,  $H$  contains all the vertices and edges of a unique linking component

associated to it. Let  $c(u)$  be the number of this linking component. We will show that  $c$  defines a proper 3-coloring of  $G$ . Let  $u, v$  be two neighbors in  $G$ . Since  $L_u[c(u), v]$  and  $L_v[c(v), u]$  both have only two neighbors in their linking component, and have degree 3 in  $H$ , then  $H$  contains a connecting edge between them. In particular, by definition of  $H$ , we have  $c(u) \neq c(v)$ . So  $c$  is indeed a proper coloring.

To finish the proof of Theorem 5.5, we just have to show that the conditions of the definition of a local reduction are satisfied. By definition of the identifiers of  $G'$ , (R1) is satisfied. For (R2), we just proved that it holds as well. Conditions (R3a), (R3b), (R3e) and (R3f) hold by definition. For (R3c), it is also true by definition with  $\alpha$  being a constant function taking the value 42 (because, by assumption  $G$  has maximum degree 4, and just by counting the maximum size of  $C_u$ ). Finally, (R3c) holds as well because if  $u \neq v$ , we have  $C_u \neq C_v$ .  $\square$

*Remark 5.8.* The proof of Theorem 5.5 shows that  $G'$  has a cubic subgraph if and only if it has a cubic *induced* subgraph. Thus, we obtain the same  $\Omega(n/\log n)$  lower bound to certify that a graph does not have a cubic induced subgraph, even for graphs of maximum degree 7.

### 5.3. Acyclic partition.

**Theorem 5.9.** *For any fixed  $k \geq 3$ , the property that the vertex set of a given graph  $G$  cannot be partitioned into  $k$  induced forests has local complexity  $\Omega(n/\log n)$ .*

*Proof.* Let  $\mathcal{P}$  be the property of having a partition of the vertex set into  $k$  acyclic induced subgraphs (i.e.,  $k$  induced forests). We will show that there is a local reduction from  $k$ -colorability to  $\mathcal{P}$  with local expansion  $O(n)$  and global expansion  $O(n)$ , and the result will then follow from Corollary 5.3. Let  $G$  be an  $n$ -vertex graph having unique identifiers in  $\{1, \dots, n\}$ . The graph  $G' = f_{k\text{-col}, \mathcal{P}}(G)$  is obtained by adding a set  $U$  of  $k$  universal vertices to  $G$ . For every  $u \in V(G')$ , we define  $V_u := U \cup \{u\}$  and  $C_u := V(G')$ .

We only prove that Property (R2) of the definition of a local reduction is satisfied, since the other properties are straightforward to verify. Assume that  $G$  is  $k$ -colorable. Then, we can partition the vertex set of  $G'$  into  $k$  acyclic induced subgraphs, each of which corresponds to one color class together with one of the universal vertices in  $U$ . Indeed, by doing so, each resulting induced subgraph is a star, which is acyclic. Conversely, assume that  $V(G')$  can be partitioned into  $k$  acyclic induced subgraphs. Then,  $G'$  is  $2k$ -colorable (since each of these acyclic subgraphs is 2-colorable). Consider any proper  $2k$ -coloring of  $G'$ . Then, its restriction to  $G$  is a proper  $k$ -coloring of  $G$ , since each vertex in  $U$  must be alone in its color class (because it is a universal vertex), so  $G$  is  $k$ -colorable.  $\square$

### 5.4. Monochromatic triangles.

**Theorem 5.10.** *The property of having no 2-edge-coloring without monochromatic triangles has local complexity  $\Omega(n/\log n)$ , even in graphs of maximum degree 40.*

*Proof.* Let  $\mathcal{P}$  be the property of the existence of a 2-edge-coloring without any monochromatic triangle. We will prove that there exists a local reduction of local expansion  $O(1)$  from 3-colorability in graphs of maximum degree 4 to  $\mathcal{P}$ . The result will then follow from Corollary 5.3.

Let  $G$  be a graph of maximum degree at most 4, with  $n$  vertices having unique identifiers in  $\{1, \dots, n\}$ . Let us describe the graph  $G' = f_{3\text{-col}, \mathcal{P}}(G)$ . This graph has



two parts, denoted by  $G_0$  and  $G_1$ , which are the following.  $G_0$  is obtained by taking a triangle  $T_u^0$  for each vertex  $u$  of  $G$ , and creating a new edge  $e_{uv}$  that is complete to both  $T_u^0$  and  $T_v^0$  for every edge  $uv$  of  $G$ . See Figure 12 for an example.

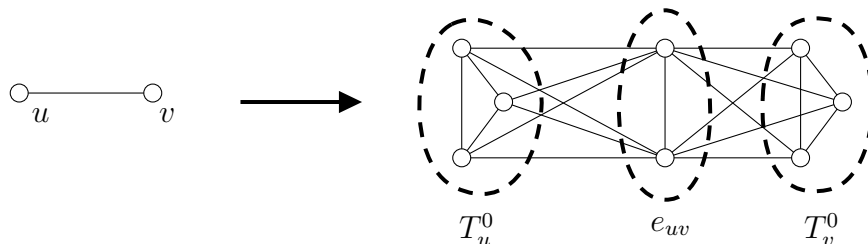

FIGURE 12. The construction of  $G_0$ .

Then,  $G_1$  is obtained by taking seven triangles  $T_u^1, T_u^2, T_u^3, T_u^{12}, T_u^{23}, T_u^{13}, T_u^{123}$  for every vertex  $u$  of  $G$ , and adding three triangles  $T_{uv}^1, T_{uv}^2, T_{uv}^3$  for every edge  $uv$  of  $G$ . Finally, we add the following edges in  $G_1$ , and between  $G_0$  and  $G_1$ :

- for every  $u \in V(G)$ , we make one edge of  $T_u^{123}$  complete to  $T_u^1$ , one complete to  $T_u^2$  and one complete to  $T_u^3$  (see Figure 13 for an illustration);
- for every  $u \in V(G)$  and  $1 \leq i < j \leq 3$ , we make one edge of  $T_u^{ij}$  complete to  $T_u^i$ , one complete to  $T_u^j$ , and one complete to  $T_u^0$ ;
- for every  $\{u, v\} \in E(G)$  and  $i \in \{1, 2, 3\}$ , we make one edge of  $T_{uv}^i$  complete to  $T_u^i$ , one complete to  $T_v^i$ , and one complete to both  $T_u^0$  and  $T_v^0$ .

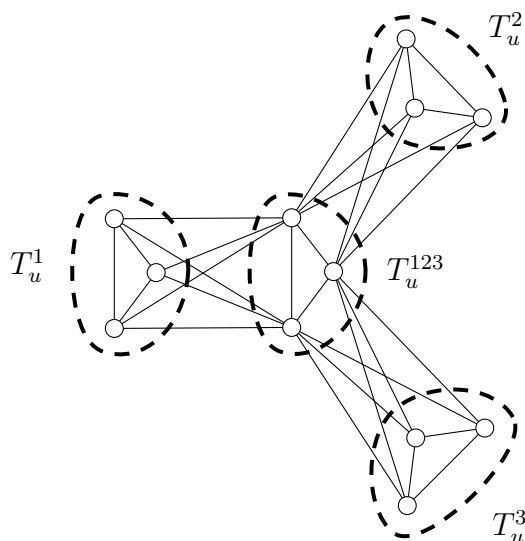

FIGURE 13. Some of the edges in the construction of  $G_1$ .

Finally, for every vertex  $u \in G$ , we define  $V_u$  and  $C_u$  as being both equal to the set containing the vertices in  $T_u^0, e_{uv}, T_u^i, T_u^{ij}, T_u^{123}, T_{uv}^i$  for some  $i, j \in \{1, 2, 3\}$  and  $v \in N(u)$ .

Since  $G$  has maximum degree 4, the size of  $C_u$  is bounded by a constant for every  $u \in V(G)$ , so the local reduction has expansion  $O(1)$ . Moreover, a simple verification shows that every vertex of  $G'$  has degree at most 40 (and the vertices that have degree 40 are the ones in the triangles  $T_u^0$  for some  $u \in V(G)$  which has

degree 4). The only property of the definition of local reduction that is non-trivial to verify is Property (R2): namely, we will show that  $G$  is 3-colorable if and only if  $G'$  admits a 2-edge-coloring without monochromatic triangles.

So, first, assume that  $G'$  admits a 2-edge-coloring without monochromatic triangles, and let us show that  $G$  is 3-colorable. Let us say that the edges of  $G'$  are colored *red* and *blue*. In a 2-edge-coloring of a triangle  $T$  which is not monochromatic, we will say that the color assigned to two out of the three edges of  $T$  is the *main color* of  $T$ . We start by proving the following lemma:

**Lemma 5.11.** *Let us consider a clique  $K_5$  on 5 vertices, denoted by  $s, t, u, v, w$ . In any 2-edge-coloring of  $K_5$  without any monochromatic triangle, the color of the edge  $st$  is the same as the main color of the triangle  $uvw$ . Conversely, any 2-edge-coloring of the edge  $st$  and of the triangle  $uvw$  which makes  $uvw$  non-monochromatic and which satisfies the previous condition can be completed into a 2-edge-coloring of  $K_5$  without any monochromatic triangle.*

*Proof.* Consider a 2-edge-coloring of  $K_5$  without any monochromatic triangle, with colors red and blue. By symmetry, assume that the main color of  $uvw$  is blue, and that  $uv$  is blue,  $uw$  is blue, and  $vw$  is red. Note that the blue-degree of every vertex is at most two (since otherwise there would be a monochromatic triangle), and similarly the red-degree of every vertex is at most two. As  $K_5$  is 4-regular, the blue and red subgraphs are both 5-cycles. It remains to observe that any 5-cycle of  $K_5$  containing the edges  $uv$  and  $uw$  also contains the edge  $st$ . See Figure 14 for an illustration.  $\square$

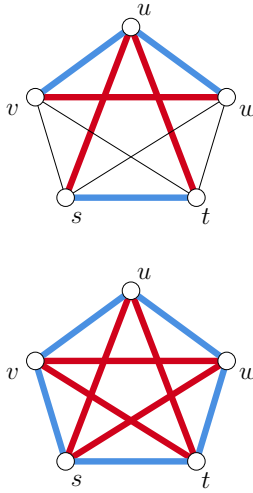

FIGURE 14. (top) The main color of  $uvw$  and the color of  $st$  are the same; (bottom) A coloring of  $K_5$  without monochromatic triangle completing the previous one.

By Lemma 5.11, in the 2-edge-coloring of  $G'$  without monochromatic triangles, for every  $uv \in E(G)$ , since the union of  $T_u^0$  and  $e_{uv}$  induces a  $K_5$ , the main color of  $T_u^0$  and the color of  $e_{uv}$  are the same. Thus, the main colors of  $T_u^0$  and  $T_v^0$  are the same. Since  $G$  is connected, the main color of  $T_u^0$  is the same for all the vertices  $u \in V(G)$ . By symmetry, assume that this color is blue. Let us now prove the following claim to get the result.

**Claim 5.12.** *For every  $u \in V(G)$ , there is exactly one  $i \in \{1, 2, 3\}$  such that the main color of  $T_u^i$  is blue.*

*Proof.* By Lemma 5.11, for every  $1 \leq i < j \leq 3$ , the colors of the edges of  $T_u^{ij}$  are respectively the main colors of  $T_u^i$ ,  $T_u^j$  and  $T_u^0$  (which is blue). Since  $T_u^{ij}$  is not monochromatic, the main color of either  $T_u^i$  or  $T_u^j$  (or both) is red. Thus, at least two of the main colors of  $T_u^1, T_u^2, T_u^3$  are red. But it cannot be red for the 3 triangles, since otherwise the triangle  $T_u^{123}$  would be monochromatic (because its edges are colored with the main colors of  $T_u^1, T_u^2, T_u^3$ ). So exactly one has blue as its main color.  $\square$

Let us define a proper 3-coloring of  $G$  in the following way. By Claim 5.12, for every  $u \in V(G)$ , there is a unique  $i \in \{1, 2, 3\}$  such that the main color of  $T_u^i$  is blue. Let  $c(u)$  be this unique  $i \in \{1, 2, 3\}$ , and let us prove that  $c$  is a proper 3-coloring of  $G$ . By contradiction, assume that there exists  $uv \in E(G)$  such that  $c(u) = c(v)$ . Then, the triangle  $T_{uv}^{c(u)}$  is monochromatic (because its edges are colored with the main colors of  $T_u^{c(u)}, T_v^{c(v)}$  and  $T_u^0$ , respectively, which are all blue), and that is a contradiction. So  $G$  is indeed 3-colorable.

Conversely, assume that  $G$  is 3-colorable. Then, we can define a 2-edge-coloring of  $G'$  without monochromatic triangle in the following way: for each  $u \in V(G)$ , we color two out of the three edges of  $T_u^0$  by blue, and the other one by red. We also color two out of the three edges of  $T_u^{c(u)}$  by blue, the other one by red, and we do the converse for  $T_u^i$  if  $i \neq c(u)$ . Finally, using Lemma 5.11, we color the remaining edges to obtain a 2-edge-coloring of  $G'$  which does not have any monochromatic triangle.  $\square$

While every coNP-hard problem has a polynomial reduction from non-3-colorability, these reductions are often non-local, and sometimes reductions are much easier to perform from problems such as 3-SAT (which is not a purely graph theoretic problem). In the next section, we describe a mild modification of Theorem 5.2 in the specific context of local reduction from 3-SAT. Our main applications are non-Hamiltonicity and non- $\Delta$ -edge-colorability.

## 6. REDUCTIONS FROM 3-SAT TO $\mathcal{P}$

Let us recall the following reduction from 3-coloring to 3-SAT. Let  $G$  be a graph. We construct a 3-CNF formula  $\varphi_G$  which is satisfiable if and only if  $G$  is 3-colorable. For every vertex  $u \in V(G)$ , we create three variables  $u_1, u_2, u_3$ , to express the fact that  $u$  is colored with color 1, 2 or 3.

For every  $u \in V(G)$ , we add the following clauses to  $\varphi_G$ :

$$(u_1 \vee u_2 \vee u_3) \wedge (\neg u_1 \vee \neg u_2) \wedge (\neg u_1 \vee \neg u_3) \wedge (\neg u_2 \vee \neg u_3)$$

For every edge  $\{u, v\} \in E(G)$ , we add the following clauses to  $\varphi_G$ :

$$(\neg u_1 \vee \neg v_1) \wedge (\neg u_2 \vee \neg v_2) \wedge (\neg u_3 \vee \neg v_3)$$

Note that  $\varphi_G$  has  $3|V(G)|$  variables and  $4|V(G)| + 3|E(G)|$  clauses.

**Claim 6.1.**  *$G$  has a proper 3-coloring if and only if  $\varphi_G$  is satisfiable.*

Let  $\varphi$  be a 3-CNF formula, and  $V(\varphi)$  be the set of variables of  $\varphi$ . We say that two variables  $x, y \in V(\varphi)$  have a clause in common if there exists a clause of  $\varphi$  which contains both  $x$  or its negation, and  $y$  or its negation (in particular,  $x$  has a clause

in common with itself). We define  $\mathcal{F}_0$  as the set of 3-CNF formulae  $\varphi$  such that each variable appears in at most  $|V(\varphi)| + 1$  clauses, and  $\mathcal{F}_1$  as the set of 3-CNF formulae  $\varphi$  such that each variable appears in at most 7 clauses. Note that for any graph  $G$ , we have  $\varphi_G \in \mathcal{F}_0$ , and for every  $G$  of maximum degree at most 4, we have  $\varphi_G \in \mathcal{F}_1$ .

**Local reductions from 3-SAT.** Let  $\mathcal{F}$  be a class of 3-CNF formulae,  $\mathcal{C}$  be a graph class, and  $\mathcal{P}$  be a property on  $\mathcal{C}$ . Let  $\alpha, \beta : \mathbb{N} \rightarrow \mathbb{N}$ . We say that there exists a *local reduction from 3-SAT (in  $\mathcal{F}$ ) to  $\mathcal{P}$*  with local expansion  $\alpha$  and global expansion  $\beta$  if there exists a function  $f_{\mathcal{P}}$  which takes as input a 3-CNF formula  $\varphi \in \mathcal{F}$  having the following properties:

- (P1) the variables of  $\varphi$  have identifiers in  $\{1, \dots, n\}$ , where  $n := |V(\varphi)|$ ,
- (P2) for any variables  $x, y \in V(\varphi)$ , there exists a sequence of variables  $x_1, \dots, x_k$  such that  $x = x_1, y = x_k$  and  $x_i, x_{i+1}$  have a clause in common for all  $i < k$ ,  
and outputs a graph  $f_{\mathcal{P}}(\varphi) \in \mathcal{C}$  having at most  $\beta(n)$  vertices, with identifiers, and such that the following properties are satisfied:
- (S1) the vertices of  $f_{\mathcal{P}}(\varphi)$  have unique identifiers written on  $O(\log n)$  bits,
- (S2)  $\varphi$  is satisfiable if and only if  $f_{\mathcal{P}}(\varphi)$  satisfies  $\mathcal{P}$ ,
- (S3) for each variable  $x$  of  $\varphi$ , there exist two sets  $C_x, V_x \subseteq V(f_{\mathcal{P}}(\varphi))$ , such that, for every  $x \in V(\varphi)$ , the following properties are satisfied:
  - (a)  $V_x \subseteq C_x$ ,
  - (b)  $\bigcup_{y \in V(\varphi)} V_y = V(f_{\mathcal{P}}(\varphi))$ ,
  - (c)  $|C_x| \leq \alpha(n)$ ,
  - (d) for every  $t \in V(f_{\mathcal{P}}(\varphi))$ , and for every variables  $y, y'$  such that  $t \in C_y \cap C_{y'}$ , there exists a sequence of variables  $y_1, \dots, y_k$  such that:  $y_1 = y, y_k = y'$ ,  $t \in \bigcap_{1 \leq i \leq k} C_{y_i}$ , and for every  $i \in \{1, \dots, k-1\}$ ,  $y_i$  and  $y_{i+1}$  have a clause in common,
  - (e) for every  $t \in V_x$ ,  $N[t]$  is included in  $\bigcup_{y \in X} C_y$ , where  $X$  denotes the set of variables of  $\varphi$  which have a clause in common with  $x$ ,
  - (f)  $V_x$  and its neighborhood (resp.  $C_x$ ) only depends on the set of clauses in which  $x$  (or its negation) appears. In other words: if  $\varphi'$  is another formula on the same set of variables with identifiers  $\{1, \dots, n\}$ , and if the set of clauses in which  $x$  appears is the same in  $\varphi$  and  $\varphi'$ , then the sets  $V_x$  and the subgraphs with identifiers formed by the vertices in  $V_x$  and their adjacent edges are the same in  $f_{\mathcal{P}}(\varphi)$  and  $f_{\mathcal{P}}(\varphi')$  (resp. the sets  $C_x$  in  $f_{\mathcal{P}}(\varphi)$  and  $f_{\mathcal{P}}(\varphi')$  are the same).

*Remark 6.2.* We can make the same observations as in Remark 5.1. Namely: every local reduction from 3-SAT to  $\mathcal{P}$  with local expansion  $\alpha$  has global expansion at most  $n\alpha(n)$ , and the definition is symmetric between properties and their complement.

We obtain the following variant of Theorem 5.2, tailored to local reductions from 3-SAT.

**Theorem 6.3.** *Let  $\mathcal{C}, \mathcal{C}'$  be two graph classes, and  $\mathcal{F}$  be a class of 3-CNF formulae. Let  $\mathcal{P}$  be a graph property on  $\mathcal{C}$ . If there exists a local reduction from 3-SAT (in  $\mathcal{F}$ ) to  $\mathcal{P}$  with local expansion  $\alpha$  and global expansion  $\beta$ , and if  $\varphi_G \in \mathcal{F}$  for all  $G \in \mathcal{C}'$ , then there exists a local reduction from 3-colorability in  $\mathcal{C}'$  to  $\mathcal{P}$  with local expansion  $\alpha'$  and global expansion  $\beta'$ , where  $\alpha'(n) = 3\alpha(3n)$  and  $\beta'(n) = \beta(3n)$ .*

Again, the following immediate corollary of Theorem 6.3 and Corollary 5.3 will be the result we use in practice to obtain lower bounds.

**Corollary 6.4.** *Let  $\mathcal{P}$  be a graph property (on some graph class  $\mathcal{C}$ ).*

- (1) *If there exists a local reduction from 3-SAT in  $\mathcal{F}_0$  to  $\mathcal{P}$  with local expansion  $O(n^\delta)$  for some  $0 \leq \delta < 2$ , and global expansion  $O(n^\gamma)$ , then  $\overline{\mathcal{P}}$  requires certificates of size  $\Omega(n^{(2-\delta)/\gamma}/\log n)$ . In particular, since  $\gamma \leq \delta + 1$ ,  $\overline{\mathcal{P}}$  requires certificates of size  $\Omega(n^{\frac{3}{\delta+1}-1}/\log n)$ .*
- (2) *If there exists a local reduction from 3-SAT in  $\mathcal{F}_1$  to  $\mathcal{P}$  with local expansion  $O(n^\delta)$  for some  $0 \leq \delta < 1$ , and global expansion  $O(n^\gamma)$ , then  $\overline{\mathcal{P}}$  requires certificates of size  $\Omega(n^{(1-\delta)/\gamma}/\log n)$ . In particular, since  $\gamma \leq \delta + 1$ , it requires certificates of size  $\Omega(n^{\frac{2}{\delta+1}-1}/\log n)$ .*

We now proceed with the proof of Theorem 6.3, which is very similar to that of Theorem 5.2.

*Proof of Theorem 6.3.* Let  $f_{\mathcal{P}}$  be the function corresponding to the local reduction from 3-SAT (in  $\mathcal{F}$ ) to  $\mathcal{P}$  with local expansion  $\alpha$  and global expansion  $\beta$ . We show that there exists a local reduction from 3-colorability in  $\mathcal{C}'$  to  $\mathcal{P}$  with local expansion  $\alpha'(n) := 3\alpha(3n)$  and global expansion  $\beta'(n) := \beta(3n)$ , with the function  $f_{3\text{-col},\mathcal{P}}(G) := f_{\mathcal{P}}(\varphi_G)$  for every  $G$ , where for each vertex  $u \in V(G)$  having its identifier in  $\{1, \dots, n\}$ , the variable  $u_i$  in  $\varphi_G$  received the identifier  $3(\text{id}(u) - 1) + i$ , so that the variables of  $\varphi_G$  have indeed identifiers in  $\{1, \dots, 3n\}$  and thus  $\varphi_G$  satisfies property (P1) of the definition of local reduction from 3-SAT (see the beginning of Section 6). Note that  $\varphi_G$  also satisfies property (P2) because  $G$  is connected.

Now, let us prove that  $f_{3\text{-col},\mathcal{P}}(G)$  satisfies all the conditions of the definition of local reduction from 3-colorability to  $\mathcal{P}$  (see the beginning of Section 5). First, it has at most  $\beta(3n) = \beta'(n)$  vertices. Then, it is straightforward to see that conditions (R1) and (R2), are satisfied. Let us prove that (R3) holds as well. For every vertex  $u$ , let us define  $C_u := C_{u_1} \cup C_{u_2} \cup C_{u_3}$ , and  $V_u := V_{u_1} \cup V_{u_2} \cup V_{u_3}$ , where  $u_1, u_2, u_3$  are the variables of  $\varphi_G$  corresponding to  $u$ . It is again straightforward that (R3a) and (R3b) both hold. For (R3c), observe that  $\varphi_G$  has  $3n$  variables, and that for every  $u \in G$  and every  $i \in \{1, 2, 3\}$ ,  $|C_{u_i}| \leq \alpha(3n)$ . Thus,  $|C_u| \leq 3\alpha(3n) = \alpha'(n)$ . For (R3d), let  $t \in V(f_{3\text{-col},\mathcal{P}}(G))$  and let  $u, v \in V(G)$  such that  $t \in C_u \cap C_v$ . Without loss of generality, assume that  $t \in C_{u_1} \cap C_{v_1}$ . By condition (S3d) of the definition of local reduction from 3-SAT, there exists a sequence of variables  $y_1, \dots, y_k$  such that  $y_1 = u_1, y_k = v_1$ , for every  $i \in \{1, \dots, k-1\}$ ,  $y_i$  and  $y_{i+1}$  have a clause in common, and  $t \in \bigcap_{1 \leq i \leq k} C_{y_i}$ . Thus, by construction of  $\varphi_G$ , for every  $i \in \{1, \dots, k-1\}$ , one of the two following cases holds:

- there exists  $w \in V(G)$  and  $j, j' \in \{1, 2, 3\}$  such that  $y_i = w_j$  and  $y_{i+1} = w_{j'}$ ,  
or
- there exists  $w, w' \in V(G)$  which are neighbors, and  $j \in \{1, 2, 3\}$  such that  $y_i = w_j$  and  $y_{i+1} = w'_j$

So there is a path from  $u$  to  $v$  which is included in  $\{w \in V(G) \mid t \in C_w\}$ , which proves (R3d). Then, (R3e) simply follows from the definition of  $C_u$  and from (S3e) of the definition of local reduction from 3-SAT. Finally, for (R3f), if  $G'$  is another  $n$ -vertex graph with unique identifiers in  $\{1, \dots, n\}$  and if the subgraph formed by  $u$  and its neighbors is the same in  $G$  and  $G'$ , then for every  $i \in \{1, 2, 3\}$  the clauses in which the variable  $u_i$  appears in  $\varphi_G$  and  $\varphi_{G'}$  are the same, and we can just apply the property (S3f) of the definition of local reduction from 3-SAT to conclude.  $\square$

### 6.1. Non-Hamiltonicity.

**Theorem 6.5.** *The property of not having a Hamiltonian cycle has local complexity  $\Omega(\sqrt{n}/\log n)$ , even in graphs of maximum degree at most 4.*

*Proof.* Let  $\mathcal{P} := \text{HAMILTONIANCYCLE}$ . We prove that there exists a local reduction from 3-SAT (in  $\mathcal{F}_0$ ) to  $\mathcal{P}$  with local expansion  $O(n)$ , and then the result will follow from Corollary 6.4. Recall that  $\mathcal{F}_0$  was defined as the set of 3-CNF formulae  $\varphi$  such that each variable appears in at most  $|V(\varphi)|+1$  clauses. We use the reduction of [18]. Let  $\varphi$  be a 3-CNF formula with variables having identifiers in  $\{1, \dots, |V(\varphi)|\}$ , and such that each variable appears in at most  $|V(\varphi)| + 1$  clauses. Let  $n := |V(\varphi)|$ , and let  $m$  be the number of clauses in  $\varphi$ . Let  $x_1, \dots, x_n$  be the variables of  $\varphi$ , and  $C_1, \dots, C_m$  be its clauses.

The graph  $f_{\mathcal{P}}(\varphi)$  is constructed in two steps. First, we construct a directed graph  $f_{\mathcal{P}}^*(\varphi)$  which has a directed Hamiltonian cycle if and only if  $\varphi$  is satisfiable. Then, we explain how to construct the undirected graph  $f_{\mathcal{P}}(\varphi)$  from  $f_{\mathcal{P}}^*(\varphi)$ .

The graph  $f_{\mathcal{P}}^*(\varphi)$  is constructed as follows. For each variable  $x_i$  such that  $x_i$  or its negation appears in  $d$  clauses, we create a horizontal row of  $3d+3$  vertices, an entry node, and an exit node. The exit node of  $x_i$  is the entry one of  $x_{i+1}$ , except the entry node of  $x_1$  which is called  $s$ , and the exit node of  $x_n$  which is called  $t$ . There is also an arc from  $t$  to  $s$ . Finally, we add  $m$  single vertices, one for each clause. This is depicted on Figure 15. We now specify how to connect the vertices corresponding to the clauses to the rest of the graph. For each  $i \in \{1, \dots, n\}$ , the  $3d+3$  vertices of the row corresponding to  $x_i$  are divided as follows. Among the  $3d+1$  vertices which are not the first and the last one, they are grouped by adjacent pairs, with one separator between each pair. Let us denote  $C_{i_1}, \dots, C_{i_d}$  the clauses in which  $x_i$  or its negation appears. For every  $j \in \{1, \dots, d\}$ , we add two edges between the  $j$ -th pair of the row of  $x_i$  and the vertex corresponding to  $C_{i_j}$ , and their direction depends only on whether  $x_i$  appears positively or negatively in  $C_j$ . See [18] for more details and Figure 16 for an example.

Now, let us explain how to construct the graph  $f_{\mathcal{P}}(\varphi)$  from  $f_{\mathcal{P}}^*(\varphi)$ . We proceed again as in [18], by replacing each vertex  $u$  of  $f_{\mathcal{P}}^*(\varphi)$  by three vertices  $u_{\text{in}}, u_{\text{mid}}, u_{\text{out}}$ . These three vertices form a path, in this order. Each (directed) edge from  $u$  to  $v$  is replaced an (undirected) edge from  $u_{\text{out}}$  to  $v_{\text{in}}$ .

The identifiers of the vertices of  $f_{\mathcal{P}}(\varphi)$  consist in a pair: the first entry indicates the identifier of the corresponding vertex  $u$  in  $f_{\mathcal{P}}^*(\varphi)$  (see thereafter the definition), and the second entry indicates if it is  $u_{\text{in}}, u_{\text{mid}}$  or  $u_{\text{out}}$ . In  $f_{\mathcal{P}}^*(\varphi)$ , the identifier of each vertex  $u$  indicates if it is a vertex corresponding to a clause (by encoding the identifiers of the three variables in it), or to a variable, and in this latter case if it is linked to a clause vertex (and which one) or if it is a separator between two pairs (and the corresponding pairs it separates). All this information can be encoded with  $O(\log n)$  bits.

For every variable  $x_i$  of  $\varphi$ , let us describe the sets  $C_{x_i}$  and  $V_{x_i}$  (and see Figure 15 for an example).

- The set  $V_{x_i}$  consists in all the vertices  $u_{\text{in}}, u_{\text{mid}}, u_{\text{out}}$  for each vertex  $u$  which is either the entry node corresponding to  $x_i$ , or the exit node, or a node in the row of  $x_i$ , or a node corresponding to a clause to which  $x_i$  or its negation belongs. These vertices are colored in green on Figure 15.



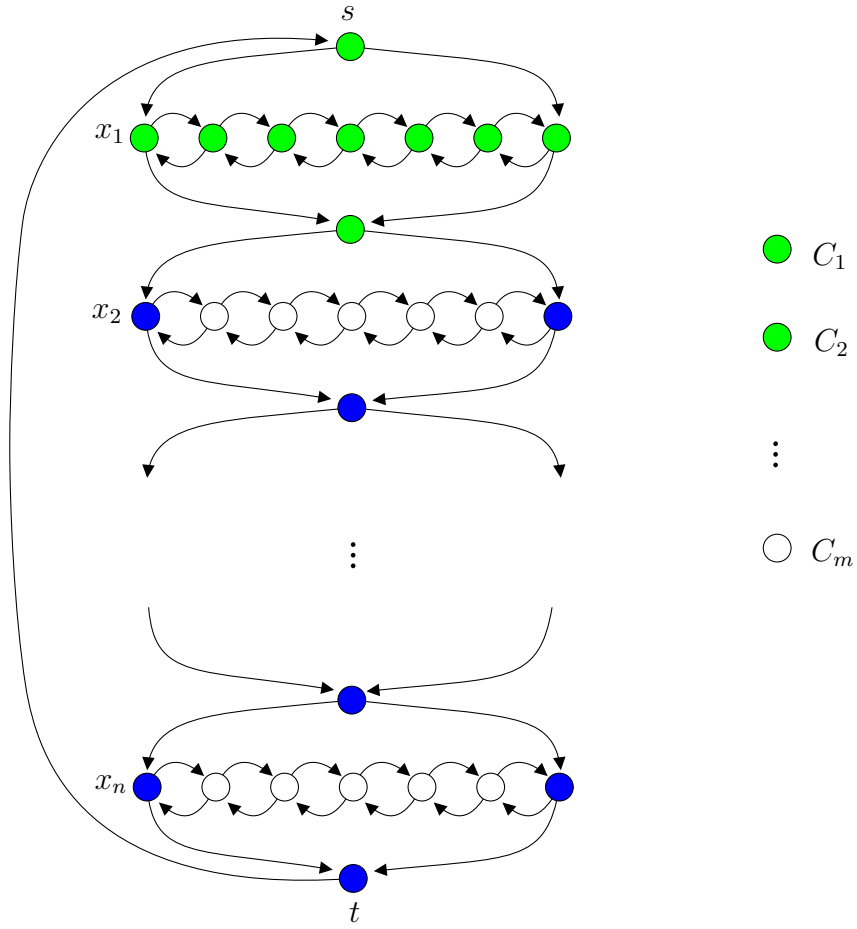

FIGURE 15. The graph  $f_{\mathcal{P}}^*(\varphi)$ . There are  $n$  rows (one per variable). The edges between the vertices corresponding to the clauses and the rest of the graph are not represented here. The green vertices are those in  $V_{x_1}$  (assuming that  $x_1$  or its negation belongs to  $C_1$  and  $C_2$ , but not to  $C_m$ ). The blue vertices are those in  $C_{x_1} \setminus V_{x_1}$ .

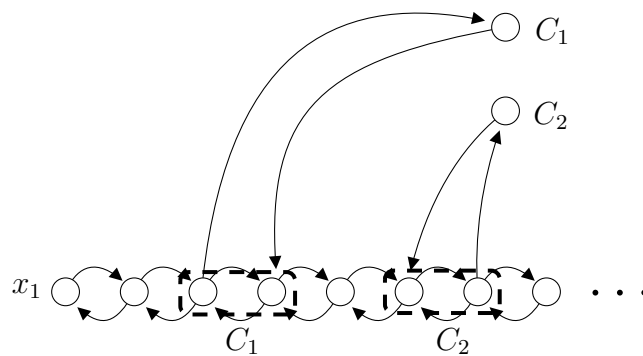

FIGURE 16. The connection between the nodes corresponding to clauses and the rest of the graph. On this example,  $x_1$  appears in  $C_1$ ,  $\bar{x}_1$  appears in  $C_2$ .

- The set  $C_{x_i}$  consists in  $V_{x_i}$ , plus all the vertices  $u_{\text{in}}, u_{\text{mid}}, u_{\text{out}}$  for  $u$  which is either an entry/exit node of any variable, or a first/last vertex in the row of any variable. These vertices are colored in blue on Figure 15.

Let us verify that the properties of the definition of local reduction from 3-SAT (see the beginning of section 6) are satisfied. For (S1), the identifiers are indeed on  $O(\log |V(\varphi)|)$  bits. For (S2), it is proved in [18]. Properties (S3a), (S3b), (S3d), (S3e), and (S3f) follow from the definition of  $C_{x_i}$  and  $V_{x_i}$ . For (S3c), we indeed have  $|C_{x_i}| = O(n)$  for every variable  $x_i$ : this holds because, by definition of  $\mathcal{F}_0$ ,  $x_i$  appears in at most  $n$  clauses.

Thus, we can apply Corollary 6.4 which gives us the  $\Omega\left(\frac{\sqrt{n}}{\log n}\right)$  lower bound. Since  $f_{\mathcal{P}}(G)$  has maximum degree at most 4, the lower bound holds even for this class of graphs.  $\square$

**6.2. Chromatic index.** The *chromatic index* of a graph  $G$  is the least  $k$  such that the edges of  $G$  can be colored with  $k$  colors, so that any two edges sharing a endpoint have distinct colors. By Vizing's theorem, if  $\Delta$  is the maximum degree of  $G$ , its chromatic index is either  $\Delta$  or  $\Delta + 1$ .

**Theorem 6.6.** *The property of having chromatic index  $\Delta + 1$  (where  $\Delta$  denotes the maximum degree) has local complexity  $\Omega(n/\log n)$ , even in cubic graphs .*

*Proof of Theorem 6.6.* Let  $\mathcal{P}$  be the property of having chromatic index  $\Delta$ . We will show that there exists a local reduction from 3-SAT in  $\mathcal{F}_1$  to  $\mathcal{P}$  with local expansion  $O(1)$ , and then the result will follow from Corollary 6.4. Recall that  $\mathcal{F}_1$  was defined as the set of 3-CNF formulae  $\varphi$  such that each variable appears in at most 7 clauses. Let  $\varphi$  be a 3-CNF formula with variables having identifiers in  $\{1, \dots, |V(\varphi)|\}$ , and such that each variable appears in at most 7 clauses. Let  $n := |V(\varphi)|$ , and let  $m$  be the number of clauses in  $\varphi$ . Let  $x_1, \dots, x_n$  be the variables of  $\varphi$ , and  $C_1, \dots, C_m$  be its clauses.

We use the reduction presented in [15]. For completeness, we recall this construction. First, we define an *inverting component*, which is shown on Figure 17.

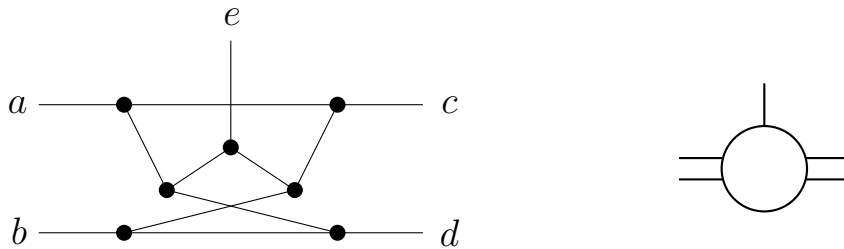

FIGURE 17. An inverting component and its symbolic representation.

In an edge-coloring, a pair of edges is said to be *true* (resp. *false*) if it is colored with the same colors (resp. with different colors). In any proper 3-edge-coloring of an inverting component, exactly one of the two pairs  $(a, b)$  or  $(c, d)$  is true, and the three other edges have different colors. Thus, regarding  $(a, b)$  as the input and  $(c, d)$  as the output, an inverting component changes true to false and vice-versa.

Then, we define a *variable-setting* component with  $k$  outputs. It consists in a cycle of  $k$  pairs of inverting components, as shown on Figure 18 with  $k = 4$ . In any

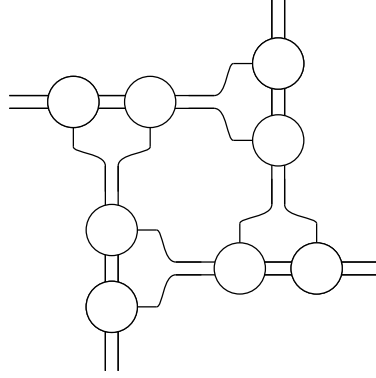

FIGURE 18. A variable-setting component with four outputs.

proper 3-coloring of the edges, all the output pairs must have the same value, either all true or all false.

Finally, for each clause, we will create a *satisfaction-testing component*, represented on Figure 19. This component has a proper 3-coloring of the edges if and only if at least one of its three input pairs is true.

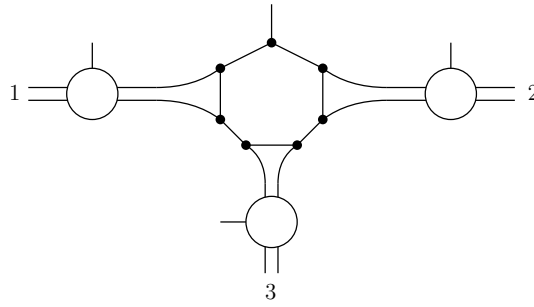

FIGURE 19. A satisfaction-testing component.

The graph  $f_{\mathcal{P}}(\varphi)$  is constructed as follows. For each variable  $x_i$  such that  $x_i$  or its negation belongs to  $d$  clauses, we create a variable-setting component with  $d$  outputs, numbered from 1 to  $d$ . For each clause  $C_j$ , we create a satisfaction-testing component. Let  $x_{j_1}, x_{j_2}, x_{j_3}$  be the variables which appear (positively or negatively) in  $C_j$ , by increasing order of their identifiers. Let  $\ell$  be the index such that, by sorting the clauses containing  $x_{j_1}$  or its negation by lexicographic order of the variables appearing inside,  $C_j$  is the  $\ell$ -th. We connect the  $\ell$ -th output of the variable-setting component of  $x_{j_1}$  to the input 1 of the satisfaction-testing component of  $C_j$ , and if  $x_{j_1}$  appears negatively in  $C_j$ , we insert an inverting component in this branching. We do the same for  $x_{j_2}$  and  $x_{j_3}$  with inputs 2 and 3 of the satisfaction-testing component. This results in a graph  $H$ , which has some edges having an endpoint of degree 1 (in the satisfaction-testing components). The graph  $f_{\mathcal{P}}(\varphi)$  is obtained by taking two copies of this graph  $H$  and identifying these edges. It results in a cubic graph.

The identifier of each vertex  $u$  of  $f_{\mathcal{P}}(G)$  is the following. First, it indicates to which of the two copies of the graph  $H$  does  $u$  belong to. Then, if  $u$  belongs to a variable-setting component, it indicates to which variable it corresponds, its position in the variable-setting component, and if it is adjacent to an output, it also indicates the clause corresponding to the satisfaction-testing component to which it is adjacent. If  $u$  belongs to a satisfaction-testing component, it indicates to which

clause it corresponds, and its position in the satisfaction-testing component. All this information can be encoded on  $O(\log n)$  bits.

For every variable  $x_i$  of  $\varphi$ , we define  $C_{x_i} = V_{x_i}$  as being the set which contains all the vertices in the two copies of  $H$  which are in the variable-setting component of  $x_i$ , in the satisfaction-testing of any clause to which  $x_i$  belongs, and in an inverting component branched between its variable-setting component and the satisfaction-testing component of a clause in which it appears negatively.

Let us verify that the properties of the definition of local reduction from 3-SAT (see the beginning of section 6) are satisfied. Property (S1) is true by definition of the identifiers of the vertices of  $f_{\mathcal{P}}(\varphi)$ , and (S2) comes from the correctness of the reduction in [15]. Properties (S3a), (S3b), (S3e) and (S3f) follow from the definition of  $V_{x_i}$  and  $C_{x_i}$ . For (S3f), we have  $C_{x_i} = O(1)$  for every variable  $x_i$ , because by definition of  $\mathcal{F}_1$ ,  $x_i$  appears in a constant number of clauses (at most 7). Finally, (S3d) is true because if  $C_{x_i} \cap C_{x_j} \neq \emptyset$  then either  $x_i = x_j$ , or  $x_i$  and  $x_j$  have a clause in common.

Thus, Corollary 6.4 gives us a lower bound of order  $\Omega(n/\log n)$  on the local complexity of the problem, and the lower bound holds even for cubic graphs because  $f_{\mathcal{P}}(\varphi)$  is a cubic graph.  $\square$

## 7. VARIANT OF OUR THEOREMS IN A BOUNDED-DEGREE CLASS

In this subsection, we give an example of a lower bound for which the proof is not follow from a direct application of our general results on local reductions, because the definition of local reduction requires a small tweak to be applied efficiently here. This lower bound is stated in the following theorem. We then show that the bound on the maximum degree is close to optimal: if the maximum degree is decreased by two, then the local complexity of the problem drops from  $\Omega(n/\log n)$  to  $O(\log n)$ .

**Theorem 7.1.** *Let  $k \geq 3$ . In graphs of maximum degree  $k + \lceil \sqrt{k} \rceil - 1$ , non- $k$ -colorability has local complexity  $\Omega(n/\log n)$ .*

Note that Theorem 7.1 generalizes Theorem 3.2 to non- $k$ -colorability. To prove it, we will rely on the reduction presented in [5], that the authors use to prove the NP-completeness of the  $k$ -colorability problem in graphs of maximum degree  $k + \lceil \sqrt{k} \rceil - 1$ . First, let us recall this NP-completeness reduction. Given a graph  $G$  of maximum degree larger than  $k + \lceil \sqrt{k} \rceil - 1$ , we perform iteratively the following operation: we pick a vertex  $u \in V(G)$  of degree  $d(u) > k + \lceil \sqrt{k} \rceil - 1$ , add vertices  $r_1, \dots, r_{\lceil \sqrt{k} \rceil}$  to  $G$ , detach  $k$  edges incident to  $u$  and attach them evenly to  $r_1, \dots, r_{\lceil \sqrt{k} \rceil}$ . Finally, we add a  $(k-1)$ -clique  $K_{k-1}$  and connect  $u$  and all the vertices  $r_1, \dots, r_{\lceil \sqrt{k} \rceil}$  to each vertex of  $K_{k-1}$ . It is straightforward that this operation preserves the  $k$ -colorability property, and decreases the degree of  $u$  by one, without creating vertices of degree larger than  $k + \lceil \sqrt{k} \rceil - 1$ . Thus, at the end of the process, all the vertices have degree at most  $k + \lceil \sqrt{k} \rceil - 1$  and the  $k$ -colorability property of the graph has been preserved. See Figure 20 for an example of this operation. In the following, we will use it to prove Theorem 7.1.

First, recall that by Theorem 4.1, at least  $\Omega(n/\log n)$  bits are necessary to certify non- $k$ -colorability in graphs of maximum degree  $5k-4$ . We will prove that, for every  $\delta \in \{k + \lceil \sqrt{k} \rceil, \dots, 5k-4\}$ , there exists a local reduction of local expansion  $O(1)$  from non- $k$ -colorability in graphs of maximum degree  $\delta$  to non- $k$ -colorability in graphs of

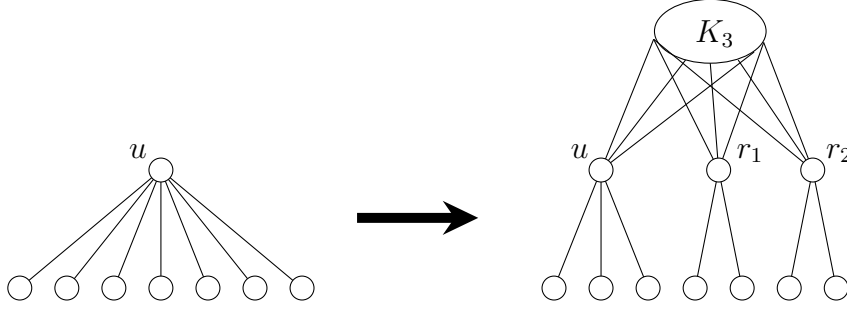

FIGURE 20. An example of the operation performed in the reduction of [5], with  $k = 4$ . The degree of  $u$  decreased by one after this operation.

maximum degree  $\delta - 1$ , with a slightly different definition of local reduction (and we will prove that this small change will not affect Theorem 5.2). By doing so, since  $k$  is a constant, by applying iteratively Theorem 5.2, the  $\Omega(n/\log n)$  lower bound for non- $k$ -colorability will hold in graphs of maximum degree  $k + \lceil \sqrt{k} \rceil - 1$ .

Let  $\delta \in \{k + \lceil \sqrt{k} \rceil, \dots, 5k - 4\}$ , and let  $\mathcal{P}$  (resp.  $\mathcal{P}'$ ) be the  $k$ -colorability property in graphs of maximum degree  $\delta$  (resp.  $\delta - 1$ ). Let  $G$  be an  $n$ -vertex graph with vertices having unique identifiers in  $\{1, \dots, n\}$  and maximum degree  $\delta$ . We define the graph  $G' = f_{\mathcal{P}, \mathcal{P}'}(G)$  in the following way. We perform simultaneously, for all the vertices  $u$  of  $G$ , the operation represented on Figure 20: namely, we add  $\lceil \sqrt{k} \rceil$  additional vertices  $r_1(u), \dots, r_{\lceil \sqrt{k} \rceil}(u)$  and a clique  $K_{k-1}(u)$  of size  $k - 1$  complete to  $u$  and to all the vertices  $r_1(u), \dots, r_{\lceil \sqrt{k} \rceil}(u)$ . Then, for each edge  $uv$  of  $G$ , let  $i_u(v)$  (resp.  $i_v(u)$ ) denote the index of the identifier of  $v$  (resp. of  $u$ ) in the list of identifiers of the neighbors of  $u$  (resp. of  $v$ ) sorted in increasing order. We put an edge in  $f_{\mathcal{P}', \mathcal{P}}(G')$  which has the following endpoints:

- if  $i_u(v) \leq k$ , the first endpoint is  $r_{(i_u(v) \bmod \lceil \sqrt{k} \rceil) + 1}(u)$ , otherwise it is  $u$ ;
- if  $i_v(u) \leq k$ , the second endpoint is  $r_{(i_v(u) \bmod \lceil \sqrt{k} \rceil) + 1}(v)$ , otherwise it is  $v$ .

In other words: for each vertex  $u$ , we detach the edges of  $u$  incident to its  $\lceil \sqrt{k} \rceil$  neighbors having smallest identifiers, and attach them evenly to  $r_1(u), \dots, r_{\lceil \sqrt{k} \rceil}(u)$ . Let us also define  $V_u = C_u$  as the set containing  $u, r_1(u), \dots, r_{\lceil \sqrt{k} \rceil}(u), K_{k-1}(u)$ . Finally, we define an identifier for every vertex in  $G'$  that indicates to which vertex it corresponds in  $G$ , if it belongs to a  $(k - 1)$ -clique, or if it is a vertex  $r_i(u)$  for some  $i$  and  $u$ . All this information can be encoded on  $O(\log n)$  bits.

Now, we would like to prove that it defines a local reduction of local expansion  $O(1)$  and to apply Theorem 5.2. In fact, it is nearly the case: all the properties of the definition of local reduction (see Section 5) are satisfied (by a straightforward verification) except property (R3f). Indeed, the neighborhood of  $V_u$  does not only depend on  $N[u]$ , because for each  $v \in N(u)$ ,  $i_v(u)$  depends on the neighborhood of  $v$ . In fact, it is straightforward to see that the neighborhood of  $V_u$  depends only on  $N^2[u]$ . We will now show that this is not a significant issue, as soon as the property  $\mathcal{P}$  is a property on a class of bounded-degree graphs (which is in particular the case here, since we look at graphs of maximum degree  $\delta$ , which is at most  $5k - 4$ , which is itself a constant).

**Proposition 7.2.** *Let  $\mathcal{P}, \mathcal{P}'$  be two graph properties, on two graph classes  $\mathcal{C}, \mathcal{C}'$  respectively, and let  $d \geq 1$ . If  $\mathcal{C}$  is a class of bounded-degree graphs, then Theorem 5.2*

(and thus also Corollary 5.3) remains true even if we replace condition (R3f) of the definition of local reduction (see Section 5) by the following one:

(R3f')  $V_u$  and its neighborhood (resp.  $C_u$ ) only depends on  $N^d[u]$ . In other words: if  $G'$  is another  $n$ -vertex graph with unique identifiers in  $\{1, \dots, n\}$ , and if the subgraph with identifiers formed by the vertices in  $N^{d-1}[u]$  and their adjacent edges is the same in  $G$  and  $G'$ , then the sets  $V_u$  and the subgraphs with identifiers formed by the vertices in  $V_u$  and their adjacent edges in  $f_{\mathcal{P}', \mathcal{P}}(G)$  and  $f_{\mathcal{P}', \mathcal{P}}(G')$  are the same (resp. the sets  $C_u$  in  $f_{\mathcal{P}', \mathcal{P}}(G)$  and  $f_{\mathcal{P}', \mathcal{P}}(G')$  are the same).

*Proof.* Since  $\mathcal{C}$  is a class of bounded-degree graphs, the set  $N^{d-1}[u]$  has constant size for every vertex  $u$ . In the proof of Theorem 5.2, the prover adds the following information in the certificate of each vertex  $u$ : for every  $v \in N^{d-1}[u]$ , it writes the identifier of  $v$ , its distance to  $u$ , and all the edges adjacent to  $v$ . This information has size  $O(\log n)$  and its correctness can be checked by the vertices at the beginning of the verification procedure. Thus, we can assume that each vertex  $u$  knows all the edges adjacent to the vertices in  $N^{d-1}[u]$ , and the rest of the proof of Theorem 5.2 is the same.  $\square$

Finally, the result of Theorem 7.1 follows from Proposition 7.2: indeed, for every  $\delta \in \{k + \lceil \sqrt{k} \rceil, \dots, 5k - 4\}$ , we obtain a local reduction (in the sense of Proposition 7.2) of constant local expansion, from non- $k$ -colorability in graphs of maximum degree  $\delta$  to non- $k$ -colorability in graphs of maximum degree  $\delta - 1$ . Thus, the  $\Omega(n/\log n)$  lower bound holds for graphs of maximum degree  $k + \lceil \sqrt{k} \rceil - 1$ .  $\square$

We now show that the bound  $k + \lceil \sqrt{k} \rceil - 1$  on the maximum degree in Theorem 7.1 is close to best possible for sufficiently large (but constant)  $k$ .

**Theorem 7.3.** *Let  $k$  be a sufficiently large integer. In graphs of maximum degree  $k + \lceil \sqrt{k} \rceil - 3$ , non- $k$ -colorability has local complexity  $O(\log n)$ .*

*Proof.* It was proved by Molloy and Reed [16, Theorem 5] that for sufficiently large  $k$ , a graph  $G$  of maximum degree  $k + \lceil \sqrt{k} \rceil - 3$  is not  $k$ -colorable if and only if there exists a vertex  $v \in V(G)$  such that the subgraph of  $G$  induced by  $N[v]$  is not  $k$ -colorable. We use this to produce a proof labeling scheme for non- $k$ -colorability as follows. The prover identifies a vertex  $v$  such that the subgraph of  $G$  induced by  $N[v]$  is not  $k$ -colorable, and each vertex  $u$  in the graph receives as a certificate the list  $L(u)$  of all neighbors of  $u$  (as the graph has bounded maximum degree, this list of identifiers takes  $O(\log n)$  bits). Using the lists  $\{L(u) : uv \in E(G)\}$ , the vertex  $v$  knows the subgraph of  $G$  induced by  $N[v]$ , and can thus check that this subgraph is indeed not  $k$ -colorable.  $\square$

## 8. FINAL REMARKS

Since the lower bounds obtained in this paper are all based on NP-hardness reductions, all the applications presented so far relate to coNP-hard problems. It might be tempting to conjecture that all such problems have polynomial local complexity. We now observe that this is not the case.

Indeed, consider the property  $\mathcal{P}$  defined as the set of connected graphs  $G$  for which there exists a vertex  $u \in V(G)$  and an integer  $m \geq 2$  such that  $u$  has degree  $3m$  and the neighbors  $v_1, \dots, v_{3m}$  of  $u$  can be partitioned into  $m$  triples  $T_1, \dots, T_m$



such that, for all  $i \in \{1, \dots, m\}$ ,  $\sum_{v \in T_i} \deg(v) = \frac{1}{m} \sum_{j=1}^{3m} \deg(v_j)$ . The problem of determining whether a graph satisfies  $\mathcal{P}$  is NP-complete : indeed, there is a simple polynomial reduction from 3-partition where the inputs are encoded in unary (recall that 3-partition is strongly NP-complete), which is the following: on an instance  $\mathcal{I} := \{a_1, \dots, a_{3m}\}$  of 3-partition (where  $m \geq 2$ ), we create the graph  $G_{\mathcal{I}}$  consisting of a central vertex  $u$  that has  $3m$  neighbors  $v_1, \dots, v_{3m}$ , and for every  $i \in \{1, \dots, m\}$ ,  $v_i$  has  $a_i - 1$  additional neighbors of degree 1. For every  $i \in \{1, \dots, n\}$ , we have  $\deg(v_i) = a_i$ . The graph  $G_{\mathcal{I}}$  satisfies  $\mathcal{P}$  if and only if we can partition the set of neighbors of  $u$  into triples of vertices that have the same sum of degrees, so if and only if  $\mathcal{I}$  is a valid instance of 3-partition. However, there is a local reduction with certificates of size  $O(\log n)$  for  $\overline{\mathcal{P}}$ , where the certificate of each vertex is its degree. Then, every vertex can simply check that its set of neighbors cannot be partitioned into such triples.

We note that a priori, nothing prevents our reduction framework to be applied to problems that are not coNP-hard. Instead of starting from non-3-colorability, it suffices to start with a problem that has high local complexity, but which is easy globally.

Let us give examples of reductions that apply to problems that are not coNP-hard. For some graphs  $H$ , it is known that certifying that a graph  $G$  does not contain  $H$  as an induced subgraph (we will call this property *H-freeness*) requires certificates of size  $\Omega(n)$ . For instance, it is the case when  $H$  is a clique of size at least 4 [4, Theorem 15]<sup>2</sup>, or when  $H$  is a path of length at least 7 [1, Theorem 7]<sup>3</sup>. However, for every fixed graph  $H$ , determining if an  $n$ -vertex graph  $G$  contains  $H$  as an induced subgraph can be done globally in time  $O(n^{V(H)})$ , so in polynomial time. Here, we present how, starting from a lower bound on the local complexity of  $H$ -freeness, we can prove a lower bound for  $f(H)$ -freeness, for some functions  $f$  on graphs. For instance, let  $k \geq 2$  and let  $f$  be the following function: for every graph  $G$ ,  $f(G)$  is the graph obtained by replacing each vertex of  $G$  by a clique of size  $k$  and each edge of  $G$  by a complete bipartite graph  $K_{k,k}$  (this operation is sometimes called the lexicographic product of  $G$  with  $K_k$ ). It can be easily checked that, for every graphs  $G$  and  $H$ ,  $G$  is  $H$ -free if and only if  $f(G)$  is  $f(H)$ -free. Moreover, this transformation defines a local reduction of constant local expansion, where for each vertex  $u \in V(G)$ , the sets  $V_u$  and  $C_u$  are both equal to the clique of size  $k$  replacing  $u$  in  $V(f(G))$ . Thus, if  $H$ -freeness requires certificates of size  $\Omega(n)$ ,  $f(H)$ -freeness requires certificates of size  $\Omega(n)$  by Theorem 5.2. For instance, if  $H$  is a path of length 7 and if  $k = 2$ , we obtain an  $\Omega(n)$  lower bound for the local complexity of  $H'$ -freeness where  $H'$  is the following graph:

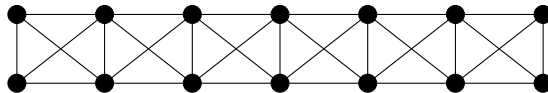

If  $f$  consists in adding a pending vertex to each vertex, it can easily be checked that  $G$  is  $H$ -free if and only if  $f(G)$  is  $f(H)$ -free, and this defines again a local reduction of

<sup>2</sup>The model considered in [4] is a bit different from local certification but their proof can be easily adapted to work in this model.

<sup>3</sup>Authors in [1] actually prove the  $\Omega(n)$  lower bound for  $P_7$ -graphs but their proof can be easily adapted to paths of length  $\ell$  for every  $\ell \geq 7$ , by adding a pending path of length  $\ell - 7$  to the vertex  $v_0$  in their construction.

constant local expansion. So for instance, if  $H$  is a path of length 7, we obtain an  $\Omega(n)$  lower bound for the local complexity of  $H'$ -freeness where  $H'$  is the following graph:

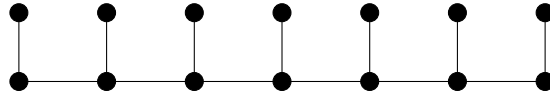

If  $f$  consists in adding a pending path of length  $t$  to every vertex, if  $i, j$  are two integers such that  $i + j \geq 6$ , it can easily be checked that  $G$  contains no path of length  $i + j + 1$  if and only if  $f(G)$  contains no claw with a central vertex and three branches of length  $(t, t + i, t + j)$ . This transformation defines again a local reduction of constant local expansion. For instance, with  $t = 3, i = 2, j = 4$ , we obtain a  $\Omega(n)$  lower bound on the local complexity of  $H'$ -freeness where  $H'$  is the claw with branches of size  $(3, 5, 7)$ , that is, the following graph:

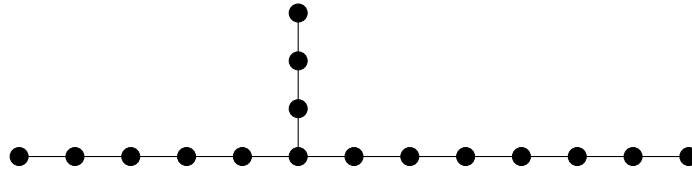

## REFERENCES

- [1] Nicolas Bousquet, Linda Cook, Laurent Feuilloley, Théo Pierron, and Sébastien Zeitoun. Local certification of forbidden subgraphs. *CoRR*, abs/2402.12148, 2024.
- [2] Nicolas Bousquet, Louis Esperet, Laurent Feuilloley, and Sébastien Zeitoun. Renaming in distributed certification. *CoRR*, abs/2409.15404, 2024.
- [3] Oscar Defrain, Louis Esperet, Aurélie Lagoutte, Pat Morin, and Jean-Florent Raymond. Local certification of geometric graph classes. In Rastislav Královic and Antonín Kucera, editors, *49th International Symposium on Mathematical Foundations of Computer Science, MFCS 2024, August 26-30, 2024, Bratislava, Slovakia*, volume 306 of *LIPICs*, pages 48:1–48:14. Schloss Dagstuhl - Leibniz-Zentrum für Informatik, 2024.
- [4] Andrew Drucker, Fabian Kuhn, and Rotem Oshman. On the power of the congested clique model. In Magnús M. Halldórsson and Shlomi Dolev, editors, *ACM Symposium on Principles of Distributed Computing, PODC '14, Paris, France, July 15-18, 2014*, pages 367–376. ACM, 2014.
- [5] Thomas Emden-Weinert, Stefan Hougardy, and Bernd Kreuter. Uniquely colourable graphs and the hardness of colouring graphs of large girth. *Comb. Probab. Comput.*, 7(4):375–386, 1998.
- [6] Louis Esperet and Benjamin Lévêque. Local certification of graphs on surfaces. *Theoretical Computer Science*, 909:68–75, 2022.
- [7] Laurent Feuilloley. Introduction to local certification. *Discret. Math. Theor. Comput. Sci.*, 23(3), 2021.
- [8] Laurent Feuilloley, Nicolas Bousquet, and Théo Pierron. What can be certified compactly? Compact local certification of MSO properties in tree-like graphs. In Alessia Milani and Philipp Woelfel, editors, *PODC '22: ACM Symposium on Principles of Distributed Computing, Salerno, Italy, July 25 - 29, 2022*, pages 131–140. ACM, 2022.
- [9] Laurent Feuilloley, Pierre Fraigniaud, Pedro Montealegre, Ivan Rapaport, Éric Rémila, and Ioan Todinca. Compact distributed certification of planar graphs. *Algorithmica*, 83(7):2215–2244, 2021.
- [10] Laurent Feuilloley, Pierre Fraigniaud, Pedro Montealegre, Ivan Rapaport, Éric Rémila, and Ioan Todinca. Local certification of graphs with bounded genus. *Discrete Applied Mathematics*, 325:9–36, 2023.

- [11] Pierre Fraigniaud, Frédéric Mazoit, Pedro Montealegre, Ivan Rapaport, and Ioan Todinca. Distributed certification for classes of dense graphs. In Rotem Oshman, editor, *37th International Symposium on Distributed Computing, DISC 2023, October 10-12, 2023, L'Aquila, Italy*, volume 281 of *LIPICs*, pages 20:1–20:17. Schloss Dagstuhl - Leibniz-Zentrum für Informatik, 2023.
- [12] Pierre Fraigniaud, Pedro Montealegre, Ivan Rapaport, and Ioan Todinca. A meta-theorem for distributed certification. In Merav Parter, editor, *Structural Information and Communication Complexity - 29th International Colloquium, SIROCCO 2022, Paderborn, Germany, June 27-29, 2022, Proceedings*, volume 13298 of *Lecture Notes in Computer Science*, pages 116–134. Springer, 2022.
- [13] Michael R. Garey, David S. Johnson, and Larry J. Stockmeyer. Some simplified NP-complete graph problems. *Theor. Comput. Sci.*, 1(3):237–267, 1976.
- [14] Mika Göös and Jukka Suomela. Locally checkable proofs in distributed computing. *Theory Comput.*, 12(1):1–33, 2016.
- [15] Ian Holyer. The NP-completeness of edge-coloring. *SIAM J. Comput.*, 10(4):718–720, 1981.
- [16] Michael Molloy and Bruce Reed. Colouring graphs when the number of colours is almost the maximum degree. *J. Comb. Theory, Ser. B*, 109:134–195, 2014.
- [17] Moni Naor, Merav Parter, and Eylon Yogev. The power of distributed verifiers in interactive proofs. In Shuchi Chawla, editor, *Proceedings of the 2020 ACM-SIAM Symposium on Discrete Algorithms, SODA 2020, Salt Lake City, UT, USA, January 5-8, 2020*, pages 1096–115. SIAM, 2020.
- [18] Michael Sipser. *Introduction to the theory of computation*. PWS Publishing Company, 1997.
- [19] Iain A. Stewart. Deciding whether a planar graph has a cubic subgraph is NP-complete. *Discret. Math.*, 126(1-3):349–357, 1994.
- [20] Iain A. Stewart. On locating cubic subgraphs in bounded-degree connected bipartite graphs. *Discret. Math.*, 163(1-3):319–324, 1997.

(L. Esperet) UNIV. GRENOBLE ALPES, CNRS, LABORATOIRE G-SCOP, GRENOBLE, FRANCE  
*Email address:* louis.esperet@grenoble-inp.fr

(S. Zeitoun) CNRS, INSA LYON, UCBL, LIRIS, UMR5205, F-69622 VILLEURBANNE, FRANCE  
*Email address:* sebastien.zeitoun@univ-lyon1.fr