

THE AUTOMORPHISM GROUP OF AN APÉRY–FERMI $K3$ SURFACE

ICHIRO SHIMADA

ABSTRACT. An Apéry–Fermi $K3$ surface is a complex $K3$ surface of Picard number 19 that is birational to a general member of a certain one-dimensional family of affine surfaces related to the Fermi surface in solid-state physics. This $K3$ surface is also linked to a recurrence relation that appears in the famous proof of the irrationality of $\zeta(3)$ by Apéry.

We compute the automorphism group $\text{Aut}(X)$ of the Apéry–Fermi $K3$ surface X using Borcherds’ method. We describe $\text{Aut}(X)$ in terms of generators and relations. Moreover, we determine the action of $\text{Aut}(X)$ on the set of ADE-configurations of smooth rational curves on X for some ADE-types. In particular, we show that $\text{Aut}(X)$ acts transitively on the set of smooth rational curves, and that it partitions the set of pairs of disjoint smooth rational curves into two orbits.

1. INTRODUCTION

1.1. **Main results.** We consider a pencil of complex affine surfaces $X_s^\circ \subset \mathbb{A}^3$ defined by the equation

$$(1.1) \quad \xi_1 + \frac{1}{\xi_1} + \xi_2 + \frac{1}{\xi_2} + \xi_3 + \frac{1}{\xi_3} = s,$$

where ξ_1, ξ_2, ξ_3 are coordinates of \mathbb{A}^3 , and $s \in \mathbb{C}$ is a parameter. When s is very general, the surface X_s° is birational to a projective $K3$ surface X_s whose Néron–Severi lattice is isomorphic to

$$(1.2) \quad M_6 := U \oplus E_8(-1) \oplus E_8(-1) \oplus \langle -12 \rangle,$$

where U is the hyperbolic plane, $E_8(-1)$ is the negative-definite root lattice of type E_8 , and $\langle -12 \rangle$ is a rank-one lattice generated by a vector with square-norm -12 . We call the $K3$ surface X_s with s sufficiently general an *Apéry–Fermi $K3$ surface*. For simplicity, we assume that the parameter s is very general throughout this work.

In this paper, we study the automorphism group $\text{Aut}(X_s)$ of the Apéry–Fermi $K3$ surface X_s by using Borcherds’ method. We provide a finite set of generators of $\text{Aut}(X_s)$, and describe the action of $\text{Aut}(X_s)$ on the nef-and-big cone of X_s explicitly. We prove that the nef-and-big cone of X_s is tessellated by copies of a polyhedral cone with 80 walls, that the action of $\text{Aut}(X_s)$ preserves this tessellation, and that $\text{Aut}(X_s)$ acts transitively on the set of tiles of this tessellation with the stabilizer subgroup $\text{Aut}(X_s, D_0)$ of a tile D_0 being isomorphic to a dihedral group of order 16. Using this tessellation, we obtain the following result in Section 3:

Key words and phrases. $K3$ surface, automorphism group, lattice.

Supported by JSPS KAKENHI Grant Number 20H01798, 20K20879, 20H00112, and 23H00081.

μ	τ	$ \mathfrak{C}(\tau)/\text{Aut}(X_s) $	μ	τ	$ \mathfrak{C}(\tau)/\text{Aut}(X_s) $
1	A_1	1	4	$4A_1$	2
2	$2A_1$	2	4	$2A_1 + A_2$	2
2	A_2	1	4	$A_1 + A_3$	9
3	$3A_1$	2	4	$2A_2$	2
3	$A_1 + A_2$	1	4	A_4	1
3	A_3	3	4	D_4	2

TABLE 1.1. Sizes of $\mathfrak{C}(\tau)/\text{Aut}(X_s)$

Theorem 1.1. *The automorphism group $\text{Aut}(X_s)$ is generated by a finite subgroup $\text{Aut}(X_s, D_0)$ of order 16, and eight extra automorphisms.*

In Section 4, we provide an explicit geometric description of these generators in terms of Mordell–Weil groups of Jacobian fibrations, using the algorithm for computing the Mordell–Weil action on the Néron–Severi lattice described in our previous paper [23]. We also analyze the faces of D_0 , and using the list of codimension-2 faces, we describe $\text{Aut}(X_s)$ in terms of generators and relations in Section 6.

Next we study the action of $\text{Aut}(X_s)$ on the set of ADE-configurations of smooth rational curves on X_s . Let τ be an ordinary ADE-type, and let μ be the number of nodes in the corresponding Dynkin diagram. We denote by $\mathfrak{C}(\tau)$ the set of all non-ordered sets $\mathcal{C} = \{C_1, \dots, C_\mu\}$ of smooth rational curves on X_s such that the dual graph of \mathcal{C} is the Dynkin diagram of type τ . For example, $\mathfrak{C}(A_1)$ is the set of smooth rational curves on X_s , $\mathfrak{C}(2A_1)$ is the set of non-ordered pairs of disjoint smooth rational curves, whereas $\mathfrak{C}(A_2)$ is the set of non-ordered pairs of smooth rational curves intersecting at one point transversely.

Theorem 1.2. *For $\mu \leq 4$, the numbers of the orbits of the action of $\text{Aut}(X_s)$ on the set $\mathfrak{C}(\tau)$ are given in Table 1.1.*

Corollary 1.3. *The group $\text{Aut}(X_s)$ acts on the set of smooth rational curves on X_s transitively. \square*

In fact, it is theoretically possible to obtain the same result for ADE-types τ with higher Milnor numbers μ . However, we stopped the computation at $\mu = 4$ because the computation becomes too expensive for $\mu \geq 5$. See Section 5.3.

Our result is obtained by using Borcherds’ method. This method was introduced by Borcherds [7], [8], and its first geometric application was given by Kondo [16]. In [22] and [23], we presented tools and techniques for implementing Borcherds’ method on a computer.

Borcherds’ method has been applied to many $K3$ and Enriques surfaces. With the advances in machine computing power, the geometric information that can be obtained by means of this method is rapidly expanding. A secondary aim of this paper is to highlight the usefulness and strength of this method by applying it to an important $K3$ surface.

1.2. Previous studies of the Apéry–Fermi $K3$ surface. The Apéry–Fermi $K3$ surface is an important $K3$ surface that has been extensively studied by many authors. Here, we provide a brief review of previous works related to the Apéry–Fermi $K3$ surface.

In 1984, Beukers and Peters [6] constructed a one-dimensional family of $K3$ surfaces whose Picard–Fuchs equation is the differential equation arising in Apéry’s famous proof [2] of irrationality of $\zeta(3)$. In 1986, Peters [19] determined the Néron–Severi lattice and the transcendental lattice of the general member of this family, and in 1989, Peters and Stienstra [20] showed that the general member is an Apéry–Fermi $K3$ surface defined above. The equation (1.1) has its origin in the solid-state physics, where it is related to the Fermi surface of electrons moving in a crystal.

In 1996, Dolgachev [12] introduced the notion of *lattice polarized $K3$ surfaces*. The Apéry–Fermi $K3$ surface is an M_6 -lattice polarized $K3$ surface, and Dolgachev [12] determined, among other things, the coarse moduli space of Apéry–Fermi $K3$ surfaces. In 2004, Hosono et al. [15] used Apéry–Fermi $K3$ surfaces in the study of the autoequivalences of derived category of its Fourier–Mukai partner, a $K3$ surface with Picard number 1 and of degree 12. In the paper [11] of Dardanelli and van Geemen, the Apéry–Fermi $K3$ surfaces appear as the Hessians of certain cubic surfaces (see Proposition 5.7 of [11]).

On the other hand, there exists a rigid Calabi–Yau 3-fold birational to a smooth affine 3-fold defined by

$$(1.3) \quad \xi_1 + \frac{1}{\xi_1} + \xi_2 + \frac{1}{\xi_2} + \xi_3 + \frac{1}{\xi_3} + \xi_4 + \frac{1}{\xi_4} = 0.$$

Its modularity was studied by van Geemen and Nygaard [26], Verrill [27], and Ahlgren and Ono [1].

In 2015, Mukai and Ohashi [17] found another birational model of the Apéry–Fermi $K3$ surface: the symmetric quartic surface $Y_t \subset \mathbb{P}^3$ defined by

$$(1.4) \quad (x_1x_2 + x_1x_3 + x_1x_4 + x_2x_3 + x_2x_4 + x_3x_4)^2 = tx_1x_2x_3x_4,$$

where $(x_1 : x_2 : x_3 : x_4)$ are homogeneous coordinates of \mathbb{P}^3 and $t \in \mathbb{C}$ is a parameter. Mukai and Ohashi [17] exhibited an Enriques involution ε of Y_t , and described the automorphism group of the Enriques surface birational to $Y_t/\langle \varepsilon \rangle$.

Remark 1.4. To the best of our knowledge, the fact that the Apéry–Fermi $K3$ surface X_s is birational to the quartic surface Y_t for some $t = t(s)$ has not yet appeared in the literature. We were informed of this fact through personal communication with the authors of [17]. See Proposition 2.3 for the proof of this fact.

In 2020, Bertin and Lecacheux [4] determined all Jacobian fibrations of the Apéry–Fermi $K3$ surface by using Kneser–Nishiyama method. The geometry of some special members of the pencil (1.1) has also been studied, for example, in Bertin and Lecacheux [3], [5]. In [14], Festi and van Straten provided an account on the relation between the Apéry–Fermi $K3$ surfaces and quantum electrodynamics, highlighting the importance of studying this $K3$ surface.

1.3. Plan of this paper. In Section 2, we review the result of Peters and Stienstra [20], and present 32 smooth rational curves on the $K3$ surface X_s whose classes generate the Néron–Severi lattice of X_s . We also compare X_s with the quartic surface Y_t of Mukai and Ohashi [17], and prove that X_s is birational to Y_t for a suitable choice of t (see Remark 1.4). In Section 3, we execute Borcherds’ method, and obtain a set of generators of $\text{Aut}(X_s)$ *lattice-theoretically*, thereby proving Theorem 1.1. We also describe the finite polytope D_0 with 80 walls and prove Corollary 1.3. In Section 4, we give geometric realization to each of the generators of $\text{Aut}(X_s)$ given in Theorem 1.1. In Section 5, we calculate the set of faces of the

polytope D_0 , and prove Theorem 1.2 in Section 5.3. In Section 6, we explain how to describe $\text{Aut}(X_s)$ in terms of generators and relations using the codimension-2 faces of D_0 .

Detailed computational data are available from [24]. For our computation, we used GAP [25].

Acknowledgements. We are grateful to Professor Shigeru Mukai, Professor Shigeyuki Kondo, and Professor Hisanori Ohashi for providing information about the quartic surface Y_t . We also thank Professor Takuya Yamauchi for enlightening us about the rigid Calabi–Yau 3-fold (1.3).

2. TWO PROJECTIVE MODELS OF AN APÉRY–FERMI $K3$ SURFACE

2.1. The Fermi surface model. We review the result of Peters and Stienstra [20]. Let X_s° be the affine surface in \mathbb{A}^3 defined by the equation (1.1), and let X_s be the $K3$ surface containing X_s° as a Zariski open subset. Recall that we have assumed that the parameter $s \in \mathbb{C}$ is very general. We present 32 smooth rational curves on X_s whose classes generate the Néron–Severi lattice $\text{NS}(X_s)$ of X_s .

The $K3$ surface X_s is isomorphic to a smooth surface in $\mathbb{P}^6 \times \mathbb{P}^1 \times \mathbb{P}^1 \times \mathbb{P}^1$ defined by the equation (4) in [20]. Considering the projection onto the first factor \mathbb{P}^6 , we see that X_s is birational to the surface \bar{X}_s in \mathbb{P}^6 defined by

$$(2.1) \quad \begin{aligned} u_1 + u_2 + u_3 + v_1 + v_2 + v_3 &= sw, \\ u_1v_1 - w^2 &= u_2v_2 - w^2 = u_3v_3 - w^2 = 0, \end{aligned}$$

where $(w : u_1 : u_2 : u_3 : v_1 : v_2 : v_3)$ is a homogeneous coordinate system of \mathbb{P}^6 such that we have $\xi_i = u_i/w = w/v_i$ on X_s° . We denote by H_∞ the hyperplane of \mathbb{P}^6 defined by $w = 0$. For $i = 1, 2, 3$, let $\gamma_i \in \{0, +, -\}$ denote the condition

$$\begin{cases} u_i = 0 \text{ and } v_i = 0, & \text{if } \gamma_i = 0, \\ u_i \neq 0 \text{ and } v_i = 0, & \text{if } \gamma_i = +, \\ u_i = 0 \text{ and } v_i \neq 0, & \text{if } \gamma_i = -. \end{cases}$$

If one of $\gamma_1, \gamma_2, \gamma_3$ is 0 and the other two are not, then the conditions $\gamma_1, \gamma_2, \gamma_3$ with $w = 0$ determine a single point $p_{\gamma_1\gamma_2\gamma_3}$ on $\bar{X}_s \cap H_\infty$. For example, we have

$$p_{+-0} = (0 : 1 : 0 : 0 : 0 : -1 : 0).$$

The points $p_{\gamma_1\gamma_2\gamma_3}$ are ordinary nodes of \bar{X}_s , and the singular locus $\text{Sing } \bar{X}_s$ of \bar{X}_s consists of these 12 points. Let $L_{\gamma_1\gamma_2\gamma_3}$ denote the exceptional (-2) -curve of the minimal desingularization $X_s \rightarrow \bar{X}_s$ over $p_{\gamma_1\gamma_2\gamma_3}$. If none of $\gamma_1, \gamma_2, \gamma_3$ is 0, then the conditions γ_1 and γ_2 and γ_3 with $w = 0$ define a line $\bar{L}_{\gamma_1\gamma_2\gamma_3}$ on $\bar{X}_s \cap H_\infty$. For example, we have

$$\bar{L}_{+++} = \{(0 : \lambda_1 : 0 : \lambda_3 : 0 : \lambda_2 : 0) \mid \lambda_1 + \lambda_2 + \lambda_3 = 0\}.$$

Let $L_{\gamma_1\gamma_2\gamma_3} \subset X_s$ denote the strict transform of $\bar{L}_{\gamma_1\gamma_2\gamma_3}$ in X_s . Thus, we obtain $12 + 8$ smooth rational curves $L_{\gamma_1\gamma_2\gamma_3}$ on X_s .

Let $\sigma, \sigma^{-1} \in \mathbb{C}$ be the roots of the equation $\xi + 1/\xi = s$. For $k \in \{1, 2, 3\}$ and $\alpha, \beta \in \{+, -\}$, we define the curve $M_{k\alpha\beta}$ on X_s as follows. Let i, j be the indexes such that $\{i, j, k\} = \{1, 2, 3\}$. The curve defined by

$$\xi_i + 1/\xi_i + \xi_j + 1/\xi_j = 0$$

in \mathbb{A}^2 with coordinates (ξ_i, ξ_j) is a union of two rational curves $\xi_i + \xi_j = 0$ and $\xi_i \xi_j + 1 = 0$. Let $M_{k\alpha\beta}^\circ$ be the curve on $X_s^\circ \subset \mathbb{A}^3$ defined by

$$\begin{cases} \xi_k = \sigma & \text{if } \alpha = +, \\ \xi_k = \sigma^{-1} & \text{if } \alpha = - \end{cases}, \quad \text{and} \quad \begin{cases} \xi_i + \xi_j = 0 & \text{if } \beta = +, \\ \xi_i \xi_j + 1 = 0 & \text{if } \beta = -, \end{cases}$$

and let $M_{k\alpha\beta} \subset X_s$ be the strict transform of the closure of $M_{k\alpha\beta}^\circ$. Thus, we obtain 12 smooth rational curves $M_{k\alpha\beta}$ on X_s .

We now confirm the following results proved in Section 7 of [19] and [20] by direct computation.

Lemma 2.1. (1) *The intersection numbers of these 20 + 12 smooth rational curves $L_{\gamma_1\gamma_2\gamma_3}$ and $M_{k\alpha\beta}$ are as follows.*

- (i) *The dual graph of the curves $L_{\gamma_1\gamma_2\gamma_3}$ is shown in Figure 2.1, which we refer to as the L-cube.*
- (ii) *The curves $M_{k\alpha\beta}$ intersect as follows:*

$$\langle M_{k\alpha\beta}, M_{k'\alpha'\beta'} \rangle = \begin{cases} -2 & \text{if } k = k', \alpha = \alpha', \beta = \beta', \\ 2 & \text{if } k = k', \alpha = \alpha', \beta \neq \beta', \\ 0 & \text{if } k = k', \alpha \neq \alpha', \beta = \beta', \\ 0 & \text{if } k = k', \alpha \neq \alpha', \beta \neq \beta', \\ 1 & \text{if } k \neq k', \alpha = \alpha', \beta = \beta', \\ 0 & \text{if } k \neq k', \alpha = \alpha', \beta \neq \beta', \\ 0 & \text{if } k \neq k', \alpha \neq \alpha', \beta = \beta', \\ 1 & \text{if } k \neq k', \alpha \neq \alpha', \beta \neq \beta'. \end{cases}$$

- (iii) *We have*

$$\langle L_{\gamma_1\gamma_2\gamma_3}, M_{k\alpha\beta} \rangle = \begin{cases} 1 & \text{if } \gamma_k = 0 \text{ and } \beta = \gamma_i\gamma_j, \text{ where } \{i, j, k\} = \{1, 2, 3\}, \\ 0 & \text{otherwise.} \end{cases}$$

(2) *The classes of these 32 smooth rational curves span the Néron–Severi lattice $\text{NS}(X_s)$ of X_s , which is of rank 19 and with discriminant -12 .*

(3) *The lattice $\text{NS}(X_s)$ is isomorphic to the lattice M_6 defined by (1.2).* \square

To prove the assertion (3), we use the following Jacobian fibration of X_s . The configuration of the 32 smooth rational curves described in Lemma 2.1 contains a sub-configuration shown in Figure 2.2. Hence X_s has an elliptic fibration with a section M_{2++} and two singular fibers of type II^* . Consequently, $\text{NS}(X_s)$ contains a rank-18 sublattice isomorphic to $U \oplus E_8(-1) \oplus E_8(-1)$. Since this sublattice is unimodular, it must be a direct summand of $\text{NS}(X_s)$. Comparing the discriminant, we see that $\text{NS}(X_s)$ is isomorphic to M_6 .

Thus, X_s can be regarded as an M_6 -lattice polarized K3 surface in the sense of Dolgachev [12]. According to [12], the isomorphism classes of M_6 -lattice polarized K3 surfaces are parameterized by an irreducible curve, and our surface X_s corresponds to a geometric generic point of this curve.

2.2. The Mukai–Ohashi quartic. Let Y_t be the quartic surface in \mathbb{P}^3 defined by the quartic polynomial (1.4), where the parameter t is assumed to be very general. For $i \in \{1, \dots, 4\}$, let $H_i \subset \mathbb{P}^3$ denote the plane defined by $x_i = 0$, and let p_i denote the point such that $\{p_i\} = H_j \cap H_k \cap H_l$, where $\{i, j, k, l\} = \{1, \dots, 4\}$. Then the

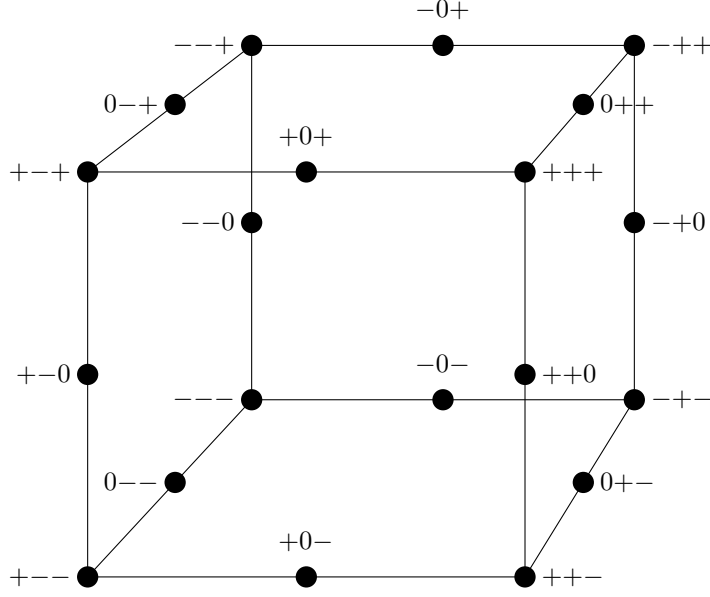
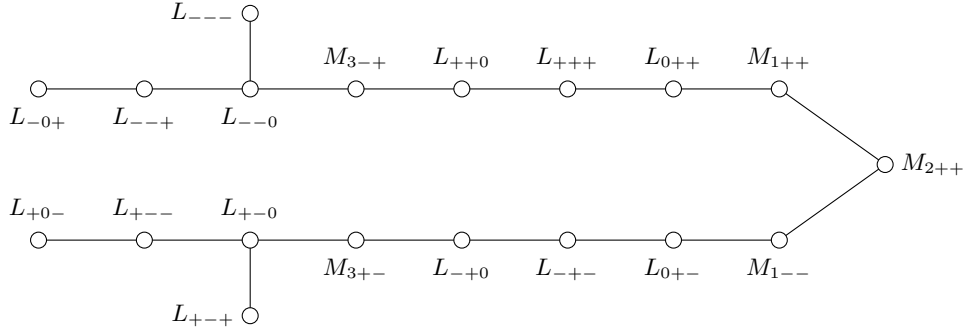
FIGURE 2.1. Dual graph of the curves $L_{\gamma_1 \gamma_2 \gamma_3}$ (L -cube)FIGURE 2.2. Sub-configuration containing $2\Pi^*$

singular locus $\text{Sing } Y_t$ of Y_t consists of four points p_1, \dots, p_4 . Let $(\mathbb{P}^3)' \rightarrow \mathbb{P}^3$ be the blowing up at the points p_1, \dots, p_4 . We denote by $Y'_t \subset (\mathbb{P}^3)'$ the strict transform of Y_t , and by $E_i \subset (\mathbb{P}^3)'$ the exceptional divisor over p_i . We have homogeneous coordinates $(u_{ij} : u_{ik} : u_{il})$ of $E_i \cong \mathbb{P}^2$, where $\{i, j, k, l\} = \{1, \dots, 4\}$, such that the strict transform of the plane in \mathbb{P}^3 defined by $a_j x_j + a_k x_k + a_l x_l = 0$ intersects E_i along the line $a_j u_{ij} + a_k u_{ik} + a_l u_{il} = 0$. We consider the line

$$\Lambda_i : u_{ij} + u_{ik} + u_{il} = 0$$

on E_i . Then the scheme-theoretic intersection of Y'_t and E_i is the double line $2\Lambda_i$. For $\nu \in \{j, k, l\}$, let $q_{i\nu}$ be the intersection point in $E_i \cong \mathbb{P}^2$ of the line Λ_i and the line defined by $u_{i\nu} = 0$. Then the singular points of Y'_t located on E_i are precisely the three points $q_{i\nu}$, forming a total of 3×4 ordinary nodes of Y'_t . Let $(\mathbb{P}^3)'' \rightarrow (\mathbb{P}^3)'$

be the blowing up at these nodes $q_{i\nu}$, and let $Y_t'' \subset (\mathbb{P}^3)''$ be the strict transform of Y_t' . Then Y_t'' is smooth. Let $P_i \subset Y_t''$ be the strict transform of Λ_i , and let $Q_{i\nu} \subset Y_t''$ be the exceptional curve over the ordinary node $q_{i\nu} \in Y_t'$. Then, for each i , the smooth rational curves P_i and $Q_{i\nu}$ ($\nu \in \{j, k, l\}$) form a dual graph isomorphic to the Dynkin diagram of type D_4 with P_i being the central node.

The scheme-theoretic intersection of Y_t and $H_\lambda = \{x_\lambda = 0\}$ is a double conic $2T_\lambda$, where T_λ is a smooth conic on H_λ . Let $T_\lambda' \subset Y_t'$ and $T_\lambda'' \subset Y_t''$ be the strict transforms of T_λ in Y_t' and in Y_t'' , respectively. Suppose that $i \neq \lambda$. Then T_λ' intersects E_i at the point $q_{i\lambda}$, and the curve T_λ'' intersects $Q_{i\lambda}$, but is disjoint from the other three component P_i and $Q_{i\mu}, Q_{i\nu}$ of the D_4 -configuration over p_i , where $\{i, \lambda, \mu, \nu\} = \{1, \dots, 4\}$.

Let τ and $1/\tau$ be the two roots of the equation $(u-1)^2 - tu = 0$ in variable u . Let $\mu, \nu \in \{1, \dots, 4\}$ be distinct indexes, and let $H_{\mu\nu} \subset \mathbb{P}^3$ be the plane in \mathbb{P}^3 defined by $x_\mu + x_\nu = 0$. We put $\{i, j\} = \{1, \dots, 4\} \setminus \{\mu, \nu\}$. Then $H_{\mu\nu} \cap Y_t$ is a union of two conics

$$C_{\mu\nu, \rho} \quad : \quad x_\mu x_\nu + \rho x_i x_j = x_\mu + x_\nu = 0,$$

where $\rho \in \{\tau, 1/\tau\}$. Let $C_{\mu\nu, \rho}' \subset Y_t'$ and $C_{\mu\nu, \rho}'' \subset Y_t''$ be the strict transforms of $C_{\mu\nu, \rho}$ in Y_t' and in Y_t'' , respectively. Note that, since the strict transform $H_{\mu\nu}' \subset (\mathbb{P}^3)'$ of $H_{\mu\nu}$ intersects the exceptional surface E_i along the line $u_{i\mu} + u_{i\nu} = 0$, the curves $C_{\mu\nu, \tau}'$ and $C_{\mu\nu, 1/\tau}'$ pass through q_{ij} , because Λ_i is defined by $u_{ij} + u_{i\mu} + u_{i\nu} = 0$. Thus, the curves $C_{\mu\nu, \tau}''$ and $C_{\mu\nu, 1/\tau}''$ intersect Q_{ij} .

We can now establish the following result by direct computation.

Lemma 2.2. *The intersection numbers of the 32 smooth rational curves P_i, Q_{ij}, T_ν'' , and $C_{\mu\nu, \rho}''$ on Y_t'' are as follows.*

- (i) *The dual graph of the curves P_i, Q_{ij}, T_ν'' is shown in Figure 2.3, where the thick edges indicate the four D_4 -configurations over the singular points of Y_t .*
- (ii) *The intersection numbers of the curves $C_{\mu\nu, \rho}''$, where $\mu, \nu \in \{1, \dots, 4\}$ with $\mu \neq \nu$ and $\rho \in \{\tau, 1/\tau\}$, are as follows.*

If $\{\mu, \nu\} = \{\mu', \nu'\}$, then

$$\langle C_{\mu\nu, \rho}'', C_{\mu'\nu', \rho'}'' \rangle = \begin{cases} -2 & \text{if } \rho = \rho', \\ 0 & \text{if } \rho \neq \rho'. \end{cases}$$

If $\{\mu, \nu\} \cap \{\mu', \nu'\}$ consists of a single element, then

$$\langle C_{\mu\nu, \rho}'', C_{\mu'\nu', \rho'}'' \rangle = \begin{cases} 1 & \text{if } \rho = \rho', \\ 0 & \text{if } \rho \neq \rho'. \end{cases}$$

If $\{\mu, \nu\} \cap \{\mu', \nu'\} = \emptyset$, then

$$\langle C_{\mu\nu, \rho}'', C_{\mu'\nu', \rho'}'' \rangle = \begin{cases} 0 & \text{if } \rho = \rho', \\ 2 & \text{if } \rho \neq \rho'. \end{cases}$$

- (iii) *The curve $C_{\mu\nu, \rho}''$ is disjoint from P_i, T_ν'' , and we have*

$$\langle C_{\mu\nu, \rho}'', Q_{ij} \rangle = \begin{cases} 1 & \text{if } \{\mu, \nu, i, j\} = \{1, 2, 3, 4\}, \\ 0 & \text{otherwise.} \end{cases}$$

□

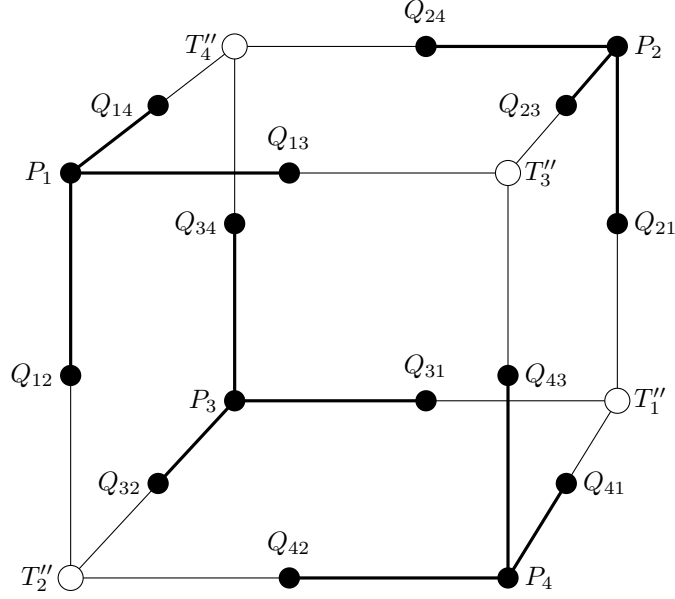
FIGURE 2.3. Dual graph of the curves P_i, Q_{ij}, T''_ν

$k\alpha\beta$	1--	1-+	1+-	1++	2--	2-+	2+-	2++
$\mu\nu, \rho$	23, τ	14, $1/\tau$	23, $1/\tau$	14, τ	13, τ	24, $1/\tau$	13, $1/\tau$	24, τ
$k\alpha\beta$	3--	3-+	3+-	3++				
$\mu\nu, \rho$	34, τ	12, $1/\tau$	34, $1/\tau$	12, τ				

TABLE 2.1. Bijection between $M_{k\alpha\beta}$ and $C''_{\mu\nu, \rho}$

As noted in Remark 1.4, the following result was known to the authors of [17].

Proposition 2.3. *There exists a parameter $t(s) \in \mathbb{C}$ such that the K3 surfaces X_s and $Y''_{t(s)}$ are isomorphic.*

Proof. The 32 smooth rational curves in Lemma 2.1 and those in Lemma 2.2 have the same configuration. Indeed, a bijection between these two sets of 32 curves preserving their intersection numbers can be established by comparing the cubes in Figures 2.1 and 2.3 for the curves $L_{\gamma_1\gamma_2\gamma_3}$, and using Table 2.1 for $M_{k\alpha\beta}$.

Since the isomorphism class of the K3 surface Y''_t varies as t changes, and t is assumed to be very general, we conclude that $\text{NS}(Y''_t)$ is of rank 19. By Lemma 2.1 (2) and the bijection above, $\text{NS}(Y''_t)$ contains a sublattice isomorphic to $\text{NS}(X_s)$ with finite index. Since $\text{NS}(X_s)$ admits no non-trivial even overlattice, as was noted in the proof of Proposition 7.1.1 of [19], we see that $\text{NS}(X_s) \cong \text{NS}(Y_t)$. By Corollary 7.1.3 of [19], the transcendental lattice of X_s is isomorphic to that of Y''_t . Applying the Torelli theorem for K3 surfaces, we conclude that there exists a suitable choice of $t(s)$ for which $X_s \cong Y''_{t(s)}$. \square

3. NÉRON–SEVERI LATTICE AND AUTOMORPHISM GROUP

From now on, we omit the parameter s in X_s , and simply denote the Apéry–Fermi K3 surface by X . We also write S_X for the Néron–Severi lattice $\text{NS}(X)$ of X . We make the orthogonal group $\text{O}(S_X)$ act on S_X from the right.

3.1. Chambers and their faces. We fix terminologies and notation about lattices and hyperbolic spaces. Let L be an even lattice of signature $(1, l-1)$ with $l \geq 2$. A *positive cone* of L is one of the two connected components of the space

$$\{x \in L \otimes \mathbb{R} \mid \langle x, x \rangle > 0\}.$$

We fix a positive cone \mathcal{P}_L , and define the autochronous subgroup of $\text{O}(L)$ as

$$\text{O}(L, \mathcal{P}_L) := \{g \in \text{O}(L) \mid \mathcal{P}_L^g = \mathcal{P}_L\}.$$

We also define

$$\mathcal{R}_L := \{r \in L \mid \langle r, r \rangle = -2\}.$$

For $v \in L \otimes \mathbb{R}$ with $\langle v, v \rangle < 0$, let $(v)^\perp$ denote the real hyperplane in \mathcal{P}_L defined by $\langle x, v \rangle = 0$. The *Weyl group* $W(L)$ is the subgroup of $\text{O}(L, \mathcal{P}_L)$ generated by reflections $x \mapsto x + \langle x, r \rangle r$ into the mirrors $(r)^\perp$ defined by vectors $r \in \mathcal{R}_L$. A *standard fundamental domain of the action of the Weyl group $W(L)$ on \mathcal{P}_L* is the closure in \mathcal{P}_L of a connected component of the space

$$\mathcal{P}_L \setminus \bigcup_{r \in \mathcal{R}_L} (r)^\perp.$$

Now, let M be a primitive sublattice of L with signature $(1, m-1)$ with $m \geq 2$, and let \mathcal{P}_M be the positive cone $(M \otimes \mathbb{R}) \cap \mathcal{P}_L$ of M .

Definition 3.1. An *L/M -chamber* is a closed subset D of \mathcal{P}_M such that

- (i) D has the form $\mathcal{P}_M \cap D_L$, where D_L is a standard fundamental domain of the action of $W(L)$ on \mathcal{P}_L , and
- (ii) D contains a nonempty open subset of \mathcal{P}_M .

Each L/M -chamber is defined in \mathcal{P}_M by locally finite linear inequalities

$$(3.1) \quad \langle x, v_i \rangle \geq 0, \quad \text{where } v_i \in M \otimes \mathbb{Q}.$$

Remark 3.2. According to this terminology, the lengthy phrase “standard fundamental domain of the action of $W(L)$ on \mathcal{P}_L ” can be shortened to “ L/L -chamber”. Note that $W(L)$ acts on the set of L/L -chambers simply transitively.

Remark 3.3. In general, L/M -chambers are *not* congruent to each other.

Remark 3.4. Each M/M -chamber is a union of L/M -chambers, meaning that each M/M -chamber is *tessellated* by L/M -chambers. (We use the term “tessellation” even when the constituent tiles are not congruent to each other.)

More generally, if M' is a primitive sublattice of M , then every M/M' -chamber is tessellated by L/M' -chambers.

For $v \in L \cap \mathcal{P}_L$, we put

$$[v]^\perp := \{r \in L \mid \langle v, r \rangle = 0\}.$$

Then a point $v \in L \cap \mathcal{P}_L$ is an interior point of an L/L -chamber if and only if $[v]^\perp \cap \mathcal{R}_L = \emptyset$. Suppose that v is an interior point of an L/L -chamber N , and let

v' be another vector of $L \cap \mathcal{P}_L$. Then v' belongs to the same L/L -chamber N as v if and only if the set

$$\text{Sep}(v, v') := \{ r \in \mathcal{R}_L \mid \langle v, r \rangle > 0, \langle v', r \rangle < 0 \}$$

of *separating* (-2) -vectors is empty. The set $\text{Sep}(v, v')$ can be computed using an algorithm given in [21].

Let D be an L/M -chamber. A closed subset f of D is called a *face of codimension* μ of D if there exists a linear subspace \mathcal{P}_f of \mathcal{P}_M of codimension μ such that

- (i) $f = \mathcal{P}_f \cap D$,
- (ii) \mathcal{P}_f is disjoint from the interior of D , and
- (iii) f contains a nonempty open subset of \mathcal{P}_f .

The linear subspace \mathcal{P}_f is called the *supporting linear subspace* of the face f . A face of codimension 1 is called a *wall*.

Let $\mathcal{F}^\mu(D)$ be the set of faces of codimension μ of D . Suppose that the set $\mathcal{F}^1(D)$ of walls of D is finite. Then the set $\mathcal{F}^\mu(D)$ can be computed inductively on μ using standard linear programming methods (see [13]).

Let w be a wall of D . We say that a vector v of the dual lattice M^\vee is a *primitive defining vector* of the wall $w = \mathcal{P}_w \cap D$ of D if

- (i) $\mathcal{P}_w = (v)^\perp$,
- (ii) v is primitive in M^\vee , and
- (iii) $\langle v, x \rangle > 0$ for an (and hence every) interior point x of D .

Each wall of D has a unique primitive defining vector.

For a face f of D , let $\mathcal{D}(f)$ be the set of L/M -chambers that contain f . If w is a wall of D , there exists a unique L/M -chamber $D' \neq D$ such that $\mathcal{D}(w) = \{D, D'\}$. We call D' the L/M -chamber *adjacent to D across the wall w* .

3.2. The lattice S_X . We study the Néron–Severi lattice S_X , which is an even lattice of signature $(1, 18)$. Let $\mathcal{P}_X \subset S_X \otimes \mathbb{R}$ be the positive cone of S_X containing an ample class of X . We define the *nef-and-big cone* of X by

$$N_X := \{ x \in \mathcal{P}_X \mid \langle x, C \rangle \geq 0 \text{ for all curves } C \text{ on } X \}.$$

It is well known that N_X is an S_X/S_X -chamber. We then define

$$\mathcal{R}_X := \mathcal{R}_{S_X} = \{ r \in S_X \mid \langle r, r \rangle = -2 \},$$

and denote by $\text{Rats}(X) \subset \mathcal{R}_X$ the set of classes of smooth rational curves on X . Then N_X is determined by

$$N_X = \{ x \in \mathcal{P}_X \mid \langle x, C \rangle \geq 0 \text{ for any } C \in \text{Rats}(X) \}.$$

Remark 3.5. To simplify notation, we do not distinguish a smooth rational curve on X and its class in S_X . For example, we often write $C \in S_X$ for $C \in \text{Rats}(X)$.

We introduce a basis of the Néron–Severi lattice S_X . First, we fix a basis for the lattice M_6 defined in (1.2). Let u_1, u_2 be the basis of the hyperbolic plane U with the Gram matrix

$$\begin{pmatrix} 0 & 1 \\ 1 & 0 \end{pmatrix}.$$

For $\nu = 1, 2$, let $e_1^{(\nu)}, \dots, e_8^{(\nu)}$ be the (-2) -vectors in the two copies of $E_8(-1)$ that form the dual graph illustrated in Figure 3.1. Let $\langle -12 \rangle = \mathbb{Z} v_{12}$ be the rank-one lattice generated by a vector v_{12} satisfying $\langle v_{12}, v_{12} \rangle = -12$. Then the 19 vectors

$$(3.2) \quad u_1, u_2, e_1^{(1)}, \dots, e_8^{(1)}, e_1^{(2)}, \dots, e_8^{(2)}, v_{12}$$

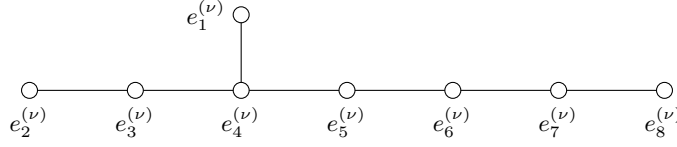
 FIGURE 3.1. Dual graph of $e_1^{(\nu)}, \dots, e_8^{(\nu)}$

L_{---}	:	[0, 0, 1, 0, 0, 0, 0, 0, 0, 0, 0, 0, 0, 0, 0, 0, 0, 0, 0]
L_{--0}	:	[0, 0, 0, 0, 0, 1, 0, 0, 0, 0, 0, 0, 0, 0, 0, 0, 0, 0, 0]
L_{--+}	:	[0, 0, 0, 0, 1, 0, 0, 0, 0, 0, 0, 0, 0, 0, 0, 0, 0, 0, 0]
L_{-0-}	:	[4, 3, -8, -5, -10, -15, -12, -9, -6, -3, -6, -4, -8, -12, -10, -8, -6, -3, -1]
L_{-0+}	:	[0, 0, 0, 1, 0, 0, 0, 0, 0, 0, 0, 0, 0, 0, 0, 0, 0, 0, 0]
L_{-+-}	:	[0, 0, 0, 0, 0, 0, 0, 0, 0, 0, 0, 0, 0, 0, 0, 0, 1, 0, 0]
L_{-+0}	:	[0, 0, 0, 0, 0, 0, 0, 0, 0, 0, 0, 0, 0, 0, 0, 0, 1, 0, 0]
L_{-++}	:	[4, 4, -8, -6, -11, -16, -13, -10, -7, -4, -9, -6, -12, -18, -15, -12, -8, -4, -1]
L_{0--}	:	[4, 4, -8, -5, -10, -15, -12, -9, -6, -3, -10, -7, -14, -20, -16, -12, -8, -4, -1]
L_{0-+}	:	[4, 4, -10, -7, -14, -20, -16, -12, -8, -4, -8, -5, -10, -15, -12, -9, -6, -3, -1]
L_{0+-}	:	[0, 0, 0, 0, 0, 0, 0, 0, 0, 0, 0, 0, 0, 0, 0, 0, 1, 0, 0]
L_{0++}	:	[0, 0, 0, 0, 0, 0, 0, 0, 1, 0, 0, 0, 0, 0, 0, 0, 0, 0, 0]
L_{+-}	:	[0, 0, 0, 0, 0, 0, 0, 0, 0, 0, 0, 1, 0, 0, 0, 0, 0, 0, 0]
L_{+-0}	:	[0, 0, 0, 0, 0, 0, 0, 0, 0, 0, 0, 1, 0, 0, 0, 0, 0, 0, 0]
L_{+--}	:	[0, 0, 0, 0, 0, 0, 0, 0, 0, 1, 0, 0, 0, 0, 0, 0, 0, 0, 0]
L_{+0-}	:	[0, 0, 0, 0, 0, 0, 0, 0, 0, 0, 1, 0, 0, 0, 0, 0, 0, 0, 0]
L_{+0+}	:	[4, 3, -6, -4, -8, -12, -10, -8, -6, -3, -8, -5, -10, -15, -12, -9, -6, -3, -1]
L_{++-}	:	[4, 4, -9, -6, -12, -18, -15, -12, -8, -4, -8, -6, -11, -16, -13, -10, -7, -4, -1]
L_{++0}	:	[0, 0, 0, 0, 0, 0, 1, 0, 0, 0, 0, 0, 0, 0, 0, 0, 0, 0, 0]
L_{+++}	:	[0, 0, 0, 0, 0, 0, 0, 1, 0, 0, 0, 0, 0, 0, 0, 0, 0, 0, 0]
M_{1--}	:	[1, 0, 0, 0, 0, 0, 0, 0, 0, -3, -2, -4, -6, -5, -4, -3, -2, 0]
M_{1-+}	:	[7, 7, -15, -10, -20, -30, -25, -19, -13, -7, -12, -8, -16, -24, -20, -15, -10, -5, -2]
M_{1+-}	:	[7, 7, -12, -8, -16, -24, -20, -15, -10, -5, -15, -10, -20, -30, -25, -19, -13, -7, -2]
M_{1++}	:	[1, 0, -3, -2, -4, -6, -5, -4, -3, -2, 0, 0, 0, 0, 0, 0, 0, 0, 0]
M_{2--}	:	[3, 3, -5, -4, -7, -10, -8, -6, -4, -2, -5, -4, -7, -10, -8, -6, -4, -2, -1]
M_{2-+}	:	[5, 5, -12, -8, -16, -24, -20, -15, -10, -5, -12, -8, -16, -24, -20, -15, -10, -5, -1]
M_{2+-}	:	[9, 7, -17, -12, -23, -34, -28, -21, -14, -7, -17, -12, -23, -34, -28, -21, -14, -7, -2]
M_{2++}	:	[-1, 1, 0, 0, 0, 0, 0, 0, 0, 0, 0, 0, 0, 0, 0, 0, 0, 0, 0]
M_{3--}	:	[12, 11, -24, -16, -32, -48, -40, -30, -20, -10, -24, -16, -32, -48, -39, -30, -20, -10, -3]
M_{3-+}	:	[0, 0, 0, 0, 0, 1, 0, 0, 0, 0, 0, 0, 0, 0, 0, 0, 0, 0, 0]
M_{3+-}	:	[0, 0, 0, 0, 0, 0, 0, 0, 0, 0, 0, 0, 0, 0, 0, 1, 0, 0, 0]
M_{3++}	:	[12, 11, -24, -16, -32, -48, -39, -30, -20, -10, -24, -16, -32, -48, -40, -30, -20, -10, -3]

 TABLE 3.1. Isometry between M_6 and S_X

form a basis of M_6 . We write vectors of M_6 as row vectors of length 19 with respect to this basis. Next, we choose an isometry $M_6 \cong S_X$ as given in Table 3.1, and express vectors of S_X using the same row vector representation.

Remark 3.6. Under this isomorphism $M_6 \cong S_X$, the vector $u_1 \in M_6$ corresponds to the class of a fiber of the elliptic fibration $\phi: X \rightarrow \mathbb{P}^1$ defined by the configuration in Figure 2.2, the vector $u_2 \in M_6$ corresponds to the class $z + u_1$, where z is the zero section M_{2++} of ϕ , and the vectors $e_i^{(\nu)}$ correspond to the reduced parts C of the irreducible components of the two reducible fibers of ϕ satisfying $\langle z, C \rangle = 0$. The sign of v_{12} is chosen so that $\langle v_{12}, C \rangle \geq 0$ holds for all 32 smooth rational curves C in Lemmas 2.1 and 2.2.

Finally, let

$$q_{S_X} : S_X^\vee / S_X \rightarrow \mathbb{Q}/2\mathbb{Z}$$

denote the discriminant form of the even lattice S_X (see [18]), where S_X^\vee is the dual lattice of S_X . The discriminant group S_X^\vee/S_X is a cyclic group of order 12 generated by $v_{12}/12 \bmod S_X$, and satisfies $q_{S_X}(v_{12}/12) = -1/12 \bmod 2\mathbb{Z}$.

Let \mathcal{L}_{32} be the set of 32 smooth rational curves in Lemmas 2.1 and 2.2. The two sets in these two lemmas are identified by the bijection established in the proof of Proposition 2.3.

Let $h_8 \in S_X$ be the class of a hyperplane section of the projective model $\overline{X}_s \subset \mathbb{P}^6$ of X defined by (2.1). Since \overline{X}_s is a $(2, 2, 2)$ -complete intersection in the hyperplane of \mathbb{P}^6 defined by the first equation of (2.1), it follows that h_8 is a nef vector of degree 8. Examining the intersection numbers with the 32 smooth rational curves in \mathcal{L}_{32} , we find

$$h_8 = [24, 22, -48, -32, -64, -95, -78, -59, -40, -20, -48, -32, -64, -95, -78, -59, -40, -20, -6].$$

Similarly, the class h_4 of the hyperplane section of the quartic surface $Y_{t(s)} \subset \mathbb{P}^3$ is given by

$$h_4 = [28, 26, -56, -38, -76, -112, -92, -70, -48, -24, -56, -38, -76, -112, -92, -70, -48, -24, -7].$$

Recall that $\text{Sing } \overline{X}_s$ consists of 12 ordinary nodes $p_{\gamma_1\gamma_2\gamma_3}$, where one of $\gamma_1, \gamma_2, \gamma_3$ is 0 and the other two are in $\{+, -\}$. Thus, we obtain

$$\{r \in \text{Rats}(X) \mid \langle r, h_8 \rangle = 0\} = \{L_{\gamma_1\gamma_2\gamma_3} \mid \text{one of } \gamma_1, \gamma_2, \gamma_3 \text{ is } 0\} \subset \mathcal{L}_{32}.$$

It follows that N_X is the S_X/S_X -chamber containing h_8 and contained in the region of \mathcal{P}_X defined by

$$(3.3) \quad \langle x, C \rangle \geq 0 \text{ for all } C = L_{\gamma_1\gamma_2\gamma_3} \text{ with one of } \gamma_1, \gamma_2, \gamma_3 \text{ being } 0.$$

Now we define

$$a_{32} := [70, 63, -140, -94, -187, -279, -230, -174, -117, -59, -140, -94, -187, -279, -230, -174, -117, -59, -17].$$

We verify that

$$\langle a_{32}, a_{32} \rangle = 32.$$

The intersection numbers of a_{32} with elements of \mathcal{L}_{32} are

$$\langle C, a_{32} \rangle = \begin{cases} 1 & \text{if } C = L_{\gamma_1\gamma_2\gamma_3} \text{ or } C \in \{M_{2-+}, M_{2+-}, M_{3--}, M_{3++}\}, \\ 4 & \text{if } C = M_{1\alpha\beta}, \\ 7 & \text{if } C \in \{M_{2--}, M_{2++}, M_{3+-}, M_{3-+}\}. \end{cases}$$

Since a_{32} lies in the region defined by (3.3), and we confirm by direct computation that

$$[a_{32}]^\perp \cap \mathcal{R}_X = \emptyset, \quad \text{Sep}(h_8, a_{32}) = \emptyset,$$

it follows that a_{32} is in the interior of N_X , and hence a_{32} is ample.

Thanks to the ample class a_{32} , we can now utilize various tools and methods explained in [23]. For example, we can determine whether a given (-2) -vector $r \in \mathcal{R}_X$ belongs to $\text{Rats}(X)$ or not by the criterion in Section 3.4 of [23]. The numbers of smooth rational curves C on X of low degree $\langle C, a_{32} \rangle$ are given in Table 3.2.

$\langle C, a_{32} \rangle$	1	2	3	4	5	6	7	8	9	10	11	12	13	14	15	16	17
number	24	0	0	4	0	0	8	0	0	16	32	0	32	16	0	80	192
$\langle C, a_{32} \rangle$	18	19	20	21	22	23	24	25	26	27	28	29					
number	0	136	96	0	248	384	0	416	320	304	560	816					

TABLE 3.2. Numbers of smooth rational curves of low degrees

Remark 3.7. We found the ample class a_{32} by random search for ample classes of X . This class plays an important role in specifying the Conway chamber $\mathbf{C}(\mathbf{w}_0)$ and the L_{26}/S_X -chamber $D_0 = \mathcal{P}_X \cap \mathbf{C}(\mathbf{w}_0)$ in Borchards' method. See Section 3.5.

3.3. Embedding $\text{Aut}(X)$ into $\text{O}(S_X, \mathcal{P}_X)$. Recall that q_{S_X} is the discriminant form of the even lattice S_X . Let

$$\text{O}(q_{S_X}) \cong (\mathbb{Z}/12\mathbb{Z})^\times = \{\pm 1, \pm 5\}$$

denote the automorphism group of the finite quadratic form q_{S_X} . We have a natural homomorphism

$$\eta: \text{O}(S_X) \rightarrow \text{O}(q_{S_X}).$$

By Theorem 5.4 and Example 5.5 of [23], we obtain the following result:

Proposition 3.8. *The natural homomorphism $\text{Aut}(X) \rightarrow \text{O}(S_X, \mathcal{P}_X)$ is injective, and its image consists precisely of isometries $g \in \text{O}(S_X, \mathcal{P}_X)$ satisfying $N_X^g = N_X$ and $\eta(g) \in \{\pm 1\}$. \square*

From this point onward, we will regard $\text{Aut}(X)$ as a subgroup of $\text{O}(S_X, \mathcal{P}_X)$. An isometry $g \in \text{O}(S_X, \mathcal{P}_X)$ satisfies the condition $N_X^g = N_X$ if and only if the set $\text{Sep}(a_{32}, a_{32}^g)$ of (-2) -vectors separating a_{32} and a_{32}^g is empty. Thus, for $g \in \text{O}(S_X, \mathcal{P}_X)$, we have

$$g \in \text{Aut}(X) \iff (\text{Sep}(a_{32}, a_{32}^g) = \emptyset \text{ and } \eta(g) \in \{\pm 1\}).$$

3.4. The finite subgroup $\text{Aut}(X, \mathcal{L}_{32})$. Let $\text{O}(S_X, \mathcal{L}_{32})$ denote the group of permutations of the set \mathcal{L}_{32} of 32 smooth rational curves in Lemma 2.1 that preserve intersection numbers. Since the classes of curves in \mathcal{L}_{32} generate S_X , we can naturally embed $\text{O}(S_X, \mathcal{L}_{32})$ into $\text{O}(S_X)$. Since the sum s of elements of \mathcal{L}_{32} satisfies $\langle s, s \rangle > 0$ and $\langle s, a_{32} \rangle > 0$, it follows that $\text{O}(S_X, \mathcal{L}_{32})$ is contained in $\text{O}(S_X, \mathcal{P}_X)$. We put

$$\text{Aut}(X, \mathcal{L}_{32}) := \text{O}(S_X, \mathcal{L}_{32}) \cap \text{Aut}(X),$$

where the intersection is taken in $\text{O}(S_X, \mathcal{P}_X)$. In this section, we present various facts about this finite automorphism group $\text{Aut}(X, \mathcal{L}_{32})$.

(a) The size of the group $\text{O}(S_X, \mathcal{L}_{32})$ is 96. Every element g of $\text{O}(S_X, \mathcal{L}_{32})$ satisfies $\text{Sep}(a_{32}, a_{32}^g) = \emptyset$, which implies

$$\text{Aut}(X, \mathcal{L}_{32}) = \{g \in \text{O}(S_X, \mathcal{L}_{32}) \mid \eta(g) \in \{\pm 1\}\}.$$

Let $\mu \in \text{O}(S_X, \mathcal{L}_{32})$ be the involution given by

$$L_{\gamma_1 \gamma_2 \gamma_3}^\mu = L_{\gamma_1 \gamma_2 \gamma_3}, \quad M_{k\alpha\beta}^\mu = M_{k(-\alpha)\beta}.$$

Then we have $\eta(\mu) = 5 \in \text{O}(q_{S_X})$, and

$$\text{O}(S_X, \mathcal{L}_{32}) = \langle \mu \rangle \times \text{Aut}(X, \mathcal{L}_{32}).$$

In particular, the size of the group $\text{Aut}(X, \mathcal{L}_{32})$ is 48. This group $\text{Aut}(X, \mathcal{L}_{32})$ acts on the L -cube (Figure 2.1) faithfully. We put the L -cube in \mathbb{R}^3 by

$$L_{\gamma_1\gamma_2\gamma_3} \mapsto \gamma_1\mathbf{e}_1 + \gamma_2\mathbf{e}_2 + \gamma_3\mathbf{e}_3,$$

where $\mathbf{e}_1, \mathbf{e}_2, \mathbf{e}_3$ are the standard ortho-normal basis of \mathbb{R}^3 . This gives a representation

$$(3.4) \quad \rho_L: \text{Aut}(X, \mathcal{L}_{32}) \hookrightarrow \text{O}(3).$$

Then the morphism $\eta: \text{Aut}(X, \mathcal{L}_{32}) \rightarrow \{\pm 1\} \subset \text{O}(q_{S_X})$ is given by

$$(3.5) \quad \eta(g) = 1 \iff \rho_L(g) \in \text{SO}(3).$$

(b) The action of $\text{Aut}(X, \mathcal{L}_{32})$ decomposes \mathcal{L}_{32} into three orbits

$$\{L_{\gamma_1\gamma_2\gamma_3} \mid \text{none of } \gamma_1, \gamma_2, \gamma_3 \text{ is zero}\}, \quad \{L_{\gamma_1\gamma_2\gamma_3} \mid \text{one of } \gamma_1, \gamma_2, \gamma_3 \text{ is zero}\}, \quad \{M_{k\alpha\beta}\}.$$

These orbits have sizes 8, 12, 12, respectively.

(c) By the natural embedding $\mathcal{L}_{32} \hookrightarrow S_X$, we have

$$\mathcal{L}_{32} = \{r \in \text{Rats}(X) \mid \langle r, h_8 \rangle \leq 2\}.$$

Hence the group

$$\text{Aut}(X, h_8) := \{g \in \text{Aut}(X) \mid h_8^g = h_8\}$$

of projective automorphisms of the $(2, 2, 2)$ -complete intersection $\overline{X}_s \subset \mathbb{P}^5$ given by (2.1) is contained in $\text{Aut}(X, \mathcal{L}_{32})$. In fact, by computing the order of $\text{Aut}(X, h_8)$, we can show that $\text{Aut}(X, h_8) = \text{Aut}(X, \mathcal{L}_{32})$.

(d) There exists an involution $\varepsilon \in \text{Aut}(X, \mathcal{L}_{32})$ defined by

$$L_{\gamma_1\gamma_2\gamma_3}^\varepsilon = L_{(-\gamma_1)(-\gamma_2)(-\gamma_3)}, \quad M_{k\alpha\beta}^\varepsilon = M_{k(-\alpha)\beta}.$$

The center of $\text{Aut}(X, \mathcal{L}_{32})$ is equal to $\langle \varepsilon \rangle$. Let $\Sigma \subset \text{Aut}(X, \mathcal{L}_{32})$ be the subgroup consisting of all $g \in \text{Aut}(X, \mathcal{L}_{32})$ such that

$$\{P_1^g, P_2^g, P_3^g, P_4^g\} = \{P_1, P_2, P_3, P_4\},$$

where $P_1 = L_{+-+}$, $P_2 = L_{-++}$, $P_3 = L_{---}$, $P_4 = L_{++-}$ are the vertices of a regular tetrahedron in the cube in Figure 2.3. Then we have

$$\text{Aut}(X, \mathcal{L}_{32}) = \langle \varepsilon \rangle \times \Sigma,$$

and Σ is isomorphic to the symmetric group \mathfrak{S}_4 . The involution ε is induced by the Enriques involution

$$(3.6) \quad x_1 \leftrightarrow 1/x_1, \quad x_2 \leftrightarrow 1/x_2, \quad x_3 \leftrightarrow 1/x_3, \quad x_4 \leftrightarrow 1/x_4$$

of the quartic surface Y_t . This Enriques involution and the associated Enriques surface were studied by Mukai and Ohashi [17]. The action of $\Sigma \cong \mathfrak{S}_4$ on Y_t is induced by the permutations of the coordinates $(x_1 : x_2 : x_3 : x_4)$ of \mathbb{P}^3 .

(e) We have an isomorphism

$$\text{Aut}(X, \mathcal{L}_{32}) = \langle \varepsilon \rangle \times \Sigma \cong (\mathbb{Z}/2\mathbb{Z})^3 \rtimes \mathfrak{S}_3.$$

This isomorphism arises from the action of $\text{Aut}(X, \mathcal{L}_{32})$ on the affine Fermi surface X_s° in \mathbb{A}^3 via the three involutions $\xi_i \leftrightarrow 1/\xi_i$ and the permutations of the coordinates (ξ_1, ξ_2, ξ_3) of \mathbb{A}^3 .

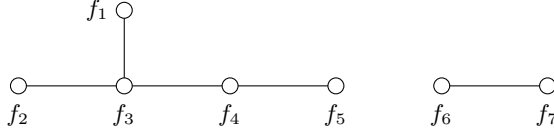
FIGURE 3.2. Basis of R

3.5. Borcherds' method. Let L_{26} be an even unimodular lattice of rank 26 and signature $(1, 25)$. Note that such a lattice is unique up to isomorphism. We embed S_X into L_{26} primitively using the technique of discriminant forms [18] as follows. Recall that the discriminant group S_X^\vee/S_X is a cyclic group of order 12 generated by γ_S , where $\gamma_S := v_{12}/12 \bmod S_X$, and the discriminant form q_{S_X} is given by $q_{S_X}(\gamma_S) = -1/12 \bmod 2\mathbb{Z}$. Let R be the *negative-definite* root lattice of type $D_5 + A_2$. We fix a basis f_1, \dots, f_7 of R as is shown in the Dynkin diagram in Figure 3.2. Then R^\vee/R is a cyclic group of order 12 generated by $\gamma_R := \tilde{\gamma}_R \bmod R$, where

$$\tilde{\gamma}_R := \frac{1}{4}(3f_1 + f_2 + 2f_3 + 2f_5) + \frac{1}{3}(f_6 + 2f_7) \in R^\vee,$$

and we have $q_R(\gamma_R) = 1/12 \bmod 2\mathbb{Z}$, where $q_R: R^\vee/R \rightarrow \mathbb{Q}/2\mathbb{Z}$ is the discriminant form of R . Hence $\gamma_S \mapsto -\gamma_R$ gives an anti-isomorphism $q_{S_X} \cong -q_R$. The graph of this anti-isomorphism in $(S_X^\vee/S_X) \times (R^\vee/R)$ yields an even unimodular overlattice L_{26} of the orthogonal direct sum $S_X \oplus R$. Indeed, L_{26} is generated in $S_X^\vee \oplus R^\vee$ over $S_X \oplus R$ by the vector $v_{12}/12 + \tilde{\gamma}_R$. From this point forward, we regard S_X and R as primitive sublattices of L_{26} via this embedding $(S_X \oplus R) \hookrightarrow L_{26}$.

Let $\mathcal{P}_{26} \subset L_{26} \otimes \mathbb{R}$ denote the positive cone of L_{26} containing the positive cone \mathcal{P}_X of S_X . We refer to an L_{26}/L_{26} -chamber as a *Conway chamber*, as its structure was determined by Conway [10]. The tessellation of \mathcal{P}_{26} by Conway chambers induces a tessellation of \mathcal{P}_X by L_{26}/S_X -chambers. Each S_X/S_X -chamber, including the nef-and-big cone N_X , is also tessellated by L_{26}/S_X -chambers. For every $g \in \text{Aut}(X)$, its action $\eta(g) \in O(q_{S_X})$ on the discriminant form q_{S_X} is in $\{\pm 1\}$, and hence the action of g on S_X extends to an action on L_{26} . Consequently, the action of $\text{Aut}(X)$ on N_X preserves the tessellation of N_X by L_{26}/S_X -chambers. We put

$$(3.7) \quad V_X := \text{the set of } L_{26}/S_X\text{-chambers contained in } N_X.$$

Our goal is to analyze the action of $\text{Aut}(X)$ on N_X via the the action of $\text{Aut}(X)$ on V_X .

Definition 3.9. Let D be an element of V_X , and f a face of D . We say that f is *inner* if the set $\mathcal{D}(f)$ of all L_{26}/S_X -chambers containing f is a subset of V_X . Otherwise, we say that f is *outer*.

Suppose that $w = D \cap (v)^\perp$ is a wall of $D \in V_X$, where $v \in S_X^\vee$ is the primitive defining vector (see Section 3.1). Then w is inner if and only if the L_{26}/S_X -chamber adjacent to D across the wall w belongs to V_X . It is also obvious that w is outer if and only if v is equal to αC for some $\alpha \in \mathbb{Q}_{>0}$ and $C \in \text{Rats}(X)$.

We put

$$\mathcal{R}_{26} := \{r \in L_{26} \mid \langle r, r \rangle = -2\}.$$

Recall that $a_{32} \in S_X$ is an ample class with $\langle a_{32}, a_{32} \rangle = 32$, which we regard as a vector of L_{26} by the embedding $S_X \hookrightarrow L_{26}$.

Proposition 3.10. *The ample class a_{32} is an interior point of an L_{26}/S_X -chamber.*

Proof. By direct computation, we verify that the set $\{r \in \mathcal{R}_{26} \mid \langle r, a_{32} \rangle = 0\}$ is equal to the set

$$\{r \in \mathcal{R}_{26} \mid \langle r, v \rangle = 0 \text{ for all } v \in S_X\} = \{r \in \mathcal{R}_{26} \mid r \in R\} \cong \{r \in R \mid \langle r, r \rangle = -2\}$$

of roots of R . This implies that, if $r \in \mathcal{R}_{26}$ satisfies $\langle r, a_{32} \rangle = 0$, then we have $\mathcal{P}_X \subset (r)^\perp$ in \mathcal{P}_{26} . \square

Definition 3.11. A vector \mathbf{w} of L_{26} is called a *Weyl vector* if

- (i) \mathbf{w} is non-zero, primitive in L_{26} , and of square-norm 0,
- (ii) \mathbf{w} is contained in the closure of \mathcal{P}_{26} in $L_{26} \otimes \mathbb{R}$, and
- (iii) the negative-definite even unimodular lattice $[\mathbb{Z}\mathbf{w}]^\perp/\mathbb{Z}\mathbf{w}$ of rank 24 contains no vectors of square-norm -2 .

For a Weyl vector \mathbf{w} , we call a (-2) -vector $r \in \mathcal{R}_{26}$ of L_{26} a *Leech root of \mathbf{w}* if $\langle r, \mathbf{w} \rangle = 1$ holds.

Conway [10] proved that the mapping $\mathbf{w} \mapsto \mathbf{C}(\mathbf{w})$, where

$$\mathbf{C}(\mathbf{w}) := \{x \in \mathcal{P}_{26} \mid \langle x, r \rangle \geq 0 \text{ for all Leech roots } r \text{ of } \mathbf{w}\},$$

is a bijection from the set of Weyl vectors to the set of Conway chambers. Moreover, he showed that $\mathbf{C}(\mathbf{w}) \cap (r)^\perp$ is a wall of the Conway chamber $\mathbf{C}(\mathbf{w})$ for each Leech root r of \mathbf{w} ; that is, $\mathbf{C}(\mathbf{w}) \cap (r)^\perp$ contains a nonempty open subset of $(r)^\perp$ for every Leech root r of \mathbf{w} .

We put

$$a_R := [-5, -5, -9, -7, -4, -1, -1] \in R,$$

which is a vector of R satisfying $\langle a_R, f_j \rangle = 1$ for $j = 1, \dots, 7$. Since $\langle a_R, a_R \rangle = -32$, the vector

$$\mathbf{w}_0 := a_{32} + a_R$$

of L_{26} is of square-norm 0. We verify that \mathbf{w}_0 is a primitive vector in L_{26} , and that the negative-definite even unimodular lattice $[\mathbb{Z}\mathbf{w}_0]^\perp/\mathbb{Z}\mathbf{w}_0$ has no (-2) -vectors. Thus, we confirm that \mathbf{w}_0 is a Weyl vector.

Proposition 3.12. *The closed subset*

$$D_0 := \mathcal{P}_X \cap \mathbf{C}(\mathbf{w}_0)$$

of \mathcal{P}_X is the L_{26}/S_X -chamber containing a_{32} in its interior.

Proof. We have already proved that a_{32} is an interior point of a certain L_{26}/S_X -chamber in \mathcal{P}_X . Thus, it suffices to show that a_{32} lies in $\mathbf{C}(\mathbf{w}_0)$. Since $\mathbf{w}_0 \in L_{26}$ is a primitive vector with square-norm 0 and we have $L_{26} = L_{26}^\vee$, there exists a vector $\mathbf{w}'_0 \in L_{26}$ such that $\langle \mathbf{w}'_0, \mathbf{w}'_0 \rangle = 0$ and $\langle \mathbf{w}_0, \mathbf{w}'_0 \rangle = 1$. Then \mathbf{w}_0 and \mathbf{w}'_0 span a hyperbolic plane $U_{\mathbf{w}}$ in L_{26} , and its orthogonal complement $\Lambda := U_{\mathbf{w}}^\perp$ is isomorphic to the negative-definite Leech lattice $[\mathbb{Z}\mathbf{w}_0]^\perp/\mathbb{Z}\mathbf{w}_0$. Thus we can write $L_{26} = U_{\mathbf{w}} \oplus \Lambda$. The Leech roots with respect to \mathbf{w}_0 are given by

$$r_\lambda := \left(\frac{-2 - \langle \lambda, \lambda \rangle}{2} \right) \mathbf{w}_0 + \mathbf{w}'_0 + \lambda, \quad \text{where } \lambda \in \Lambda.$$

We put

$$\mathbf{a}_L := 2\mathbf{w}_0 + \mathbf{w}'_0.$$

Since $\langle \mathbf{a}_L, \mathbf{a}_L \rangle > 0$ and $\langle \mathbf{a}_L, r_\lambda \rangle > 0$ for any $\lambda \in \Lambda$, it follows that \mathbf{a}_L is an interior point of $\mathbf{C}(\mathbf{w}_0)$. Then we confirm that the set

$$\text{Sep}(\mathbf{a}_L, a_{32}) := \{ r \in \mathcal{R}_{26} \mid \langle \mathbf{a}_L, r \rangle > 0, \langle a_{32}, r \rangle < 0 \}$$

of (-2) -vectors in L_{26} separating \mathbf{a}_L and a_{32} is empty. Therefore a_{32} belongs to the Conway chamber $\mathbf{C}(\mathbf{w}_0)$. \square

Remark 3.13. The order of the Weyl group $W(R)$ of the root lattice R of type $D_5 + A_2$ is 11,520. Consequently, there exist exactly 11,520 Conway chambers \mathbf{C}' such that $D_0 = \mathcal{P}_X \cap \mathbf{C}'$.

Starting from D_0 , we execute the algorithm described in Section 5 of [23], and obtain the orbit decomposition of V_X under the action of $\text{Aut}(X)$, where V_X is the set of L_{26}/S_X -chambers contained in N_X (see (3.7)). As a result, we obtain the following facts.

(1) The L_{26}/S_X -chamber D_0 has 80 walls. Let w_1, \dots, w_{80} be the walls of D_0 , and let $v_i \in S_X^\vee$ be the primitive defining vector of w_i . (See Section 3.1 for the definition of the primitive defining vector.) The values

$$n(w_i) := \langle v_i, v_i \rangle \quad \text{and} \quad a(w_i) := \langle a_{32}, v_i \rangle$$

for each wall w_i are given in Table 3.3.

(2) The group

$$\text{O}(S_X, D_0) := \{ g \in \text{O}(S_X, \mathcal{P}_X) \mid D_0^g = D_0 \}$$

is of order 32, and is equal to

$$\text{O}(S_X, a_{32}) := \{ g \in \text{O}(S_X, \mathcal{P}_X) \mid a_{32}^g = a_{32} \}.$$

Its subgroup

$$\text{Aut}(X, D_0) := \text{Aut}(X) \cap \text{O}(S_X, D_0) = \{ g \in \text{O}(S_X, D_0) \mid \eta(g) \in \{\pm 1\} \}$$

is isomorphic to the dihedral group of order 16. We see that $\text{Aut}(X, D_0)$ is equal to the group

$$\text{Aut}(X, a_{32}) := \{ g \in \text{Aut}(X) \mid a_{32}^g = a_{32} \}$$

of the projective model of X defined by a_{32} . Table 3.3 shows the orbit decomposition of the set of walls of D_0 by the action of $\text{Aut}(X, D_0)$. In Table 3.4, the primitive defining vector of a representative wall of each orbit o_i is given. The orbits o_5 and o_6 merge into a single orbit under the action of $\text{O}(S_X, D_0)$, as do the orbits o_9 and o_{10} . Meanwhile, each of the other six orbits remains to be an orbit under $\text{O}(S_X, D_0)$.

(3) Let w be a wall of D_0 . If $w \in o_1 \cup o_2$, then w is an outer wall. Suppose instead that $w \in o_3 \cup \dots \cup o_{10}$. Then the L_{26}/S_X -chamber adjacent to D_0 across the wall w is congruent to D_0 by the action of $\text{Aut}(X)$. In other words, the set

$$(3.8) \quad \text{Adj}(w) := \left\{ g \in \text{Aut}(X) \mid \begin{array}{l} D_0^g \text{ is the } L_{26}/S_X\text{-chamber adjacent to} \\ D_0 \text{ across the wall } w \end{array} \right\}$$

is nonempty. Thus, by Proposition 4.1 of [9] (see also Proposition 5.1 of [23]), we obtain the following result.

3.6. Proof of Corollary 1.3. Now we prove Corollary 1.3. Let C be an arbitrary element of $\text{Rats}(X)$, and set $r := C$. Then $N_X \cap (r)^\perp$ contains a nonempty open subset of $(r)^\perp$, and hence there exists an L_{26}/S_X -chamber $D \in V_X$ such that $D \cap (r)^\perp$ is a wall of D . By Proposition 3.14, there exists an automorphism $g \in \text{Aut}(X)$ such that $D^g = D_0$. Then $D_0 \cap (r^g)^\perp$ is an outer wall of D_0 . From (3.9) and (3.10), there exists an automorphism $g' \in \text{Aut}(X, D_0)$ such that

$$r^{gg'} = L_{0++} \quad \text{or} \quad r^{gg'} = L_{+0+}.$$

By Fact (b) in Section 3.4, there exists an automorphism $g'' \in \text{Aut}(X, \mathcal{L}_{32})$ such that $r^{gg'g''} = L_{0++}$. Consequently, $\text{Rats}(X)$ forms a single orbit under the action of $\text{Aut}(X)$. \square

4. GEOMETRIC DESCRIPTION OF GENERATORS

4.1. Goal. In Proposition 3.14, we provided a finite generating set of $\text{Aut}(X)$ in lattice-theoretic terms; that is, we presented a finite set of isometries of S_X that generate the subgroup $\text{Aut}(X)$ of $\text{O}(S_X, \mathcal{P}_X)$. In this section, we describe these generators in terms of the geometry of X .

Definition 4.1. Let o_ν be an orbit of inner walls of D_0 under the action of $\text{Aut}(X, D_0)$. We say that $g \in \text{Aut}(X)$ is a *generator associated with o_ν* if $g \in \text{Adj}(w)$ for a wall $w \in o_\nu$, where $\text{Adj}(w)$ is defined by (3.8).

The geometric origin of the finite subgroup $\text{Aut}(X, \mathcal{L}_{32})$ of order 48 is well understood. (See Section 3.4.) The intersection $\text{Aut}(X, D_0) \cap \text{Aut}(X, \mathcal{L}_{32})$ is of order 8, and an element g of $\text{Aut}(X, \mathcal{L}_{32})$ belongs to $\text{Aut}(X, D_0)$ if and only if its action $\rho_L(g)$ on the L -cube (see (3.4) and (3.5)) preserves the set $\{L_{0\pm\pm}\}$ of four vertices and satisfies $\det(\rho_L(g)) = 1$.

Our goal is to provide a geometric description of

- (a) an automorphism $g^{[0]}$ in $\text{Aut}(X, D_0)$ not belonging to $\text{Aut}(X, \mathcal{L}_{32})$, and
- (b) generators $g^{[3]}, \dots, g^{[10]}$ associated with the orbits o_3, \dots, o_{10} of inner walls.

Then $\text{Aut}(X)$ is generated by $\text{Aut}(X, \mathcal{L}_{32})$ along with $g^{[0]}, g^{[3]}, \dots, g^{[10]}$.

4.2. Strategy. Let $\phi: X \rightarrow \mathbb{P}^1$ be a Jacobian fibration with the zero section $z \in \text{Rats}(X)$. Let E_ϕ be the generic fiber of ϕ , which is an elliptic curve defined over the function field of \mathbb{P}^1 with the zero element z . We regard the Mordell-Weil group $\text{MW}(\phi)$ of ϕ as a subgroup of $\text{Aut}(X)$ by identifying a rational point $s \in \text{MW}(\phi)$ of E_ϕ with the translation $x \mapsto x +_E s$ of E_ϕ by s , where $+_E$ is the addition on the elliptic curve E_ϕ . We also have an involution $\iota(\phi) \in \text{Aut}(X)$ coming from the inversion $x \mapsto z -_E x$ of E_ϕ .

Suppose that we have a configuration

$$\Theta = \{C_0, \dots, C_n\}$$

of smooth rational curves $C_i \in \text{Rats}(X)$ whose dual graph is a *connected affine* Dynkin diagram of type A_ℓ, D_m , or E_n . Then Θ yields an elliptic fibration

$$\phi_\Theta: X \rightarrow \mathbb{P}^1$$

such that Θ is the set of irreducible components of a reducible fiber

$$\phi_\Theta^{-1}(p) = \sum a_i C_i,$$

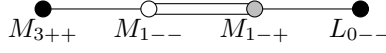
FIGURE 4.1. Configuration for $\phi^{[0]}$

where the coefficients $a_i \in \mathbb{Z}_{>0}$ are determined by the ADE-type of Θ . (See Table 4.1 of [23].) A smooth rational curve C is a section of ϕ_Θ if and only if

$$\sum a_i \langle C_i, C \rangle = 1.$$

Hence, by choosing an appropriate configuration of elements of $\text{Rats}(X)$, we can determine a Jacobian fibration of X along with some elements of its Mordell–Weil group. The procedure for computing the Mordell–Weil group and its action on S_X is explained in [23]. The action of the inversion $\iota(\phi)$ on S_X is also easily computed.

In the following, we present many dual graphs of such configurations. In each graph, we depict sections by black nodes, elements of Θ disjoint from the zero section z by white nodes, and the element of Θ intersecting z by a gray node. Hence the white nodes form a connected *ordinary* Dynkin diagram, and the black node connected to the gray node is the zero section z .

4.3. The group $\text{Aut}(X, D_0)$. The configuration \mathcal{L}_{32} contains a sub-configuration depicted in Figure 4.1. The white nodes form a Dynkin diagram of type A_1 , and, together with the gray node, they form an affine Dynkin diagram of type A_1 . Therefore we obtain a Jacobian fibration

$$\phi^{[0]}: X \rightarrow \mathbb{P}^1$$

with the zero section $z := L_{0--}$. This Jacobian fibration has four reducible fibers of type $A_7 + A_7 + A_1 + A_1$. The Mordell–Weil group $\text{MW}(\phi^{[0]})$ of $\phi^{[0]}$ is isomorphic to $\mathbb{Z} \oplus \mathbb{Z}/4\mathbb{Z}$. The section $s := M_{3++}$ generates the free part of $\text{MW}(\phi^{[0]})$. Then the product

$$g^{[0]} := \iota(\phi^{[0]}) \cdot s$$

is an involution belonging to $\text{Aut}(X, D_0) \setminus (\text{Aut}(X, D_0) \cap \text{Aut}(X, \mathcal{L}_{32}))$.

Remark 4.2. The Jacobian fibration $\phi^{[0]}$ has a beautiful property with respect to \mathcal{L}_{32} . Since the reducible fibers of $\phi^{[0]}$ is of type $A_7 + A_7 + A_1 + A_1$, there exist 20 smooth rational curves contained in fibers of $\phi^{[0]}$. All these 20 curves belong to \mathcal{L}_{32} . The other 12 smooth rational curves in \mathcal{L}_{32} are sections of $\phi^{[0]}$. The section $t = L_{0+-}$ is a torsion section of order 4, and the following sections belong to \mathcal{L}_{32} :

$$as +_E bt \quad (a = \{-1, 0, 1\}, \quad b \in \{0, 1, 2, 3\}), \quad \text{where } s := M_{3++}.$$

4.4. A generator associated with o_3 . Let $g^{[3]}$ be the involution in $\text{Aut}(X, \mathcal{L}_{32})$ whose action on the L -cube makes the exchanges

$$L_{+++} \longleftrightarrow L_{--+}, \quad L_{++-} \longleftrightarrow L_{---},$$

and fixes the other four vertexes $L_{+-\pm}$ and $L_{-+\pm}$. Then $g^{[3]}$ is a generator associated with the orbit o_3 .

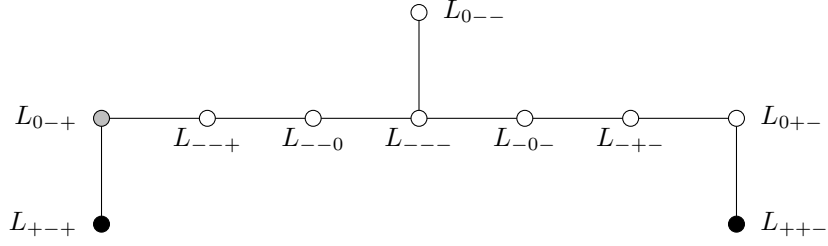
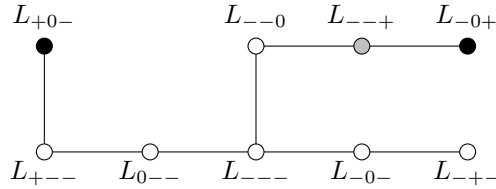
 FIGURE 4.2. Configuration for $\phi^{[4]}$

 FIGURE 4.3. Configuration for $\phi^{[5]}$

4.5. **A generator associated with o_4 .** The configuration \mathcal{L}_{32} contains a sub-configuration depicted in Figure 4.2. The seven white nodes form a Dynkin diagram of type E_7 , and, together with the gray node, they form an affine Dynkin diagram of type E_7 . Therefore we obtain a Jacobian fibration

$$\phi^{[4]}: X \rightarrow \mathbb{P}^1$$

with the zero section L_{+--+} . This Jacobian fibration has three reducible fibers of type $E_7 + D_5 + A_5$. The Mordell–Weil group of $\phi^{[4]}$ is isomorphic to $\mathbb{Z}/2\mathbb{Z}$ and its non-trivial element is the section L_{+--+} . Let

$$g^{[4]}: X \rightarrow X$$

be the translation by the non-trivial torsion section L_{+--+} . Then $g^{[4]}$ is a generator associated with the orbit o_4 .

4.6. **Generators associated with o_5 and o_6 .** The configuration \mathcal{L}_{32} contains a sub-configuration depicted in Figure 4.3. The seven white and gray nodes form an affine Dynkin diagram of type E_6 , and hence we obtain a Jacobian fibration

$$\phi^{[5]}: X \rightarrow \mathbb{P}^1$$

with the zero section L_{-0+} . This Jacobian fibration $\phi^{[5]}$ has four reducible fibers of type $E_6 + E_6 + A_2 + A_2$. The Mordell–Weil group of $\phi^{[5]}$ is isomorphic to $\mathbb{Z} \oplus \mathbb{Z}/3\mathbb{Z}$, and the section L_{+0-} is of order ∞ . Let

$$g^{[5]}: X \rightarrow X$$

be the automorphism obtained by the translation by this section L_{+0-} . Then $g^{[5]}$ is a generator associated with the orbit o_5 . We put

$$g^{[6]} := (g^{[5]})^{-1}.$$

Then $g^{[6]}$ is a generator associated with the orbit o_6 .

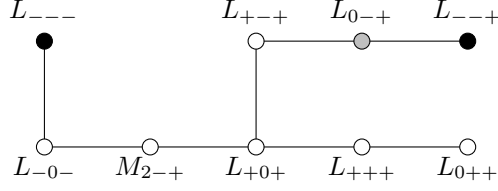
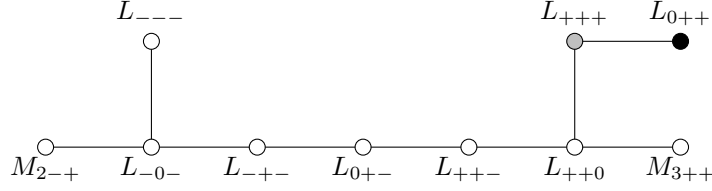
FIGURE 4.4. Configuration for $\phi^{[7]}$ FIGURE 4.5. Configuration for $\phi^{[8]}$

4.7. **A generator associated with o_7 .** We consider the Jacobian fibration

$$\phi^{[7]}: X \rightarrow \mathbb{P}^1$$

associated with the configuration whose dual graph is in Figure 4.4. The zero section of $\phi^{[7]}$ is L_{--+} . This Jacobian fibration $\phi^{[7]}$ has four reducible fibers of type $E_6 + E_6 + A_2 + A_2$. The Mordell–Weil group of $\phi^{[7]}$ is isomorphic to $\mathbb{Z} \oplus \mathbb{Z}/3\mathbb{Z}$, and the section L_{---} is of order ∞ . The automorphism $g^{[7]}: X \rightarrow X$ obtained by the translation by this section L_{---} is a generator associated with the orbit o_7 .

4.8. **A generator associated with o_8 .** We consider the Jacobian fibration

$$\phi^{[8]}: X \rightarrow \mathbb{P}^1$$

associated with the configuration whose dual graph is in Figure 4.5. The zero section of $\phi^{[8]}$ is L_{0++} . This Jacobian fibration has two reducible fibers of type $D_8 + D_8$. The Mordell–Weil group of $\phi^{[8]}$ is isomorphic to $\mathbb{Z} \oplus \mathbb{Z}/2\mathbb{Z}$. The automorphism $g^{[8]}: X \rightarrow X$ obtained by the inversion $\iota(\phi^{[8]})$ of the generic fiber is a generator associated with the orbit o_8 .

4.9. **Generators associated with o_9 and o_{10} .** We consider the Jacobian fibrations

$$\phi^{[9]}: X \rightarrow \mathbb{P}^1, \quad \phi^{[10]}: X \rightarrow \mathbb{P}^1$$

associated with the two configurations whose dual graphs are in Figures 4.6. Each of these Jacobian fibrations has two reducible fibers of type $E_8 + E_8$, and their Mordell–Weil groups are isomorphic to \mathbb{Z} . The automorphisms $g^{[9]}: X \rightarrow X$ and $g^{[10]}: X \rightarrow X$ obtained by the inversions $\iota(\phi^{[9]})$ and $\iota(\phi^{[10]})$ of the generic fiber of $\phi^{[9]}$ and of $\phi^{[10]}$ are generators associated with the orbits o_9 and o_{10} , respectively.

5. FACES OF D_0

We investigate the faces of D_0 of codimension ≥ 2 . This leads to the following:

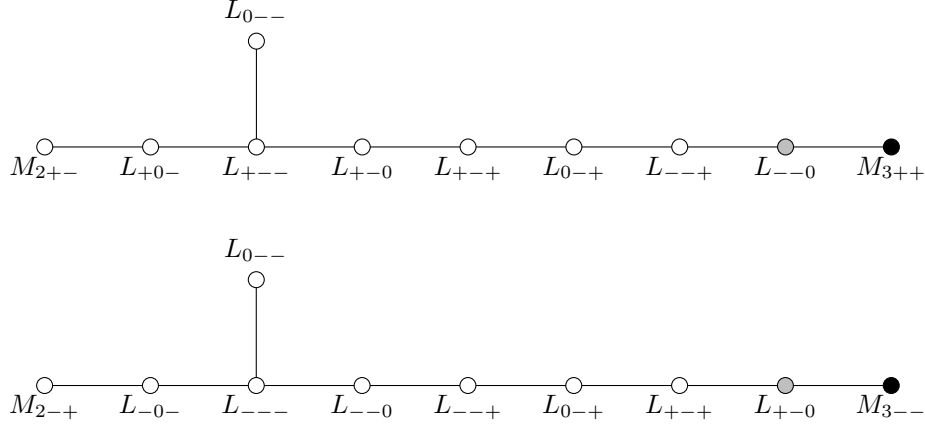

FIGURE 4.6. Configurations for $\phi^{[9]}$ and $\phi^{[10]}$

- (a) The orbit decomposition by $\text{Aut}(X)$ of the set $\mathfrak{C}(\tau)$ of ADE-configurations of smooth rational curves on X with a fixed ADE-type τ (Theorem 1.2).
- (b) A presentation of $\text{Aut}(X)$ in terms of generators and relations (Theorem 6.6).

5.1. Enumeration of faces of D_0 . Using the standard algorithm of linear programming, we can calculate the set $\mathcal{F}^\mu(D_0)$ of faces of D_0 with codimension μ by induction on μ . See [13] for the algorithm. Since the size of the set $\mathcal{F}^\mu(D_0)$ grows rapidly with μ as is indicated in the table below, we stopped the computation at $\mu = 5$. In the table below, the number of $\text{Aut}(X, D_0)$ -orbits in $\mathcal{F}^\mu(D_0)$ is also given.

μ	1	2	3	4	5
$ \mathcal{F}^\mu(D_0) $	80	1746	20228	150750	793280
orbits	10	128	1322	9578	49880.

For each wall w of D_0 , we choose an isometry $g_w \in O(S_X, \mathcal{P}_X)$ such that $D_0^{g_w}$ is the L_{26}/S_X -chamber adjacent to D_0 across the wall w and that

$$(5.1) \quad \eta(g_w) \in \{\pm 1\}.$$

When w is an inner wall of D_0 , any element of $\text{Adj}(w)$ defined by (3.8) can be taken as g_w . When w is an outer wall of D_0 , we can choose g_w to be the reflection $s_r: x \mapsto x + \langle x, r \rangle r$ with respect to the (-2) -vector r such that $w = D_0 \cap (r)^\perp$. (Note that $\eta(s_r) = 1$.)

Recall that, for a face f of an L_{26}/S_X -chamber, we denote by $\mathcal{D}(f)$ the set of L_{26}/S_X -chambers containing f . Suppose that $f \in \mathcal{F}^\mu(D_0)$. We explain a method for enumerating all the elements of $\mathcal{D}(f)$. Since $D_0 \in \mathcal{D}(f)$, we initialize

$$\mathcal{G} = [\text{id}], \quad \mathcal{A} = [a_{32}], \quad i = 1,$$

where id is the identity element of $O(S_X, \mathcal{P}_X)$. We then expand the list \mathcal{G} of elements of $O(S_X, \mathcal{P}_X)$ maintaining the following properties:

- (a) If g is a member of \mathcal{G} , then $D_0^g \in \mathcal{D}(f)$ holds.
- (b) If g and g' are distinct members of \mathcal{G} , then $D_0^g \neq D_0^{g'}$ holds. Note that the condition $D_0^g \neq D_0^{g'}$ is equivalent to the condition $a_{32}^g \neq a_{32}^{g'}$.

μ	τ	$ \mathcal{F}^\mu(D_0, \tau) $	orbits	μ	τ	$ \mathcal{F}^\mu(D_0, \tau) $	orbits
1	A_1	24	2	4	$4A_1$	8802	572
2	$2A_1$	276	23	4	$2A_1 + A_2$	5056	322
2	A_2	32	3	4	$A_1 + A_3$	10760	673
3	$3A_1$	1936	126	4	$2A_2$	384	32
3	$A_1 + A_2$	592	37	4	A_4	96	8
3	A_3	712	45	4	D_4	160	10

TABLE 5.1. Sizes of $\mathcal{F}^\mu(D_0, \tau)$ and the number of $\text{Aut}(X, D_0)$ -orbits

The procedure goes as follows. While the counter i is $\leq |\mathcal{G}|$, we repeat the following. Let g_i be the i th element of \mathcal{G} , so that we have $D_0^{g_i} \in \mathcal{D}(f)$. We put

$$f' := f^{(g_i^{-1})} \in \mathcal{F}^\mu(D_0).$$

If a wall w of D_0 passes through f' , then $D_0^{g_w g_i}$ is an element of $\mathcal{D}(f)$ adjacent to $D_0^{g_i}$ across the wall w^{g_i} of $D_0^{g_i}$. For each wall w of D_0 , if $w \supset f'$ and $a_{32}^{g_w g_i} \notin \mathcal{A}$, then we append $g_w g_i$ to \mathcal{G} , and $a_{32}^{g_w g_i}$ to \mathcal{A} . After doing this task for all walls w of D_0 , we increment the counter i by 1.

When this procedure terminates, the set $\mathcal{D}(f)$ is equal to $\{D_0^g \mid g \in \mathcal{G}\}$. Then we can compute the set

$$\mathcal{D}(f) \cap V_X = \{D \in \mathcal{D}(f) \mid D \subset N_X\}.$$

We can also compute the set

$$(5.2) \quad \mathcal{C}(f) := \{C \in \text{Rats}(X) \mid (C)^\perp \supset f\}.$$

Remark 5.1. For $D \in \mathcal{D}(f)$, let $g(D)$ denote the element of \mathcal{G} such that $D = D_0^{g(D)}$. Since the choice of g_w satisfies (5.1), we have $\eta(g(D)) \in \{\pm 1\}$. In particular, we have

$$D \in \mathcal{D}(f) \cap V_X \iff g(D) \in \text{Aut}(X)$$

by Proposition 3.8.

Computing these data for all $f \in \mathcal{F}^\mu(D_0)$ and examining the dual graph of $\mathcal{C}(f)$ for each f , we calculate the subset

$$\mathcal{F}^\mu(D_0, \tau) := \{f \in \mathcal{F}^\mu(D_0) \mid \mathcal{C}(f) \in \mathfrak{C}(\tau)\}$$

of $\mathcal{F}^\mu(D_0)$ for each ADE-type τ . The group $\text{Aut}(X, D_0)$ acts on $\mathcal{F}^\mu(D_0, \tau)$. The sizes of the set $\mathcal{F}^\mu(D_0, \tau)$ and the numbers of $\text{Aut}(X, D_0)$ -orbits in $\mathcal{F}^\mu(D_0, \tau)$ are given in Table 5.1.

5.2. Faces of codimension 2. We examine the set $\mathcal{F}^2(D_0)$. The faces in $\mathcal{F}^2(D_0)$ are classified into 12 types, which are illustrated in Figure 5.1. We choose a general point p of f , and consider a small disk Δ centered at p within a 2-dimensional linear subspace in \mathcal{P}_X intersecting f at p orthogonally. In Figure 5.1, we depict the intersections of Δ with the L_{26}/S_X -chambers $D \in \mathcal{D}(f)$ containing f . The dark gray sector is $\Delta \cap D_0$, and the dark and light gray sectors are $\Delta \cap D$ with $D \subset N_X$. Thick lines indicate $\Delta \cap (C)^\perp$, where $C \in \text{Rats}(X)$ is a smooth rational curves such that $(C)^\perp \supset f$.

The type is denoted as $\sigma := n_{lr}$, where n is the size of the set $\mathcal{D}(f)$, l is the size of $\mathcal{D}(f) \cap V_X$, and r is the number of $C \in \mathcal{C}(f)$ such that $(C)^\perp \cap D_0$ is a

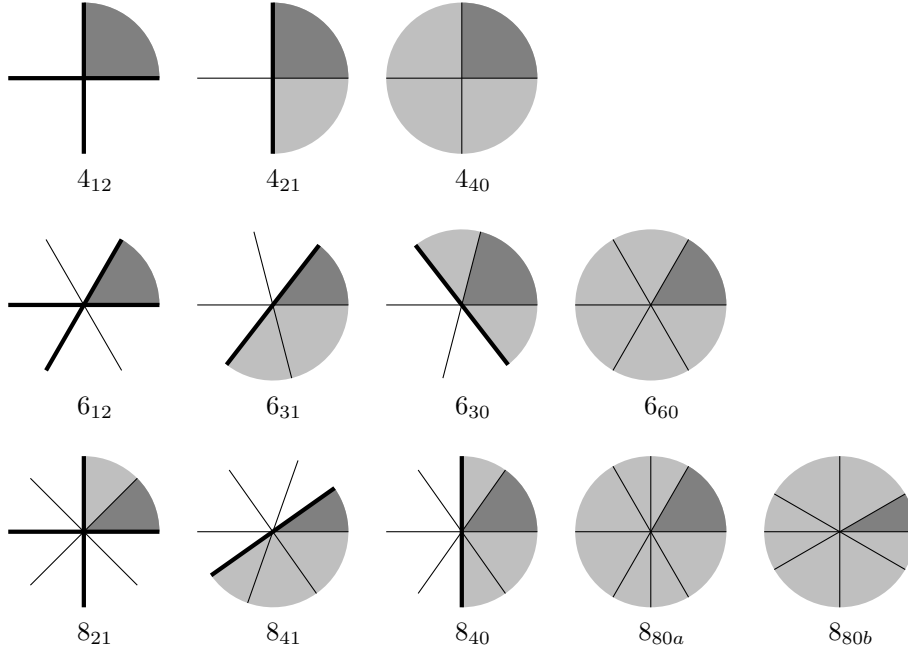
 FIGURE 5.1. Types of codimension-2 faces of D_0

wall of D_0 . The size of the set $\mathcal{F}^2(D_0)_\sigma$ of faces of type σ is listed in the second column of Table 5.2. The group $\text{Aut}(X, D_0)$ acts on $\mathcal{F}^2(D_0)_\sigma$. The numbers of $\text{Aut}(X, D_0)$ -orbits in $\mathcal{F}^2(D_0)_\sigma$ are also presented.

We index the L_{26}/S_X -chambers $D \in \mathcal{D}(f)$ as D_0, \dots, D_{n-1} , starting D_0 and proceeding around f . Then the dihedral angle θ_i of D_i at p for $i = 0, 1, \dots, n/2 - 1$ are given in the third column of Table 5.2 by means of the rational number

$$(\cos \theta_i)^2 = \frac{\langle v, v' \rangle^2}{\langle v, v \rangle \langle v', v' \rangle},$$

where $(v)^\perp \cap D_i$ and $(v')^\perp \cap D_i$ are the two walls of D_i containing f . The fourth column of Table 5.2 provides all possible pairs $kk' = \{k, k'\}$ of the indexes of orbits o_k and $o_{k'}$ to which the walls $(v)^\perp \cap D_0$ and $(v')^\perp \cap D_0$ of D_0 containing f belong. Here the index 10 of o_{10} is denoted by t so that $1t$ and $2t$ mean $\{1, 10\}$ and $\{2, 10\}$, respectively.

Let $w \in \mathcal{F}^1(D_0)$ be a wall of D_0 that belongs to the orbit o_i . The numbers and types of codimension-2 faces $f \in \mathcal{F}^2(D_0)$ such that $f \subset w$ are given in Table 5.3.

5.3. Orbit decomposition of $\mathcal{C}(\tau)$ by $\text{Aut}(X)$. We present a method to calculate the orbit decomposition of the action of $\text{Aut}(X)$ on the set $\mathcal{C}(\tau)$ of ADE-configurations of smooth rational curves of type τ . This method requires the sets $\mathcal{F}^\mu(D_0)$ and $\mathcal{F}^{\mu+1}(D_0)$ of all faces of codimension μ and $\mu+1$, where μ is the Milnor number of τ . From the set $\mathcal{F}^1(D_0), \dots, \mathcal{F}^5(D_0)$, we obtain the orbit decomposition of $\mathcal{C}(\tau)$ for all ADE-types τ with $\mu \leq 4$, proving Theorem 1.2.

Let $\mathcal{C} = \{C_1, \dots, C_\mu\}$ be an element of $\mathcal{C}(\tau)$. We define

$$\mathcal{P}_{\mathcal{C}} = (C_1)^\perp \cap \dots \cap (C_\mu)^\perp,$$

type σ	$ \mathcal{F}^2(D_0)_\sigma $	orbits	$(\cos \theta_i)^2$			pairs of walls	
4_{12}	244	21	0	0		11, 12, 22	
4_{21}	1096	73	0	0		13, \dots, 19, 1t, 23, \dots, 29, 2t	
4_{40}	88	8	0	0		34, 35, 36, 37	
6_{12}	32	3	1/4	1/4	1/4	12, 22	
6_{31}	8	1	3/8	3/8	1/16	13	
6_{30}	4	1	1/16	3/8	3/8	33	
6_{60}	2	1	1/4	1/4	1/4	33	
8_{21}	32	2	1/2	1/2	1/2	14, 24	
8_{41}	112	8	2/3	2/3	1/3	1/3	15, 16, 25, 26, 27
8_{40}	112	8	1/3	2/3	2/3	1/3	45, 46, 47
8_{80a}	8	1	1/4	3/4	3/4	1/4	38
8_{80b}	8	1	3/4	1/4	1/4	3/4	34

TABLE 5.2. Data of codimension-2 faces of D_0

orbit	total number	types and numbers
o_1	77	$(4_{12})^{21}(4_{21})^{45}(6_{12})^2(6_{31})^1(8_{21})^2(8_{41})^6$
o_2	74	$(4_{12})^{20}(4_{21})^{46}(6_{12})^3(8_{21})^1(8_{41})^4$
o_3	53	$(4_{21})^{22}(4_{40})^{22}(6_{31})^2(6_{30})^2(6_{60})^1(8_{80a})^2(8_{80b})^2$
o_4	42	$(4_{21})^{20}(4_{40})^3(8_{21})^4(8_{40})^{14}(8_{80b})^1$
o_5	32	$(4_{21})^{19}(4_{40})^3(8_{41})^5(8_{40})^5$
o_6	32	$(4_{21})^{19}(4_{40})^3(8_{41})^5(8_{40})^5$
o_7	30	$(4_{21})^{20}(4_{40})^2(8_{41})^4(8_{40})^4$
o_8	22	$(4_{21})^{20}(8_{80a})^2$
o_9	19	$(4_{21})^{19}$
o_{10}	19	$(4_{21})^{19}$

TABLE 5.3. Faces of codimension 2 that bound a wall

which is a linear subspace of codimension μ in \mathcal{P}_X .

Proposition 5.2. *The intersection $\mathcal{P}_C \cap N_X$ is a face of codimension μ of the S_X/S_X -chamber N_X .*

Proof. Since $\langle a, C_i \rangle > 0$ for any ample class a , it follows that \mathcal{P}_C is disjoint from the interior of N_X . It suffices to show that there exists a point p on \mathcal{P}_C such that $\langle p, C' \rangle > 0$ holds for any smooth rational curve C' on X that is not a member of \mathcal{C} . We define $m_{ij} := \langle C_i, C_j \rangle$, and consider the $\mu \times \mu$ matrix $M := (m_{ij})$, which is the Gram matrix of the negative-definite root lattice of type τ with respect to the standard basis. It is well known that every entry of the inverse matrix M^{-1} is ≤ 0 . Fixing an ample class a , we define $t_1, \dots, t_\mu \in \mathbb{Q}$ by

$$\begin{bmatrix} t_1 \\ \vdots \\ t_\mu \end{bmatrix} = M^{-1} \begin{bmatrix} \langle a, C_1 \rangle \\ \vdots \\ \langle a, C_\mu \rangle \end{bmatrix}.$$

Since $\langle a, C_i \rangle > 0$ for $i = 1, \dots, \mu$, we have $t_i \leq 0$ for $i = 1, \dots, \mu$. We put

$$p := a - (t_1 C_1 + \dots + t_\mu C_\mu).$$

Then we have $\langle p, C_i \rangle = 0$ for $i = 1, \dots, \mu$, and

$$\langle p, p \rangle = \langle p, a \rangle = \langle a, a \rangle - (t_1 \langle C_1, a \rangle + \dots + t_\mu \langle C_\mu, a \rangle) > 0.$$

Thus we have $p \in \mathcal{P}_C$. For any $C' \in \text{Rats}(X)$ such that $C' \notin \mathcal{C}$, we have $\langle a, C' \rangle > 0$ and $\langle C_i, C' \rangle \geq 0$ for $i = 1, \dots, \mu$. Hence $\langle p, C' \rangle > 0$ holds. Therefore a small neighborhood of p in \mathcal{P}_C is contained in $\mathcal{P}_C \cap N_X$. \square

Let $[\mathcal{C}]^\perp$ be the orthogonal complement of the sublattice $[\mathcal{C}]$ of S_X generated by the elements of \mathcal{C} . Then $[\mathcal{C}]^\perp$ is a primitive sublattice of S_X with signature $(1, 18 - \mu)$, and

$$\mathcal{P}_C := \mathcal{P}_X \cap ([\mathcal{C}]^\perp \otimes \mathbb{R})$$

is a positive cone of $[\mathcal{C}]^\perp$. The tessellation of \mathcal{P}_X by the S_X/S_X -chambers induces a tessellation of \mathcal{P}_C by the $S_X/[\mathcal{C}]^\perp$ -chambers, and $\mathcal{P}_C \cap N_X$ is one of these $S_X/[\mathcal{C}]^\perp$ -chambers. On the other hand, since S_X is embedded primitively into L_{26} in Section 3.5, we can regard $[\mathcal{C}]^\perp$ as a primitive sublattice of L_{26} , and every $S_X/[\mathcal{C}]^\perp$ -chamber is tessellated by $L_{26}/[\mathcal{C}]^\perp$ -chambers. Note that every $L_{26}/[\mathcal{C}]^\perp$ -chamber is of the form $\mathcal{P}_C \cap D$, where D is an L_{26}/S_X -chamber and $\mathcal{P}_C \cap D$ is a face of D with supporting linear subspace \mathcal{P}_C . The algorithm below is Borcherds' method applied to the tessellation of the $S_X/[\mathcal{C}]^\perp$ -chamber $\mathcal{P}_C \cap N_X$ by $L_{26}/[\mathcal{C}]^\perp$ -chambers $\mathcal{P}_C \cap D$.

We consider the map

$$(5.3) \quad \mathcal{F}^\mu(D_0, \tau) \rightarrow \mathfrak{C}(\tau)$$

given by $f \mapsto \mathcal{C}(f)$, where $\mathcal{C}(f)$ is defined by (5.2). Let \mathcal{C} be an arbitrary element of $\mathfrak{C}(\tau)$. By Proposition 5.2, there exists an element D of V_X such that $f_D := \mathcal{P}_C \cap D$ is a face of D with supporting linear subspace \mathcal{P}_C . Since $\text{Aut}(X)$ acts on V_X transitively, there exists an automorphism $g \in \text{Aut}(X)$ such that $D^g = D_0$. Then we have $f_D^g \in \mathcal{F}^\mu(D_0, \tau)$, and the mapping (5.3) maps f_D^g to \mathcal{C}^g . Therefore the mapping (5.3) induces a surjective map

$$(5.4) \quad \mathcal{F}^\mu(D_0, \tau) \twoheadrightarrow \mathfrak{C}(\tau) / \text{Aut}(X).$$

Fix an element \mathcal{C} of $\mathfrak{C}(\tau)$. We define

$$\begin{aligned} \tilde{V}_\mathcal{C} &:= \{ D \in V_X \mid \mathcal{P}_C \cap D \text{ is a face of } D \text{ with supporting linear subspace } \mathcal{P}_C \} \\ &= \{ D \in V_X \mid \mathcal{P}_C \cap D \text{ contains a nonempty open subset of } \mathcal{P}_C \}, \\ V_\mathcal{C} &:= \{ \mathcal{P}_C \cap D \mid D \in \tilde{V}_\mathcal{C} \}. \end{aligned}$$

Then the stabilizer subgroup

$$\text{Aut}(X, \mathcal{C}) := \{ g \in \text{Aut}(X) \mid g \text{ preserves } \mathcal{C} \}$$

of \mathcal{C} acts on $\tilde{V}_\mathcal{C}$.

Remark 5.3. The mapping $D \mapsto \mathcal{P}_C \cap D$ from $\tilde{V}_\mathcal{C}$ to $V_\mathcal{C}$ may not be a bijection. For example, when $\tau = 2A_1$, if $\mathcal{P}_C \cap D_0$ is a codimension-2 face of D_0 with type 8_{21} (see Figure 5.1), then there exists an L_{26}/S_X -chamber D' such that $D' \neq D_0$ and that $\mathcal{P}_C \cap D' = \mathcal{P}_C \cap D_0$.

For $D \in \tilde{V}_{\mathcal{C}}$, there exists an automorphism $g(D) \in \text{Aut}(X)$ such that $D = D_0^{g(D)}$. Then

$$(\mathcal{P}_{\mathcal{C}} \cap D)^{(g(D)^{-1})} = \mathcal{P}_{\mathcal{C}(g(D)^{-1})} \cap D_0$$

is a face of D_0 of codimension μ , and this face is a member of $\mathcal{F}^{\mu}(D_0, \tau)$. Recall that $\text{Aut}(X, D_0)$ acts on $\mathcal{F}^{\mu}(D_0, \tau)$. The choice of $g(D) \in \text{Aut}(X)$ such that $D = D_0^{g(D)}$ is unique up to the left multiplication of elements of $\text{Aut}(X, D_0)$. More generally, if $D' \in \tilde{V}_{\mathcal{C}}$ is equal to D^{γ} for an element $\gamma \in \text{Aut}(X, \mathcal{C})$, then there exists an element $h \in \text{Aut}(X, D_0)$ such that $hg(D)\gamma = g(D')$. Since

$$(\mathcal{P}_{\mathcal{C}} \cap D')^{(g(D')^{-1})} = (\mathcal{P}_{\mathcal{C}} \cap D')^{(\gamma^{-1}g(D)^{-1}h^{-1})} = (\mathcal{P}_{\mathcal{C}} \cap D)^{(g(D)^{-1}h^{-1})},$$

the mapping $D \mapsto (\mathcal{P}_{\mathcal{C}} \cap D)^{(g(D)^{-1})}$ induces a mapping

$$\Phi_{\mathcal{C}} : \tilde{V}_{\mathcal{C}} \rightarrow \mathcal{F}^{\mu}(D_0, \tau) / \text{Aut}(X, D_0)$$

that factors through the natural projection

$$\tilde{V}_{\mathcal{C}} \twoheadrightarrow \tilde{V}_{\mathcal{C}} / \text{Aut}(X, \mathcal{C}).$$

Proposition 5.4. *For $\mathcal{C} \in \mathfrak{C}(\tau)$ and $\mathcal{C}' \in \mathfrak{C}(\tau)$, the following are equivalent:*

- (i) \mathcal{C} and \mathcal{C}' are in the same $\text{Aut}(X)$ -orbit.
- (ii) The images of $\Phi_{\mathcal{C}}$ and of $\Phi_{\mathcal{C}'}$ are the same.
- (iii) The images of $\Phi_{\mathcal{C}}$ and of $\Phi_{\mathcal{C}'}$ have nonempty intersection.

Proof. Suppose that $\mathcal{C}' = \mathcal{C}^{\alpha}$ for some $\alpha \in \text{Aut}(X)$. We have $\mathcal{P}_{\mathcal{C}'}^{(\alpha^{-1})} = \mathcal{P}_{\mathcal{C}}$. For $D \in \tilde{V}_{\mathcal{C}}$, we have $D^{\alpha} \in \tilde{V}_{\mathcal{C}'}$ and $\Phi_{\mathcal{C}}(D) = \Phi_{\mathcal{C}'}(D^{\alpha})$, because $g(D^{\alpha}) = hg(D)\alpha$ for some $h \in \text{Aut}(X, D_0)$. Thus, the image of $\Phi_{\mathcal{C}}$ is contained in the image of $\Phi_{\mathcal{C}'}$. Therefore (i) implies (ii).

The implication (ii) \implies (iii) is obvious. The implication (iii) \implies (i) follows from the fact that, if f is an element of the $\text{Aut}(X, D_0)$ -orbit $\Phi_{\mathcal{C}}(D)$, then \mathcal{C} and $\mathcal{C}(f)$ are in the same $\text{Aut}(X)$ -orbit, because the supporting linear subspace $\mathcal{P}_{\mathcal{C}} \cap D$ of D is mapped to the supporting linear subspace $\mathcal{P}_{\mathcal{C}(f)}$ of the face f of D_0 by an element of $\text{Aut}(X)$. \square

As is seen from the surjectivity of the map (5.4), every $\text{Aut}(X)$ -orbit in $\mathfrak{C}(\tau)$ contains a configuration $\mathcal{C}(f)$ for some $f \in \mathcal{F}^{\mu}(D_0, \tau)$. Hence, calculating the images of $\Phi_{\mathcal{C}(f)}$ for all $f \in \mathcal{F}^{\mu}(D_0, \tau)$, we obtain the orbit decomposition of $\mathfrak{C}(\tau)$ by $\text{Aut}(X)$.

The images of $\Phi_{\mathcal{C}(f)}$ for faces $f \in \mathcal{F}^{\mu}(D_0, \tau)$ are computed as follows. The idea is to calculate the orbit decomposition of $\tilde{V}_{\mathcal{C}}$ under the action of $\text{Aut}(X, \mathcal{C})$ by Borchers' method. For simplicity, we put

$$[\mathcal{F}] := \mathcal{F}^{\mu}(D_0, \tau) / \text{Aut}(X, D_0),$$

and for $f \in \mathcal{F}^{\mu}(D_0, \tau)$, let $[f] \in [\mathcal{F}]$ denote the $\text{Aut}(X, D_0)$ -orbit containing f . We construct a graph whose set of nodes is $[\mathcal{F}]$ and whose set of edges is defined as follows. Let f be an element of $\mathcal{F}^{\mu}(D_0, \tau)$. We have $D_0 \in \tilde{V}_{\mathcal{C}(f)}$, and $\Phi_{\mathcal{C}(f)}$ maps D_0 to $[f]$, as $\mathcal{P}_{\mathcal{C}(f)} \cap D_0 = f$. Using the set $\mathcal{F}^{\mu+1}(D_0)$, we compute the set

$$\mathcal{F}^{\mu+1}\langle f \rangle := \{ \varphi \in \mathcal{F}^{\mu+1}(D_0) \mid f \supset \varphi \},$$

which is the set of all walls of the $L_{26}/[\mathcal{C}(f)]^{\perp}$ -chamber $f = \mathcal{P}_{\mathcal{C}(f)} \cap D_0$. For each $\varphi \in \mathcal{F}^{\mu+1}\langle f \rangle$, we calculate the set $\mathcal{D}(\varphi)$ and subsequently compute the subset

$$\mathcal{D}(f, \varphi) := \tilde{V}_{\mathcal{C}(f)} \cap \mathcal{D}(\varphi).$$

For an L_{26}/S_X -chamber D , we have $D \in \mathcal{D}(f, \varphi)$ if and only if $\mathcal{P}_{\mathcal{C}(f)} \cap D$ is an $L_{26}/[\mathcal{C}(f)]^\perp$ -chamber that is contained in $\mathcal{P}_{\mathcal{C}(f)} \cap N_X$ and that is either equal to f or adjacent to f across the wall φ . For each $D \in \mathcal{D}(f, \varphi)$, we choose an automorphism $g(D) \in \text{Aut}(X)$ such that $D = D_0^{g(D)}$, and consider the face

$$f' := (\mathcal{P}_{\mathcal{C}(f)})^{(g(D)^{-1})} \cap D_0.$$

Then f' is an element of $\mathcal{F}^\mu(D_0, \tau)$ and $[f'] \in [\mathcal{F}]$ does not depend on the choice of $g(D)$. If $[f'] \neq [f]$, we connect the nodes $[f]$ and $[f']$ by an edge. Performing this procedure for all $[f] \in [\mathcal{F}]$, $\varphi \in \mathcal{F}^{\mu+1}(f)$ and $D \in \mathcal{D}(f, \varphi)$, we obtain a graph structure on $[\mathcal{F}]$.

Since any pair of elements of $V_{\mathcal{C}(f)}$ (that is, any pair of $L_{26}/[\mathcal{C}(f)]^\perp$ -chambers contained in $\mathcal{P}_{\mathcal{C}(f)} \cap N_X$) is connected by the adjacency relation of $L_{26}/[\mathcal{C}(f)]^\perp$ -chambers, it follows that the image of $\Phi_{\mathcal{C}(f)}$ is precisely the connected component of the graph $[\mathcal{F}]$ containing the node $[f]$.

Therefore the number of $\text{Aut}(X)$ -orbits in $\mathfrak{C}(\tau)$ is equal to the number of connected components of the graph $[\mathcal{F}]$. Using this method, we obtain a proof of Theorem 1.2.

Example 5.5. We consider the case where $\tau = 2A_1$. The number of nodes of the graph $[\mathcal{F}] = \mathcal{F}^2(D_0, 2A_1)/\text{Aut}(X, D_0)$ is 23, and this graph has two connected components $[\mathcal{F}]_{21}$ and $[\mathcal{F}]_2$ of size 21 and 2, respectively. Every face in the connected component $[\mathcal{F}]_{21}$ is of type 4_{12} , whereas every face in the connected component $[\mathcal{F}]_2$ is of type 8_{21} . Hence $\text{Aut}(X)$ partitions the set $\mathfrak{C}(2A_1)$ of pairs of disjoint smooth rational curves into two orbits $\mathfrak{C}(2A_1)_{21}$ and $\mathfrak{C}(2A_1)_2$, which correspond to the connected components $[\mathcal{F}]_{21}$ and $[\mathcal{F}]_2$, respectively.

The linear subspace

$$(L_{---})^\perp \cap (L_{-0+})^\perp$$

of \mathcal{P}_X is a supporting linear subspace of a face of D_0 with type 4_{12} . Hence the pair $\{L_{---}, L_{-0+}\}$ is a member of the orbit $\mathfrak{C}(2A_1)_{21}$.

Let L' be the image of the smooth rational curve L_{+--} by the automorphism $g^{[4]} \in \text{Aut}(X)$ of order 2 given in Section 4.5. Then the linear subspace

$$(L_{+--})^\perp \cap (L')^\perp$$

of \mathcal{P}_X is a supporting linear subspace of a face of D_0 with type 8_{21} . Hence the pair $\{L_{+--}, L'\}$ is a member of the orbit $\mathfrak{C}(2A_1)_2$. (Note that, for every face f of type 8_{21} , there exists a wall in the orbit o_4 passing through f . See Table 5.2.)

6. RELATIONS

It is well known that a set of defining relations of a group acting on a space of constant curvature can be derived from the shape of a fundamental domain. See, for example, the survey [28]. In our current setting involving $\text{Aut}(X)$ and D_0 , however, we cannot apply this theory directly because of the following reasons. First, the cone D_0 is not a fundamental domain; it has a non-trivial automorphism group $\text{Aut}(X, D_0)$. Second, not all codimension-2 faces contribute to relations as D_0 has outer faces. Hence we provide a detailed explanation how to obtain a set of defining relations for $\text{Aut}(X)$ from D_0 . The main result of this section is Theorem 6.6.

Remark 6.1. In [13], we have treated the case where $\text{Aut}(X, D_0)$ is trivial.

For simplicity, we put

$$\Gamma_0 := \text{Aut}(X, D_0).$$

Recall from (3.8) that we have defined $\text{Adj}(w)$ for each inner wall w of D_0 . For $h \in \Gamma_0$ and $g \in \text{Adj}(w)$, we have $hg \in \text{Adj}(w)$, and this action of Γ_0 on $\text{Adj}(w)$ by the multiplication from the left is free and simply transitive. Note that Γ_0 and these $\text{Adj}(w)$ are pairwise disjoint. We put

$$\Gamma_{\mathcal{A}} := \bigsqcup_{w : \text{inner}} \text{Adj}(w) \quad \text{and} \quad \Gamma := \Gamma_0 \sqcup \Gamma_{\mathcal{A}}.$$

Since D_0 has exactly 56 inner walls, we have $|\Gamma| = |\Gamma_0| + 56 \times |\Gamma_0| = 912$.

Lemma 6.2. *The subset $\Gamma_{\mathcal{A}}$ of $\text{Aut}(X)$ is closed under the operation $g \mapsto g^{-1}$. Hence so is $\Gamma = \Gamma_0 \sqcup \Gamma_{\mathcal{A}}$.*

Proof. Suppose that $g \in \text{Adj}(w)$, where w is an inner wall of D_0 . Then D_0 and D_0^g are adjacent across w . Hence $D_0^{(g^{-1})}$ and D_0 are adjacent across $w^{(g^{-1})}$. Since $D_0^{(g^{-1})} \subset N_X$, the wall $w^{(g^{-1})}$ of D_0 is inner, and we have $g^{-1} \in \text{Adj}(w^{(g^{-1})})$. \square

We consider Γ as an alphabet, and denote by Γ^* the set of finite sequences of elements of Γ . An element of Γ^* is called a *word*. Note that the empty sequence $\varepsilon := []$ is also a word. The conjunction of two words \mathbf{u} and \mathbf{v} is denoted by $\mathbf{u} \cdot \mathbf{v}$ or by \mathbf{uv} . We have seen in Proposition 3.14 that the multiplication map

$$m : \Gamma^* \rightarrow \text{Aut}(X)$$

given by $[\gamma_1, \dots, \gamma_n] \mapsto \gamma_1 \cdots \gamma_n$ is surjective. See Remark 6.5.

Definition 6.3. A pair $\{\mathbf{w}, \mathbf{w}'\}$ of words is called a *relation* if $m(\mathbf{w}) = m(\mathbf{w}')$ holds. Let \mathcal{R} be a set of relations. The *\mathcal{R} -equivalence relation* is the minimal equivalence relation on Γ^* that satisfies the following: if two words \mathbf{u} and \mathbf{v} have decompositions $\mathbf{u} = \mathbf{a} \cdot \mathbf{w} \cdot \mathbf{b}$ and $\mathbf{v} = \mathbf{a} \cdot \mathbf{w}' \cdot \mathbf{b}$ with $\{\mathbf{w}, \mathbf{w}'\} \in \mathcal{R}$, then \mathbf{u} and \mathbf{v} are \mathcal{R} -equivalent.

Note that, for any set of relations \mathcal{R} , if two words \mathbf{u} and \mathbf{v} are \mathcal{R} -equivalent, then we have $m(\mathbf{u}) = m(\mathbf{v})$.

Definition 6.4. We say that a set of relations \mathcal{R} is a *set of defining relations* if every word in the fiber

$$\mathcal{K} := m^{-1}(1)$$

of the map m over $1 \in \text{Aut}(X)$ is \mathcal{R} -equivalent to the empty word ε .

Our goal is to exhibit a finite set of defining relations.

Let $\mathcal{R}_{\text{triv}}$ be the set of relations consisting of the following pairs of words:

$$\begin{aligned} & \{[1], \varepsilon\}, \\ & \{[\gamma, \gamma^{-1}], [1]\} \quad (\gamma \in \Gamma), \\ & \{[h, h'], [hh']\} \quad (h, h' \in \Gamma_0), \\ & \{[h, g], [hg]\} \quad (h \in \Gamma_0, g \in \Gamma_{\mathcal{A}}). \end{aligned}$$

Here, in the pair $\{[h, h'], [hh']\}$, the word $[h, h']$ is of length 2, whereas $[hh']$ is the word consisting of a single letter $hh' \in \Gamma_0$. The same remark is applied to the pair $\{[h, g], [hg]\}$.

A word \mathbf{u} is said to be of *gh-form* if it is of the form

$$[g_N, \dots, g_1, h] \quad (g_N, \dots, g_1 \in \Gamma_{\mathcal{A}}, \quad h \in \Gamma_0).$$

We allow N to be 0, so that $[h]$ is (and hence $[1]$ is) of gh-form for any $h \in \Gamma_0$. It is easy to see that every word is $\mathcal{R}_{\text{triv}}$ -equivalent to a word of gh-form. For example, for $g_1, g_2 \in \Gamma_{\mathcal{A}}$ and $h \in \Gamma_0$, the word $[g_1, h, g_2]$ is $\mathcal{R}_{\text{triv}}$ -equivalent to the word $[g_1, hg_2, 1]$, which is of gh-form.

Let N be a non-negative integer. A *chamber path* of length N is a sequence

$$\boldsymbol{\lambda} := (D^{(N)}, \dots, D^{(0)})$$

of L_{26}/S_X -chambers $D^{(k)}$ such that

- (i) each $D^{(k)}$ is contained in N_X , and
- (ii) $D^{(k)}$ and $D^{(k-1)}$ are distinct and adjacent for $k = 1, \dots, N$.

A chamber path is read from right to left, so that the chamber path $\boldsymbol{\lambda}$ above is from $D^{(0)}$ to $D^{(N)}$. Let

$$\boldsymbol{\lambda}' := (D'^{(N')}, \dots, D'^{(0)})$$

be a chamber path of length N' such that $D'^{(0)} = D^{(N)}$. Then the conjunction

$$\boldsymbol{\lambda}' \cdot \boldsymbol{\lambda} := (D'^{(N')}, \dots, D'^{(0)}, D^{(N-1)}, \dots, D^{(0)})$$

is defined and is a chamber path of length $N' + N$. A *chamber loop* is a chamber path $(D^{(N)}, \dots, D^{(0)})$ such that $D^{(N)} = D^{(0)}$. In this case, we say that $D^{(0)}$ is the *base point* of the chamber loop.

Let $\mathbf{u} = [g_N, \dots, g_1, h]$ be a word of gh-form. Then we have a chamber path

$$\lambda(\mathbf{u}) = (D^{(N)}, \dots, D^{(0)})$$

from $D^{(0)} = D_0$ to $D^{(N)} = D_0^{m(\mathbf{u})}$ defined by

$$D^{(0)} := D_0^h, \quad D^{(1)} := D_0^{g_1 h}, \quad \dots \quad D^{(k)} := D_0^{g_k \cdots g_1 h}, \quad \dots \quad D^{(N)} := D_0^{g_N \cdots g_1 h}.$$

We call $\lambda(\mathbf{u})$ the *chamber path associated with \mathbf{u}* . If $\mathbf{u} \in \mathcal{K} = m^{-1}(1)$, then $\lambda(\mathbf{u})$ is a chamber loop with the base point D_0 .

Conversely, let $\boldsymbol{\lambda} = (D^{(N)}, \dots, D^{(0)})$ be a chamber path of length N starting from $D^{(0)} = D_0$. We define

$$\mathcal{W}(\boldsymbol{\lambda}) := \{ \mathbf{u} \in \Gamma^* \mid \mathbf{u} \text{ is of gh-form such that } \lambda(\mathbf{u}) = \boldsymbol{\lambda} \}.$$

A word $\mathbf{u} = [g_N, \dots, g_1, h]$ of gh-form is in $\mathcal{W}(\boldsymbol{\lambda})$ if and only if

$$(6.1) \quad D^{(k)} = D_0^{g_k \cdots g_1 h}$$

holds for $k = 0, \dots, N$. Here we set $g_0 = h$. The elements of $\mathcal{W}(\boldsymbol{\lambda})$ can be enumerated by the following method. First choose $g_0 = h$ arbitrarily from Γ_0 . Suppose that g_m, \dots, g_1, h have been obtained such that (6.1) holds for $k = 0, \dots, m$. Let $w^{(m)}$ be the wall between $D^{(m)}$ and $D^{(m+1)}$. Then

$$w_m := (w^{(m)})^{(g_m \cdots g_1 h)^{-1}}$$

is an inner wall of D_0 . We choose g_{m+1} from $\text{Adj}(w_m)$ arbitrarily, and append it to the beginning of the sequence g_m, \dots, g_1, h . By iterating this process until we reach $m+1 = N$, we obtain a word in $\mathcal{W}(\boldsymbol{\lambda})$. Repeating this process for all possible choices of $h \in \Gamma_0$ and $g_{m+1} \in \text{Adj}(w_m)$, we obtain all words in $\mathcal{W}(\boldsymbol{\lambda})$. Therefore the size of the set $\mathcal{W}(\boldsymbol{\lambda})$ is equal to $|\Gamma_0|^{N+1}$.

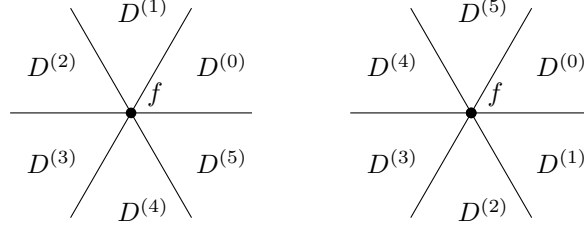
FIGURE 6.1. $\lambda^+(f)$ and $\lambda^-(f)$

Now suppose that λ is a chamber loop with the base point D_0 . Then, for any $\mathbf{u} \in \mathcal{W}(\lambda)$, we have $m(\mathbf{u}) \in \Gamma_0$, and the map m induces a surjection from $\mathcal{W}(\lambda)$ onto Γ_0 . We define

$$\mathcal{W}_{\mathcal{K}}(\lambda) := \mathcal{W}(\lambda) \cap \mathcal{K}.$$

The size of the set $\mathcal{W}_{\mathcal{K}}(\lambda)$ is equal to $|\Gamma_0|^N$. In particular, if $N = 0$, then $\mathcal{W}_{\mathcal{K}}(\lambda)$ is equal to $\{[1]\}$.

Remark 6.5. Suppose that $g \in \text{Aut}(X)$ is given. Then a word $\mathbf{u} \in \Gamma^*$ satisfying $m(\mathbf{u}) = g$ can be obtained by means of the following method. We choose a chamber path $\lambda = (D^{(N)}, \dots, D^{(0)})$ from $D^{(0)} = D_0$ to $D^{(N)} = D_0^g$, and compute an element

$$\mathbf{u}' = [g_N, \dots, g_1, 1]$$

of $\mathcal{W}(\lambda)$ using the method above. Since $D_0^g = D^{(N)} = D_0^{m(\mathbf{u}')}$, there exists an element $h \in \Gamma_0$ such that $g = h \cdot m(\mathbf{u}')$. Then the word $\mathbf{u} := [h, g_N, \dots, g_1]$ satisfies $m(\mathbf{u}) = g$.

Let $D^{(0)}$ be an L_{26}/S_X -chamber contained in N_X , and let f be an inner face of $D^{(0)}$ of codimension 2. Recall that $\mathcal{D}(f)$ is the set of L_{26}/S_X -chambers D such that $D \supset f$. We have $D^{(0)} \in \mathcal{D}(f)$. Since f is inner, we have $\mathcal{D}(f) \subset V_X$. Then we have two chamber loops $\lambda(f)^+$ and $\lambda(f)^-$ with the base point $D^{(0)}$ such that

- (i) every chamber in the loop belongs to $\mathcal{D}(f)$, and
- (ii) each element of $\mathcal{D}(f) \setminus \{D^{(0)}\}$ appears in the loop exactly once.

See Figure 6.1. These two loops differ only in the direction to which the loop goes around f . We call these loops the *simple chamber loops around f with the base point $D^{(0)}$* .

Suppose that f_0 is an inner face of D_0 of codimension 2. In other words, f_0 is of type 4_{40} , 6_{60} , 8_{80a} , or 8_{80b} (see Figure 5.1). Let $\lambda(f_0)^+$ and $\lambda(f_0)^-$ be the simple chamber loops around f_0 with the base point D_0 . Then, for any word \mathbf{u} belonging to $\mathcal{W}(\lambda(f_0)^+)$ or $\mathcal{W}(\lambda(f_0)^-)$, we have $m(\mathbf{u}) \in \Gamma_0$. We define a set of relations $\mathcal{R}_{\text{face}}$ as

$$\mathcal{R}_{\text{face}} := \bigcup_{f_0} \{ \{\mathbf{u}, [m(\mathbf{u})]\} \mid \mathbf{u} \in \mathcal{W}(\lambda(f_0)^+) \cup \mathcal{W}(\lambda(f_0)^-) \},$$

where f_0 ranges over the set of inner faces of D_0 of codimension 2.

Theorem 6.6. *The set $\mathcal{R}_{\text{triv}} \cup \mathcal{R}_{\text{face}}$ is a set of defining relations of $\text{Aut}(X)$ with respect to the generating set $\Gamma = \Gamma_0 \sqcup \Gamma_{\mathcal{A}}$.*

To prove this, we introduce additional definitions and propositions. Let

$$(6.2) \quad \lambda = (D^{(N)}, \dots, D^{(0)}) \quad \text{with} \quad D^{(N)} = D^{(0)} = D_0$$

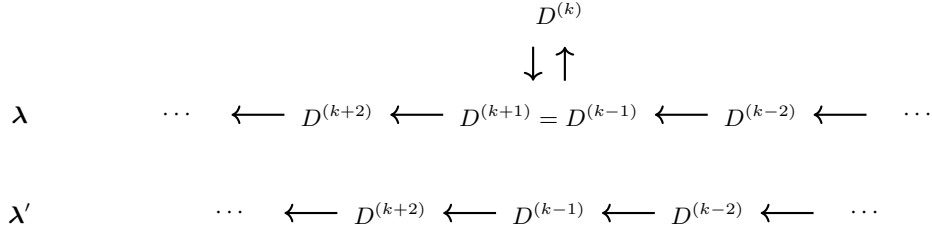
FIGURE 6.2. $\lambda \Rightarrow_{\text{I}} \lambda'$

be a chamber loop with the base point D_0 . We say that λ is *reduced to a chamber loop λ' by a type-I-move* and write $\lambda \Rightarrow_{\text{I}} \lambda'$ if there exists a subsequence $(D^{(k+1)}, D^{(k)}, D^{(k-1)})$ in λ such that $D^{(k+1)} = D^{(k-1)}$ and that λ' is obtained from λ by removing the two chambers $D^{(k+1)}$ and $D^{(k)}$. See Figure 6.2. We say that two chamber loops λ, λ' with the base point D_0 are *connected by a type-I-move* if either $\lambda \Rightarrow_{\text{I}} \lambda'$ or $\lambda' \Rightarrow_{\text{I}} \lambda$.

Proposition 6.7. *Suppose that chamber loops λ and λ' with the base point D_0 are connected by a type-I-move. Then, for each word $\mathbf{u} \in \mathcal{W}_{\mathcal{K}}(\lambda)$, there exists a word $\mathbf{u}' \in \mathcal{W}_{\mathcal{K}}(\lambda')$ that is $\mathcal{R}_{\text{triv}}$ -equivalent to \mathbf{u} .*

Proof. Let λ be as in (6.2), and we put $\mathbf{u} = [g_N, \dots, g_1, h]$ with $g_0 = h$.

Suppose that $\lambda \Rightarrow_{\text{I}} \lambda'$ as is shown in Figure 6.2. Then $D^{(k+1)} = D^{(k-1)}$ implies that $g_{k+1}g_k \in \Gamma_0$. We put $h' := g_{k+1}g_k$, and let \mathbf{u}' be a word obtained from \mathbf{u} by removing the two letters g_{k+1}, g_k and replacing g_{k-1} with $h'g_{k-1}$. Then we see that \mathbf{u}' is $\mathcal{R}_{\text{triv}}$ -equivalent to \mathbf{u} , using the relation $\{[h', g_k^{-1}], [g_{k+1}]\}$. It is easy to see that \mathbf{u}' belongs to $\mathcal{W}_{\mathcal{K}}(\lambda')$.

Conversely, suppose that $\lambda' \Rightarrow_{\text{I}} \lambda$. We assume that λ' is obtained from λ by putting D'', D' on the left of a chamber $D^{(k)}$ in λ , where $D'' = D^{(k)}$ and D' is adjacent to $D^{(k)} = D''$. Let w' be the wall between $D^{(k)}$ and D' , and define

$$\gamma_k := (g_k \dots g_1 h)^{-1}.$$

Then $(w')^{\gamma_k}$ is an inner wall of $D_0 = (D^{(k)})^{\gamma_k}$. We choose an arbitrary element g' from $\text{Adj}((w')^{\gamma_k})$. Then we have $D' = D_0^{g'g_k \dots g_1 h}$. We make a word \mathbf{u}' by putting g'^{-1}, g' on the left of the letter g_k in \mathbf{u} . Then \mathbf{u}' is $\mathcal{R}_{\text{triv}}$ -equivalent to \mathbf{u} , and \mathbf{u}' belongs to $\mathcal{W}_{\mathcal{K}}(\lambda')$. \square

We say that a chamber loop λ as in (6.2) is *reduced to a chamber loop λ' by a type-II-move* and write $\lambda \Rightarrow_{\text{II}} \lambda'$ if there exists a subsequence

$$\rho = (D^{(m)}, \dots, D^{(k)}) \quad \text{with } m > k$$

in λ such that

- (i) $D^{(m)} = D^{(k)}$,
- (ii) ρ is a simple chamber loop with the base point $D^{(k)}$ around an inner face f of $D^{(k)}$ of codimension 2, and
- (iii) λ' is obtained from λ by removing the chambers $D^{(m-1)}, \dots, D^{(k)}$.

See Figure 6.3. We say that two chamber loops λ, λ' with the base point D_0 are *connected by a type-II-move* if either $\lambda \Rightarrow_{\text{II}} \lambda'$ or $\lambda' \Rightarrow_{\text{II}} \lambda$.

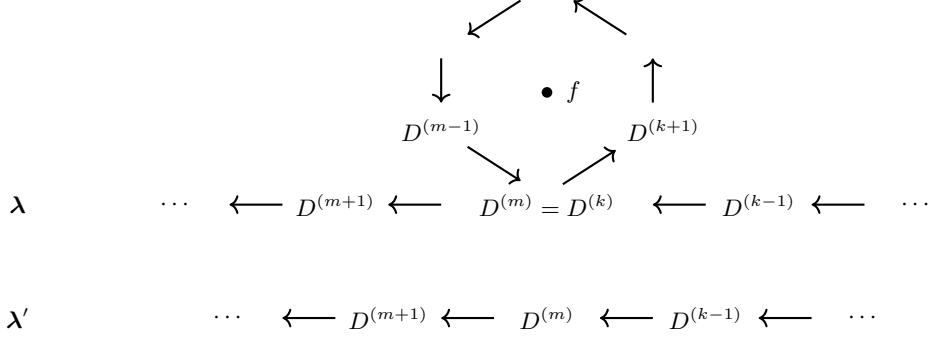
FIGURE 6.3. $\lambda \Rightarrow_{\text{II}} \lambda'$

Proposition 6.8. *Suppose that chamber loops λ and λ' with the base point D_0 are connected by a type-II-move. Then, for each word $\mathbf{u} \in \mathcal{W}_{\mathcal{K}}(\lambda)$, there exists a word $\mathbf{u}' \in \mathcal{W}_{\mathcal{K}}(\lambda')$ that is $(\mathcal{R}_{\text{triv}} \cup \mathcal{R}_{\text{face}})$ -equivalent to \mathbf{u} .*

Proof. Let λ be as in (6.2), and we put $\mathbf{u} = [g_N, \dots, g_1, h]$ with $g_0 = h$.

Suppose that $\lambda \Rightarrow_{\text{II}} \lambda'$ as is shown in Figure 6.3. Then $D^{(m)} = D^{(k)}$ implies

$$h' := g_m \cdots g_{k+1} \in \Gamma_0.$$

We define

$$\gamma_k := (g_k \cdots g_1 h)^{-1}.$$

Then f^{γ_k} is an inner face of D_0 , and the simple chamber loop $\rho = (D^{(m)}, \dots, D^{(k)})$ around f is mapped by γ_k to a simple chamber loop ρ^{γ_k} around f^{γ_k} with the base point D_0 . Moreover, the word $[g_m, \dots, g_{k+1}, 1]$ of gh-form is an element of $\mathcal{W}(\rho^{\gamma_k})$. In particular, we have

$$\{ [g_m, \dots, g_{k+1}, 1], [h'] \} \in \mathcal{R}_{\text{face}}.$$

Let \mathbf{u}' be a word obtained from \mathbf{u} by removing the letters g_m, \dots, g_{k+1} and replacing g_k by $h'g_k$. Then \mathbf{u}' is $(\mathcal{R}_{\text{triv}} \cup \mathcal{R}_{\text{face}})$ -equivalent to \mathbf{u} , and we have $\mathbf{u}' \in \mathcal{W}_{\mathcal{K}}(\lambda')$.

Conversely, suppose that $\lambda' \Rightarrow_{\text{II}} \lambda$. We assume that λ' is obtained from λ by putting a sequence $D'^{(n)}, \dots, D'^{(1)}$ on the left of a chamber $D^{(k)}$ in λ , where

$$\rho' = (D'^{(n)}, D'^{(n-1)}, \dots, D'^{(1)}, D'^{(0)}) \quad \text{with} \quad D'^{(n)} = D^{(k)} \quad \text{and} \quad D'^{(0)} := D^{(k)}$$

is a simple chamber loop around an inner face f of $D^{(k)}$. Again, we put $\gamma_k := (g_k \cdots g_1 h)^{-1}$. Then f^{γ_k} is an inner face of $D_0 = (D^{(k)})^{\gamma_k}$, and γ_k maps ρ' to a simple chamber loop ρ'^{γ_k} around the inner face f^{γ_k} of D_0 . Then $\mathcal{W}(\rho'^{\gamma_k})$ contains a word of the form

$$\mathbf{v} := [g'_n, \dots, g'_1, 1].$$

We have $m(\mathbf{v}) \in \Gamma_0$. Since $n > 0$, by replacing g'_n with $m(\mathbf{v})^{-1}g'_n$ if necessary, we can assume that

$$g'_n \cdots g'_1 = 1,$$

and we have $\{\mathbf{v}, [1]\} \in \mathcal{R}_{\text{face}}$. We make a word \mathbf{u}' from \mathbf{u} by putting g'_n, \dots, g'_1 on the left of the letter g_k in \mathbf{u} . Then \mathbf{u}' is $(\mathcal{R}_{\text{triv}} \cup \mathcal{R}_{\text{face}})$ -equivalent to \mathbf{u} , and \mathbf{u}' belongs to $\mathcal{W}_{\mathcal{K}}(\lambda')$. \square

Proof of Theorem 6.6. Let \mathbf{u} be a word in \mathcal{K} . We show that \mathbf{u} is $(\mathcal{R}_{\text{triv}} \cup \mathcal{R}_{\text{face}})$ -equivalent to an empty word $\varepsilon = []$. Since every word is $\mathcal{R}_{\text{triv}}$ -equivalent to a word of gh-form, we can assume that \mathbf{u} is of gh-form. Let $\lambda_0 := \lambda(\mathbf{u})$ be the chamber loop with the base point D_0 associated with \mathbf{u} . Since the nef-and-big cone N_X is simply connected, there exists a sequence

$$\lambda_0, \lambda_1, \dots, \lambda_n = (D_0)$$

of chamber loops with the base point D_0 such that, for $i = 1, \dots, n$, the two loops λ_{i-1} and λ_i are connected by either a type-I-move or a type-II-move, and that the last chamber loop λ_n is the loop (D_0) of length 0. Since $\mathbf{u} \in \mathcal{W}_{\mathcal{K}}(\lambda_0)$ and $\mathcal{W}_{\mathcal{K}}(\lambda_n) = \{[1]\}$, Propositions 6.7 and 6.8 imply that \mathbf{u} is $(\mathcal{R}_{\text{triv}} \cup \mathcal{R}_{\text{face}})$ -equivalent to $[1]$, and hence to ε . \square

REFERENCES

- [1] Scott Ahlgren and Ken Ono. Modularity of a certain Calabi-Yau threefold. *Monatsh. Math.*, 129(3):177–190, 2000.
- [2] Roger Apéry. Irrationalité de $\zeta(2)$ et $\zeta(3)$. Number 61, pages 11–13. 1979. Luminy Conference on Arithmetic.
- [3] M. J. Bertin and O. Lecacheux. Elliptic fibrations on the modular surface associated to $\Gamma_1(8)$. In *Arithmetic and geometry of K3 surfaces and Calabi-Yau threefolds*, volume 67 of *Fields Inst. Commun.*, pages 153–199. Springer, New York, 2013.
- [4] Marie José Bertin and Odile Lecacheux. Apéry-Fermi pencil of $K3$ -surfaces and 2-isogenies. *J. Math. Soc. Japan*, 72(2):599–637, 2020.
- [5] Marie José Bertin and Odile Lecacheux. Elliptic fibrations of a certain $K3$ surface of the Apéry-Fermi pencil. In *Publications mathématiques de Besançon. Algèbre et théorie des nombres. 2022*, volume 2022 of *Publ. Math. Besançon Algèbre Théorie Nr.*, pages 5–36. Presses Univ. Franche-Comté, Besançon, 2022.
- [6] F. Beukers and C. A. M. Peters. A family of $K3$ surfaces and $\zeta(3)$. *J. Reine Angew. Math.*, 351:42–54, 1984.
- [7] Richard Borcherds. Automorphism groups of Lorentzian lattices. *J. Algebra*, 111(1):133–153, 1987.
- [8] Richard E. Borcherds. Coxeter groups, Lorentzian lattices, and $K3$ surfaces. *Internat. Math. Res. Notices*, 1998(19):1011–1031, 1998.
- [9] Simon Brandhorst and Ichiro Shimada. Automorphism groups of certain Enriques surfaces. *Found. Comput. Math.*, 22(5):1463–1512, 2022.
- [10] J. H. Conway. The automorphism group of the 26-dimensional even unimodular Lorentzian lattice. *J. Algebra*, 80(1):159–163, 1983.
- [11] Elisa Dardanelli and Bert van Geemen. Hessians and the moduli space of cubic surfaces. In *Algebraic geometry*, volume 422 of *Contemp. Math.*, pages 17–36. Amer. Math. Soc., Providence, RI, 2007.
- [12] I. V. Dolgachev. Mirror symmetry for lattice polarized $K3$ surfaces. volume 81, pages 2599–2630. 1996. Algebraic geometry, 4.
- [13] Igor Dolgachev and Ichiro Shimada. 15-nodal quartic surfaces. Part II: the automorphism group. *Rend. Circ. Mat. Palermo (2)*, 69(3):1165–1191, 2020.
- [14] Dino Festi and Duco van Straten. Bhabha scattering and a special pencil of $K3$ surfaces. *Commun. Number Theory Phys.*, 13(2):463–485, 2019.
- [15] Shinobu Hosono, Bong H. Lian, Keiji Oguiso, and Shing-Tung Yau. Autoequivalences of derived category of a $K3$ surface and monodromy transformations. *J. Algebraic Geom.*, 13(3):513–545, 2004.
- [16] Shigeyuki Kondo. The automorphism group of a generic Jacobian Kummer surface. *J. Algebraic Geom.*, 7(3):589–609, 1998.
- [17] S. Mukai and H. Ohashi. The automorphism groups of Enriques surfaces covered by symmetric quartic surfaces. In *Recent advances in algebraic geometry*, volume 417 of *London Math. Soc. Lecture Note Ser.*, pages 307–320. Cambridge Univ. Press, Cambridge, 2015.

- [18] V. V. Nikulin. Integer symmetric bilinear forms and some of their geometric applications. *Izv. Akad. Nauk SSSR Ser. Mat.*, 43(1):111–177, 238, 1979. English translation: *Math USSR-Izv.* 14 (1979), no. 1, 103–167 (1980).
- [19] C. Peters. Monodromy and Picard-Fuchs equations for families of $K3$ -surfaces and elliptic curves. *Ann. Sci. École Norm. Sup. (4)*, 19(4):583–607, 1986.
- [20] C. Peters and J. Stienstra. A pencil of $K3$ -surfaces related to Apéry’s recurrence for $\zeta(3)$ and Fermi surfaces for potential zero. In *Arithmetic of complex manifolds (Erlangen, 1988)*, volume 1399 of *Lecture Notes in Math.*, pages 110–127. Springer, Berlin, 1989.
- [21] Ichiro Shimada. Projective models of the supersingular $K3$ surface with Artin invariant 1 in characteristic 5. *J. Algebra*, 403:273–299, 2014.
- [22] Ichiro Shimada. An algorithm to compute automorphism groups of $K3$ surfaces and an application to singular $K3$ surfaces. *Int. Math. Res. Not. IMRN*, (22):11961–12014, 2015.
- [23] Ichiro Shimada. Mordell–Weil groups and automorphism groups of elliptic $K3$ surfaces. *Rev. Mat. Iberoam.*, 40(4):1469–1503, 2024.
- [24] Ichiro Shimada. The automorphism group of an Apéry-Fermi $K3$ surface: Computational data. 2025. <https://doi.org/10.5281/zenodo.14842583>, <https://home.hiroshima-u.ac.jp/ichiro-shimada/ComputationData.html>.
- [25] The GAP Group. *GAP - Groups, Algorithms, and Programming*. Version 4.13.0 of 2024-03-15 (<http://www.gap-system.org>).
- [26] Bert van Geemen and Niels O. Nygaard. On the geometry and arithmetic of some Siegel modular threefolds. *J. Number Theory*, 53(1):45–87, 1995.
- [27] H. A. Verrill. The L -series of certain rigid Calabi-Yau threefolds. *J. Number Theory*, 81(2):310–334, 2000.
- [28] È.È. Vinberg and O. V. Shvartsman. Discrete groups of motions of spaces of constant curvature. In *Geometry, II*, volume 29 of *Encyclopaedia Math. Sci.*, pages 139–248. Springer, Berlin, 1993.

DEPARTMENT OF MATHEMATICS, GRADUATE SCHOOL OF SCIENCE, HIROSHIMA UNIVERSITY, 1-3-1 KAGAMIYAMA, HIGASHI-HIROSHIMA, 739-8526 JAPAN
Email address: ichiro-shimada@hiroshima-u.ac.jp