

Observation and mitigation of microwave echoes from dielectric defects in Josephson traveling wave amplifiers

Matteo Boselli, Joel Grebel, Ambroise Peugeot, Rémy Dassonneville,* Benjamin Huard, and Audrey Bienfait†
CNRS, ENS DE LYON, LPENSL, UMR5672, 69342 Lyon cedex 07, France

(Dated: March 4, 2025)

Amplifying microwave signals with a noise close to the minimum imposed by quantum mechanics is now routinely performed with superconducting quantum devices. In particular, Josephson-based Traveling Wave Parametric Amplifiers (JTWPA) have shown record bandwidth with added noise close to the quantum limit [1, 2]. In this work, we report the appearance of echo signals emitted by JTWPAs driven by trains of high-power pulses exceeding their dynamical range. These echoes have micro-second coherence and we attribute their origin to microscopic defects in the amplifier dielectric layer. By analyzing the power and the coherence of the echo signal as a function of temperature, we estimate the dielectric loss brought by these defects, and their impact on the JTWPA quantum efficiency. We introduce a mitigation technique (BLAST) to prevent the appearance of these echoes, consisting in an additional high-power tone sent concurrently with each pulse. We demonstrate that it suppresses the spurious defect signals and we recover the typical gain and noise figure within 95 % of their low-power values in 300 ns. These results can help to extend the use of JTWPAs in experiments where fast high-power sequences are necessary to generate weak microwave responses from the system under study, and also provide a path towards characterizing in-situ the dielectric losses of these devices.

Parametric amplification is now a widespread technique for efficiently measuring quantum microwave states [3] and generating squeezed states [4–7]. It is thus key for high-fidelity readout of qubits [8, 9] and for microwave quantum sensing [10–13]. Many amplifier designs have been explored, among which traveling-wave amplifiers based on Josephson junctions (JTWPAs) [1, 2] have demonstrated large gain over bandwidths exceeding 2 GHz, with added noise close to the quantum limit. These performances are reached when the signal strength is kept below the 1 dB compression point of these devices, about -100 dBm for current devices [1, 2]. This is a limitation when one would like to measure a signal along with a drive pulse exceeding this 1 dB compression point. Here, we show that the limitation also arises when the drive pulses are applied less than a few microseconds before the signal to be detected and also enter the JTWPA. This is typically the case when strong drive pulses are required to trigger a response from the system under study such as performing fast gates and readout for qubits [14], and pulse-probe experiments [15–19]. Here, we probe the dynamics of JTWPAs all provided by the Lincoln labs [1] in the context of a train of strong pulses to explore this limitation.

Namely, we observe the emergence of a delayed spurious signal in response to high-power pulses that we attribute to the collective coherent excitation of dielectric defects inside the JTWPA capacitors. This feature is dependent on temperature and vanishes for $T > 110$ mK, similarly to what is expected from dielectric echoes observed in spin glass physics [20–22]. By studying the

dynamics of this effect, we quantify an associated microwave absorption limiting the efficiency of the JTWPA [1, 23, 24]. To counteract the in-situ emission of these spurious signals, we propose and demonstrate two mitigation strategies. One strategy relies on interferometric cancellation of the drive pulses at the TWPA input. The other consists in adding an off-resonant pulse whose power is well above the 1 dB compression point of the JTWPA and of all other drive pulses. This pulse, that we call BLAST (BLinding for Amplification Suppression Technique), turns the JTWPA into a fully reflective device, preventing any signal from exciting the microscopic defects, thus avoiding the emission of the spurious echo. We observe that a transient period of 300 ns is necessary to recover the low-power behavior of the JTWPA after these BLAST pulses, a timing similar to the transient time needed to stabilize the JTWPA gain when powered on.

The JTWPAs we use are made up of a chain of Josephson junctions connected in series, and grounded through parallel-plate capacitors. The dielectric for these capacitors is a SiO₂ and NbO_x bilayer [1]. Every three Josephson junctions, a LC resonator is added to ensure quasi-phase matching between a signal at frequency ω_d and a pump tone at frequency ω_p , ensuring that a four-wave amplification process takes place constructively all along the chain, yielding a gain of about 20 dB over a bandwidth larger than 2 GHz when the amplification pump tone is present. These resonators also create a dispersive gap which prevents transmission through the JTWPA over ~ 100 MHz band at the center of the frequency gain profile.

The JTWPA is inserted in a typical setup for quantum microwave experiments (Fig 1c and Appendix A). It is anchored at the base plate of a dilution refrigerator,

* Present address: CNRS, AIX-MARSEILLE UNIV., UNIVERSITY OF TOULON, IM2NP, UMR5672, 13013 Marseille, France

† audrey.bienfait@ens-lyon.fr

whose temperature T is varied from 8 mK to 110 mK. Any signal of drive frequency ω_d , such as could be emitted from a device under test (DUT), enters through the JTWPA after combination with the amplification pump tone using a directional coupler. After the JTWPA, the signal is routed to a high electron mobility transistor (HEMT) amplifier through two isolators, followed by room-temperature amplification and heterodyne demodulation, allowing to access the I and Q quadratures of the signal. In the following, we excite the JTWPA only through the pump line.

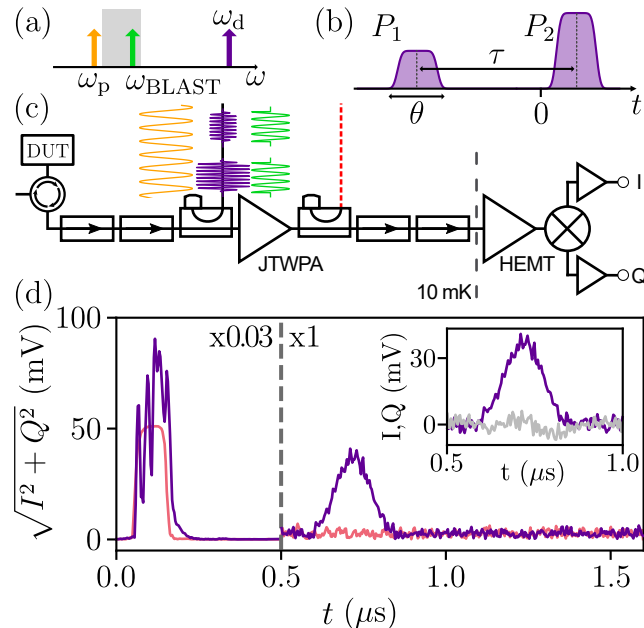

FIG. 1. (a) Frequencies of the experimental tones compared to the dispersive feature of the JTWPA (gray): JTWPA pump tone at ω_p (orange), BLAST tone at ω_{BLAST} (green), driving tone at ω_d (purple). The drive can be at any frequency within the 4-8 GHz bandwidth of the isolators, whereas the pump and BLAST tones lie close to the JTWPA dispersive feature. (b) Two pulse sequence. (c) The pulses are directed either at the input of the JTWPA (purple) or at the input of a HEMT amplifier (red) using directional couplers. The transmitted signals are amplified by room-temperature amplifiers and demodulated. (d) Detected signal amplitude when sending the two pulses at frequency $\omega_d/(2\pi) = 7$ GHz through the JTWPA (purple, device D1) or through the HEMT (light red), showing the transmitted second pulse at $t \sim 0.1 \mu\text{s}$ and a spurious signal appearing a time $\tau = 0.55 \mu\text{s}$ later only when going through the JTWPA. We have applied a scaling factor $\times 0.03$ during the first period of the trace. In the inset, spurious signal I (purple) and Q (gray) quadratures.

We use a drive sequence at frequency ω_d comprising two pulses P_1 and P_2 of length θ separated by an interval τ (Fig. 1b), akin to a Hahn echo experiment in magnetic resonance. Unless specified otherwise, each pulse is a flat-top pulse of length $\theta=100$ ns with a rise time of 20 ns and we do not apply any pump tone to the JTWPA. In Fig. 1d, we observe that when this two-pulse sequence is

sent to the JTWPA, it triggers the emission of a spurious signal of Gaussian shape. The powers of the pulses are set to $P_1 = -81$ dBm and $P_2 = -75$ dBm, referred to the JTWPA input. To check whether this signal is solely due to the JTWPA, we reroute this probe directly through the HEMT. Even using higher powers ($P_{1(2)}^{\text{max}} = -50$ dBm at the HEMT input), we do not observe this spurious signal. As the spurious signal is dominantly emitted on a single quadrature (see inset of Fig. 1b), in the following we post-process all signals to only keep this quadrature of interest I , and compute a mean average signal \bar{I} (see Appendix C).

To identify the origin of these spurious signals, we explore different pulse powers, delays, and devices. We first note that we observe such signals on three different devices D1, D2, D3 that respectively have dispersive features centered on 6.14 GHz, 6.12 GHz and 7.94 GHz. When sweeping the delay τ between the pulses, we see a decay of the integrated signal. We first fit this decay with a simple exponential $A_0 e^{-(2\tau/T_2)}$, extracting a coherence time $T_2^{\text{D1}} = 2.55(2) \mu\text{s}$, $T_2^{\text{D2}} = 3.50(2) \mu\text{s}$ and $T_2^{\text{D3}} = 3.42(2) \mu\text{s}$ for each device, for data acquired at $T = 8$ mK. When increasing the temperature we observe that the coherence time is reduced: for instance, $T_2^{\text{D3}} = 0.61(3) \mu\text{s}$ at $T = 90$ mK. The amplitude of the signal also depends on the power of the pulses. While keeping P_2 fixed in inset of Fig. 2a, we observe that \bar{I} oscillates as a function of P_1 as in a Rabi experiment for one or several two-level systems (TLS). We only observe up to one or two oscillations, indicating either a very short Rabi coherence time or a large spread in couplings in the TLS responding to the sequence [25]. In all devices, we observe the presence of this signal in the 4 to 8 GHz frequency range accessible in our setup, at frequencies both above and below the JTWPA dispersive features, with its coherence decreasing for higher ω_d (see Fig. 2c).

From these experimental observations, we attribute the physical origin of the echo signal to microscopic defects in the JTWPA dielectric layer. Similar signals have already been observed in dielectrics (also called spin glass) at low-temperature since the 1960s, using acoustic [20, 21] or microwave drives [22, 26, 27]. These signals were first explored to explain the anomalous heat coefficient of amorphous dielectrics at low temperature, and attributed to microscopic defects. To model these defects and their resulting echoes, the standard tunneling model was put forward [21]. Later on, this model was extended to explain the absorption of microwave radiation by microscopic defects [28–30], known to limit the performances of superconducting resonators and qubits [31]. In the context of parametric amplification, beyond limiting the quantum efficiency, TLS have been proposed to explain the power behavior of intermodulation products [32].

A single defect can be modeled as a two-level-system with Hamiltonian $H/\hbar = \frac{\Delta}{2}\sigma_z + \frac{\Delta_0}{2}\sigma_x$ where Δ is the energy splitting between the two levels, and Δ_0 the tunneling barrier between the two states. From this model, the TLSs respond to the same Bloch equations as spins

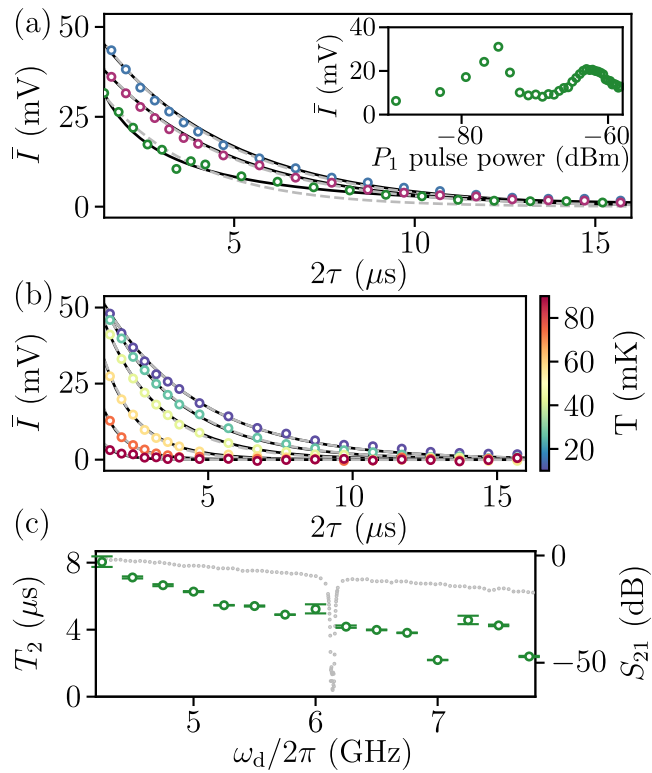

FIG. 2. (a) Mean echo amplitude \bar{I} as versus delay 2τ between P_1 and the echo. The measurements are performed at temperature $T = 8$ mK and $\omega_d = 7.0$ GHz on device D1 (green), D2 (blue) and D3 (pink). Lines are fit either using a simple exponential model (gray dashes) or using the spectral diffusion model discussed in the main text (black). In inset, average echo amplitude \bar{I} versus P_1 pulse peak power, with $P_2 = -77$ dBm for JTWPA D1. (b) Mean echo amplitude \bar{I} versus delay 2τ measured on device D3 at $T = 10$ mK, 18 mK, 26 mK, 40 mK, 60 mK and 90 mK. Gray dotted lines, simple exponential fit. Black lines, spectral diffusion model. (c) Hahn echo decay time T_2 as a function of ω_d . Gray dots, measured transmission amplitude profile through device D1 including the contribution of the lines

and are thus expected to produce echoes when probed with Hahn echo sequences [21]. In a material, a wide distribution of resonant frequencies ($\omega_0 = \sqrt{\Delta_0^2 + \Delta^2}$) is expected ranging from zero frequency to some finite cut-off value which depends on the specific nature of the TLS and the properties of the host dielectric [21, 33]. It would thus fit well with our observations over the entire 4-8 GHz band. Another key feature of these dielectric echoes is that their dynamics is largely governed by spectral diffusion, which is strongly temperature-dependent. When the ensemble of TLSs is sufficiently concentrated, TLS-TLS dipolar interactions play a strong role in the decay of the transverse coherence created by the P_1 pulse, and can take place not only between resonant TLSs, but also off-resonant TLSs. When considering their effect, it is interesting to consider the polarization of the ensemble of TLSs: at the frequency of our drive ω_d (TLSs A), we

JTWPA	$\Gamma_2^{\text{eff}}/2\pi$ (kHz)	$\Gamma_{\text{SD}}^{T \rightarrow \infty}/2\pi$ (kHz)	$\Gamma_1^{\text{ph,B}}/2\pi$ (kHz)	$W_{\text{ex}}/2\pi$ (MHz/K)	$\omega_b/2\pi$ (GHz)
D2	32(3)	468(34)	161(16)	2.9(4)	2.3(2)
D3	33(2)	586(46)	187(19)	3.0(4)	2.4(2)

TABLE I. Fit results for the spectral diffusion model discussed in the main text.

expect the TLSs that we probe to be fully polarized at the temperature $T \ll \hbar\omega_d/k_B$ we operate at. However, lower frequency TLS (TLSs B) are thermally excited, so that their random flips induce uncontrollable frequency shifts on the TLS resonantly excited by the initial pulse P_1 . Namely, the spectral distribution of excited TLSs by P_1 will widen inexorably with time, provided the TLS concentration is high enough. Among spectral diffusion models [34, 35] we make use of an uncorrelated jump model [36] to capture temperature dependence of the decoherence (see Appendix B). In this model where TLSs A are assumed identical and similarly coupled to the bath of identical thermally excited TLSs B, the dipolar diffusion rate is given by:

$$\Gamma_{\text{sd}} = \frac{2\pi}{9\sqrt{3}\hbar\epsilon} d_A d_B c_B \text{sech}^2(\hbar\omega_B/(2k_B T)) \quad (1)$$

where ϵ is the permittivity of the dielectric material, d_A , d_B are the mean dipole moments of TLS A and B and c_B is the concentration of B TLSs. The hyperbolic secant term expresses that only B TLSs that have flipped participate to spectral diffusion: at low temperature ($\hbar\omega_B \ll k_B T$) the process is frozen, while it reaches its maximum rate Γ_{sd}^0 at large temperature. The Hahn echo amplitude measured at temperature T is given by:

$$A(2\tau, T) = A_0 e^{-2\Gamma_2^{\text{int}}(T)\tau} e^{-\Gamma_{\text{sd}}\alpha(2\tau, W)}. \quad (2)$$

Here, A_0 is the initial echo amplitude. The first exponential captures the action of an intrinsic decoherence process of rate $\Gamma_2^{\text{int}}(T) = \Gamma_2^* + \Gamma_1^{\text{int}}(T)/2$ that we decompose into a fixed intrinsic rate Γ_2^* and its limitation by energy relaxation Γ_1^{int} . The latter has two contributions: single-phonon relaxation, characterized by the rate $\Gamma_1^{\text{ph,A}} \coth(\hbar\omega_A/(2k_B T))$, and a TLS interaction with rate $W_{\text{ex}} \cdot T$ [28, 37]. The second exponential expresses the spectral diffusion effect, where $\alpha(2\tau, W)$ is a function that averages over all the possible flip histories of TLSs B and it is strongly dependent on the jump rate W of TLSs B (see Appendix B). We assume this rate is set only by a single-phonon relaxation process $W = \Gamma_1^{\text{ph,B}} \coth(\hbar\omega_B/(2k_B T))$ [21, 29].

To quantify this spectral diffusion effect, we measure Hahn-echo decays for temperatures ranging from 8 mK to 110 mK above which the signal is too weak to be measured. We perform a global fit over all temperatures traces we have measured by taking Γ_{sd}^0 , ω_B , $\Gamma_1^{\text{ph,B}}$, W_{ex} and Γ_2^{eff} as global free fit parameters (see Appendix D), where we have considered $\Gamma_2^{\text{eff}} = \Gamma_2^* + \Gamma_1^{\text{ph,A}}/2$ as a single variable whose temperature dependence can be neglected since

$\hbar\omega_A \gg k_B T$. The resulting fit for various devices and temperatures is shown in Fig. 2a and Fig. 2b (see also Appendix D), with the fit values given in Table I. It successfully captures the decaying echo signal, with a marginal difference compared to a single-exponential fit. This is explained by the fact that we are in a regime where the spectral diffusion is neither slow ($W\tau \ll 1$ where τ^2 dependence would be expected) nor fast ($W\tau \gg 1$ where $\sqrt{\tau}$ dependence would be expected)[21]. Comparing the coherence time extracted using a simple exponential fit (squares in Fig. 3a) to what is expected from our spectral diffusion model (dashed lines, with T_2^{sd} estimated using $A(T_2^{\text{sd}}, T)/A_0 = 1/e$), we find a rather good match for their temperature dependence. The temperature dependence of the spectral diffusion also gives a precise indication about the effective frequency of bath B $\omega_b/(2\pi) = 2.3(2)$ GHz.

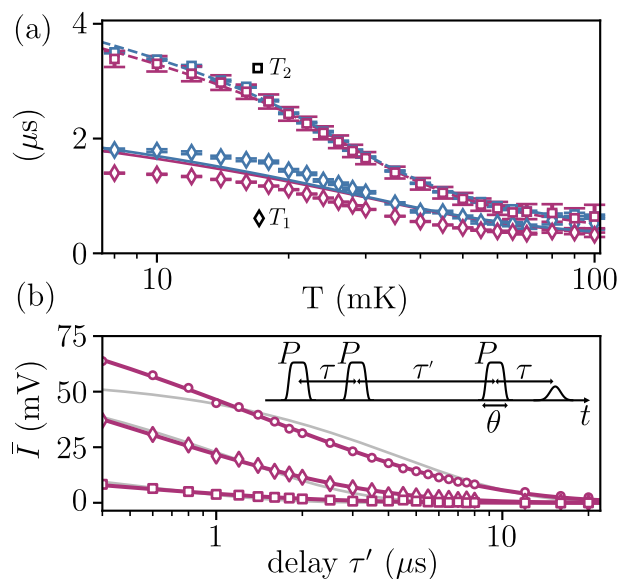

FIG. 3. (a) Extracted T_1 (diamonds) and T_2 (squares) versus T for JTWPA D2 (blue) and D3 (purple). Values for T_2 are obtained by a simple exponential fit while T_1 values are obtained from a stretched exponential fit. Lines are fit using the spectral diffusion model for device D2 (blue) and D3 (pink): dashes for predicted T_2 and solid lines for predicted T_1 assuming $\Gamma_1^{\text{int}} = 2\Gamma_2^{\text{int}}$. (b) Mean echo amplitude \bar{I} versus delay τ' for JTWPA D3 using a stimulated echo sequence (inset), with $\tau = 0.55 \mu\text{s}$ and $\theta = 100 \text{ ns}$ for 8 mK (circles), 40 mK (diamonds) and 80 mK (squares). Lines correspond to stretched exponential fit (purple) and to spectral diffusion model (gray).

We now investigate the longitudinal relaxation time T_1 associated to these defects, see Fig. 3b. We use a three pulse sequence as for stimulated Hahn echo experiments [38]. It consists of three identical pulses at frequency $\omega_d/2\pi = 7 \text{ GHz}$ with power of -77 dBm (-81 dBm) at the JWTPA D2 (D3) input separated by delay $\tau = 0.55 \mu\text{s}$ and τ' . The first pulse creates an initial transverse coherence which is partially conver-

ted to a polarization by the second pulse. The polarization decays through T_1 processes during τ' , and is converted back to a transverse coherence by the third pulse. Waiting an additional time τ enables to refocus the dipoles and to generate an echo whose amplitude is governed by both waiting times. Sweeping the delay τ' between the second and third pulse monitors the polarization decay through the echo amplitude. Observed decays at 8 mK, 40 mK and 80 mK are shown in Fig. 3b. These decays are no longer simple exponential, but fit well to a stretched exponential $A \exp(-(t/T_1)^p)$ with $p_{D2} = 0.606(5)$ and $p_{D3} = 0.547(6)$. This is characteristic of dynamics governed by spectral diffusion. The fitted values of T_1 show a similar trend in temperature as T_2 , with a decrease of T_1 around 30 mK (see Fig. 3a).

The same sudden jump model we used for Hahn echo decay can also model the stimulated echo amplitude:

$$A^{\text{se}}(\tau', T) = A_0^{\text{se}}(T) e^{-\Gamma_1^{\text{int}}(T)\tau'} e^{-\Gamma_{\text{sd}}\beta(\tau, \tau', W)}. \quad (3)$$

Here, A_0^{se} is the initial amplitude and the first exponential captures the intrinsic energy decay described above. The second exponential accounts solely for the effect of spectral diffusion with β a function taking into account the jump history similarly to α [36], and is fully determined by the fit of the Hahn echo signals. We fit our data with this model, with $\Gamma_1^{\text{ph,A}}$ a global free fit parameter while A_0^{se} is adjusted for each trace. The other parameters are taken from the fit of the two-pulses experimental data. In Fig. 3b, we show this fit for $T = 8 \text{ mK}$, 40 mK and 80 mK. The model provides a good fit at high temperatures, but it degrades at lower temperature. This can also be seen when comparing the decay rates: similarly to T_2 , we can extract the T_1 values from our model using the relation $A^{\text{se}}(T_1)/A_0^{\text{se}} = 1/e$, solid lines in Fig. 3a. The comparison of the full model with the simple stretch exponential rates indicates that another intrinsic relaxation mechanism plays a stronger role at lower temperatures.

The presence of these microscopic dielectric defects represents a source of dissipation for the JTWPA that ultimately degrades the signal to noise ratio at its output, and namely its efficiency η [1, 23, 24, 39]. Indeed, assuming a distributed loss model and that amplification is constant across all JTWPA cells, one finds $\eta = \frac{2g-ga-1}{ga-1}$, where a and g are respectively the absorption and gain per JTWPA cell [1]. This efficiency is only an upper bound, since there exists others limiting effects such as parasitic reflections [40] and hot environments [41]. Assuming all losses per cell are due to the defects in the dielectric capacitor, one can express a as a function of $\tan \delta$ (see Appendix E). The dielectric losses at zero temperature can be related to the concentration of TLS through $\tan \delta = \frac{4\pi^2}{3\epsilon} N_0 d_A^2 \tanh(\frac{\hbar\omega_A}{2k_B T})$ [26, 28], where N_0 is the number of TLS per unit of volume and per unit of energy.

We now assess whether these dielectric echoes offer a way to calibrate in-situ the dielectric losses, namely whether we can evaluate finely N_0 and d_A . One first

possibility is to use spectral diffusion since the underlying effect is the dipolar interaction between TLSs of bath A and of bath B, see Eq. 1. At the price of three approximations, we can compute $\tan \delta$ from Γ_{sd} . First, we assume the TLS distribution follow the universal law $N(\Delta, \Delta_0) = \frac{N_0}{\Delta_0}$ [21, 42] so that we can consider TLSs A and B to have the same concentration. Second, we can reasonably consider that the mean dipoles of TLSs A and TLSs B are of equal strength [26, 42]. Last, a hypothesis on the spectral width γ_B of the TLSs B contributing to spectral diffusion is needed to relate N_0 to c_B through $N_0 = c_B / (\hbar \gamma_B)$. Given that we expect TLSs to be everywhere, and only TLSs of non-zero polarization can contribute to spectral diffusion, we can roughly estimate that the spectral width of the TLSs B bath is set by their thermal energy so that $\gamma_B \sim \omega_B$. We thus find $\tan \delta = \frac{6\sqrt{3}\pi\Gamma_{\text{SD}}(T \rightarrow \infty)}{\omega_B} = 0.007$, and $\eta = 0.8$ for JTWPA D2, which seems compatible with previous reported values [1]. The uncertainty on these two values comes from the fit of our spectral diffusion model, and are highly optimistic (1×10^{-5}) compared to the level of confidence of our assumptions.

Another approach is to quantify N_0 and d_A using directly the two-pulse echo signal. To estimate these quantities, we model the bath of TLS A as an ensemble of TLSs coupled to a transmission line, where each TLS has a radiative coupling to the line Γ_R . When applying a pulse of amplitude $|\alpha_{\text{in}}| = \sqrt{\frac{P_{\text{in}}}{\hbar\omega_d}}$ and of length θ , a resonant TLS undergoes Rabi rotations at rate $\Omega = 2\sqrt{\Gamma_R}|\alpha_{\text{in}}|$. Using our experimental observation of Rabi oscillations in Fig. 2a, we can thus determine the value of Γ_R . Another way of expressing this Rabi oscillation is through $\hbar\Omega = d_A E_d$, where E_d is the strength of the driving electrical field applied on the capacitor. Using this relation, we find $d_A = 3(1)\text{D}$. This value is compatible with what is expected for OH^- impurities [27, 43] in silica. Next, we can estimate that the peak echo amplitude is proportional to the number of excited TLSs, so that $|\alpha_{\text{out}}| = (N_0 V \gamma_A) \sqrt{\Gamma_P}$ where $V = 1.5 \times 10^{-13} \text{m}^3$ is the volume of the capacitors comprising the JTWPA chain [1], and $\gamma_A = 1/\theta$ is the bandwidth of excited TLSs, given by the duration of the first pulse. The precision of this technique suffers from our lack of precise power calibration and from non-canonical Rabi oscillations. We find $N_0 = 3(2) \times 10^{43} \text{J}^{-1} \text{m}^{-3}$, which lies close to values reported in the literature for amorphous materials [42, 44]. In this case, we find $\tan \delta = 18(16) \times 10^{-4}$ and $\eta = 0.94(5)$ for JTWPA D1. Here the uncertainties are governed by the quality of the calibration of our lines. Despite the strong assumptions in both techniques, we find that they lie close to previously reported estimations, indicating that with additional characterization and modeling, these dielectric echoes could become an in-situ technique for characterizing dielectric losses in a JTWPA.

We now present solutions for removing these dielectric echoes that can be detrimental to experiments. Our glo-

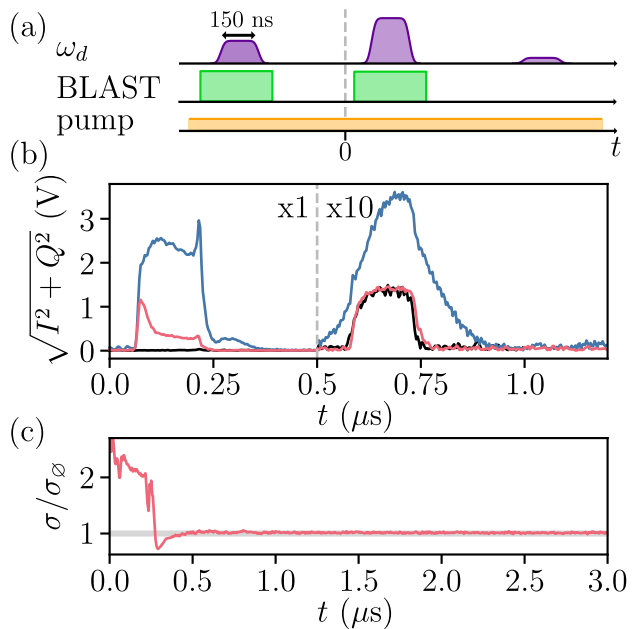

FIG. 4. (a) BLAST pulse sequence. We use square pulses for the BLAST tone and flat-top pulses 150 ns long with 20 ns rise time. The pump tone is always active. (b) Measured amplitude versus time when sending only the probe signal pulse (black) at $\omega_d/2\pi = 7$ GHz, or the two pulse sequence at $P_1 = -85$ dBm and $P_2 = -79$ dBm at ω_d along with the probe signal (blue) or when including on top the BLAST sequence, here at $\omega_{\text{BLAST}} = 6.14$ GHz (red) and $P_{\text{BLAST}} = -55$ dBm at the JTWPA input. (c) Ratio between the signal standard deviation σ when performing BLAST and when no input pulses are applied σ_\emptyset . The standard deviation is calculated using $\sigma = \sqrt{\sigma_I^2 + \sigma_Q^2}$, where $\sigma_X(t)$ is the standard deviation of all voltages recorded on quadrature X at time t : $\sigma_X^2 = \langle X(t)^2 - \bar{X}^2(t) \rangle$. Gray shadow, normalized reference standard deviation when no pulses are applied taking into account fluctuations from measurement to measurement due to room temperature setup drifts.

bal strategy relies on preventing the pulses from reaching the JTWPA. One possibility is to perform interferometric cancellation of the high power pulses [45]. While feasible (see Appendix H), it finely depends on all the components in the microwave setup, requiring constant recalibration to account for temporal drifts in their response. We develop a second, more resilient protocol which can be complementary to interferometric pulses. It consists in using a microwave tone of far greater power (25 dB) than our high-power pulses (from -85 to -75 dBm), or JTWPA pump (-82 dBm). Such a high-power BLAST pulse turns the JTWPA into a pure reflective device (see Appendix F), which can be used for preventing high-power pulses from entering the amplifier, and thus from generating this spurious signal. We now want to test whether BLAST pulses sent concurrently with the train of pulses used previously (Fig. 4a) can help recover routine performance of the JTWPA. We thus send a test signal of power -125 dBm, much weaker

than the JTWPA saturation threshold, after the Hahn echo sequence, where we typically observe the echo. Without using the BLAST pulses, we observe the echo on top of this weak signal (blue curve in Fig. 4b), whereas adding the BLAST pulses to the sequence (red) allows to recover the signal expected when sending only the weak probe (black). We realize this experiment in presence of the JTWPA amplification pump tone, demonstrating that these BLAST pulses do not degrade the JTWPA gain. We also probe the noise observed on each quadrature throughout the sequence, detecting no additional noise after a 300 ns recovery time consecutive to the last BLAST pulse. Similarly to the JTWPA amplification tone, the precise frequency of the BLAST pulse does not require a very fine calibration for this shielding effect to occur, and its power needs only be sufficient to make the JTWPA reflective (see Appendix G).

In short, our results evidence the presence of dielectric echoes in the JTWPA due to microscopic defects in the JTWPA dielectric layers. These echoes need to be taken into account in many experiments, but can be simply avoided through the application of a BLAST pulse. By analyzing the strength of these echoes signals and their time dynamics using a spectral diffusion model, we can also estimate the internal losses they induce in the JT-

WPA and the limit they impose on quantum efficiency, leading the way for these measurements to become an additional in-situ characterization technique for JTWPAs. Future experiments could probe traveling-wave amplifiers beyond the 4 to 8 GHz range studied here to compare with other experimental results [46, 47]. It would allow to access for the first time the frequency distribution of these microscopic defects. In addition, it would be interesting to check whether it is possible to correlate these dynamics to effects on other quantities such as the intermodulation product, or to material changes in JTWPA devices.

ACKNOWLEDGMENTS

This work was supported by the European Union (ERC, INDIGO, 101039953) and by the ARO GASP (contract No. W911-NF23-10093) program. We acknowledge IARPA and Lincoln Labs for providing us with Josephson Traveling-Wave Parametric Amplifiers. We thank William Oliver, Alexis Coissard, Romain Albert, Luca Planat and Nicolas Roch for fruitful discussions.

-
- [1] C. Macklin, K. O'Brien, D. Hover, M. E. Schwartz, V. Bolkhovskiy, X. Zhang, W. D. Oliver, and I. Siddiqi, A near-quantum-limited Josephson traveling-wave parametric amplifier, *Science* **350**, 307 (2015).
 - [2] L. Planat, A. Ranadive, R. Dassonneville, J. Pueras Martínez, S. Léger, C. Naud, O. Buisson, W. Hasch-Guichard, D. M. Basko, and N. Roch, Photonic-Crystal Josephson Traveling-Wave Parametric Amplifier, *Physical Review X* **10**, 021021 (2020).
 - [3] A. A. Clerk, M. H. Devoret, S. M. Girvin, F. Marquardt, and R. J. Schoelkopf, Introduction to quantum noise, measurement, and amplification, *Rev. Mod. Phys.* **82**, 1155 (2010).
 - [4] N. Bergeal, F. Schackert, M. Metcalfe, R. Vijay, V. E. Manucharyan, L. Frunzio, D. E. Prober, R. J. Schoelkopf, S. M. Girvin, and M. H. Devoret, Phase-preserving amplification near the quantum limit with a Josephson ring modulator, *Nature* **465**, 64 (2010).
 - [5] A. L. Grimsmo and A. Blais, Squeezing and quantum state engineering with Josephson travelling wave amplifiers, *npj Quantum Information* **3**, 20.
 - [6] M. Esposito, A. Ranadive, L. Planat, S. Leger, D. Fraudet, V. Jouanny, O. Buisson, W. Guichard, C. Naud, J. Aumentado, F. Lecocq, and N. Roch, Observation of Two-Mode Squeezing in a Traveling Wave Parametric Amplifier, *Physical Review Letters* **128**, 153603 (2022).
 - [7] J. Y. Qiu, A. Grimsmo, K. Peng, B. Kannan, B. Lienhard, Y. Sung, P. Krantz, V. Bolkhovskiy, G. Calusine, D. Kim, A. Melville, B. M. Niedzielski, J. Yoder, M. E. Schwartz, T. P. Orlando, I. Siddiqi, S. Gustavsson, K. P. O'Brien, and W. D. Oliver, Broadband squeezed microwaves and amplification with a Josephson travelling-wave parametric amplifier, *Nature Physics* **19**, 706 (2023).
 - [8] R. Vijay, D. H. Slichter, and I. Siddiqi, Observation of Quantum Jumps in a Superconducting Artificial Atom, *Phys. Rev. Lett.* **106**, 110502 (2011).
 - [9] J. Stehlik, Y.-Y. Liu, C. M. Quintana, C. Eichler, T. R. Hartke, and J. R. Petta, Fast charge sensing of a cavity-coupled double quantum dot using a Josephson parametric amplifier, *Phys. Rev. Appl.* **4**, 014018 (2015).
 - [10] J. D. Teufel, T. Donner, D. Li, J. W. Harlow, M. S. Allman, K. Cicak, A. J. Sirois, J. D. Whittaker, K. W. Lehnert, and R. W. Simmonds, Sideband cooling of micro-mechanical motion to the quantum ground state, *Nature* **475**, 359 (2011).
 - [11] D. M. P. Smith, L. Bakker, R. H. Witvers, B. E. M. Woestenburg, and K. D. Palmer, Low noise amplifier for radio astronomy, *International Journal of Microwave and Wireless Technologies* **5**, 453 (2013).
 - [12] C. Bockstiegel, J. Gao, M. R. Vissers, M. Sandberg, S. Chaudhuri, A. Sanders, L. R. Vale, K. D. Irwin, and D. P. Pappas, Development of a Broadband NbTiN Traveling Wave Parametric Amplifier for MKID Readout, *Journal of Low Temperature Physics* **176**, 476 (2014).
 - [13] A. Bienfait, J. J. Pla, Y. Kubo, M. Stern, X. Zhou, C. C. Lo, C. D. Weis, T. Schenkel, M. L. W. Thewalt, D. Vion, D. Esteve, B. Julsgaard, K. Mølmer, J. J. L. Morton, and P. Bertet, Reaching the quantum limit of sensitivity in electron spin resonance, *Nat. Nanotechnol.* **11**, 253 (2015).
 - [14] P. Krantz, M. Kjaergaard, F. Yan, T. P. Orlando, S. Gustavsson, and W. D. Oliver, A quantum engineer's guide to superconducting qubits, *Applied Physics Reviews* **6**, 021318 (2019).

- [15] B. Albanese, S. Probst, V. Ranjan, C. W. Zollitsch, M. Pechal, A. Wallraff, J. J. L. Morton, D. Vion, D. Esteve, E. Flurin, and P. Bertet, Radiative cooling of a spin ensemble, *Nature Physics* **16**, 751.
- [16] C. Bartram, T. Braine, R. Cervantes, N. Crisosto, N. Du, G. Leum, P. Mohapatra, T. Nitta, L. J. Rosenberg, G. Rybka, J. Yang, J. Clarke, I. Siddiqi, A. Agrawal, A. V. Dixit, M. H. Awida, A. S. Chou, M. Hollister, S. Knirck, A. Sonnenschein, W. Wester, J. R. Gleason, A. T. Hipp, S. Jois, P. Sikivie, N. S. Sullivan, D. B. Tanner, E. Lentz, R. Khatiwada, G. Carosi, C. Cisneros, N. Robertson, N. Woollett, L. D. Duffy, C. Boutan, M. Jones, B. H. LaRoque, N. S. Oblath, M. S. Taubman, E. J. Daw, M. G. Perry, J. H. Buckley, C. Gaikwad, J. Hoffman, K. Murch, M. Goryachev, B. T. McAllister, A. Quiskamp, C. Thomson, M. E. Tobar, V. Bolkhovskiy, G. Calusine, W. Oliver, and K. Serniak, Dark matter axion search using a Josephson Traveling wave parametric amplifier, *Review of Scientific Instruments* **94**, 044703 (2023).
- [17] M. Casariego, E. Zambrini Cruzeiro, S. Gherardini, T. Gonzalez-Raya, R. André, G. Frazão, G. Catto, M. Möttönen, D. Datta, K. Viisanen, J. Govenius, M. Prunnila, K. Tuominen, M. Reichert, M. Renger, K. G. Fedorov, F. Deppe, H. van der Vliet, A. J. Matthews, Y. Fernández, R. Assouly, R. Dassonneville, B. Huard, M. Sanz, and Y. Omar, Propagating quantum microwaves: Towards applications in communication and sensing, *Quantum Science and Technology* **8**, 023001 (2023).
- [18] A. Youssefi, S. Kono, M. Chegnizadeh, and T. J. Kippenberg, A squeezed mechanical oscillator with millisecond quantum decoherence, *Nature Physics* **19**, 1697 (2023).
- [19] E. Rej, R. Cutting, D. Datta, N. Tiencken, J. Govenius, V. Vesterinen, Y. Liu, and M. A. Sillanpää, Near-ground state cooling in electromechanics using measurement-based feedback and Josephson parametric amplifier (2024), arXiv:2403.02319 [quant-ph].
- [20] B. Golding and J. E. Graebner, Phonon Echoes in Glass, *Physical Review Letters* **37**, 852 (1976), publisher: American Physical Society.
- [21] J. L. Black and B. I. Halperin, Spectral diffusion, phonon echoes, and saturation recovery in glasses at low temperatures, *Physical Review B* **16**, 2879 (1977), publisher: American Physical Society.
- [22] L. Bernard, L. Piche, G. Schumacher, J. Joffrin, and J. Graebner, Electric dipolar echoes in glasses, *Journal de Physique Lettres* **39**, 126 (1978), publisher: Les Editions de Physique.
- [23] M. Houde, L. Govia, and A. Clerk, Loss Asymmetries in Quantum Traveling-Wave Parametric Amplifiers, *Physical Review Applied* **12**, 034054 (2019), publisher: American Physical Society.
- [24] Y. Yuan, M. Haider, and C. Jirauschek, Quantum Master Equation for a Lossy Josephson Traveling-Wave Parametric Amplifier, in *2022 IEEE International Topical Meeting on Microwave Photonics (MWP)* (2022) pp. 1–4.
- [25] A. J. Sigillito, H. Malissa, A. M. Tyryshkin, H. Riemann, N. V. Abrosimov, P. Becker, H.-J. Pohl, M. L. W. Thewalt, K. M. Itoh, J. J. L. Morton, A. A. Houck, D. I. Schuster, and S. A. Lyon, Fast, low-power manipulation of spin ensembles in superconducting microresonators, *Appl. Phys. Lett.* **104**, 222407 (2014).
- [26] M. Von Schickfus and S. Hunklinger, Saturation of the dielectric absorption of vitreous silica at low temperatures, *Physics Letters A* **64**, 144 (1977).
- [27] G. Baier and M. v. Schickfus, Dielectric rotary echoes in vitreous silica, *Phys. Rev. B* **38**, 9952 (1988).
- [28] A. L. Burin, J. M. Leveritt, G. Ruyters, C. Schötz, M. Bazrafshan, P. Fassel, M. v. Schickfus, A. Fleischmann, and C. Enss, Low-temperature dipolar echoes in amorphous dielectrics: Significance of relaxation and decoherence free two-level systems, *Europhysics Letters* **104**, 57006 (2013), publisher: EDP Sciences, IOP Publishing and Società Italiana di Fisica.
- [29] A. L. Burin, S. Matityahu, and M. Schechter, Low-temperature $1/f$ noise in microwave dielectric constant of amorphous dielectrics in Josephson qubits, *Physical Review B* **92**, 174201 (2015), publisher: American Physical Society.
- [30] C. Müller, J. H. Cole, and J. Lisenfeld, Towards understanding two-level-systems in amorphous solids: insights from quantum circuits, *Reports on Progress in Physics* **82**, 124501 (2019), publisher: IOP Publishing.
- [31] M. Kjaergaard, M. E. Schwartz, J. Braumüller, P. Krantz, J. I.-J. Wang, S. Gustavsson, and W. D. Oliver, Superconducting Qubits: Current State of Play, *Annual Review of Condensed Matter Physics* **11**, 369 (2020), publisher: Annual Reviews.
- [32] R. Kaufman, T. White, M. I. Dykman, A. Iorio, G. Sterling, S. Hong, A. Opremcak, A. Bengtsson, L. Faoro, J. C. Bardin, T. Burger, R. Gasca, and O. Naaman, Josephson parametric amplifier with Chebyshev gain profile and high saturation, *Physical Review Applied* **20**, 054058 (2023).
- [33] W. A. Phillips, Tunneling states in amorphous solids, *Journal of Low Temperature Physics* **7**, 351 (1972).
- [34] W. B. Mims, K. Nassau, and J. D. McGee, Spectral Diffusion in Electron Resonance Lines, *Physical Review* **123**, 2059 (1961), publisher: American Physical Society.
- [35] J. R. Klauder and P. W. Anderson, Spectral Diffusion Decay in Spin Resonance Experiments, *Physical Review* **125**, 912 (1962), publisher: American Physical Society.
- [36] P. Hu and S. R. Hartmann, Theory of spectral diffusion decay using an uncorrelated-sudden-jump model, *Physical Review B* **9**, 1 (1974), publisher: American Physical Society.
- [37] S. Ludwig, P. Nalbach, D. Rosenberg, and D. Osheroff, Dynamics of the destruction and rebuilding of a dipole gap in glasses, *Phys. Rev. Lett.* **90**, 105501 (2003).
- [38] A. Schweiger and G. Jeschke, *Principles of Pulse Electron Paramagnetic Resonance* (Oxford University Press, 2001).
- [39] C. M. Caves, Quantum limits on noise in linear amplifiers, *Phys. Rev. D* **26**, 1817 (1982).
- [40] S. Kern, P. Neilinger, E. Il'ichev, A. Sultanov, M. Schmelz, S. Linzen, J. Kunert, G. Oelsner, R. Stolz, A. Danilov, S. Mahashabde, A. Jayaraman, V. Antonov, S. Kubatkin, and M. Grajcar, Reflection-enhanced gain in traveling-wave parametric amplifiers, *Phys. Rev. B* **107**, 174520 (2023).
- [41] M. Malnou, J. Aumentado, M. Vissers, J. Wheeler, J. Hubmayr, J. Ullom, and J. Gao, Performance of a kinetic inductance traveling-wave parametric amplifier at 4 kelvin: Toward an alternative to semiconductor amplifiers, *Phys. Rev. Appl.* **17**, 044009 (2022).
- [42] A. L. Burin, M. S. Khalil, and K. D. Osborn, Universal dielectric loss in glass from simultaneous bias and micro-

- wave fields, *Phys. Rev. Lett.* **110**, 157002 (2013).
- [43] B. Sarabi, A. N. Ramanayaka, A. L. Burin, F. C. Wellstood, and K. D. Osborn, Projected dipole moments of individual two-level defects extracted using circuit quantum electrodynamics, *Phys. Rev. Lett.* **116**, 167002 (2016).
- [44] J. Gao, M. Daal, A. Vayonakis, S. Kumar, J. Zmuidzinas, B. Sadoulet, B. A. Mazin, P. K. Day, and H. G. Leduc, Experimental evidence for a surface distribution of two-level systems in superconducting lithographed microwave resonators, *Applied Physics Letters* **92**, 152505 (2008).
- [45] C. Eichler, C. Lang, J. M. Fink, J. Govenius, S. Filipp, and A. Wallraff, Observation of Entanglement between Itinerant Microwave Photons and a Superconducting Qubit, *Physical Review Letters* **109**, 240501 (2012).
- [46] C. Müller, J. Lisenfeld, A. Shnirman, and S. Poletto, Interacting two-level defects as sources of fluctuating high-frequency noise in superconducting circuits, *Phys. Rev. B* **92**, 035442 (2015).
- [47] M. Chen, J. C. Owens, H. Putterman, M. Schäfer, and O. Painter, Phonon engineering of atomic-scale defects in superconducting quantum circuits, *Science Advances* **10**, eado6240 (2024).
- [48] L. Stefanazzi, K. Treptow, N. Wilcer, C. Stoughton, C. Bradford, S. Uemura, S. Zorzetti, S. Montella, G. Cancelo, S. Sussman, A. Houck, S. Saxena, H. Arnaldi, A. Agrawal, H. Zhang, C. Ding, and D. I. Schuster, The QICK (Quantum Instrumentation Control Kit): Readout and control for qubits and detectors, *Review of Scientific Instruments* 10.1063/5.0076249 (2022).

Appendix A: Experimental setup

The JTWPA is driven by pulses generated with a Zynq UltraScale+ RFSoc ZCU216 Evaluation Kit, set up with the QUICK firmware [48]. The driving pulses are sampled at 430.08 MHz and modulated at a frequency 193 MHz. They are up-converted using I-Q mixers, with continuous microwave tones produced by one of the four channels of an AnaPico® APUASYN20-4 generator, and then are amplified by a Mini-Circuits ZVE-3W-183+ amplifier followed by a Wainwright Instruments WTBCX6-6500-7000-40-200-40SS bandpass filter to reject the local oscillator leakage before reaching the fridge input. A second channel of the generator is used for the JTWPA pump, while a third channel is dedicated to the BLAST tone. To characterize the JTWPA D1 amplification in Fig. 4, we tune the JTWPA pump frequency ($\omega_p/2\pi = 5.985$ GHz) in order to reach a sweet point of gain $G = 20.8(1)$ dB and noise figure $F = 13.2(1)$ dB for the entire amplification chain when the JTWPA is turned on and off. The BLAST tone output is controlled via an RF-Lambda Absorptive Coaxial SPST Switch 2GHz-18GHz. The echoes emitted by the JTWPAs are amplified by a HEMT amplifier from Low Noise Factory® at 4 K and by a room-temperature amplifier. The signals are down-converted using I-Q mixers before digitization by the ZCU216 board with readout sampling readout rate of 307.2 MHz.

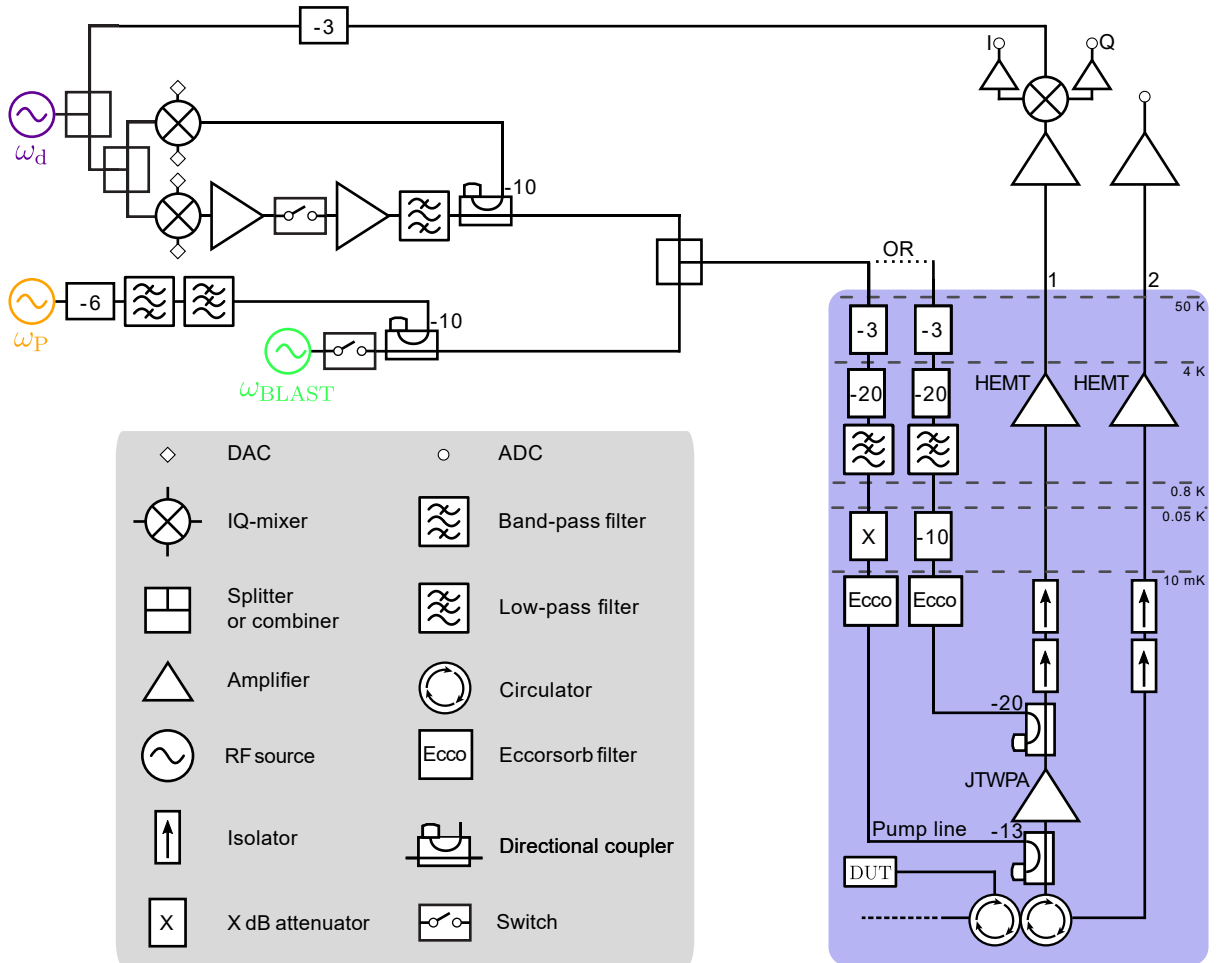

FIG. A5. General schematic of the measurement setup for JTWPA D1, D2 and D3. In the measurements presented in the main text, we send our drive signals directly through the pump line. For JTWPA D1, we placed a -10 dB attenuator on the cold plate (0.05K), and we use a -13 dB directional coupler to combine the signal from the DUT and the JTWPA pump. JTWPA D2 and D3 were measured in another fridge of nominally identical wiring, except the cold plate attenuator was -20 dB and the directional coupler had -20 dB coupling. When measuring JTWPA D2 and D3, we omitted the directional coupler placed directly after the JTWPA and the DUT is replaced by a 50Ω termination. On top of the fridge, we can choose whether to probe the JTWPA or drive directly the HEMT. We do not represent room-temperature isolators for clarity.

Appendix B: Spectral diffusion model

Let us consider a defect subjected to static strain and/or electric fields which depend on the host material. A double well potential with asymmetry splitting Δ and tunneling energy Δ_0 is widely used to model such system. The Hamiltonian is analogous to the one of an electronic spin 1/2 in a static magnetic field \vec{B}_0 :

$$H_A/\hbar = \frac{\Delta}{2}\sigma_z + \frac{\Delta_0}{2}\sigma_x \quad (\text{B1})$$

with $\sigma_x = \begin{pmatrix} 0 & 1 \\ 1 & 0 \end{pmatrix}$ and $\sigma_z = \begin{pmatrix} 1 & 0 \\ 0 & -1 \end{pmatrix}$. These TLSs are coupled to one another elastically or electrically. We focus here on electric dipole-dipole interaction between TLS A with dipole d_A and a bath of B TLSs comprising N_B dipoles d_B^k distant from A by \vec{r}_k with $k = 1, 2, \dots, N_B$. Since the interaction is short-range we assume the local static electric field \vec{E}_0 to be homogeneous. We consider only the case of non-resonant TLSs, for which

$$H_{AB} = \sum_{k=1}^N C_{AB}^k \sigma_z^A \sigma_z^k \quad (\text{B2})$$

with $C_{AB}^k = \frac{1-3\cos^2(\theta^k)}{4\pi\epsilon(r_k)^3} d_A d_B^k$ where θ^k is the angle between \vec{E}_0 and \vec{r}_k . The TLS A energy $E_a = \hbar\omega_A$ thus depends on the state of TLS B bath as

$$\omega_A(t) = \omega_A^0 + \sum_{k=1}^N \frac{C_{AB}^k}{\hbar} \sigma_z^k(t). \quad (\text{B3})$$

TLSs B are thermally active and can jump between their ground and excited state having thus an impact on TLS A. This effect is known as spectral diffusion. Once TLS A is excited its angular frequency $\omega_A(t=0)$ is modified at each TLS B jump, drifting away from its starting value. We focus now on the effect of spectral diffusion in an Hahn echo sequence (see main text). The echo amplitude of TLS A is given by:

$$E(2\tau) = \Re \left(e^{i \int_0^\tau \omega_A(t) dt - i \int_\tau^{2\tau} \omega_A(t) dt} \right) \quad (\text{B4})$$

where the exponent can be rewritten as:

$$\sum_{k=1}^N \frac{C_{AB}^k}{\hbar} \int_0^{2\tau} s(t) h^k(t) dt \quad (\text{B5})$$

where $h^k(t)$ is a function taking values ± 1 and changing sign at every jump of the k TLS while $s(t) = \begin{cases} 1 & t \leq \tau \\ -1 & t > \tau \end{cases}$.

The echo amplitude thus depends on the spatial distribution and on the flipping history of the B TLSs bath. In order to treat this problem we approximate the TLS bath as an ensemble of identical B TLSs of mean dipole \bar{d}_B where we average over all B TLSs positions (volume V) and flip histories (FP) and consider a mean interaction strength \bar{C}_{AB} [36]:

$$E(2\tau) = \Re \left(\left\langle \left\langle \exp \left[\frac{i}{\hbar} \bar{C}_{AB} \int_0^{2\tau} s(t) h(t) dt \right] \right\rangle_V \right\rangle_{\text{FH}} \right)^{N_B} \quad (\text{B6})$$

Here, N_B is the number of spin that have flipped between 0 and 2τ . The spatial averaging can be performed noting that :

$$\left(\left\langle \exp [iX] \right\rangle_V \right)_{\text{FH}}^{N_B} \approx \exp [(-N_B \langle (1 - \exp [iX]) \rangle_V)_{\text{FH}}] \quad (\text{B7})$$

for $N_B \gg 1$, by using the identity $\langle (1) \rangle_V = 1$. We can now average the first exponent over the whole volume V , obtaining:

$$\frac{2\pi}{V} \int_0^\infty \int_{-1}^1 \left[1 - e^{\frac{id_A \bar{d}_B}{\hbar} \bar{C}_{AB} \int_0^{2\tau} s(t) h(t) dt} \right] r^2 dr d[\cos(\theta)] = \quad (\text{B8})$$

$$\frac{\pi^2}{3V} \int_{-1}^1 \left| \frac{id_A \bar{d}_B}{4\pi\hbar\epsilon} (1 - 3\cos^2(\theta)) \int_0^{2\tau} s(t) h(t) dt \right| d[\cos(\theta)] = \frac{2\pi d_A \bar{d}_B}{9\sqrt{3}\hbar\epsilon V} \left| \int_0^{2\tau} s(t) h(t) dt \right| \quad (\text{B9})$$

We can now write

$$E(2\tau) = \exp \left[-\frac{2\pi}{9\sqrt{3}\hbar\epsilon} d_A \bar{d}_B c_B \left\langle \int_0^{2\tau} s(t)h(t)dt \right\rangle_{\text{FH}} \right] \quad (\text{B10})$$

where c_B is the spatial density of flipped B TLSs. The average over all possible B flip histories can be conducted considering a single flipping rate W . The derivation can be found in [36], obtaining

$$\left\langle \int_0^{2\tau} s(t)h(t)dt \right\rangle_{\text{FH}} = \alpha(2\tau, W) = 2e^{-2W\tau} \tau \left[I_1(2W\tau) + \frac{\pi}{2} (I_1(2W\tau)L_0(2W\tau) - I_0(2W\tau)L_1(2W\tau)) \right] \quad (\text{B11})$$

where $I_i(x), L_j(x)$ are the modified Bessel and Struve function of order i, j . Defining $\Gamma_{\text{SD}} = \frac{2\pi}{9\sqrt{3}\hbar\epsilon} d_A \bar{d}_B c_B$ we obtain the expression $E(2\tau)$ of the main text for N_A TLSs excited by the driving tone at ω_d .

For the three pulse sequence it is possible to proceed in a similar way:

$$E(2\tau, \tau') = \exp \left[-\Gamma_{\text{SD}} \left\langle \int_0^\tau h(t)dt - \int_{\tau+\tau'}^{2\tau+\tau'} h(t)dt \right\rangle_{\text{FH}} \right] = \exp [-\Gamma_{\text{SD}}\beta(\tau, \tau', W)] \quad (\text{B12})$$

where there is no precession of the TLS A between the second and third pulse. Averaging over all B TLSs flipping histories we obtain

$$\beta(\tau, \tau', W) = e^{-2W\tau} \tau [I_0(2W\tau) + I_1(2W\tau)] (1 - e^{-2W\tau'}) + \frac{1}{2}\alpha(2\tau, W) (1 + e^{-2W\tau'}). \quad (\text{B13})$$

Appendix C: Echo signal integration

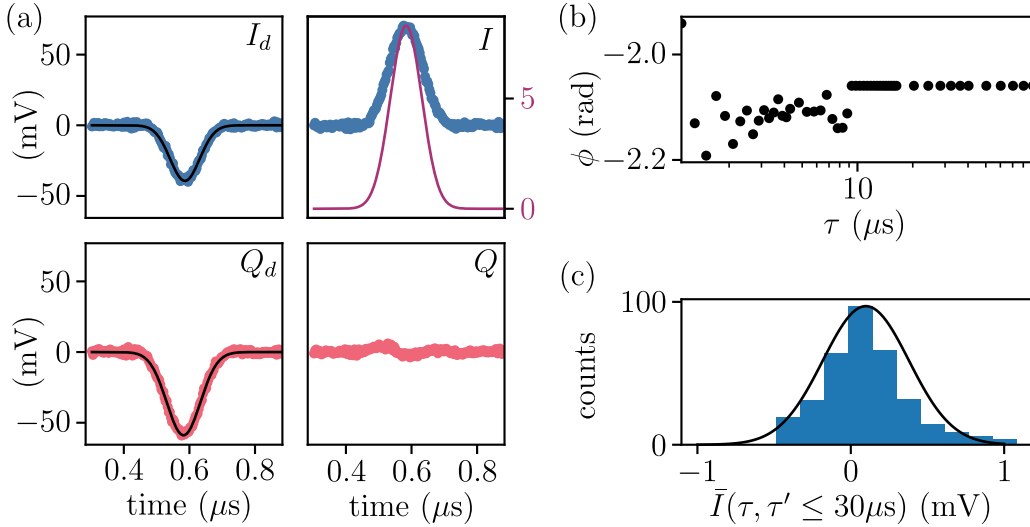

FIG. A6. (a) Time traces of the detected I_d (blue) and Q_d (red) quadrature taken on JTWPA D2 at 8 mK and $\tau = 0.6 \mu\text{s}$. After rotating by an angle ϕ , we obtain the I and Q quadratures. Black, Gaussian fit on I_d and Q_d . Purple, filtering function $u(t)$. (b) ϕ as function of τ for JTWPA D2 at 8 mK (c) Histogram of the signals used to evaluate the error on \bar{I} . Black, Gaussian fit of the point distribution.

We compute the mean average signal \bar{I} as the weighted integrated amplitude: $\bar{I} = \int u(t)I(t)dt / \int u(t)^2 dt$, where $u(t)$ is a Gaussian filter function having the same center time and width as the spurious signal

We now detail the procedure to extract the weighted integrated amplitude for each echo signal. We first detect the I_d and Q_d quadrature using heterodyne detection. The sampling time is $\Delta t = 3.2 \text{ ns}$. We then fit every echo signal j with a Gaussian $Ae^{-\frac{(t-\mu)^2}{2\sigma^2}}$. We independently treat the I_d^j and Q_d^j quadratures, thus obtaining $\mu_I^j, \mu_Q^j, \sigma_I^j, \sigma_Q^j$. In a spontaneous or stimulated Hahn echo sequence, we use the three highest echo signals i.e. the echoes detected for the three shortest delays, to define a Gaussian filtering function $u(t) = \frac{1}{\sqrt{2\pi\sigma^2}} e^{-\frac{(t-\mu)^2}{2\sigma^2}}$

where $\bar{\mu} = \frac{1}{6} \sum_{j=1,2,3} (\mu_I^j + \mu_Q^j)$ and $\bar{\sigma} = \frac{1}{6} \sum_{j=1,2,3} (\sigma_I^j + \sigma_Q^j)$. We also define in the complex IQ plane the angle $\phi_0 = \angle \left\{ \sum_{j=1,2,3} \left[\sum_{i=1}^N I_d^j(t_i) + i \sum_{i=1}^N Q_d^j(t_i) \right] \right\}$. Correcting for the phase rotation, we can access to the weighted integrated amplitude by computing:

$$\bar{I} = \frac{\int_{t_0}^{t_1} u(t) I(t) dt}{\int_{t_0}^{t_1} u(t)^2 dt} = \sum_{i=1}^N u(t_i) [I_d(t_i) \cos(\phi) + Q_d(t_i) \sin(\phi)] \Delta t. \quad (\text{C1})$$

Here $u(t)$ is a Gaussian filter function having the same center time and width as the spurious signal and $\phi = \phi_0 + \delta$ where δ is a small correction that minimizes $\bar{Q} = \sum_{i=1}^N u(t_i) [-I_d(t_i) \sin(\phi) + Q_d(t_i) \cos(\phi)] \Delta t$ for each echo. An example of the optimal ϕ obtained for each τ is shown in Fig. A6b.

To evaluate the error on \bar{I} , we collect all measurements performed using the same room temperature setup with $\tau > 30 \mu\text{s}$ and $\tau' > 30 \mu\text{s}$ for spontaneous and stimulated Hahn echo experiments. Since no echo is present in such traces, what we measure is only the noise weighted by $u(t)$. Fitting the histogram of such points with a Gaussian (see Fig. A6c), we extract $\sigma(\bar{I}) = 0.28 \text{ mV}$.

Appendix D: Fitting two pulse sequence

We detail the routine implemented for fitting the two pulse experiments. There are 29 parameters in total namely $\Gamma_2^{\text{eff}}, W_{\text{ex}}, \Gamma_{\text{SD}}, \Gamma_1^{\text{ph,B}}, \omega_B$ and the amplitude A_0 for each of the twenty-four temperature probed. Due to the large parameter space, we use a bootstrapping to evaluate all parameters and their variance. We focus on the two pulse experiment. We have acquired 24 echoes relaxation traces, each at a different temperature, with 52 integrated echoes per trace acquired for various τ . We can randomly choose a subset of 18 of these traces to perform the fit and obtain a fit vector for our 29 parameters. Repeating the operation a hundred times, we obtain a hundred fit results, from which we can extract the mean and variance of each of these fit parameters. The fit of each data-subset is performed by minimizing the cost function

$$C = \sum_{T_i=1}^{18} \left[\sum_{\tau} \left[\bar{I}(\tau, T_i) - A_{T_i} e^{-2(\Gamma_2^{\text{eff}} + W_{\text{ex}} T_i) \tau} e^{-\Gamma_{\text{sd}}(\omega_B, T_i) \alpha(2\tau, W(\omega_B, T_i))} \right]^2 \right] \quad (\text{D1})$$

where $I(\tau, T_i)$ is the integrated echo with delay τ and temperature T_i , A_{T_i} is the amplitude of the echo at temperature T_i and the temperature independent parameters discussed in eqn.2 of the main text. We thus obtain a distribution for the global fit parameters, shown in Fig.A7(b) from which we extract the mean and standard deviation values presented in table I. We then use the mean values of the temperature independent parameters together with Eq. 2 to obtain A_0 for each temperature. The fitting curves are presented in Fig.A7(a).

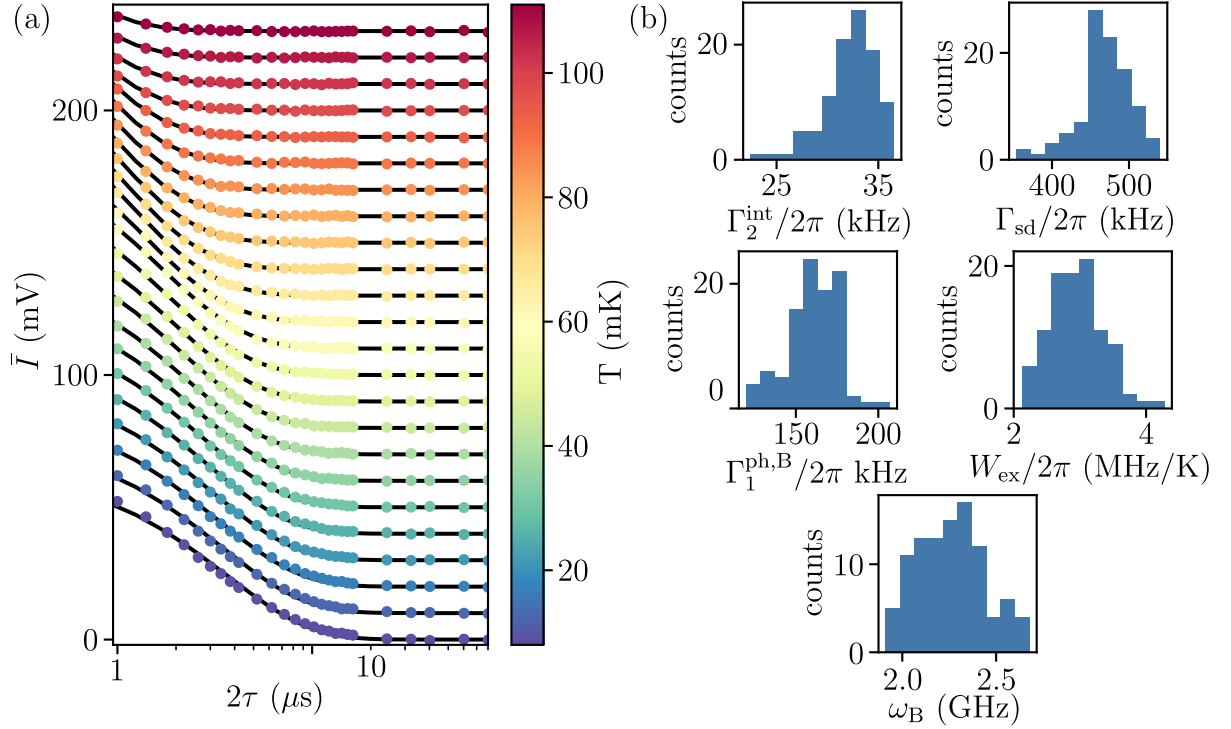

FIG. A7. (a) Two pulse sequence integrated echo versus delay 2τ for all measured temperatures. We show half of the experimental points and there are 10 mV offset between two consecutive temperatures for clarity. Black lines correspond to spectral diffusion model fit. (b) Histograms of the optimal parameters in spectral diffusion model. All data presented refer to JTWP A D2.

Appendix E: Dielectric losses impact on quantum efficiency

We detail here how dielectric losses play a role in limiting the quantum efficiency of the JTWPA amplifier. Focusing on a single cell of the JTWPA chain, we can model the dielectric losses in the capacitor c as a conductance Υ in parallel to it:

$$\Upsilon = c\omega \tan(\delta) \quad (\text{E1})$$

Such finite conductance acts as an attenuator between one cell and another. The attenuation can be expressed as

$$a \approx 1 - \frac{1}{2}c\omega Z_0 \tan(\delta) \quad (\text{E2})$$

where Z_0 is the impedance of the JTWPA chain and we consider $c\omega Z_0 \tan(\delta) \ll 1$.

We can now consider the noise of n_c amplifying cells constituting the JTWPA. We model each cell as an attenuator of attenuation a plus an ideal phase-preserving amplifier of gain g and we assume all cells to be equal. We consider an input noise $N_0 = N_Q = \frac{1}{2}$ at the first cell input. To evaluate how the noise is modified going through the first cell, we need to account three terms, namely the cell attenuation a , the quantum fluctuation added by the the attenuator $(1-a)N_Q$ and the noise $(1-1/g)N_Q$ added by amplifier. The total noise at the output of the first cell is [1]:

$$N_1 = gaN_0 + g(1-a)N_Q + (g-1)N_Q = tN_0 + \chi \quad (\text{E3})$$

where $t = ga$ and $\chi = (2g - ga - 1)N_Q$. For cell $i + 1$ it reads:

$$N_{i+1} = tN_i + \chi = t^2N_{i-1} + t\chi + \chi = t^3N_{i-2} + t^2\chi + t\chi + \chi = \dots = t^{i+1}N_0 + \chi \sum_{k=0}^i t^k. \quad (\text{E4})$$

We can thus evaluate the noise exiting the last cell n_c of the amplifier, relating the output noise N_{n_c} to the input noise N_0

$$N_{n_c} = t^{n_c}N_0 + \chi \frac{t^{n_c} - 1}{t - 1} \quad (\text{E5})$$

We define the quantum efficiency η as

$$\eta = \frac{N_0}{N_{n_c}/T - N_0} = \frac{t - 1}{\chi} = \frac{ag - 1}{2g - ag - 1} \quad (\text{E6})$$

where $T = \prod_{i=1}^{n_c} t = t^{n_c}$ is the total transmission. The JTWPA contains $n_c = 2037$ cells [1] and at the sweet spot we observe a JTWPA gain $G = 120.3(1)$.

Appendix F: JTWPA reflection and transmission

We now show the JTWPA D1 (see main text) transmission and reflection upon varying the JTWPA pump power. These measurements are carried out as follows. We apply a pump tone at 5.985 GHz with a fixed power from nothing (blue curves in Fig. A8) to 18 dBm (black curves in Fig. A8). To measure the transmission and reflection profile we use a four port Virtual Network Analyzer (VNA). We excite the JTWPA through the pump line (see Fig. A5) and we then measure the two signal S_{21} and S_{11} resulting from passing through the JTWPA or being reflected.

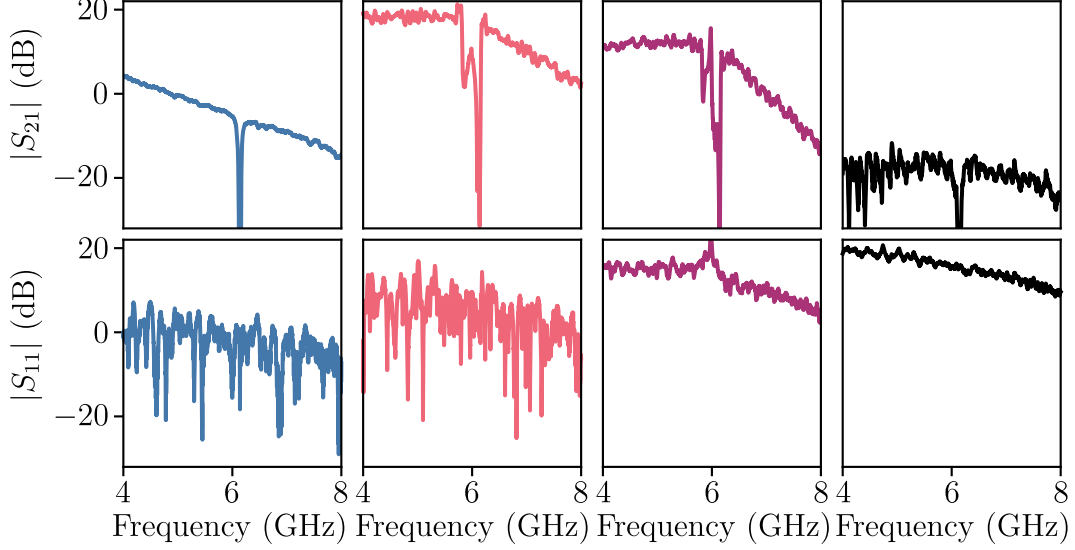

FIG. A8. JTWPA D1 transmission (S_{21}) and reflection (S_{11}) signals upon varying the pump power. Blue curve corresponds to the situation where no pump tone is applied, red purple and black correspond to a room temperature pump tone of 10 dBm, 12 dBm and 18 dBm respectively.

We observe that just above the optimal point of operation (red curves in Fig. A8) the transmitted signal starts to degrade while the reflected signal increases (purple curves in Fig. A8). By going further in this non-linear regime (black curves in Fig. A8), we suppress transmission through the JTWPA.

Appendix G: BLAST optimization

We show the optimization of the power and frequency of the BLAST tone. We have performed such experiment on JTWPA D1. We first measure a reference signal I_{ref} made of a flat-top pulse of length $\theta = 0.15 \mu\text{s}$ and rising time of 20 ns with power of -125 dBm at the JTWPA input. To measure I_{ref} , we operate the JTWPA in its sweet spot with a pump tone of angular frequency $\omega_{\text{p}} = 5.985 \text{ GHz}$ and power -82 dBm at the JTWPA input. We then perform the sequence shown in Fig.4a. The three flat-top pulses have same pulse length $\theta = 0.15 \mu\text{s}$ and are delayed by $\tau = 0.5 \mu\text{s}$. The first and second pulse enter the JTWPA with power -83 dBm , -78 dBm respectively. In doing so, the third pulse, which is identical to I_{ref} , is applied at the instant where we expect the dielectric echo to appear. The goal is to find a set of BLAST parameters that allows us to detect the small third pulse. We sweep the BLAST frequency and power to minimize the difference between the reference signal within the BLAST sequence $I_{\text{ref}}^{\text{BLAST}}$ and I_{ref} . More precisely, we minimize the quantity

$$\epsilon = \int_{t_0}^{t_1} (I_{\text{ref}}^{\text{BLAST}}(t) - I_{\text{ref}}(t)) dt \quad (\text{G1})$$

In Fig.A9 we remark that ϵ has a weak dependence on frequency and on P_{BLAST} power once it is strong enough to remove the dielectric echo. We find the BLAST optimal frequency to be 6.14 GHz. The optimal power at the output of the local oscillator is 10 dBm which corresponds to -55 dBm at the JTWPA input.

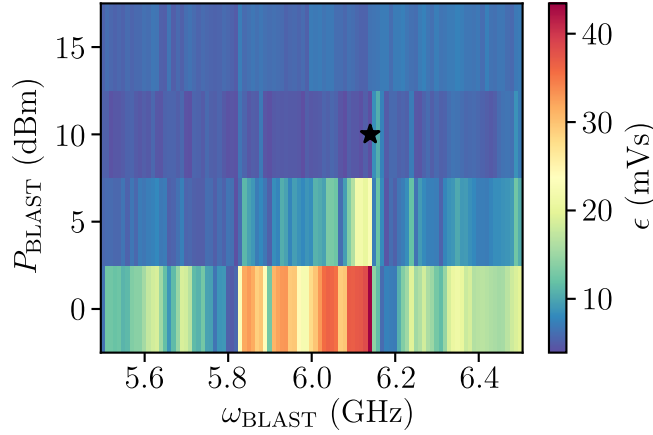

FIG. A9. Integrated signal difference ϵ with and without BLAST tone as function of BLAST angular frequency and power. Black star corresponds to the optimal point of operation

Appendix H: Echo removal by interferometric cancellation

The results in Fig.4(b) can be compared to a complementary strategy to remove JTWPA dielectric echoes, namely performing interferometric cancellation of the high power tones before the JWTPA input. We use a similar setup to the one presented in Fig. A5. We apply concurrently a two pulse sequence made of rectangular pulses on the DUT (probe pulses) and on the JTWPA pump line (cancellation pulses). By tuning the amplitude, phase and delay of the cancellation pulses we can indeed have destructive interference between the two, preventing thus the excitation and consequent emission of an echo from the JTWPA dielectric defects, as shown in Fig. A10

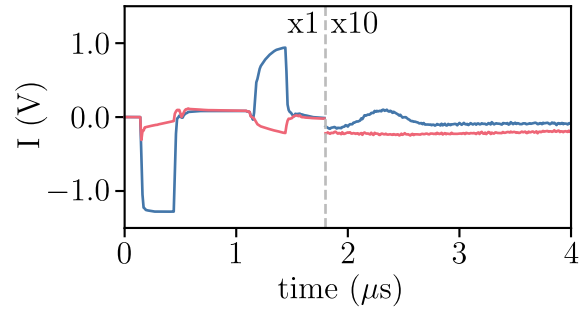

FIG. A10. Detected I quadrature of a two pulse sequence as function of time. The two pulses have length $\theta = 0.3 \mu\text{s}$ and are separated by $1.0 \mu\text{s}$. Lines correspond to detected signal when no compensation is applied (blue) and when it is applied (red).