

Design of the full-sky scanning strategy and systematic effect
control in a cosmic microwave background probe

by

Yusuke Takase
takase_y@s.okayama-u.ac.jp

A Doctoral Thesis

Thesis submitted to
the Graduate School of the Okayama University
on December 25th, 2024
in Partial Fulfillment of the Requirements
for the Degree of Doctor of Philosophy in Science
in Division of Mathematics and Physics

Thesis supervisor: Hirokazu Ishino
Professor of Astrophysics

Contents

1	Introduction	3
1.1	Probing inflationary models with CMB polarization	3
1.2	Importance of scanning strategy and systematic effects control	4
1.3	Contents of this thesis	5
2	CMB polarization	7
2.1	Detection of the CMB	8
2.2	Temperature anisotropies	8
2.2.1	Observation by space missions	8
2.2.2	Quantification of anisotropies	10
2.3	Polarization anisotropies	12
2.3.1	Stokes parameters	12
2.3.2	E -mode and B -mode polarization	14
2.3.3	Generation of polarization anisotropies	16
2.3.4	Polarization from scalar perturbations	17
2.3.5	Polarization from tensor perturbations	18
2.4	Primordial gravitational waves from cosmic inflation	20
2.4.1	Primordial gravitational waves and tensor-to-scalar ratio	21
2.5	Implications of angular power spectrum	22
2.5.1	Temperature anisotropies power spectrum	22
2.5.2	E -mode power spectrum	23
2.5.3	Lensing B -mode power spectrum	24
2.5.4	Primordial B -mode power spectrum	24
3	Scanning strategies of CMB space missions	26
3.1	Scanning strategy of past CMB space missions	26
3.1.1	<i>COBE</i>	26
3.1.2	<i>WMAP</i>	27
3.1.3	<i>Planck</i>	28
3.2	Summary of scanning parameters across CMB space missions	29
3.3	<i>LiteBIRD</i> space mission	29
3.3.1	Polarization modulation with half-wave plates	32

4	Novel map-making approach in <i>spin</i> space	33
4.1	Description of signal and map-making in <i>spin</i> space	33
4.1.1	The case without HWP	33
4.1.2	The case with HWP	36
4.2	Observation with multiple detectors	37
5	Optimization of full-sky scanning strategy	39
5.1	The parameter space of scanning strategies	40
5.2	Constraints on the parameter space	41
5.2.1	Constraints on geometric parameters	41
5.2.2	Constraints on kinetic parameters	41
5.3	The case of <i>LiteBIRD</i> mission	43
5.4	Metrics for optimization	46
5.4.1	Visibility time of compact sources	46
5.4.2	Forming speed of sky coverage	46
5.4.3	Hit-map uniformity	46
5.4.4	Cross-link factor	47
5.5	Results	47
5.5.1	Visibility time of compact sources	47
5.5.2	Forming speed of sky coverage	48
5.5.3	Hit-map uniformity	48
5.5.4	Cross-link factor	50
5.5.5	Propagation of cross-link factor to bias	50
5.6	Optimization	52
5.6.1	Optimization of the geometric parameters	53
5.6.2	Optimization of the kinetic parameters	53
	Global survey of the kinetic parameter space	53
	Fine-tuned study of the precession period	54
5.7	Implications	56
5.7.1	Beam reconstruction systematics	56
5.7.2	Amplitude of CMB solar dipole	57
5.7.3	Sky pixel visit/revisit times	58
5.7.4	Planet visit/revisit times	61
6	Systematic effects on CMB polarimetry	63
6.1	Systematic effects without HWP	64
6.1.1	Differential gain	64
6.1.2	Differential pointing	66
6.2	Systematic effects with HWP	67
6.2.1	Absolute pointing offset	67
6.2.2	Pointing disturbance due to HWP rotation	69
6.2.3	Instrumental polarization due to HWP non-ideality	70
6.3	Mitigation techniques to control systematic effects by using <i>spin</i>	72

6.4	Results of the systematic effects	74
6.4.1	Differential gain	74
6.4.2	Differential pointing	76
6.4.3	Absolute pointing offset	79
6.4.4	Pointing disturbance due to HWP rotation	83
6.4.5	Instrumental polarization due to HWP non-ideality	87
7	Conclusion	91
7.1	Summary of scanning strategy optimization	91
7.2	Summary of the systematic effect studies	93
7.3	Future perspective	94
A	Additional derivations and frameworks	95
A.1	Fundamentals of cosmology	95
A.1.1	Dipole temperature anisotropy of the CMB	95
A.2	Scanning motion of spacecraft	96
A.2.1	Sweep angular velocity on the sky	97
A.3	Method to estimate the bias on r	98
A.4	The HEALPix software package	99
A.4.1	Polarization convention on the sphere	100
B	Supplementary results and discussions	101
B.1	Comparison between TOD and map-based simulation	101
B.2	Impact of the value of the spin period on the metrics	102
B.3	Metrics for detectors located away from the boresight	103
B.4	Discussion on the rotation direction of the spacecraft	103
C	Additional figures	108
C.1	Cross-link maps	108

List of Figures

2.1	Blackbody radiation spectrum of the CMB measured by <i>COBE</i>	9
2.2	Overview of past CMB observation satellites	10
2.3	Mollweide projection of spherical harmonics for $\ell \leq 4$ and $ m $	12
2.4	The angular power spectrum of CMB temperature anisotropies measured by <i>Planck</i>	13
2.5	<i>E</i> - and <i>B</i> -mode polarization patterns	15
2.6	Generation of CMB polarization anisotropies from quadrupole radiation fields.	17
2.7	Generation of <i>E</i> - and <i>B</i> -mode polarization from scalar and tensor perturbations.	18
2.8	Deformation modes of gravitational waves.	19
2.9	Full-sky projections of <i>E</i> - and <i>B</i> -mode polarization	19
2.10	Typical potentials in the slow-roll inflation model	21
2.11	Power spectra $C_\ell^{TT,EE,BB}$ calculated using <i>CAMB</i>	25
3.1	<i>COBE</i> 's scanning strategy and instrument layout	27
3.2	<i>WMAP</i> scanning strategy	28
3.3	<i>Planck</i> scanning strategy	29
3.4	Schematic of <i>LiteBIRD</i> 's spacecraft and payloads	30
3.5	Expected sensitivity of <i>LiteBIRD</i> for CMB power spectra	31
5.1	The scanning configuration and spin period constraints of <i>LiteBIRD</i>	44
5.2	Hit-maps showing observation counts per sky pixel over time for different geometric parameters.	45
5.3	Visibility time of planets, Crab Nebula and accumulated visibility time for all planets	49
5.4	Time required to achieve half-sky coverage, T_{cover} , and hit-map standard deviation, σ_{hits}	49
5.5	Distribution of sky-averaged cross-link factors for different <i>spin</i> -(n, m) configurations.	51
5.6	Distribution of Δr due to pointing offset and instrumental polarization with the HWP.	52
5.7	Cross-link factors for different <i>spin</i> -($n, 0$) configurations and <i>spin</i> -($2, 4$) cross-link factors for LFT, MFT and HFT.	55
5.8	Dependence of normalized σ_{hits} and <i>spin</i> -($n, 0$) cross-link factors on T_α	55
5.9	Maps showing hit distribution and cross-link factors in Galactic coordinates.	56

5.10	Hit-map evolution over time using scanning strategies from <i>PICO</i> and <i>Planck</i>	57
5.11	Scanning beam angle analysis during one spin cycle.	58
5.12	Power spectra of TOD from different space missions scanning a sky containing only CMB dipole.	59
5.13	Distribution of visit times by spacecraft and sky position.	60
5.14	Distribution of pixel revisit times across spacecraft and sky positions.	60
5.15	Three-year mission planet observation frequency histogram for <i>LiteBIRD</i> , <i>PICO</i> and <i>Planck</i>	61
5.16	Jupiter revisit time distribution.	62
6.1	Estimated CMB maps and residual maps due to the differential gain by the 2×2 matrix map-making approach.	75
6.2	Estimated CMB maps and residual maps due to the differential gain by the 3×3 matrix map-making approach.	76
6.3	Systematic power spectra due to the 0.1% differential gain systematics.	77
6.4	Estimated CMB maps and residual maps due to the $1'$ differential pointing systematics by the 2×2 matrix map-making approach.	78
6.5	Systematic power spectra due to the $1'$ differential pointing systematics.	79
6.6	Estimated CMB maps and residual maps due to the $1'$ differential pointing systematics by the 4×4 matrix map-making approach.	80
6.7	Estimated CMB maps and residual maps due to the $1'$ differential pointing systematics by the 6×6 matrix map-making approach.	80
6.8	Estimated CMB maps and residual maps due to the $1'$ absolute pointing offset by the 3×3 matrix map-making approach with HWP.	81
6.9	Systematic power spectra from absolute pointing offset and HWP-induced circular pointing disturbance	82
6.10	Estimated CMB maps and residual maps due to the $1'$ absolute pointing offset by the 5×5 matrix map-making approach with HWP.	83
6.11	Estimated CMB maps and residual maps due to the $1'$ absolute pointing offset by the 9×9 matrix map-making approach with HWP.	84
6.12	Estimated CMB maps and residual maps due to the HWP wedge effect by the 3×3 matrix map-making approach with HWP.	85
6.13	Estimated CMB maps and residual maps due to the HWP wedge effect by the 5×5 matrix map-making approach with HWP.	86
6.14	Estimated CMB maps and residual maps due to the HWP wedge effect by the 9×9 matrix map-making approach with HWP.	88
6.15	Input map and residual maps of instrumental polarization due to HWP non-ideality simulation using the 3×3 matrix map-making approach.	89
6.16	Estimated CMB maps and residual maps due to instrumental polarization using the 5×5 matrix map-making approach with HWP.	89
6.17	Systematic power spectrum ΔC_ℓ^{BB} due to instrumental polarization using the 3×3 and 5×5 matrix map-making approaches with HWP.	90

A.1	Likelihood function to estimate Δr	99
A.2	HEALPix spherical division	99
A.3	HEALPix pixel ordering	100
B.1	Verification of systematic effect B -mode power spectra between TOD-based and map-based simulations.	102
B.2	Impact of scaling T_{β}^{lower} on the $spin-m$ cross-link factors.	105
B.3	Metrics for detectors located away from the boresight.	106
B.4	Impact of spacecraft rotation direction on $spin-m$ cross-link factors.	107
C.1	$Spin-(n, 0)$ cross-link factors for $n = 1$ to 10.	109
C.2	$Spin-(n, 4)$ cross-link factors for $n = 1$ to 10.	110
C.3	$Spin-(n, 8)$ cross-link factors for $n = 1$ to 10.	111
C.4	Nice logo of Falcons.jl	122

List of Tables

3.1	Scanning strategy parameters for CMB space missions.	30
5.1	Scanning strategy parameters of the <i>LiteBIRD</i> mission.	44
5.2	Geometric/kinetic parameters of <i>LiteBIRD</i> , <i>PICO</i> and <i>Planck</i>	56
B.1	Convention for spin and precession coherence.	103

Abstract

The quest for primordial B -mode polarization signatures in the Cosmic Microwave Background (CMB) is one of the most ambitious endeavors in contemporary cosmology. Such a discovery would serve as a smoking gun for primordial gravitational waves produced by tensor perturbations in the universe's nascent moments, and would allow the precise determination of the tensor-to-scalar ratio, r — a crucial parameter for distinguishing between competing inflationary models. This in-depth investigation requires unparalleled precision in mapping the large-scale angular scales of the CMB, necessitating full-sky observations from space-based platforms free from the distortions of the Earth's atmosphere.

Given that the expected B -mode signatures are approximately three to four orders of magnitude fainter than the CMB temperature anisotropies, the search for their detection requires the implementation of well-designed in-flight calibration and systematic effects mitigation strategies. Our investigation begins with a comprehensive analysis of scanning strategy parameter optimizations, examining their influence on three critical areas: the efficiency of in-flight calibration procedures, the suppression of inherent systematic effects, and the development of robust null-test methods for characterizing systematic effects.

The next generation of space-based observatories, exemplified by *LiteBIRD*, which incorporates Half-Wave Plate (HWP) modulation technology, heralds a paradigm shift in polarization measurements. This advanced approach enables single-detector observations, bypassing the traditional need for differential detection by orthogonal pairing employed in previous experimental configurations, and thereby eliminating the systematic complexities associated with it. While the HWP modulation mechanism is exceptionally effective in suppressing various systematic effects, residual perturbations remain. Through sophisticated analytical frameworks for the mapping process, emphasizing signals of *spin* corresponding to specific axiality, we systematically evaluate the suppression of these systematic effects and elucidate optimal scanning strategy characteristics within the multi-dimensional parameter space of spacecraft scan configurations, culminating in an optimized scanning strategy design for comprehensive full-sky polarization surveys.

In addition, we explore the effectiveness of optimal scanning strategies in mitigating systematic effects through extensive simulation studies, including benchmark systematic effects both with and without the implementation of the HWP. Using the *spin*-based mapping formalism, we evaluate the performance of the HWP. The HWP-enabled configuration emerges as an effective solution in polarization reconstruction, with negligible residual systematic effects. Conversely, the configuration without HWP exhibits significant systematic effects that affect the estimation

of r , although the application of mitigation techniques we develop effectively reduces systematic uncertainties and improves the estimation of r .

Chapter 1

Introduction

Contents

1.1 Probing inflationary models with CMB polarization	3
1.2 Importance of scanning strategy and systematic effects control . . .	4
1.3 Contents of this thesis	5

This thesis investigates scanning strategy optimization and systematic effect estimation and removal techniques for next-generation Cosmic Microwave Background (CMB) polarization space missions. We focus on improving B -mode polarization measurements to detect primordial gravitational waves — a key signature of cosmic inflation. The research develops novel map-making methods exploiting rotational symmetries, particularly for missions using continuously rotating Half-Wave Plates (HWP). Through optimized scanning strategies and systematic effect control, this work aims to enhance the precision of tensor-to-scalar ratio, r measurements, advancing our understanding of the early universe.

1.1 Probing inflationary models with CMB polarization

How was our universe born and shaped? This remains one of the most profound mysteries in modern cosmology. The key to unraveling this enigma lies in the Cosmic Microwave Background (CMB) — the oldest light in the universe, still observable today [1].

The CMB, a cornerstone prediction of Big Bang cosmology, represents primordial photons, emitted when the Universe was hot and dense, that have been redshifted and cooled by cosmic expansion, and are now primarily observable in the microwave regime [2,3]. This ancient radiation exhibits a remarkably uniform ~ 3 K blackbody spectrum across all sky directions, with tiny temperature fluctuations of approximately $10 \mu\text{K}$ [4,5]. These observations confirmed that the early universe existed in thermal equilibrium with small matter density perturbations, which eventually seeded today’s large-scale structures, galaxies, and stars. However, this very uniformity presents a paradox: the horizon problem, where causally disconnected regions inexplicably share nearly identical temperatures, challenging the conventional Big Bang theory.

Inflation theory emerged as a solution to this contradiction [6–8]. By positing a period of superluminal expansion in the early universe, inflation explains how quantum fluctuations crossed the horizon scale and became frozen, resolving the horizon problem. How can we verify that inflation actually occurred?

Inflationary models predict that quantum fluctuations in spacetime, specifically tensor perturbations, were stretched into primordial gravitational waves [9, 10]. These waves, inherently tensor in nature, generate two distinct types of quadrupole anisotropies in the matter distribution perpendicular to their propagation direction. While scalar acoustic waves also produce quadrupole anisotropies, they generate only one type, due to their longitudinal nature. These quadrupole anisotropies, both tensor and scalar, interact with the CMB through Thomson scattering, producing polarization on large-angular scales during the last-scattering epoch. This polarization can be decomposed in Fourier space into even-parity E -modes and odd-parity B -modes [11, 12]. Importantly, while primordial gravitational waves generate both E - and B -modes, acoustic waves produce only E -modes. Thus, the detection of B -mode polarization, which is not degenerate with E -modes, would provide compelling evidence for primordial gravitational waves and allow us to estimate the tensor-to-scalar ratio r , which is proportional to the square amplitude of these waves [13]. The tensor-to-scalar ratio is crucial for constraining the energy scale and potential shape of inflation, thereby enabling us to test and refine inflationary models.

Just as previous generations confirmed the Big Bang theory through CMB temperature anisotropies, we now seek to validate inflationary theory through CMB polarization measurements, potentially uncovering direct evidence of cosmic inflation.

1.2 Importance of scanning strategy and systematic effects control

The precision of CMB polarization measurements directly influences the estimation of r . While statistical uncertainties in CMB observations have dramatically improved through technological advancements in TES (Transition-Edge Sensor) bolometers and multiplexed detector arrays [14, 15], with ground-based *BICEP2/Keck* experiments achieving an upper limit of $r < 0.036$ [16]. However, three critical challenges remain for further improvement:

1. Ground-based experiments inherently struggle to observe large-angular scales where primordial gravitational wave B -modes are most prominent because its sky coverage is limited.
2. Ground-based observation limitations:
 - Systematic effects from atmospheric emission and fluctuations [17]
 - Restricted frequency bands due to atmospheric windows, leading to incomplete foregrounds (galactic synchrotron and dust emission) separation [18]
3. Instrumental systematic effects become increasingly problematic as the experiment's sensitivity is improved.

These challenges can be addressed through:

- Space-based observations for challenges 1 and 2
- A two-pronged approach for challenge 3:
 1. Development of observation strategy that physically suppress systematic effects
 2. Analytical techniques to isolate systematic effects from observational data

For space missions, consideration of a full-sky scanning strategy is essential. An optimized scanning strategy can average out systematic effects per sky pixel, thereby suppressing spurious B -mode signals at large-angular scales [19]. Additionally, while polarization signals exhibit a 180° rotational symmetry, referred to as *spin*, most systematic effects display different symmetries. This distinction allows for the effective separation of polarization signals from systematics [20].¹

The next-generation CMB polarization probe *LiteBIRD*, led by JAXA, uniquely focuses on polarization measurements [21]. It features a continuously rotating Half-Wave Plate (HWP) [22, 23], which controls incident light polarization states modulates the incoming polarized light and effectively suppresses instrumental $1/f$ noise at large-angular scales [24].

The optimization of scanning strategies for a space mission with HWPs that adopts a polarization modulator remains understudied, as does the development of analytical methods exploiting systematic effects' *spin* with in presence of HWPs. This research on full-sky scanning strategy optimization and systematic effect removal techniques is crucial for improving polarization measurement precision in next-generation space missions like *LiteBIRD*.

This thesis addresses these challenges by proposing a scanning strategy that effectively minimize systematic effects for next-generation CMB polarization probes aimed at producing high-precision polarization maps. We present methods for rapid systematic effect estimation and removal in observed polarization maps. By combining these approaches, we aim to enhance r measurement precision in next-generation CMB polarization probes.

1.3 Contents of this thesis

The thesis is organized as follows: chapter 2 presents a comprehensive foundation of CMB observations and its anisotropies, elucidating the fundamental concepts of E -mode and B -mode polarization. This chapter establishes the critical connection between B -mode polarization and primordial gravitational waves, describing their role as potential evidence for cosmic inflation.

Chapter 3 examines the trajectory of CMB space missions, with particular attention to their scanning methodologies. The chapter introduces the *LiteBIRD* mission, which serves as the primary motivation for this research, and elaborates on the theoretical foundations and practical implications of its Half-Wave Plate (HWP) technology. Chapter 4 introduces an innovative map-making framework that exploits *spin* moment decomposition of the signal. We develop a rigorous mathematical formalism for reconstructing temperature and polarization

¹In this thesis we distinguish the 'spin' (normal font), which is the rotation around the maximum inertial axis of a spacecraft, and '*spin*' (italic font), which is an integer characterizing systematic effects.

maps from time-series data in *spin* space, pioneering the first comprehensive treatment of HWP observations with a rotating HWP in multi-detector systems.

Chapter 5 presents a detailed optimization analysis of scanning strategies for next-generation CMB polarization probes, with specific application to *LiteBIRD*. This analysis yields essential design principles for scanning strategies and spacecraft configurations in future CMB polarimeters. Chapter 6 investigates characteristic systematic effects in CMB polarization measurements, demonstrating how an optimized scanning strategy effectively suppresses some systematic effects. The chapter also proposes novel methodologies for enhancing polarization map fidelity through systematic effect isolation and quantifies their impact on r measurements.

Chapter 7 synthesizes the research findings and explores future directions in the field. The content of this thesis is based on the following publication which is published by *Journal of Cosmology and Astroparticle Physics*:

- [25] **Y. Takase**, L. Vacher, H. Ishino, G. Patanchon, L. Montier, S. Stever et al., *Multi-dimensional optimisation of the scanning strategy for the LiteBIRD space mission*, *Journal of Cosmology and Astroparticle Physics* **2024** (2024) 036

Chapter 2

CMB polarization

Contents

2.1	Detection of the CMB	8
2.2	Temperature anisotropies	8
2.2.1	Observation by space missions	8
2.2.2	Quantification of anisotropies	10
2.3	Polarization anisotropies	12
2.3.1	Stokes parameters	12
2.3.2	E -mode and B -mode polarization	14
2.3.3	Generation of polarization anisotropies	16
2.3.4	Polarization from scalar perturbations	17
2.3.5	Polarization from tensor perturbations	18
2.4	Primordial gravitational waves from cosmic inflation	20
2.4.1	Primordial gravitational waves and tensor-to-scalar ratio	21
2.5	Implications of angular power spectrum	22
2.5.1	Temperature anisotropies power spectrum	22
2.5.2	E -mode power spectrum	23
2.5.3	Lensing B -mode power spectrum	24
2.5.4	Primordial B -mode power spectrum	24

This chapter explores the fundamental aspects of CMB polarization, beginning with its historical detection. We discuss the blackbody nature of CMB radiation and its temperature anisotropies, as observed by major satellite missions including *COBE*, *WMAP*, and *Planck*. The chapter then delves into polarization anisotropies, explaining their quantification through Stokes parameters and their decomposition into E -mode and B -mode polarizations. We explain how these polarization modes are generated, with E -modes arising from scalar perturbations and B -modes from tensor perturbations. The chapter concludes with a detailed interpretation of angular power spectra and their implications for understanding primordial gravitational waves and cosmic inflation, highlighting current observational constraints on

the tensor-to-scalar ratio. This chapter draws extensively from the comprehensive Japanese textbook on *Cosmic Microwave Background Radiation* by Eiichiro Komatsu [26], which serves as the primary reference source.

2.1 Detection of the CMB

In 1964, a groundbreaking discovery occurred at Bell Labs in Holmdel, New Jersey. Arno Penzias and Robert W. Wilson were conducting radio observations of Cassiopeia at 7.35 cm wavelength using a 6-meter horn antenna. While comparing sky temperatures with a 5 K calibration source, they detected an unexplained 3.5 K excess radiation that remained constant across the sky and seasons, even after accounting for known atmospheric, ground, and antenna emissions. This mysterious signal was later identified as the Cosmic Microwave Background (CMB), whose existence had been theoretically predicted by Robert H. Dicke. The discovery was published in 1965, with Penzias and Wilson reporting the observation ref. [1] and Dicke providing the theoretical framework ref. [3]. This momentous finding earned Penzias and Wilson the 1978 Nobel Prize in Physics.

The Big Bang theory had predicted that the early universe existed as a hot, dense plasma where light and matter maintained frequent energy exchanges through interactions. This would have resulted in thermal equilibrium, producing blackbody radiation. The spectral radiance of such radiation follows the Planck distribution:

$$B_\nu(T) = \frac{2h\nu^3}{c^2} \frac{1}{\exp(h\nu/k_B T) - 1}. \quad (2.1)$$

where $B_\nu(T)$ represents the spectral radiance ($\text{W m}^{-2} \text{sr}^{-1} \text{Hz}^{-1}$), c is the vacuum speed of light, h is Planck constant, k_B is Boltzmann constant, ν denotes frequency, and T is temperature.

NASA's Cosmic Background Explorer (*COBE*) satellite, launched in 1989, provided definitive evidence for the Big Bang theory through precise measurements of the CMB spectrum and temperature. As shown in Figure figure 2.1, the observed CMB spectral radiance perfectly matched the predicted blackbody radiation spectrum [4].

2.2 Temperature anisotropies

2.2.1 Observation by space missions

The early universe, according to Big Bang theory, existed as a hot, dense plasma. In this state, frequent light-matter interactions created a fog-like condition, making electromagnetic observation by telescopes impossible from present. The universe's expansion and cooling eventually reached a point where these interactions ceased, allowing light to travel freely for the first time. This crucial moment, called the recombination epoch, marked the release of the CMB — the oldest observable light in the universe. The CMB filled the cosmos instantaneously as recombination occurred nearly simultaneously throughout the universe. Today, viewing looking at distant regions from Earth, we observe the CMB emitted for a surface called the Last Scattering Surface (LSS), which represents the recombination epoch occurring approximately 380,000

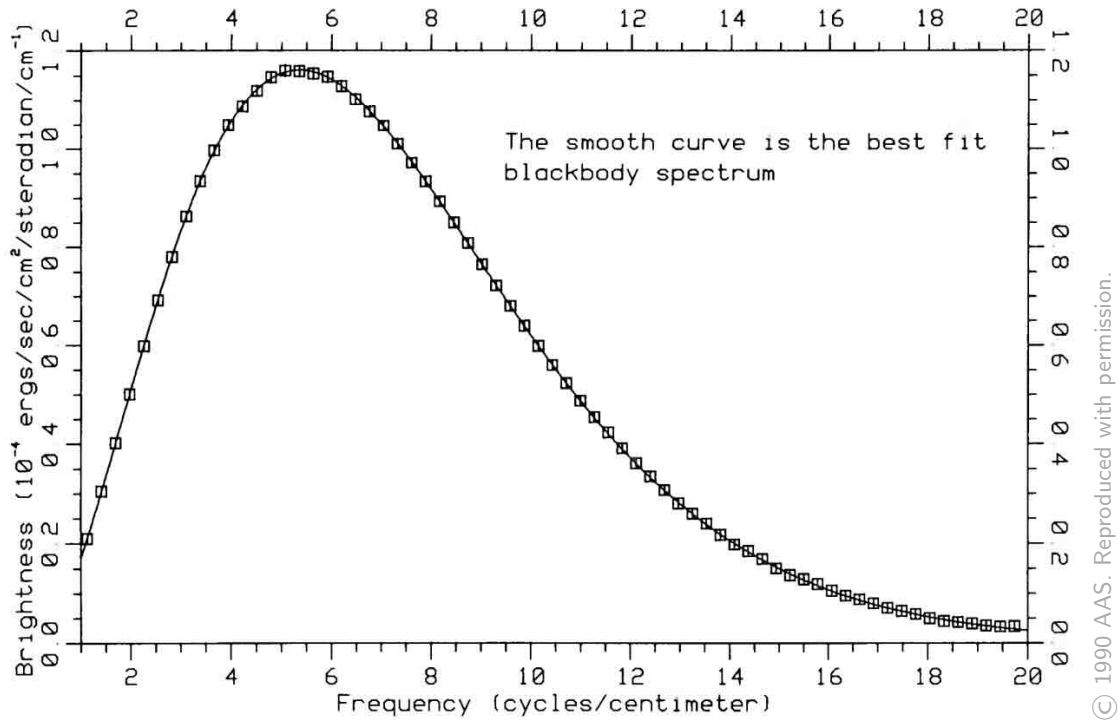

Figure 2.1: The *COBE* satellite’s Far-Infrared Absolute Spectrophotometer (FIRAS) measured CMB spectral radiance data (error bars show 1% observational uncertainty) plotted against a 2.735 K blackbody radiation spectrum fit (solid line). The figure is adapted from ref. [4] with a permission from the authors and the publisher.

years after the Big Bang (redshift $z \simeq 1100$).

COBE’s detailed observations revealed temperature anisotropies on the LSS, detecting $10 \mu\text{K}$ variations. These anisotropies, which stem from early universe quantum fluctuations, offer glimpses into the universe’s state beyond the LSS. Three major space missions – *COBE*, *WMAP*, and *Planck* have mapped these variations. Figure 2.2 presents a comparison of their full-sky CMB temperature anisotropy maps. *WMAP* improved upon *COBE*’s observations, determining the universe’s age as 13.7 ± 0.2 billion years [27]. The subsequent *Planck* mission refined this to 13.797 ± 0.023 billion years and conducted comprehensive measurements of galactic foreground emissions and CMB across frequencies from 26 GHz to 1139 GHz, providing detailed insights into emission components [28, 29].

Since *COBE* confirmed the CMB’s perfect blackbody radiation nature, we can express the relationship between CMB intensity I_{CMB} and temperature T_{CMB} using the Planck distribution from eq. (2.1):

$$I_{\text{CMB}}(\nu) = B_{\nu}(T_{\text{CMB}}). \quad (2.2)$$

The CMB temperature fluctuation $\Delta I(\nu)$ can be written as

$$\Delta I(\nu) = \left. \frac{\partial B_{\nu}(T)}{\partial T} \right|_{T=T_{\text{CMB}}} \Delta T. \quad (2.3)$$

In the Rayleigh-Jeans limit ($h\nu \ll k_B T$), the relative fluctuation becomes

$$\frac{\Delta I(\nu)}{I_{\text{CMB}}} = \frac{\Delta T}{T_{\text{CMB}}}, \quad (2.4)$$

which remains frequency-independent. While ΔI is measured in Jy sr^{-1} , CMB studies typically use ΔT in K_{CMB} (or μK_{CMB}), commonly abbreviated as K. This measurement is referred to as the thermodynamic temperature.

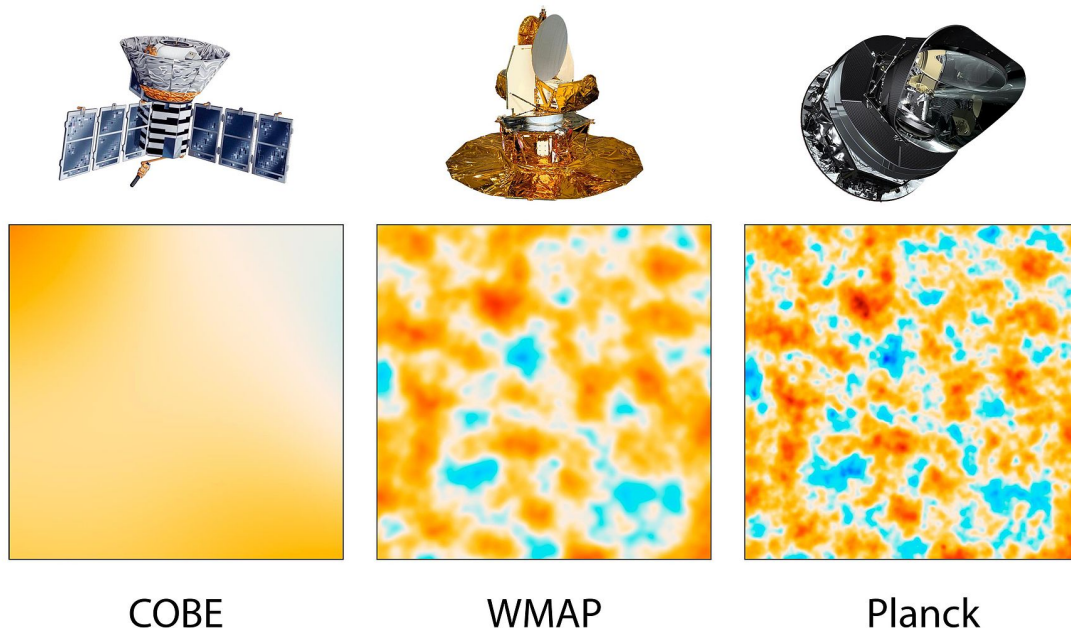

© 2013 NASA/JPL-Caltech/ESA

Figure 2.2: (top panels) Juxtaposition of the *COBE*, *WMAP*, and *Planck* satellite flight configurations, accompanied by their respective full-sky observations rendered in Mollweide projection, incorporating dipole anisotropy maps (explained in appendix A.1.1). (bottom panels) Comparative visualization of each satellite’s contribution to CMB map resolution within a $10^\circ \times 10^\circ$ sky segment. The angular resolution capabilities evolved significantly: *COBE* achieved 7° [30], *WMAP* attained 0.3° [31], and *Planck* reached an unprecedented $5'$ [29]. Image credit: NASA/JPL-Caltech/ESA.²

2.2.2 Quantification of anisotropies

To estimate cosmological parameters, including the age of the universe, from full-sky CMB temperature anisotropy maps, observations require quantification of surface fluctuations through spherical harmonic decomposition. Consider a spherical coordinate system centered on the observer, where the line-of-sight direction unit vector \hat{n} is defined as:

$$\hat{n} = (\sin \theta \cos \phi, \sin \theta \sin \phi, \cos \theta). \quad (2.5)$$

²https://lambda.gsfc.nasa.gov/education/graphic_history/microwaves.html

For a temperature distribution $T(\hat{n})$ on the celestial sphere, the mean temperature \bar{T} is:

$$\bar{T} = \int \frac{d\Omega}{4\pi} T(\hat{n}) = \int_{-1}^1 \frac{d(\cos\theta)}{2} \int_0^{2\pi} \frac{d\phi}{2\pi} T(\hat{n}). \quad (2.6)$$

Temperature anisotropy ΔT is defined as the deviation from this mean: $\Delta T = T - \bar{T}$. CMB temperature anisotropies arise from two sources: the Doppler effect due to observer motion and inherent anisotropies from cosmic matter distribution inhomogeneities. For mathematical analysis, temperature anisotropies can be expanded in spherical harmonics $Y_{\ell m}(\hat{n})$:

$$\Delta T(\hat{n}) = \sum_{\ell=1}^{\infty} \sum_{m=-\ell}^{\ell} a_{\ell m} Y_{\ell m}(\hat{n}), \quad (2.7)$$

where $a_{\ell m}$ are harmonic expansion coefficients which can be obtained by integrating over $d^2\hat{n}$:

$$a_{\ell m} = \int d^2\hat{n} \Delta T(\hat{n}) Y_{\ell m}^*(\hat{n}). \quad (2.8)$$

Here, $\ell = 0$ represents the monopole component (uniform component), $\ell = 1$ the dipole component, and $\ell = 2$ the quadrupole component. Higher ℓ values correspond to finer angular structures, with angular scale $\delta\theta \simeq \pi/\ell$. Large-angular structures are termed low- ℓ components, while small-angle structures are high- ℓ components. While the expansion coefficients $a_{\ell m}$ depend on coordinate origin, their squared sum $\sum_{m=-\ell}^{\ell} a_{\ell m} a_{\ell m}^*$ remains rotationally invariant. The spherical harmonics take the form:

$$Y_{\ell m}(\hat{n}) = (-1)^m \sqrt{\frac{2\ell+1}{4\pi} \frac{(\ell-m)!}{(\ell+m)!}} P_{\ell m}(\cos\theta) \exp(im\phi). \quad (2.9)$$

Figure 2.3 illustrates spherical harmonics up to $\ell = 4$ in Mollweide projection, showing only $|m|$ due to symmetry between $\pm m$.

The angular power spectrum C_{ℓ} is defined as:

$$C_{\ell} = \frac{1}{2\ell+1} \sum_{m=-\ell}^{\ell} a_{\ell m} a_{\ell m}^*. \quad (2.10)$$

To account for the Sachs-Wolfe effect [32], CMB studies commonly use the scaled power spectrum:

$$D_{\ell} = \frac{\ell(\ell+1)}{2\pi} C_{\ell}. \quad (2.11)$$

Figure 2.4 shows the CMB temperature anisotropy power spectrum measured by *Planck*. The larger error bars at low- ℓ reflect cosmic variance — a fundamental limitation arising from having only one observable universe, even with perfect measurements.

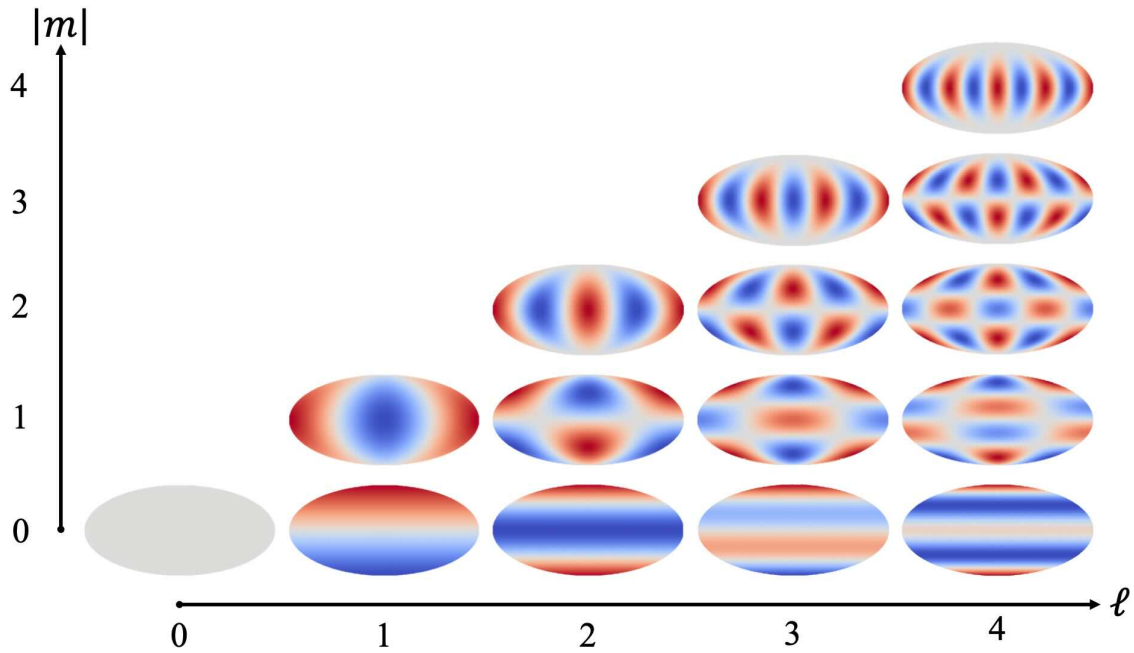

Figure 2.3: Mollweide projection of spherical harmonics for $\ell \leq 4$ and $|m|$.

2.3 Polarization anisotropies

2.3.1 Stokes parameters

The Stokes parameters provide a complete description of electromagnetic wave states and serve as observational quantities for characterizing polarization distributions across the celestial sphere. Consider measuring the electric field oscillation direction of incoming light along a line of sight. Treating the surrounding sky region as a plane, we define a Cartesian coordinate system (x, y) . If we denote the electric field components in the x and y directions as E_x^2 and E_y^2 , the electromagnetic wave intensities can be expressed as:

$$I_x \propto E_x^2, \quad (2.12)$$

$$I_y \propto E_y^2. \quad (2.13)$$

The Stokes parameter T , representing total intensity (or temperature anisotropy), also known as the unpolarized component, is given by:

$$T = I_x + I_y. \quad (2.14)$$

To characterize polarization, we define the Stokes parameter Q as the difference between the squared amplitudes of electric fields oscillating in the x and y directions:

$$Q \propto E_x^2 - E_y^2. \quad (2.15)$$

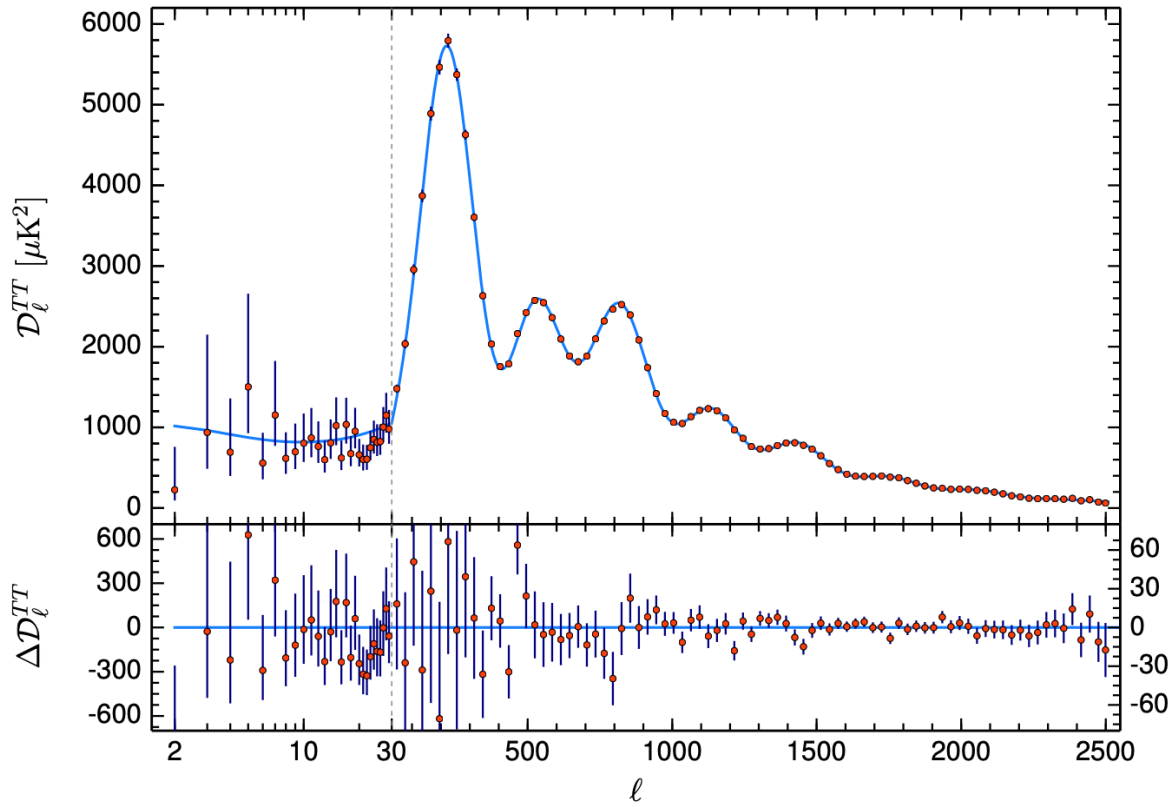

Figure 2.4: CMB temperature anisotropy power spectrum measured by *Planck*. The horizontal axis shows multipole moment ℓ , with higher values corresponding to smaller angular scales. The vertical axis shows D_ℓ in units of μK^2 . Red points indicate measurements, while the blue line shows the best-fit ΛCDM model. The figure is adapted from ref. [28] with a permission from the publisher.

The Stokes parameter U is similarly defined in a coordinate system (x', y') rotated by 45 degrees:

$$U \propto E_{x'}^2 - E_{y'}^2. \quad (2.16)$$

These polarization components Q and U are coordinate-dependent. Under a coordinate rotation by angle φ , they transform as:

$$\begin{pmatrix} Q' \\ U' \end{pmatrix} = \begin{pmatrix} \cos 2\varphi & \sin 2\varphi \\ -\sin 2\varphi & \cos 2\varphi \end{pmatrix} \begin{pmatrix} Q \\ U \end{pmatrix}. \quad (2.17)$$

Using complex notation, we can express this transformation more concisely:

$$Q' \pm iU' = \exp(\mp 2i\varphi)(Q \pm iU). \quad (2.18)$$

The factor of 2 in the exponential represents the *spin* of the transformation, reflecting how the Stokes parameters return to their original values under a 180° rotation. While a fourth Stokes parameter V exists to describe circular polarization, we omit its discussion as CMB polarization is known to be purely linear.

2.3.2 E -mode and B -mode polarization

While Stokes parameters Q and U can describe polarization, their coordinate-dependent nature can lead to confusion in quantitative polarization analysis. To address this, we introduce coordinate-independent representations: E -mode and B -mode polarization [11, 12, 33]. Consider a small sky region around an arbitrary line of sight with a 2D Cartesian coordinate system. Let the position vector from the center be:

$$\boldsymbol{\theta} = (x, y) = (\theta \cos \phi, \theta \sin \phi), \quad (2.19)$$

For Stokes parameters at position $\boldsymbol{\theta}$ on the celestial sphere, we can express their 2D Fourier expansion using wave vector $\boldsymbol{\ell} = (\ell \cos \phi_\ell, \ell \sin \phi_\ell)$:

$$Q(\boldsymbol{\theta}) + iU(\boldsymbol{\theta}) = \int \frac{d^2\ell}{(2\pi)^2} a_\ell \exp(i\boldsymbol{\ell} \cdot \boldsymbol{\theta}), \quad (2.20)$$

Since $Q + iU$ transforms under coordinate rotation, the Fourier coefficients a_ℓ also change. To compensate for the $\exp(-2i\varphi)$ factor from eq. (2.18), we define:

$$a_\ell = -{}_2a_\ell \exp(2i\phi_\ell) \quad (2.21)$$

Rewriting eq. (2.20) yields:

$$Q(\boldsymbol{\theta}) \pm iU(\boldsymbol{\theta}) = - \int \frac{d^2\ell}{(2\pi)^2} \pm 2a_\ell \exp(\pm 2i\phi_\ell + i\boldsymbol{\ell} \cdot \boldsymbol{\theta}), \quad (2.22)$$

We introduce new quantities E_ℓ and B_ℓ defined as:

$$\pm 2a_\ell \equiv -(E_\ell \pm iB_\ell), \quad (2.23)$$

This transforms eq. (2.22) into:

$$Q(\boldsymbol{\theta}) \pm iU(\boldsymbol{\theta}) = \int \frac{d^2\ell}{(2\pi)^2} (E_\ell \pm iB_\ell) \exp(\pm 2i\phi_\ell + i\boldsymbol{\ell} \cdot \boldsymbol{\theta}), \quad (2.24)$$

The relationship with original coefficients is:

$$E_\ell = -\frac{1}{2}(2a_\ell + {}_2a_\ell), \quad (2.25)$$

$$B_\ell = \frac{1}{2}i(2a_\ell - {}_2a_\ell), \quad (2.26)$$

with complex conjugates $E_\ell^* = E_{-\ell}$ and $B_\ell^* = B_{-\ell}$. The inverse transform is:

$$E_\ell \pm iB_\ell = \int d^2\theta (Q + iU)(\boldsymbol{\theta}) \exp(\mp i\phi_\ell - i\boldsymbol{\ell} \cdot \boldsymbol{\theta}), \quad (2.27)$$

As shown in figure 2.5, E_ℓ represents polarization parallel or perpendicular to the wave vector $\boldsymbol{\ell}$, while B_ℓ represents polarization rotated by 45° . These are termed E - and B -mode polarization, respectively. While coordinate rotation affects both polarization and $\boldsymbol{\ell}$ directions,

their relative orientation (parallel, perpendicular, or 45°) remains invariant, making E and B modes coordinate-independent quantities. E and B modes can be viewed as Stokes parameters Q and U defined with ℓ as the x -axis. As evident in figure 2.5, E -mode polarization is parity-invariant, while B -mode polarization changes sign under parity transformation, providing a clear distinction between these modes.

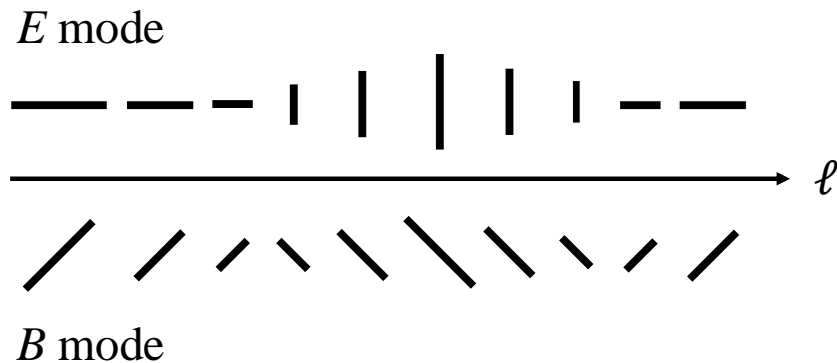

Figure 2.5: Visualization of E - and B -mode polarization patterns. Line lengths represent Stokes parameter magnitudes. ℓ -axis is the wavenumber vector direction. E -mode polarization is parallel or perpendicular to ℓ , while B -mode polarization is rotated by 45° .

To define E - and B -mode polarization globally across the celestial sphere, rather than just locally on a plane, we employ spherical harmonics instead of 2D Fourier transforms. While standard spherical harmonics are invariant under $\phi \rightarrow \phi + 2\pi$ rotations, polarization, being a $spin-2$ quantity, is invariant under $\phi \rightarrow \phi + \pi$ transformations. We define basis functions satisfying this transformation in 2D as:

$${}_{\pm 2}Y(\ell) \equiv \frac{1}{\ell^2} \left(\frac{\partial}{\partial x} \pm i \frac{\partial}{\partial y} \right)^2 \exp(i\ell \cdot \boldsymbol{\theta}) = -\exp(\pm 2i\phi_\ell + i\ell \cdot \boldsymbol{\theta}), \quad (2.28)$$

These are called $spin-2$ harmonic functions, derived from second-order derivatives of the standard harmonic functions $\exp(i\ell \cdot \boldsymbol{\theta})$ used for Fourier transforms of $spin-0$ quantities like temperature anisotropies. Using these, eq. (2.24) becomes:

$$Q(\boldsymbol{\theta}) \pm iU(\boldsymbol{\theta}) = \int \frac{d^2\ell}{(2\pi)^2} (E_\ell \pm iB_\ell) {}_{\pm 2}a_{\ell\pm 2} Y(\ell), \quad (2.29)$$

We can generalize the definition of Stokes parameters Q and U by considering arbitrary orthogonal basis vectors $\mathbf{e}_1, \mathbf{e}_2$ instead of fixed x and y directions. Defining complex basis vectors:

$$\mathbf{e}_\pm \equiv \frac{1}{\sqrt{2}}(\mathbf{e}_1 \pm i\mathbf{e}_2), \quad (2.30)$$

eq. (2.28) can be rewritten as:

$${}_{\pm 2}Y(\ell) = \frac{2}{\ell^2} \sum_{i,j} e_{\pm i} e_{\pm j} \tilde{\nabla}_i \tilde{\nabla}_j \exp(i\ell \cdot \boldsymbol{\theta}), \quad (2.31)$$

where $\tilde{\nabla}$ represents derivatives perpendicular to the line-of-sight direction \hat{n} on the celestial sphere. In spherical coordinates centered on the observer, with \mathbf{e}_1 along θ and \mathbf{e}_2 along ϕ , the relationship between spherical and Cartesian Stokes parameters becomes:

$$(Q + iU)_{\text{spherical}} = \exp(-2i\phi)(Q + iU)_{\text{cartesian}}, \quad (2.32)$$

Using *spin*- ± 2 spherical harmonics ${}_{\pm 2}Y_{\ell m}$, eq. (2.29) becomes [12]:

$$(Q \pm iU)(\hat{n}) = \sum_{\ell=2}^{\infty} \sum_{m=-\ell}^{\ell} {}_{\pm 2}a_{\ell m} {}_{\pm 2}Y_{\ell m}(\hat{n}). \quad (2.33)$$

The *spin*-2 spherical harmonics can be expressed through second derivatives of standard spherical harmonics:

$${}_{\pm 2}Y_{\ell m} = 2\sqrt{\frac{(\ell-2)!}{(\ell+2)!}} \sum_{i,j} e_{\pm i} e_{\pm j} \tilde{\nabla}_i \tilde{\nabla}_j Y_{\ell m}(\hat{n}), \quad (2.34)$$

Defining ${}_{\pm 2}a_{\ell m} \equiv -(E_{\ell m} \pm iB_{\ell m})$, the full-sky *E*- and *B*-mode polarization components are:

$$E_{\ell m} = -\frac{1}{2}(2a_{\ell m} + {}_{-2}a_{\ell m}), \quad (2.35)$$

$$B_{\ell m} = \frac{1}{2}i(2a_{\ell m} - {}_{-2}a_{\ell m}), \quad (2.36)$$

The power spectra for *E* and *B* modes are [33]:

$$\langle E_{\ell m} E_{\ell' m'}^* \rangle = C_{\ell}^{EE} \delta_{\ell\ell'} \delta_{mm'}, \quad (2.37)$$

$$\langle B_{\ell m} B_{\ell' m'}^* \rangle = C_{\ell}^{BB} \delta_{\ell\ell'} \delta_{mm'}, \quad (2.38)$$

The temperature-polarization correlation can be expressed as:

$$C_{\ell}^{XY} = \frac{1}{2\ell+1} \sum_m s a_{\ell m}^X a_{\ell m}^{Y*}, \quad (2.39)$$

where X, Y can be *T*, *E*, or *B*, and s denotes the *spin*. While C_{ℓ}^{TT} , C_{ℓ}^{TE} , C_{ℓ}^{EE} , and C_{ℓ}^{BB} have even parity, C_{ℓ}^{TB} and C_{ℓ}^{EB} have odd parity and vanish due to the absence of correlation between temperature anisotropies and *B*-mode polarization, and between *E*- and *B*-mode polarization.

2.3.3 Generation of polarization anisotropies

The CMB polarization originates through Thomson scattering interactions between photons and electrons [34, 35], and it was discovered by DASI experiment in 2002 [36]. To understand this mechanism, consider a scenario depicted in figure 2.6, where an electron is positioned at the origin of a three-dimensional Cartesian coordinate system. When the surrounding radiation field exhibits monopole symmetry (left), no net polarization is observed along the z -axis due to the perfect spherical symmetry of the distribution. Similarly, a dipole distribution (middle) produces no polarized emission along the observation direction. However, when the radiation field

possesses quadrupole anisotropy (right), Thomson scattering preferentially generates polarized light along the z -axis. This fundamental process underlies the generation of CMB polarization anisotropies.

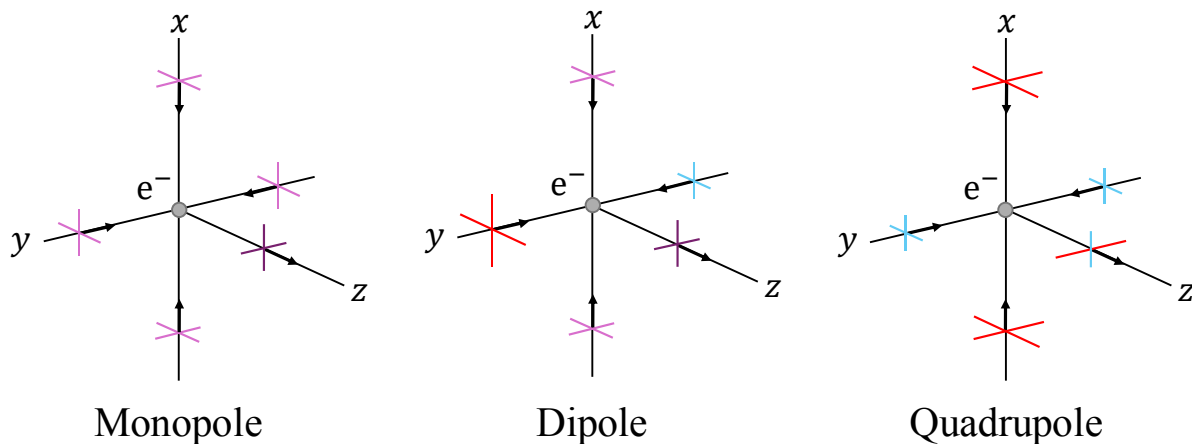

Figure 2.6: Generation of CMB polarization anisotropies. The figure represents an electron at the origin of a Cartesian coordinate system. (left) Monopole radiation field with perfect spherical symmetry. (middle) Dipole radiation field with no net polarization along the z -axis. (right) Quadrupole radiation field producing polarized light along the z -axis.

In viscous fluids, anisotropic stress — a drag-like force — acts on the fluid. Prior to the last scattering epoch, photons interacted with baryons through Thomson scattering, which suppressed anisotropic stress. However, as recombination occurred and the coupling between baryons and the photon fluid weakened, anisotropic stress increased significantly, enabling the formation of anisotropies [37]. The non-isotropic stress responsible for generating quadrupole anisotropies originates from two distinct sources: acoustic waves (scalar perturbations) and gravitational waves (tensor perturbations).

2.3.4 Polarization from scalar perturbations

The scalar perturbations, i.e., the acoustic waves in fluids generate scalar anisotropic stress. Figure 2.7 (left) illustrates how a single acoustic wave with Fourier wavenumber \mathbf{q} propagating along the z -axis generates E -mode polarization. The photon fluid develops regions of varying density along the z -axis following the acoustic wave compressions and rarefactions, depicted by alternating black and gray shading. The four circles in the right hemisphere represent temperature quadrupole anisotropies as seen by electrons. Each circle contains an electron at its center, with white circles indicating directions of higher temperature and dark gray circles showing directions of lower temperature. Consider an observer at the center of the celestial sphere. As the elevation angle θ increases according to the left diagram in figure 2.7 (left), the observed polarization direction and intensity vary as shown in the right diagram. The length of the polarization bars is proportional to $\sin^2 \theta$. In a coordinate system where the Fourier wavevector \mathbf{q} aligns with the z -axis, $Q > 0$ and $U = 0$, reflecting the axial symmetry of scalar perturbations which are independent of azimuthal angle ϕ . This analysis reveals that under anisotropic stress from acoustic waves, the polarization direction remains either perpendicular

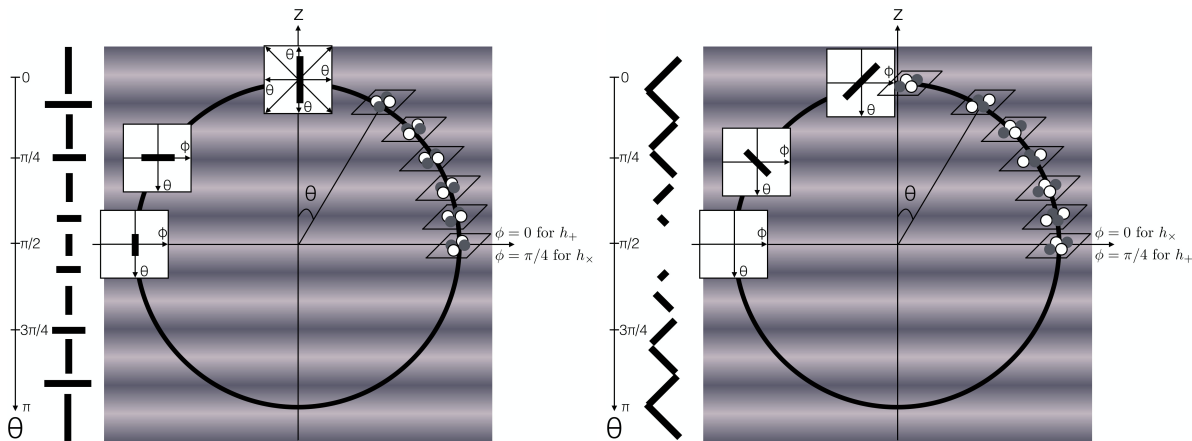

Figure 2.7: (left) E -mode polarization generated by scalar perturbations. (right) B -mode polarization generated by tensor perturbations. The left diagram shows the acoustic wave’s effect on the photon fluid, with alternating black and gray shading representing regions of varying density. The right diagram depicts quadrupole temperature anisotropy distributions generated by gravitational waves. The figures are adapted from ref. [38] with a permission from the publisher.

or parallel to the direction of elevation angle θ variation, conclusively identifying it as E -mode polarization.

2.3.5 Polarization from tensor perturbations

Under tensor-type anisotropic stress from gravitational waves, axial symmetry is broken, introducing $\cos 2\phi$ and $\sin 2\phi$ dependencies in the azimuthal angle. This generates non-zero U polarization, corresponding to B -mode polarization [13].

In a three-dimensional space defined by coordinates $x^1x^2x^3$, let D_{ij} represent gravitational waves. With wave propagation along the x^3 direction, D_{ij} has non-zero components in the x^1 - x^2 plane:

$$D_{ij} = \begin{pmatrix} h_+ & h_\times & 0 \\ h_\times & -h_+ & 0 \\ 0 & 0 & 0 \end{pmatrix}. \tag{2.40}$$

As illustrated in figure 2.8, consider the effect of these gravitational waves on test particles arranged in a circle in the x^1 - x^2 plane. When h_+ increases, space stretches along the x^1 direction, increasing the distance between particles along this axis. Since gravitational waves preserve area, the distance between particles along the x^2 direction decreases correspondingly. The opposite occurs when h_+ decreases. Conversely, when h_\times increases, space stretches along the 45° direction in the x^1 - x^2 plane while contracting in the perpendicular direction. These deformation patterns define the plus (+) mode and cross (\times) mode, associated with h_+ and h_\times variations respectively.

For gravitational waves propagating along the z -axis, figure 2.7 (right) shows the quadrupole distribution generated by \dot{h}_\times with the horizontal axis at $\phi = 0^\circ$, or by \dot{h}_+ at $\phi = 45^\circ$. Thomson

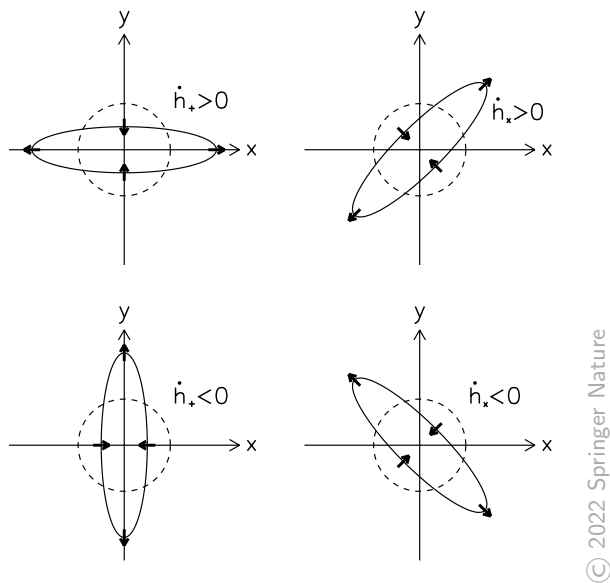

Figure 2.8: Deformation patterns of gravitational waves. The left diagram shows the plus (+) mode, with space stretching along the x^1 direction and contracting along the x^2 direction. The right diagram illustrates the cross (\times) mode, with space stretching along the 45° direction in the x^1 - x^2 plane. The figure adapted from ref. [38] with a permission.

scattering of these quadrupole temperature anisotropies by electrons at the LSS produces the polarization patterns and intensities illustrated in each figure. The observed polarization distribution represents a superposition of these contributions. Notably, in figure 2.7 (right), the polarization direction maintains a 45° angle relative to the direction of polar angle θ variation, definitively identifying it as B -mode polarization. Figure 2.9 illustrates the full-sky projection of E - and B -mode polarization patterns, analogous to the geometrical representation shown in figure 2.7, providing a comprehensive visualization of their distinct characteristics.

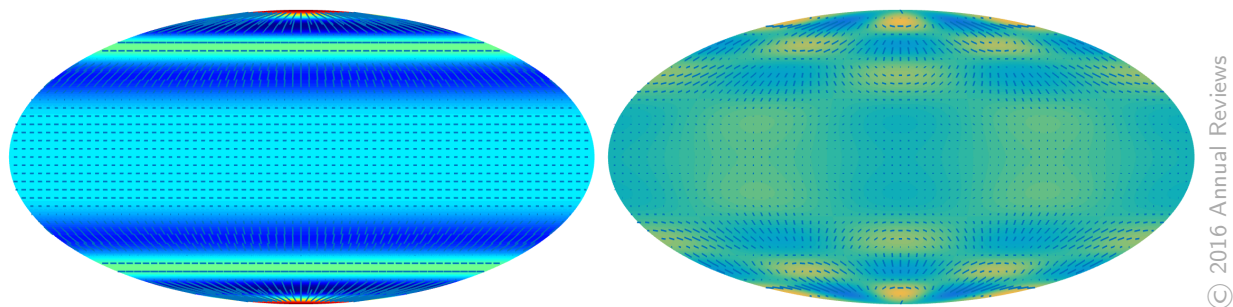

Figure 2.9: (left) Full-sky projection illustrating E -mode polarization patterns generated by a single Fourier mode of the density perturbation field. (right) Full-sky projection depicting B -mode polarization patterns induced by a single gravitational wave. The figures are adapted from ref. [39] with a permission from the publisher.

2.4 Primordial gravitational waves from cosmic inflation

The cosmic inflation provides crucial initial conditions for the Big Bang theory and offers solutions to several problems associated with it, e.g., the horizon and flatness problem [6–8]. According to this hypothesis, the universe underwent exponential spatial expansion in its early stages, stretching quantum fluctuations over a brief period. The field responsible for driving inflation is called the inflaton field, denoted by ϕ . Its time evolution is governed by the equation of motion and the Friedmann equation [40]:

$$\ddot{\phi} + 3H\dot{\phi} + V'(\phi) = 0, \quad (2.41)$$

$$H^2 = \frac{1}{3m_{pl}^2} \left[V(\phi) + \frac{\dot{\phi}^2}{2} \right], \quad (2.42)$$

where H is the Hubble parameter, m_{pl} is the Planck mass defined as $m_{pl} = (8\pi G)^{-1/2}$ with G being the gravitational constant, and V is the potential of the inflaton field. Various inflation models are characterized by the form of V . A notable example is the slow-roll inflation model for a single scalar field [41]. The slow-roll parameters ϵ_V and η_V are defined as:

$$\epsilon_V \simeq \frac{m_{pl}^2}{2} \left(\frac{V'}{V} \right)^2, \quad (2.43)$$

$$\eta_V \simeq \frac{m_{pl}^2 V''}{V}. \quad (2.44)$$

When $\epsilon_V \ll 1$ and $|\eta_V| \ll 1$, the inflaton field changes slowly over time, a process referred to as slow-rolling, analogous to a particle gently rolling down a slope. Examples of potential shapes are shown in ref. figure 2.10 (left) representing a quadratic potential and (right) a hilltop potential. The quadratic model is also known as the large-field model, while the hilltop potential is a small-field model. In the large-field model group, there are chaotic inflationary models, natural inflation models [42,43]. In the small-field model group, there is the Starobinsky model as a representative model [44]. Their power spectra are given by:

$$\mathcal{P}_R(k) = A_s \left(\frac{k}{k_*} \right)^{n_s - 1 + \frac{1}{2} \frac{dn_s}{d \ln k} \ln(k/k_*) + \dots}, \quad (2.45)$$

$$\mathcal{P}_t(k) = A_t \left(\frac{k}{k_*} \right)^{n_t + \frac{1}{2} \frac{dn_t}{d \ln k} \ln(k/k_*) + \dots}, \quad (2.46)$$

where k is the wavenumber, A_s and A_t are the amplitudes of scalar and tensor modes, respectively, and n_s and n_t are their spectral indices. The value of the inflaton field when the mode with wavenumber $k_* = a_* H_*$ first crosses the Hubble radius is denoted by ϕ_* . The pivot scale

$k_* = 0.05 \text{ Mpc}^{-1}$ is commonly used. The coefficients are related to the slow-roll parameters as:

$$A_s \approx \frac{V}{24\pi^2 m_{pl}^4 \epsilon_V}, \quad (2.47)$$

$$A_t \approx \frac{2V}{3\pi^2 m_{pl}^4}, \quad (2.48)$$

$$n_s - 1 \approx 2\eta_V - 6\epsilon_V, \quad (2.49)$$

$$n_t \approx -2\epsilon_V. \quad (2.50)$$

During the inflationary epoch, the potential maintains a notably flat configuration, characterized by the conditions $\epsilon_V \ll 1$ and $|\eta_V| \ll 1$, though these parameters do not precisely vanish. As a consequence, the scalar spectral index n_s exhibits a slight deviation from unity, as evident from eq. (2.49). This departure from perfect scale invariance, known as the primordial tilt, stands as a fundamental prediction of inflationary theory, definitively establishing that $n_s \neq 1$. Historically, it was estimated that $n_s = 0.9646 \pm 0.0098$ by 9-years *WMAP* results which implies a non-zero tilt in the primordial spectrum (i.e., $n_s < 1$) at 3.6σ [45], and later by *Planck* 2013 results, they detected $n_s = 0.9600 \pm 0.0072$, a 5.5σ departure from $n_s = 1$ [46].

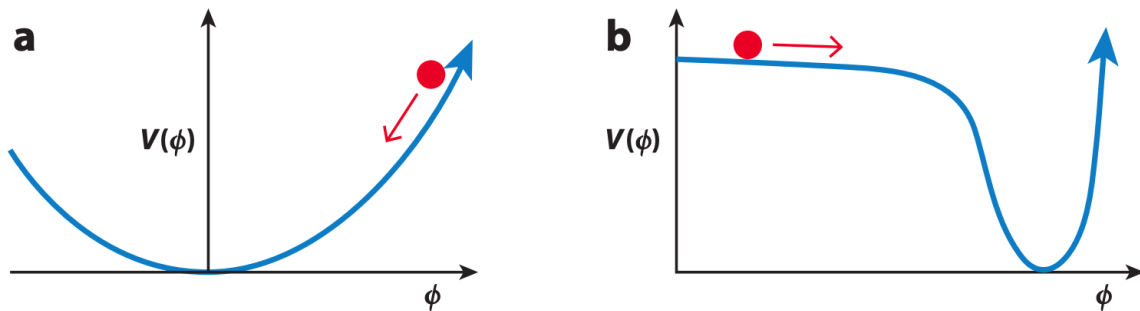

Figure 2.10: Typical potentials in the slow-roll inflation model: quadratic potential (left) and hilltop potential (right). The figure is adapted from ref. [39], with permission of the publisher.

2.4.1 Primordial gravitational waves and tensor-to-scalar ratio

The inflation hypothesis, which posits exponential spatial expansion in the early universe, also predicts the stretching of quantum fluctuations, leading to the formation of gravitational waves [10]. These primordial gravitational waves, generated during the universe's inception, are expected to exist on ultra-long wavelengths spanning billions of light-years [9]. The *B*-mode polarization produced by these waves on the LSS is specifically termed primordial *B*-mode polarization. The parameter representing the strength of primordial gravitational waves is the tensor-to-scalar ratio, r , defined as:

$$r = \frac{\mathcal{P}_t(k_*)}{\mathcal{P}_R(k_*)} \approx 16\epsilon_V \approx -8n_t. \quad (2.51)$$

Accurate measurement of the B -mode polarization power spectrum allows for the determination of r . Numerous CMB polarization experiments worldwide aim to detect this signature, but the primordial B -mode polarization remains undetected due to its extremely weak intensity, and r has not yet been discovered. Currently, various experiments provide upper limits on r . Before the results from *WMAP*, the chaotic inflation model with a potential proportional to ϕ^4 was predominant [42]. However, the *WMAP* 3-years data released in 2006 ruled out this model, leading to increasingly stringent constraints on r . Consequently, many quadratic potential models, including those proportional to ϕ^3, ϕ^2, ϕ and $\phi^{2/3}$ (classified under the left panel of figure 2.10), were also ruled out. This shift in understanding brought attention to inflation models capable of explaining smaller values of r , with the Starobinsky model [44] (classified under the right panel of figure 2.10) being a representative example.

The upper limit on r at the pivot scale 0.002 from the *Planck* 2018 data and the ground-based *BICEP2/Keck — BK15* dataset is estimated to be [16]:

$$r_{0.002} < 0.036 \quad (95\% \text{ confidence level}). \quad (2.52)$$

The value of r is directly related to the energy scale of inflation $V^{1/4}$ [47]:

$$V^{1/4} = 1.04 \times 10^{16} \text{GeV} \left(\frac{r}{0.01} \right)^{1/4}. \quad (2.53)$$

Detecting a non-zero r from primordial B -mode polarization observations would not only validate the inflation hypothesis but also provide insights into the inflation mechanism, contributing to the development of fundamental theories such as quantum gravity and grand unified theories.

2.5 Implications of angular power spectrum

Having established precise definitions for E - and B -mode polarization, eq. (2.39) enables computation of the auto-correlation power spectrum D_ℓ , illustrated in figure 2.11. The CMB power spectrum encodes a wealth of cosmological information, and through sophisticated analysis techniques such as maximum likelihood estimation, researchers have successfully constrained fundamental cosmological parameters [48]. These calculations were executed using CAMB, a sophisticated cosmological parameter-based power spectrum software [49–51].³ Among these components, the ‘Primordial C_ℓ^{BB} ’, representing the power spectrum of B -mode polarization originating from primordial gravitational waves, remains the sole unmeasured element. The distinct peaks, troughs, and high- ℓ region attenuation observed in these power spectra each arise from unique physical phenomena.

2.5.1 Temperature anisotropies power spectrum

The power spectrum of temperature anisotropies, denoted by C_ℓ^{TT} , exhibits remarkable characteristics across different angular scales. At large angular scales ($\ell \lesssim 20$), the spectrum maintains near-constant values due to the Sachs-Wolfe effect, independent of the $\ell(\ell + 1)/2\pi$ scaling [32].

³<https://camb.readthedocs.io/en/latest/>

A prominent acoustic peak emerges around $\ell \lesssim 200$, which is measured by BOOMERanG and MAXIMA-1 experiment [52, 53].

The existence of acoustic oscillations in the pre-recombination universe was theoretically established in [54]. The horizon, defined as the causal region where information propagates at light speed, is approximately determined by the inverse of the Hubble parameter, commonly known as the Hubble length [55]. An analogous concept applies to acoustic waves within the baryon-photon fluid constrained by Thomson scattering, termed the sound horizon. During inflation, fluctuations remain frozen outside the horizon due to exponential expansion. Upon inflation's conclusion, these fluctuations re-enter the horizon, establishing density distributions in the baryon-photon fluid and generating sound waves.

The series of peaks observed around $\ell \lesssim 1000$ correspond to the fundamental mode and subsequent overtones of these sound waves. For smaller angular scales ($\ell \gtrsim 1000$), the acoustic oscillations experience significant attenuation due to the Silk damping effect [56]. This damping occurs as the universe transitions to transparency and the baryon-photon fluid coupling weakens, causing exponential suppression of short-wavelength sound waves.

2.5.2 E -mode power spectrum

The power spectrum C_ℓ^{EE} of E -mode polarization exhibits peaks and troughs that are anti-phased with those of C_ℓ^{TT} . This phase opposition stems from the dominant role of scalar anisotropic stress, originating from acoustic waves, in generating E -mode polarization [57].

The general solution to the acoustic wave equation can be expressed as a linear combination of sine and cosine terms with constant coefficients. For adiabatic perturbations, the cosine term dominates, while for Cold Dark Matter (CDM) curvature perturbations, the sine term prevails. Observational data of the temperature power spectrum aligns well with the cosine-model solution characteristic of adiabatic perturbations. The velocity field potential solution must follow a sine-model pattern due to the connection between anisotropic stress and energy conservation.

Since scalar perturbations generate anisotropic stress through velocity field gradients, the resulting E -mode power spectrum naturally creates with a phase opposite to that of the temperature anisotropies power spectrum, as shown in figure 2.11. A comprehensive derivation from the Boltzmann equations can be found in [58], which provides a detailed theoretical framework for understanding these phase relationships.

Before recombination, Thomson scattering suppressed anisotropic stress in the baryon-photon fluid, preventing polarization. However, after recombination, while acoustic waves began to experience Silk damping, polarization started to form. Thus, for $\ell \lesssim 200$, C_ℓ^{TT} begins to decrease, whereas C_ℓ^{EE} increases. At higher ℓ , the E -mode power spectrum also diminishes due to Silk damping.

A notable feature of E -mode polarization is the peak at $\ell \lesssim 20$. This peak arises from the reionization of hydrogen atoms, which were ionized by ultraviolet radiation from newly formed stars after recombination. This event, known as the cosmic reionization, occurred around redshift $z \lesssim 20$. The scattering probability of photons with intergalactic gas, including hydrogen, is described by the optical depth τ , and the polarization intensity depends on τ .

Temperature anisotropies and polarization with wavelengths shorter than the Hubble length at redshift z are smoothed by Thomson scattering, decaying as $\exp(-\tau)$. In contrast, fluctuations with wavelengths comparable to the Hubble length are less affected by Thomson scattering, and their polarization intensity is proportional to τ . Since cosmic reionization occurred at $z \lesssim 20$, new polarization is generated on relatively large angular scales ($\ell \lesssim 10$).

Currently, τ remains the least precisely determined parameter in standard cosmology, limiting our ability to compare CMB anisotropies with matter distribution clustering, particularly for measuring neutrino mass sums [59–63].

2.5.3 Lensing B -mode power spectrum

The lensing C_ℓ^{BB} represents the power spectrum of B -mode polarization generated by the gravitational lensing [64]. While B -mode polarization was initially thought to be produced solely by tensor anisotropic stress from gravitational waves, gravitational lensing can convert E -mode polarization into B -mode polarization (and vice versa, though this effect is minor). This lensing effect mixes power spectra of different ℓ values. The mixing effect depends on the variance of the angle difference of light bent by gravitational lensing at two points on the celestial sphere. This can be expressed as a convolution integral with a Gaussian factor involving the variance and ℓ [65].

As a result, the lensing C_ℓ^{BB} appears as a smoothed version of the E -mode polarization. This B -mode polarization from gravitational lensing was first detected by the *BICEP2* experiment in 2016 [66]. Gravitational lensing affects not only polarization but also the temperature power spectrum, causing a smoothing effect. This phenomenon was first observed by ref. [67], predating the detection of lensing B -mode polarization.

2.5.4 Primordial B -mode power spectrum

The Primordial C_ℓ^{BB} represents the power spectrum of B -mode polarization generated by primordial gravitational waves. The peaks at $\ell \sim 2$ and $\ell \sim 80$ are known as the reionization and recombination bumps, respectively. While the latter peak is historically termed the recombination bump, it's worth noting that there was no prior period of proton-electron combination before the last scattering epoch. At large ℓ , the power spectrum's attenuation stems from the redshift-induced amplitude decay of gravitational waves during cosmic expansion, exhibiting a power-law decay with ℓ . Unlike acoustic waves affected by Silk damping, gravitational waves, being transverse waves, experience no viscous dissipation. The oscillations observed at $\ell \gtrsim 100$ differ from acoustic oscillations; each ℓ corresponds to fluctuations entering the horizon at different times, with oscillation phases determined by the number of gravitational wave cycles between horizon entry and last scattering.

The primordial gravitational wave amplitude, and consequently its power spectrum, scales proportionally with the tensor-to-scalar ratio r . Figure 2.11 displays primordial C_ℓ^{BB} for $r = 0.01$ and 0.001 . The observed B -mode power spectrum C_ℓ^{BB} comprises both lensing and primordial components. Since representative single-field slow-roll inflation models predict $r \geq 0.01$ [41], we illustrate the total C_ℓ^{BB} as the sum of lensing and primordial components assuming $r = 0.01$.

Determining r requires precise measurement of the reionization and recombination bump amplitudes. Particularly, detecting smaller r values (e.g., $r = 0.001$) necessitates accurate measurement of the reionization bump. Since this feature manifests at low ℓ , corresponding to large angular scales on the celestial sphere, observations covering wide sky areas become crucial.

In 2014, the *BICEP2* experiment conducted unprecedented large-angular scale B -mode polarization measurements from the ground, initially reporting $r = 0.20$ [68]. However, this single-frequency (150 GHz) measurement could not adequately account for galactic dust foreground contamination, and subsequent joint analysis with *Planck* data led to its retraction. This experience highlighted the importance of multi-frequency observations for proper foreground removal, in addition to large-angular scale coverage.

As of 2022, the *BICEP2* collaboration, incorporating data from *WMAP*, *Planck*, and the ground-based Keck Array, has established an upper limit of $r_{0.05} < 0.036$ at 95% confidence level [16]. This analysis achieved an unprecedented precision with an uncertainty of $\sigma(r) = 0.009$, representing the most stringent constraints on r to date.

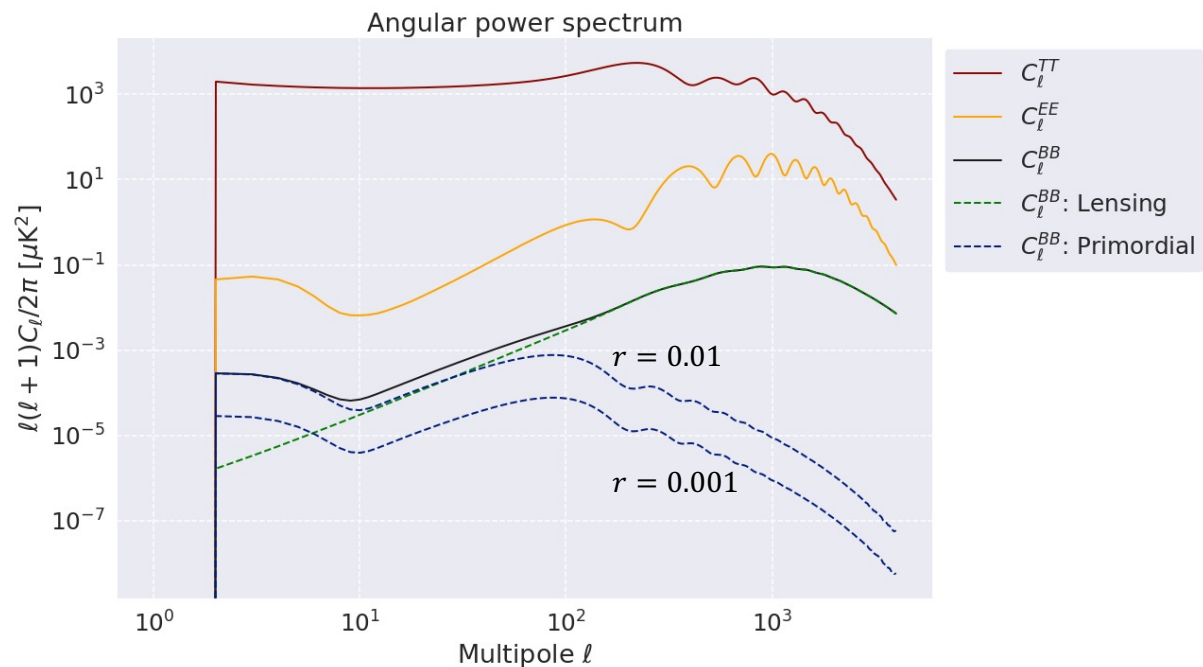

Figure 2.11: Power spectra $C_\ell^{TT,EE,BB}$ calculated using CAMB. The C_ℓ^{BB} components are shown separately as lensing (green dashed line) and primordial (blue dashed line). The observed C_ℓ^{BB} would be the sum of these components; for instance, if the true value is $r = 0.01$, the measured C_ℓ^{BB} would follow the black line.

Chapter 3

Scanning strategies of CMB space missions

Contents

3.1 Scanning strategy of past CMB space missions	26
3.1.1 <i>COBE</i>	26
3.1.2 <i>WMAP</i>	27
3.1.3 <i>Planck</i>	28
3.2 Summary of scanning parameters across CMB space missions	29
3.3 <i>LiteBIRD</i> space mission	29
3.3.1 Polarization modulation with half-wave plates	32

This chapter delves into the scanning strategies utilized by various CMB space missions, from the pioneering *COBE*'s Sun Synchronous Orbit to the advanced Lagrange point 2-based missions. We follow the evolution of these strategies, focusing on their unique methods for achieving full-sky coverage. Key technical parameters, such as spin and precession axis angles, and rotation periods, are thoroughly examined. The chapter also introduces the *LiteBIRD* mission, which inspired this study, highlighting its use of HWP. Finally, we summarize the scanning parameters across different CMB missions, underscoring the critical role of optimized scanning strategies in attaining high-precision CMB polarization measurements.

3.1 Scanning strategy of past CMB space missions

3.1.1 *COBE*

COBE was deployed in a Sun Synchronous Orbit (SSO), which is a specialized polar orbit designed for CMB spectrum and full-sky temperature anisotropy measurements [69]. The SSO's key advantage lies in maintaining a constant angle between the orbital plane and the Sun, ensuring stable solar radiation exposure throughout the mission. For SSO configurations with

inclination angles above 95° , the Earth's oblate shape induces orbital plane rotations completing one cycle annually, facilitating comprehensive sky coverage.

The satellite spins at 0.8 rpm, a rate carefully selected to reduce noise and systematic effects from radiometer gain and offset variations. This pioneering research on the relationship between scanning strategies and noise characteristics was thoroughly examined in [70]. Three primary instruments were aboard: FIRAS, DMR (Differential Microwave Radiometers), and DIRBE (Diffuse Infrared Background Experiment). FIRAS, aligned with the spin axis, measured sky frequency spectra through a 7° field of view (FoV). The DMR system comprised three receiver pairs, positioned 120° apart around the dewar's aperture plane. Each radiometer measured differential sky signals between horn pairs with 7° FoV separated by 60° , positioned 30° from the spin axis.

Both DMR and DIRBE instruments traced epicyclic patterns, enabling daily scans of half the sky and facilitating comprehensive multipole measurements for each sky pixel.

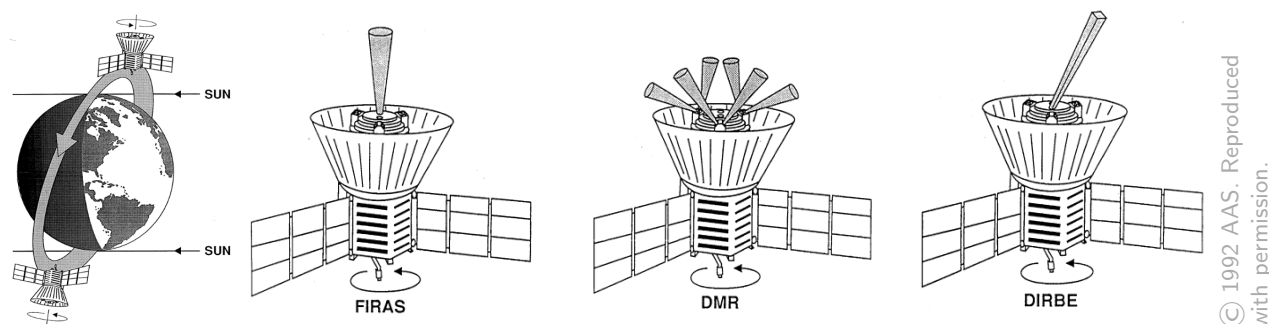

© 1992 AAS. Reproduced with permission.

Figure 3.1: *COBE*'s SSO scanning strategy (leftmost) and instrument layout: FIRAS (center-left), DMR (center-right), and DIRBE (rightmost). Rotation schematic shows satellite's spin. The figure is adapted from ref. [69] with a permission from the authors and the publisher.

3.1.2 *WMAP*

WMAP aimed to observe the full-sky temperature anisotropy previously measured by *COBE* at higher angular resolution, with the goal of estimating cosmological parameters from the power spectrum [71]. As the first CMB satellite deployed at Lagrange point 2 (L_2), it combined precession, spin, and solar orbit rotations for comprehensive sky coverage. This three-rotation scanning strategy offers high flexibility and has become a fundamental concept for L_2 -based space mission, allowing optimization for specific mission objectives. In this scanning approach, α defines the angle between the Sun- L_2 vector and precession axis, while β represents the angle between the spin axis and telescope pointing direction (figure 3.2).

WMAP's scanning strategy, configured with the parameters shown in figure 3.2, was designed to minimize systematic errors through several key considerations: rapid scanning of most of the sky to minimize $1/f$ noise effects; uniform scanning angles across sky pixels to suppress systematic effects; multiple observations of each pixel at different times; maintaining instruments in Earth's shadow for optimal passive cooling and avoiding radiation from the Sun, Earth, and Moon; constant angle between the Sun and solar panel plane for thermal and power

stability.

With $\alpha + \beta \leq 90^\circ$, the satellite could observe the full sky within six months. Additionally, two telescopes were positioned at mirror-image angles, enabling common-mode noise reduction through differential measurements. The mission conducted full-sky CMB observations for 9 years and 2 months following its launch on June 30, 2001.

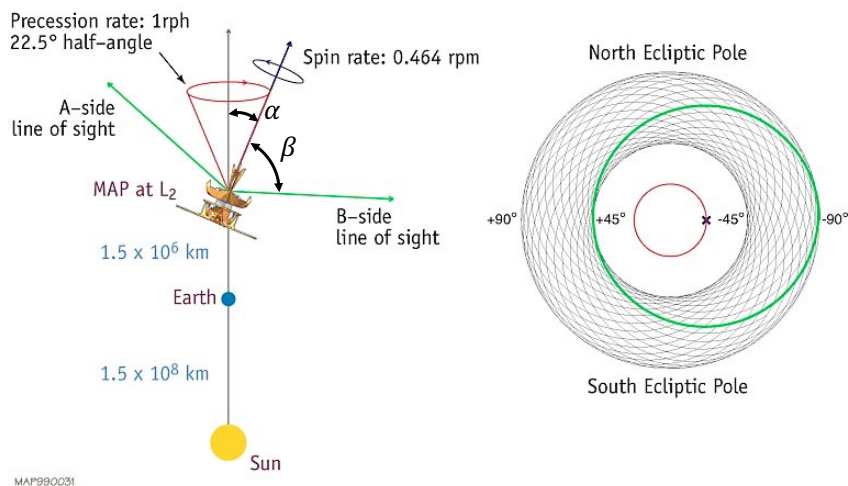

Figure 3.2: *WMAP* scanning strategy (left) and telescope scanning trajectory over one precession period of 1 hour (right). Figure credit: NASA/*WMAP* Science Team²

3.1.3 *Planck*

Planck was designed to conduct high-resolution, high-sensitivity observations of CMB temperature anisotropies and galactic frequency spectra. The mission employed a scanning strategy that enabled multiple observations of the same sky pixel within short time intervals, significantly enhancing temperature mapping precision [72–74]. Unlike *WMAP*, *Planck* featured a single telescope configuration rather than a pair, maximizing optical system size to achieve superior angular resolution.

Planck operated with a 1 rpm spin rate combined with a slow 6-month precession period (figure 3.3). This precession period, the longest among all CMB space missions considered to date, successfully achieved uniform full-sky coverage. However, this strategy provided a valuable lesson for future missions: while effective for temperature measurements, it resulted in redundant polarization angles relative to sky pixels, thereby reducing polarization sensitivity. Nevertheless, the slow precession rate offered exceptional satellite control stability and maneuverability, enabling flexible in-flight operations.

This operational flexibility proved particularly valuable for a calibration using planets. For instance, Jupiter, being the brightest, served as a crucial calibrator for gain and pointing measurements. While *Planck*'s spin axis typically rotated approximately 1° per day, the satellite could switch to a ‘deep scan mode’ when Jupiter was in view. This mode involved slower spin

²https://wmap.gsfc.nasa.gov/mission/observatory_scan.html

axis rotation, allowing extended ‘repointing’ maneuvers of Jupiter and improving beam pattern sampling by a factor of 3.4 [75].

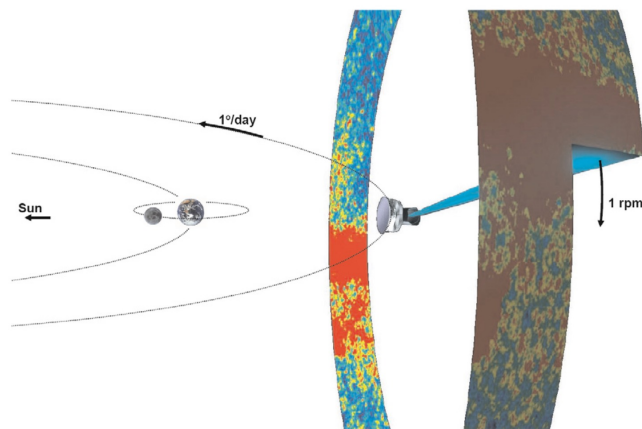

© 2010 A&A

Figure 3.3: *Planck* scanning strategy, characterized by its 1 rpm spin rate and slow 6-month precession period. The figure adopted from ref. [76] with a permission from the publisher.

3.2 Summary of scanning parameters across CMB space missions

This section summarizes the scanning strategies of CMB space missions deployed at L_2 (excluding *COBE* due to its different orbit). The scanning strategies are characterized by four key parameters:

- Precession axis angle (α): angle between Sun- L_2 vector and precession axis
- Spin axis angle (β): angle between spin axis and telescope
- Precession period (T_α): time for one complete spin axis rotation
- Spin period (T_β): period of spacecraft rotation around spin axis

Table 3.1 presents these parameters for *WMAP*, *Planck*, *EPIC*, *CORE*, *PICO*, and *LiteBIRD* [25, 71, 77–80]. Among these, *EPIC* and *PICO* were NASA proposals, *CORE* was an ESA proposal, and *LiteBIRD* is a JAXA mission. All these missions focus on CMB polarization, specifically targeting the primordial B -mode signal from the inflationary epoch.

3.3 *LiteBIRD* space mission

LiteBIRD, scheduled for launch in 2032 as a JAXA L-class mission, will conduct three years of CMB polarization observations [21]. As illustrated in figure 3.4, the spacecraft architecture integrates a payload module (PLM) and service module (SVM). The observatory’s multi-frequency

	α	β	T_α	T_β
<i>WMAP</i>	22.5°	70°	1 hr	129 s
<i>Planck</i>	7.5°	85°	6 month	1 min
<i>EPIC</i>	45°	55°	3.2 hr	1 min
<i>CORE</i>	30°	65°	4 day	2 min
<i>PICO</i>	26°	69°	10 hr	1 min
<i>LiteBIRD</i>	45°	50°	3.2058 hr	20 min

Table 3.1: Scanning strategy parameters for CMB space missions deployed at L_2 . Among these missions, only *Planck* and *WMAP* have been completed, while the others are either in development or were proposed missions.

coverage is achieved through three specialized telescopes: the Low Frequency Telescope (LFT) [81], Medium Frequency Telescope (MFT), and High Frequency Telescope (HFT) [82]. The

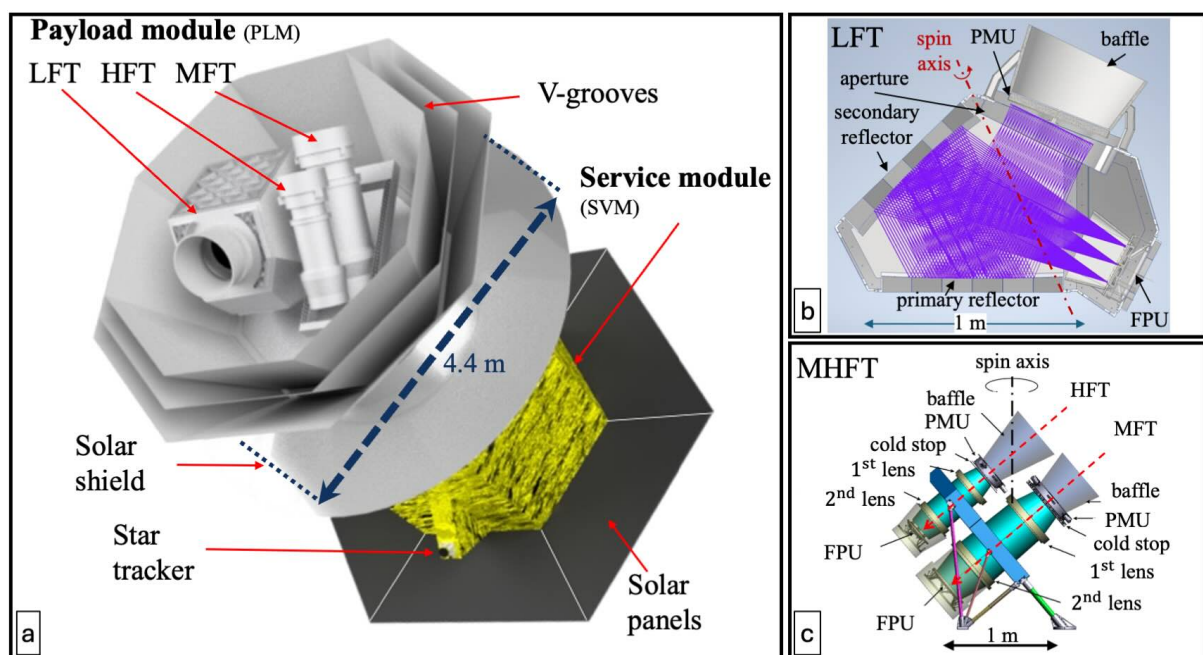

Figure 3.4: Architectural overview of *LiteBIRD* showing: (a) integrated spacecraft design comprising PLM and SVM, (b) reflective LFT, and (c) refractive MHFT. The figure is adapted from ref. [83], with permission of the publisher and authors.

mission's primary scientific objective is to detect primordial B -mode polarization signatures from cosmic inflation, with anticipated sensitivity shown in figure 3.5. The mission aims to achieve a high-precision measurement of the tensor-to-scalar ratio, r with its error $\delta r < 0.001$.

To achieve this unprecedented sensitivity, *LiteBIRD* implements two key technological innovations: a continuously rotating HWP for polarization modulation and an optimized scanning strategy for comprehensive full-sky polarization measurements. These design features make *LiteBIRD* an exemplary case study for analyzing polarization-optimized scanning strategies.

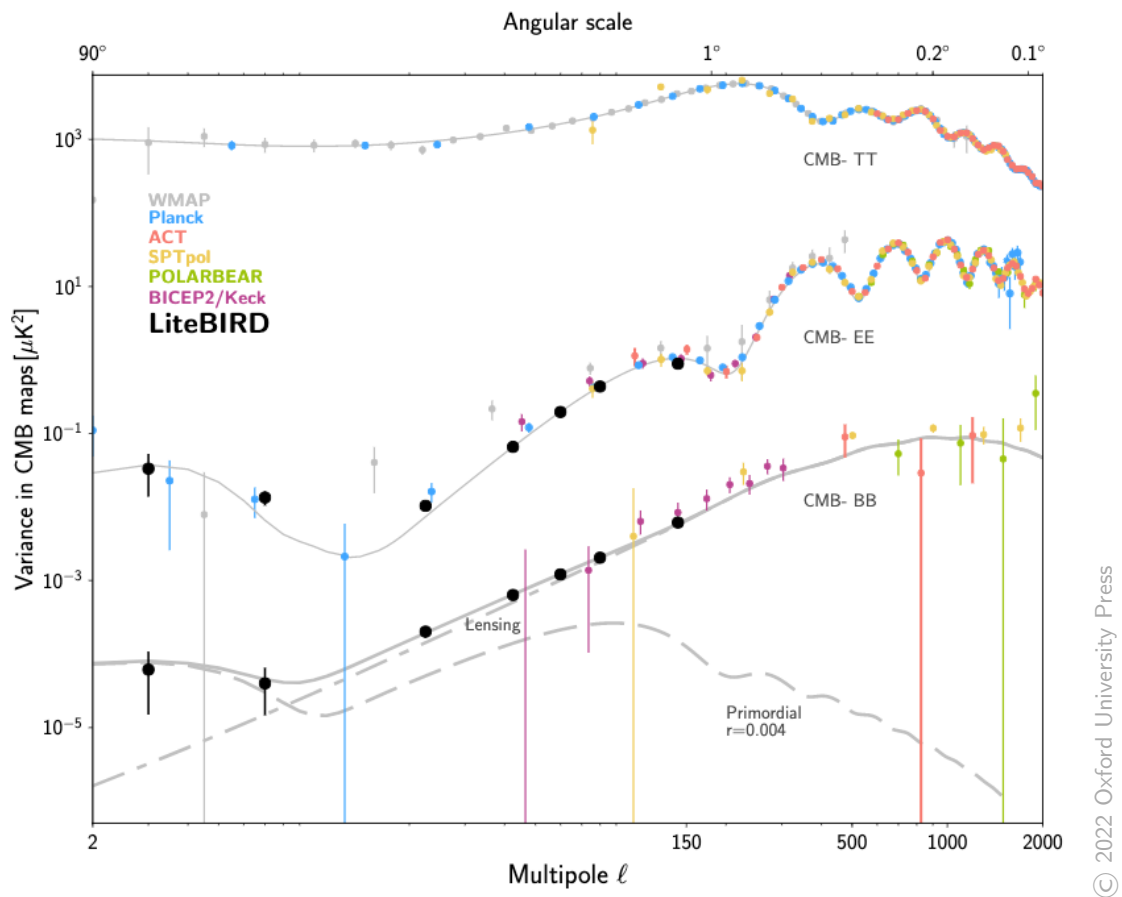

Figure 3.5: CMB angular power spectra components: temperature anisotropy (top), E -mode (middle), and B -mode polarization (bottom). Solid lines represent the Λ CDM model's best-fit power spectra including scale-invariant tensor perturbations ($r = 0.004$). The thin dashed line shows the B -mode contribution from scale-invariant tensor perturbations ($r = 0.004$). Colored points indicate existing CMB measurements from various experiments [29, 45, 84–92], while black points represent *LiteBIRD*'s projected polarization sensitivity. The figure is adopted from ref. [21] based on Creative Commons CC BY license.

3.3.1 Polarization modulation with half-wave plates

LiteBIRD employs the continuously rotating HWPs as Polarization Modulator Units (PMUs) in all three telescopes [22, 23]. HWPs are manufactured from birefringent materials with different refractive indices along two orthogonal optical axes. The LFT uses A-cut sapphire, while the MHFT adopts metamaterial-based metal mesh HWPs. When polarized light enters a HWP, the difference in refractive indices along each axis creates an optical path difference, altering the electromagnetic wave's phase. Specifically, an HWP introduces a half-wavelength phase retardation; other common wave plates include quarter-wave plates. For HWPs, the polarization direction of incident light is rotated symmetrically relative to the optical axis. Consequently, rotating an HWP by an angle ϕ rotates the transmitted polarization direction by 2ϕ relative to the incident polarization. When the HWP continuously rotates with angular frequency $\phi = \omega t$, the transmitted polarization direction rotates at $2\omega t$. Since electromagnetic wave intensity is proportional to the square of the electric field, the polarization signal is ultimately modulated at $4\omega t$ [93].

Chapter 4

Novel map-making approach in *spin* space

Contents

4.1	Description of signal and map-making in <i>spin</i> space	33
4.1.1	The case without HWP	33
4.1.2	The case with HWP	36
4.2	Observation with multiple detectors	37

In this chapter, we introduce map-making methods in a *spin* space representation, which transforms angular domain information into Fourier domain. We first establish the formalism for observations without a HWP, showing how the detected signal can be decomposed into *spin* components. We then extend this to include HWP modulation, which adds complexity but maintains similar mathematical structure. Finally, we demonstrate how this formalism generalizes to multiple detectors, including orthogonal detector pairs. This *spin* space approach enables faster map-making compared to traditional time-domain methods while preserving all relevant information.

4.1 Description of signal and map-making in *spin* space

4.1.1 The case without HWP

We can describe the signal detected by a detector within a sky pixel of spherical coordinates $\Omega = (\theta, \phi)$ as a function of the detector's crossing angle ψ as

$$S^d(\Omega, \psi) = h(\Omega, \psi)S(\Omega, \psi), \quad (4.1)$$

where S is the signal field, which describes the signal detected by the detector at each visit of the sky pixel, and the real space scan field, h , describes the observation by a detector in each sky pixel under a specific scanning strategy. In this thesis, we refer a quantity that is function

of Ω and ψ to a ‘field’ which can be recognized like a state function in the quantum mechanics. As introduced in ref. [94], the real space scan field can be expressed as

$$h(\Omega, \psi) = \frac{2\pi}{N_{\text{hits}}(\Omega)} \sum_j \delta(\psi - \psi_j(\Omega)), \quad (4.2)$$

where δ is the Dirac delta function, $N_{\text{hits}}(\Omega)$ is the number of hits/observations in the sky pixel Ω , and $\psi_j(\Omega)$ is the crossing angle of the j^{th} visit of the sky pixel Ω .

It is then we can decompose the signal field S into the *spin*- n space components, ${}_n\tilde{S}$ by the Fourier transform $\psi \rightarrow n$ as

$$S^d(\Omega, \psi) = \sum_n {}_n\tilde{S}^d(\Omega) e^{in\psi}, \quad (4.3)$$

$${}_n\tilde{S}^d(\Omega) = \sum_{n'=-\infty}^{\infty} {}_{n-n'}\tilde{h}(\Omega) {}_{n'}\tilde{S}(\Omega), \quad (4.4)$$

where ${}_{n-n'}\tilde{h}$ is referred to as the orientation function defined as

$$\begin{aligned} {}_n\tilde{h}(\Omega) &= \frac{1}{2\pi} \int d\psi h(\Omega, \psi) e^{-in\psi} \\ &= \frac{1}{N_{\text{hits}}(\Omega)} \sum_j e^{-in\psi_j(\Omega)}. \end{aligned} \quad (4.5)$$

Note that when we discuss the *spin* moment, we describe it in italics to distinguish it from the spacecraft’s about the maximum inertial axis, which is described in normal font. In this thesis, we distinguish quantities x and \tilde{x} as the real (i.e. angular) space and *spin* (i.e. Fourier) space, respectively. These quantities in *spin* space satisfy the relations:

$${}_n\tilde{S} = -{}_n\tilde{S}^*, \quad (4.6)$$

$${}_n\tilde{S}^d = -{}_n\tilde{S}^{d*}, \quad (4.7)$$

$${}_n\tilde{h} = -{}_n\tilde{h}^*. \quad (4.8)$$

Once, a signal is given by the bolometric equation

$$\begin{aligned} S(\Omega, \psi) &= I(\Omega) + Q(\Omega) \cos(2\psi) + U(\Omega) \sin(2\psi) + \mathcal{N} \\ &= I(\Omega) + \frac{1}{2}P(\Omega)e^{2i\psi} + \frac{1}{2}P^*(\Omega)e^{-2i\psi} + \mathcal{N}, \end{aligned} \quad (4.9)$$

where we introduce $P = Q+iU$ and its complex conjugate P^* . The \mathcal{N} represents the probability density function (PDF) of the noise. Here, we define a signal that is measured by j^{th} observation

at a sky pixel Ω as

$$\begin{aligned} d_j &= \begin{pmatrix} 1 & \frac{1}{2}e^{2i\psi_j} & \frac{1}{2}e^{-2i\psi_j} \end{pmatrix} \begin{pmatrix} I \\ P \\ P^* \end{pmatrix} + n_j \\ &= \mathbf{w}_j \cdot \mathbf{s} + n_j, \end{aligned} \quad (4.10)$$

where n_j represents the j^{th} sample of noise given by \mathcal{N} , \mathbf{w}_j is a basis vector, and \mathbf{s} is the Stokes vector. In order to reconstruct the Stokes vector from observations, we minimize:

$$\chi^2 = \sum_{i,j} (d_i - \mathbf{w}_i \cdot \mathbf{s})(N^{-1})_{ij}(d_j - \mathbf{w}_j \cdot \mathbf{s}), \quad (4.11)$$

where N_{ij} is the noise covariance matrix. After minimizing χ^2 , we obtain the equation of linear regression to estimate Stokes vector as

$$\hat{\mathbf{s}} = \left(\sum_{i,j} \mathbf{w}_i^\dagger (N^{-1})_{ij} \mathbf{w}_j \right)^{-1} \left(\sum_{i,j} \mathbf{w}_i^\dagger (N^{-1})_{ij} d_j \right), \quad (4.12)$$

where $\hat{\mathbf{s}}$ represents the estimated Stokes vector and \dagger represents the Hermitian transpose. Let us assume the noise is given by Gaussian distribution, i.e., white noise which does not have a correlation between the i^{th} and the j^{th} measurement. Furthermore, we define the symbol for the average of a quantity x_j as $\langle x_j \rangle = \frac{1}{N} \sum_j^N x_j$, then, eq. (4.12) can be expressed as

$$\begin{aligned} \hat{\mathbf{s}} &= \left(\sum_j \mathbf{w}_j^\dagger \mathbf{w}_j \right)^{-1} \left(\sum_j \mathbf{w}_j^\dagger d_j \right) \\ &= \begin{pmatrix} 1 & \frac{1}{2}2\tilde{h} & \frac{1}{2}-2\tilde{h} \\ \frac{1}{2}-2\tilde{h} & \frac{1}{4} & \frac{1}{4}-4\tilde{h} \\ \frac{1}{2}2\tilde{h} & \frac{1}{4}4\tilde{h} & \frac{1}{4} \end{pmatrix}^{-1} \begin{pmatrix} \langle d_j \rangle \\ \frac{1}{2}\langle d_j e^{2i\psi_j} \rangle \\ \frac{1}{2}\langle d_j e^{-2i\psi_j} \rangle \end{pmatrix}. \end{aligned} \quad (4.13)$$

This equation corresponds to the simple binning map-making approach (e.g. ref. [95]), and the following relation

$$\begin{pmatrix} \langle d_j \rangle \\ \frac{1}{2}\langle d_j e^{2i\psi_j} \rangle \\ \frac{1}{2}\langle d_j e^{-2i\psi_j} \rangle \end{pmatrix} = \begin{pmatrix} {}_0\tilde{S}^d \\ \frac{1}{2}2\tilde{S}^d \\ \frac{1}{2}-2\tilde{S}^d \end{pmatrix}, \quad (4.14)$$

where the right part can be obtain by eq. (4.4). Of these, the map-maker in *spin* space is given by

$$\hat{\mathbf{s}} = \begin{pmatrix} 1 & \frac{1}{2}2\tilde{h} & \frac{1}{2}-2\tilde{h} \\ \frac{1}{2}-2\tilde{h} & \frac{1}{4} & \frac{1}{4}-4\tilde{h} \\ \frac{1}{2}2\tilde{h} & \frac{1}{4}4\tilde{h} & \frac{1}{4} \end{pmatrix}^{-1} \begin{pmatrix} {}_0\tilde{S}^d \\ \frac{1}{2}2\tilde{S}^d \\ \frac{1}{2}-2\tilde{S}^d \end{pmatrix}. \quad (4.15)$$

This formalization is introduced in ref. [94] which allows us to simulate the map-making faster than TOD-based approach.

4.1.2 The case with HWP

Basic formalism of the map-making in *spin* space with or without HWP is the same, but the case with HWP has additional complexity due to the HWP modulation. First, the signal field S is defined as a function of the detector's crossing angle ψ and the HWP angle ϕ . The real space scan field h is also a function of Ω , ψ , and ϕ . The signal detected by a detector within a sky pixel of spherical coordinates $\Omega = (\theta, \varphi)$ is given by

$$S^d(\Omega, \psi, \phi) = h(\Omega, \psi, \phi)S(\Omega, \psi, \phi). \quad (4.16)$$

Since the signal field is expanded to a two dimensional field given by ψ and ϕ , we consider corresponding scan field h as

$$h(\Omega, \psi, \phi) = \frac{4\pi^2}{N_{\text{hits}}(\Omega)} \sum_j \delta(\psi - \psi_j) \delta(\phi - \phi_j). \quad (4.17)$$

Now we consider Fourier transform to bring the signal field to *spin* space. Defining n and m as the *spin* moment that is the variable conjugate to the angle ψ and ϕ , the transformation $(\psi, \phi) \rightarrow (n, m)$ is given by

$$S^d(\Omega, \psi, \phi) = \sum_{n,m} S^d(\Omega) e^{in\psi} e^{im\phi}, \quad (4.18)$$

$$S^d(\Omega) = \sum_{n'=-\infty}^{\infty} \sum_{m'=-\infty}^{\infty} \Delta_{n,\Delta m} \tilde{h}(\Omega)_{n',m'} \tilde{S}(\Omega), \quad (4.19)$$

where we introduce $\Delta n = n - n'$ and $\Delta m = m - m'$, and define the two dimensional orientation function, $\Delta_{n,\Delta m} \tilde{h}$ by Fourier transform of the real space scan field as

$$\begin{aligned} \Delta_{n,\Delta m} \tilde{h}(\Omega) &= \frac{1}{4\pi^2} \int d\psi \int d\phi h(\Omega, \psi, \phi) e^{-in\psi} e^{-im\phi} \\ &= \frac{1}{N_{\text{hits}}} \sum_j e^{-i(n\psi_j + m\phi_j)}. \end{aligned} \quad (4.20)$$

Now, we define a signal field given by a bolometer with a HWP as

$$\begin{aligned} S(\Omega, \psi, \phi) &= I(\Omega) + Q(\Omega) \cos(4\phi - 2\psi) + U(\Omega) \sin(4\phi - 2\psi) + \mathcal{N} \\ &= I(\Omega) + \frac{1}{2}P(\Omega)e^{-i(4\phi-2\psi)} + \frac{1}{2}P^*(\Omega)e^{i(4\phi-2\psi)} + \mathcal{N}. \end{aligned} \quad (4.21)$$

A signal detected by the j^{th} observation at a sky pixel Ω is given by

$$d_j = \begin{pmatrix} 1 & \frac{1}{2}e^{-i(4\phi_j-2\psi_j)} & \frac{1}{2}e^{i(4\phi_j-2\psi_j)} \end{pmatrix} \begin{pmatrix} I \\ P \\ P^* \end{pmatrix} + n_j$$

$$= \mathbf{w}_j \cdot \mathbf{s} + n_j. \quad (4.22)$$

By the same procedure as the case without HWP, we can obtain the map-making equation

$$\hat{\mathbf{s}} = \begin{pmatrix} 1 & \frac{1}{2}2_{-2,4}\tilde{h} & \frac{1}{2}2_{-2,-4}\tilde{h} \\ \frac{1}{2}2_{-2,-4}\tilde{h} & \frac{1}{4} & \frac{1}{4}4_{-4,-8}\tilde{h} \\ \frac{1}{2}2_{-2,4}\tilde{h} & \frac{1}{4}4_{-4,8}\tilde{h} & \frac{1}{4} \end{pmatrix}^{-1} \begin{pmatrix} \langle d_j \rangle \\ \frac{1}{2}\langle d_j e^{i(4\phi_j-2\psi_j)} \rangle \\ \frac{1}{2}\langle d_j e^{-i(4\phi_j-2\psi_j)} \rangle \end{pmatrix} \quad (4.23)$$

$$= \begin{pmatrix} 1 & \frac{1}{2}2_{-2,4}\tilde{h} & \frac{1}{2}2_{-2,-4}\tilde{h} \\ \frac{1}{2}2_{-2,-4}\tilde{h} & \frac{1}{4} & \frac{1}{4}4_{-4,-8}\tilde{h} \\ \frac{1}{2}2_{-2,4}\tilde{h} & \frac{1}{4}4_{-4,8}\tilde{h} & \frac{1}{4} \end{pmatrix}^{-1} \begin{pmatrix} 0,0\tilde{S}^d \\ \frac{1}{2}2_{-2,-4}\tilde{S}^d \\ \frac{1}{2}2_{-2,4}\tilde{S}^d \end{pmatrix}, \quad (4.24)$$

where eqs. (4.23) and (4.24) correspond to the time domain and the *spin* domain map-making approach, respectively.

4.2 Observation with multiple detectors

Nowadays, the CMB experiment usually has multiple detectors about 10^3 to 10^4 to take a statistics. Here we consider the implementation of multiple detectors in the map-making procedure. This can be simply described by modifying several quantities in the previous section. We introduce the detector index μ and total number of detectors N_{dets} , then the total number of hits per pixel $N_{\text{hits}}^{\text{tot}}$ is given by

$$N_{\text{hits}}^{\text{tot}}(\Omega) = \sum_{\mu} N_{\text{hits}}^{(\mu)}(\Omega), \quad (4.25)$$

where $N_{\text{hits}}^{(\mu)}$ is the number of hits of the μ^{th} detector in the sky pixel Ω . The orientation function given by total number of observations, ${}_{n,m}\tilde{h}^{\text{tot}}$, is

$${}_{n,m}\tilde{h}^{\text{tot}}(\Omega) = \frac{1}{N_{\text{hits}}^{\text{tot}}(\Omega)} \sum_{\mu} {}_{n,m}\tilde{h}^{(\mu)}(\Omega) N_{\text{hits}}^{(\mu)}(\Omega). \quad (4.26)$$

Here, we define orthogonal pair detector which is named as T and B that stands for ‘Top’ and ‘Bottom’ detectors. These detector observes the same direction though different crossing angle ψ , let us denote the crossing angle of the T and B detectors as ψ^{T} and ψ^{B} , respectively. Then, the orientation function of the T can be exchanged to that of the B by the following relation

$${}_{n,m}\tilde{h}^{(\text{B})} = {}_{n,m}\tilde{h}^{(\text{T})} e^{in\frac{\pi}{2}}. \quad (4.27)$$

The detected signal in *spin* space per detector is given by

$${}_{n,m}\tilde{S}^{d(\mu)}(\Omega) = \sum_{n'=-\infty}^{\infty} \sum_{m'=-\infty}^{\infty} {}_{n-n',m-m'}\tilde{h}^{(\mu)}(\Omega) {}_{n',m'}\tilde{S}^{(\mu)}(\Omega). \quad (4.28)$$

It is then the total detected signal given by the multiple detectors is

$$\begin{aligned} {}_{n,m}\tilde{S}^{d^{\text{tot}}}(\Omega) &= \frac{1}{N_{\text{hits}}^{\text{tot}}(\Omega)} \sum_{\mu} \sum_{n'=-\infty}^{\infty} \sum_{m'=-\infty}^{\infty} N_{\text{hits}}^{(\mu)}(\Omega) {}_{n-n',m-m'}\tilde{h}^{(\mu)}(\Omega) {}_{n',m'}\tilde{S}^{(\mu)}(\Omega) \\ &= \frac{1}{N_{\text{hits}}^{\text{tot}}(\Omega)} \sum_{\mu} N_{\text{hits}}^{(\mu)}(\Omega) {}_{n,m}\tilde{S}^{d(\mu)}(\Omega). \end{aligned} \quad (4.29)$$

By using these quantities, the map-making equation for the multiple detectors is given by

$$\hat{\mathbf{s}} = \begin{pmatrix} 1 & \frac{1}{2}-2,4\tilde{h}^{\text{tot}} & \frac{1}{2}2,-4\tilde{h}^{\text{tot}} \\ \frac{1}{2}2,-4\tilde{h}^{\text{tot}} & \frac{1}{4} & \frac{1}{4}4,-8\tilde{h}^{\text{tot}} \\ \frac{1}{2}-2,4\tilde{h}^{\text{tot}} & \frac{1}{4}-4,8\tilde{h}^{\text{tot}} & \frac{1}{4} \end{pmatrix}^{-1} \begin{pmatrix} {}_{0,0}\tilde{S}^{d^{\text{tot}}} \\ \frac{1}{2}2,-4\tilde{S}^{d^{\text{tot}}} \\ \frac{1}{2}-2,4\tilde{S}^{d^{\text{tot}}} \end{pmatrix}. \quad (4.30)$$

In this section we assumed HWP-aware observation though in the case without HWP can be obtained by same procedure.

Chapter 5

Optimization of full-sky scanning strategy

This chapter addresses the optimization of scanning strategies for next-generation CMB space missions, with particular focus on *LiteBIRD*. We begin by establishing the parameter space of scanning strategies and analyzing the constraints on both geometric and kinematic parameters. Through detailed simulations and defined evaluation metrics, we explore optimal scanning configurations. Our analysis yields three promising solutions for CMB polarimetry. Based on *LiteBIRD*'s perspective, we identify and recommend the most suitable configuration. Finally, we benchmark this optimal strategy against those employed by *Planck* and proposed for *PICO*, evaluating their relative merits for calibration procedures and null-tests. The contents in this chapter are based on our work published in ref. [25].

Contents

5.1	The parameter space of scanning strategies	40
5.2	Constraints on the parameter space	41
5.2.1	Constraints on geometric parameters	41
5.2.2	Constraints on kinetic parameters	41
5.3	The case of <i>LiteBIRD</i> mission	43
5.4	Metrics for optimization	46
5.4.1	Visibility time of compact sources	46
5.4.2	Forming speed of sky coverage	46
5.4.3	Hit-map uniformity	46
5.4.4	Cross-link factor	47
5.5	Results	47
5.5.1	Visibility time of compact sources	47
5.5.2	Forming speed of sky coverage	48
5.5.3	Hit-map uniformity	48
5.5.4	Cross-link factor	50

5.5.5	Propagation of cross-link factor to bias	50
5.6	Optimization	52
5.6.1	Optimization of the geometric parameters	53
5.6.2	Optimization of the kinetic parameters	53
5.7	Implications	56
5.7.1	Beam reconstruction systematics	56
5.7.2	Amplitude of CMB solar dipole	57
5.7.3	Sky pixel visit/revisit times	58
5.7.4	Planet visit/revisit times	61

5.1 The parameter space of scanning strategies

At the second Lagrange point (L_2) of the Sun-Earth system, pioneering CMB space missions like *WMAP* and *Planck* executed their observations. These missions achieved comprehensive celestial coverage through an intricate combination of spacecraft dynamics: rotational motion about its axis, precessional movement, and its heliocentric orbital trajectory. As depicted in the left panel of figure 5.1, the scanning geometry is characterized by two fundamental angles: β , which defines the angular separation between the observational line-of-sight and the spacecraft’s principal axis of inertia (serving as the spin axis), and α , which measures the angle between this spin axis and the Sun-spacecraft vector. The spacecraft undergoes two primary rotational motions: a spin about its principal axis with period T_β , and a precession of this spin axis around the Sun-spacecraft vector with period T_α .

The next generation of CMB experiments introduces an additional complexity through the implementation of a continuously rotating HWP for polarization modulation. The HWP’s orientation is specified by angle ϕ relative to the optical axis, with a rotation period of T_ϕ . For each rotational component $j \in \{\alpha, \beta, \phi\}$, the motion can be equivalently characterized by its period T_j or its corresponding frequency:

$$\omega_j = 2\pi/T_j \text{ [rad/s]}, \quad (5.1)$$

$$f_j = 1/T_j \text{ [Hz]}, \quad (5.2)$$

$$\nu_j = 60/T_j \text{ [rpm]}. \quad (5.3)$$

Throughout this work, we employ these kinetic parameters (T_j, ω_j, f_j , or ν_j) interchangeably as contextually appropriate. A comprehensive exposition of the spacecraft’s precession and spin dynamics is presented in appendix A.2. The scanning strategy incorporates another critical parameter: the sampling rate f_s , which quantifies the temporal density of data acquisition. The parameters α and β constitute the ‘geometric parameters’ of the scanning strategy, while the temporal measures $T_j/\omega_j/f_j/\nu_j$ represent the ‘kinematic parameters’. The scanning strategy’s complete characterization requires optimization within a six-dimensional parameter space $\{\alpha, \beta, T_\alpha, T_\beta, \nu_\phi, f_s\}$. While this optimization presents considerable complexity, we can systematically reduce its effective dimensionality through mission-specific constraints and judicious assumptions, particularly for configurations incorporating a HWP.

5.2 Constraints on the parameter space

5.2.1 Constraints on geometric parameters

A fundamental geometric constraint requires that

$$\kappa = \alpha + \beta > 90^\circ. \quad (5.4)$$

This condition, as elaborated in ref. [19], is imperative for achieving comprehensive celestial coverage. Given that the effective β varies across detector positions, implementing an elevated κ value, typically $\kappa \sim 95^\circ$ [19], is advantageous to accommodate the experiment's specific Field of View (FoV). This configuration simultaneously optimizes thermal management by minimizing direct solar radiation exposure. The upper limit of κ is primarily determined by the engineering constraints of the sun-shield and thermal control systems. Historical precedents include *WMAP* and *Planck*, both utilizing $\kappa = 92.5^\circ$, while *EPIC* [78] proposed a more ambitious $\kappa = 100^\circ$ (achieved with $\alpha = 45^\circ, \beta = 55^\circ$; see table 3.1), representing the most extensive κ value proposed for any CMB space mission. Within a given experimental framework, κ typically remains fixed, establishing a direct relationship between α and β .

5.2.2 Constraints on kinetic parameters

Having established the geometric parameters, we now examine the temporal aspects governed by periods T_j . The incorporation of a HWP in the spacecraft serves dual critical functions: primarily, it facilitates polarization modulation at frequencies substantially exceeding the instrument's $1/f$ noise knee frequency f_{knee} ; additionally, it enhances the homogeneity of effective crossing angles. The optimization of HWP revolution frequency in relation to the $1/f$ noise model lies beyond our present scope.

Given a HWP with revolution frequency f_ϕ capable of adequately suppressing $1/f$ noise characterized by a specific f_{knee} , we must establish appropriate constraints for the spacecraft's rotational periods. In contrast to traditional configurations without a HWP, where incoherent polarimetric receivers rely exclusively on spacecraft rotation for polarization modulation (necessitating rapid spin rates as detailed in ref. [19]), the presence of a HWP fundamentally alters these requirements. The primary consideration shifts to ensuring sufficient polarization modulation within each sky pixel during the telescope's transit. Specifically, the HWP's angular velocity must be appropriately scaled relative to the sky scanning motion. The maximum angular velocity of the pointing across the celestial sphere can be expressed as

$$\begin{aligned} \omega_{\text{max}} &= \omega_\alpha \sin \kappa + \omega_\beta \sin \beta \\ &= 2\pi \left(\frac{\sin \kappa}{T_\alpha} + \frac{\sin \beta}{T_\beta} \right). \end{aligned} \quad (5.5)$$

A comprehensive derivation of this ω_{max} expression is elaborated in appendix A.2.1.¹

The transit duration τ , representing the time interval during which the pointing vector

¹This formulation assumes co-directional precession and spin rotations. For counter-rotating configurations, refer to the detailed analysis in appendix B.4.

traverses an angular distance equivalent to the beam's Full Width at Half Maximum (FWHM) $\Delta\theta$, is given by

$$\tau = \frac{\Delta\theta}{\omega_{\max}}. \quad (5.6)$$

For accurate demodulation of the polarization signal modulated by the HWP, the sampling rate must exceed the Nyquist frequency with an adequate margin. Specifically, since a HWP rotating at frequency f_ϕ modulates the polarization signal at $4f_\phi$, the corresponding Nyquist frequency is $8f_\phi$. To ensure robust signal recovery, we introduce a margin factor N_{margin} ($N_{\text{margin}} > 1$), leading to the following sampling rate requirement:

$$f_s > 8f_\phi N_{\text{margin}}. \quad (5.7)$$

Furthermore, to ensure adequate polarization modulation within each sky pixel, the HWP must complete N_{mod} ($N_{\text{mod}} > 1$) revolutions while the telescope's line of sight traverses an angular distance equivalent to the beam's FWHM $\Delta\theta$, yielding the requirement

$$N_{\text{mod}} T_\phi < \tau. \quad (5.8)$$

By integrating eqs. (5.7) and (5.8), we establish a fundamental constraint:

$$\frac{N_{\text{mod}}}{\tau} < f_\phi < \frac{f_s}{8N_{\text{margin}}}. \quad (5.9)$$

This inequality ensures both adequate polarization signal modulation within the beam's FWHM $\Delta\theta$ and sufficient temporal resolution for signal demodulation. The resultant constraint on the spacecraft manifests through τ , necessitating a duration sufficient to satisfy eq. (5.8). This effectively imposes an upper threshold on the maximum angular velocity ω_{\max} at which the instruments can traverse the celestial sphere. To establish precise constraints on the spacecraft's kinematic parameters, specifically T_α and T_β , we can reformulate eq. (5.8) into:

$$\frac{N_{\text{mod}}}{f_\phi} < \frac{\Delta\theta}{2\pi \left(\frac{\sin \kappa}{T_\alpha} + \frac{\sin \beta}{T_\beta} \right)}. \quad (5.10)$$

Through algebraic manipulation, we derive a lower bound for T_β :

$$T_\beta^{\text{lower}} \equiv \frac{2\pi N_{\text{mod}} T_\alpha \sin \beta}{\Delta\theta f_\phi T_\alpha - 2\pi N_{\text{mod}} \sin \kappa}. \quad (5.11)$$

While previous studies, notably ref. [19], considered detector time constants as a constraint on T_β , this consideration becomes redundant in configurations incorporating HWP modulation. In such systems, the detector's time constant primarily influences the HWP rotation frequency rather than imposing direct constraints on the scanning strategy parameters. By applying the condition $T_\beta < T_\alpha$ to eq. (5.11), we can establish a lower bound for T_α to maintain stable

spacecraft inertial control:

$$T_{\alpha}^{\text{lower}} \equiv \frac{2\pi N_{\text{mod}}(\sin \beta + \sin \kappa)}{\Delta\theta f_{\phi}}. \quad (5.12)$$

This yields a hierarchical constraint on the rotational periods:

$$T_{\beta}^{\text{lower}} < T_{\beta} < T_{\alpha}. \quad (5.13)$$

The precession period T_{α} is further constrained by an upper limit, which can only be determined through numerical simulations. Prior research [19] indicates that precession periods exceeding one year compromise the achievement of comprehensive sky coverage.

Through the systematic application of these angular and temporal constraints, we can effectively reduce the dimensionality of the optimization problem from six to three parameters. Given that κ is typically fixed by instrumental considerations and incorporating the constraint $T_{\beta}^{\text{lower}} < T_{\beta}$, the parameter space can be reformulated as:

$$\{\alpha, \beta, T_{\alpha}, T_{\beta}, \nu_{\phi}, f_s\} \rightarrow \{\alpha, \kappa - \alpha, T_{\alpha}, T_{\beta}^{\text{lower}}(\alpha, T_{\alpha}) < T_{\beta}, \nu_{\phi}(f_{\text{knee}}), f_s(\nu_{\phi})\}. \quad (5.14)$$

The optimization problem ultimately reduces to the exploration of three essential parameters $\{\alpha, T_{\alpha}, T_{\beta}^{\text{lower}} < T_{\beta}\}$, where ν_{ϕ} and f_s are determined by the specified f_{knee} characteristics.

5.3 The case of *LiteBIRD* mission

The *LiteBIRD* instrument model employs the following configuration: $\alpha = 45^{\circ}$ and $\beta = 50^{\circ}$ (yielding $\kappa = 95^{\circ}$), aligned with our discussion in section 5.2.1. The rotation periods are set to $T_{\alpha} = 3.2058$ hours (192.348 minutes) and $T_{\beta} = 20$ minutes, with HWP rotation rates $\nu_{\phi} = 46/39/61$ rpm for LFT/MFT/HFT respectively, and a sampling rate $f_s = 19$ Hz². The telescopes' Fields of View are $18^{\circ} \times 8^{\circ}$ for LFT and 14° radius for both MFT and HFT³.

This configuration, termed the *standard configuration*, is depicted in figure 5.1 (left) and detailed in table 5.1. Figure 5.2 (middle column) shows simulated hit-maps counting observations per sky pixel under the *standard configuration*. For comparison, the figure includes hit-maps with $\alpha = 10^{\circ}$ (left) and $\alpha = 85^{\circ}$ (right), demonstrating geometric parameter effects on scan patterns. These simulations maintain the *standard configuration*'s T_{α} while using T_{β}^{lower} calculated for each α and T_{α} combination.

This work aims to explore and rigorously justify this configuration choice, focusing on in-flight calibration and systematic effect suppression. To evaluate the constraints from eq. (5.11), we use the parameters of the HFT, which has the highest HWP revolution rate and smallest FWHM ($\Delta\theta = 17.9'$) at 402 GHz. For simplicity, we apply these parameters across all frequency bands, with $N_{\text{mod}} = 1$ and $N_{\text{margin}} = 2$ as recommended in ref. [21]. In the *LiteBIRD* instrument model, satisfying eq. (5.11) for the HFT parameters ensures compliance for LFT and MFT as well. Using these values to calculate T_{β}^{lower} yields the parameter space shown in figure 5.1

²Precisely defined as $f_s = 20 \text{ MHz}/2^{20}$ [21].

³MFT and HFT values represent FoV radius.

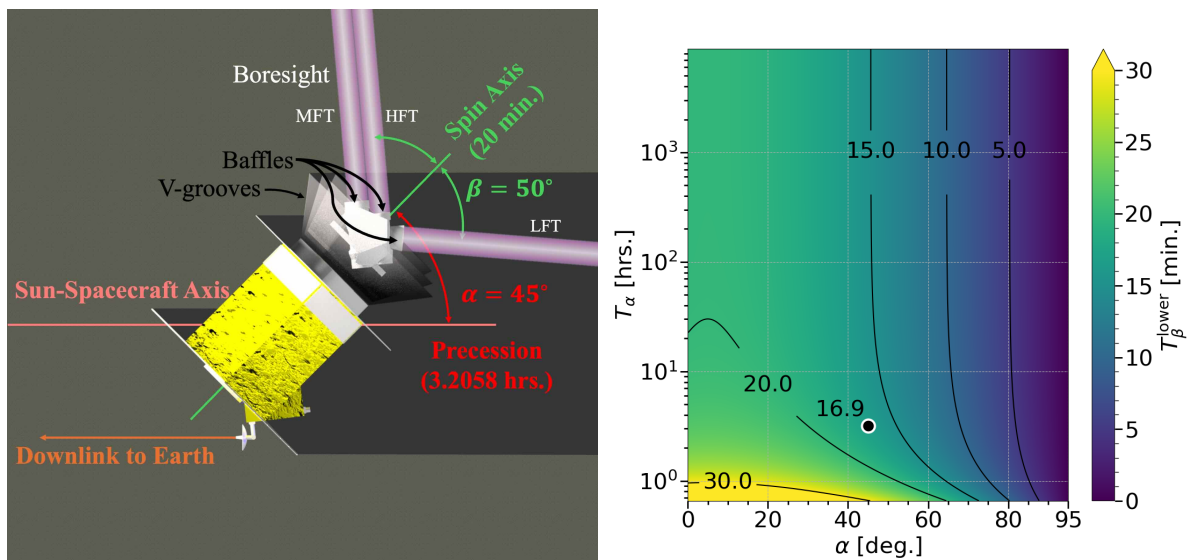

Figure 5.1: (left) Illustration of *LiteBIRD*'s standard scanning configuration. (right) Lower bound on spin period (T_β^{lower}) calculated from eq. (5.11) with $N_{\text{mod}} = 1$, using HFT parameters (402 GHz, FWHM=17.9'). The black dot indicates the *standard configuration* parameters $(\alpha, T_\alpha, T_\beta) = (45^\circ, 192.348 \text{ min}, 16.9 \text{ min})$, where α and T_α are *LiteBIRD*'s nominal values.

(right), where $T_\beta^{\text{lower}} = 16.9$ minutes at $(\alpha, T_\alpha) = (45^\circ, 192.348 \text{ min})$.

α	β	Precession period	Spin period	HWP revolution rate			Sampling rate
				LFT	MFT	HFT	
[deg]	[deg]	[min]	[min]	[rpm]			[Hz]
45	50	192.348	20	46	39	61	19

Table 5.1: Parameters of the *standard configuration* for the *LiteBIRD* mission [21].

From the *LiteBIRD* instrument model and the discussion in the previous section, the effective free parameters of the scanning strategy to optimize are given by

$$\{\alpha, \beta, T_\alpha, T_\beta, \nu_\phi, f_s\} \rightarrow \{\alpha, 95^\circ - \alpha, T_\alpha, 16.9 \text{ min} < T_\beta, 61 \text{ rpm}, 19 \text{ Hz}\}. \quad (5.15)$$

For the subsequent analysis, we concentrate our simulations on a single detector positioned at the boresight (the central axis of the telescope's focal plane). Our comprehensive verification demonstrates that extending the analysis to detectors situated at the periphery of the FoV yields conclusions consistent with those derived from the boresight detector, as elaborated in section 5.6. For an exhaustive treatment of non-boresight detector characteristics, readers are directed to appendix B.3.

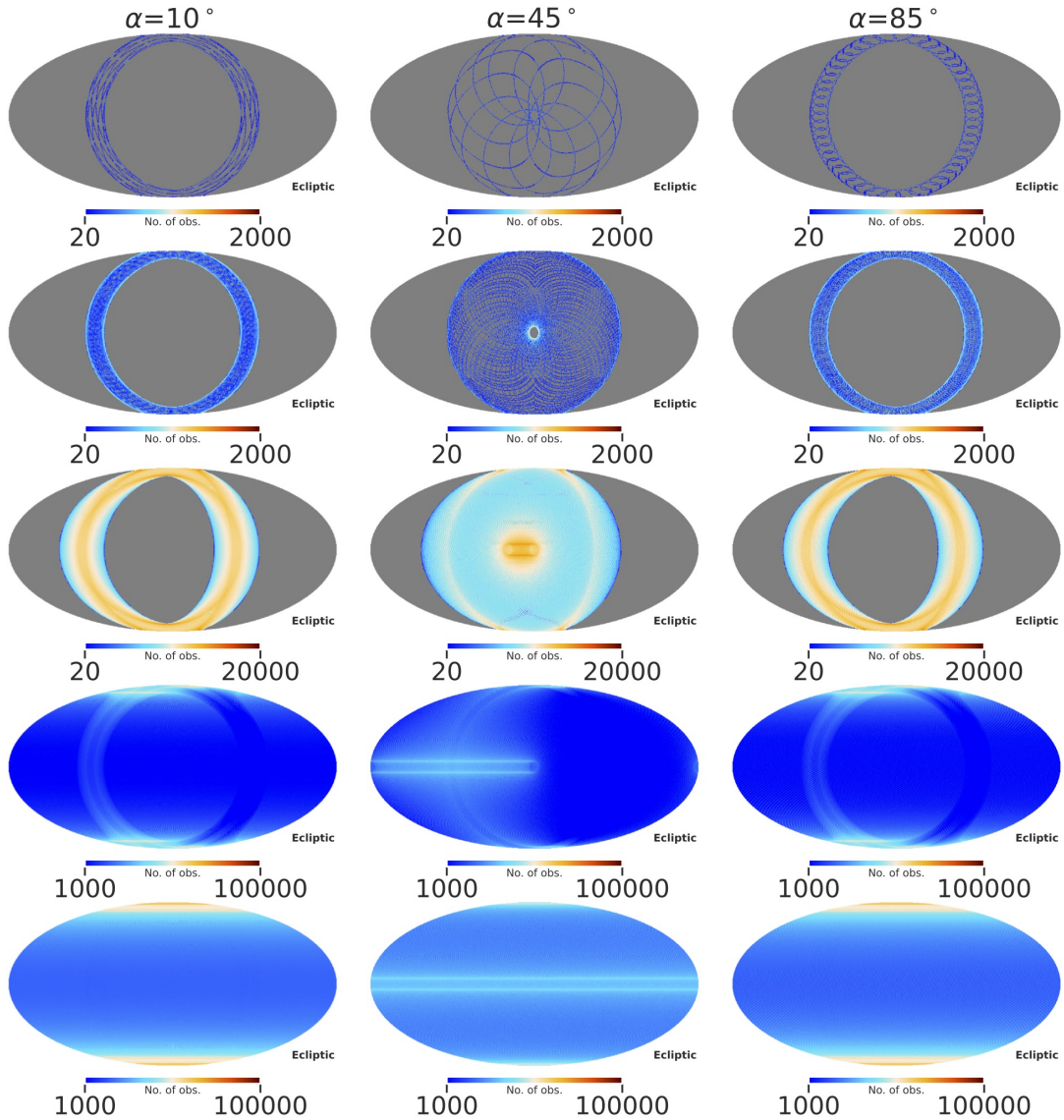

Figure 5.2: Hit-maps showing observation counts per sky pixel over time for different geometric parameters. The central column shows the *standard configuration* ($\kappa = 95^\circ$, $T_\alpha = 192.348$ minutes). Left and right columns show configurations with $\alpha = 10^\circ$ and 85° respectively, with corresponding T_β values of 21.9 and 3.8 minutes calculated from eq. (5.11). Rows display hit-map evolution from one precession period (192.348 minutes) through 1 day, 1 month, 6 months, to 1 year. Simulations use a single boresight detector with 19 Hz sampling rate and $N_{\text{side}} = 128$ (pixel size $\approx 0.46^\circ$).

5.4 Metrics for optimization

5.4.1 Visibility time of compact sources

The seminal observations from the *Planck* mission underscore the critical significance of compact astronomical sources, particularly solar system planets and distant galaxy clusters, in achieving precise beam characterization and pointing calibration [75,96]. Consequently, an optimal scanning strategy must strike a delicate balance between maximizing the observation duration of these calibration sources while simultaneously fulfilling the primary scientific objectives within the prescribed mission timeline. The calibration precision is anticipated to correlate directly with the integrated duration during which the instrument’s boresight maintains visibility of these compact sources. Our analysis seeks to identify optimal parameters in the $\{\alpha, T_\alpha\}$ parameter space that maximize this integrated visibility duration throughout the mission.

5.4.2 Forming speed of sky coverage

A fundamental requirement for any scanning strategy is its ability to efficiently survey extensive celestial regions. *EPIC* is engineered to observe more than 50% of the celestial sphere within a single 24 hours period, achieved through the careful selection of a 3.2 hours precession period and a 1 rpm spin rate. This configuration enables data acquisition across all necessary angular scales for comprehensive analysis [97]. To quantify this coverage efficiency, we introduce the T_{cover} metric, defined as the duration required to survey a specified fraction of the hemispheric sky. A shorter T_{cover} indicates more rapid sky coverage, which is instrumental in mitigating the impact of $1/f$ noise contamination at large angular scales.

5.4.3 Hit-map uniformity

The spatial uniformity of the hit-map distribution across the celestial sphere is paramount for achieving homogeneous sensitivity. Any significant heterogeneity in sensitivity across distinct celestial regions can potentially amplify noise variance, thereby compromising the efficacy of foreground removal.

We define a spherical coordinate system $\Omega_i = (\theta_i, \varphi_i)$ and employ index i to designate sky pixels in accordance with the HEALPix schema [98] (see appendix A.4).⁴ To quantitatively assess the degree of sensitivity homogeneity, we employ the hit-map’s standard deviation, σ_{hits} , mathematically expressed as

$$\sigma_{\text{hits}} = \sqrt{\frac{1}{N_{\text{pix}} - 1} \sum_{i=0}^{N_{\text{pix}}-1} (\langle N_{\text{hits}} \rangle - N_{\text{hits}}(\Omega_i))^2}, \quad (5.16)$$

where N_{hits} represents the aggregate number of observational hits, and $\langle \cdot \rangle$ denotes the full-sky averaged value. A diminished σ_{hits} value signifies enhanced hit-map uniformity, consequently indicating more consistent sensitivity across sky pixels. We conduct a comprehensive analysis of the σ_{hits} distribution within the $\{\alpha, T_\alpha\}$ parameter space.

⁴<https://healpix.sourceforge.io/>

5.4.4 Cross-link factor

Building upon the framework established in ref. [19], we examine how scanning strategies with diverse crossing angles across sky pixels can effectively mitigate systematic effects. To quantify the uniformity of these crossing angles, we introduce the 'cross-link factor', defined mathematically as:

$$\begin{aligned} \left| {}_{n,m}\tilde{h}(\Omega) \right|^2 &= \left(\frac{\sum_j^{N_{\text{hits}}} \cos(n\psi_j + m\phi_j)}{N_{\text{hits}}} \right)^2 + \left(\frac{\sum_j^{N_{\text{hits}}} \sin(n\psi_j + m\phi_j)}{N_{\text{hits}}} \right)^2 \\ &= \langle \cos(n\psi_j + m\phi_j) \rangle^2 + \langle \sin(n\psi_j + m\phi_j) \rangle^2, \end{aligned} \quad (5.17)$$

where ψ represents the intersection angle between the crossing angle and the meridian, while ϕ denotes the HWP angle.⁵ For our analysis, we maintain the assumption that the crossing angle remains parallel to the detector polarization angle. The index j corresponds to the j^{th} observation at a given sky pixel, and the pair (n, m) represents the respective *spin* components for the crossing and HWP angles. It is noteworthy that in circular statistics, the cross-link factor exhibits a direct relationship with the circular variance V , expressed as $V = 1 - \sqrt{\left| {}_{n,m}\tilde{h}(\Omega) \right|^2}$.

For an ideally uniform distribution of crossing angles, the cross-link factor vanishes ($\left| {}_{n,m}\tilde{h}(\Omega) \right|^2 = 0$) across all *spin*-(n, m) combinations. Therefore, a minimal cross-link factor indicates optimal cross-linking efficiency. Previous studies [19, 94] have demonstrated that minimizing these factors across the celestial sphere effectively mitigates systematic effects.

This investigation incorporates a continuously rotating HWP into eq. (5.17) and analyzes the cross-link factor distribution for each *spin*-(n, m) component within the $\{\alpha, T_\alpha\}$ parameter space. Following the methodology proposed in ref. [19], we evaluate the sky-averaged cross-link factor, $\left\langle \left| {}_{n,m}\tilde{h} \right|^2 \right\rangle$. The theoretical framework developed in chapter 4 establishes the relationship between specific systematic effects and their corresponding cross-link factors in *spin* space, thereby demonstrating the metric's utility in systematic effects suppression.

5.5 Results

In this section, we present the optimization metrics results: visibility time of planets, hit-map uniformity, and cross-link factor. Our analysis focuses on the special case where $T_\beta = T_\beta^{\text{lower}}$, allowing us to evaluate all metrics in the $\{\alpha, T_\alpha\}$ space, as shown in figure 5.1 (right). We demonstrate in appendix B.2 that choosing different values of $T_\beta > T_\beta^{\text{lower}}$ merely scales the distribution of metrics in this space while preserving their optimal values.

5.5.1 Visibility time of compact sources

A planetary observation is recorded when the boresight comes within 0.5° of a planet's position. The accumulated duration of such encounters defines the visibility time. Also, we consider same

⁵The HWP angle ϕ is defined in accordance with standardized polarization conventions, following either IAU or COSMO (HEALPix) frameworks, see appendix A.4.1 for detail.

quantity for Crab Nebula which is often used as a polarization calibration source. For simulating planetary motions, we make the following assumptions:

- Initial planetary positions are obtained using `Astropy` [99] at 2032-04-01T00:00:00 in Barycentric Dynamical Time.⁶ We assume the position of the Crab Nebula does not change during the mission.
- Planetary positions are computed at one-second intervals, with positions assumed static within each second.
- Five outer planets (Mars, Jupiter, Saturn, Uranus, and Neptune) and Crab Nebula are used as calibration sources.

Figure 5.3 displays the integrated visibility time distribution in the $\{\alpha, T_\alpha\}$ space over the mission's 3-year duration, accounting for all boresight observations of the considered compact sources. The distribution pattern is consistent across all planets, with peak visibility times of 0.77 (Mars), 1.00 (Jupiter), 0.87 (Saturn), and 0.83 (Neptune), 0.90 (Crab Nebula) hours. The accumulated visibility time for all planets is shown in the bottom right plot of figure 5.3, which has 4.4 hours as the peak.

For $T_\alpha \lesssim 100$ hours, the integrated visibility time shows minimal variation with respect to T_α . However, the dependence on α is more pronounced, with the maximum visibility occurring at $\alpha = \beta = 47.5^\circ$ and displaying symmetrical behavior around this value. This pattern can be understood by examining the scan trajectories illustrated in figure 5.2. When $\alpha = \beta = 47.5^\circ$, the two parallel scan lines, formed by the orbital rotation's tangent line shift, intersect at the equator.

The visibility is limited by what we term the 'scan pupil' — an inner gap where planets cannot be observed. This pupil is visible in the center of the one-day hit-map simulation shown in figure 5.2. Consequently, scanning strategies where α deviates significantly from 47.5° result in reduced integrated visibility times.

5.5.2 Forming speed of sky coverage

We simulate the time required to achieve half-sky coverage, T_{cover} in the $N_{\text{side}} = 128$ map. Figure 5.4 (left) shows T_{cover} , in the $\{\alpha, T_\alpha\}$ space. It is clear as figure 5.2 shown, if we have too small (or too large) α , T_{cover} is large, because the scan pupil is large. In order to cover the large sky fraction in a short time, we need to set $30^\circ \lesssim \alpha \lesssim 70^\circ$.

5.5.3 Hit-map uniformity

The distribution of σ_{hits} is shown in figure 5.4 (right). High values of σ_{hits} occur at extreme values of α (both large and small), as illustrated in figure 5.2 (left/right). This is because such scanning strategies result in frequent polar observations but fewer equatorial ones during the one-year observation period. Similarly, when $T_\alpha > 100$ hours, the limited orbital rotation during precession prevents multiple cycles in the same sky region, breaking azimuthal symmetry on the hit-map (see figure 5.2) and increasing σ_{hits} .

⁶<https://www.astropy.org/>

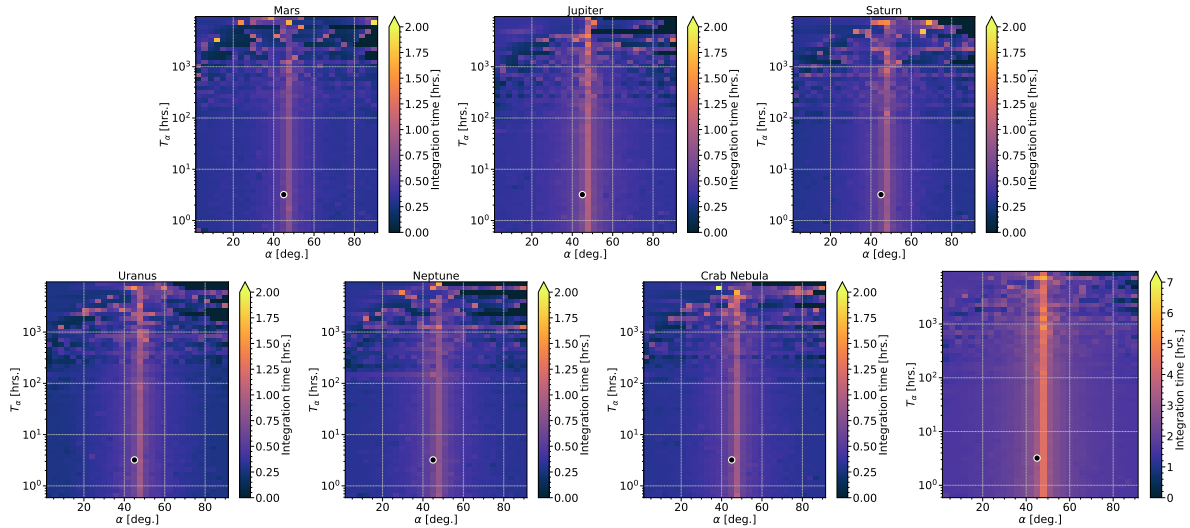

Figure 5.3: Visibility time of planets, Crab Nebula and accumulated visibility time for all planets. The order of figure is organized as Mars, Jupiter, Saturn, Uranus, Neptune, and Crab Nebula from top left to bottom right. The plot on the bottom right shows the accumulated planets visibility time distribution.

For $25^\circ \lesssim \alpha \lesssim 75^\circ$ and $T_\alpha \lesssim 100$ hours, σ_{hits} remains relatively stable, with a notable exception at $\alpha = \beta$. At this special point, trajectory intersection at the equator creates a closed scan pupil, leading to intensive scanning of poles and equator but reduced coverage of equatorial regions, thus increasing variance.

This creates an optimization challenge: minimizing σ_{hits} conflicts with maximizing planetary visibility time, which is determined by the scan pupil size.

Notable outliers appear in the region where $T_\alpha \lesssim 10$ hours, showing σ_{hits} values that deviate from surrounding pixels. This phenomenon, caused by spin-precession period resonance, will be examined in section 5.6.2.

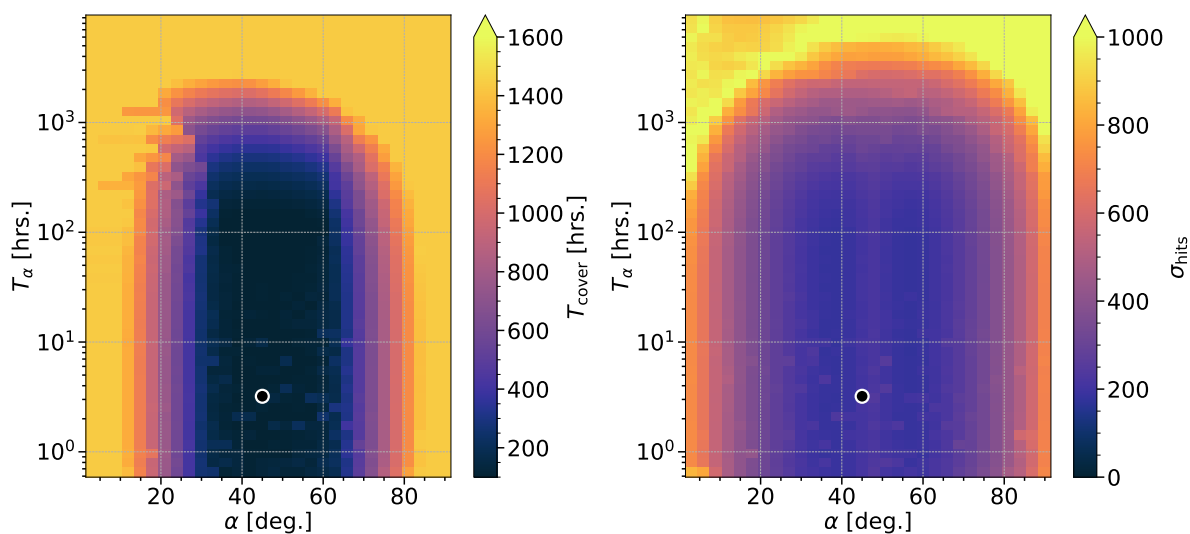

Figure 5.4: (left) The time requires to achieve half-sky coverage, T_{cover} . This is simulated by the $N_{\text{side}} = 128$ map. (right) Hit-map standard deviation at $N_{\text{side}} = 256$. Higher σ_{hits} values occur at extreme α values due to increased polar observations and reduced equatorial coverage.

5.5.4 Cross-link factor

Figure 5.5 presents the distribution of cross-link factors for each $spin-(n, m)$ values in the $\{\alpha, T_\alpha\}$ space. The distributions are organized in three parts: the top two rows show $spin-(n, m)|_{m=0}$ factors without HWP contribution, while the bottom row displays $spin-(n, m)|_{m=4,8}$ factors with HWP contribution.

The $spin-(n, 0)$ distributions align closely with findings from ref. [19], with minor variations attributable to different parameter space sampling. These factors exhibit smaller values for scanning strategies with large α and small β . This reduction occurs because the spin creates smaller rings in this region (visible in figure 5.2), resulting in more uniform crossing angles per sky pixel.

In contrast, the $spin-(n, m)|_{m=4,8}$ factors show remarkably uniform distribution across the $\{\alpha, T_\alpha\}$ space. This uniformity stems from constraint eq. (5.11), where the HWP completes multiple revolutions during sky pixel transit, generating uniform crossing angles between 0 and 2π in a single observation. This flat behavior extends to all $spin-(n, m)|_{m=4,8}$ factors where $1 \leq n \leq 6$, as demonstrated by the $spin-(1, 4)$ and $spin-(2, 4)$ examples in figure 5.5.

5.5.5 Propagation of cross-link factor to bias

We use the map-based method employing the $spin$ formalism from chapter 4 to estimate the measurement bias on r , i.e., Δr , induced by the pointing offset and HWP non-ideality. This demonstrates how the cross-link factor value directly relates to Δr . Detailed estimation methods for Δr are provided in appendix A.3.

The CMB map for this demonstration is generated using CAMB [100].⁷ We adopt a 6-parameter Λ CDM model based on the best fit from *Planck* 2018 results: Hubble constant $H_0 = 67.32$, baryon density $\Omega_b = 0.0494$, dark matter density $\Omega_{cdm} = 0.265$, optical depth to reionization $\tau = 0.0543$, scalar spectral index $n_s = 0.966$, and amplitude of scalar perturbations $A_s = 2.10 \times 10^{-9}$ [101]. The tensor-to-scalar ratio is set to $r = 0$, assuming no primordial B modes.

For the pointing offset simulation, we set the offset parameter $(\rho, \chi) = (1', 0')$ in eq. (6.28) and use a CMB-only map as input. The CMB map is smoothed with a symmetric Gaussian beam of $\text{FWHM} = 17.9'$, simulating the smallest instrumental beam of *LiteBIRD*, as discussed in section 5.3. For the instrumental polarization simulation due to the HWP, we set $\epsilon_1 = 1.0 \times 10^{-5}$ and $\phi_{QI} = 0$ in eq. (6.46), using the CMB solar dipole map as input, as it is a dominant temperature component [102]. While CMB and foreground anisotropies can contribute as leakage signals, CMB anisotropies are negligible compared to the dipole. The complexity of frequency-dependent foregrounds is typically addressed through specific models, masking, and component separation methods, which is beyond the scope of this scanning strategy optimization. Note that the magnitude of systematic effects, i.e., ρ, χ , and ϵ_1 , are not treated as an issue here; only the relative penalty of each scanning strategy is identified. Calibration and mitigation techniques, as discussed in [102, 103], are necessary to address these systematic effects. The map-based simulations using the $spin$ formalism in chapter 4 are approximately

⁷<https://camb.readthedocs.io/en/latest/>

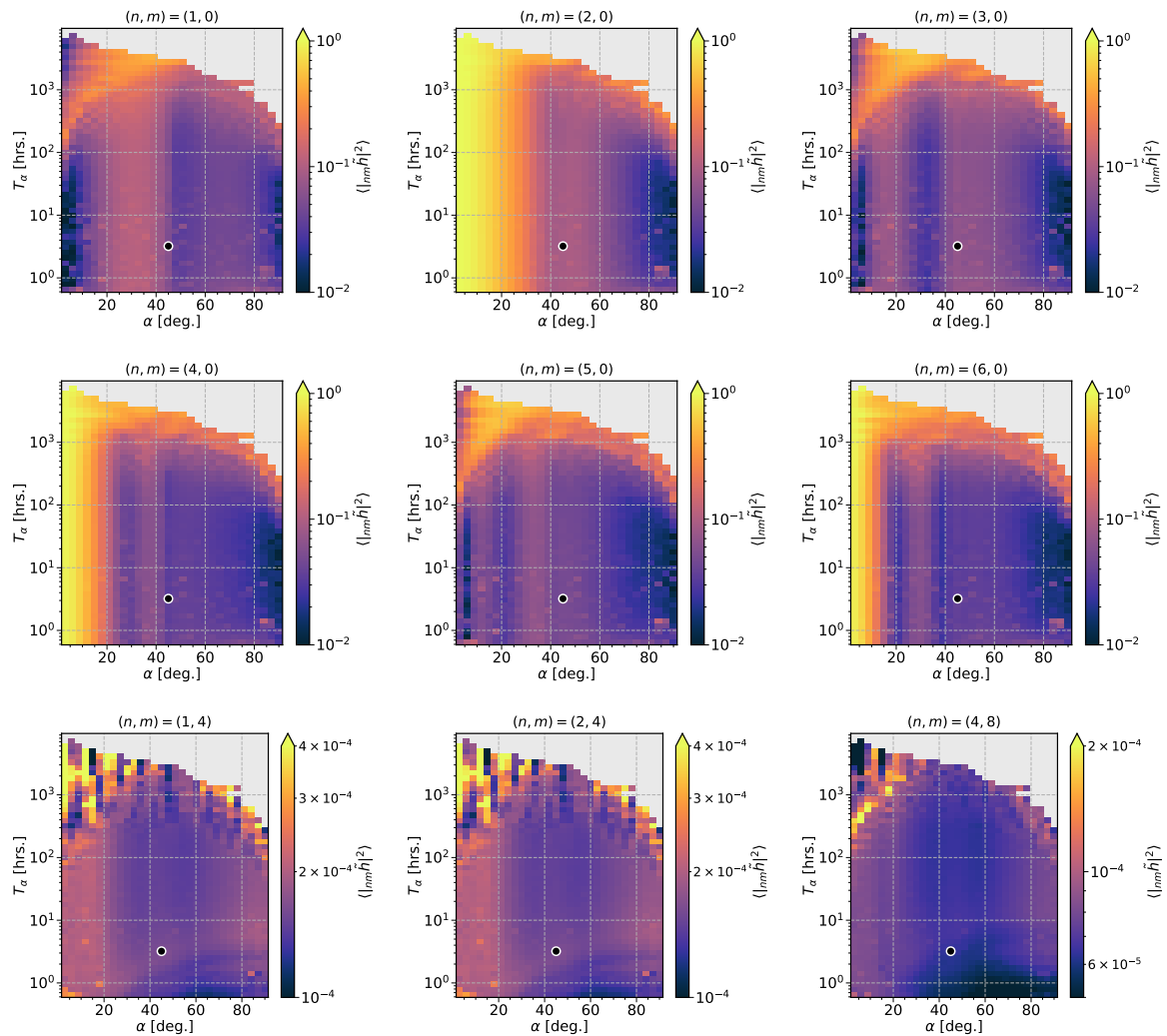

Figure 5.5: Distribution of sky-averaged cross-link factors for different $spin-(n, m)$ configurations. The top two rows show $spin-(n, 0)$ factors without HWP contribution, exhibiting minimal T_α dependence but decreasing values at larger α . The bottom row displays $spin-(n, m)|_{m=4,8}$ factors with HWP contribution, showing uniform distribution across the parameter space due to the eq. (5.11) constraints. The HWP's independent rotation ensures consistent cross-link factors regardless of $spin-n$ when $spin-m$ is non-zero.

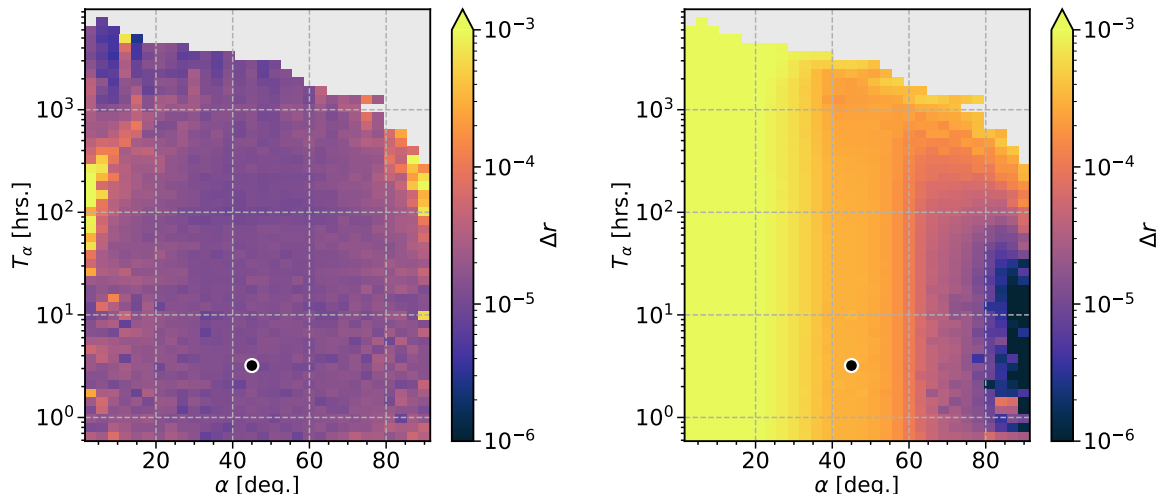

Figure 5.6: (left) Distribution of Δr due to the pointing offset with parameters $(\rho, \chi) = (1', 0')$. The input map is the CMB, smoothed by a Gaussian beam with $\text{FWHM} = 17.9'$. (right) Distribution of Δr due to instrumental polarization with the HWP, using $\epsilon_1 = 1.0 \times 10^{-5}$ and $\phi_{QI} = 0$. The input map is the CMB solar dipole.

10^4 times faster than TOD-based simulations.

Figure 5.6 (left) shows the distribution of Δr due to the pointing offset. The overall flat distribution of Δr , inherited from the $\text{spin}-(n, 4)$ cross-link factors, indicates that the HWP effectively suppresses temperature leakage due to the pointing offset. This confirms that the full-sky average of cross-link factors considering the HWP, as expressed in eq. (5.17), is a suitable indicator for the penalty of the scanning strategy for systematic effects coupled with HWP modulation.

Figure 5.6 (right) shows the distribution of Δr due to instrumental polarization with the non-ideal HWP. The distribution structure is similar to the $\text{spin}-(2, 0)$ cross-link factor in figure 5.5, indicating that this systematic effect is not suppressed by the HWP rotation, and only the $\text{spin}-(2, 0)$ cross-link factor acts as a suppression factor. The justification for the cross-link factor dependency of HWP non-ideality is found in section 6.2.3. These results suggest that systematic effects coupled with the $\text{spin}-(n, 4)$ cross-link factor are suppressed independently of the scanning strategy, and reducing $\text{spin}-(n, 0)$ is crucial even with HWPs.

5.6 Optimization

Based on our previous analysis of how different metrics behave in the $\{\alpha, T_\alpha\}$ parameter space, we confirmed that increasing T_β from T_β^{lower} does not significantly affect the optimized configuration of cross-link factors (see appendix B.2). Our optimization approach will proceed in two steps. First, we will optimize the geometric parameters, as most metrics depend primarily on α and remain largely independent of T_α for values up to 100 hours. Second, with the geometric parameters fixed, we will optimize the kinematic parameters. This two-step approach will allow us to propose an effective scanning strategy that balances all considered metrics. In this section, we begin by examining and comparing different geometric parameter configurations that have

been suggested for next-generation CMB space missions.

5.6.1 Optimization of the geometric parameters

Let us now focus on optimizing the geometric parameters α and β . Given the constraints in eq. (5.4), β is determined by α , making our optimization effectively single-dimensional. Our key objectives are to maximize planet visibility time while minimizing both σ_{hits} and the cross-link factors.

The maximum planet visibility time occurs at $\alpha = \beta = 47.5^\circ$ (the *balanced configuration*), yielding 4.4 hours of integration time. As shown in figure 5.3, planet visibility is symmetrically distributed around this point. However, this configuration exhibits increased σ_{hits} , reducing hit-map uniformity. The *standard configuration*, while providing only 3.2 hours of planet integration time (0.7 times that of *balanced configuration*), achieves 1.1 times better hit-map uniformity.

An alternative configuration with $\alpha = 50^\circ$ that we refer to *flipped configuration* matches the *standard configuration*'s planet integration time and σ_{hits} , while offering marginally better cross-link factors (a 5% improvement). However, comparing the *standard configuration* and *flipped configuration* respect to the *LiteBIRD* as a model, reveals crucial engineering implications:

- The *flipped configuration* increases solar heat input by 8% ($\sin 50^\circ / \cos 45^\circ = 1.08$) while reducing solar panel efficiency by 8%.
- Accommodating this increased heat load would require either:
 - Optimizing thermal protection mechanism e.g. V-grooves (shown in left of figure 5.1) at the cost of telescope volume, or
 - Maintaining the V-groove design but reducing baffle size, resulting in increased side-lobes and systematic effects.

While configurations with $60^\circ \lesssim \alpha \lesssim 70^\circ$ show improved systematic error suppression (see figures 5.5 and 5.6), they further exacerbate heat management issues and reduce solar panel efficiency. Additionally, the smaller associated β values would decrease the CMB solar dipole signal amplitude, compromising gain calibration.

Given these considerations, and building on the systematic studies in refs. [21, 104], we conclude that the *standard configuration* $(\alpha, \beta) = (45^\circ, 50^\circ)$ represents an effective choice for the *LiteBIRD* mission.

5.6.2 Optimization of the kinetic parameters

Having established that the *standard configuration* geometric parameters $(\alpha, \beta) = (45^\circ, 50^\circ)$ provide an effective choice between scientific objectives and spacecraft design constraints for *LiteBIRD*, we now focus on optimizing the kinematic parameters T_α and T_β while keeping these geometric parameters fixed.

Global survey of the kinetic parameter space

Previous simulations used $T_\beta = T_\beta^{\text{lower}}(\alpha, T_\alpha) = 16.9$ min, rather than the *standard configuration*'s proposed 20 min. This lower limit on spacecraft spin period corresponds to an upper limit

on spin rate, ν_β^{upper} , constrained by eq. (5.10). With the HWP handling $1/f$ noise suppression, we can operate below ν_β^{upper} for easier attitude control of the spacecraft. However, slower spin rates reduce number of spins per precession, degrading crossing angle uniformity and increasing $spin-(n, 0)$ cross-link factors. We examine this trade-off between spin rate and cross-link factors.

Figure 5.7 shows the dependence of cross-link factors on T_α and T_β . The top panels display $spin-(n, 0)$ factors, while bottom panels show $spin-(2, 4)$ factors for each telescope. Bottom panels focus on a narrower, higher-resolution parameter space with $T_\alpha \leq 5$ hours. For LFT/MFT/HFT, we use HWP rates of 46/39/61 rpm and N_{side} of 128/128/256, matching their respective beam FWHMs of 23.7/28.0/17.9 arcmin.⁸ Other parameters match the *standard configuration*.

The $spin-(n, 0)$ cross-link factors generally decrease with increasing ν_β and remain nearly constant for $T_\alpha > 2$ hours.⁹ Map outliers show Moiré patterns from spin-precession resonance, which can be eliminated through fine-tuning as discussed in the next section.

Cross-link factors remain stable until $\nu_\beta = 0.05$ rpm, showing only a 5% increase between 0.04-0.05 rpm. HWP-related factors increase with ν_β but oscillate due to spin-HWP synchronization. We select $\nu_\beta = 0.05$ rpm ($T_\beta = 20$ min) as the first local minimum below ν_β^{upper} , balancing attitude control and systematic error suppression.

Regarding precession period optimization, faster rates benefit CMB solar dipole calibration by reducing $1/f$ noise impact. At $\nu_\beta = 0.05$ rpm, $spin-(n, 4)$ factors decrease 15% as T_α increases from T_α^{lower} to 3.2 hours, then stabilize. Therefore, $T_\alpha = 3.2$ hours (192 min) offers an effective choice between precession speed and cross-linking performance.

Fine-tuned study of the precession period

With our geometric parameters now established, we can fine-tune the rotation periods to eliminate resonances. We introduce the ratio η between precession and spin periods:

$$\eta = \frac{T_\alpha}{T_\beta}. \quad (5.18)$$

Our initial value of $\eta = 192 \text{ [min]}/20 \text{ [min]} = 9.6$ is rational, causing the spin to synchronize with precession every 9.6 cycles. This synchronization creates undesirable linear patterns in the hit-map's azimuthal direction as the trajectory intersections remain fixed during solar revolution.

Ref. [105] proposed using irrational numbers' decimal parts to avoid this synchronization. Since irrational numbers cannot be exactly represented computationally, they must be approximated using rational numbers. Diophantine approximation theory suggests using truncated continued-fraction expansions of irrational numbers for this purpose. While ref. [105] recommended the golden ratio for its optimal convergence properties (also supported by dynamical systems analysis in ref. [106]), practical spacecraft operation introduces unavoidable rotational disturbances. We therefore analyze σ_{hits} within $T_\alpha \in [192, 193]$ min at 0.1% resolution to identify regions robust against operational perturbations.

Figure 5.8 plots normalized σ_{hits} and $spin-(n, 0)$ cross-link factors versus T_α . We identify

⁸A HEALPix pixel spans $\sqrt{4\pi/N_{\text{pix}}}$, giving 27.5/13.7 arcmin for $N_{\text{side}}=128/256$.

⁹This trend extends to higher $spin-(n, 0)$ factors ($n = 4, 5, 6$) and persists up to $T_\alpha = 100$ hours.

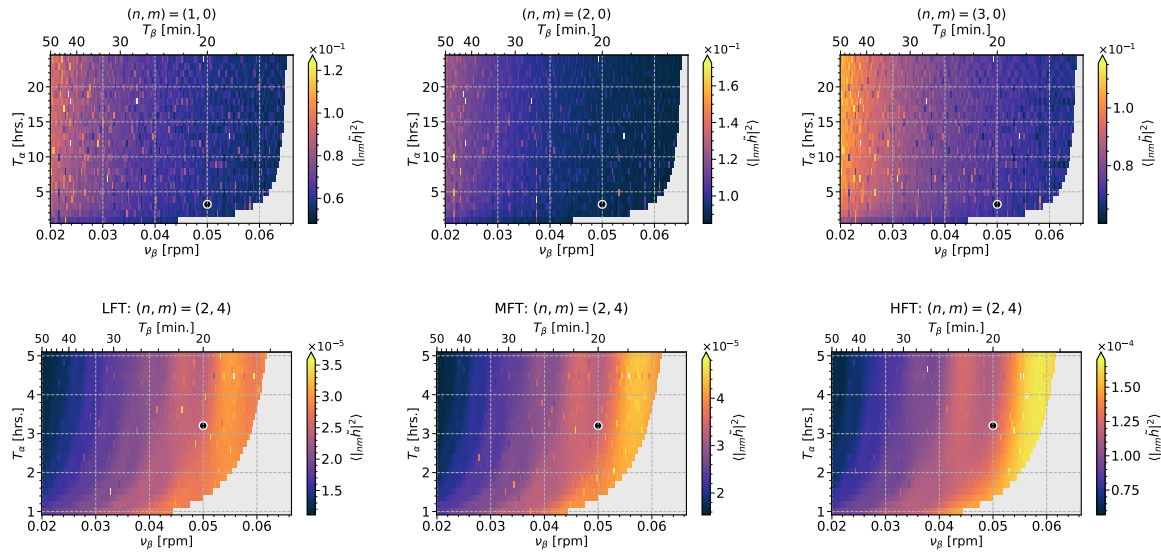

Figure 5.7: (top panels) Cross-link factors for each $spin-(n,0)$ configuration. (bottom panels) $spin-(2,4)$ cross-link factors shown for LFT (left), MFT (middle) and HFT (right) telescopes. The gray shaded region at higher ν_β indicates where $\nu_\beta < \nu_\beta^{\text{upper}}$ (eq. (5.11)) is violated. Missing values within the allowed region are due to spin-precession resonance, discussed further in section 5.6.2. While these configurations still achieve nearly full sky coverage, certain pixels may be unobserved due to redundant trajectories caused by spin-precession synchronization.

an optimal interval of $192.320 \text{ min} \leq T_\alpha \leq 192.370 \text{ min}$ where metrics remain near minimal with low local variation.¹⁰ Within this range, we select $T_\alpha = 192.348 \text{ min}$ for its minimal cross-link factors. Figure 5.9 demonstrates the improvement: strong Moiré patterns visible at $T_\alpha = 192.08 \text{ min}$ (top panels) disappear at our selected value (bottom panels).

While this analysis assumes perfect rotational stability, practical implementation will require further study. Future work should model spacecraft inertia and in-flight stabilization to determine achievable T_α precision under real conditions.

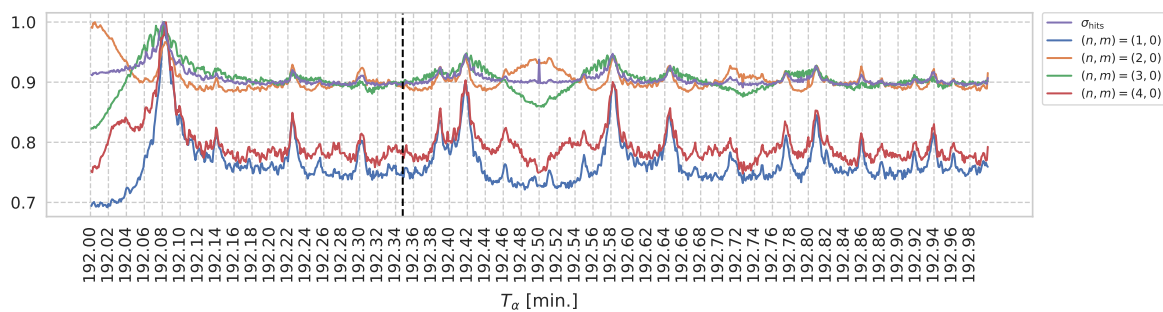

Figure 5.8: Dependence of normalized σ_{hits} and $spin-(n,0)$ cross-link factors on T_α . The dashed black line indicates our chosen value of $T_\alpha = 192.348 \text{ min}$ for the *standard configuration*. Peaks correspond to spin-precession resonances, which produce Moiré patterns in the maps as demonstrated in figure 5.9.

¹⁰Analysis of $spin-(n,m)|_{m=4,8}$ cross-link factors shows minimal resonance effects due to the HWP's relatively high revolution rate compared to spacecraft motions.

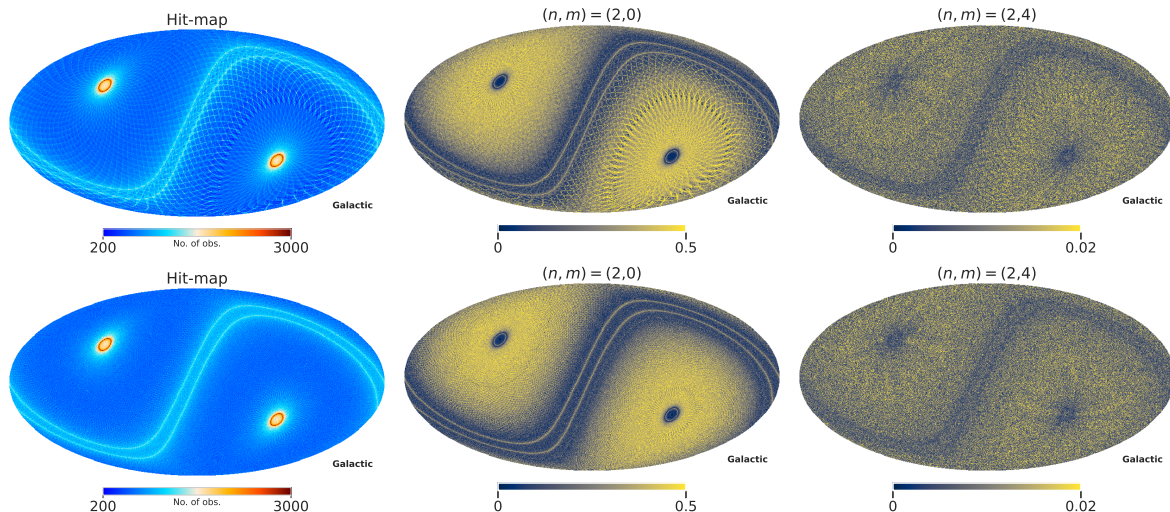

Figure 5.9: Maps showing hit distribution and cross-link factors in Galactic coordinates. Top row ($T_\alpha = 192.08$ min): hit-map (left), *spin*-(2,0) (middle) and *spin*-(2,4) (right) cross-link factors. Bottom row: same quantities for the *standard configuration*'s optimized $T_\alpha = 192.348$ min. The strong Moiré patterns visible in the top panels due to spin-precession resonance are eliminated in the bottom panels through fine-tuning of the precession period.

	α	β	T_α	T_β
<i>LiteBIRD</i>	45°	50°	3.2058 hr	20 min
<i>PICO</i>	26°	69°	10 hr	1 min
<i>Planck</i>	7.5°	85°	6 month	1 min

Table 5.2: Geometric/kinetic parameters of *LiteBIRD*, *PICO* and *Planck* [80,107].

5.7 Implications

This section examines crucial considerations beyond previously discussed metrics when designing scanning strategies. We analyze four key aspects: First, section 5.7.1 explores how scanning strategy impacts beam shape reconstruction through scanning beam angle analysis. Second, section 5.7.2 investigates the scanning strategy's effect on CMB solar dipole amplitude, which is vital for instrumental gain calibration. Third, section 5.7.3 evaluates sky pixel visit/revisit times across different CMB missions, essential for null-tests. Finally, section 5.7.4 assesses planet observation opportunities for calibration during mission duration.

For comparison, we examine the *Planck* mission and planned *PICO* mission. Table 5.2 details their scanning strategies, while figure 5.10 illustrates the time evolution of their simulated hit-maps.

5.7.1 Beam reconstruction systematics

Planet observations enable beam shape reconstruction, making this process crucial for mitigating systematic effects, with scanning strategy playing a vital role [108]. According to ref. [96], systematic effects in the scan direction (like detector time constant and pointing systematics) can create degeneracies with sidelobe shapes, hampering reconstruction capabilities. Despite observing beam shape and detector time constant degeneracy, *Planck* improved Jupiter-based

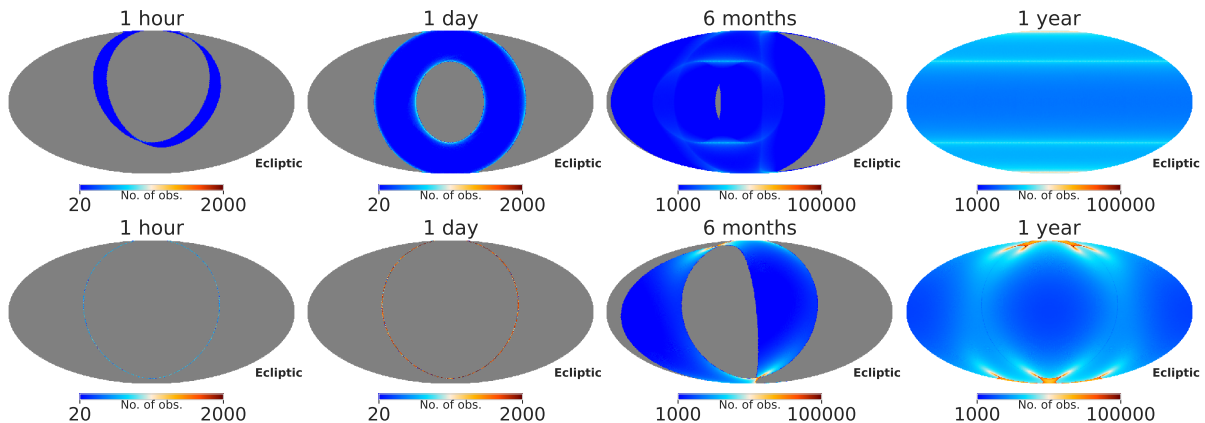

Figure 5.10: Hit-map evolution over time using scanning strategies from *PICO* (top) and *Planck* (bottom). From left to right: observations after 1 hour, 1 day, 6 months, and 1 year. Simulations use 19 Hz sampling rate with $N_{\text{side}} = 128$. Both missions demonstrate continuous sky mapping with overlapping scan rings that shift through slow precession, contrasting with *LiteBIRD*'s *standard configuration* pattern shown in figure 5.2.

beam reconstruction accuracy using a ‘deep scan mode’ that reduced spin axis shift when Jupiter was observable [75]. This demonstrates how appropriate scanning strategy choices can enhance beam measurements.

Figure 5.11 (left) illustrates velocity vectors during one spin cycle. We define the scanning beam angle ζ as the angle between focal plane coordinate x -axis (x_{FP}) and scan velocity vector \vec{v}_{scan} , which combines spin (\vec{v}_{spin}) and precession (\vec{v}_{prec}) velocities. During scanning, \vec{v}_{scan} direction changes relative to x_{FP} , causing $\zeta(t)$ to oscillate over time. Figure 5.11 (right) shows the total amplitude of $\zeta(t)$, representing the scanning direction angle variation range in the detector frame during one spin cycle. Larger amplitudes facilitate both resolving \vec{v}_{scan} -related systematic effect degeneracies and improving beam-shape/sidelobe characterization.

LiteBIRD's short T_{α} produces a ζ amplitude of approximately 5° , significantly larger than *Planck*'s 0.5 arcsec. This larger variation aids sidelobe reconstruction and helps identify unexpected systematics like extended detector time constants or transfer function effects. However, *Planck* and *PICO* strategies, with larger T_{α} , better support frequent short-term compact source observations.

5.7.2 Amplitude of CMB solar dipole

During sky scanning, the CMB dipole manifests as a 3.3 mK sinusoidal signal in the time-ordered data (TOD) [109]. This prominent signal acts as a natural photometric calibrator for detector gain calibration, where larger signal amplitudes facilitate more precise calibration. However, the frequency spectrum of this signal plays an equally critical role in calibration quality.

Various instrumental effects can compromise detector gain stability. For instance, thermal fluctuations typically produce $1/f$ -like gain variation spectra. When these gain fluctuation spectra overlap with dipole signal frequencies, they can significantly degrade calibration accuracy. Therefore, scanning strategies that generate dipole signals with higher-frequency spectral peaks are advantageous for robust calibration.

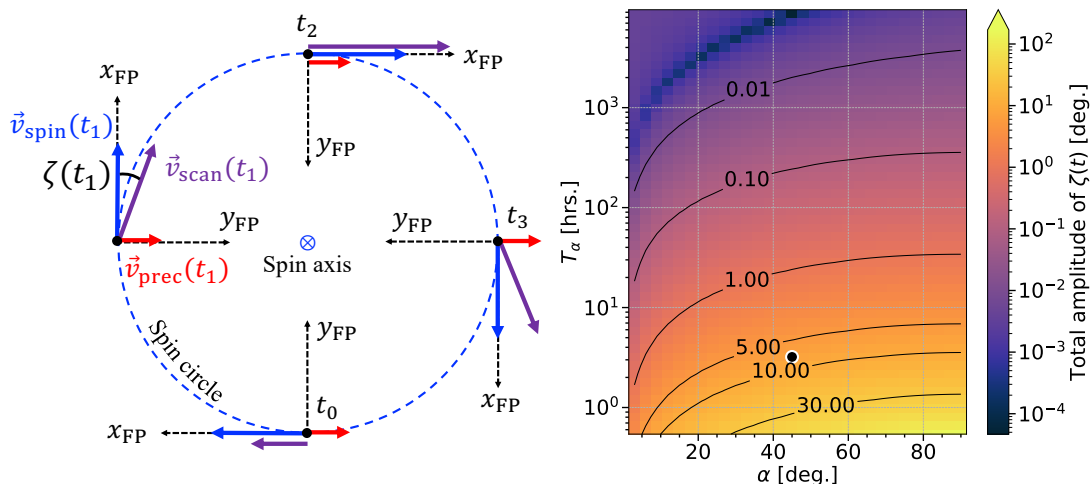

Figure 5.11: (left) Spin cycle velocity vectors viewed from spin axis. x_{FP} and y_{FP} show detector reference frame coordinates, while \vec{v}_{prec} and \vec{v}_{spin} represent precession and spin velocities. Precession pushes the spin axis rightward, causing \vec{v}_{scan} (combining \vec{v}_{prec} and \vec{v}_{spin}) to vary across x_{FP} . Angle ζ measures between \vec{v}_{scan} and x_{FP} . (right) Total $\zeta(t)$ amplitude during one spin cycle across $\{\alpha, T_\alpha\}$ space.

Figure 5.12 presents power spectra analyses of TOD from different space missions scanning a sky containing only the CMB dipole signal. The spectral peaks correspond to spacecraft precession (marked by red \blacktriangledown) and spin (marked by blue \blacktriangledown) frequencies. Notably, *LiteBIRD* exhibits the highest frequency peak by precession, potentially allowing better separation between dipole signals and gain fluctuation spectra, thus enabling more precise calibration. Since spacecraft thermal variations typically occur at the spin frequency due to continuous solar exposure on one side of spacecraft during each spin cycle, this separation is particularly valuable. A distinctive feature of *LiteBIRD*'s spectrum is the presence of two additional peaks around the spin frequency, located at $f_{\text{spin}} \pm f_{\text{prec}}$. These satellite peaks provide additional leverage for calibration and null-tests by helping distinguish between genuine dipole signals and systematic gain drifts caused by spin-synchronized disturbances.

5.7.3 Sky pixel visit/revisit times

To detect unknown time-dependent systematic effects, data is commonly split into different time periods for null-test analysis through differencing. The distribution of pixel observation times indicates null-test effectiveness. Uniform observation of pixels across the mission duration helps detect long-term systematic effects like gain drift. The pixel revisit time, defined as

$$t_j^{\text{re}} = t_{j+1} - t_j, \quad (5.19)$$

where j denotes the j^{th} measurement, is another key indicator. A uniform distribution of revisit times enables analysis across multiple timescales. We analyze three characteristic points in ecliptic coordinates by **HEALPix**: $(\theta, \varphi) = (0^\circ, 0^\circ)$, $(45^\circ, 180^\circ)$, and $(90^\circ, 180^\circ)$. All simulations use 19 Hz sampling rate with $N_{\text{side}} = 64$ pixelization.

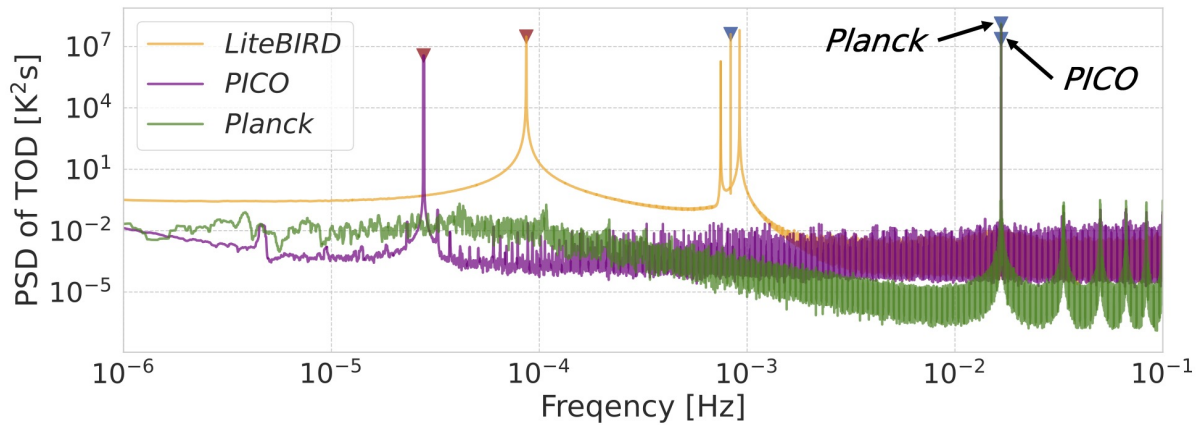

Figure 5.12: Power spectra of TOD from different space missions scanning a sky containing only CMB dipole. The red \blacktriangledown and blue \blacktriangledown markers indicate precession and spin frequencies, respectively.

Figure 5.13 compares visit time distributions across missions. For polar pixels $(\theta, \varphi) = (0^\circ, 0^\circ)$, *LiteBIRD* and *PICO* show consistent year-round visits, while *Planck* exhibits observation gaps. *Planck*'s large β creates wide scan rings, causing intense short-term pixel visits but 6-month gaps between observations as rings drift. These gaps complicate detection of long-term effects like gain drift. In contrast, *LiteBIRD* and *PICO*'s larger α and shorter precession periods enable more frequent pixel visiting. Their main difference appears in equatorial pixel visit distributions, where gaps reflect scan pupil size $(2|\alpha - \beta|)$. Annual unobservable periods occur in regions $|\alpha - \beta|$ from the equator, determined by scan pupil size and orbital velocity.

Figure 5.14 displays revisit time distributions, with blue and red dashed lines marking spin and precession periods. *LiteBIRD* and *PICO* demonstrate extended pixel visibility and diverse revisit timescales, enabling comprehensive null-tests. *Planck* shows abundant short-term revisits but limited long-term pixel visibility, constraining temporal null-test capabilities.

These results suggest scanning strategies with small scan pupils and shorter precession periods ($T_\alpha < 100$ hours) optimize time-domain null-tests, aligning with section 5.6 findings.

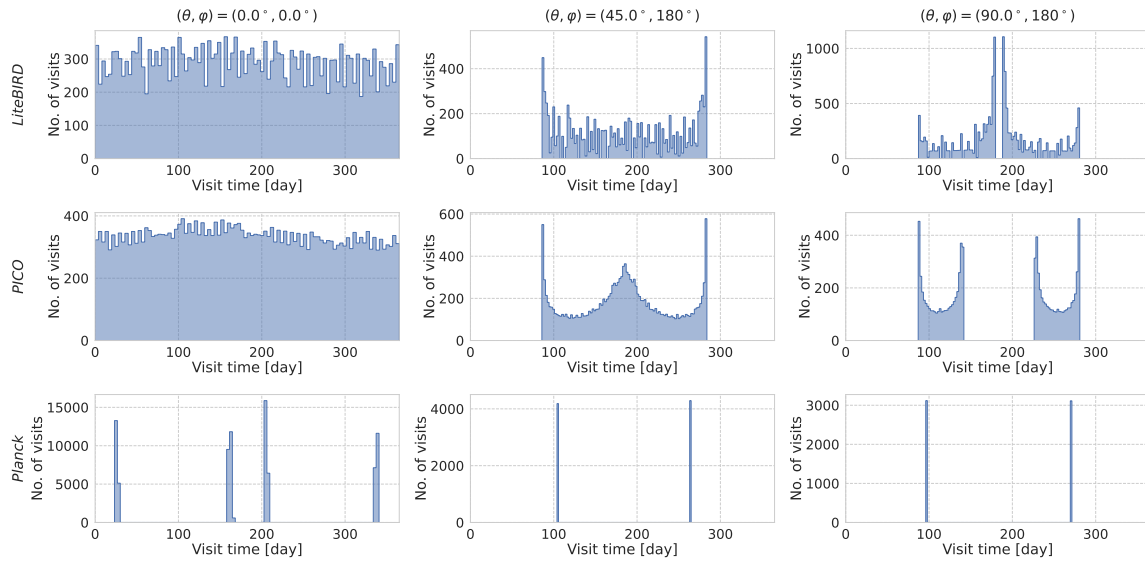

Figure 5.13: Distribution of visit times by spacecraft and sky position. The rows show *LiteBIRD* (top), *PICO* (middle), and *Planck* (bottom). Columns display pixel positions in ecliptic coordinates: North pole ($0^\circ, 0^\circ$), mid-latitude ($45^\circ, 180^\circ$), and equator ($90^\circ, 180^\circ$). All simulations use HEALPix maps with $N_{\text{side}} = 64$ and 19 Hz sampling rate. The Sun- L_2 vector at simulation start points to $(\theta, \varphi) = (90^\circ, 0^\circ)$.

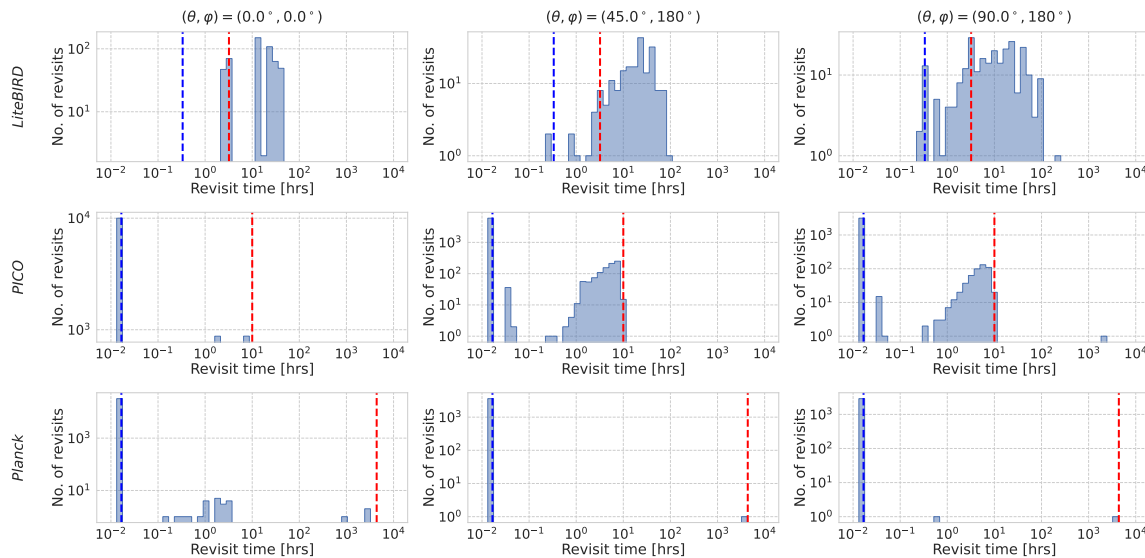

Figure 5.14: Distribution of pixel revisit times across spacecraft and sky positions, corresponding to panel layout in figure 5.13. Blue and red dashed lines mark spin and precession periods respectively. Note: Some revisits occur faster than the spin period because at scan pattern edges, maximum precession angular velocity (ω_{max}) enables earlier revisits.

5.7.4 Planet visit/revisit times

While section 5.5.1 addressed planet observation integration time, this section examines two additional crucial aspects: calibration duration availability throughout the mission and calibration frequency opportunities. We simulate planet visit and revisit times to understand how scanning strategy affects planetary visibility, using the same setup as section 5.5.1 but analyzing temporal distribution rather than integrated visit times.

Figure 5.15 displays planet visit time distributions across spacecraft. The distributions mirror those of equatorial sky pixels $(\theta, \varphi) = (90^\circ, 180^\circ)$ in figure 5.13, as planets orbit near the ecliptic plane. Smaller scan pupils enable longer planetary observation windows. *PICO*'s larger scan pupil creates 90-day observation gaps approximately, though its 1-minute rotation and 10-hour precession periods allow frequent short-term visibility. *Planck* exhibits extreme short-term clustering of observations but with extensive gaps, complicating long-term calibration. Total planetary visibility times are: *LiteBIRD* (3.1 hours), *PICO* (1.8 hours), and *Planck* (1.6 hours). *LiteBIRD*'s superiority stems from its smaller scan pupil and 20-fold longer spin period, extending planet transit times.

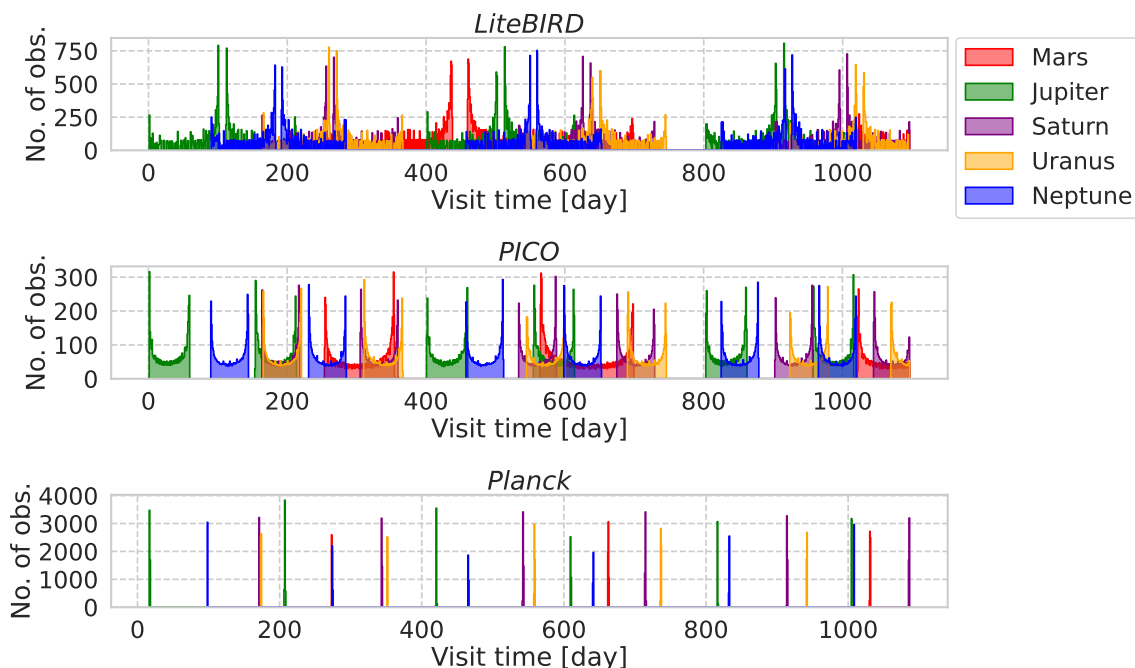

Figure 5.15: Three-year mission planet observation frequency histogram for *LiteBIRD*, *PICO* and *Planck*. Parameters: 1-day bins, simulation start 2032-04-01T00:00:00, 0.5° planet detection threshold, 1-second planet position updates.

Figure 5.16 analyzes Jupiter's revisit time distribution. *LiteBIRD* and *PICO* demonstrate diverse revisit timescales, enabling comprehensive calibration datasets. *Planck* favors shorter timescales. Minimizing scan pupil size maximizes long-term planet visibility and diversifies revisit intervals. Longer spin periods enhance integrated visibility time.

Spacecraft spin periods determine minimum revisit times. For overlapping scan strategies like *PICO*, precession periods limit maximum revisit times. *LiteBIRD*'s non-overlapping spin cycles generate many revisit times exceeding the precession period. All missions share 6-month

maximum revisit intervals, with secondary maxima determined by scan pupil transit times.

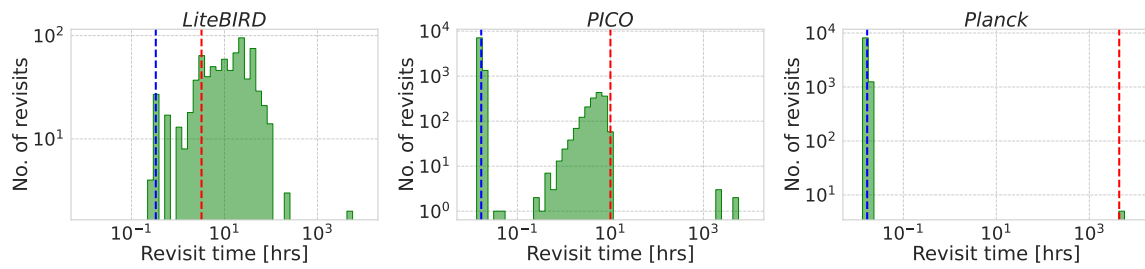

Figure 5.16: Jupiter revisit time distribution from figure 5.15. Blue/red dashed lines indicate spin/precession periods. Minimum revisit times match spin periods; maximum 6-month intervals reflect coverage gaps. Secondary maxima (scan pupil transit times): *LiteBIRD* 10 days, *PICO* 90 days, *Planck* 6 months.

Chapter 6

Systematic effects on CMB polarimetry

Contents

6.1	Systematic effects without HWP	64
6.1.1	Differential gain	64
6.1.2	Differential pointing	66
6.2	Systematic effects with HWP	67
6.2.1	Absolute pointing offset	67
6.2.2	Pointing disturbance due to HWP rotation	69
6.2.3	Instrumental polarization due to HWP non-ideality	70
6.3	Mitigation techniques to control systematic effects by using <i>spin</i>	72
6.4	Results of the systematic effects	74
6.4.1	Differential gain	74
6.4.2	Differential pointing	76
6.4.3	Absolute pointing offset	79
6.4.4	Pointing disturbance due to HWP rotation	83
6.4.5	Instrumental polarization due to HWP non-ideality	87

Building on the *spin* formalism established in chapter 4, this chapter systematically analyzes the contaminating effects of systematics on CMB polarization measurements in *LiteBIRD*'s scanning strategy context. We explore two primary categories of systematic effects: those present in measurements without HWP implementation, and with HWP. Through map-based simulations using *spin* formalism, we demonstrate how these systematics manifest in the observed data and quantify their impact on the tensor-to-scalar ratio measurement. Furthermore, we introduce novel mitigation techniques that exploit the *spin* properties of systematic effects.

This chapter begins by categorizing systematic effects into two primary classifications: those associated with and without HWP implementation. Traditional polarization measurements

without HWP rely on differential detection, which involves subtracting signals from orthogonal detector pairs. This differential approach can introduce several systematic effects, including differential gain, differential pointing, and differential beam, which are considered typical systematic challenges [110].

Although *LiteBIRD* implements HWPs, analyzing these differential systematics provides valuable context for understanding the HWPs' role in systematic mitigation. By examining *LiteBIRD*'s hypothetical performance without HWPs, we gain deeper insights into their benefits. Additionally, we present novel mitigation techniques we have developed to suppress these systematic effects.

The systematic effects analyzed in this chapter include differential gain and differential pointing for the case without HWP. For the case with HWP, we consider absolute pointing offset; pointing disturbance due to HWP rotation; and instrumental polarization due the HWP non-ideality. By the following sections, we describe the model of systematic effect in *spin* space.

In order to simulate these systematic effects, we developed the simulation framework **SBM** (*Spin*-Based Map-making) in **Python**. This software is distributed in author's GitHub repository.¹ To maintain the quality of the code, we wrote unit-tests and applied the 'GitHub Actions' to run the test automatically. The GitHub Actions can run the unit-tests by a virtual machine in cloud server when the new version of the code is pushed to the repository.

6.1 Systematic effects without HWP

For modeling differential systematics, we define the signal field for an orthogonal detector pair T/B as

$$S_{\text{T}}^{(\mu)} = I + \frac{1}{2}Pe^{2i\psi_{\text{T}}^{(\mu)}} + \frac{1}{2}P^*e^{-2i\psi_{\text{T}}^{(\mu)}}, \quad (6.1)$$

$$S_{\text{B}}^{(\mu)} = I - \frac{1}{2}Pe^{2i\psi_{\text{T}}^{(\mu)}} - \frac{1}{2}P^*e^{-2i\psi_{\text{T}}^{(\mu)}}, \quad (6.2)$$

where $\psi_{\text{B}}^{(\mu)} = \psi_{\text{T}}^{(\mu)} + \pi/2$. Here, detectors T and B share the same detector-pixel ID μ and observe the same sky direction. Without a HWP, *spin-m* is always zero, so we omit it from our formalism.

6.1.1 Differential gain

The signal field with time-independent gain offset can be expressed as

$$S_{\text{T,g}}^{(\mu)} = (1 + g_{\text{T}}^{(\mu)})S_{\text{T}}^{(\mu)}, \quad (6.3)$$

$$S_{\text{B,g}}^{(\mu)} = (1 + g_{\text{B}}^{(\mu)})S_{\text{B}}^{(\mu)}, \quad (6.4)$$

¹<https://github.com/yusuke-takase/SBM>

where $g_{\text{T}}^{(\mu)}$ and $g_{\text{B}}^{(\mu)}$ represent the gain offsets of detectors T and B respectively. The differential gain field $D_{\text{g}}^{(\mu)}$ is defined as

$$D_{\text{g}}^{(\mu)} = \frac{1}{2}(S_{\text{T},\text{g}}^{(\mu)} - S_{\text{B},\text{g}}^{(\mu)}) \quad (6.5)$$

$$= \frac{1}{2}[\Delta g^{(\mu)} I + \frac{1}{2}(2 + g_{\text{T}}^{(\mu)} + g_{\text{B}}^{(\mu)})P e^{2i\psi_{\text{T}}^{(\mu)}} + \frac{1}{2}(2 + g_{\text{T}}^{(\mu)} + g_{\text{B}}^{(\mu)})P^* e^{-2i\psi_{\text{T}}^{(\mu)}}], \quad (6.6)$$

where $\Delta g^{(\mu)} = g_{\text{T}}^{(\mu)} - g_{\text{B}}^{(\mu)}$. Fourier transforming with respect to $\psi_{\text{T}}^{(\mu)}$ yields the *spin* space form:

$${}_0\tilde{D}_{\text{g}}^{(\mu)}(\Omega) = \frac{1}{2}\Delta g^{(\mu)} I(\Omega), \quad (6.7)$$

$${}_2\tilde{D}_{\text{g}}^{(\mu)}(\Omega) = \frac{1}{4}(2 + g_{\text{T}}^{(\mu)} + g_{\text{B}}^{(\mu)})P(\Omega), \quad (6.8)$$

$${}_{-2}\tilde{D}_{\text{g}}^{(\mu)}(\Omega) = \frac{1}{4}(2 + g_{\text{T}}^{(\mu)} + g_{\text{B}}^{(\mu)})P^*(\Omega). \quad (6.9)$$

The scanning strategy's mitigation effect is incorporated by coupling these maps using eq. (4.28):

$$\begin{aligned} {}_2\tilde{D}_{\text{g}}^{d(\mu)}(\Omega) &= \sum_{n'} {}_2\tilde{h}^{(\mu)}(\Omega) {}_{n'}\tilde{D}_{\text{g}}^{(\mu)}(\Omega) \\ &= {}_4\tilde{h}^{(\mu)} {}_{-2}\tilde{D}_{\text{g}}^{(\mu)} + {}_2\tilde{h}^{(\mu)} {}_0\tilde{D}_{\text{g}}^{(\mu)} + {}_0\tilde{h}^{(\mu)} {}_2\tilde{D}_{\text{g}}^{(\mu)}, \end{aligned} \quad (6.10)$$

$${}_{-2}\tilde{D}_{\text{g}}^{d(\mu)}(\Omega) = {}_2\tilde{D}_{\text{g}}^{d(\mu)*}(\Omega). \quad (6.11)$$

As we described in section 4.2, the total differential signal ${}_n\tilde{D}_{\text{g}}^{d\text{tot}}$ is obtained through:

$${}_n\tilde{D}_{\text{g}}^{d\text{tot}}(\Omega) = \frac{1}{N_{\text{hits}}^{\text{tot}}(\Omega)} \sum_{\mu} N_{\text{hits}}^{(\mu)}(\Omega) {}_n\tilde{D}_{\text{g}}^{d(\mu)}(\Omega). \quad (6.12)$$

Since differential detection using orthogonal detector pairs should cancel the temperature signal, we can exclude the I component estimation from eq. (4.30). This reduces the matrix dimension from 3×3 to 2×2 , then the map-making equation by a single pair of detectors can be expressed as

$$\begin{pmatrix} \hat{P} \\ \hat{P}^* \end{pmatrix} = {}_2\tilde{M}^{-1} \begin{pmatrix} \frac{1}{2} {}_2\tilde{D}_{\text{g}}^{d(\mu)} \\ \frac{1}{2} {}_{-2}\tilde{D}_{\text{g}}^{d(\mu)} \end{pmatrix}, \quad (6.13)$$

where ${}_2\tilde{M}$ is a 2×2 matrix defined as

$${}_2\tilde{M}^{-1} = \begin{pmatrix} \frac{1}{4} & \frac{1}{4} {}_4\tilde{h}^{(\mu)} \\ \frac{1}{4} {}_{-4}\tilde{h}^{(\mu)} & \frac{1}{4} \end{pmatrix}^{-1}, \quad (6.14)$$

and the map-making equation by the multiple pairs of detectors can be expressed as

$$\begin{pmatrix} \hat{P} \\ \hat{P}^* \end{pmatrix} = \begin{pmatrix} \frac{1}{4} & \frac{1}{4} \tilde{h}^{\text{tot}} \\ \frac{1}{4} {}_{-4}\tilde{h}^{\text{tot}} & \frac{1}{4} \end{pmatrix}^{-1} \begin{pmatrix} \frac{1}{2} {}_2\tilde{D}_{\text{g}}^{d\text{tot}} \\ \frac{1}{2} {}_{-2}\tilde{D}_{\text{g}}^{d\text{tot}} \end{pmatrix}, \quad (6.15)$$

where $\hat{P} = \hat{Q} + i\hat{U}$ represents the estimated polarization.

6.1.2 Differential pointing

To describe the pointing offset, we refer the coordinates and formalism introduced in ref. [19,94]. We use the flat-sky approximation in the small angular scale and span the sky with a Cartesian coordinate system. In this reference frame, x - and y -axis are chosen to be aligned with east and north, respectively. Assuming that a first-order Taylor expansion around a point (x, y) is possible when the pointing offset is small, then, the pointing offset field, S_p as

$$S_p(\psi) = [1 - (\partial_x \Delta x + \partial_y \Delta y)]I + \frac{1}{2} [1 - (\partial_x \Delta x + \partial_y \Delta y)] P e^{2i\psi} + \frac{1}{2} [1 - (\partial_x \Delta x + \partial_y \Delta y)] P^* e^{-2i\psi}. \quad (6.16)$$

The perturbation term can be defined by using the magnitude of the pointing offset, ρ and direction of the pointing offset, χ as

$$\begin{aligned} \partial_x \Delta x + \partial_y \Delta y &= \partial_x [\rho \sin(\psi + \chi)] + \partial_y [\rho \cos(\psi + \chi)] \\ &= \frac{\rho}{2} \left[e^{i(\psi + \chi)} \bar{\partial} + e^{-i(\psi + \chi)} \bar{\bar{\partial}} \right], \end{aligned} \quad (6.17)$$

where we introduced the *spin*-up (-down) ladder operators, $\bar{\partial} = \partial_y - i\partial_x$, ($\bar{\bar{\partial}} = \partial_y + i\partial_x$) as in ref. [94].

Now we can describe the signal field of the pointing offset for a detector-T and B as

$$\begin{aligned} S_{T,p}^{(\mu)}(\psi_T^{(\mu)}) &= I - \frac{\rho_T^{(\mu)}}{2} \left[e^{i(\psi_T^{(\mu)} + \chi_T^{(\mu)})} \bar{\partial} + e^{-i(\psi_T^{(\mu)} + \chi_T^{(\mu)})} \bar{\bar{\partial}} \right] I \\ &+ \frac{1}{2} \left[e^{2i\psi_T^{(\mu)}} - \frac{\rho_T^{(\mu)}}{2} \left(e^{i(3\psi_T^{(\mu)} + \chi_T^{(\mu)})} \bar{\partial} + e^{-i(-\psi_T^{(\mu)} + \chi_T^{(\mu)})} \bar{\bar{\partial}} \right) \right] P \\ &+ \frac{1}{2} \left[e^{-2i\psi_T^{(\mu)}} - \frac{\rho_T^{(\mu)}}{2} \left(e^{i(-\psi_T^{(\mu)} + \chi_T^{(\mu)})} \bar{\partial} + e^{-i(3\psi_T^{(\mu)} + \chi_T^{(\mu)})} \bar{\bar{\partial}} \right) \right] P^*, \end{aligned} \quad (6.18)$$

$$\begin{aligned} S_{B,p}^{(\mu)}(\psi_B^{(\mu)}) &= I - i \frac{\rho_B^{(\mu)}}{2} \left[e^{i(\psi_T^{(\mu)} + \chi_B^{(\mu)})} \bar{\partial} - e^{-i(\psi_T^{(\mu)} + \chi_B^{(\mu)})} \bar{\bar{\partial}} \right] I \\ &- \frac{1}{2} \left[e^{2i\psi_T^{(\mu)}} - i \frac{\rho_B^{(\mu)}}{2} \left(e^{i(3\psi_T^{(\mu)} + \chi_B^{(\mu)})} \bar{\partial} - e^{-i(-\psi_T^{(\mu)} + \chi_B^{(\mu)})} \bar{\bar{\partial}} \right) \right] P \\ &- \frac{1}{2} \left[e^{-2i\psi_T^{(\mu)}} - i \frac{\rho_B^{(\mu)}}{2} \left(e^{i(-\psi_T^{(\mu)} + \chi_B^{(\mu)})} \bar{\partial} - e^{-i(3\psi_T^{(\mu)} + \chi_B^{(\mu)})} \bar{\bar{\partial}} \right) \right] P^*, \end{aligned} \quad (6.19)$$

where $\rho_T^{(\mu)}$ ($\rho_B^{(\mu)}$) is the magnitude of pointing offset, and $\chi_T^{(\mu)}$ ($\chi_B^{(\mu)}$) are the orientation of pointing offset for the detector-T (-B). By taking the difference of the signal fields as shown in

eq. (6.5), we can obtain the differential pointing field as

$$\begin{aligned}
D_{\text{p}}^{(\mu)} &= -\frac{1}{4} \left[\zeta^{(\mu)} e^{i\psi_{\text{T}}^{(\mu)}} \bar{\partial} + \zeta^{*(\mu)} e^{-i\psi_{\text{T}}^{(\mu)}} \bar{\partial} \right] I \\
&+ \frac{1}{2} P e^{2i\psi_{\text{T}}^{(\mu)}} - \frac{1}{4} \left[\bar{\zeta}^{(\mu)} e^{3i\psi_{\text{T}}^{(\mu)}} \bar{\partial} + \bar{\zeta}^{*(\mu)} e^{i\psi_{\text{T}}^{(\mu)}} \bar{\partial} \right] P \\
&+ \frac{1}{2} P^* e^{-2i\psi_{\text{T}}^{(\mu)}} - \frac{1}{4} \left[\bar{\zeta}^{(\mu)} e^{-i\psi_{\text{T}}^{(\mu)}} \bar{\partial} + \bar{\zeta}^{*(\mu)} e^{-3i\psi_{\text{T}}^{(\mu)}} \bar{\partial} \right] P^*,
\end{aligned} \tag{6.20}$$

where we defined $\zeta^{(\mu)}$ and $\bar{\zeta}^{(\mu)}$ as

$$\zeta^{(\mu)} = \rho_{\text{T}}^{(\mu)} e^{i\chi_{\text{T}}^{(\mu)}} - i\rho_{\text{B}}^{(\mu)} e^{i\chi_{\text{B}}^{(\mu)}}, \tag{6.21}$$

$$\bar{\zeta}^{(\mu)} = \rho_{\text{T}}^{(\mu)} e^{i\chi_{\text{T}}^{(\mu)}} + i\rho_{\text{B}}^{(\mu)} e^{i\chi_{\text{B}}^{(\mu)}}. \tag{6.22}$$

By the Fourier transform, we can obtain the *spin* space form as

$${}_1\tilde{D}_{\text{p}}^{(\mu)}(\Omega) = -\frac{1}{4} \left(\zeta^{(\mu)} \bar{\partial} I(\Omega) + \bar{\zeta}^{*(\mu)} \bar{\partial} P(\Omega) \right), \tag{6.23}$$

$${}_2\tilde{D}_{\text{p}}(\Omega) = \frac{1}{2} P(\Omega), \tag{6.24}$$

$${}_3\tilde{D}_{\text{p}}^{(\mu)}(\Omega) = -\frac{1}{4} \bar{\zeta}^{(\mu)} \bar{\partial} P(\Omega). \tag{6.25}$$

The coupling with a scan described as follows

$$\begin{aligned}
{}_2\tilde{D}_{\text{p}}^{d(\mu)}(\Omega) &= \sum_{n'} {}_{2-n'}\tilde{h}^{(\mu)}(\Omega) {}_{n'}\tilde{D}_{\text{p}}^{(\mu)}(\Omega) \\
&= {}_5\tilde{h}^{(\mu)} {}_{-3}\tilde{D}_{\text{p}}^{(\mu)} + {}_4\tilde{h}^{(\mu)} {}_{-2}\tilde{D}_{\text{p}}^{(\mu)} + {}_3\tilde{h}^{(\mu)} {}_{-1}\tilde{D}_{\text{p}}^{(\mu)} \\
&+ {}_1\tilde{h}^{(\mu)} {}_1\tilde{D}_{\text{p}}^{(\mu)} + {}_0\tilde{h}^{(\mu)} {}_2\tilde{D}_{\text{p}}^{(\mu)} + {}_1\tilde{h}^{(\mu)} {}_3\tilde{D}_{\text{p}}^{(\mu)} \\
{}_{-2}\tilde{D}_{\text{p}}^{d(\mu)}(\Omega) &= {}_2\tilde{D}_{\text{p}}^{d(\mu)*}(\Omega)
\end{aligned} \tag{6.26}$$

Same as the differential gain case, we can perform the map-making by eq. (6.13) after obtaining ${}_n\tilde{D}_{\text{p}}^{d(\text{tot})}$ by eq. (6.12).

6.2 Systematic effects with HWP

6.2.1 Absolute pointing offset

Building upon our discussion of differential pointing, we now examine the absolute pointing offset without considering pair difference that arises when the spacecraft's actual pointing direction deviates from its intended target. Such deviations can stem from star tracker calibration errors or misalignment between the star tracker and telescope mounting. To model this absolute pointing offset, we extend the formalism developed in eq. (6.16) to incorporate both telescope

pointing angle ψ and HWP angle ϕ , yielding

$$S_{\text{ap}}(\psi, \phi) = [1 - (\partial_x \Delta x + \partial_y \Delta y)]I + \frac{1}{2}[1 - (\partial_x \Delta x + \partial_y \Delta y)]P e^{-i(4\phi - 2\psi)} + \frac{1}{2}[1 - (\partial_x \Delta x + \partial_y \Delta y)]P^* e^{i(4\phi - 2\psi)}. \quad (6.27)$$

The perturbation term defined in eq. (6.17) can be applied here as well. Using this definition, we can express the absolute pointing offset field as

$$S_{\text{ap}}^{(\mu)}(\psi^{(\mu)}, \phi) = I - \frac{\rho^{(\mu)}}{2} \left[e^{i(\psi^{(\mu)} + \chi^{(\mu)})} \partial + e^{-i(\psi^{(\mu)} + \chi^{(\mu)})} \bar{\partial} \right] I + \frac{1}{2} \left[e^{-i(4\phi - 2\psi^{(\mu)})} - \frac{\rho^{(\mu)}}{2} \left(e^{i(-4\phi + 3\psi^{(\mu)} + \chi^{(\mu)})} \partial + e^{-i(4\phi - \psi^{(\mu)} + \chi^{(\mu)})} \bar{\partial} \right) \right] P + \frac{1}{2} \left[e^{i(4\phi - 2\psi^{(\mu)})} - \frac{\rho^{(\mu)}}{2} \left(e^{i(4\phi - \psi^{(\mu)} + \chi^{(\mu)})} \partial + e^{-i(-4\phi + 3\psi^{(\mu)} + \chi^{(\mu)})} \bar{\partial} \right) \right] P^*. \quad (6.28)$$

It's important to note that the HWP angle remains coherent across all detectors. Through Fourier transformation with respect to both angles $(\psi, \phi) \rightarrow (n, m)$, we can represent the signal in spin space as *spin* space as

$${}_{0,0}\tilde{S}_{\text{ap}} = I, \quad (6.29)$$

$${}_{2,-4}\tilde{S}_{\text{ap}} = -{}_{-2,4}\tilde{S}_{\text{ap}}^* = \frac{P}{2}, \quad (6.30)$$

$${}_{1,0}\tilde{S}_{\text{ap}}^{(\mu)} = -{}_{-1,0}\tilde{S}_{\text{ap}}^{(\mu)*} = -\frac{\rho^{(\mu)}}{2} e^{i\chi^{(\mu)}} \partial I, \quad (6.31)$$

$${}_{1,-4}\tilde{S}_{\text{ap}}^{(\mu)} = -{}_{-1,4}\tilde{S}_{\text{ap}}^{(\mu)*} = -\frac{\rho^{(\mu)}}{4} e^{-i\chi^{(\mu)}} \bar{\partial} P, \quad (6.32)$$

$${}_{3,-4}\tilde{S}_{\text{ap}}^{(\mu)} = -{}_{-3,4}\tilde{S}_{\text{ap}}^{(\mu)*} = -\frac{\rho^{(\mu)}}{4} e^{i\chi^{(\mu)}} \partial P. \quad (6.33)$$

The first two components represent pure signals: *spin*-(0, 0) for temperature and *spin*-($\pm 2, \mp 4$) for polarization P or P^* . The remaining three terms characterize systematic effects. Examining the systematic signal in eq. (6.31), we observe that the pointing offset's perturbation, through the action of *spin* ladder operators, transforms the original *spin*-(0, 0) temperature field into a *spin*-($\pm 1, 0$) signal. These ladder operators, representing the field's gradient, generate spurious odd *spin* components absent in the expected signal. Using eq. (4.19), we can express the

coupling between the scanning strategy and systematic effects for the pointing offset as

$${}_{0,0}\tilde{S}_{\text{ap}}^{d(\mu)}(\Omega) = \sum_{n'=-\infty}^{\infty} \sum_{m'=-\infty}^{\infty} {}_{0-n',0-m'}\tilde{h}^{(\mu)}(\Omega) {}_{n',m'}\tilde{S}_{\text{ap}}^{(\mu)}(\Omega) \quad (6.34)$$

$$\begin{aligned} &= {}_{3,-4}\tilde{h}^{(\mu)} {}_{-3,4}\tilde{S}_{\text{ap}}^{(\mu)} + {}_{2,-4}\tilde{h}^{(\mu)} {}_{-2,4}\tilde{S}_{\text{ap}}^{(\mu)} + {}_{1,-4}\tilde{h}^{(\mu)} {}_{-1,4}\tilde{S}_{\text{ap}}^{(\mu)} \\ &\quad + {}_{1,0}\tilde{h}^{(\mu)} {}_{-1,0}\tilde{S}_{\text{ap}}^{(\mu)} + {}_{0,0}\tilde{h}^{(\mu)} {}_{0,0}\tilde{S}_{\text{ap}}^{(\mu)} + {}_{-1,0}\tilde{h}^{(\mu)} {}_{1,0}\tilde{S}_{\text{ap}}^{(\mu)} \\ &\quad + {}_{-1,4}\tilde{h}^{(\mu)} {}_{1,-4}\tilde{S}_{\text{ap}}^{(\mu)} + {}_{-2,4}\tilde{h}^{(\mu)} {}_{2,-4}\tilde{S}_{\text{ap}}^{(\mu)} + {}_{-3,4}\tilde{h}^{(\mu)} {}_{3,-4}\tilde{S}_{\text{ap}}^{(\mu)}, \\ {}_{2,-4}\tilde{S}_{\text{ap}}^{d(\mu)}(\Omega) &= {}_{-2,4}\tilde{S}_{\text{ap}}^{d(\mu)*}(\Omega) = \sum_{n'=-\infty}^{\infty} \sum_{m'=-\infty}^{\infty} {}_{2-n',-4-m'}\tilde{h}^{(\mu)}(\Omega) {}_{n',m'}\tilde{S}_{\text{ap}}^{(\mu)}(\Omega) \quad (6.35) \\ &= {}_{5,-8}\tilde{h}^{(\mu)} {}_{-3,4}\tilde{S}_{\text{ap}}^{(\mu)} + {}_{4,-8}\tilde{h}^{(\mu)} {}_{-2,4}\tilde{S}_{\text{ap}}^{(\mu)} + {}_{3,-8}\tilde{h}^{(\mu)} {}_{-1,4}\tilde{S}_{\text{ap}}^{(\mu)} \\ &\quad + {}_{3,-4}\tilde{h}^{(\mu)} {}_{-1,0}\tilde{S}_{\text{ap}}^{(\mu)} + {}_{2,-4}\tilde{h}^{(\mu)} {}_{0,0}\tilde{S}_{\text{ap}}^{(\mu)} + {}_{1,-4}\tilde{h}^{(\mu)} {}_{1,0}\tilde{S}_{\text{ap}}^{(\mu)} \\ &\quad + {}_{1,0}\tilde{h}^{(\mu)} {}_{1,-4}\tilde{S}_{\text{ap}}^{(\mu)} + {}_{0,0}\tilde{h}^{(\mu)} {}_{2,-4}\tilde{S}_{\text{ap}}^{(\mu)} + {}_{-1,0}\tilde{h}^{(\mu)} {}_{3,-4}\tilde{S}_{\text{ap}}^{(\mu)}. \end{aligned}$$

These equations demonstrate how the scanning strategy's orientation functions ${}_{n,m}\tilde{h}$ couple with systematic fields ${}_{n,m}\tilde{S}$ through multiplication. This coupling mechanism explicitly reveals how specific *spin*-(n, m) systematic effects can be suppressed through careful design of the scanning strategy.

6.2.2 Pointing disturbance due to HWP rotation

While the HWP effectively enables polarization measurement through modulation, its physical imperfections can introduce systematic effects. A notable example is the non-perfectly flat surfaces of sapphire-based HWPs, which create a small wedge angle. This imperfection leads to pointing disturbances during HWP rotation.

Given a HWP wedge angle w , refraction causes the pointing direction to deviate by an angle ξ from its original path, expressed as

$$\xi = (n_{\text{ref}} - 1)w, \quad (6.36)$$

where n_{ref} represents sapphire's refractive index. During HWP rotation, the pointing direction traces a circular path with radius ξ around the expected direction. The pointing disturbance field induced by the HWP wedge angle, denoted as S_w , can be formulated as

$$\begin{aligned} S_w^{(\mu)}(\psi^{(\mu)}, \phi) &= I - \frac{\xi}{2} \left[e^{i(\psi^{(\mu)} + \phi + \chi)} \bar{\partial} + e^{-i(\psi^{(\mu)} + \phi + \chi)} \bar{\partial} \right] I \\ &\quad + \frac{1}{2} \left[e^{-i(4\phi - 2\psi^{(\mu)})} - \frac{\xi}{2} \left(e^{i(-3\phi + 3\psi^{(\mu)} + \chi)} \bar{\partial} + e^{-i(5\phi - \psi^{(\mu)} + \chi)} \bar{\partial} \right) \right] P \\ &\quad + \frac{1}{2} \left[e^{i(4\phi - 2\psi^{(\mu)})} - \frac{\xi}{2} \left(e^{i(5\phi - \psi^{(\mu)} + \chi)} \bar{\partial} + e^{-i(-3\phi + 3\psi^{(\mu)} + \chi)} \bar{\partial} \right) \right] P^*. \end{aligned} \quad (6.37)$$

This model is derived by substituting $\chi \rightarrow \phi + \chi$ in eq. (6.28), where χ represents the HWP

angle phase. The Fourier transform yields the following *spin* space representation:

$${}_{0,0}\tilde{S}_w = I, \quad (6.38)$$

$${}_{2,-4}\tilde{S}_w = -{}_{2,4}\tilde{S}_w^* = \frac{P}{2}, \quad (6.39)$$

$${}_{1,1}\tilde{S}_w = -{}_{1,1}\tilde{S}_w^* = -\frac{\xi}{2}e^{i\chi}\bar{\partial}I, \quad (6.40)$$

$${}_{-3,3}\tilde{S}_w = {}_{3,-3}\tilde{S}_w^* = -\frac{\xi}{4}e^{i\chi}\bar{\partial}P, \quad (6.41)$$

$${}_{1,-5}\tilde{S}_w = {}_{5,-1}\tilde{S}_w^* = -\frac{\xi}{4}e^{-i\chi}\bar{\partial}P. \quad (6.42)$$

Since the HWP wedge angle produces a consistent pointing perturbation direction, the systematic field remains detector-pixel ID (μ) independent. The coupling between systematic effects and scanning can be expressed as

$${}_{0,0}\tilde{S}_w^d(\Omega) = \sum_{n'=-\infty}^{\infty} \sum_{m'=-\infty}^{\infty} {}_{0-n',0-m'}\tilde{h}(\Omega)_{n',m'}\tilde{S}_w(\Omega) \quad (6.43)$$

$$\begin{aligned} &= {}_{3,-3}\tilde{h}_{-3,3}\tilde{S}_w + {}_{2,-4}\tilde{h}_{-2,4}\tilde{S}_w + {}_{1,-5}\tilde{h}_{-1,5}\tilde{S}_w \\ &\quad + {}_{1,1}\tilde{h}_{-1,-1}\tilde{S}_w + {}_{0,0}\tilde{h}_{0,0}\tilde{S}_w + {}_{-1,-1}\tilde{h}_{1,1}\tilde{S}_w \\ &\quad + {}_{-1,5}\tilde{h}_{1,-5}\tilde{S}_w + {}_{-2,4}\tilde{h}_{2,-4}\tilde{S}_w + {}_{-3,3}\tilde{h}_{3,-3}\tilde{S}_w, \end{aligned}$$

$${}_{2,-4}\tilde{S}_w^d = -{}_{2,4}\tilde{S}_w^{d*} = \sum_{n'=-\infty}^{\infty} \sum_{m'=-\infty}^{\infty} {}_{2-n',-4-m'}\tilde{h}(\Omega)_{n',m'}\tilde{S}_w(\Omega) \quad (6.44)$$

$$\begin{aligned} &= {}_{4,-7}\tilde{h}_{-3,3}\tilde{S}_w + {}_{4,-8}\tilde{h}_{-2,4}\tilde{S}_w + {}_{3,-9}\tilde{h}_{-1,5}\tilde{S}_w \\ &\quad + {}_{3,-3}\tilde{h}_{-1,-1}\tilde{S}_w + {}_{2,-4}\tilde{h}_{0,0}\tilde{S}_w + {}_{1,-5}\tilde{h}_{1,1}\tilde{S}_w \\ &\quad + {}_{1,1}\tilde{h}_{1,-5}\tilde{S}_w + {}_{0,0}\tilde{h}_{2,-4}\tilde{S}_w + {}_{-1,-1}\tilde{h}_{3,-3}\tilde{S}_w. \end{aligned}$$

The pointing offset generates spurious *spin*-($\pm 1, 0$) systematics from the *spin*-(0,0) temperature field through the *spin* ladder operators, which represent the field's gradient. For pointing systematics due to the HWP wedge angle, the HWP rotation induces pointing disturbances that sample the gradient fields. This process generates spurious *spin*-($\pm 1, 0$) fields from the original *spin*-(0,0) temperature field. The systematic effect modulates the temperature signal at the HWP rotation frequency f_ϕ , manifesting as a HWP synchronous systematic effect at $1f_\phi$.

6.2.3 Instrumental polarization due to HWP non-ideality

Although HWPs effectively modulate polarization signals, suppress $1/f$ noise, and reduce polarization measurement uncertainties even with single detectors, their inherent imperfections introduce systematic effects that require careful consideration [111–113]. Of particular concern are the non-diagonal terms in the HWP Mueller matrix arising from non-ideality, which can generate instrumental polarization leading to temperature-to-polarization leakage which is denoted as $T \rightarrow B$.

As discussed in ref. [102], this systematic effect significantly impacts measurements through the CMB solar dipole and Galactic emission intensity. To quantify the bias on r induced by

instrumental polarization, ref. [102] introduced the Mueller matrix deviation ΔM from an ideal HWP. Considering only the instrumental polarization components at modulation frequency $4f_\phi$ that contribute to $T \rightarrow B$ leakage, the systematic field ΔS_{ip} can be expressed as

$$\Delta S_{\text{ip}}^{(\mu)} = \left[\epsilon_1^{(\mu)} \cos(4\phi - 4\psi^{(\mu)} + \phi_{QI}) \cos 2\psi_0^{(\mu)} + \epsilon_2^{(\mu)} \cos(4\phi - 4\psi^{(\mu)} + \phi_{UI}) \sin 2\psi_0^{(\mu)} \right] I, \quad (6.45)$$

where ψ_0 represents the detector's polarization angle relative to the focal plane reference axis, and ϕ_{QI} and ϕ_{UI} denote the phases described in ref. [102]. The parameters ϵ_1 and ϵ_2 represent the amplitudes of the Mueller matrix elements at $4f_\phi$, which ideally should be zero but acquire finite values due to HWP non-ideality.

This systematic signal arises from two coupled physical mechanisms: First, for incident polarization perpendicular to the HWP, the 180° retardation difference between polarization states generates a spurious $2f_\phi$ -signal; Second, the non-perpendicular s- and p-polarization components flip every 180° HWP rotation, producing another $2f_\phi$ -signal. The coupling between these $2f_\phi$ -signals generates spurious $4f_\phi$ -signals that mimic polarization signals [114]. Notably, this effect persists despite HWP rotation since it originates from the rotation itself. Under the assumptions $\epsilon_1^{(\mu)} = \epsilon_2^{(\mu)}$ and $\phi_{QI} = \phi_{UI} + \frac{\pi}{2}$, the systematic signal can be expressed in a more compact form:

$$\Delta S_{\text{ip}}^{(\mu)} = \frac{\epsilon_1^{(\mu)}}{2} \left[e^{i(4\phi - 4\psi^{(\mu)} + \phi_{QI} - 2\psi_0^{(\mu)})} + e^{-i(4\phi - 4\psi^{(\mu)} + \phi_{QI} + 2\psi_0^{(\mu)})} \right] I. \quad (6.46)$$

In a coordinate system where $\psi_0 = 0$, Fourier transformation yields the *spin* space representation:

$${}_{4,-4}\Delta\tilde{S}_{\text{ip}}^{(\mu)} = {}_{-4,4}\Delta\tilde{S}_{\text{ip}}^{*(\mu)} = \frac{\epsilon_1^{(\mu)}}{2} e^{-i\phi_{QI}} I. \quad (6.47)$$

The coupling with scanning strategy according to eq. (4.19) results in:

$$\begin{aligned} {}_{0,0}\Delta\tilde{S}_{\text{ip}}^{d(\mu)} &= \sum_{n'=-\infty}^{\infty} \sum_{m'=-\infty}^{\infty} {}_{0-n',0-m'}\tilde{h}_{n',m'}^{(\mu)} \Delta\tilde{S}_{\text{ip}}^{(\mu)} \\ &= {}_{4,-4}\tilde{h}^{(\mu)} {}_{-4,4}\Delta\tilde{S}_{\text{ip}}^{(\mu)} + {}_{-4,4}\tilde{h}^{(\mu)} {}_{4,-4}\Delta\tilde{S}_{\text{ip}}^{(\mu)}, \end{aligned} \quad (6.48)$$

$$\begin{aligned} {}_{2,-4}\Delta\tilde{S}_{\text{ip}}^{d(\mu)} &= {}_{-2,4}\Delta\tilde{S}_{\text{ip}}^{d*(\mu)} = \sum_{n'=-\infty}^{\infty} \sum_{m'=-\infty}^{\infty} {}_{2-n',-4-m'}\tilde{h}_{n',m'}^{(\mu)} \Delta\tilde{S}_{\text{ip}}^{(\mu)} \\ &= {}_{6,-8}\tilde{h}^{(\mu)} {}_{-4,4}\Delta\tilde{S}_{\text{ip}}^{(\mu)} + {}_{-2,0}\tilde{h}^{(\mu)} {}_{4,-4}\Delta\tilde{S}_{\text{ip}}^{(\mu)}. \end{aligned} \quad (6.49)$$

The HWP's contribution significantly suppresses systematic signals coupled to $\pm_{4,\mp 4}\tilde{h}$ and $\pm_{6,\mp 8}\tilde{h}$ terms through their real and imaginary parts. However, $\pm_{2,0}\tilde{h}$ lacks HWP contribution, leaving the associated temperature leakage only moderated by the scanning strategy. While previous studies have shown that this bias on r can be compensated [102], this case effectively demonstrates how crucial the scanning strategy remains, even with HWP implementation.

6.3 Mitigation techniques to control systematic effects by using *spin*

In this section, we discuss the mitigation of the systematic effects. The map-making can be recognized as a linear regression problem, and it regresses the signal basis vector, which corresponds to the \mathbf{w}_j in eq. (4.10). If we reconstruct not only the Stokes vector but also the systematic effects per *spin*-(n, m), we can suppress the leakage due to the systematic effects to the Stokes vector. Now we start from a general case that the TOD, d_j detected by a single detector can be written as

$$\begin{aligned}
d_j &= I + Q \cos(4\phi_j - 2\psi_j) + U \sin(4\phi_j - 2\psi_j) \\
&\quad + \sum_{n \geq 0} [{}_{n,m}Z^Q \cos(n\psi_j + m\phi_j) + {}_{n,m}Z^U \sin(n\psi_j + m\phi_j)] + n_j \\
&= \begin{pmatrix} 1 & \cos(4\phi_j - 2\psi_j) & \sin(4\phi_j - 2\psi_j) & \cdots & \cos(n\psi_j + m\phi_j) & \sin(n\psi_j + m\phi_j) \end{pmatrix} \begin{pmatrix} I \\ Q \\ U \\ \vdots \\ {}_{n,m}Z^Q \\ {}_{n,m}Z^U \end{pmatrix} + n_j \\
&= \mathbf{w}_j \cdot \mathbf{s} + n_j,
\end{aligned} \tag{6.50}$$

where ${}_{n,m}Z^Q$ and ${}_{n,m}Z^U$ are additional *spin*-(n, m) signals that may be attributed to systematic effects (or sky component, such as $\bar{\delta}I$ in the differential pointing systematics) where the superscripts Q and U are in analogy to the polarization signal [20]. In order to estimate the signal vector from the measured data samples, we minimize:

$$\chi^2 = \sum_{i,j} (d_i - \mathbf{w}_i \cdot \mathbf{s})(N^{-1})_{ij}(d_j - \mathbf{w}_j \cdot \mathbf{s}), \tag{6.51}$$

where N_{ij} is the noise covariance matrix. After minimization, we can obtain the equation to estimate the signal vector as

$$\hat{\mathbf{s}} = \left(\sum_{i,j} \mathbf{w}_i^\dagger (N^{-1})_{ij} \mathbf{w}_j \right)^{-1} \left(\sum_{i,j} \mathbf{w}_i^\dagger (N^{-1})_{ij} d_j \right), \tag{6.52}$$

then, we assume the noise is white noise, i.e., $N_{ij} = \sigma^2 \delta_{ij}$, where σ is the standard deviation of the noise. The equation can be simplified as

$$\begin{aligned} \hat{\mathbf{s}} &= \left(\sum_j \mathbf{w}_j^\dagger \mathbf{w}_j \right)^{-1} \left(\sum_j \mathbf{w}_j^\dagger d_j \right) \\ &= M^{-1} \begin{pmatrix} \langle d_j \rangle \\ \langle d_j \cos(4\phi_j - 2\psi_j) \rangle \\ \langle d_j \sin(4\phi_j - 2\psi_j) \rangle \\ \vdots \\ \langle d_j \cos(n\psi_j + m\phi) \rangle \\ \langle d_j \sin(n\psi_j + m\phi) \rangle \end{pmatrix}, \end{aligned} \quad (6.53)$$

where M is the matrix defined as

$$M = \begin{pmatrix} 1 & \langle \cos(4\phi - 2\psi_j) \rangle & \langle \sin(4\phi - 2\psi_j) \rangle & \cdots & \langle \cos(n\psi_j + m\phi) \rangle & \langle \sin(n\psi_j + m\phi) \rangle \\ \langle \cos(4\phi - 2\psi_j) \rangle & \langle \cos^2(4\phi - 2\psi_j) \rangle & \langle \cos(4\phi - 2\psi_j) \sin(4\phi - 2\psi_j) \rangle & \cdots & \vdots & \vdots \\ \langle \sin(4\phi - 2\psi_j) \rangle & \langle \cos(4\phi - 2\psi_j) \sin(4\phi - 2\psi_j) \rangle & \langle \sin^2(4\phi - 2\psi_j) \rangle & \cdots & \vdots & \vdots \\ \vdots & \vdots & \vdots & \ddots & \vdots & \vdots \\ \langle \cos(n\psi_j + m\phi) \rangle & \cdots & \cdots & \cdots & \langle \cos^2(n\psi_j + m\phi) \rangle & \vdots \\ \langle \sin(n\psi_j + m\phi) \rangle & \cdots & \cdots & \cdots & \cdots & \langle \sin^2(n\psi_j + m\phi) \rangle \end{pmatrix}. \quad (6.54)$$

The mitigation technique with this formalism is introduced by appendix A1.2 of ref. [20], and it corresponds the following equation in *spin* space as

$$\begin{pmatrix} I \\ P \\ P^* \\ \vdots \\ {}_{n,m}Z \\ {}_{-n,-m}Z \end{pmatrix} = \tilde{M}^{-1} \begin{pmatrix} {}_{0,0}\tilde{S}^d \\ {}_{2,-4}\tilde{S}^d \\ {}_{-2,4}\tilde{S}^d \\ \vdots \\ {}_{n,m}\tilde{S}^d \\ {}_{-n,-m}\tilde{S}^d \end{pmatrix}, \quad (6.55)$$

where ${}_{n,m}Z$ and ${}_{-n,-m}Z$ are the estimated systematic signals in *spin* space, and \tilde{M} is the matrix defined as

$$\tilde{M} = \begin{pmatrix} 1 & \frac{1}{2}{}_{-2,4}\tilde{h} & \frac{1}{2}{}_{2,-4}\tilde{h} & \cdots & \frac{1}{2}{}_{-n,-m}\tilde{h} & \frac{1}{2}{}_{n,m}\tilde{h} \\ \frac{1}{2}{}_{2,-4}\tilde{h} & \frac{1}{4} & \frac{1}{4}{}_{4,-8}\tilde{h} & \cdots & \vdots & \vdots \\ \frac{1}{2}{}_{-2,4}\tilde{h} & \frac{1}{4}{}_{-4,8}\tilde{h} & \frac{1}{4} & \cdots & \vdots & \vdots \\ \vdots & \vdots & \vdots & \ddots & \vdots & \vdots \\ \frac{1}{2}{}_{n,m}\tilde{h} & \cdots & \cdots & \cdots & \frac{1}{4} & \frac{1}{4}{}_{2n,2m}\tilde{h} \\ \frac{1}{2}{}_{-n,-m}\tilde{h} & \cdots & \cdots & \cdots & \frac{1}{4}{}_{-2n,-2m}\tilde{h} & \frac{1}{4} \end{pmatrix}. \quad (6.56)$$

It allows us to estimate the polarization without contamination due to the systematic effect given by ${}_{n,m}Z$.

6.4 Results of the systematic effects

We first consider the case of a single detector at the boresight, so we drop the superscript μ which was used to distinguish a detector's pixel ID. The input map is CMB only which is created by the Λ CDM model with the CAMB, and the 6-cosmological parameter is set to the *Planck* 2018 best-fit values with no primordial B -modes, i.e., $r = 0$ as same as we used for section 5.5.5. The scanning strategy is assumed to be the *LiteBIRD's standard configuration* [25]. Finally, the map is smoothed by the Gaussian beam with FWHM = 1° .

6.4.1 Differential gain

We assume that a single pair detectors-T/B on the boresight have the gain offset: $g_T = 0.001$ and $g_B = 0$, i.e., $\Delta g = 0.001$ (0.1%) in eq. (6.6). For the map-making equation, we chose 2×2 type that is shown in eq. (6.13). The input CMB maps (I , Q and U), estimated CMB maps (\hat{Q} and \hat{U}), and residual maps (ΔQ and ΔU) given by the subtraction of the input map from the estimated map are shown in figure 6.1. Due to the differential gain systematics, we can see the pattern of temperature-to-polarization leakage, denoted as $T \rightarrow P$, in the residual map. The residual is dominated by the leakage, the structure of the map is given by the multiplication between the temperature anisotropy and ${}_2\tilde{h}$ (see figure C.1) so in the case that the real part and imaginary part of the ${}_2\tilde{h}$ are small, the leakage is suppressed.

The spherical harmonic expansion of the residual maps gives us the systematics power spectrum, i.e., ΔC_ℓ^{BB} which is shown in figure 6.3 (left) by the solid red line. The boosting where the high- ℓ region is made by the deconvolution of the beam's transfer function. The dashed blue line is given by the analytical estimation that is given by the following transfer function to describe $T \rightarrow B$ (temperature-to- B mode) leakage [19, 115]

$$\Delta C_\ell^{BB} = \frac{1}{2} C_\ell^{TT} \left\langle \left| {}_2\tilde{h} \right|^2 \right\rangle \Delta g^2, \quad (6.57)$$

where $\left\langle \left| {}_2\tilde{h} \right|^2 \right\rangle$ is the mean value of the ${}_2\tilde{h}$ over the sky. Since the red and blue line have a good agreement, the simulated result by the SBM is consistent with the analytical estimation. We estimated the bias on r i.e. Δr by using the likelihood function described in appendix A.3. A maximum multipole ℓ_{\max} for the likelihood function is set to $\ell_{\max} = 191$, and estimated $\Delta r = 0.0023$. The likelihood function that gives this result is shown in figure A.1. This value is larger than the *LiteBIRD* mission requirement for total error ($\delta r < 0.001$) and is nearly 1000 times larger than $\Delta r \simeq 10^{-6}$ — the error budget assigned to individual systematic effects in ref. [21], which is a difficult value to achieve for primordial B -mode observations.

To manage this huge systematic bias on r , we can consider the mitigation by the 3×3

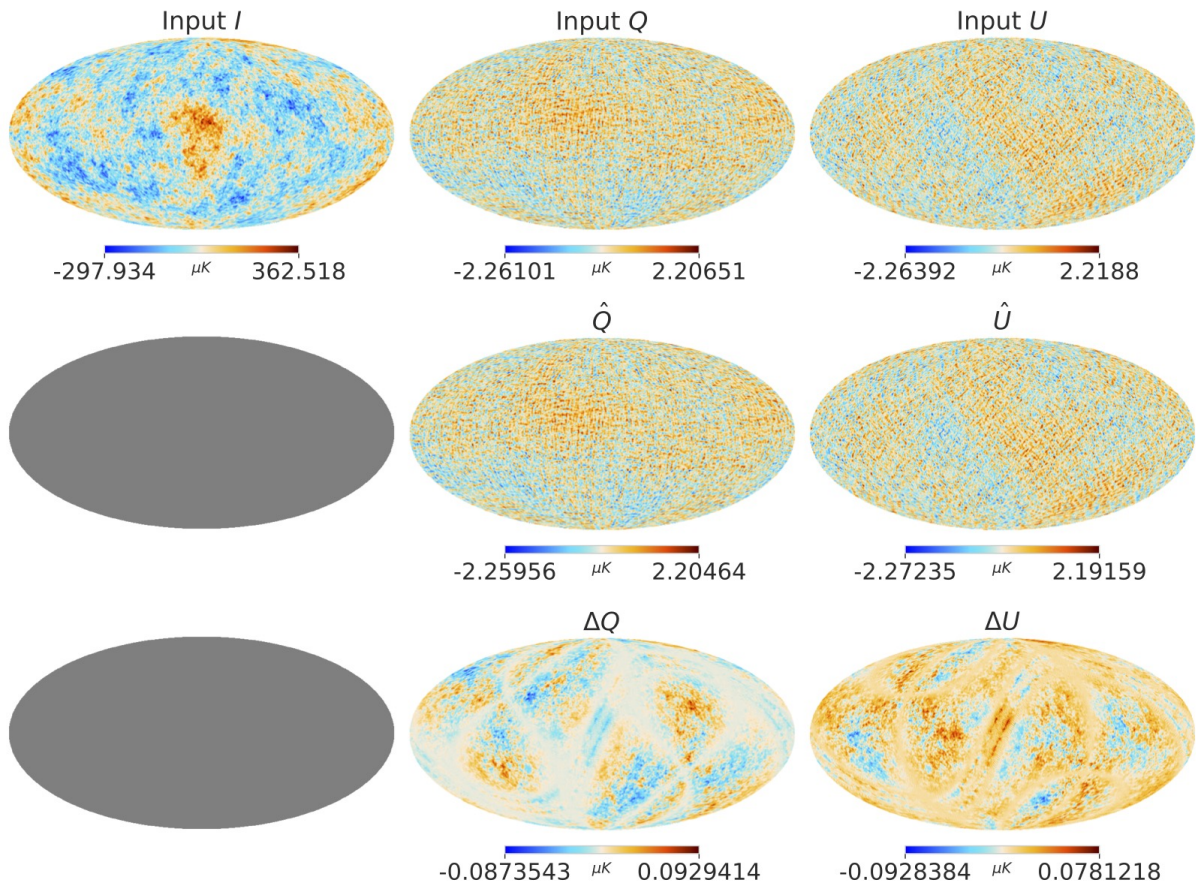

Figure 6.1: (top panels) Input CMB maps for I (left), Q (middle) and U (right). (middle panels) Estimated CMB maps for \hat{Q} (middle) and \hat{U} (right) with the 0.1% differential gain systematics. Due to the differential detection, we do not show the temperature map and its residual map as well. (bottom panels) Residual maps given by the subtraction between the input map and the estimated map ΔQ (middle) and ΔU (right). The leakage pattern is given by the structure of ${}_2\tilde{h}(\Omega)$ and temperature anisotropy.

matrix approach as

$$\begin{pmatrix} {}_0\hat{Z} \\ \hat{P} \\ \hat{P}^* \end{pmatrix} = {}_3M_g^{-1} \begin{pmatrix} {}_0\tilde{D}_g^d \\ \frac{1}{2}{}_2\tilde{D}_g^d \\ \frac{1}{2}{}_{-2}\tilde{D}_g^d \end{pmatrix}, \quad (6.58)$$

$${}_3M_g = \begin{pmatrix} 1 & \frac{1}{2}{}_2\tilde{h} & \frac{1}{2}{}_{-2}\tilde{h} \\ \frac{1}{2}{}_{-2}\tilde{h} & \frac{1}{4} & \frac{1}{4}{}_{-4}\tilde{h} \\ \frac{1}{2}{}_2\tilde{h} & \frac{1}{4}\tilde{h} & \frac{1}{4} \end{pmatrix}, \quad (6.59)$$

where ${}_0\hat{Z}$ represents the estimated systematic effect with *spin*-0 which corresponds to the $T \rightarrow B$ leakage due to the differential gain offset. Because we estimate the systematic effect, it no longer contaminates the polarization signal. Figure 6.2 shows the estimated CMB maps and the residual maps by the 3×3 map-making approach in eq. (6.59). The leakage pattern that we observed in figure 6.1 is vanished in the ΔQ and ΔU residual maps, instead, the leakage is absorbed into the ${}_0\hat{Z}$. Now, the remained systematics effect is only gain offset to the polarization

maps which just scales the magnitude of the maps without changing the pattern. It gives us the scaled C_ℓ^{BB} by the given offset as ΔC_ℓ^{BB} .

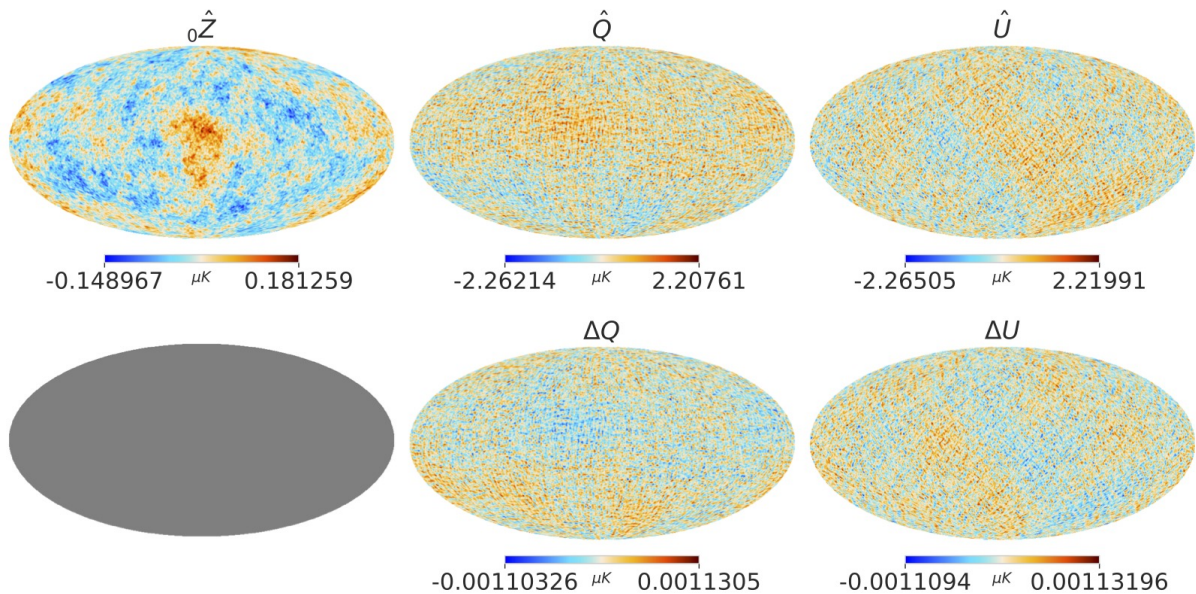

Figure 6.2: (top panels) Estimated systematics maps and CMB polarizations for \hat{Z} (left), \hat{Q} (middle) and \hat{U} by using 3×3 matrix map-making approach in eq. (6.59). (bottom panels) Residual maps, ΔQ (middle) and ΔU (right) due to the 0.1% differential gain systematics.

The systematic power spectrum is shown in figure 6.3 (left) in red solid line. The leakage is suppressed by the mitigation technique, and the systematic power spectrum is consistent with the analytical estimation which is given by the transfer function which is scaling C_ℓ^{BB} and make B mode-to- B mode leakage ($B \rightarrow B$)

$$\Delta C_\ell^{BB} = \frac{1}{4} C_\ell^{BB} \Delta g^2. \quad (6.60)$$

The temperature leakage is captured by the \hat{Z} and it is no longer depends on scanning strategy as the transfer function does not have cross-linking term. And estimated Δr is less than 10^{-6} .

6.4.2 Differential pointing

We assume that a single pair detectors-T/B has the pointing offset. We impose its systematics parameter $(\rho, \chi) = (1', 0')$ and obtained \hat{Q} , \hat{U} , ΔQ , and ΔU maps are shown in figure 6.4. These maps are simulated by the 2×2 map-making approach defined by eq. (6.13) and its systematic power spectrum is shown in figure 6.5 (left) in red. The blue dashed line shows the analytical estimation given by the transfer function as [19, 115] to describe the $T \rightarrow P$ leakage

$$\Delta C_\ell^{BB} = \frac{1}{8} \left(\left\langle \left| \tilde{h}_1 \right|^2 \right\rangle + \left\langle \left| \tilde{h}_3 \right|^2 \right\rangle \right) C_\ell^{TT} \rho^2 \ell^2. \quad (6.61)$$

We estimate Δr by the same way with the differential gain case, then we obtain $\Delta r = 2.35$ which is quite huge value.

As we mitigated differential gain systematics by expanding a dimension of the map-making

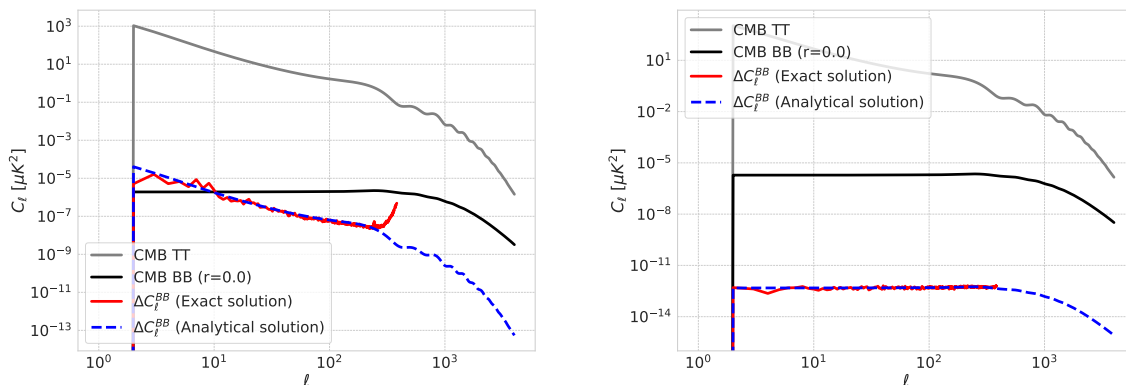

Figure 6.3: Systematic power spectra due to the 0.1% differential gain systematics. (left) ΔC_ℓ^{BB} by the 2×2 matrix map-making approach (eq. (6.13)). The red solid line is the systematic power spectrum given by SBM, and the blue dashed line is the analytical estimation given by eq. (6.60). The boosting in high- ℓ region is due to the deconvolution of the beam's transfer function. (middle) ΔC_ℓ^{BB} by the 3×3 matrix map-making approach (eq. (6.58)). The red solid line is the systematic power spectrum, and the blue dashed line is the analytical estimation. The gray/black solid line show the fiducial C_ℓ^{TT} and C_ℓ^{TT} power spectrum of CMB, respectively.

linear system, we can consider to mitigate the differential pointing systematics as well. In order to capture temperature gradient-to-polarization leakage which is expected as a dominant term in eqs. (6.23) and (6.25), we use following map-maker

$$\begin{pmatrix} \hat{Z} \\ -\hat{Z} \\ \hat{P} \\ \hat{P}^* \end{pmatrix} = {}_4M_p^{-1} \begin{pmatrix} \frac{1}{2} \tilde{D}_p^d \\ \frac{1}{2} -1 \tilde{D}_p^d \\ \frac{1}{2} 2 \tilde{D}_p^d \\ \frac{1}{2} -2 \tilde{D}_p^d \end{pmatrix}, \quad (6.62)$$

$${}_4M_p = \begin{pmatrix} \frac{1}{4} & \frac{1}{2} -1 \tilde{h} & \frac{1}{2} 2 \tilde{h} & \frac{1}{2} -2 \tilde{h} \\ \frac{1}{2} 1 \tilde{h} & \frac{1}{4} & \frac{1}{4} 3 \tilde{h} & \frac{1}{4} -1 \tilde{h} \\ \frac{1}{2} -2 \tilde{h} & \frac{1}{4} -3 \tilde{h} & \frac{1}{4} & \frac{1}{4} -4 \tilde{h} \\ \frac{1}{2} 2 \tilde{h} & \frac{1}{4} 1 \tilde{h} & \frac{1}{4} 4 \tilde{h} & \frac{1}{4} \end{pmatrix}. \quad (6.63)$$

Figure 6.6 shows \hat{Q} and \hat{U} maps, systematic maps ${}_1\hat{Z}^Q$ and ${}_1\hat{Z}^U$, and residual maps ΔQ and ΔU by the 4×4 map-making approach. The leakage pattern is absorbed into the ${}_1\hat{Z}^Q$ and ${}_1\hat{Z}^U$, and the residual maps are free from the temperature gradient leakage. The systematics power spectrum obtained by eq. (6.62) is shown in figure 6.5 (middle). The blue dashed line is the analytical estimation by the transfer function as

$$\Delta C_\ell^{BB} = \frac{1}{4} \left(\left\langle \left| {}_1\tilde{h} \right|^2 \right\rangle + \left\langle \left| {}_3\tilde{h} \right|^2 \right\rangle \right) C_\ell^{EE} \rho^2 \ell^2. \quad (6.64)$$

Because we capture the systematic field originated by the temperature gradient, the systematic power spectrum is no longer depends on the temperature and switches E mode-to- B mode leakage ($E \rightarrow B$), as we can see in eq. (6.64). In this case, the Δr is estimated as $\Delta r = 2.8 \times 10^{-6}$.

Additionally, if we expand the dimension of the matrix to 6×6 to capture polarization

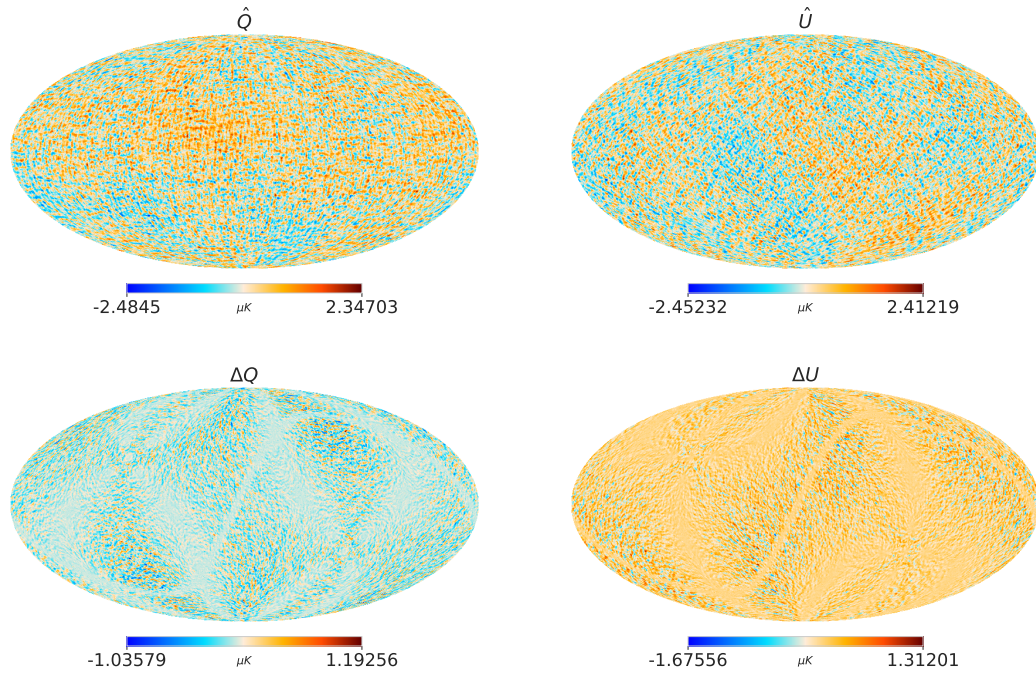

Figure 6.4: Estimated \hat{Q} and \hat{U} maps of CMB (top panels), residual maps ΔQ and ΔU due to the $1'$ differential pointing systematics (bottom panels) by the 2×2 matrix map-making approach.

gradient, we can mitigate all the systematics due to the differential pointing offset. The map-maker is given by

$$\begin{pmatrix} 1\hat{Z} \\ -1\hat{Z} \\ \hat{P} \\ \hat{P}^* \\ 3\hat{Z} \\ -3\hat{Z} \end{pmatrix} = {}_6M_p^{-1} \begin{pmatrix} \frac{1}{2}1\tilde{D}_p^d \\ \frac{1}{2}-1\tilde{D}_p^d \\ \frac{1}{2}2\tilde{D}_p^d \\ \frac{1}{2}-2\tilde{D}_p^d \\ \frac{1}{2}3\tilde{D}_p^d \\ \frac{1}{2}-3\tilde{D}_p^d \end{pmatrix}, \quad (6.65)$$

$${}_6M_p = \begin{pmatrix} \frac{1}{4} & \frac{1}{2}-1\tilde{h} & \frac{1}{2}2\tilde{h} & \frac{1}{2}-2\tilde{h} & \frac{1}{2}3\tilde{h} & \frac{1}{2}-3\tilde{h} \\ \frac{1}{2}1\tilde{h} & \frac{1}{4} & \frac{1}{4}3\tilde{h} & \frac{1}{4}-1\tilde{h} & \frac{1}{4}4\tilde{h} & \frac{1}{4}-2\tilde{h} \\ \frac{1}{2}-2\tilde{h} & \frac{1}{4}-3\tilde{h} & \frac{1}{4} & \frac{1}{4}-4\tilde{h} & \frac{1}{4}1\tilde{h} & \frac{1}{4}-5\tilde{h} \\ \frac{1}{2}2\tilde{h} & \frac{1}{4}1\tilde{h} & \frac{1}{4}4\tilde{h} & \frac{1}{4} & \frac{1}{4}5\tilde{h} & \frac{1}{4}-1\tilde{h} \\ \frac{1}{2}-3\tilde{h} & \frac{1}{4}-4\tilde{h} & \frac{1}{4}-1\tilde{h} & \frac{1}{4}-5\tilde{h} & \frac{1}{4} & \frac{1}{4}-6\tilde{h} \\ \frac{1}{2}3\tilde{h} & \frac{1}{4}2\tilde{h} & \frac{1}{4}5\tilde{h} & \frac{1}{4}1\tilde{h} & \frac{1}{4}6\tilde{h} & \frac{1}{4} \end{pmatrix}. \quad (6.66)$$

Figure 6.7 shows the estimated CMB polarization maps and systematic maps which is captured by the 6×6 matrix map-making approach. The residual maps are totally free from the systematic effects, and the systematic power spectrum is shown in figure 6.5 (right) by red solid line, though since no systematics is remained in the maps, so the systematic power spectrum is given by the only computational noise.

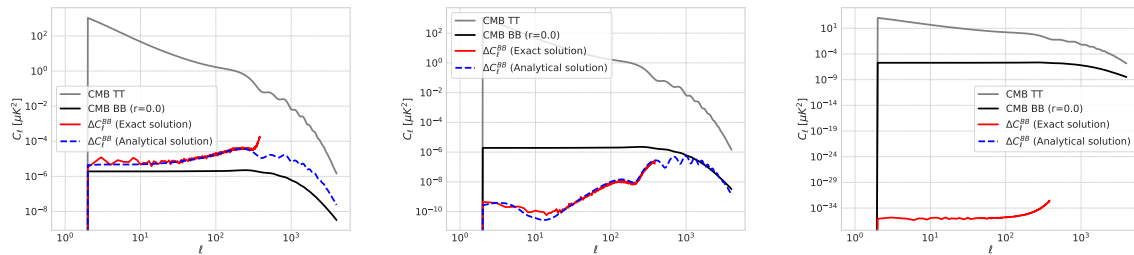

Figure 6.5: Systematic power spectra due to the $1'$ differential pointing systematics. (left) The red solid line is the systematic power spectrum by the 2×2 matrix map-making approach (eq. (6.13)). The blue dashed line is the analytical estimation given by eq. (6.61). (middle) The red solid line is the systematic power spectrum by the 4×4 matrix map-making approach (eq. (6.62)). The blue dashed line is the analytical estimation given by eq. (6.64). The gray/black solid line show the fiducial CMB TT/BB power spectrum, respectively. (right) The red solid line is the systematic power spectrum by the 6×6 matrix map-making approach (eq. (6.62)). The approach can fully mitigate differential systematics, so the systematic power spectrum is given by only the computational noise.

6.4.3 Absolute pointing offset

Now we start to discuss the systematic effect with HWP case. We assume that the pointing systematics parameter $(\rho, \chi) = (1', 0')$ as we set in section 5.5.5. Figure 6.8 shows the estimated CMB maps and residual maps by the 3×3 matrix map-making approach shown in eq. (4.24), we reintroduce it here for the notation that we are using and reader's convenience:

$$\begin{pmatrix} \hat{I} \\ \hat{P} \\ \hat{P}^* \end{pmatrix} = {}_3\tilde{M}_{\text{ap}}^{-1} \begin{pmatrix} 0,0\tilde{S}_{\text{ap}}^d \\ \frac{1}{2}2,-4\tilde{S}_{\text{ap}}^d \\ \frac{1}{2}-2,4\tilde{S}_{\text{ap}}^d \end{pmatrix}, \quad (6.67)$$

where ${}_3\tilde{M}_{\text{ap}}$ is given by

$${}_3\tilde{M}_{\text{ap}} = \begin{pmatrix} 1 & \frac{1}{2}-2,4\tilde{h} & \frac{1}{2}2,-4\tilde{h} \\ \frac{1}{2}2,-4\tilde{h} & \frac{1}{4} & \frac{1}{4}4,-8\tilde{h} \\ \frac{1}{2}-2,4\tilde{h} & \frac{1}{4}-4,8\tilde{h} & \frac{1}{4} \end{pmatrix}. \quad (6.68)$$

Even without implementing mitigation techniques, the residual from absolute pointing offset with HWP shows smaller contamination compared to differential pointing without HWP (figure 6.4). The HWP contributes to systematic mitigation through two distinct mechanisms.

First, it reduces systematic contamination through the multiplication of smaller cross-linking terms. In both differential and absolute pointing cases, the dominant systematic effect stems from temperature gradient-to-polarization leakage, corresponding to $\pm_{1,0}\tilde{S}_{\text{ap}}$ (or $\pm_{1}\tilde{S}_{\text{p}}$) in eqs. (6.23) and (6.31). For absolute pointing offset with HWP, ${}_{1,0}\tilde{S}_{\text{ap}}$ couples with ${}_{1,-4}\tilde{h}$ (and ${}_{-1,0}\tilde{S}_{\text{ap}}$ with ${}_{3,-4}\tilde{h}$) as shown in eq. (6.36). In contrast, differential pointing without HWP couples ${}_{1}\tilde{S}_{\text{p}}$ with ${}_{1}\tilde{h}$ (and ${}_{-1}\tilde{S}_{\text{p}}$ with ${}_{3}\tilde{h}$) as in eq. (6.36). Since *spin*-(n, m) cross-linking terms with $m > 0$ are inherently smaller than *spin*-($n, 0$) terms, the temperature gradient leakage experiences greater suppression in the HWP-enabled case. Second, HWP rotation enhances the

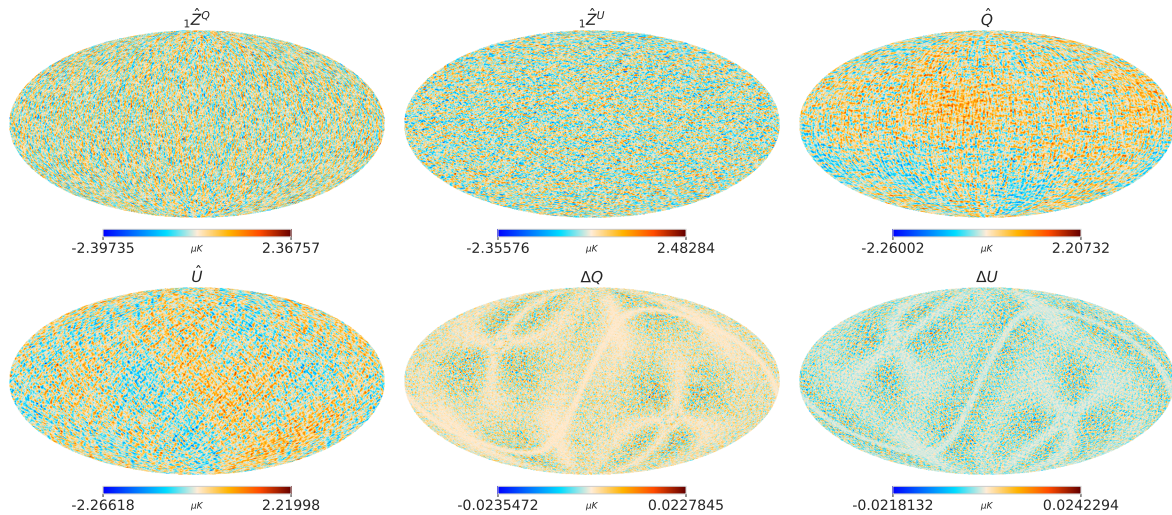

Figure 6.6: Estimated CMB maps and residual maps due to the $1'$ differential pointing systematics by the 4×4 matrix map-making approach. It displays ${}_1\hat{Z}^Q$, ${}_1\hat{Z}^U$, \hat{Q} , \hat{U} , ΔQ and ΔU from top left to bottom right.

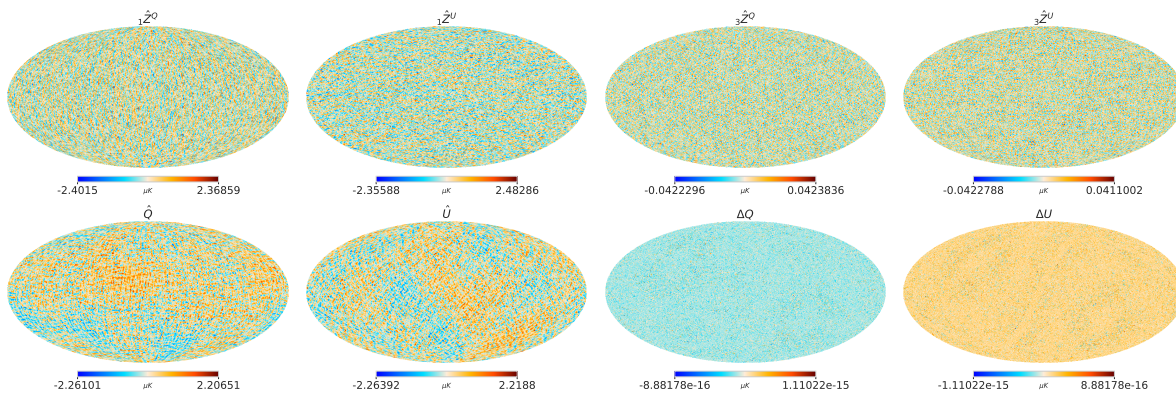

Figure 6.7: Estimated CMB maps and residual maps due to the $1'$ differential pointing systematics by the 6×6 matrix map-making approach. It displays ${}_1\hat{Z}^Q$, ${}_1\hat{Z}^U$, ${}_3\hat{Z}^Q$, ${}_3\hat{Z}^U$, \hat{Q} , \hat{U} , ΔQ and ΔU from top left to bottom right.

diagonalization of the covariance matrix in the map-making equation. The reduced cross-linking terms lead to a more diagonalized covariance matrix, minimizing the mixing between Stokes parameters during the map-making process.

The systematic power spectrum derived from 3×3 map-making approach is presented in figure 6.9 (left, blue solid line). In contrast to previous scenarios where analytical estimations of systematic power spectra were feasible through ensemble-averaged CMB power spectra, the incorporation of HWP adds complexity via its *spin* moment. While it may be feasible to develop a transfer function mapping signal fields to systematic power spectra by extending the framework of ref. [20] to incorporate HWP contributions, we reserve this analytical development for future investigation.

Nevertheless, our map-based simulation methodology efficiently generates residual maps and

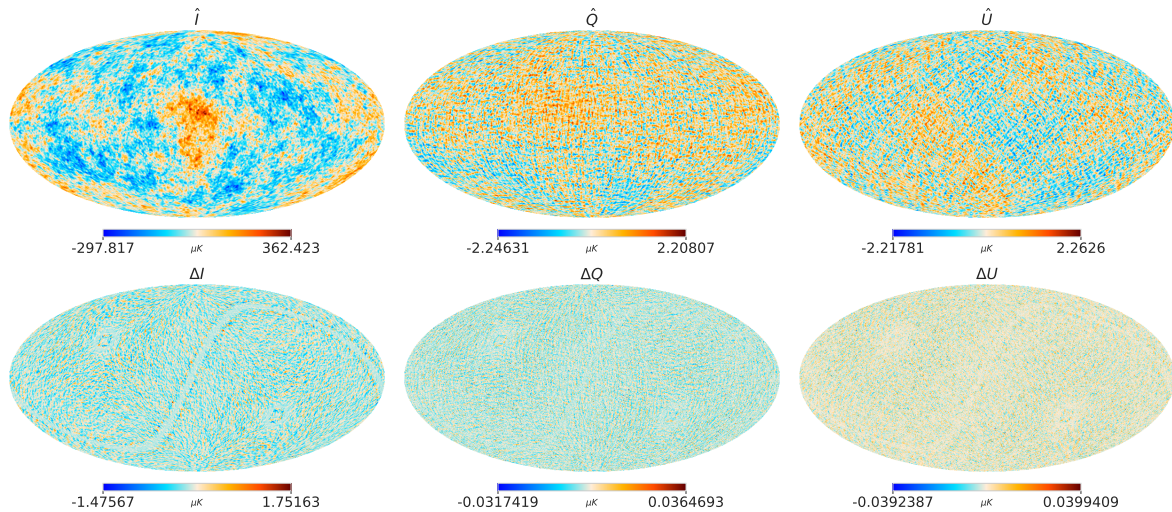

Figure 6.8: Estimated CMB maps and residual maps due to the absolute pointing offset with HWP, $(\rho, \chi) = (1', 0')$ by the 3×3 matrix map-making approach with HWP. It displays \hat{I} , \hat{Q} , \hat{U} , ΔI , ΔQ , and ΔU from top left to bottom right.

corresponding systematic power spectra through rapid CMB realizations.² Moreover, this approach surpasses analytical power spectrum estimation by producing output maps that include systematic effects, enabling both pixel-space component separation and analysis of systematic-foreground interactions. Even under use of HWP, we can further improve systematic mitigation by expanding the map-making matrix to 5×5 and 9×9 dimensions. The 5×5 matrix map-making approach is defined by

$$\begin{pmatrix} \hat{I} \\ 1,0\hat{Z} \\ -1,0\hat{Z} \\ \hat{P} \\ \hat{P}^* \end{pmatrix} = {}_5\tilde{M}_{\text{ap}}^{-1} \begin{pmatrix} 0,0\tilde{S}_{\text{ap}}^d \\ 1,0\tilde{S}_{\text{ap}}^d \\ -1,0\tilde{S}_{\text{ap}}^d \\ 2,-4\tilde{S}_{\text{ap}}^d \\ -2,4\tilde{S}_{\text{ap}}^d \end{pmatrix}, \quad (6.69)$$

where ${}_5\tilde{M}_{\text{ap}}$ is given by

$${}_5\tilde{M}_{\text{ap}} = \begin{pmatrix} 1 & \frac{1}{2}-1,0\tilde{h} & \frac{1}{2}1,0\tilde{h} & \frac{1}{2}-2,4\tilde{h} & \frac{1}{2}2,-4\tilde{h} \\ \frac{1}{2}1,0\tilde{h} & \frac{1}{4} & \frac{1}{4}2,0\tilde{h} & \frac{1}{4}-1,4\tilde{h} & \frac{1}{4}3,-4\tilde{h} \\ \frac{1}{2}-1,0\tilde{h} & \frac{1}{4}-2,0\tilde{h} & \frac{1}{4} & \frac{1}{4}-3,4\tilde{h} & \frac{1}{4}1,-4\tilde{h} \\ \frac{1}{2}2,-4\tilde{h} & \frac{1}{4}1,-4\tilde{h} & \frac{1}{4}3,-4\tilde{h} & \frac{1}{4} & \frac{1}{4}4,-8\tilde{h} \\ \frac{1}{2}-2,4\tilde{h} & \frac{1}{4}-3,4\tilde{h} & \frac{1}{4}-1,4\tilde{h} & \frac{1}{4}-4,8\tilde{h} & \frac{1}{4} \end{pmatrix}, \quad (6.70)$$

²A CMB realization involves generating a CMB map by randomizing the phase of CMB spherical harmonic coefficients $a_{\ell m}$ and computing the ensemble average of the resulting power spectrum to eliminate cosmic variance.

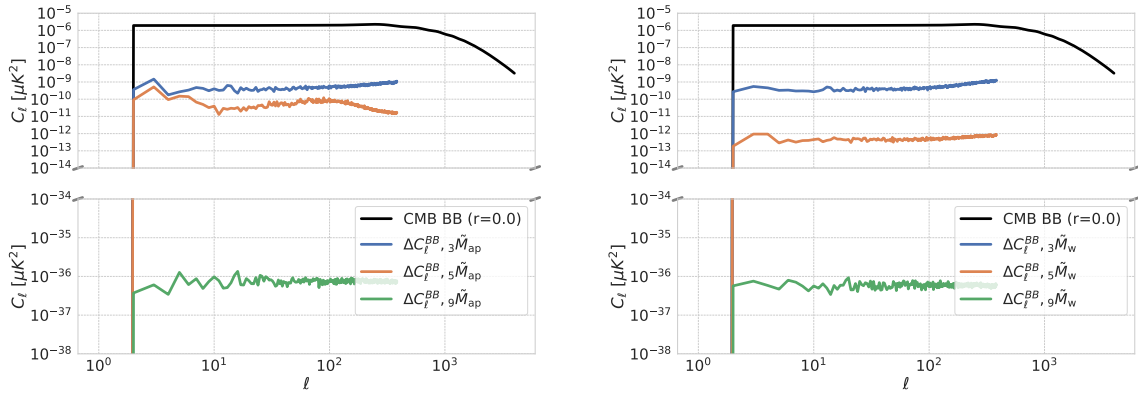

Figure 6.9: (left) Power spectrum of systematic effects arising from absolute pointing offset with HWP, parameterized by $(\rho, \chi) = (1', 0')$. Results are shown for three map-making approaches: 3×3 using ${}_3\tilde{M}_{\text{ap}}$ (blue), 5×5 using ${}_5\tilde{M}_{\text{ap}}$ (orange), and 9×9 using ${}_9\tilde{M}_{\text{ap}}$ (green, achieving full mitigation). (right) Power spectrum of systematic effects from HWP-induced circular pointing disturbance, characterized by pointing perturbation angle $\xi = 1'$ and HWP phase $\chi = 0'$. Results shown for identical map-making approaches as the left panel. The fiducial CMB B -mode power spectrum is overlaid in black.

and the 9×9 matrix map-making approach is defined by

$$\begin{pmatrix} \hat{I} \\ 1,0\hat{Z} \\ -1,0\hat{Z} \\ \hat{P} \\ \hat{P}^* \\ 3,-4\hat{Z} \\ -3,4\hat{Z} \\ 1,-4\hat{Z} \\ -1,4\hat{Z} \end{pmatrix} = {}_9\tilde{M}_{\text{ap}}^{-1} \begin{pmatrix} 0,0\tilde{S}_{\text{ap}}^d \\ 1,0\tilde{S}_{\text{ap}}^d \\ -1,0\tilde{S}_{\text{ap}}^d \\ 2,-4\tilde{S}_{\text{ap}}^d \\ -2,4\tilde{S}_{\text{ap}}^d \\ 3,-4\tilde{S}_{\text{ap}}^d \\ -3,4\tilde{S}_{\text{ap}}^d \\ 1,-4\tilde{S}_{\text{ap}}^d \\ -1,4\tilde{S}_{\text{ap}}^d \end{pmatrix}, \quad (6.71)$$

where ${}_9\tilde{M}_{\text{ap}}$ is given by

$${}_9\tilde{M}_{\text{ap}} = \begin{pmatrix} 1 & \frac{1}{2}-1,0\tilde{h} & \frac{1}{2}1,0\tilde{h} & \frac{1}{2}-2,4\tilde{h} & \frac{1}{2}2,-4\tilde{h} & \frac{1}{2}-3,4\tilde{h} & \frac{1}{2}3,-4\tilde{h} & \frac{1}{2}-1,4\tilde{h} & \frac{1}{2}1,-4\tilde{h} \\ \frac{1}{2}1,0\tilde{h} & \frac{1}{4} & \frac{1}{4}2,0\tilde{h} & \frac{1}{4}-1,4\tilde{h} & \frac{1}{4}3,-4\tilde{h} & \frac{1}{4}-2,4\tilde{h} & \frac{1}{4}4,-4\tilde{h} & \frac{1}{4}0,4\tilde{h} & \frac{1}{4}2,-4\tilde{h} \\ \frac{1}{2}-1,0\tilde{h} & \frac{1}{4}-2,0\tilde{h} & \frac{1}{4} & \frac{1}{4}-3,4\tilde{h} & \frac{1}{4}1,-4\tilde{h} & \frac{1}{4}-4,4\tilde{h} & \frac{1}{4}2,-4\tilde{h} & \frac{1}{4}-2,4\tilde{h} & \frac{1}{4}0,-4\tilde{h} \\ \frac{1}{2}2,-4\tilde{h} & \frac{1}{4}1,-4\tilde{h} & \frac{1}{4}3,-4\tilde{h} & \frac{1}{4} & \frac{1}{4}4,-8\tilde{h} & \frac{1}{4}-1,0\tilde{h} & \frac{1}{4}5,-8\tilde{h} & \frac{1}{4}1,0\tilde{h} & \frac{1}{4}3,-8\tilde{h} \\ \frac{1}{2}-2,4\tilde{h} & \frac{1}{4}-3,4\tilde{h} & \frac{1}{4}-1,4\tilde{h} & \frac{1}{4}-4,8\tilde{h} & \frac{1}{4} & \frac{1}{4}-5,8\tilde{h} & \frac{1}{4}1,0\tilde{h} & \frac{1}{4}-3,8\tilde{h} & \frac{1}{4}-1,0\tilde{h} \\ \frac{1}{2}3,-4\tilde{h} & \frac{1}{4}2,-4\tilde{h} & \frac{1}{4}4,-4\tilde{h} & \frac{1}{4}1,0\tilde{h} & \frac{1}{4}5,-8\tilde{h} & \frac{1}{4} & \frac{1}{4}6,-8\tilde{h} & \frac{1}{4}2,0\tilde{h} & \frac{1}{4}4,-8\tilde{h} \\ \frac{1}{2}-3,4\tilde{h} & \frac{1}{4}-4,4\tilde{h} & \frac{1}{4}-2,4\tilde{h} & \frac{1}{4}-5,8\tilde{h} & \frac{1}{4}-1,0\tilde{h} & \frac{1}{4}-6,8\tilde{h} & \frac{1}{4} & \frac{1}{4}-4,8\tilde{h} & \frac{1}{4}-2,0\tilde{h} \\ \frac{1}{2}1,-4\tilde{h} & \frac{1}{4}0,-4\tilde{h} & \frac{1}{4}2,-4\tilde{h} & \frac{1}{4}-1,0\tilde{h} & \frac{1}{4}3,-8\tilde{h} & \frac{1}{4}-2,0\tilde{h} & \frac{1}{4}4,-8\tilde{h} & \frac{1}{4} & \frac{1}{4}2,-8\tilde{h} \\ \frac{1}{2}-1,4\tilde{h} & \frac{1}{4}-2,4\tilde{h} & \frac{1}{4}0,4\tilde{h} & \frac{1}{4}-3,8\tilde{h} & \frac{1}{4}1,0\tilde{h} & \frac{1}{4}-4,8\tilde{h} & \frac{1}{4}2,0\tilde{h} & \frac{1}{4}-2,8\tilde{h} & \frac{1}{4} \end{pmatrix}. \quad (6.72)$$

Figures 6.10 and 6.11 present the estimated CMB and residual maps derived from the 5×5 and

9×9 matrix map-making approaches defined in eqs. (6.70) and (6.72), respectively. The 5×5 approach effectively isolates the temperature gradient-to-polarization leakage, with the resulting temperature gradient maps displayed in the top panels of figure 6.10. This isolation successfully removes temperature leakage from the residual maps. The corresponding systematic power spectrum, shown in figure 6.9 (left, orange solid line), exhibits a non-flat structure characteristic of CMB E -mode polarization, though its amplitude remains suppressed through cross-linking. The 9×9 approach achieves complete mitigation of systematic effects arising from absolute

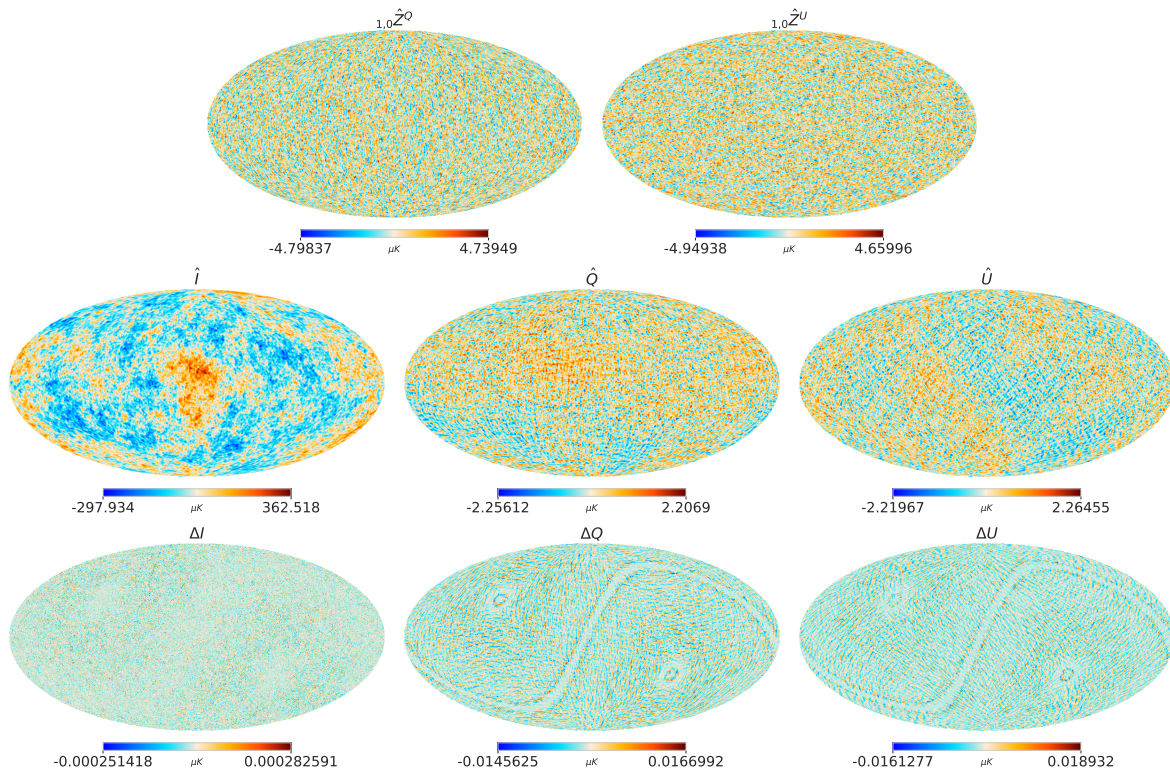

Figure 6.10: Estimated CMB maps and residual maps due to the absolute pointing offset, $(\rho, \chi) = (1', 0')$ by the 5×5 matrix map-making approach with HWP. Top panels show ${}_{1,0}\hat{Z}^Q$ and ${}_{1,0}\hat{Z}^U$, middle panels show \hat{I} , \hat{Q} , and \hat{U} , and bottom panels show ΔI , ΔQ , and ΔU from left to right.

pointing offset, as evidenced by the residual maps shown in the bottom panels of figure 6.11. This comprehensive approach enables detailed examination of all systematic field components, including temperature-gradient fields ($\pm_{1,0}\hat{Z}$) and polarization-gradient fields ($\pm_{1,\mp 4}\hat{Z}$, $\pm_{3,\mp 4}\hat{Z}$), providing valuable insights into the magnitude of spurious signals generated by systematic effects associated with specific *spin* moments.

Analysis of the tensor-to-scalar ratio bias yielded $\Delta r < 10^{-6}$ for all scenarios driven by the matrices we used with the absolute pointing offset parameters $(\rho, \chi) = (1', 0')$.

6.4.4 Pointing disturbance due to HWP rotation

The pointing systematic effects arising from the HWP wedge angle exhibit characteristics analogous to those observed in the absolute pointing offset scenario. We impose the systematic parameters $(\xi, \chi) = (1', 0')$ which describes the pointing perturbation due to the HWP wedge

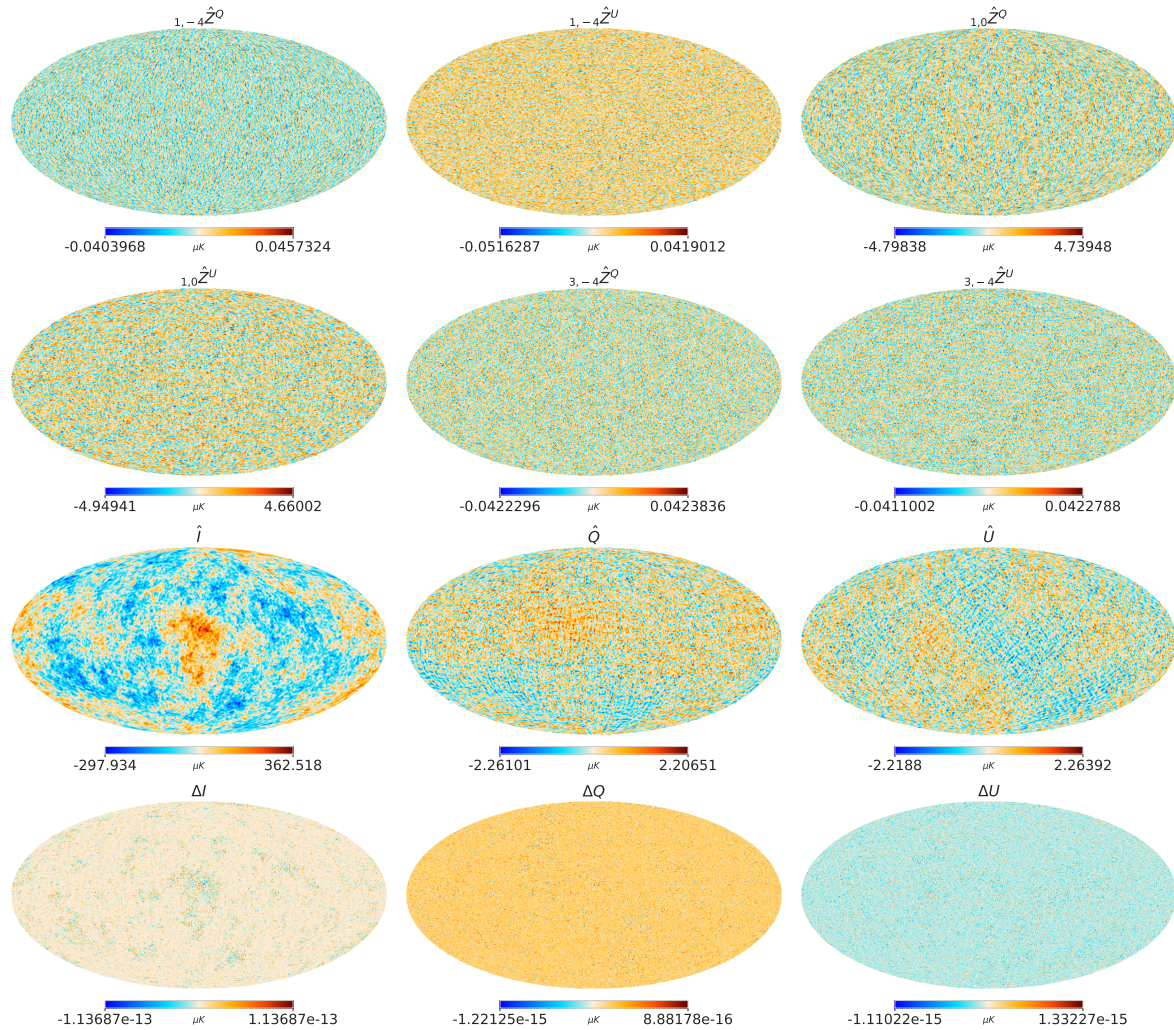

Figure 6.11: Estimated CMB maps and residual maps due to the absolute pointing offset, $(\rho, \chi) = (1', 0')$ by the 9×9 matrix map-making approach with HWP. Top panel shows ${}_{1,-4}\hat{Z}^Q$, ${}_{1,-4}\hat{Z}^U$, and ${}_{1,0}\hat{Z}^Q$; second panel shows ${}_{1,0}\hat{Z}^U$, ${}_{3,-4}\hat{Z}^Q$, and ${}_{3,-4}\hat{Z}^U$; and third panel shows \hat{I} , \hat{Q} and \hat{U} ; and bottom panel shows ΔI , ΔQ , and ΔU from left to right.

angle and HWP phase, respectively. Figure 6.12 illustrates the estimated CMB maps and corresponding residual maps generated through the 3×3 matrix map-making framework outlined in eq. (6.68).

Although the systematic field differs from the absolute pointing offset case, we can employ the same 3×3 map-maker, as the underlying mathematical framework remains consistent. Comparing the residual maps (ΔQ and ΔU) between the absolute offset of the pointing (figure 6.8) and the HWP wedge effect reveals remarkably similar magnitudes and structures, which aligns with our expectations given that the HWP rotation effectively minimizes cross-linking in both cases.

In particular, while the temperature residual (ΔI) does not directly contribute to systematic contamination of the B mode, the HWP wedge effect exhibits smaller temperature residuals compared to the absolute pointing offset. This phenomenon arises from the different coupling mechanisms: in the wedge effect of the HWP, the temperature gradient fields ${}_{\mp 1, \mp 1}\tilde{S}$ are coupled

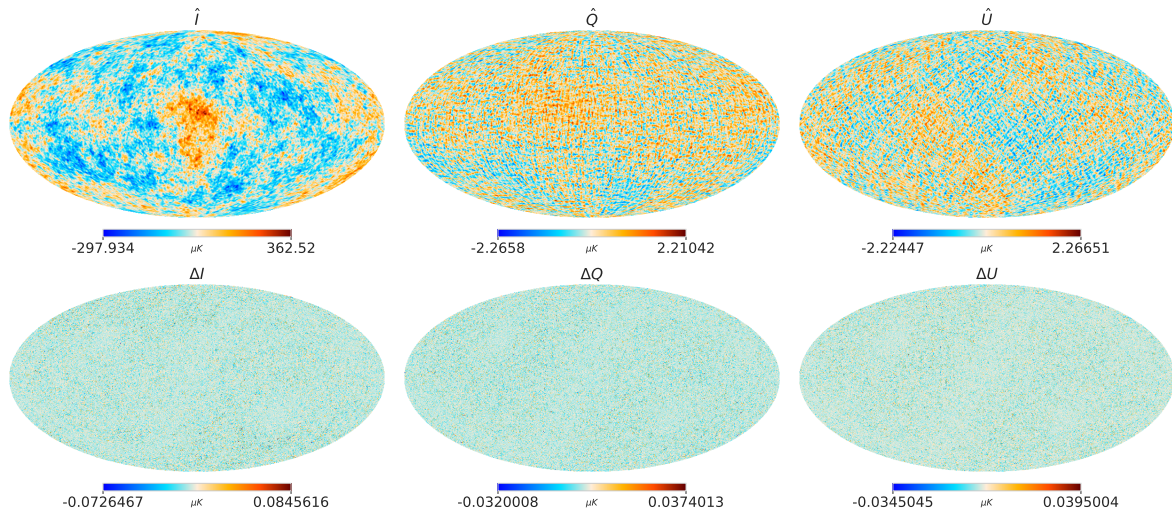

Figure 6.12: Estimated CMB maps and residual maps due to the HWP wedge effect by the 3×3 matrix map-making approach with HWP. It displays \hat{I} , \hat{Q} , \hat{U} , ΔI , ΔQ , and ΔU from top left to bottom right. The imposed systematic parameter is $(\xi, \chi) = (1', 0')$

with $\pm_{1,\pm 1}\tilde{h}$ without the contribution of the HWP (eq. (6.43)), whereas the absolute pointing offset involves the coupling between $\mp_{1,0}\tilde{S}$ and $\pm_{1,0}\tilde{h}$ (eq. (6.34)). The HWP rotation in the wedge effect effectively averages signals around sky pixels, resulting in reduced temperature residuals.

The systematic power spectra originating from the HWP wedge effect are presented in figure 6.9 (right). The solid blue line depicts the spectrum derived from the 3×3 matrix map-making approach, where the systematic effect manifests itself primarily as leakage $T \rightarrow B$, analogous to the case of absolute pointing offset. The comparable magnitudes of residual maps in both cases naturally lead to similar levels in their systematic power spectra.

Figure 6.13 presents the estimated CMB maps and residual maps generated using the 5×5 matrix map-making approach defined by

$$\begin{pmatrix} \hat{I} \\ {}_{1,1}\hat{Z} \\ {}_{-1,-1}\hat{Z} \\ \hat{P} \\ \hat{P}^* \end{pmatrix} = {}_5\tilde{M}_w^{-1} \begin{pmatrix} 0,0\tilde{S}_w^d \\ {}_{1,1}\tilde{S}_w^d \\ {}_{-1,-1}\tilde{S}_w^d \\ {}_{2,-4}\tilde{S}_w^d \\ {}_{-2,4}\tilde{S}_w^d \end{pmatrix}, \quad (6.73)$$

where ${}_5\tilde{M}_w$ is given by

$${}_5\tilde{M}_w = \begin{pmatrix} 1 & \frac{1}{2}{}_{-1,-1}\tilde{h} & \frac{1}{2}{}_{1,1}\tilde{h} & \frac{1}{2}{}_{-2,4}\tilde{h} & \frac{1}{2}{}_{2,-4}\tilde{h} \\ \frac{1}{2}{}_{1,1}\tilde{h} & \frac{1}{4} & \frac{1}{4}{}_{2,2}\tilde{h} & \frac{1}{4}{}_{-1,5}\tilde{h} & \frac{1}{4}{}_{3,-3}\tilde{h} \\ \frac{1}{2}{}_{-1,-1}\tilde{h} & \frac{1}{4}{}_{-2,-2}\tilde{h} & \frac{1}{4} & \frac{1}{4}{}_{-3,3}\tilde{h} & \frac{1}{4}{}_{1,-5}\tilde{h} \\ \frac{1}{2}{}_{2,-4}\tilde{h} & \frac{1}{4}{}_{1,-5}\tilde{h} & \frac{1}{4}{}_{3,-3}\tilde{h} & \frac{1}{4} & \frac{1}{4}{}_{4,-8}\tilde{h} \\ \frac{1}{2}{}_{-2,4}\tilde{h} & \frac{1}{4}{}_{-3,3}\tilde{h} & \frac{1}{4}{}_{-1,5}\tilde{h} & \frac{1}{4}{}_{-4,8}\tilde{h} & \frac{1}{4} \end{pmatrix}. \quad (6.74)$$

This enhanced approach successfully isolates the temperature leakage, transforming the domi-

nant systematic effect from $T \rightarrow B$ to predominantly $E \rightarrow B$ leakage.

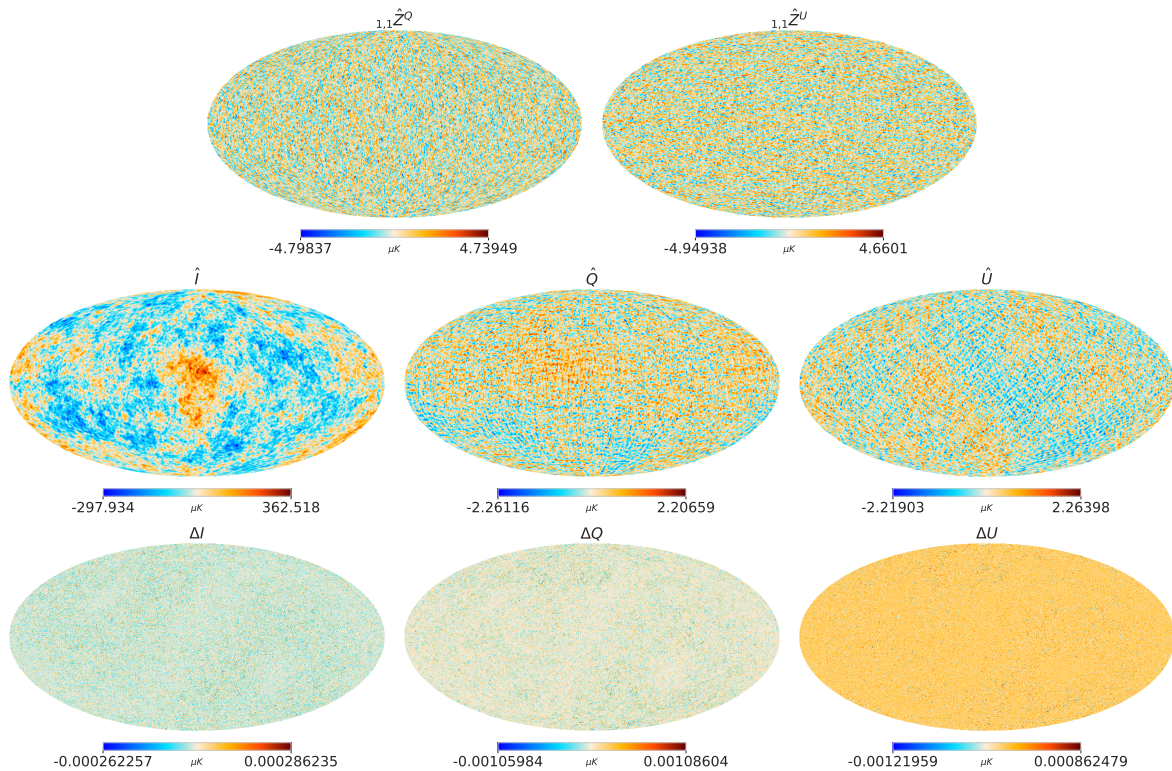

Figure 6.13: Estimated CMB maps and residual maps due to the HWP wedge effect by the 5×5 matrix map-making approach with HWP. It displays ${}_{1,1}\hat{Z}^Q$, ${}_{1,1}\hat{Z}^U$, \hat{I} , \hat{Q} , \hat{U} , ΔI , ΔQ , and ΔU from top left to bottom right. The systematics parameter for the HWP wedge is same as the previous 3×3 matrix map-making approach case. The imposed systematics parameter is $(\xi, \chi) = (1', 0')$.

The systematic power spectrum obtained through the 5×5 matrix map-making approach is depicted by the orange solid line in figure 6.9 (right). Notably, the ΔC_ℓ^{BB} exhibits a completely flat structure, contrasting with the results from the 5×5 matrix approach applied to absolute pointing offset. This distinction arises from the fundamental differences in their coupling mechanisms between the systematic fields and cross-link maps. In the absolute pointing offset scenario, when $n_0\tilde{h}$ couples with the polarization gradient without HWP contribution (see eq. (6.36)), the structural integrity of the $n_0\tilde{h}$ map (illustrated in figure C.1) persists, facilitating phase-coherent leakage from E -mode to B -mode polarization.

Conversely, the HWP wedge effect demonstrates no $m = 0$ cross-links in eq. (6.45), indicating that all systematic effect components are suppressed by $n_{,m}\tilde{h}$ ($m \neq 0$) through HWP contribution. These cross-link maps exhibit highly flat structures due to HWP rotation (as shown in figure C.2), manifesting as a flat angular power spectrum. When convolved with any sky signal, regardless of its intrinsic angular structure, this randomization process effectively smooths out spatial correlations, yielding a flat angular power spectrum. This mechanism parallels the E mode to B mode conversion induced by gravitational lensing (discussed in section 2.5.3): while absolute offset produces phase-coherent $E \rightarrow B$ leakage, the HWP wedge effect smooth out its phase information.

Figure 6.14 presents the CMB maps and residual maps estimated through the 9×9 matrix map-making approach defined by:

$$\begin{pmatrix} \hat{I} \\ 1,1\hat{Z} \\ -1,-1\hat{Z} \\ \hat{P} \\ \hat{P}^* \\ 3,-3\hat{Z} \\ -3,3\hat{Z} \\ 1,-5\hat{Z} \\ -1,5\hat{Z} \end{pmatrix} = {}_9\tilde{M}_w^{-1} \begin{pmatrix} 0,0\tilde{S}_w^d \\ 1,1\tilde{S}_w^d \\ -1,-1\tilde{S}_w^d \\ 2,-4\tilde{S}_w^d \\ -2,4\tilde{S}_w^d \\ 3,-3\tilde{S}_w^d \\ -3,3\tilde{S}_w^d \\ 1,-5\tilde{S}_w^d \\ -1,5\tilde{S}_w^d \end{pmatrix}, \quad (6.75)$$

where ${}_9\tilde{M}_w$ is given by

$${}_9\tilde{M}_w = \begin{pmatrix} 1 & \frac{1}{2}-1,-1\tilde{h} & \frac{1}{2}1,1\tilde{h} & \frac{1}{2}-2,4\tilde{h} & \frac{1}{2}2,-4\tilde{h} & \frac{1}{2}-3,3\tilde{h} & \frac{1}{2}3,-3\tilde{h} & \frac{1}{2}-1,5\tilde{h} & \frac{1}{2}1,-5\tilde{h} \\ \frac{1}{2}1,1\tilde{h} & \frac{1}{4} & \frac{1}{4}2,2\tilde{h} & \frac{1}{4}-1,5\tilde{h} & \frac{1}{4}3,-3\tilde{h} & \frac{1}{4}-2,4\tilde{h} & \frac{1}{4}4,-2\tilde{h} & \frac{1}{4}0,6\tilde{h} & \frac{1}{4}2,-4\tilde{h} \\ \frac{1}{2}-1,-1\tilde{h} & \frac{1}{4}-2,-2\tilde{h} & \frac{1}{4} & \frac{1}{4}-3,3\tilde{h} & \frac{1}{4}1,-5\tilde{h} & \frac{1}{4}-4,2\tilde{h} & \frac{1}{4}2,-4\tilde{h} & \frac{1}{4}-2,4\tilde{h} & \frac{1}{4}0,-6\tilde{h} \\ \frac{1}{2}2,-4\tilde{h} & \frac{1}{4}1,-5\tilde{h} & \frac{1}{4}3,-3\tilde{h} & \frac{1}{4} & \frac{1}{4}4,-8\tilde{h} & \frac{1}{4}-1,-1\tilde{h} & \frac{1}{4}5,-7\tilde{h} & \frac{1}{4}1,1\tilde{h} & \frac{1}{4}3,-9\tilde{h} \\ \frac{1}{2}-2,4\tilde{h} & \frac{1}{4}-3,3\tilde{h} & \frac{1}{4}-1,5\tilde{h} & \frac{1}{4}-4,8\tilde{h} & \frac{1}{4} & \frac{1}{4}-5,7\tilde{h} & \frac{1}{4}1,1\tilde{h} & \frac{1}{4}-3,9\tilde{h} & \frac{1}{4}-1,-1\tilde{h} \\ \frac{1}{2}3,-3\tilde{h} & \frac{1}{4}2,-4\tilde{h} & \frac{1}{4}4,-2\tilde{h} & \frac{1}{4}1,1\tilde{h} & \frac{1}{4}5,-7\tilde{h} & \frac{1}{4} & \frac{1}{4}6,-6\tilde{h} & \frac{1}{4}2,2\tilde{h} & \frac{1}{4}4,-8\tilde{h} \\ \frac{1}{2}-3,3\tilde{h} & \frac{1}{4}-4,2\tilde{h} & \frac{1}{4}-2,4\tilde{h} & \frac{1}{4}-5,7\tilde{h} & \frac{1}{4}-1,-1\tilde{h} & \frac{1}{4}-6,6\tilde{h} & \frac{1}{4} & \frac{1}{4}-4,8\tilde{h} & \frac{1}{4}-2,-2\tilde{h} \\ \frac{1}{2}1,-5\tilde{h} & \frac{1}{4}0,-6\tilde{h} & \frac{1}{4}2,-4\tilde{h} & \frac{1}{4}-1,-1\tilde{h} & \frac{1}{4}3,-9\tilde{h} & \frac{1}{4}-2,-2\tilde{h} & \frac{1}{4}4,-8\tilde{h} & \frac{1}{4} & \frac{1}{4}2,-10\tilde{h} \\ \frac{1}{2}-1,5\tilde{h} & \frac{1}{4}-2,4\tilde{h} & \frac{1}{4}0,6\tilde{h} & \frac{1}{4}-3,9\tilde{h} & \frac{1}{4}1,1\tilde{h} & \frac{1}{4}-4,8\tilde{h} & \frac{1}{4}2,2\tilde{h} & \frac{1}{4}-2,10\tilde{h} & \frac{1}{4} \end{pmatrix}. \quad (6.76)$$

This approach successfully isolates both temperature gradient and polarization gradient, achieving complete mitigation of systematic effects. The resulting systematic power spectrum, shown as the green solid line in figure 6.9 (right), demonstrates full suppression of systematic contamination.

When analyzing the impact on the tensor-to-scalar ratio, we found $\Delta r < 10^{-6}$ across all scenarios with pointing offset disturbance parameters $(\xi, \chi) = (1', 0')$ induced by the HWP wedge angle.

6.4.5 Instrumental polarization due to HWP non-ideality

To evaluate this systematic effect, we modify the input map and analysis method. The systematic field is defined by the deviation signal, which includes only the systematic effect without the fiducial signal we aim to measure, as shown in eq. (6.46). As discussed in section 5.5.5, the primary source of this systematic effect is the solar dipole. Therefore, we define the input map as the sum of the CMB temperature anisotropies and the solar dipole map, excluding any polarization. This approach allows us to focus on the $T \rightarrow B$ leakage induced by the instrumental polarization due to HWP non-ideality. For the systematic parameters, we set $(\epsilon_1, \phi_{QI}) = (1.0 \times 10^{-5}, 0)$ as defined in section 5.5.5.

Figure 6.15 shows the input map and the residual maps derived from the 3×3 matrix map-

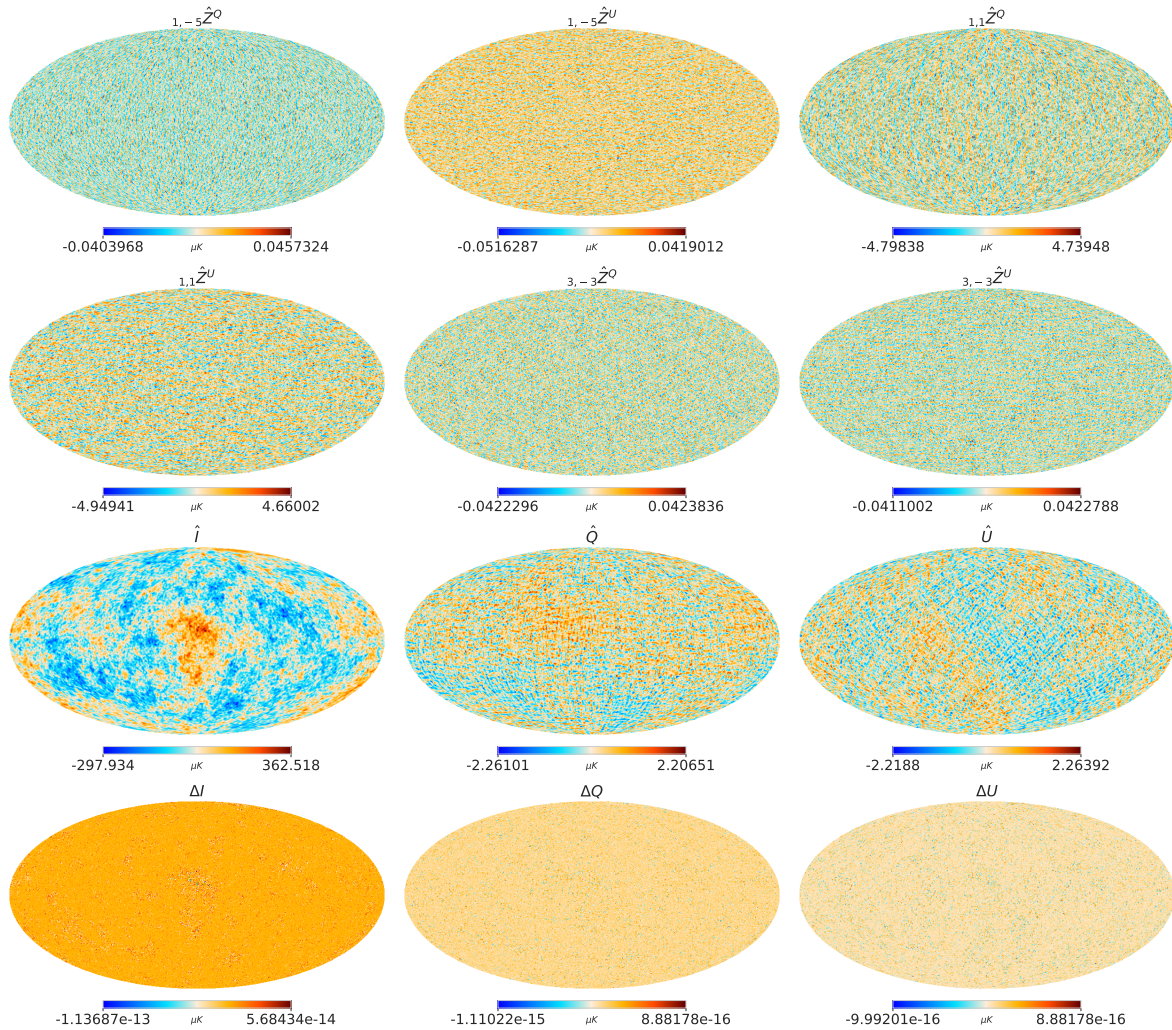

Figure 6.14: Esimated CMB maps and residual maps due to the HWP wedge effect by the 9×9 matrix map-making approach with HWP. It displays $1,-5\hat{Z}^Q$, $1,-5\hat{Z}^U$, $1,1\hat{Z}^Q$, $1,1\hat{Z}^U$, $3,-3\hat{Z}^Q$, $3,-3\hat{Z}^U$, \hat{I} , \hat{Q} , \hat{U} , ΔI , ΔQ , and ΔU from top left to bottom right. The systematics parameter for the HWP wedge is same as the previous 3×3 matrix map-making approach case.

making approach (defined by eq. (6.68)). In the residual maps, the temperature-to-polarization leakage pattern is clearly visible, created by the convolution between the solar dipole and $\pm_{2,0}\tilde{h}$ cross-link maps.

To effectively mitigate the systematic effect, we capture the leakage term using the following 5×5 map-making approach:

$$\begin{pmatrix} \hat{I} \\ \hat{P} \\ \hat{P}^* \\ 4,-4\hat{Z} \\ -4,4\hat{Z} \end{pmatrix} = {}_5\tilde{M}_{\text{ip}}^{-1} \begin{pmatrix} 0,0\tilde{S}_w^d \\ 2,-4\tilde{S}_w^d \\ -2,4\tilde{S}_w^d \\ 4,-4\tilde{S}_w^d \\ -4,4\tilde{S}_w^d \end{pmatrix}, \quad (6.77)$$

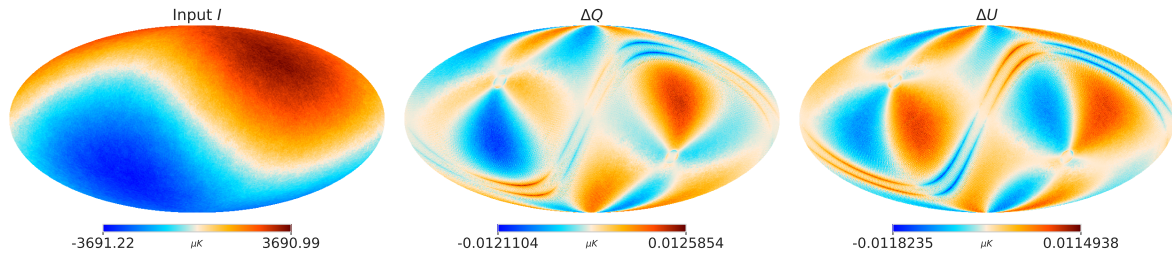

Figure 6.15: (left) Input map for instrumental polarization due to HWP non-ideality, comprising the sum of CMB temperature anisotropies and the solar dipole map. (middle/right) Residual maps ΔQ and ΔU resulting from instrumental polarization using the 3×3 matrix map-making approach with HWP.

where ${}_5\tilde{M}_{\text{ip}}$ is given by

$${}_5\tilde{M}_{\text{ip}} = \begin{pmatrix} 1 & \frac{1}{2}2,-4\tilde{h} & \frac{1}{2}2,-4\tilde{h} & \frac{1}{2}-4,4\tilde{h} & \frac{1}{2}4,-4\tilde{h} \\ \frac{1}{2}2,-4\tilde{h} & \frac{1}{4} & \frac{1}{4}4,-8\tilde{h} & \frac{1}{4}-2,0\tilde{h} & \frac{1}{4}6,-8\tilde{h} \\ \frac{1}{2}2,-4\tilde{h} & \frac{1}{4}-4,8\tilde{h} & \frac{1}{4} & \frac{1}{4}-6,8\tilde{h} & \frac{1}{4}2,0\tilde{h} \\ \frac{1}{2}4,-4\tilde{h} & \frac{1}{4}2,0\tilde{h} & \frac{1}{4}6,-8\tilde{h} & \frac{1}{4} & \frac{1}{4}8,-8\tilde{h} \\ \frac{1}{2}-4,4\tilde{h} & \frac{1}{4}-6,8\tilde{h} & \frac{1}{4}-2,0\tilde{h} & \frac{1}{4}-8,8\tilde{h} & \frac{1}{4} \end{pmatrix}^{-1}. \quad (6.78)$$

This map-maker captures the modulated temperature term, $\pm_{4,\mp 4}\hat{Z}$, and estimates it as shown in figure 6.16 (top panels). The residual maps' level is significantly reduced compared to the 3×3 matrix map-making approach, as shown in the middle and bottom panels of figure 6.16. The estimated $\Delta r = 0.00046$ in the case of the 3×3 matrix map-making approach, while the 5×5 matrix map-making approach yields $\Delta r < 10^{-6}$. This result implies that some HWP systematics driven by harmonics due to the HWP rotation can be mitigated using the map-making approach in terms of *spin*.

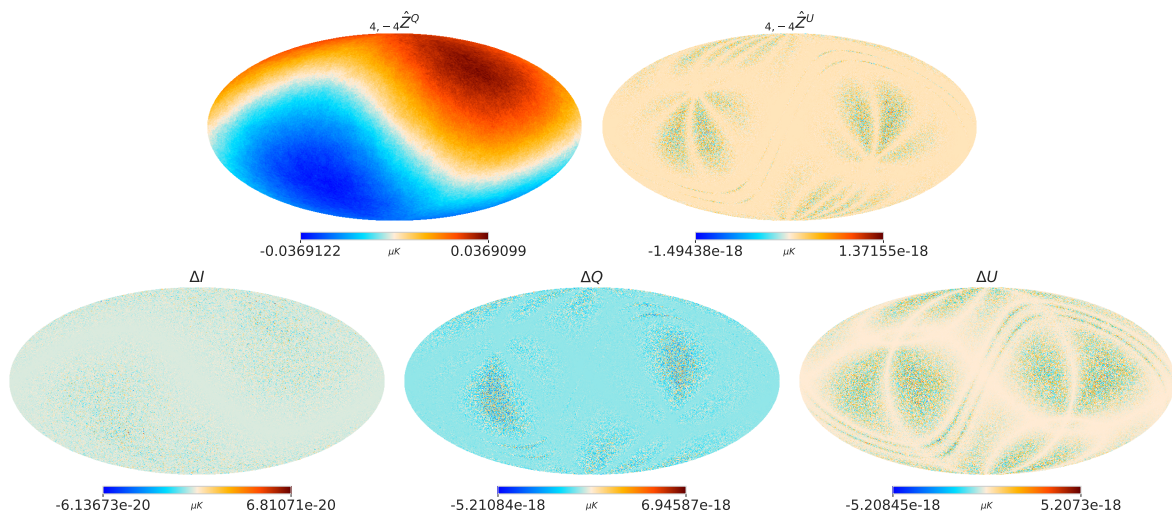

Figure 6.16: Estimated CMB maps and residual maps due to instrumental polarization using the 5×5 matrix map-making approach with HWP. The top panels show ${}_{4,-4}\hat{Z}^Q$ and ${}_{4,-4}\hat{Z}^U$, while the middle and bottom panels display ΔI , ΔQ , and ΔU . The systematic parameters for instrumental polarization are $(\epsilon_1, \phi_{QI}) = (1.0 \times 10^{-5}, 0)$ as used in section 5.5.5.

The systematic power spectrum obtained using this map-making approach is shown in figure 6.17. The solid blue line represents the derived ΔC_ℓ^{BB} , highlighting a noticeable bump in the low- ℓ region due to the dipole leakage.

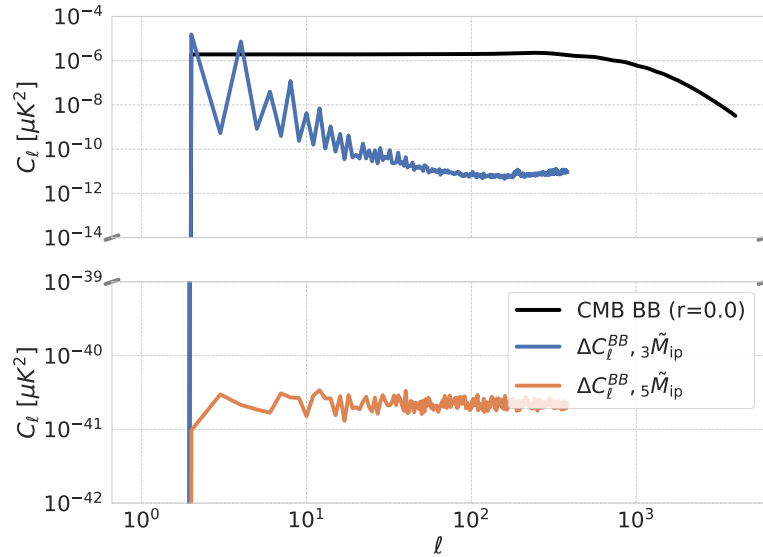

Figure 6.17: Systematic power spectrum ΔC_ℓ^{BB} due to instrumental polarization using the 3×3 matrix map-making approach (solid blue line) and the 5×5 matrix map-making approach (solid orange line) with HWP. The systematic parameters for instrumental polarization are $(\epsilon_1, \phi_{QI}) = (1.0 \times 10^{-5}, 0)$ as used in section 5.5.5.

The orange solid line shows the systematic power spectrum derived from the 5×5 matrix map-making approach, demonstrating a significant reduction in systematic contamination compared to the 3×3 matrix map-making approach. This result indicates that the $T \rightarrow B$ leakage induced by instrumental polarization due to HWP non-ideality can be effectively mitigated using the 5×5 matrix map-making approach.

Chapter 7

Conclusion

Contents

7.1 Summary of scanning strategy optimization	91
7.2 Summary of the systematic effect studies	93
7.3 Future perspective	94

7.1 Summary of scanning strategy optimization

This study has investigated the scanning strategy parameter space for spacecraft missions equipped with a HWP, utilizing $\{\alpha, T_\alpha, T_\beta\}$ as the primary variables. Our analysis focused on four fundamental metrics essential for B -mode observation: planet visibility time, forming speed of sky coverage, hit-map uniformity, and cross-link factor.

Through the application of our custom-developed scan simulator `Falcons.jl`, we conducted a comprehensive analysis of metric distributions across the $\{\alpha, T_\alpha, T_\beta\}$ parameter space. Our findings substantiate that the configuration adopted by *LiteBIRD*, as detailed in ref. [21] and known as the *standard configuration*, achieves an optimal balance between instrumental calibration, systematic effect suppression, and the implementation of robust null-tests for the mission.

From a more comprehensive perspective, optimal metric performance can be achieved within our defined scanning strategy parameter space (figure 5.1, right) by maintaining $\alpha \simeq \beta$ and constraining T_α to less than 100 hours. Our analysis revealed that the considered metrics exhibit small dependence on T_α within this kinetic parameter domain (as evidenced in figures 5.3 to 5.5), emphasizing the paramount importance of geometric parameters in scanning strategy optimization. Through rigorous examination detailed in section 5.6.1, we systematically eliminated sub-optimal configurations and determined that the geometric configuration of $(\alpha, \beta) = (45^\circ, 50^\circ)$ achieves an optimal equilibrium between our metrics and the requirements imposed by *LiteBIRD*'s instrumental architecture.

Throughout our analysis, we presented metric distributions within the $\{\alpha, T_\alpha\}$ parameter space while maintaining T_β at T_β^{lower} . This methodological approach was validated by our discovery that, in the regime where $T_\beta < 20$ min, the structural characteristics of these metric distributions demonstrates invariant scaling properties with respect to T_β , thereby preserving

the spatial configuration of optimal solutions. A comprehensive investigation of this invariant scaling behavior is elaborated in appendix B.2.

This invariant scaling property is further evidenced in figure 5.7, which illustrates the correlation between cross-link factors within the T_β and T_α parameter space. Our detailed analysis in section 5.6.2 demonstrates that the configuration of $T_\beta = 20$ min and $T_\alpha = 192$ min represents an optimal compromise for minimizing cross-link factors. These findings were derived under the assumption of *LiteBIRD*'s current HWP rotation rate. For alternative experimental configurations with elevated f_{knee} characteristics, enhanced HWP rotation speeds would be necessary to achieve efficient modulation. Under such circumstances, the lower boundary of the spin period, as defined by eq. (5.11), would be reduced, permitting more rapid spin rates. Nevertheless, figure 5.7 clearly demonstrates that reducing the spin period below $T_\beta = 20$ min offers no additional performance benefits.

Extended spin periods are beneficial for spacecraft attitude control, while shortened precession periods advantageously shift the CMB solar dipole signal used for gain calibration to higher frequencies, thereby suppressing low-frequency gain fluctuations (see figure 5.12). As shown in figure 5.11, a shortened precession period also allows for a wider distribution of scanning beam angles, effectively eliminating potential degeneracies between beam shape and various systematic effects. To avoid the manifestation of Moiré patterns in both hit-map and cross-link factor distributions—resulting from in-precession resonance phenomena (figure 5.9)—a meticulous refinement of the precession period was performed. This optimization process culminated in the selection of $T_\alpha = 192.348$ min, a value specifically chosen for its absence of nearby resonance peaks with significant standard deviations (figure 5.8).

Beyond the active mitigation of systematic effects through cross-link factor reduction, scanning strategies must incorporate robust null-test frameworks to evaluate the effectiveness of in-flight calibration strategies and facilitate the detection of unforeseen systematic effects. In section 5.7, we compared the sky pixel visit/revisit times and the visit/revisit times to planets—key indicators for designing calibration strategies and effective null-tests—across the scanning strategies of *Planck*, *PICO*, and *LiteBIRD*'s *standard configuration*. Our analysis revealed that *LiteBIRD* and *PICO* offer extensive daily coverage, allowing continuous observation of specific sky pixels and planets over extended periods. The frequent pixel revisitations at diverse temporal intervals exhibited by these missions facilitate various calibration strategies and null-test implementations through the strategic segmentation of observational data across multiple timescales for both sky pixels and planetary sources. Conversely, *Planck*'s scanning strategy, although not specifically optimized for polarization studies, exhibited exceptional efficiency in attaining rapid deep sensitivity and ensuring stable pixel observations—features particularly beneficial for temperature measurements. Moreover, while not explicitly detailed in the manuscript, our investigation encompassed the directional parameters of spacecraft rotation, including spin and precession orientations. Our analyses, predicated on counterclockwise spin, precession, and orbital motion, were subsequently validated through comprehensive simulations examining all permutations of clockwise and counterclockwise rotations, revealing negligible directional dependencies. A thorough exposition of this investigation is presented in appendix B.4.

The implementation of `Falcons.jl` proved transformative in our analytical approach, per-

forming grid searches on supercomputing platforms while achieving optimal memory utilization through thread-parallelization. Furthermore, our elucidation of the relationship between the scanning strategy parameter space and *LiteBIRD*'s *standard configuration*, within our defined constraints, provides invaluable insights for the architectural design of future space-based polarimetric missions. The adaptable framework of our scan simulator `Falcons.jl` extends beyond the specific requirements of the *LiteBIRD* mission, offering broader applicability in the field.

7.2 Summary of the systematic effect studies

The *spin*-based map-making methodology developed described in chapter 4 has proven exceptionally effective for both scanning strategy optimization and systematic effect evaluation. This approach achieved enhanced versatility through Fourier transformation of HWP rotation angles, enabling accommodation of more complex experimental configurations. Compared to conventional TOD-based binning map-making techniques, our method achieved approximately 10^4 -fold computational acceleration by transforming individual pixel binning operations into efficient map, i.e., image convolutions within Fourier (*spin*) space.

The primary advantage of our methodology extends beyond mere computational efficiency to provide deeper insights into how systematic effects influence polarimetry. While TOD-based simulations struggled to elucidate the interplay between systematic effects and scanning strategies, our approach, leveraging the inherent rotational symmetry, i.e., *spin* of polarization and systematic effects, enabled analytical understanding of the relationship between scanning strategy's cross-linking and systematic effects. This framework revealed both the mechanisms by which specific systematic effects induce $T \rightarrow B$ or $E \rightarrow B$ leakage and their suppression through the cross-linking of scanning strategy, as we discussed in chapter 6.

Furthermore, we developed an enhanced map-maker capable of simultaneous polarization and systematic effect estimation through extension of the regression estimation linear system as shown in section 6.3. This methodology enables separation of polarization components from systematic effects utilizing *spin* properties, resulting in more precise polarization maps.

Performance evaluation of our optimized scanning strategy demonstrated that with HWP implementation, in section 6.4, nearly all systematic effects were suppressed to $\Delta r < 10^{-6}$ (less than $1/10^3$ of *LiteBIRD*'s science objective). Notably, comparable suppression levels ($\Delta r \lesssim 10^{-6}$) were achievable even without HWP utilization through our developed suppression techniques.

However, the absence of HWP necessitates allocation of sensitivity to systematic effect estimation, inevitably increasing statistical errors. This presents an intriguing trade-off between active systematic error suppression through HWP implementation versus achieving sensitivity through increased detector count or observation time while employing our methodology without HWP.

7.3 Future perspective

An important remaining challenge lies in the analysis of systematic effects. While we pioneered the world’s first formulation of a map-based formalism using *spin* with HWP, we have yet to develop methodologies for directly calculating systematics power spectra from systematic fields in with HWP scenarios, as we did for the differential gain and pointing by eqs. (6.57) and (6.61). Such development would enable the calculation of systematic power spectra without CMB ensemble averaging and cosmic variance effects, potentially leading to substantial computational efficiency obtains and deeper insights into systematic effects.

In our research, we conducted simulations using CMB-only input maps to elucidate the impact of systematic effects on CMB maps and *B*-mode power spectra. However, real observations are complicated by foreground emissions, including synchrotron and dust radiation from the Milky Way superimposed on the CMB signal. The analysis of systematic effects incorporating these foreground contributions remains an important avenue for future investigation.

As mentioned at the conclusion of the previous section, a crucial area for future research involves resolving the trade-off between active systematic error suppression through HWP implementation versus achieving enhanced sensitivity through increased detector count or extended observation time without HWP while employing our methodology.

Notably, the software tools developed and utilized in this research—`Falcons.jl` and `SBM`—are publicly available on the author’s GitHub repository, enabling third-party verification and reproduction of our results.¹ Future work will also encompass maintaining software quality standards and developing comprehensive documentation.

¹<https://github.com/yusuke-takase>

Appendix A

Additional derivations and frameworks

Contents

A.1	Fundamentals of cosmology	95
A.1.1	Dipole temperature anisotropy of the CMB	95
A.2	Scanning motion of spacecraft	96
A.2.1	Sweep angular velocity on the sky	97
A.3	Method to estimate the bias on r	98
A.4	The HEALPix software package	99
A.4.1	Polarization convention on the sphere	100

This appendix provides additional derivations to support the discussion in the manuscript. We first derive the dipole temperature anisotropy of the CMB in. Next, we describe the spacecraft scanning motion in detail. We then discuss the HEALPix software framework, which is used for spherical data analysis. Finally, we present a method to estimate the bias on the tensor-to-scalar ratio r .

A.1 Fundamentals of cosmology

A.1.1 Dipole temperature anisotropy of the CMB

Consider a system where the temperature distribution of the CMB on the celestial sphere is isotropic with a temperature T_0 . This is called the rest frame of the CMB. Next, consider an observer moving with velocity \mathbf{v} relative to the rest frame of the CMB. Due to the Doppler effect of light, the energy of photons arriving from the direction of motion increases, while the energy of photons arriving from the opposite direction decreases. Therefore, the temperature

distribution $T(\hat{n})$ observed in the direction of the unit vector \hat{n} is given by

$$T(\hat{n}) = \frac{T_0 \sqrt{1 - \frac{v^2}{c^2}}}{1 - \frac{\mathbf{v} \cdot \hat{n}}{c}}, \quad (\text{A.1})$$

where c is the speed of light. This can be expanded in spherical harmonics, and if the origin of the celestial coordinates θ is taken in the direction of the velocity vector, the expansion coefficients $a_{\ell m}$ become zero for all values of m except $m = 0$. The Earth orbits the Sun at approximately 30 km/s. From the rest frame of the CMB, the direction of the Earth's velocity vector changes with the seasons, so the temperature anisotropy of the CMB observed from Earth varies seasonally. Excluding the anisotropy due to the Earth's orbital motion, the remaining temperature anisotropy is caused by the Sun's orbital motion around the galactic center, the mutual interaction between our galaxy and the Andromeda galaxy, and the influence of the large-scale structure of galaxies. The temperature anisotropy we observe is the sum of all these velocity vectors. If the velocity vector of the solar system relative to the rest frame of the CMB is denoted as $\mathbf{v}_{\text{solar system}}$, it can be written as

$$\mathbf{v}_{\text{solar system}} = (\mathbf{v}_{\text{solar system}} - \mathbf{v}_{\text{galactic}}) + (\mathbf{v}_{\text{galactic}} - \mathbf{v}_{\text{local group}}) + \mathbf{v}_{\text{local group}}, \quad (\text{A.2})$$

The first and second terms on the right-hand side are measured by astronomical observations, and their magnitudes are approximately 220 km/s and 80 km/s, respectively. The third term is difficult to measure by astronomical observations, but it can be estimated by detailed observations of the temperature anisotropy of the CMB. The amplitude of CMB dipole is measured as $3361.90 \pm 0.36 \mu\text{K}$ by *Planck* [116].

A.2 Scanning motion of spacecraft

This section defines the spacecraft's spin and precession motions in detail. Consider an orthonormal coordinate frame xyz where the spacecraft's spin axis aligns with the z -axis. Let β be the angle between the telescope boresight and spin axis. In the xyz frame, the boresight direction vector is $\mathbf{n}_0 = (\sin \beta, 0, \cos \beta)$. The 'spin' motion, with angular velocity ω_β around the z -axis, transforms \mathbf{n}_0 via the time-dependent rotation matrix R_z :

$$\begin{aligned} \mathbf{n}_{\text{spin}}(t) &= R_z(\omega_\beta t) \mathbf{n}_0 \\ &= \begin{pmatrix} \cos \omega_\beta t & -\sin \omega_\beta t & 0 \\ \sin \omega_\beta t & \cos \omega_\beta t & 0 \\ 0 & 0 & 1 \end{pmatrix} \begin{pmatrix} \sin \beta \\ 0 \\ \cos \beta \end{pmatrix}, \end{aligned} \quad (\text{A.3})$$

where R_j ($j \in \{x, y, z\}$) represents rotation matrices around respective axes. To incorporate spin axis time dependence, we align the z -axis with the Sun-spacecraft axis (see figure 5.1, left).

The spin axis is tilted by angle α through a y -axis rotation:

$$\begin{aligned}\mathbf{n}'_{\text{spin}}(t) &= R_y(\alpha)\mathbf{n}_{\text{spin}}(t) \\ &= \begin{pmatrix} \cos \alpha & 0 & \sin \alpha \\ 0 & 1 & 0 \\ -\sin \alpha & 0 & \cos \alpha \end{pmatrix} \mathbf{n}_{\text{spin}}(t),\end{aligned}\tag{A.4}$$

Here, $\mathbf{n}'_{\text{spin}}(t)$ describes the boresight rotation around the tilted spin axis. The ‘precession’ motion adds rotation to the spin axis around the z -axis with angular velocity ω_α :

$$\begin{aligned}\mathbf{n}(t) &= R_z(\omega_\alpha t)\mathbf{n}'_{\text{spin}}(t) \\ &= \begin{pmatrix} \cos \omega_\alpha t & -\sin \omega_\alpha t & 0 \\ \sin \omega_\alpha t & \cos \omega_\alpha t & 0 \\ 0 & 0 & 1 \end{pmatrix} \mathbf{n}'_{\text{spin}}(t),\end{aligned}\tag{A.5}$$

The complete rotational motion combines spin and precession through the matrix chain:

$$\begin{aligned}\mathbf{n}(t) &= R_z(\omega_\alpha t)R_y(\alpha)R_z(\omega_\beta t)\mathbf{n}_0 \\ &= \begin{pmatrix} \cos \omega_\alpha t & -\sin \omega_\alpha t & 0 \\ \sin \omega_\alpha t & \cos \omega_\alpha t & 0 \\ 0 & 0 & 1 \end{pmatrix} \begin{pmatrix} \cos \alpha & 0 & \sin \alpha \\ 0 & 1 & 0 \\ -\sin \alpha & 0 & \cos \alpha \end{pmatrix} \begin{pmatrix} \cos \omega_\beta t & -\sin \omega_\beta t & 0 \\ \sin \omega_\beta t & \cos \omega_\beta t & 0 \\ 0 & 0 & 1 \end{pmatrix} \begin{pmatrix} \sin \beta \\ 0 \\ \cos \beta \end{pmatrix}.\end{aligned}\tag{A.6}$$

By the chain, the motion of spacecraft except for the orbital motion around the Sun is fully described.

A.2.1 Sweep angular velocity on the sky

We now derive the maximum angular velocity of the telescope’s boresight sweep across the sky.¹ Using eq. (A.6), the angle ΔA traversed by $\mathbf{n}(t)$ between times t and $t + \Delta t$ is:

$$\Delta A = |\mathbf{n}(t + \Delta t) - \mathbf{n}(t)|.\tag{A.7}$$

The sweep angular velocity $\frac{dA}{dt}$ is:

$$\frac{dA}{dt} = \left| \frac{d\mathbf{n}(t)}{dt} \right|.\tag{A.8}$$

The maximum sweep velocity ω_{max} occurs when $\omega_\beta t = 0$:

$$\begin{aligned}\omega_{\text{max}} &= \left| \frac{dA}{dt} \right|_{\text{max}} \\ &= \omega_\alpha \sin(\alpha + \beta) + \omega_\beta \sin \beta.\end{aligned}\tag{A.9}$$

¹We ignore the orbital rotation around the Sun due to its negligible contribution to spin and precession.

Note that this assumes aligned precession and spin rotation directions. For analysis of reversed rotation directions and their impact on scanning strategy optimization, see appendix B.4.

A.3 Method to estimate the bias on r

We can obtain temperature and polarization maps with specific systematic effects using the formalism described in this section. The residual maps are created by subtracting the original input map from the output map containing systematic effects:

$$\Delta I = {}_{0,0}\tilde{S}^d - {}_{0,0}\tilde{S}, \quad (\text{A.10})$$

$$\Delta P = {}_{2,-4}\tilde{S}^d - {}_{2,-4}\tilde{S}, \quad (\text{A.11})$$

where ΔP decomposes into Stokes parameters as $\Delta Q = \text{Re}[\Delta P]$ and $\Delta U = \text{Im}[\Delta P]$. For cases where signal fields are already described solely by systematic signal fields (as with HWP non-ideality in section 6.2.3), we can obtain the residuals directly:

$$\Delta I = {}_{0,0}\Delta\tilde{S}^d, \quad (\text{A.12})$$

$$\Delta Q = \text{Re}\left[{}_{2,-4}\Delta\tilde{S}^d\right], \quad (\text{A.13})$$

$$\Delta U = \text{Im}\left[{}_{2,-4}\Delta\tilde{S}^d\right]. \quad (\text{A.14})$$

To assess potential systematic bias Δr on the tensor-to-scalar ratio r , we define a likelihood function $L(r)$ as:

$$\log L(r) = \sum_{\ell=\ell_{\min}}^{\ell_{\max}} \log P_{\ell}(r), \quad (\text{A.15})$$

using multipole range $(\ell_{\min}, \ell_{\max}) = (2, 191)$ [21]. Here, $P_{\ell}(r)$ is defined as:

$$\log P_{\ell}(r) = -f_{\text{sky}} \frac{2\ell+1}{2} \left[\frac{\hat{C}_{\ell}}{C_{\ell}} + \log C_{\ell} - \frac{2\ell-1}{2\ell+1} \log \hat{C}_{\ell} \right], \quad (\text{A.16})$$

where \hat{C}_{ℓ} and C_{ℓ} represent measured and modeled B -mode power spectra respectively [117]. We use $f_{\text{sky}} = 1$ for full-sky coverage. The power spectra are:

$$\hat{C}_{\ell} = \Delta C_{\ell} + C_{\ell}^{\text{lens}} + N_{\ell}, \quad (\text{A.17})$$

$$C_{\ell} = r C_{\ell}^{\text{tens}} + C_{\ell}^{\text{lens}} + N_{\ell}, \quad (\text{A.18})$$

where ΔC_{ℓ} is the systematic effects power spectrum from ΔQ and ΔU , C_{ℓ}^{lens} is the lensing B -mode spectrum, C_{ℓ}^{tens} is the tensor mode with $r = 1$ [21], and N_{ℓ} represents noise power spectrum.

The systematic bias Δr is defined as the value maximizing $L(r)$:

$$\left. \frac{dL(r)}{dr} \right|_{r=\Delta r} = 0. \quad (\text{A.19})$$

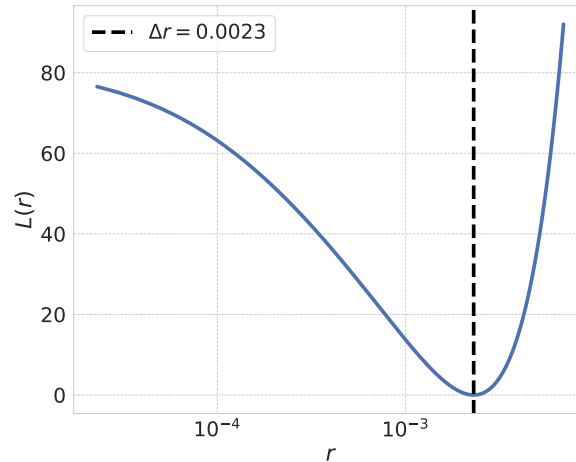

Figure A.1: Likelihood function $L(r)$ for the 0.1% differential gain systematics case.

Results in section 5.5.5 use this definition.

A.4 The HEALPix software package

HEALPix (Hierarchical Equal Area and isoLatitude Pixelisation) is a software framework that enables systematic handling of spherical data through pixelization of the celestial sphere.² It has become the standard tool for data analysis in modern astrophysics and astronomy.

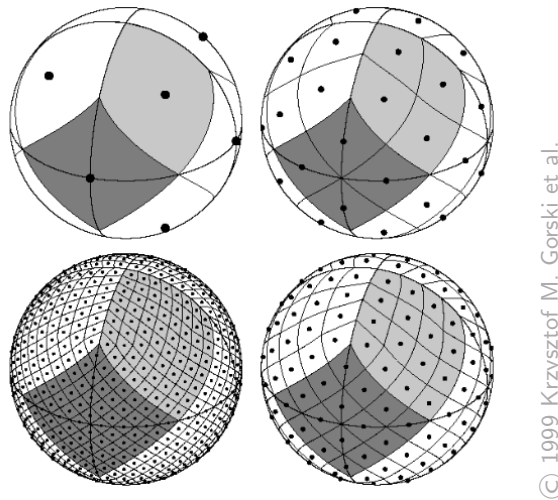

Figure A.2: Orthographic projection of the celestial sphere divided into HEALPix pixels. Bold lines represent the equator and meridians. Light gray regions show polar base-resolution pixels, while dark gray regions show equatorial base-resolution pixels, illustrating different pixel shapes in these regions. Clockwise from top-left: $N_{\text{side}} = 1, 2, 4, 8$, corresponding to total pixel counts $N_{\text{pix}} = 12, 48, 192, 768$ per eq. (A.21). The figure adapted from ref. [118], with permission of the authors.

²<https://healpix.sourceforge.io/>

The HEALPix resolution parameter N_{side} is defined as a power of 2:

$$N_{\text{side}} = 2^n, \quad (\text{A.20})$$

where n is an integer. This scheme divides the sphere into equal-area pixels (see figure A.2). The total number of pixels N_{pix} relates to N_{side} as:

$$N_{\text{pix}} = 12 \times N_{\text{side}}^2, \quad (\text{A.21})$$

In CMB research, the Ring ordering scheme is commonly used for pixel numbering, where indices spiral from the north pole to the south pole, as shown in figure A.3.

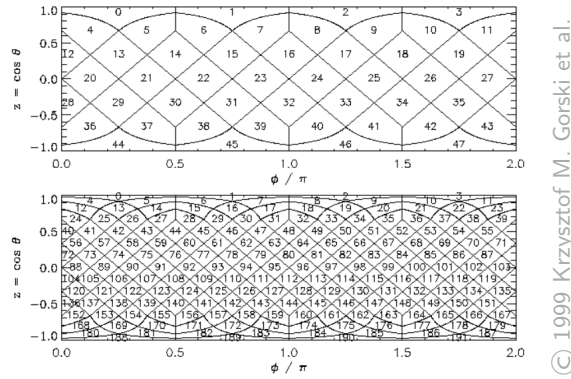

Figure A.3: Cylindrical projection of the HEALPix-pixelized celestial sphere. The ‘Ring’ ordering scheme numbers pixels from $z = \cos \theta = 1$ to $z = \cos \theta = -1$ with increasing ϕ . The figure adapted from ref. [118], with permission of the authors.

A.4.1 Polarization convention on the sphere

Two major conventions exist for defining polarization on a sphere. The IAU convention defines the coordinate system at any tangent plane with positive z -axis pointing toward the sphere’s center and positive x -axis in the direction of decreasing polar angle θ . The Stokes parameters Q and U are defined in this frame.

In contrast, the COSMO (HEALPix) convention defines the positive z -axis outward from the sphere’s surface and positive x -axis in the direction of increasing polar angle θ . This difference results in a sign flip for the U parameter. These coordinates are summarized by NASA’s LAMBDA (Legacy Archive for Microwave Background Data Analysis) project.³

³https://lambda.gsfc.nasa.gov/product/about/pol_convention.html

Appendix B

Supplementary results and discussions

Contents

B.1 Comparison between TOD and map-based simulation	101
B.2 Impact of the value of the spin period on the metrics	102
B.3 Metrics for detectors located away from the boresight	103
B.4 Discussion on the rotation direction of the spacecraft	103

This appendix presents supplementary analyses and discussions that complement the scanning strategy optimization addressed in the manuscript. We begin by validating our map-based simulation methodology through comparison with TOD-based simulations. Subsequently, we examine how variations in the spin period influence key performance metrics. We then investigate the impact of detector positioning relative to the boresight on optimization parameters. Finally, we analyze how different spacecraft rotation configurations affect the overall scanning performance metrics.

B.1 Comparison between TOD and map-based simulation

We validate our map-based simulation with *spin* formalism against general TOD-based simulation performed by eq. (4.23), using the same input maps and systematic parameters as section 5.5.5. Following systematic effect injection and map-making, we compute ΔQ , ΔU maps and ΔC_ℓ according to appendix A.3.

Figure B.1 shows the comparison of ΔC_ℓ between TOD-based (blue dots) and map-based approaches (orange crosses) for two cases:

- Left: CMB-only input with pointing offset $(\rho, \chi) = (1', 0')$
- Right: Solar dipole-only input with HWP non-ideality $(\epsilon_1, \phi_{QI}) = (1.0 \times 10^{-5}, 0)$

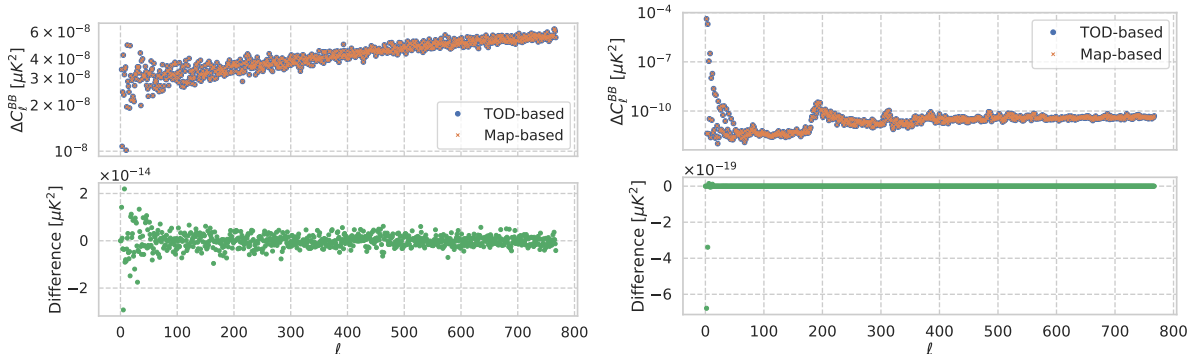

Figure B.1: Systematic effect B -mode power spectra (ΔC_ℓ^{BB}) comparing pointing offset (left) and HWP non-ideality (right). Blue dots show TOD-based simulation results, orange crosses show map-based simulation results, and green dots (bottom) show their difference. The left panel uses CMB-only input with $(\rho, \chi) = (1', 0')$, while the right panel uses solar dipole input with $(\epsilon_1, \phi_{QT}) = (1.0 \times 10^{-5}, 0)$.

The difference between methods (green dots) remains at $\mathcal{O}(10^{-14}) \mu K^2$, confirming their numerical equivalence. For the HWP non-ideality case, we observe a jump at $\ell \simeq 200$ arising from the east-west structure in the hit map (see figure 5.2 middle bottom).

This comparison confirms that our map-based simulations achieve scientific equivalence with TOD simulations, even when incorporating HWP contributions.

B.2 Impact of the value of the spin period on the metrics

In this paper, we presented results in the $\{\alpha, T_\alpha\}$ space using a fixed $T_\beta = T_\beta^{\text{lower}} = 16.9$ min. While T_β can vary freely above T_β^{lower} , creating a three-dimensional parameter space $\{\alpha, T_\alpha, T_\beta^{\text{lower}} < T_\beta\}$, we demonstrate that varying T_β merely rescales the metrics without affecting their optimal values.

To illustrate this, we examine how rescaling T_β^{lower} affects the cross-link factor distribution in the $\{\alpha, T_\alpha\}$ space. Figure B.2 (top left) shows the $\{\alpha, T_\alpha, T_\beta^{\text{scaled}}\}$ space where we multiply the *standard configuration* point $(\alpha, T_\alpha) = (45^\circ, 192.348 \text{ min})$ by a constant to achieve $T_\beta = 20$ min.

The resulting cross-link factors are shown in figure B.2: *spin*-(2, 0) (top right), *spin*-(2, 4) (bottom left), and *spin*-(4, 8) (bottom right). The *spin*-(2, 0) factor, which excludes HWP contributions, remains nearly identical to results using T_β^{lower} . The *spin*-(2, 4) and *spin*-(4, 8) factors maintain their flat distribution pattern but show smaller values due to slower spin allowing more HWP rotation per sky pixel. While this helps suppress systematic effects, excessive slowdown can degrade *spin*-(n , 0) cross-link factors, as discussed in section 5.6.2. These results confirm that changing rotation periods only scales values without altering the global structure.

This scaling principle extends to hit-map uniformity and planet visibility metrics, as these primarily depend on geometric parameters like sky scanning patterns and scan pupil size.

B.3 Metrics for detectors located away from the boresight

Here we analyze how metrics vary for detectors positioned away from the boresight (focal plane center) in our *standard configuration*. These detectors have different effective β angles (β^{eff}) relative to the boresight, expressed as:

$$\beta_i^{\text{eff}} = \beta + \beta_i, \quad (\text{B.1})$$

where i denotes the detector index. Different β_i values yield unique scan trajectories and metric values. However, detectors with β_i^{eff} close to β maintain nearly identical trajectories and metrics to the boresight. We simulate planets visibility time and cross-link factors for detectors at extreme β_i values ($\pm 14^\circ$) within the MFT/HFT's 14° radius field of view.

Figure B.3 shows planet visibility integration times (top left/middle: $\beta_i = \mp 14^\circ$). Like figure 5.3, these remain independent of T_α , peaking at $\alpha = (\kappa + \beta_i)/2$. The results demonstrate that our *standard configuration* provides substantial planet visibility for both boresight and extreme- β_i^{eff} detectors.

The figure also shows *spin*-(2,0) cross-link factors (top right/bottom left: $\beta_i = \mp 14^\circ$) and *spin*-(2,4) factors (bottom middle/right: $\beta_i = \mp 14^\circ$). For some effective β values, detectors cannot satisfy eq. (5.4), causing unobservable regions near ecliptic poles with divergent cross-link factors. We present full-sky averages excluding these divergent pixels.

The $\beta_i = -14^\circ$ detector's limited sky coverage prevents full-sky observation. While *spin*-(2,0) factors maintain similar structure between $\beta_i = \pm 14^\circ$, values increase for $\beta_i = -14^\circ$ due to reduced crossing angle uniformity in the narrower accessible region. The *spin*-(2,4) factors show structural changes with generally lower values for $\beta_i = -14^\circ$, as slower scanning (per eq. (A.9)) allows more HWP rotations per sky pixel. Despite these variations, the *standard configuration* maintains low cross-link factors across all detector positions.

B.4 Discussion on the rotation direction of the spacecraft

While we defined forward (counterclockwise) rotation in eq. (A.6), four possible spin-precession rotation direction combinations exist. Since these combinations create different trajectories relative to orbital direction, we must verify our conclusions hold regardless of rotation direction.

We classify the four combinations using rotation matrix signs and define spin-precession coherence as their product, shown in table B.1.

Sign of precession	+	+	-	-
Sign of spin	+	-	+	-
Spin-precession coherence	+	-	-	+

Table B.1: Convention for spin and precession coherence.

Positive coherence follows eq. (A.9) for ω_{max} , while negative coherence causes one rotation to counteract the other, reducing sweep velocity. For negative coherence, we transpose the R_z

rotation matrix in eq. (A.6):

$$\mathbf{n}(t) = R_z(\omega_\alpha t) R_y(\alpha) R_z^\top(\omega_\beta t) \mathbf{n}_0, \quad (\text{B.2})$$

where \top denotes matrix transposition. The sweep velocity becomes:

$$\omega_{\max}^\pm = \omega_\alpha \sin(\alpha \pm \beta) + \omega_\beta \sin \beta, \quad (\text{B.3})$$

with $+/-$ indicating positive/negative coherence. This modification affects T_β^{lower} and T_α^{lower} constraints:

$$T_\beta^{\text{lower}, \pm} = \frac{2\pi N_{\text{mod}} T_\alpha \sin \beta}{\Delta\theta f_\phi T_\alpha - 2\pi N_{\text{mod}} \sin(\alpha \pm \beta)}, \quad (\text{B.4})$$

$$T_\alpha^{\text{lower}, \pm} = \frac{2\pi N_{\text{mod}} (\sin \beta + \sin(\alpha \pm \beta))}{\Delta\theta f_\phi}. \quad (\text{B.5})$$

Negative coherence produces a different $T_\beta^{\text{lower}}(\alpha, T_\alpha)$ space than figure 5.1 (right), shown in figure B.4 (top left), allowing shorter T_β^{lower} due to $\omega_{\max}^+ \rightarrow \omega_{\max}^-$. We examined all metrics across all four combinations, finding the *standard configuration* maintains its advantages. The remaining panels in figure B.4 show cross-link factors for (prec., spin) = (+, -), demonstrating minimal changes from figure 5.5.

Notably, negative coherence configurations like (prec., spin) = (+, -) can reduce maximum sweep velocity without parameter changes. For example, the *standard configuration*'s $\omega_{\max}^+ = 0.26$ deg/s reduces to $\omega_{\max}^- = 0.23$ deg/s with reversed spin, increasing data samples and HWP rotations per sky pixel.

The impact of this velocity reduction on physical results, particularly with time-correlated noise and HWP-synchronized systematics, requires future end-to-end simulation study. However, our *standard configuration* maintains required scanning capabilities regardless of rotation directions, providing sufficient information for basic spacecraft design.

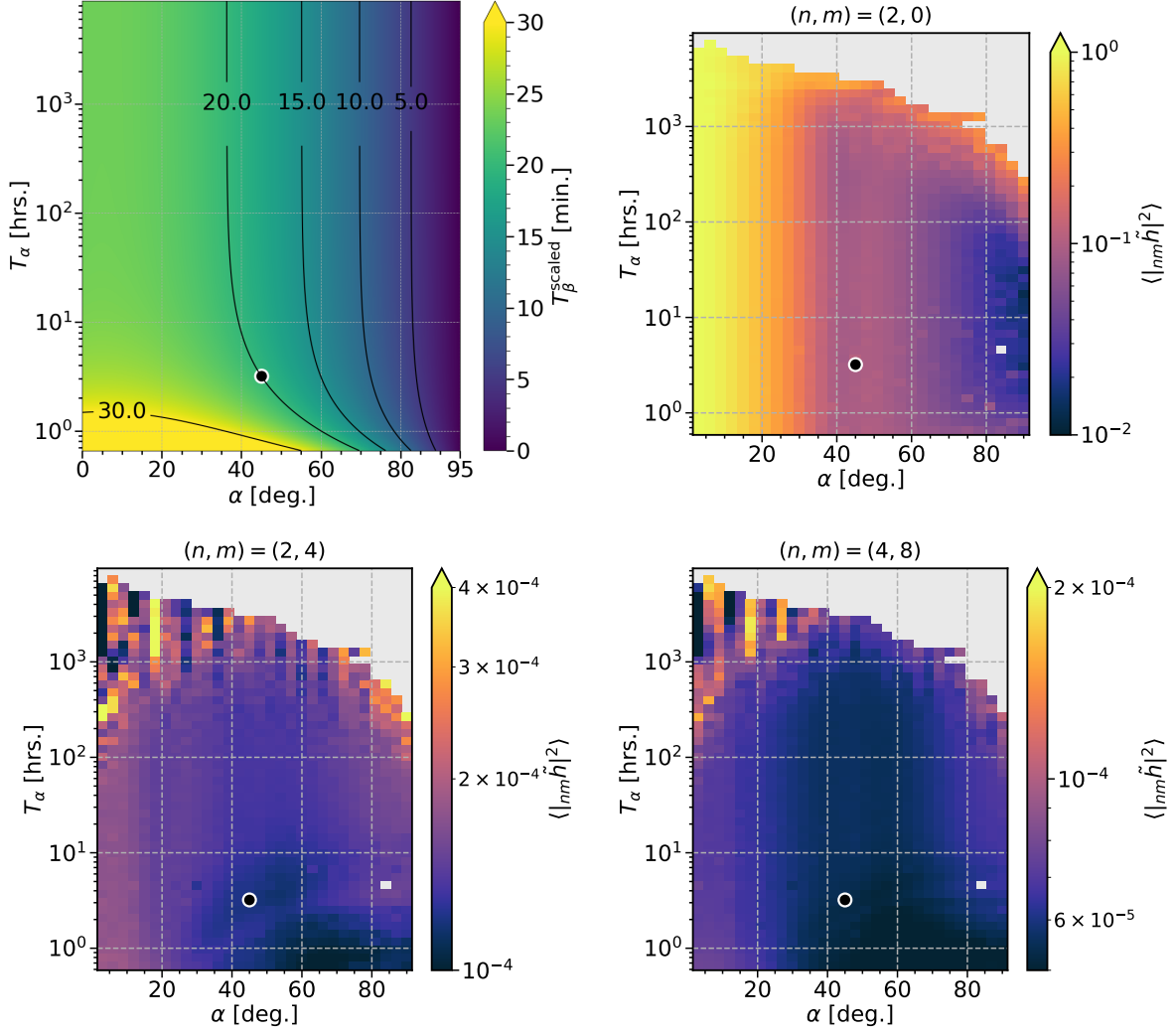

Figure B.2: (top left) $\{\alpha, T_\alpha, T_\beta^{\text{scaled}}\}$ space derived by scaling T_β^{lower} to achieve $T_\beta = 20$ min at the *standard configuration* point. (top right) *spin*-(2, 0) cross-link factors. (bottom left/right) *spin*-(2, 4)/*spin*-(4, 8) cross-link factors. Non-zero *spin*- m cross-link factors show reduced values compared to T_β^{lower} calculations due to increased HWP rotation time per sky pixel. The blank point in the bottom right corner indicates unobserved sky pixels from spin-precession resonances, resolvable through minor precession period adjustments.

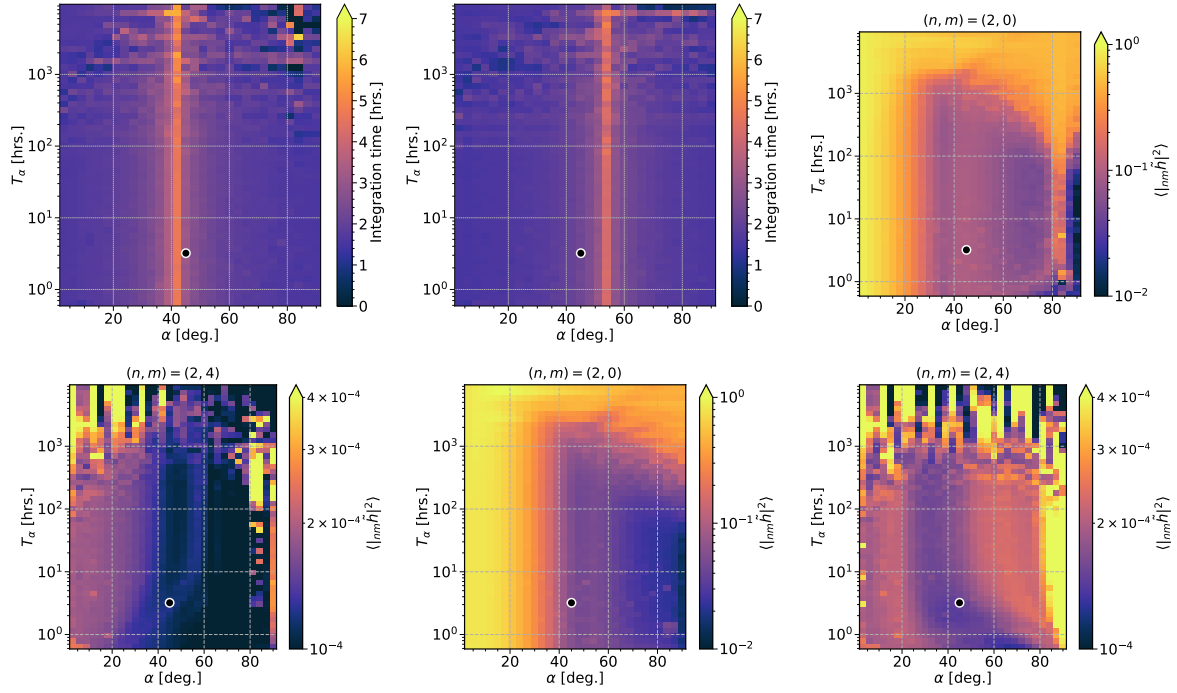

Figure B.3: (top left/top middle) Integrated planet visibility time simulated by a detector which has $\beta_i = -14^\circ/14^\circ$. (top right/bottom left) *spin*-(2, 0) cross-link factor simulated by a detector which has $\beta_i = -14^\circ/14^\circ$. (bottom middle/bottom right) *spin*-(2, 4) cross-link factor simulated by a detector which has $\beta_i = -14^\circ/14^\circ$. Values for sky pixels with diverging cross-link factors are ignored and averaged over the entire sky.

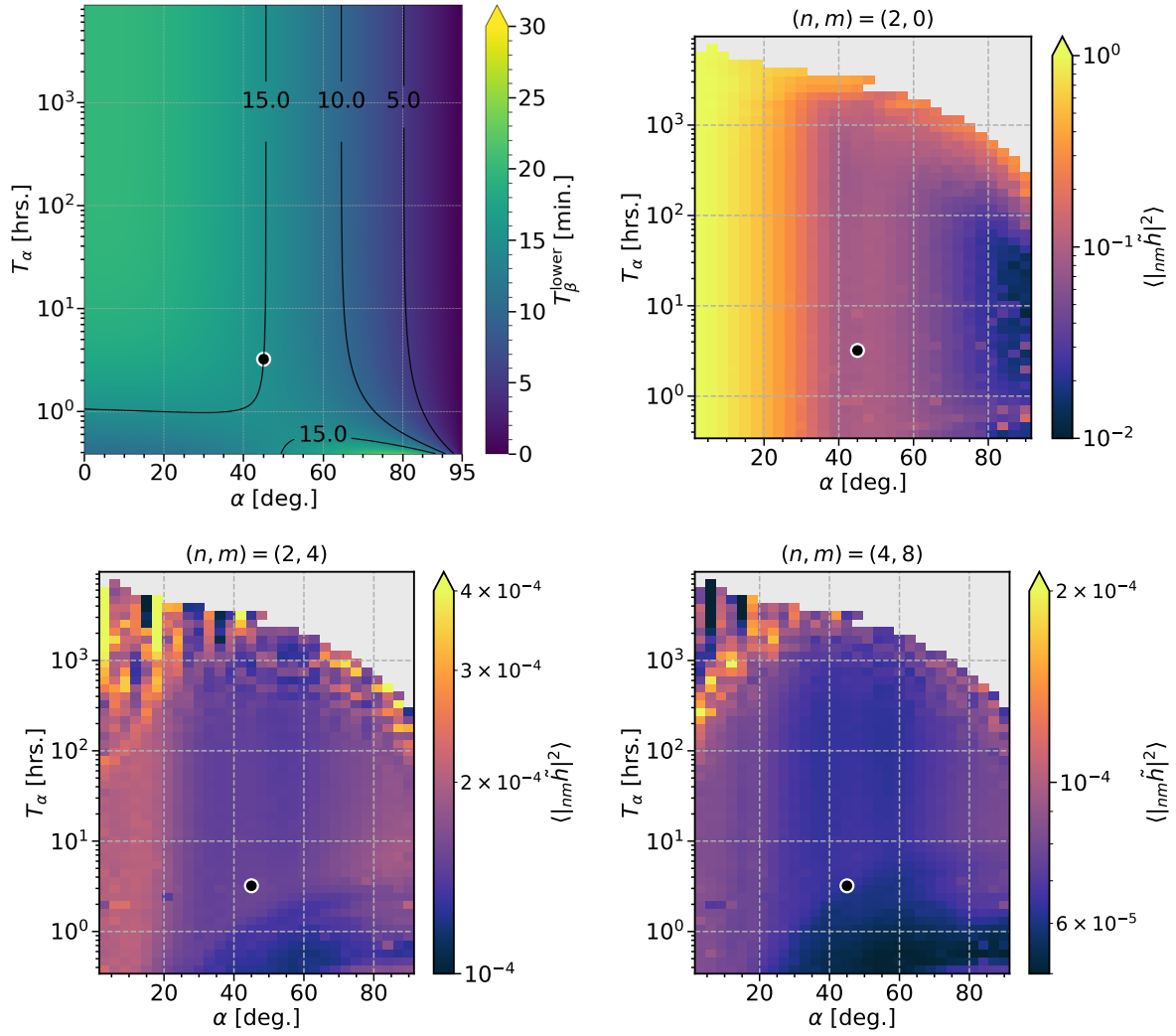

Figure B.4: (top left) $\{\alpha, T_\alpha, T_\beta^{\text{lower},-}\}$ space given by eq. (B.4). (top right) $spin$ -(2, 0) cross-link factors simulated using $T_\beta^{\text{lower},-}$. (bottom left/right) $spin$ -(2, 4)/ $spin$ -(4, 8) cross-link factors simulated using $T_\beta^{\text{lower},-}$. Maps use (prec., spin) = (+, -) configuration. The change from $\omega_{\text{max}}^+ \rightarrow \omega_{\text{max}}^-$ reduces sweep speed and increases HWP rotations per sky pixel visit, resulting in smaller non-zero $spin$ - m cross-link factors compared to $T_\beta^{\text{lower},+}$ case in section 5.5.4.

Appendix C

Additional figures

Contents

C.1 Cross-link maps	108
---	-----

This appendix shows specific cross-link maps for $spin-(n, m)$ configurations.

C.1 Cross-link maps

We present cross-link maps for $spin-(n, 0)$ for $n = 1$ to 10 in figure [C.1](#), $spin-(n, 4)$ for $n = 1$ to 10 in figure [C.2](#) and $spin-(n, 8)$ for $n = 1$ to 10 in figure [C.1](#). The maps are calculated by 3-years simulation by *LiteBIRD's standard configuration* with $N_{\text{side}} = 128$ configuration.

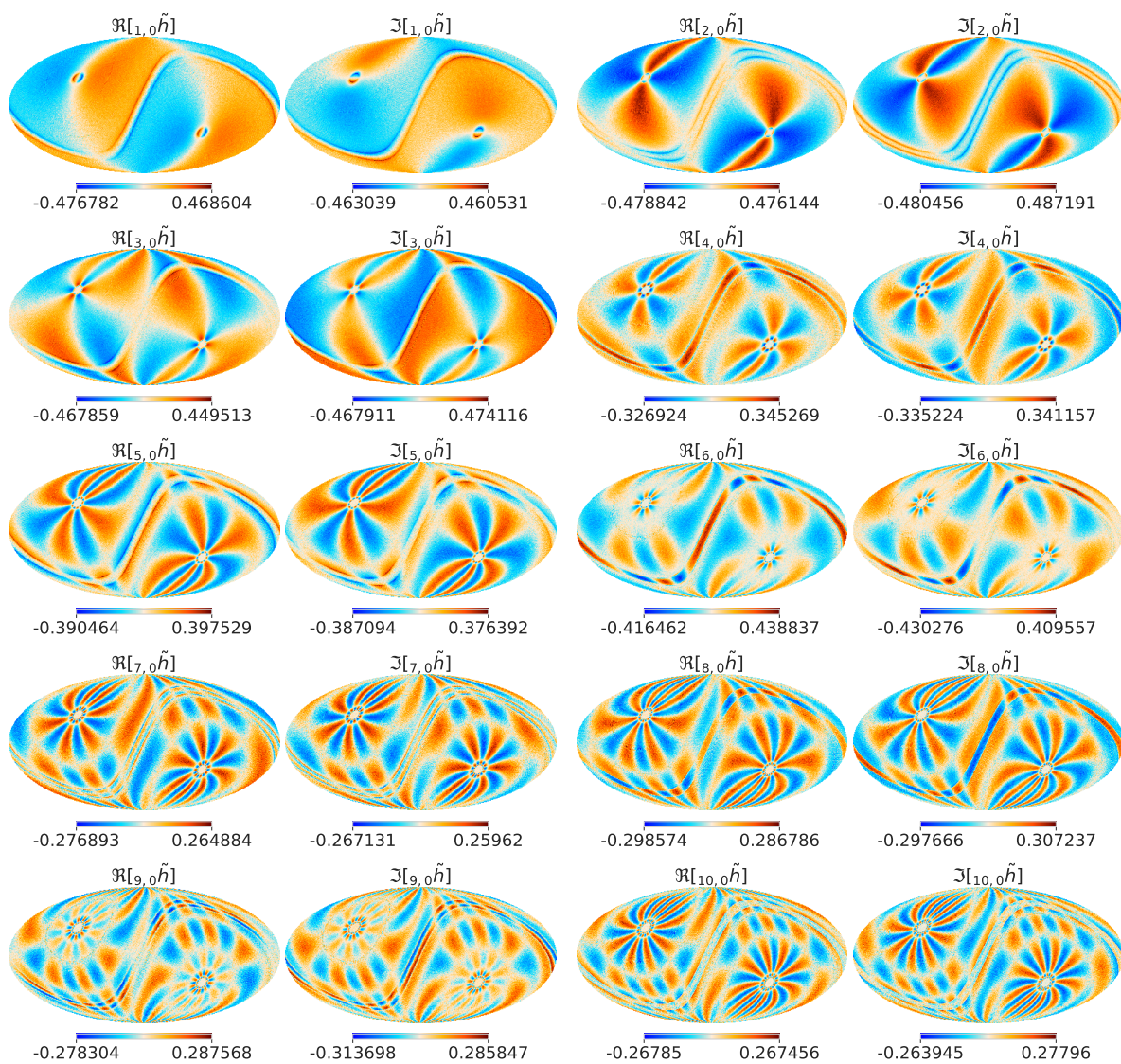
Figure C.1: $Spin-(n,0)$ cross-link factors for $n = 1$ to 10 .

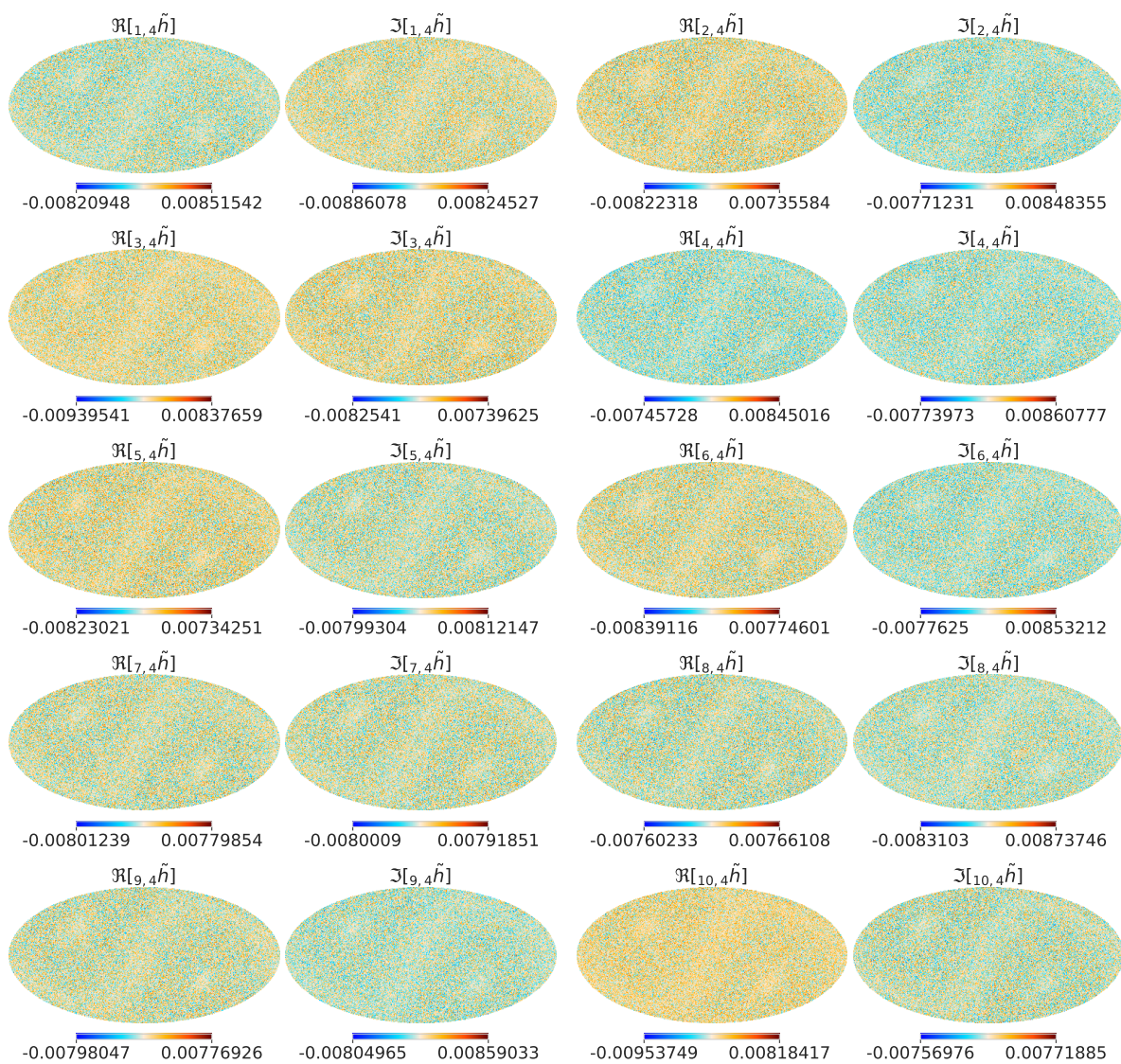
Figure C.2: $Spin-(n, 4)$ cross-link factors for $n = 1$ to 10 .

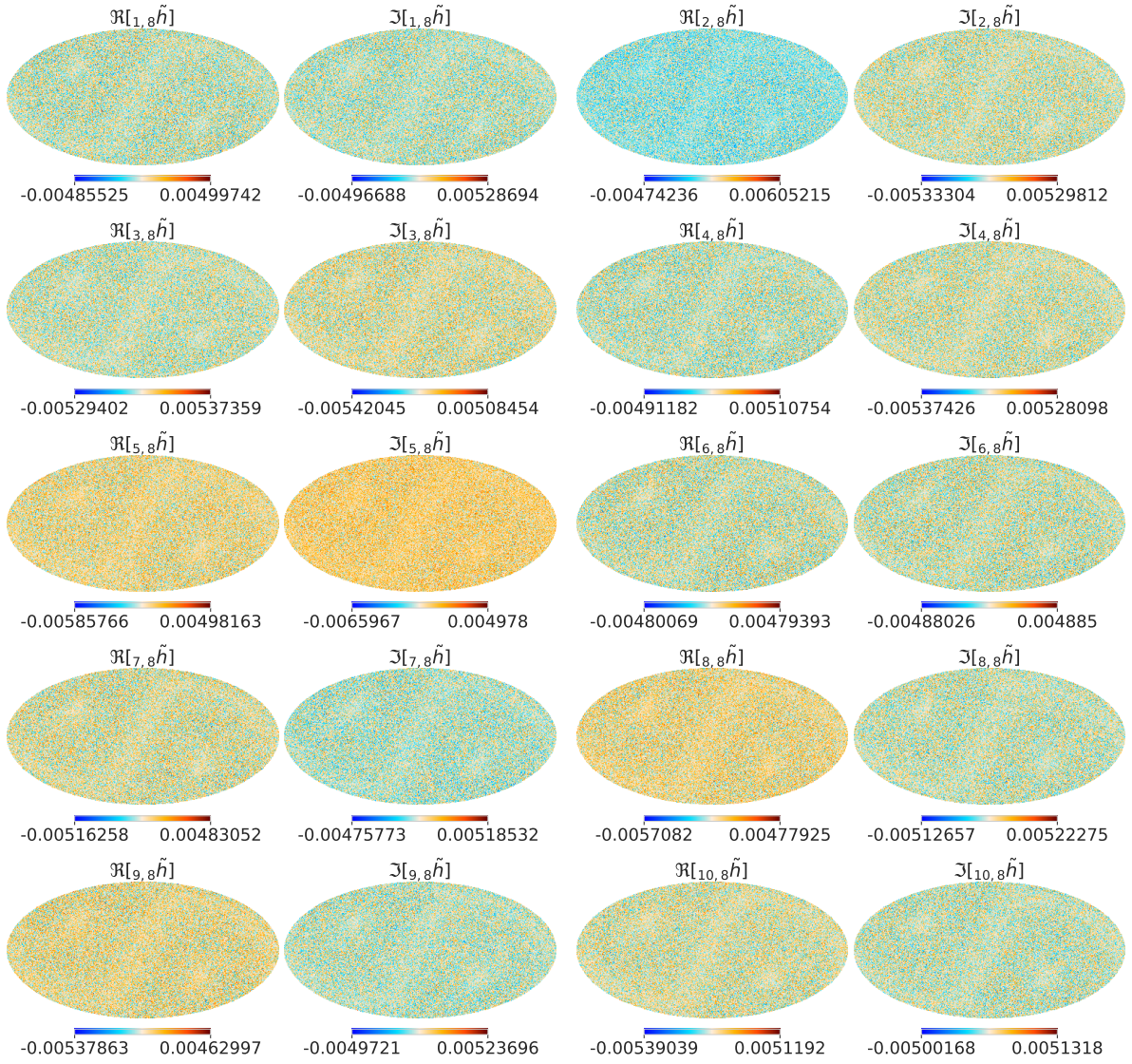
Figure C.3: $Spin-(n, 8)$ cross-link factors for $n = 1$ to 10 .

Bibliography

- [1] A.A. Penzias and R.W. Wilson, *A Measurement of Excess Antenna Temperature at 4080 Mc/s.*, *Astrophysical Journal* **142** (1965) 419.
- [2] G. Gamow, *Expanding Universe and the Origin of Elements*, *Physical Review* **70** (1946) 572.
- [3] R.H. Dicke, P.J.E. Peebles, P.G. Roll and D.T. Wilkinson, *Cosmic Black-Body Radiation.*, *Astrophysical Journal* **142** (1965) 414.
- [4] J.C. Mather, E. Cheng, R. Eplee Jr, R. Isaacman, S. Meyer, R. Shafer et al., *A preliminary measurement of the cosmic microwave background spectrum by the cosmic background explorer (cobe) satellite*, *The Astrophysical Journal* **354** (1990) L37.
- [5] C.L. Bennett, A.J. Banday, K.M. Gorski, G. Hinshaw, P. Jackson, P. Keegstra et al., *Four-Year COBE DMR Cosmic Microwave Background Observations: Maps and Basic Results*, *Astrophysical Journal, Letters* **464** (1996) L1 [[astro-ph/9601067](#)].
- [6] K. Sato, *First-order phase transition of a vacuum and the expansion of the Universe*, *Monthly Notices of the RAS* **195** (1981) 467.
- [7] A.H. Guth, *Inflationary universe: A possible solution to the horizon and flatness problems*, *Physical Review D* **23** (1981) 347.
- [8] D. Kazanas, *Dynamics of the universe and spontaneous symmetry breaking*, *Astrophysical Journal, Letters* **241** (1980) L59.
- [9] M.C. Guzzetti, N. Bartolo, M. Liguori and S. Matarrese, *Gravitational waves from inflation*, *Riv. Nuovo Cim.* **39** (2016) 399 [[1605.01615](#)].
- [10] L.P. Grishchuk, *Amplification of gravitational waves in an isotropic universe.*, *Zhurnal Eksperimentalnoi i Teoreticheskoi Fiziki* **67** (1974) 825.
- [11] U. Seljak, *Measuring Polarization in the Cosmic Microwave Background*, *Astrophysical Journal* **482** (1997) 6 [[astro-ph/9608131](#)].
- [12] M. Zaldarriaga and U. Seljak, *All-sky analysis of polarization in the microwave background*, *Physical Review D* **55** (1997) 1830 [[astro-ph/9609170](#)].
- [13] U. Seljak and M. Zaldarriaga, *Signature of Gravity Waves in the Polarization of the Microwave Background*, *Physical Review Letters* **78** (1997) 2054 [[astro-ph/9609169](#)].

- [14] K.D. Irwin, *An application of electrothermal feedback for high resolution cryogenic particle detection*, *Applied Physics Letters* **66** (1995) 1998.
- [15] The Polarbear Collaboration, J. Errard, P.A.R. Ade, A. Anthony, K. Arnold, F. Aubin et al., *The new generation CMB B-mode polarization experiment: POLARBEAR*, *arXiv e-prints* (2010) arXiv:1011.0763 [1011.0763].
- [16] P.A.R. Ade, Z. Ahmed, M. Amiri, D. Barkats, R.B. Thakur, C.A. Bischoff et al., *Improved Constraints on Primordial Gravitational Waves using Planck, WMAP, and BICEP/Keck Observations through the 2018 Observing Season*, *Physical Review Letters* **127** (2021) 151301 [2110.00483].
- [17] J. Errard, P.A.R. Ade, Y. Akiba, K. Arnold, M. Atlas, C. Baccigalupi et al., *Modeling Atmospheric Emission for CMB Ground-based Observations*, *Astrophysical Journal* **809** (2015) 63 [1501.07911].
- [18] M.E. Thomas, *Infrared- and millimeter-wavelength continuum absorption in the atmospheric windows: measurements and models.*, *Infrared Physics* **30** (1990) 161.
- [19] C.G.R. Wallis, M.L. Brown, R.A. Battye and J. Delabrouille, *Optimal scan strategies for future CMB satellite experiments*, *Monthly Notices of the RAS* **466** (2016) 425 [<https://academic.oup.com/mnras/article-pdf/466/1/425/10864929/stw2577.pdf>].
- [20] N. McCallum, D.B. Thomas, M.L. Brown and N. Tessore, *Spin characterization of systematics in CMB surveys – a comprehensive formalism*, *Monthly Notices of the RAS* **501** (2020) 802 [<https://academic.oup.com/mnras/article-pdf/501/1/802/35077383/staa3609.pdf>].
- [21] LiteBIRD Collaboration, E. Allys, K. Arnold, J. Aumont, R. Aurlien, S. Azzoni et al., *Probing cosmic inflation with the LiteBIRD cosmic microwave background polarization survey*, *Progress of Theoretical and Experimental Physics* **2023** (2023) 042F01.
- [22] Y. Sakurai, T. Matsumura, N. Katayama, K. Komatsu, R. Takaku, S. Sugiyama et al., *Breadboard model of the polarization modulator unit based on a continuously rotating half-wave plate for the low-frequency telescope of the LiteBIRD space mission*, in *Millimeter, Submillimeter, and Far-Infrared Detectors and Instrumentation for Astronomy X*, J. Zmuidzinas and J.-R. Gao, eds., vol. 11453 of *Society of Photo-Optical Instrumentation Engineers (SPIE) Conference Series*, p. 114534E, Dec., 2020, DOI.
- [23] F. Columbro, P. de Bernardis, L. Lamagna, S. Masi, A. Paiella, F. Piacentini et al., *A polarization modulator unit for the mid- and high-frequency telescopes of the LiteBIRD mission*, in *Space Telescopes and Instrumentation 2020: Optical, Infrared, and Millimeter Wave*, M. Lystrup and M.D. Perrin, eds., vol. 11443 of *Society of Photo-Optical Instrumentation Engineers (SPIE) Conference Series*, p. 114436Z, Dec., 2020, DOI.

- [24] A. Kusaka, T. Essinger-Hileman, J.W. Appel, P. Gallardo, K.D. Irwin, N. Jarosik et al., *Publisher's Note: "Modulation of cosmic microwave background polarization with a warm rapidly rotating half-wave plate on the Atacama B-Mode Search instrument"* [*Rev. Sci. Instrum.* **85**, 024501 (2014)], *Review of Scientific Instruments* **85** (2014) 039901 [[1310.3711](#)].
- [25] Y. Takase, L. Vacher, H. Ishino, G. Patanchon, L. Montier, S. Stever et al., *Multi-dimensional optimisation of the scanning strategy for the litebird space mission*, *Journal of Cosmology and Astroparticle Physics* **2024** (2024) 036.
- [26] E. Komatsu, *Cosmic Microwave Background Radiation*, vol. 6 of *New astronomy library*, NIPPON HYORON SHA CO.,LTD., Japan, first ed. (2019).
- [27] H.V. Peiris, E. Komatsu, L. Verde, D. Spergel, C. Bennett, M. Halpern et al., *First-year wilkinson microwave anisotropy probe (wmap)* observations: implications for inflation*, *The Astrophysical Journal Supplement Series* **148** (2003) 213.
- [28] N. Aghanim, Y. Akrami, M. Ashdown, J. Aumont, C. Baccigalupi, M. Ballardini et al., *Planck 2018 results-vi. cosmological parameters*, *Astronomy & Astrophysics* **641** (2020) A6.
- [29] N. Aghanim, Y. Akrami, F. Arroja, M. Ashdown, J. Aumont, C. Baccigalupi et al., *Planck 2018 results-i. overview and the cosmological legacy of planck*, *Astronomy & Astrophysics* **641** (2020) A1.
- [30] C.L. Bennett, A.J. Banday, K.M. Górski, G. Hinshaw, P. Jackson, P. Keegstra et al., *Four-year coBE* dmr cosmic microwave background observations: maps and basic results*, *The Astrophysical Journal Letters* **464** (1996) L1.
- [31] M. Tegmark, A. de Oliveira-Costa and A.J. Hamilton, *High resolution foreground cleaned cmb map from wmap*, *Physical Review D* **68** (2003) 123523.
- [32] R.K. Sachs and A.M. Wolfe, *Perturbations of a Cosmological Model and Angular Variations of the Microwave Background*, *Astrophysical Journal* **147** (1967) 73.
- [33] M. Kamionkowski, A. Kosowsky and A. Stebbins, *Statistics of cosmic microwave background polarization*, *Physical Review D* **55** (1997) 7368 [[astro-ph/9611125](#)].
- [34] A.G. Polnarev, *Polarization and Anisotropy Induced in the Microwave Background by Cosmological Gravitational Waves*, *Soviet Astronomy* **29** (1985) 607.
- [35] W. Hu and M. White, *A CMB polarization primer*, *New Astronomy* **2** (1997) 323 [[astro-ph/9706147](#)].
- [36] J.M. Kovac, E.M. Leitch, C. Pryke, J.E. Carlstrom, N.W. Halverson and W.L. Holzapfel, *Detection of polarization in the cosmic microwave background using DASI*, *Nature* **420** (2002) 772 [[astro-ph/0209478](#)].

- [37] C.-P. Ma and E. Bertschinger, *Cosmological Perturbation Theory in the Synchronous and Conformal Newtonian Gauges*, *Astrophysical Journal* **455** (1995) 7 [[astro-ph/9506072](#)].
- [38] E. Komatsu, *New physics from the polarized light of the cosmic microwave background*, *Nature Reviews Physics* **4** (2022) 452 [[2202.13919](#)].
- [39] M. Kamionkowski and E.D. Kovetz, *The quest for b modes from inflationary gravitational waves*, *Annual Review of Astronomy and Astrophysics* **54** (2016) 227.
- [40] A. Friedmann, *Über die Möglichkeit einer Welt mit konstanter negativer Krümmung des Raumes*, *Zeitschrift für Physik* **21** (1924) 326.
- [41] D.H. Lyth and A. Riotto, *Particle physics models of inflation and the cosmological density perturbation*, *Physics Reports* **314** (1999) 1.
- [42] A.D. Linde, *Chaotic inflation*, *Physics Letters B* **129** (1983) 177.
- [43] K. Freese, J.A. Frieman and A.V. Olinto, *Natural inflation with pseudo - Nambu-Goldstone bosons*, *Phys. Rev. Lett.* **65** (1990) 3233.
- [44] A.A. Starobinsky, *A new type of isotropic cosmological models without singularity*, *Physics Letters B* **91** (1980) 99.
- [45] G. Hinshaw, D. Larson, E. Komatsu, D.N. Spergel, C.L. Bennett, J. Dunkley et al., *Nine-year Wilkinson Microwave Anisotropy Probe (WMAP) Observations: Cosmological Parameter Results*, *Astrophysical Journal, Supplement* **208** (2013) 19 [[1212.5226](#)].
- [46] Planck Collaboration, P.A.R. Ade, N. Aghanim, C. Armitage-Caplan, M. Arnaud, M. Ashdown et al., *Planck 2013 results. XVI. Cosmological parameters*, *Astronomy and Astrophysics* **571** (2014) A16 [[1303.5076](#)].
- [47] A. Achúcarro, M. Biagetti, M. Braglia, G. Cabass, R. Caldwell, E. Castorina et al., *Inflation: Theory and Observations*, *arXiv e-prints* (2022) [arXiv:2203.08128](#) [[2203.08128](#)].
- [48] J.R. Bond, *The theoretical agenda in CMB research.*, in *Microwave Background Anisotropies*, F.R. Bouchet, R. Gispert, B. Guiderdoni and J. Trần Thanh Vân, eds., vol. 16, pp. 15–22, Jan., 1997, DOI [[astro-ph/9610119](#)].
- [49] A. Lewis, A. Challinor and A. Lasenby, *Efficient Computation of Cosmic Microwave Background Anisotropies in Closed Friedmann-Robertson-Walker Models*, *Astrophysical Journal* **538** (2000) 473 [[astro-ph/9911177](#)].
- [50] A. Lewis, *Efficient sampling of fast and slow cosmological parameters*, *Physical Review D* **87** (2013) 103529 [[1304.4473](#)].
- [51] C. Howlett, A. Lewis, A. Hall and A. Challinor, *CMB power spectrum parameter degeneracies in the era of precision cosmology*, *Journal of Cosmology and Astroparticle Physics* **2012** (2012) 027 [[1201.3654](#)].

- [52] P. de Bernardis, P.A.R. Ade, J.J. Bock, J.R. Bond, J. Borrill, A. Boscaleri et al., *A flat Universe from high-resolution maps of the cosmic microwave background radiation*, *Nature* **404** (2000) 955 [[astro-ph/0004404](#)].
- [53] S. Hanany, P. Ade, A. Balbi, J. Bock, J. Borrill, A. Boscaleri et al., *MAXIMA-1: A Measurement of the Cosmic Microwave Background Anisotropy on Angular Scales of $10'$ - 5°* , *Astrophysical Journal, Letters* **545** (2000) L5 [[astro-ph/0005123](#)].
- [54] P.J.E. Peebles and J.T. Yu, *Primeval Adiabatic Perturbation in an Expanding Universe*, *Astrophysical Journal* **162** (1970) 815.
- [55] J.R. Bond and G. Efstathiou, *The statistics of cosmic background radiation fluctuations*, *Monthly Notices of the RAS* **226** (1987) 655.
- [56] J. Silk, *Cosmic black-body radiation and galaxy formation*, *The Astrophysical Journal* **151** (1968) 459.
- [57] W. Hu and M. White, *Acoustic Signatures in the Cosmic Microwave Background*, *Astrophysical Journal* **471** (1996) 30 [[astro-ph/9602019](#)].
- [58] W. Hu and M. White, *CMB anisotropies: Total angular momentum method*, *Physical Review D* **56** (1997) 596 [[astro-ph/9702170](#)].
- [59] R. Allison, P. Caucal, E. Calabrese, J. Dunkley and T. Louis, *Towards a cosmological neutrino mass detection*, *Physical Review D* **92** (2015) 123535 [[1509.07471](#)].
- [60] E. Di Valentino, E. Giusarma, O. Mena, A. Melchiorri and J. Silk, *Cosmological limits on neutrino unknowns versus low redshift priors*, *Physical Review D* **93** (2016) 083527 [[1511.00975](#)].
- [61] E. Giusarma, M. Gerbino, O. Mena, S. Vagnozzi, S. Ho and K. Freese, *Improvement of cosmological neutrino mass bounds*, *Physical Review D* **94** (2016) 083522 [[1605.04320](#)].
- [62] A. Boyle and E. Komatsu, *Deconstructing the neutrino mass constraint from galaxy redshift surveys*, *Journal of Cosmology and Astroparticle Physics* **2018** (2018) 035 [[1712.01857](#)].
- [63] M. Archidiacono, T. Brinckmann, J. Lesgourgues and V. Poulin, *Physical effects involved in the measurements of neutrino masses with future cosmological data*, *Journal of Cosmology and Astroparticle Physics* **2017** (2017) 052 [[1610.09852](#)].
- [64] A. Einstein et al., *Über den einfluß der schwerkraft auf die ausbreitung des lichtes*, *Annalen der Physik* **35** (1911) 898.
- [65] U. Seljak, *Gravitational Lensing Effect on Cosmic Microwave Background Anisotropies: A Power Spectrum Approach*, *Astrophysical Journal* **463** (1996) 1 [[astro-ph/9505109](#)].
- [66] P. Ade, Z. Ahmed, R. Aikin, K.D. Alexander, D. Barkats, S. Benton et al., *Bicep2/keck array viii: Measurement of gravitational lensing from large-scale b-mode polarization*, *The Astrophysical Journal* **833** (2016) 228.

- [67] R. Keisler, C.L. Reichardt, K.A. Aird, B.A. Benson, L.E. Bleem, J.E. Carlstrom et al., *A Measurement of the Damping Tail of the Cosmic Microwave Background Power Spectrum with the South Pole Telescope*, *Astrophysical Journal* **743** (2011) 28 [1105.3182].
- [68] BICEP2 COLLABORATION collaboration, *Detection of b-mode polarization at degree angular scales by bicep2*, *Phys. Rev. Lett.* **112** (2014) 241101.
- [69] N.W. Boggess, J.C. Mather, R. Weiss, C.L. Bennett, E.S. Cheng, E. Dwek et al., *The COBE Mission: Its Design and Performance Two Years after Launch*, *Astrophysical Journal* **397** (1992) 420.
- [70] E.L. Wright, *Scanning and Mapping Strategies for CMB Experiments*, *arXiv e-prints* (1996) astro [astro-ph/9612006].
- [71] C.L. Bennett, M. Bay, M. Halpern, G. Hinshaw, C. Jackson, N. Jarosik et al., *The Microwave Anisotropy Probe Mission*, *Astrophysical Journal* **583** (2003) 1 [astro-ph/0301158].
- [72] X. Dupac and J. Tauber, *Scanning strategy for mapping the Cosmic Microwave Background anisotropies with Planck*, *Astronomy and Astrophysics* **430** (2005) 363 [astro-ph/0409405].
- [73] J. Delabrouille, J.L. Puget, R. Gispert and J.M. Lamarre, *Scanning strategies for the Planck mission*, *arXiv e-prints* (1998) astro [astro-ph/9810478].
- [74] M. Maris, M. Bersanelli, C. Burigana, B. Cappellini, X. Dupac, G. Morgante et al., *The Flexible Planck Scanning Strategy*, *Memorie della Societa Astronomica Italiana Supplementi* **9** (2006) 460.
- [75] Planck Collaboration, Ade, P. A. R., Aghanim, N., Ashdown, M., Aumont, J., Baccigalupi, C. et al., *Planck 2015 results - iv. low frequency instrument beams and window functions*, *Astronomy and Astrophysics* **594** (2016) A4.
- [76] J.A. Tauber, N. Mandolesi, J.L. Puget, T. Banos, M. Bersanelli, F.R. Bouchet et al., *Planck pre-launch status: The Planck mission*, *Astronomy and Astrophysics* **520** (2010) A1.
- [77] Planck Collaboration, P.A.R. Ade, N. Aghanim, M. Arnaud, M. Ashdown, J. Aumont et al., *Planck early results. I. The Planck mission*, *Astronomy and Astrophysics* **536** (2011) A1 [1101.2022].
- [78] J. Bock, A. Aljabri, A. Amblard, D. Baumann, M. Betoule, T. Chui et al., *Study of the experimental probe of inflationary cosmology (epic)-intemediate mission for nasa's einstein inflation probe*, 2009. 10.48550/ARXIV.0906.1188.
- [79] F. Finelli, M. Bucher, A. Achúcarro, M. Ballardini, N. Bartolo, D. Baumann et al., *Exploring cosmic origins with CORE: Inflation*, *Journal of Cosmology and Astroparticle Physics* **2018** (2018) 016 [1612.08270].

- [80] S. Hanany, M. Alvarez, E. Artis, P. Ashton, J. Aumont, R. Aurlien et al., *PICO: Probe of Inflation and Cosmic Origins*, *arXiv e-prints* (2019) arXiv:1902.10541 [1902.10541].
- [81] Y. Sekimoto, P.A.R. Ade, A. Adler, E. Allys, K. Arnold, D. Auguste et al., *Concept design of low frequency telescope for CMB B-mode polarization satellite LiteBIRD*, in *Millimeter, Submillimeter, and Far-Infrared Detectors and Instrumentation for Astronomy X*, J. Zmuidzinas and J.-R. Gao, eds., vol. 11453 of *Society of Photo-Optical Instrumentation Engineers (SPIE) Conference Series*, p. 1145310, Dec., 2020, DOI.
- [82] L. Montier, B. Mot, P. de Bernardis, B. Maffei, G. Pisano, F. Columbro et al., *Overview of the medium and high frequency telescopes of the LiteBIRD space mission*, in *Space Telescopes and Instrumentation 2020: Optical, Infrared, and Millimeter Wave*, M. Lystrup and M.D. Perrin, eds., vol. 11443 of *Society of Photo-Optical Instrumentation Engineers (SPIE) Conference Series*, p. 114432G, Dec., 2020, DOI [2102.00809].
- [83] T. Ghigna, A. Adler, K. Aizawa, H. Akamatsu, R. Akizawa, E. Allys et al., *The LiteBIRD mission to explore cosmic inflation*, in *Space Telescopes and Instrumentation 2024: Optical, Infrared, and Millimeter Wave*, L.E. Coyle, S. Matsuura and M.D. Perrin, eds., vol. 13092, p. 1309228, International Society for Optics and Photonics, SPIE, 2024, DOI.
- [84] P.A.R. Ade, Z. Ahmed, M. Amiri, D. Barkats, R.B. Thakur, C.A. Bischoff et al., *Improved Constraints on Primordial Gravitational Waves using Planck, WMAP, and BICEP/Keck Observations through the 2018 Observing Season*, *Physical Review Letters* **127** (2021) 151301 [2110.00483].
- [85] S. Adachi, M.A.O. Aguilar Faúndez, K. Arnold, C. Baccigalupi, D. Barron, D. Beck et al., *A Measurement of the CMB E-mode Angular Power Spectrum at Subdegree Scales from 670 Square Degrees of POLARBEAR Data*, *Astrophysical Journal* **904** (2020) 65 [2005.06168].
- [86] J.T. Sayre, C.L. Reichardt, J.W. Henning, P.A.R. Ade, A.J. Anderson, J.E. Austermann et al., *Measurements of B -mode polarization of the cosmic microwave background from 500 square degrees of SPTpol data*, *Physical Review D* **101** (2020) 122003 [1910.05748].
- [87] BICEP2 Collaboration, Keck Array Collaboration, P.A.R. Ade, Z. Ahmed, R.W. Aikin, K.D. Alexander et al., *Constraints on Primordial Gravitational Waves Using Planck, WMAP, and New BICEP2/Keck Observations through the 2015 Season*, *Physical Review Letters* **121** (2018) 221301 [1810.05216].
- [88] C.L. Bennett, D. Larson, J.L. Weiland, N. Jarosik, G. Hinshaw, N. Odegard et al., *Nine-year Wilkinson Microwave Anisotropy Probe (WMAP) Observations: Final Maps and Results*, *Astrophysical Journal, Supplement* **208** (2013) 20 [1212.5225].
- [89] POLARBEAR Collaboration, P.A.R. Ade, M. Aguilar, Y. Akiba, K. Arnold, C. Baccigalupi et al., *A Measurement of the Cosmic Microwave Background B-mode*

- Polarization Power Spectrum at Subdegree Scales from Two Years of polarbear Data*, *Astrophysical Journal* **848** (2017) 121 [1705.02907].
- [90] J.W. Henning, J.T. Sayre, C.L. Reichardt, P.A.R. Ade, A.J. Anderson, J.E. Austermann et al., *Measurements of the Temperature and E-mode Polarization of the CMB from 500 Square Degrees of SPTpol Data*, *Astrophysical Journal* **852** (2018) 97 [1707.09353].
- [91] Planck Collaboration, N. Aghanim, Y. Akrami, M. Ashdown, J. Aumont, C. Baccigalupi et al., *Planck 2018 results. V. CMB power spectra and likelihoods*, *Astronomy and Astrophysics* **641** (2020) A5 [1907.12875].
- [92] S.K. Choi, M. Hasselfield, S.-P.P. Ho, B. Koopman, M. Lungu, M.H. Abitbol et al., *The Atacama Cosmology Telescope: a measurement of the Cosmic Microwave Background power spectra at 98 and 150 GHz*, *Journal of Cosmology and Astroparticle Physics* **2020** (2020) 045 [2007.07289].
- [93] N. Galitzki, A. Ali, K.S. Arnold, P.C. Ashton, J.E. Austermann, C. Baccigalupi et al., *The simons observatory: instrument overview*, in *Millimeter, Submillimeter, and Far-Infrared Detectors and Instrumentation for Astronomy IX*, vol. 10708, p. 1070804, International Society for Optics and Photonics, 2018.
- [94] N. McCallum, D.B. Thomas and M.L. Brown, *Fast map-based simulations of systematics in CMB surveys including effects of the scanning strategy*, *Monthly Notices of the RAS* **513** (2022) 3610 [<https://academic.oup.com/mnras/article-pdf/513/3/3610/43687567/stac561.pdf>].
- [95] M.L. Brown, A. Challinor, C.E. North, B.R. Johnson, D. O’Dea and D. Sutton, *Impact of modulation on CMB B-mode polarization experiments*, *Monthly Notices of the RAS* **397** (2009) 634 [0809.4032].
- [96] Planck Collaboration, Adam, R., Ade, P. A. R., Aghanim, N., Arnaud, M., Ashdown, M. et al., *Planck 2015 results - vii. high frequency instrument data processing: Time-ordered information and beams*, *Astronomy and Astrophysics* **594** (2016) A7.
- [97] J. Bock, A. Cooray, S. Hanany, B. Keating, A. Lee, T. Matsumura et al., *The experimental probe of inflationary cosmology (epic): a mission concept study for nasa’s einstein inflation probe*, *arXiv preprint arXiv:0805.4207* (2008) .
- [98] K.M. Górski, E. Hivon, A.J. Banday, B.D. Wandelt, F.K. Hansen, M. Reinecke et al., *HEALPix: A Framework for High-Resolution Discretization and Fast Analysis of Data Distributed on the Sphere*, *Astrophysical Journal* **622** (2005) 759 [astro-ph/0409513].
- [99] Astropy Collaboration, A.M. Price-Whelan, P.L. Lim, N. Earl, N. Starkman, L. Bradley et al., *The Astropy Project: Sustaining and Growing a Community-oriented Open-source Project and the Latest Major Release (v5.0) of the Core Package*, *Astrophysical Journal* **935** (2022) 167 [2206.14220].

- [100] A. Lewis and A. Challinor, “CAMB: Code for Anisotropies in the Microwave Background.” Astrophysics Source Code Library, record ascl:1102.026, Feb., 2011.
- [101] Planck Collaboration, N. Aghanim, Y. Akrami, M. Ashdown, J. Aumont, C. Baccigalupi et al., *Planck 2018 results. VI. Cosmological parameters*, *Astronomy and Astrophysics* **641** (2020) A6 [1807.06209].
- [102] G. Patanchon, H. Imada, H. Ishino and T. Matsumura, *Effect of instrumental polarization with a half-wave plate on the B-mode signal: prediction and correction*, *Journal of Cosmology and Astroparticle Physics* **2024** (2024) 074 [2308.00967].
- [103] Planck Collaboration, P.A.R. Ade, N. Aghanim, C. Armitage-Caplan, M. Arnaud, M. Ashdown et al., *Planck 2013 results. VI. High Frequency Instrument data processing*, *Astronomy and Astrophysics* **571** (2014) A6 [1303.5067].
- [104] K. Odagiri, M. Saijo, K. Shinozaki, F. Matsuda, S. Oguri, T. Suzuki et al., *Cryogenic thermal design and analysis for LiteBIRD payload module*, in *Space Telescopes and Instrumentation 2022: Optical, Infrared, and Millimeter Wave*, L.E. Coyle, S. Matsuura and M.D. Perrin, eds., vol. 12180 of *Society of Photo-Optical Instrumentation Engineers (SPIE) Conference Series*, p. 121801U, Aug., 2022, DOI.
- [105] D.T. Hoang, G. Patanchon, M. Bucher, T. Matsumura, R. Banerji, H. Ishino et al., *Bandpass mismatch error for satellite cmb experiments i: estimating the spurious signal*, *Journal of Cosmology and Astroparticle Physics* **2017** (2017) 015.
- [106] M.V. Berry, *Regular and irregular motion*, *AIP Conference Proceedings* **46** (1978) 16 [https://pubs.aip.org/aip/acp/article-pdf/46/1/16/11659773/16_1_online.pdf].
- [107] J.A. Tauber, N. Mandolesi, J.L. Puget, T. Banos, M. Bersanelli, F.R. Bouchet et al., *Planck pre-launch status: The Planck mission*, *Astronomy and Astrophysics* **520** (2010) A1.
- [108] C. Leloup, G. Patanchon, J. Errard, C. Franceschet, J.E. Gudmundsson, S. Henrot-Versillé et al., *Impact of beam far side-lobe knowledge in the presence of foregrounds for LiteBIRD*, *Journal of Cosmology and Astroparticle Physics* **2024** (2024) 011 [2312.09001].
- [109] J.M. Delouis, J.L. Puget and L. Vibert, *Improved large-scale interstellar dust foreground model and CMB solar dipole measurement*, *Astronomy and Astrophysics* **650** (2021) A82 [2102.10004].
- [110] Bicep2 Collaboration, P.A.R. Ade, R.W. Aikin, D. Barkats, S.J. Benton, C.A. Bischoff et al., *Bicep2 III: Instrumental Systematics*, *Astrophysical Journal* **814** (2015) 110 [1502.00608].
- [111] G. Savini, G. Pisano and P.A.R. Ade, *Achromatic half-wave plate for submillimeter instruments in cosmic microwave background astronomy: modeling and simulation*, *Appl. Opt.* **45** (2006) 8907.

- [112] L. Moncelsi, P.A.R. Ade, F.E. Angilè, S.J. Benton, M.J. Devlin, L.M. Fissel et al., *Empirical modelling of the BLASTPol achromatic half-wave plate for precision submillimetre polarimetry*, *Monthly Notices of the RAS* **437** (2013) 2772 [<https://academic.oup.com/mnras/article-pdf/437/3/2772/18466207/stt2090.pdf>].
- [113] T. Essinger-Hileman, A. Kusaka, J.W. Appel, S.K. Choi, K. Crowley, S.P. Ho et al., *Systematic effects from an ambient-temperature, continuously rotating half-wave plate*, *Review of Scientific Instruments* **87** (2016) 094503 [https://pubs.aip.org/aip/rsi/article-pdf/doi/10.1063/1.4962023/15759977/094503_1_online.pdf].
- [114] H. Imada, T. Matsumura, R. Takaku, G. Patanchon, H. Ishino, Y. Sakurai et al., *Instrumentally induced spurious polarization of a multi-layer half wave plate for a cmb polarization observation*, in *Proc. Twenty-Ninth Int. Symp. Space Terahertz Technol.*, 2018.
- [115] W. Hu, M.M. Hedman and M. Zaldarriaga, *Benchmark parameters for CMB polarization experiments*, *Physical Review D* **67** (2003) 043004 [[astro-ph/0210096](https://arxiv.org/abs/astro-ph/0210096)].
- [116] J.M. Delouis, J.L. Puget and L. Vibert, *Improved large-scale interstellar dust foreground model and CMB solar dipole measurement*, *Astronomy and Astrophysics* **650** (2021) A82 [[2102.10004](https://arxiv.org/abs/2102.10004)].
- [117] S. Hamimeche and A. Lewis, *Likelihood analysis of CMB temperature and polarization power spectra*, *Physical Review D* **77** (2008) 103013 [[0801.0554](https://arxiv.org/abs/0801.0554)].
- [118] K.M. Gorski, B.D. Wandelt, F.K. Hansen, E. Hivon and A.J. Banday, *The healpix primer*, *arXiv preprint astro-ph/9905275* (1999) .
- [119] J. Bezanson, A. Edelman, S. Karpinski and V.B. Shah, *Julia: A fresh approach to numerical computing*, *SIAM Review* **59** (2017) 65.

Acknowledgments

I would like to express my heartfelt gratitude to all those who have supported me in writing this doctoral thesis.

First and foremost, I owe my deepest appreciation to my supervisor, Hirokazu Ishino. Over the course of six years, spanning my undergraduate, master's, and doctoral studies, he has guided me and imparted invaluable knowledge. In the beginning, I struggled immensely with both cosmology and simulations, but thanks to his supervisions, I was able to complete my doctoral dissertation. His passionate mentorship and unwavering support have been the cornerstone of my academic journey.

Next, I extend my gratitude to Yuya Nagano, Léo Vacher, and Samantha Stever, who have always been by my side throughout my research life. Coding together in the lab and sharing laughs over jokes are memories I cherish deeply. Without their companionship, I would not have made it this far.

I am also grateful to Guillaume Patanchon, Tomotake Matsumura, Yuki Sakurai, Tommaso Ghigna, Ludovic Montier, Wang Wang, Jonathan Aumont (He kindly created my `Falcons.jl` logo which is shown in figure C.4), Koki Ishizaka, and Eiichiro Komatsu for their invaluable advice throughout my research. Meeting them has been a stroke of luck, and their guidance has been instrumental in advancing my studies.

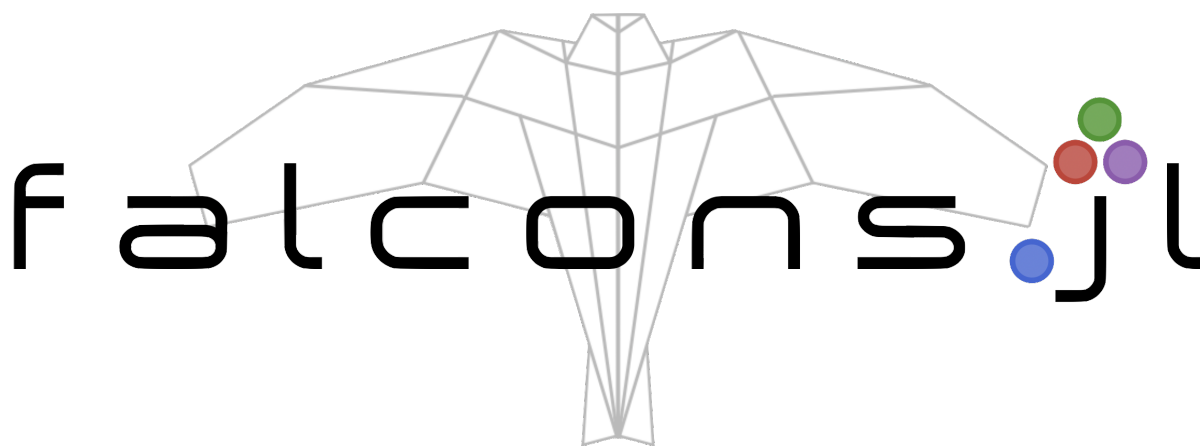

Figure C.4: The `Falcons.jl` logo was designed by Jonathan Aumont. The motif is based on Japanese origami, and the `Julia` extension — ‘.jl’ has the same coloring as the four colored dots in the logo of the `Julia` language itself [119]. The author is very pleased with this sophisticated design.

To my esteemed Italian friends, Marco Bortolami and Nicolò Raffuzzi, I extend my heartfelt thanks. Our collaborative research has been incredibly stimulating, and discussing technical topics like pointing systematics and MPI, as well as Italian culture, has been a delightful experience. Avinash Anand, who helped me when I suffered from dehydration during an face-to-face meeting on Elba Island, is a lifesaver. Without him, I might not be here today. I am deeply grateful to him and all the *LiteBIRD* collaborators who supported me during that time.

I also wish to thank my friends in the lab and collaboration, Kunimoto Komatsu, Naoya Doi, Kazuya Kazahaya, Ryota Uematsu, Serika Tsukatsune, Mami Morinaga, Kiyoshi Ikuma, Ryuji Omae, Mitsuhiro Higuchi, Shunsuke Okumura, Kento Kakinoki, Kosuke Aizawa and Ryosuke Akizawa. The discussions and enjoyable times we shared in the lab have been invaluable to me.

The greatest fortune in my research career has been encountering the fascinating subject of CMB and becoming a member of the *LiteBIRD* collaboration. I am deeply grateful to the *LiteBIRD* collaboration for nurturing me into a cosmologist.

Finally, I would like to express my gratitude to my family and my wife Asuka, who have always supported and encouraged my research life from afar.