

The UKIRT Infrared Deep Sky Survey (UKIDSS)

A.Lawrence¹, S.J.Warren², O.Almaini³, A.C.Edge⁴, N.C.Hambly¹,
 R.F.Jameson⁵, P.Lucas⁶, M.Casali⁷, A.Adamson⁸, S.Dye⁹, J.P.Emerson¹⁰,
 S.Foucaud³, P.Hewett¹¹, P.Hirst⁸, S.T.Hodgkin¹¹, M.J.Irwin¹¹,
 N.Lodieu⁵, R.G.McMahon¹¹, C.Simpson^{12,13}, I.Smail⁴, D.Mortlock², M.Folger⁷

¹*Institute for Astronomy, SUPA (Scottish Universities Physics Alliance), University of Edinburgh, Royal Observatory, Blackford Hill, Edinburgh EH9 3HJ*

²*Blackett Laboratory, Imperial College of Science Technology and Medicine, Prince Consort Rd, London SW7 2AZ*

³*School of Physics and Astronomy, University of Nottingham, University Park, Nottingham NG7 2RD*

⁴*Institute for Computational Cosmology, Durham University, South Road, Durham DH1 3LE*

⁵*Department of Physics and Astronomy, University of Leicester, Leicester LE1 7RH*

⁶*Centre for Astrophysics Research, Science and Technology Research Institute, University of Hertfordshire, Hatfield, AL10 9AB*

⁷*UK Astronomy Technology Centre, Royal Observatory, Blackford Hill, Edinburgh EH9 3HJ*

⁸*Joint Astronomy Centre, 660 N. A'ohuku Place, Hilo, Hawaii 96720, U.S.A.*

⁹*School of Physics and Astronomy, Cardiff University, 5 The Parade, Cardiff, CF24 3YB*

¹⁰*Astronomy Unit, School of Mathematical Sciences, Queen Mary University of London, Mile End Road, London E1 4NS*

¹¹*Institute of Astronomy, University of Cambridge, Madingley Road, Cambridge CB3 0HA*

¹²*Department of Physics, Durham University, South Road, Durham DH1 3LE*

¹³*Astrophysics Research Institute, Liverpool John Moores University, Twelve Quays House, Egerton Wharf, Birkenhead CH41 1LD*

Accepted 2007 May 29. Received 2007 May 28 ; in original form 2006 April 7

ABSTRACT

We describe the goals, design, implementation, and initial progress of the UKIRT Infrared Deep Sky Survey (UKIDSS), a seven year sky survey which began in May 2005. UKIDSS is being carried out using the UKIRT Wide Field Camera (WFCAM), which has the largest *étendue* of any IR astronomical instrument to date. It is a portfolio of five survey components covering various combinations of the filter set ZYJHK and H₂. The Large Area Survey, the Galactic Clusters Survey, and the Galactic Plane Survey cover approximately 7000 square degrees to a depth of K~18; the Deep Extragalactic Survey covers 35 square degrees to K~21, and the Ultra Deep Survey covers 0.77 square degrees to K~23. Summed together UKIDSS is 12 times larger in effective volume than the 2MASS survey. The prime aim of UKIDSS is to provide a long term astronomical legacy database; the design is however driven by a series of specific goals – for example to find the nearest and faintest sub-stellar objects; to discover Population II brown dwarfs, if they exist; to determine the sub-stellar mass function; to break the z=7 quasar barrier; to determine the epoch of re-ionisation; to measure the growth of structure from z=3 to the present day; to determine the epoch of spheroid formation; and to map the Milky Way through the dust, to several kpc. The survey data are being uniformly processed. Images and catalogues are being made available through a fully queryable user interface - the WFCAM Science Archive (WSA : <http://surveys.roe.ac.uk/wsa>). The data are being released in stages. The data are immediately public to astronomers in all ESO member states, and available to the world after eighteen months. Before the formal survey began, UKIRT and the UKIDSS consortium collaborated in obtaining and analysing a series of small science verification (SV) projects to complete the commissioning of the camera. We show some results from these SV projects in order to demonstrate the likely power of the eventual complete survey. Finally, using the data from the First Data Release we assess how well UKIDSS is meeting its design targets so far.

Key words: surveys, infrared: general

1 INTRODUCTION

The UKIRT Infrared Deep Sky Survey (UKIDSS) can be considered the near-infrared counterpart of the Sloan Digital Sky Survey (SDSS; York *et al.* 2000). It does not cover the whole sky, but is many times deeper than the Two Micron All Sky Survey (2MASS; Skrutskie *et al.* 2006). It is in fact not a single survey but a survey programme combining a set of five survey components of complementary combinations of depth and area, covering several thousand square degrees to $K \sim 18$, 35 square degrees to $K \sim 21$, and 0.77 square degrees to $K \sim 23$. The survey uses the Wide Field Camera (WFCAM) on the 3.8m United Kingdom Infra-red Telescope (UKIRT). WFCAM has an instantaneous field of view of 0.21 square degrees, considerably larger than any previous IR camera on a 4m class telescope, along with a pixel size of $0.4''$. The tip-tilt system on UKIRT delivers close to natural seeing (median size $0.6''$) across the whole field of view. The combination of large telescope, large field of view, and good image quality, makes possible a survey of considerably greater scope than 2MASS. The various surveys employ up to five filters *ZYJHK* covering the wavelength range $0.83\text{--}2.37\ \mu\text{m}$ and extend over both high and low Galactic latitudes. The survey began on 2005 May 13, and is expected to take seven years to complete. The survey is being carried out by a private consortium but is fully public with no proprietary rights for the consortium. Data products are being released in stages, with the intention of having these roughly twice a year.

1.1 Origins and nature of project

The UKIDSS survey concept first emerged in 1998 while making the funding case for the WFCAM instrument itself, but eventually became a formal referendum proposal to the UKIRT Board in March 2001, submitted by a consortium of 61 UK astronomers. This included a commitment to making data available immediately to all UK astronomers (not just consortium members), plus specified individual Japanese consortium members, and available to the world after a year or two. (See section 7.4 for the final data release policy.) Later, during the UK's entry in to ESO, it was agreed that astronomers in all ESO member states would have the same data rights as UK astronomers, and at the same time, membership of the consortium was extended to any interested European astronomers. Consortium membership now stands at 130. Note that individual astronomers are members, not their institutions.

The project is unusual compared to previous large survey projects, being neither private, nor conducted by a public body on behalf of the community. UKIDSS relies on the separate existence of three things. (i) The UKIRT observatory, operated as part of the UK's Joint Astronomy Centre (JAC). (ii) The

WFCAM instrument, built at the Astronomy Technology Centre (ATC) at the Royal Observatory Edinburgh, as a funded PPARC project. Note that WFCAM was built as a common user instrument to be part of the UKIRT suite of instruments. The UKIDSS consortium is essentially the largest single user. (iii) The pipeline and archive development project, run by the Cambridge Astronomy Survey Unit (CASU) and the Edinburgh Wide Field Astronomy Unit (WFAU), and funded by several different PPARC grants. This data processing development is part of the VISTA Data Flow System (VDFS) project, with the WFCAM pipeline and archive being seen as an intermediate step. Note this data processing project deals with all WFCAM data, not just the UKIDSS data.

The consortium has no data privileges, and does not plan the scientific exploitation of the survey; its purpose is to make the survey happen, on behalf of the ESO community. The aim of the UKIDSS consortium is then to produce the scientific design for the survey; to win the telescope time necessary; to plan the implementation of the survey, liaising with the other bodies above; to staff the observing implementation; to define the necessary Quality Control (QC) filtering stages to produce final survey products; to assist the data processing team as necessary in producing stacked and merged survey products; and finally to document the production of the survey data in scientific publications and other technical papers. A number of individuals in ATC, JAC, CASU and WFAU are also members of UKIDSS, so that the liaison with the camera construction and data processing projects, as well as telescope operations, has been well motivated. A clear relationship with UKIDSS has been built into each of these projects. For example the science requirements document for the pipeline and archive emerged from consultation with UKIDSS; and the commissioning schedule for WFCAM include a "science verification (SV)" phase following standard tests, in which the survey implementation described in section 3 could be tested and refined.

1.2 Technical reference papers

This paper is one of a set of five which provide the reference technical documentation for UKIDSS. It summarises the scope, goals, and overall design of the survey, along with a brief discussion of implementation methods, progress to date, and presentation of early "science verification" data. The other four papers, described briefly below, are Casali *et al.* (2007), Hewett *et al.* (2006), Irwin *et al.* (in preparation) and Hambly *et al.* (in preparation). In addition to these five core reference papers, each data release will be accompanied by a paper detailing its contents and implementation information. The first two of these are Dye *et al.* (2006) for the "Early Data Release (EDR)",

and Warren *et al.* (2007) for the “First Data Release” (DR1).

Casali *et al.* (2007) describe the survey instrument, WFCAM. A short summary is given in section 3. At the time of commissioning, 2004 November, the instrument *étendue*¹ of 2.38 m² deg² was the largest of any near-infrared imager in the world. The Canada France Hawaii Telescope WIRCAM instrument (Puget *et al.* 2004) covers a solid angle of 0.1 deg² per exposure giving an *étendue* of 1.11 m² deg². WFCAM is likely to remain as the near-infrared imager with the largest *étendue* in the world until completion of the near-infrared camera for VISTA (Dalton *et al.* 2004).

The data flow system for WFCAM is described by Irwin *et al.* (in preparation) and Hambly *et al.* (in preparation). A summary is given in section 5. The very high data rate (1TB per week) requires a highly automated processing system that removes instrumental signature, produces object catalogues, and ingests into a fully queryable WFCAM Science Archive (WSA). It is expected that nearly all science analysis of UKIDSS will be initiated through the WSA.

The photometric system is described in Hewett *et al.* (2006). The survey uses five broadband filters, *ZYJHK*. The *JHK* passbands are as close as possible to the MKO system; the *Z* passband is similar to the SDSS *z'* passband, but has a cleaner red tail. The *Y* passband is a new one centred at 0.97 μm , which bridges the gap between *Z* and *J*. The exact passband was designed with the aim of discriminating between high-redshift quasars and brown dwarfs.

Hewett *et al.* present the measured passband transmissions, and use synthetic colours of various classes of astronomical object to produce expected colour equations between certain WFCAM, SDSS, and 2MASS filters. Table 1 provides summary information on the *ZYJHK* passbands. A later paper (Hodgkin *et al.* in preparation) will report on the photometric calibration of the UKIDSS survey and colour equations determined on the sky from standard star observations.

1.3 Plan of paper

This paper begins with a description of the science goals of UKIDSS, and some illustrations of how the survey design will achieve them. We then describe the practical implementation of the survey - the tiling and jittering patterns, exposure times, calibration plan, and so on, in the context of the camera properties and the UKIRT operating procedures and software. Next we consider the detailed design of the individual survey components - areas, field selection, filters and scheduling. We also describe the staging of UKIDSS

Table 1. WFCAM passbands used for UKIDSS. Columns show the name, the effective wavelength, (Schneider, Gunn & Hoessel, 1983), the short and long wavelength limits, and the width, i.e. the difference between these two wavelengths. The wavelength limits are set by the total system transmission, and defined as 50% transmission relative to the peak. Complete transmission functions are shown in Hewett *et al.* (2006).

band	λ_{eff} μm	range μm	width μm
<i>Z</i>	0.8817	0.836–0.929	0.093
<i>Y</i>	1.0305	0.979–1.081	0.102
<i>J</i>	1.2483	1.169–1.328	0.159
<i>H</i>	1.6313	1.492–1.784	0.292
<i>K</i>	2.2010	2.029–2.380	0.351

in a two year plan and final seven year plan. We then summarise the data processing arrangements, which as described above are pursued as a formally separate project, but which of course are crucial to the scientific success of UKIDSS. Following this we present some example data and simple analysis from the science verification phase of UKIDSS, and point towards the expected final data quality. Finally we summarise progress to date, including an analysis of how well UKIDSS is meeting its design targets, describe the plan for publication of the data, and provide links to more detailed information about UKIDSS, WFCAM, and the science archive.

2 SCIENCE GOALS

2.1 General goals

The primary goal of UKIDSS is to produce IR sky atlases and catalogs as a fundamental resource of lasting significance analogous to the various Schmidt photographic sky surveys of the 1970s and onwards (Hambly *et al.* 2001 and references therein), and to the SDSS survey of modern times (York *et al.* 2000). None of our survey components covers the whole sky, but none the less each component deserves the term “atlas”, as the volume surveyed, and the number of objects detected are comparable to the above optical surveys, and each survey maps out some significant part of the universe - the solar neighbourhood, the Milky Way, the local extragalactic universe, the universe at $z=1$, and the universe at $z=3$. Each of the component surveys is many times larger than any existing IR survey at comparable depth.

The strength of a survey is of course its potential for multiple use over many years, but this general aim does not fix the best combination of area, depth, and wavelength coverage. In a Euclidean volume, for a given total time, a shallow survey always produces a larger sample size than a deep one; but specific science goals often require a given depth, for example to detect galaxies at a given redshift; and for relatively

¹ product of telescope collecting area, and solid angle of instrument field of view, sometimes called *grasp*

Survey Name <i>Notes</i>	Passbands	Depth K mag	Area sq.deg	Seeing FWHM arcsec	Phot RMS mag	Astrom RMS arcsec	Ellipticity
Large Area Survey (LAS) <i>Matched to SDSS areas</i>	YJHK	18.2	4028	<1.2	<0.02	<0.1	<0.25
Deep Extragalactic Survey (DXS) <i>Four multiwavelength fields</i>	JK	20.8	35	<1.3	<0.02	<0.1	<0.25
Ultra Deep Survey (UDS) <i>Subaru/XMM Deep Survey Field</i>	JHK	22.8	0.77	<0.8	<0.02	<0.1	<0.25
Galactic Plane Survey (GPS) <i>Northern Plane, $b < 5^\circ$</i>	JHK	18.8	1868	<1.0	<0.02	<0.1	<0.25
Galactic Clusters Survey (GCS) <i>Ten large open clusters</i>	ZYJHK	18.6	1067	<1.2	<0.02	<0.1	<0.25

Table 2. General design of each component of UKIDSS. These are the planned survey goals as originally approved by the UKIRT Board, together with survey quality parameters applied during preparation for the First Data Release. The final areas and depths will depend on a variety of factors including survey efficiency and UKIRT time allocation.

deep surveys, neither the Milky Way nor the universe at large are Euclidean volumes. As we cannot predict all future uses of the UKIDSS survey databases, the general idea is to pursue a “wedding cake” strategy, dividing the time between a large shallow survey, a medium sized fairly deep survey, and a small very deep survey, and including targeted observations of the Galactic Plane and nearby clusters.

The general features of the five planned survey components are described in Table 2. (More details are given in section 4 and in the data release papers, Dye *et al.* (2006) and Warren *et al.* (2007a,b)). The intention is to achieve uniformity of depth across each survey.² Separate limits apply in each band of course. The photometric and astrometric accuracy goals are requirements set by the UKIDSS consortium on the VDFS data processing system. They are maximum absolute errors, and so include any non-uniformity across the survey. Seeing and ellipticity ‘goals’ in the table are a simplified version of the cuts that have been applied in quality control filtering during preparation for the first data release; the actual cuts vary between bands, and the great majority of dataframes easily pass these cuts.

In the following subsections we summarise the scientific goals of each survey component, and overall survey quality goals. In section 4 we describe the design of each survey component - areas, depths, field locations, filters, implementation strategy - needed to achieve those goals. In section 7 we summarise the progress so far towards the design goals, and the actual achieved quality.

The scope of the surveys is illustrated in an interesting way in Fig. 1. For sky limited observations in the K-band, one can show that for a uniform source population in Euclidean space, the effective volume surveyed is proportional to the quan-

tity $\text{Area} \times 10^{0.6K}$. On the other hand, the time to reach depth K is proportional to $10^{0.8K}$. So, as one surveys the same area deeper, the effective volume increases slowly, but the overall information gained (for example on colours of brighter sources) increases somewhat faster. For fixed observing conditions, the quantity $10^{0.8K}$ is proportional to $\text{etendue} \times \text{instrument throughput} \times \text{time spent}$, which we can think of as overall ‘effective survey resource’. The largest existing multiband near-IR survey in terms of both quantities is 2MASS. In Fig. 1 we have normalised the computed values for each of the five UKIDSS elements, to the 2MASS values using the 2MASS limit of $K=15.50$ (Skrutskie *et al.* 2006). Viewed in this way, each of the 5 K-band surveys is between 10 and 30 times larger than 2MASS in terms of resource, and, except for the UDS, is a few times larger in volume. Summed over the whole programme, UKIDSS is 70 times larger than 2MASS in terms of resource, and 12 times larger in terms of volume.

In practice, achieving the science goals of UKIDSS will depend not just on the depths and areas achieved, but also on the survey quality - completeness, reliability, number of artefacts and so on. These issues are discussed in section 5, with some preliminary results given in section 7.

2.2 Headline science goals

To develop a plan beyond this very general concept, we encouraged the formation of groupings within the consortium to promote distinct survey components and science goals. The whole consortium then debated the science goals and designs proposed by these groups, looked for overlaps, and made compromises until we felt we had a balanced strategy. (The resulting survey component designs are presented in Section 4.) As part of this scientific debate, we also agreed *headline science goals*, which were used to drive the specific designs of the survey components.

² The depths quoted in this table and elsewhere are magnitudes in the Vega system for a point source which attains a 5σ detection within a $2''$ aperture.

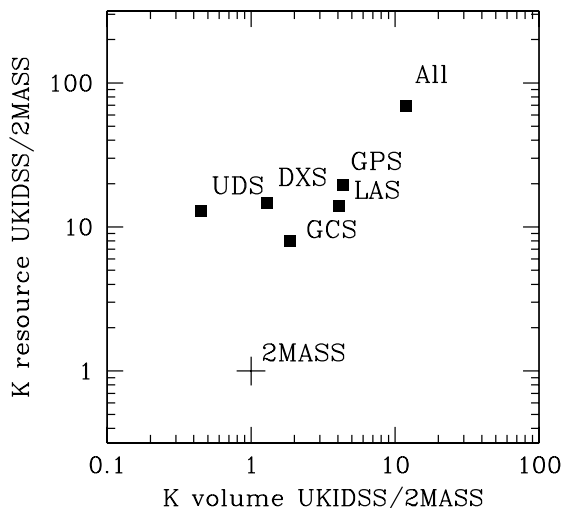

Figure 1. Illustration of the scope of the five UKIDSS survey components, and their sum, by comparison with 2MASS. The comparison is made in terms of effective volume, and effective resource, for the K band, computed as described in the text

The most important of these specific goals are as follows :

- to find the nearest and faintest sub-stellar objects
- to discover Pop II brown dwarfs, if they exist
- to determine the substellar mass function
- to break the $z=7$ quasar barrier
- to determine the epoch of re-ionisation
- to construct a galaxy catalogue at $z=1$ as large as the SDSS catalogue
 - to measure the growth of structure and bias from $z=3$ to the present day
 - to determine the epoch of spheroid formation
 - to clarify the relationship between quasars, ULIRGs, and galaxy formation
- to map the Milky Way through the dust, to several kpc
- to increase the number of known Young Stellar Objects by an order of magnitude, including rare types such as FU Orionis stars

2.3 Goals of the Large Area Survey (LAS)

The Large Area Survey (LAS) aims to map as large a fraction of the Northern Sky as feasible (4000 square degrees) within a few hundred nights, which when combined with the SDSS, produces an atlas covering almost an order of magnitude in wavelength. Furthermore a huge number of objects will already have spectroscopic data from the SDSS project. The target depths of the basic shallow survey are $Y=20.3$, $J=19.5$, $H=18.6$, $K=18.2$. We also plan a second pass

in the J-band, with an average epoch separation of 3.5 years, and a minimum separation of 2 years, to detect proper motions of low mass objects and thus their kinematic distances. The final J depth target is therefore $J=19.9$. (The final achieved depth may of course be different; this is discussed in 7.)

The Large Area Survey, when combined with the matching SDSS data, will produce a catalogue of a half a million galaxies with colours and spectra, and several million galaxies with photometric redshifts; will detect thousands of rich clusters out to $z=1$; will find ten times more brown dwarfs than 2MASS, will probe to much fainter objects, and can get statistical ages and masses from kinematics; and will produce a complete sample of 10,000 bright quasars, including reddened quasars, using the K excess method (Warren, Hewett and Foltz 2000).

We are particularly driven however by three especially exciting prospects. (i) A search for the nearest and smallest objects in the solar neighbourhood. The LAS is deep enough to detect brown dwarfs and young (< 5 Myr) free floating planets with as little as 5 Jupiter masses out to distances of tens of parsecs. The LAS should find brown dwarfs even cooler than T dwarfs, $T_e < 700\text{K}$, a new spectral class tentatively named Y dwarfs (Leggett *et al.* 2005). (ii) The combination of IR and optical colours, and large expected proper motions, will allow the LAS to find halo brown dwarfs if they exist, testing the universality of star formation processes, and the formation history of the Milky Way. (Calculations based on Burrows *et al.* (2003) indicate that halo brown dwarfs will have an absolute Y magnitude > 16 and so could be found to distances of 60pc.) (iii) We hope to find quasars at $z = 7$ and to detect the epoch of re-ionisation. SDSS have found $z=5-6$ quasars by ‘i’ drop-out’. Beyond $z=6$ quasars become rapidly redder, indistinguishable from brown dwarfs in standard colours, and too faint to be in the SDSS z' survey. We therefore intend to undertake a survey in the new Y filter to match our JHK survey. Extrapolating the evolution function of Fan *et al.* 2001 to predict quasar numbers detected in both Y and J to 10σ , the LAS should find 10 quasars in the range $z=6-7$ and 4 in the range $z=7-8$. Figure 2 illustrates how the UKIDSS filter set can distinguish cleanly between very cool brown dwarfs and very high redshift quasars.

2.4 Goals of the Galactic Plane Survey (GPS)

The Galactic Plane Survey aims to map half of the Milky Way to within a latitude of $\pm 5^\circ$. Given the declination constraints of UKIRT, we can survey $l=15^\circ-107^\circ$ and $l=141^\circ-230^\circ$. Owing to interest in recent results from multi-waveband observations of the Galactic Centre region (eg. Wang *et al.* 2002; Hasegawa *et al.* 1998) the survey region has been extended south to include the $l=-2^\circ$ to 15° region in a narrow strip

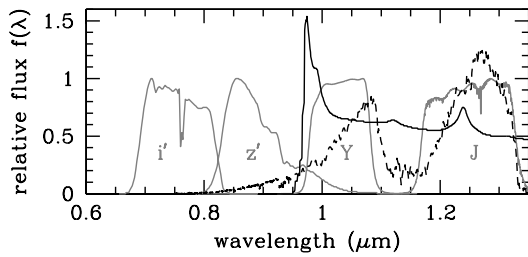

Figure 2. Plot illustrating the usefulness of the Y band for finding cool brown dwarfs and quasars of very-high redshift ($z > 6.4$). Filter curves are total system throughput (above atmosphere to detector), normalised to the peak, for the SDSS i' and z' bands (from Fan et al. 2001), and the WFCAM Y and J bands (from Hewett et al. 2006). The dashed curve is the spectrum of the T6 brown dwarf SDSS J162414.37+002915.6 (from Leggett et al. 2000), and the solid curve is a model spectrum of a quasar at $z=7$. High-redshift quasars and brown dwarfs may be identified by the very sharp spectral discontinuity in moving from the optical (i' , z') to the near-infrared (Y, J), while the quasars may be distinguished from the brown dwarfs, because they are somewhat bluer in Y-J colour.

at $b = \pm 2^\circ$. The target depths are J=19.9, H=19.0, K=18.8, with the K depth made up of three separate epochs with a depth of K=18.2 each time.³ This is deep enough to probe the IMF down to $M \sim 0.05 M_\odot$ in star formation regions within 2 kpc of the sun, to detect stars below the main sequence turn off in the galactic bulge, and to detect luminous objects such as OB stars and post-AGB stars across the whole galaxy. The K band repeats are for both extra depth and to detect highly variable objects and locate nearby objects through their proper motions. In addition we will make a three epoch narrow band H₂ survey in a 300 square degree area of the Taurus-Auriga-Perseus molecular cloud complex (with JHK data also). This survey area closely follows the region of molecular emission detected by Ungerechts & Thaddeus (1987).

Like the high latitude LAS, the GPS has its prime importance as a fundamental resource for future astronomy. The survey depths are close to being confusion limited, so this survey is unlikely to be superseded until a high resolution wide angle camera is placed in space. We expect to detect several times 10^9 sources in total. However, there are a number of immediately expected results, which will be achieved in combination with data from multiwaveband galactic surveys from many facilities. There will be particular benefit from surveys planned or in progress with the

³ These depths refer to uncrowded regions well away from the Galactic Centre and a few degrees out of the plane. In crowded regions the survey will be less deep, due to added background noise from unresolved stars (see section 6.2)

Isaac Newton Telescope (optical), SPITZER space telescope (infrared), CHANDRA and XMM-Newton (X-ray), the VLA (radio, especially the 5 GHz CORNISH survey), HERSCHEL and SCUBA-2 (submm) and AKARI (far infrared). The following list illustrates some of the expected results. (1) An increase in the number of known Young Stellar Objects (YSOs) by an order of magnitude and measurement of the duration of the YSO phase as a function of mass and environment. (2) Star formation regions will be mapped throughout the Milky Way, measuring the environmental dependence of the IMF to low masses and estimating the overall star formation rate of the galaxy. (3) Rare or brief duration variables will be found in significant numbers, aiding the study of phenomena such as FU Orionis variables, Luminous Blue Variables and unstable post-AGB stars undergoing thermonuclear pulsations. (4) Thousands of evolved objects such as protoplanetary nebulae and planetary nebulae will be found, a huge increase over previous samples. This will be achieved by selecting candidates from far IR surveys such as the Akari (ASTRO-F) survey. New detections are expected to be commonest for small protoplanetary nebulae and very large low surface brightness planetary nebulae, which would respectively be unresolved or undetected by 2MASS. (5) Many stellar populations will be mapped to large distances through the Milky Way extinction, measuring the scale height versus stellar type and mapping poorly measured regions of the arms and warp. (6) The IR counterparts of hundreds of X-ray binaries, thousands of CVs, and thousands of coronally active stars will be identified and source lists provided for regions yet to be mapped by X-ray satellites.

2.5 Goals of the Galactic Clusters Survey (GCS)

The Galactic Clusters Survey (GCS) aims to survey ten large open star clusters and star formation associations, covering a total of 1067 sq.deg. using the standard single pass depth (see section 3.2) plus a second pass in K for proper motions, giving a depth of Z=20.4, Y=20.3, J=19.5, H=18.6, K=18.6. The targets are all relatively nearby, are at intermediate to low Galactic latitudes and are several degrees across.

The GCS is the most targeted of our surveys, being aimed at the crucial question of the sub-stellar initial mass function (IMF). Our current knowledge of the IMF is illustrated in Fig. 3, by comparing measurements of the Pleiades with various functional forms. (Note that determining whether the Pleiades is typical or not is part of the goals of the survey). The stellar IMF is well determined down to the brown dwarf boundary but is much less well known below, and it is not known whether the IMF as a whole is universal or not (the current state of research into ultra low-mass star formation is described in Martín & Magazzù 2007). The mass limit reached varies some-

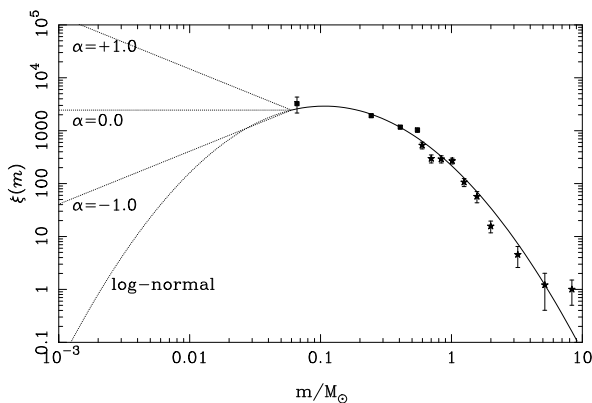

Figure 3. Various extrapolations (dotted lines) of the Pleiades mass function (after Hambly et al. 1999) illustrating uncertainties in the behaviour of the Mass Function (MF) in the brown dwarf (BD) regime. (Vertical axis is cluster stars per unit mass.) The most recent surveys have probed the mass range 0.01 to 0.1 solar masses, using a variety of techniques, and have produced a range of different forms of the MF using heterogeneous datasets with varying degrees of completeness. The GCS aims to obtain maximal completeness in ten targets to settle the questions as to the form and universality (or otherwise) of the MF in the BD regime.

what from cluster to cluster, but is typically around $M_L \sim 30M_J$, where M_J is the mass of Jupiter. The number of objects expected to be detected in the range $M_L - M_L + 10M_J$ ranges from 100 to 3000 for the range of possible mass function models, showing how well we will constrain the IMF compared to current knowledge.

To find extreme objects — the very nearest examples, the lowest mass objects — the Large Area Survey is better. But to measure the substellar IMF, one wants to target the 30 – 100 M_J region, and to obtain masses one needs both a distance and an age, for which mapping clusters is ideal. This approach has of course already been started (e.g. Moraux et al. 2007 and references therein). Our survey improves on current studies not by going deeper but by collecting much larger numbers, and examining objects formed in environments having a range of ages and metallicities, to examine the question of universality.

2.6 Goals of the Deep Extragalactic Survey (DXS)

The Deep Extragalactic Survey (DXS) aims to map 35 sq.deg. of sky to a 5σ point-source sensitivity of $J=22.3$ and $K=20.8$ in four carefully selected, multi-wavelength survey areas. Central regions of each field will also be mapped to $H=21.8$. The primary aim of the survey is to produce a photometric galaxy sample at a redshift of 1–2, within a volume comparable to

that of the SDSS, selected in the same passband (rest frame optical). Figure 4 shows measured K magnitude versus redshift for galaxies in the Hawaii Deep Fields (L.Cowie, private communication). This shows that to achieve a sample such that the median redshift is $z \sim 1$ requires measuring galaxies with $K \sim 20$ and so going to a point source depth of $K \sim 21$. Such a sample will allow a direct test of the evolution of the galaxy population and determine how galaxies of different types (passive, star-forming, AGN) trace large scale structure (their bias). Each of these properties can be predicted from cosmological simulations so the DXS will set tight constraints on these models in volumes less susceptible to cosmic variance than previous, narrow-angle surveys at this redshift. The sample will also enable the selection of clusters of galaxies in this redshift range, where cosmological models predict numbers to be sensitive to the total mass density of the Universe, Ω_0 .

The number of deep, multi-wavelength survey fields has increased dramatically in the past 5 years with the up-grade of existing facilities (e.g. Megacam on CFHT and VIMOS on the VLT) and new satellite missions (e.g. *Spitzer*, *GALEX*, *XMM-Newton* and *Chandra*). Each of these facilities has current surveys of 2–40 sq.deg. of contiguous area to levels where many of the counterparts are intrinsically faint in the optical ($R > 24$) due to a combination of redshift and/or intrinsic dust obscuration, but are relatively red ($R-K > 4$). Therefore deep NIR imaging ($K \sim 21$) over tens of square degrees is required to fully characterise these dusty and/or distant objects. Looking ahead to the end of this decade and the completion of UKIDSS, there will be many more complementary surveys on these scales in other wavebands such as the far-infrared (*Herschel*), sub-mm (SCUBA-2), radio (EVLA and eMerlin) and Sunyaev-Zel’dovich (SZ telescope and AMI). The legacy potential of the DXS was a key driver for the science case and the field selection (see section 4.4).

2.7 Goals of the Ultra Deep Survey (UDS)

The Ultra Deep Survey (UDS) aims to map 0.77 sq. degrees to a 5σ point-source sensitivity of $J=24.8$, $H=23.8$, $K=22.8$. Such depths are required to reach typical L^* galaxies at $z = 3$. Covering an area one hundred times larger than any previous survey to these depths, this will provide the first large-volume map of the high-redshift Universe (30×30 Mpc by 2 Gpc deep at $2 < z < 4$).

Deep near-infrared surveys are crucial for obtaining a more complete census of the Universe at these epochs. In particular, galaxies which are reddened by dust or those which appear red due to old stellar populations may be completely missed by standard optical surveys. From the UDS we anticipate over 10,000 galaxies at $z > 2$, allowing detailed studies of the luminosity functions, clustering and multi-wavelength

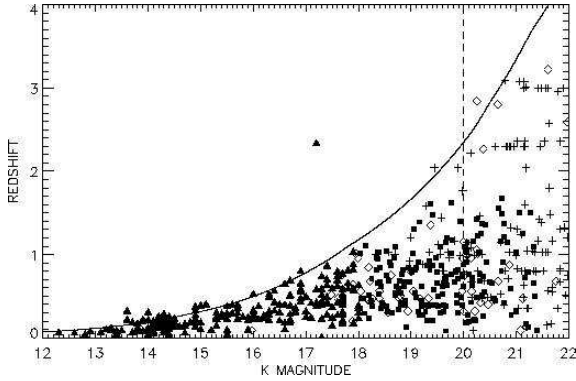

Figure 4. The redshift distribution of a K selected galaxy sample from the Hawaii Deep Fields. This is an updated version of the figure in Songaila *et al* (1994), kindly provided by L. Cowie and collaborators. The solid symbols show spectroscopic redshifts from the Hawaii Deep Fields, which have been completely observed to $K=20$ (dashed line) though only identified objects are shown. The open diamonds show the spectroscopically identified objects in the Hubble Deep Field, while the crosses show all the remaining objects at their photometric redshift. The solid line shows the K magnitude of a $2L^*$ unevolving Sb galaxy.

SEDs over a large, representative volume. A major goal, together with the DXS and local surveys, is to measure clustering as a function of stellar mass and cosmic time, which will provide very powerful tests of models for biased galaxy formation and the growth of structure.

The UDS is also designed to address one of the major unsolved problems in modern astronomy, which is to understand when the massive elliptical galaxies are formed. A key test will be to determine the co-moving number density of the most massive galaxies at various epochs, particularly at $z > 2$. This requires a combination of both depth and area which has previously been impossible to achieve. If the density of massive galaxies (more massive than local L^* ellipticals) is similar to that of today, we should see ~ 1000 per square degree. Current semi-analytic models predict an order of magnitude fewer. Our goal is to directly measure the build-up of this population over cosmic time.

The survey field chosen for the UDS is the Subaru/XMM Deep Field, which has a wide range of multiwavelength data available, including deep radio observations from the VLA, submm mapping from SCUBA, mid-IR photometry from Spitzer, deep optical imaging from Subaru Suprimecam and deep X-ray observations from XMM-Newton. When combined, these will enable detailed studies of the relationship between black hole activity, dust-dominated ULIRGs and IR-selected massive galaxies using an unprecedented high-redshift sample.

3 IMPLEMENTATION WITH THE UKIRT WIDE FIELD CAMERA

3.1 General characteristics of telescope and camera

UKIDSS is implemented using the Wide Field Camera (WFCAM) on the United Kingdom Infrared Telescope (UKIRT), which is operated by the Joint Astronomy Centre (JAC), an establishment of the UK's Particle Physics and Astronomy Research Council (PPARC). General technical details for UKIRT are given on the JAC website⁴. It is an infra-red dedicated 3.8m telescope operating at the summit of Mauna Kea in Hawaii. Of particular importance is a tip-tilt secondary, which primarily removes dome and windshake effects on seeing, delivering close to free-atmosphere seeing (half arcsecond on many nights) across the whole WFCAM field of view. With the advent of UKIDSS, UKIRT now operates in part as a survey telescope and in part as an open access telescope offering time through periodic peer-reviewed competition. At the time of writing, WFCAM is scheduled for 60% of UKIRT time, 220 nights per year. After removal of engineering time, and time allocated to the University of Hawaii, and Japan, an average of 167 nights per year is left, 80% of which, 134 nights per year, is devoted to UKIDSS, and the remaining time to other peer-reviewed programmes. (The latter are selected by the UK PATT system, open to world wide proposals).

WFCAM is described in detail by Casali *et al.* (2007). Here we summarise some key characteristics. WFCAM has an unusual design, with an array of IR detectors inside a long tube mounted above Cassegrain focus. The forward-Cassegrain Schmidt-like camera design makes possible a very wide field of view (40 arcmin) on a telescope not originally designed for this purpose. The camera has four 2048×2048 Rockwell Hawaii-II PACE arrays. The arrays have a projected pixel size of $0.4''$, which gives an instantaneous exposed field of view of 0.207 deg^2 per exposure. The arrays are spaced by 0.94 detector widths. The focal plane coverage is illustrated in Figure 5.

The WFCAM filters, the optical performance, and the detector efficiency are presented in Casali *et al.* (2007). The photometric system is described in Hewett *et al.* (2006).

3.2 Observing with WFCAM

WFCAM makes short exposures on the sky, typically 5-10 seconds. Coverage of the sky is then built up in several stages - by small jittering patterns around a fixed telescope pointing position; by macrostepping to make a filled in "tile"; and by accumulating sets

⁴ <http://www.jach.hawaii.edu/UKIRT/>

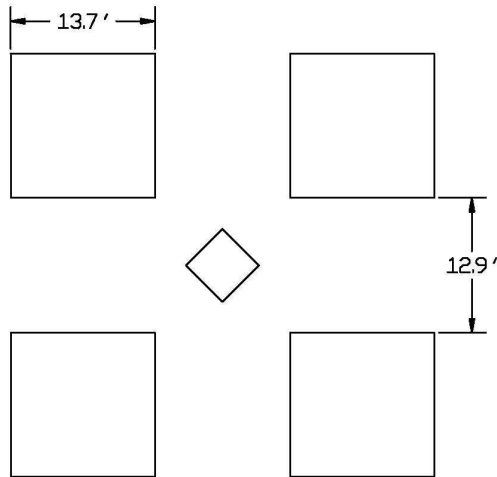

Figure 5. The WFCAM focal plane. The spacing between detectors is 94% of the width of each detector. A sequence of four pointings therefore produces complete coverage for one “tile”, plus a small overlap region. The central diamond is the autoguider CCD. For details see Casali et al. (2007).

of such tiles to gradually cover the sky, or revisiting tiles to build up depth.

Integration overheads. Each WFCAM array has a separate SDSU controller, reading out 32 channels (8 segments in each of 4 quadrants). The total readout time is 0.7 seconds, and the reset process is almost instantaneous, but normal procedure involves two dummy readouts to stabilise the array, which take 0.3 seconds. The overall *exposure overhead* is therefore 1.0 seconds. Multiple *exposures* can be made at the same pointing position, co-adding into the same data file. The sum of these exposures is an *integration*, which results in a set of four data files which in offline processing are later linked together as a *multi-frame*. For some users of WFCAM there may be several exposures per integration, but UKIDSS procedures always have only one exposure per integration. In addition each integration has a *data acquisition overhead* of 2-3 seconds. It is hoped that hardware and software improvements will improve this in due course, but for the moment there is then a total *integration overhead* of 3-4 seconds. Exposures of 5-10 seconds are therefore long enough to be reasonably efficient ($\sim 55\text{-}77\%$) and for sky background noise to be larger than the readout noise. The main exception is in the Y and Z bands, where exposures of 20 seconds are needed for the sky noise to exceed readout noise. Exposures longer than this are not normally used, as an increasing number of stars in the field are saturated.

Jittering and micro-stepping. Small accurate telescope offset patterns relative to a fixed base position are used to improve WFCAM data. The first

method is to use a jitter sequence with offsets equal to whole numbers of pixels, resulting in frames which can be co-added. The aim of such a *jitter pattern* is to minimise the effects of bad pixels and other flat-fielding complications. A variety of jitter patterns can be used. The second kind of pattern is *microstepping*, which uses offsets with non-integer numbers of pixels. In 2×2 microstepping, offsets by $N+1/2$ pixels are used. The data are then interlaced (i.e. keeping the pixels independent) into a grid of pixel-spacing $0.2''$, producing an image of size 4096×4096 pixels for each array. In 3×3 microstepping, offsets by $N+1/3$ and $N+2/3$ pixels are used. The aim of such a microstepping pattern is to improve image sampling - the WFCAM pixel size of $0.4''$ is adequate for moderate seeing (i.e. $>0.8''$), but undersamples the expected seeing a significant fraction of the time. For sampling and/or cosmetic reasons, all UKIDSS surveys use at least 2 offset positions, and most use 4 offset positions. The “standard shallow observation” has a total integration time of 40 seconds, with individual exposures chosen to add up to this total. The data from offset sequences are normally interleaved and/or stacked offline to make a single multi-frame data file, which is the basic unit of the archived data. Small offsets (less than $10''$) are intended to have minimal overhead. They are applied by the tip-tilt system, with a smooth restoration to the optical axis during observing. Larger offsets are applied by the telescope mount, and observing commences after the system has stabilised.

Tiling. The WFCAM arrays are spaced by 0.94 detector widths. The sky could potentially be covered in a variety of mosaic patterns, but the typical procedure would be to expose in a pattern of four macrosteps to make a complete filled-in “tile”. Allowing for overlaps with adjacent tiles, the width of a single tile is then 3.88 detector widths, i.e. 0.883° , giving a solid angle of 0.78 sq.degs. The time between macrostep integrations (slew, stabilise, guide star lock) is ~ 15 seconds. For shallow surveys, where each pointing has typically 4 offset positions each with a 10 second exposure and a 3.5 second overhead, this means that a tile with 4 pointings spends 160 seconds exposing out of an elapsed time of 276 seconds, making a total *observing efficiency* of 58%. For deeper surveys, where many integrations are made between telescope slews, the macro-step overhead is negligible, and the efficiency tends towards $\sim 75\%$.

Schedule Blocks and Survey Definition. UKIRT operates an automated flexible queuing system. A precise sequence of exposures, offset patterns, and filters at each of a list of pointing positions, which can be thought of as grouped into “tiles” as appropriate, is specified in advance. These Observations are grouped into “Minimum Schedulable Blocks (MSBs)”, occupying roughly 20-60 minutes. The MSBs also contain constraints that determine whether they can be observed - required seeing, sky

brightness, etc. Calibration observations - twilight flats, standard stars, etc - are entered as independent MSBs. The MSBs are entered into a database which is queried during observing to generate a priority ranked list of MSBs for which the current weather and observing conditions are suitable. The observer selects an MSB from this list (normally the highest priority MSB) and sends it onto an execution queue to be observed. If the MSB is successfully completed, it is marked as such in the database and will not be listed in future query results. (Occasionally MSBs are partially completed or fail the later Quality Control (QC) process, and so can be repeated). For UKIDSS, a Survey Definition Tool (SDT) is used to design the list of pointing positions and associated guide stars for each survey, which are then grouped into MSBs, and likewise into smaller “projects” which help planning and monitoring of survey completion.

Actual survey data collection rate in practice is considered in section 7. Implementation details, such as seeing and sky brightness constraints, are given in the data release papers - Dye *et al.* (2006) and Warren *et al.* (2007a,b).

3.3 Survey calibration

The UKIDSS data are calibrated to magnitudes in the Vega system. The WFCAM photometric system - filter response curves, and synthetic colours for a variety of objects - is described in Hewett *et al.* (2006). (Approximate passbands are given in section 1.2). Calibration on the sky is achieved using observations of 2MASS stars within each field, which allows us to derive photometric calibration even during non-photometric conditions, including colour equations for transformation from the 2MASS system to the WFCAM system. For the shallow surveys, the Quality Control (QC) process includes frames whose zeropoint is within 0.2 magnitudes of the modal value. (The vast majority of accepted frames are much better than this.) For the stacked surveys, where there is an additional self-calibration check, we accept frames within 0.3 magnitudes. It is possible that within such occasional frames with modest extinction there will be some noticeable spatial opacity gradient. This possibility is not included in the current pipeline, but we intend to examine it in later re-processings.

There are plenty of unsaturated 2MASS stars in every data frame - in the range 60-1000, dependent on Galactic Latitude. Furthermore the 2MASS global calibration is accurate to better than 2% across the entire sky (Nikolaev *et al.* 2000). The procedure is to cross-match objects detected by the pipeline with 2MASS unsaturated sources that have $\sigma_{JHK}(2MASS) \leq 0.1$, and to transform the photometry of these stars into the WFCAM ZYJHK system using empirically derived colour terms. After correcting counts for the known radial variation in pixel scale, the average of these stars gives a global per-

frame zeropoint. Tests against observations of UKIRT faint standards (Hawarden *et al.* 2001) indicates that this procedure gives us a JHK photometric system accurate to 2%, which is the survey design requirement. (At the time of writing, the quality of the Z-, Y- and narrowband-filter calibration has not yet been quantified.) Calibration from 2MASS stars therefore seems justified. However, we have also made frequent observations of UKIRT faint standards which provides a backup calibration, and an independent method of deriving colour equations. The calibration procedure, and the final colour equations between various systems, will be presented in full in Hodgkin *et al.* (in preparation).

4 SURVEY DESIGN

The design of the UKIDSS survey components was driven by a mixture of the legacy ambition, practical limitations, and specific science goals. The total size of the project was chosen by a decision to continue long enough to achieve a product of international significance and lasting value. The total time available was driven by UKIRT/WFCAM scheduling constraints. We thus arrived at a *seven year plan* totalling approximately a thousand nights. Seven years is however a long time to wait for science results; we therefore also designed an initial *two year plan* that would produce a self contained product and valuable science.

Table 3 summarises the design parameters of each of the five UKIDSS survey components. Figure 6 shows the location of the survey fields on the sky. The logic behind this design, and some more detail about how the surveys are implemented, is described below for each survey component in turn. The implementation details were revised after the first observing block (May-June 2005). We outline the current scheme, with the expectation that it is unlikely to change significantly. More complete details will be provided in each paper accompanying milestone data releases (Dye *et al.* (2006), for the EDR; Warren *et al.* (2007a,b) for DR1 and DR2). Note that the survey parameters shown here are the survey goals, as approved during the proposal stage, and adjusted to a minor degree during survey planning. Likewise the times quoted are the original proposal estimates. The actual time to reach these design parameters, or the likely final adjusted survey parameters, depend on both time allocation by the UKIRT Board and the real survey progress rate, which is discussed in section 7.

4.1 Microstepping strategy

Microstepping improves the sampling, but has the disadvantage of making overheads worse. With 2×2 microstepping, repeated after an offset, the exposure

Survey	Area	Filters	Limit	t_{int}	t_{tot}	Nights
LAS	4028	Y	20.3	40s	367h	262 nts
	4028	J×2	19.9	80s	734h	
	4028	H	18.6	40s	367h	
	4028	K	18.2	40s	367h	
GPS	1868	J	19.9	80s	286h	186 nts
	1868	H	19.0	80s	286h	
	1868	K×3	18.8	120s	495h	
	300	H ₂ ×3	—	450s	237h	
GCS	1067	Z	20.4	40s	86h	74 nts
	1067	Y	20.3	40s	86h	
	1067	J	19.5	40s	86h	
	1067	H	18.6	40s	86h	
	1067	K×2	18.6	80s	172h	
DXS	35	J	22.3	2.1h	415h	118 nts
	5	H	21.8	4.4h	124h	
	35	K	20.8	1.5h	287h	
UDS	0.77	J	24.8	209h	983h	296 nts
	0.77	H	23.8	174h	818h	
	0.77	K	22.8	58h	271h	
TOTAL						936 nts

Table 3. Summary of design goals for each survey. Note that the time estimates quoted are based on the efficiencies etc assumed at the time of proposal. The real time required to achieve these goals will be somewhat longer, and is being assessed at the end of the two year plan. Notes : (i) Area is in square degrees. (ii) “J×2” implies that two passes of the whole area are made in that filter. (iii) “Limit” is the Vega magnitude of a point source predicted to be detected at 5σ within a $2'$ aperture. (iv) t_{int} is the accumulated integration time at each sky position. (v) t_{tot} is the number of hours required on-sky to complete the survey, allowing for the estimated exposure efficiency and mosaic efficiency. These efficiency factors are different for each survey. (vi) “Nights” is the estimated number of nights required, allowing for calibration and average fraction of useable UKIRT time (assumed 70% clear).

time in the shallow surveys (mostly 40s total integration) is 5s. Without microstepping longer exposure times are possible, 10s or 20s, which reduces the overheads significantly. Experimentation with WFCAM data indicates that microstepping has little advantage for photometric accuracy, but improves the astrometric accuracy. In each of the shallow surveys, repeat passes are therefore made in a particular ‘astrometric’ band, for measuring proper motions; J for the LAS, and K for the GCS and GPS. As a compromise between increased overheads and better astrometry, in the current scheme for the high latitude shallow surveys (LAS and GCS), the astrometric band is 2×2 microstepped, while the other bands are not microstepped. For the GPS, 2×2 microstepping is employed because of the importance of object separation in crowded fields. (Of course 3×3 would give even better PSF sampling, but this only makes a significant difference in the small percentage of cases where seeing is better than $0.3''$.) For the deep surveys, the total integration times in a field are much larger, allowing the use of longer exposures while microstepping, so overheads are not an issue. In the DXS 2×2 microstepping is used, and in the UDS 3×3 microstepping is used, in all bands.

4.2 Design of the Large Area Survey (LAS)

The main science goals of the LAS require as large a volume as possible, with increased area being a more efficient use of time than increased depth. However the survey rate is constrained by our requirement for multiple pass bands, by the need for exposures long enough to avoid inefficient observing, and by the need for jittering in order to improve cosmetic quality and/or spatial sampling.

The detailed implementation also depends on the weather constraints used. Because LAS uses a large fraction of the UKIDSS time, it would obviously not demand the best seeing. Colours are very important, and some objects are variable, which argues for doing all four bands when each sky position is visited; on the other hand, the Y and J observations require darker sky than the H and K observations. MSBs were then grouped so that H and K would be done together, and Y and J done separately. However, the queue is monitored and adjusted to try to make sure the YJ and HK observations are not too far apart. Our current plan is to prioritise uniformity and achieve the limits given in section 2. Thus in poorer seeing conditions the integration times are increased to compensate.

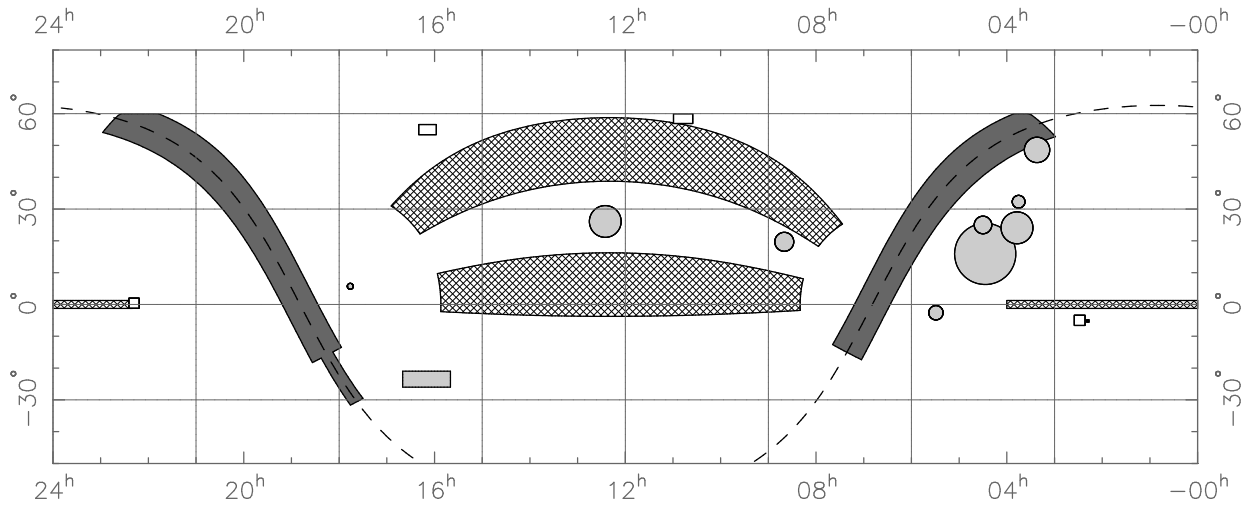

Figure 6. Location on the sky of the fields comprising the various survey components. Cross-hatch : Large Area Survey. Dark Grey : Galactic Plane Survey. Light Grey : Galactic Clusters Survey. Open rectangles : Deep Extragalactic Survey. Note that the Ultra Deep Survey lies just to the west of the DXS field at $02^{\text{h}}18^{\text{m}} - 05^{\circ}10'$. The dashed line marks the Galactic plane. Note that UKIRT lies at latitude $+20^{\circ}$.

Field selection for the LAS was designed to have a good spread in RA, to have a reasonable amount of sky coverage at lower declinations, for follow-up on ESO telescopes, to keep below the UKIRT Declination limit ($+60^{\circ}$), all while lying with the SDSS footprint. There are three sub-areas, shown in Fig 6. The detailed field co-ordinates are defined on the UKIDSS web pages.

(i) *The LAS equatorial block* : 1908 sq.deg. This includes most of SDSS stripes 9 to 16.

(ii) *The LAS northern block* : 1908 sq.deg. This includes most of SDSS stripes 26 to 33.

(iii) *The LAS southern stripe* : 212 sq.deg. This is a section of SDSS stripe 82, extending over $-25^{\circ} < \text{RA} < +60^{\circ}$, $-1.25^{\circ} < \text{Dec} < +1.25^{\circ}$. Stripe 82 has been repeatedly scanned by SDSS, and this is the region of highest quality.

4.3 Design of the Galactic Plane Survey (GPS)

The GPS aims to map as much of the Galactic Plane as possible to a latitude of $\pm 5^{\circ}$. The Galactic Latitude limit is chosen to match other surveys, for example the MSX survey (Egan and Price 1996). The survey area is then largely dictated by the UKIRT Declination limit to the North, and by the latitude of UKIRT to the South. Within a reasonable length of time, we can then afford to go roughly a factor of two deeper than the “standard shallow observation” defined in section 3.2. This depth is good enough to see all of the IMF to the H-burning limit in quite dis-

tant clusters, to see AGB stars all the way through the Galaxy, and to see ordinary G-M stars to several kpc. The tradeoff to consider is then between depth, colours, and repeat coverage. At least three bands, and preferably, four are needed, in order to estimate both spectral type and extinction. However, extinction is large enough in much of the Plane that Y band observations are impractical. For regions of low extinction the optical IPHAS survey at r’,i’ and H α (see <http://www.iphas.org>) will provide sufficient additional colours to determine the average extinction as a function of distance in each field using reddening independent colour indices. Other statistical methods to measure extinction using the JHK colours alone can also be employed - see Lopez-Corrodera *et al.* (2002). Measurement of both variability and proper motions is a goal of the GPS. As a bare minimum to achieve this, we plan three epochs in one band spread across ~ 5 years. We choose the K-band to make these repeats, because, given extinction, this is the sensible band in which to build up depth - it is the K-band that allows us to see clean through the Galaxy in most directions. In summary then, we plan an initial pass at JHK, with integrations of 80s, 80s and 40s in the 3 bands respectively, followed by two further passes at K with 40s integrations at intervals of at least 2 years for any survey site.

One of the goals of GPS is the discovery and study of Young Stellar Objects, and in particular molecular outflows. We therefore plan in addition to the above a survey of a single large star forming re-

gion in a narrow band H₂ filter. (For details of this filter, see Casali *et al.* 2007).

The area to be mapped is shown in Fig. 6. The main area is defined by the Galactic latitude range $b = \pm 5^\circ$, $\text{Dec} < 60^\circ$, and $\text{Dec} > -15^\circ$. These constraints define two sections of Galactic longitude, which are $15^\circ < l < 107^\circ$, and $142^\circ < l < 230^\circ$. In addition we will map a narrow extension through the Galactic centre, within $b = \pm 2^\circ$, covering Galactic latitudes $-2^\circ < l < 15^\circ$. The Galactic bulge will also be explored by surveying a thin stripe extending upwards in latitude from the Galactic centre. Finally, the molecular hydrogen survey maps the Taurus-Auriga-Perseus complex.

Normal procedure is to do all bands in one visit, as colours are important and many objects are variable.

4.4 Design of the Galactic Clusters Survey (GCS)

The design of the GCS is relatively simple. It needs to target several separate clusters, in order to examine the substellar IMF over a range of ages and metallicities. The depth requirement is set by the need to detect objects in the 30-100 M_J range. Assuming the standard “shallow survey” depth (see section 3.2), this means that clusters have to be fairly close and/or young, i.e. within a few hundred parsecs and/or less than a few hundred million years old. There are relatively few such objects, and they are several degrees across. A natural strategy therefore emerges using the standard shallow depth and surveying ten nearby clusters, covering 1067 sq. deg. in total. To distinguish cluster members, all five passbands are needed (ZYJHK), plus a measurement of a proper motion using a second pass in the K band. Full colour information provides cluster sequence discrimination in multi-colour space, reddening estimates using shorter versus longer wavelength colour indices, breaking the degeneracy between reddening due to instellar extinction and that due to the presence of circumstellar disks.

The strategy is to cover the majority 1067 sq. degs in a single pass in K, to provide the proper motion baseline, within the initial two year plan. Table 4 lists the parameters of the chosen clusters.

4.5 Design of the Deep Extragalactic Survey (DXS)

The DXS aims to detect galaxies at redshifts of 1–1.5. To avoid selecting only the brightest and hence most massive galaxies, this requires the detection of galaxies close to the break in the galaxy luminosity function, M_K^{*} which is -22.6 locally (Bell *et al.* 2003). At z=1 this corresponds to an evolution corrected, total K magnitude of 20.7, and 21.8 at z=1.5. Therefore, taking into account aperture effects, our target depth

of K=21 will reach to within 0.5–0.7 magnitudes of M_K^{*} and hence sample a representative galaxy population at z=1. The NIR galaxy colours at this redshift lie in the range J-K=1.5–1.8 so to provide a photometric constraint on the galaxy redshift we also require observations to J=22.3 to ensure matched J and K detections for the target galaxies.

The survey area was driven by the aim to sample large scale structure at z=1 on scales and volume comparable to that measured locally (≈ 100 Mpc and 0.2 Gpc³ respectively). At z=1, our assumed cosmology implies that 100 Mpc corresponds to 3.5° and a 0.2 Gpc³ volume in the range z=1–1.5 requires 40 sq.deg. Therefore a minimum combination of 3x3 WFCAM tiles will span these scales and a total of 54 WFCAM tiles would be required to cover that area (0.75 sq.deg. per field).

The number and position of the DXS survey fields were chosen to provide the best combination of quality and coverage of supporting, multi-wavelength data, to maximise the spatial scale sampled by each individual field (~ 100 Mpc) for clustering studies and allow a uniform coverage in right ascension. Balancing these factors resulted in the selection of four survey fields: 1) XMM-LSS (centre: 2h25m -04d30m) - a SWIRE, CFHTLS, VVDS, GALEX and XMM survey field adjacent to the UKIDSS UDS area; 2) the Lockman Hole (centre: 10h57m +57d40m) - centred on the SHADES survey area but within the SWIRE and GALEX survey areas with extensive radio coverage; 3) ELIAS-N1 (centre: 16h10m +54d00m) - a SWIRE and GALEX field with additional radio, optical and X-ray data; 4) SA22 (centre: 22h17m +00d20m) - centred on VVDS-4 but the least well surveyed area, included to ensure a uniform demand with RA. Other survey fields were considered (COSMOS, NOAO-DWFS, Groth Strip, Spitzer-FLS) but most were either not sufficiently large or comprehensive to justify inclusion. The chosen fields are listed in Table 5.

The total area covered by the DXS within the full 7 year span of UKIDSS will depend on weather and competition from other surveys (most notably the UDS) but our goal is 35 sq.deg. or 12 WFCAM fields in each DXS survey area in J and K. We also intend towards the end of the survey to include an additional 1–2 WFCAM fields in the centre of each DXS survey area in H to broaden the photometric coverage.

For DXS, star-galaxy separation at faint magnitudes will be very important, so 2x2 micro-stepping is employed to give good sampling. Achieving the required depth will require reliable stacking, and so minimising any systematic effects in detector structure that do not flat-field out. The DXS strategy therefore employs substantial jittering. Each visit to a given tile position uses 10 second exposures, a sixteen point jitter, and 2x2 microstepping at each of these jitter positions. Each such visit therefore has

Priority/ Name	Type	RA (2000)	Dec (2000)	Area (sq.deg.)	Age (Myr)	Minimum mass (M_{\odot})
(1) IC 4665	open cl.	17 46	+05 43	3.1	40	0.020
(2) Pleiades	open cl.	03 47	+24 07	79	100	0.024
(3) Alpha Per	open cl.	03 22	+48 37	50	90	0.025
(4) Praesepe	open cl.	08 40	+19 40	28	400	0.046
(5) Taurus-Auriga	SF assoc.	04 30	+25 00	218	1	0.010
(6) Orion	SF assoc.	05 29	-02 36	154	1	0.014
(7) Sco	SF assoc.	16 10	-23 00	154	5	0.010
(8) Per-OB2	SF assoc.	03 45	+32 17	12.6	1	0.011
(9) Hyades	open cl.	04 27	+15 52	291	600	0.041
(10) Coma-Ber	open cl.	12 25	+26 06	79	500	0.043

Table 4. Areas targeted for the Galactic Clusters Survey, listed in priority order. The primary data source is Allen (1973) with updated Hipparcos distances from Robichon et al (1999) and de Zeeuw et al (1999); assuming a depth $J=19.5$ (Table 3) the mass limit was calculated using the DUSTY models of Chabrier et al (2000).

an integration of 640 second at each sky point. To reach the intended depth requires a total exposure of 2.1 and 1.5 hours in J and K respectively or 12 and 8 visits each. H observations are quite slow, and are planned as a lower priority in a subset of the chosen fields. Given that the DXS observations do not require photometric conditions or the very best seeing, then the final number of visits for each field may be higher to compensate for these poorer conditions.

4.6 Design of the Ultra Deep Survey (UDS)

The UDS aims to go as deep as possible in a single contiguous WFCAM tile. The depth is set by the aim of detecting giant ellipticals at $z=3$ if they exist. The total magnitude of such objects is expected to be $K \sim 21$ but they will be significantly extended, so that we need to reach a point source depth of $K=23$. Three bands are needed, to get photometric redshifts and discriminate between objects. To effectively separate ellipticals and starbursts, we need to be able to detect colours $J-K \sim 2$ and $H-K \sim 1$, otherwise most of our detections may be K-band only. This sets limits of $J \sim 25$ and $H \sim 24$, which are in fact more demanding in time than the K-band observations. The final expected depths are $J=24.8$, $H=23.8$, $K=22.8$.

As with the DXS, we need good sampling to enable star-galaxy separation at faint magnitudes, and multiple jitters to overcome detector systematics when stacking. These issues are even more demanding however for the UDS; at each visit we use 3×3 microstepping and a 9 point jitter, and repeated visits are not at precisely the same position, but in a carefully arranged pattern - a kind of super-jitter.

Although the headline science goals of the UDS are to find high redshift galaxies which will be extremely faint at optical wavelengths, the legacy value of the survey will be increased by the presence of complementary ultra-deep optical data. The field chosen was therefore the Subaru/XMM-Newton Deep Field (Sekiguchi et al. , in preparation) which possessed the

deepest optical data of any square-degree field at the time this decision was made. Considerable data at other wavelengths from radio to X-ray also exist in this field. This field is at the western edge of one of the DXS fields.

4.7 Two Year Goals

We aim to complete self contained and scientifically valuable datasets on a two year timescale. The detailed plan is set out in Dye et al. (2006), but briefly is as follows. The shallow surveys (LAS, GCS, and GPS) are accelerated compared to the deep stacked surveys (DXS and UDS). In addition, the LAS concentrates on southern latitudes in the first two years, in order to maximise VLT follow-up. For LAS, roughly half the area - the equatorial block, and the southern stripe - will get complete YJHK coverage. (Second epoch J for the same areas will come later). Additional J only coverage in the Northern block will be achieved as time permits. For GPS, the prime aim is to obtain the first of three K epochs over the whole survey area, with J, H, and H_2 coverage over a sub-area. For GCS the aim is to get complete filter coverage for five of the ten target clusters, and the central regions of three, plus K only coverage of the remaining two. For DXS, the two year aim is to reach the full depth in J and K for a subset of the area - four tiles (3.1 square degrees) in each of the four fields. The UDS is of course a single tile. The two year goal is to achieve $K=22.8$ (full depth) and $J=23.8$ (one magnitude short), with no H coverage.

5 DATA PROCESSING AND DATA PRODUCTS

The commitment to making a public survey requires the construction of complete, reliable, tested, and documented products from the raw data. The very large volume of UKIDSS data (200 GBytes/night)

Name	Survey	Area	RA(2000)	Dec (2000)
XMM-Subaru	UDS	0.77	02 18 00	-05 10 00
XMM-LSS	DXS	8.75	02 25 00	-04 30 00
Lockman Hole	DXS	8.75	10 57 00	+57 40 00
ELAIS N1	DXS	8.75	16 10 00	+54 00 00
SA22	DXS	8.75	22 17 00	+00 20 00

Table 5. Fields targeted for the Deep Extragalactic Survey and the Ultra Deep Survey. Note that the UDS field is at the western edge of the DXS XMM-LSS field

means that to achieve these goals requires a uniform and automated approach to data processing. Likewise the large accumulated volume of products - expected to be several tens of Terabytes of image data and several billion source detections - means that as well as providing public data access, we need to provide online querying and analysis facilities as a service. These ambitions are met for all WFCAM data (both UKIDSS survey data and PATT PI data) by the VISTA Data Flow System (VDFS). VDFS is a PPARC-funded project involving QMUL, Cambridge and Edinburgh, aimed at handling the data from first WFCAM and then the VISTA telescope. (The Science Archive was also prototyped on the SuperCosmos Science Archive : see <http://surveys.roe.ac.uk/ssa/> and Hambly *et al.* 2004). The system aims at (i) removing instrumental signature; (ii) extracting source catalogues on a frame by frame basis; (iii) constructing survey level products - stacked pixel mosaics and merged catalogues; (iv) providing users with both data access and methods for querying and analysing WFCAM data.

Overall data flow is as follows. Raw data are shipped by tape on a weekly basis from Hawaii to Cambridge, where they are available within a month of the observations being taken. Raw data are then transferred via the internet for ingest into the ESO archive system. Pipeline processed single frame data are transferred to Edinburgh over the internet on a daily basis, where they are ingested into the science archive, and further processing (stacking, merging, and quality control) takes place. The processed data are then released to the public at periodic intervals.

5.1 The WFCAM Pipeline

The general philosophy behind the pipeline processing is that all fundamental data products are FITS multiextension files with headers describing the data taking protocols in sufficient detail to trigger the appropriate pipeline processing components, and that all derived information, quality control measures, photometric and astrometric calibration and processing details, are also incorporated within the FITS headers. Generated object catalogues are stored as multiextension FITS binary tables. These FITS files thereby provide the basis for ingest into databases both for archiving and for real time monitoring of survey progress and hence survey planning.

After conversion at the summit from Starlink NDF to FITS files, to reduce the data storage, I/O overheads and transport requirements, we make use of lossless Rice tile compression (eg. Sabbey *et al.* 1998). For this type of data (32 bit integer) the Rice compression algorithm typically gives an overall factor of 3–4 reduction in file size. Data are shipped roughly weekly from JAC using LTO tapes, one per detector channel, and combined to create the raw archived multiextension FITS files on ingest in Cambridge.

The data processing strategy attempts to minimise the use of on-sky science data to form “calibration” images for removing the instrumental signature. By doing this we also minimise the creation of data-related artefacts introduced in the image processing phase. To achieve this we have made extensive use of twilight flats, rather than dark-sky flats (which potentially can be corrupted by thermal glow, fringing, large objects and so on) and by attempting to decouple, insofar as is possible, sky estimation/correction from the science images.

Each night of data is pipeline processed independently using the master calibration twilight flats (updated at least monthly) and a series of nightly generated dark frames covering the range of exposure times and readout modes used during that night. A running sky “average”, i.e. calculated from a number of recent frames, in each passband is used for sky artefact correction. After removing the basic instrumental signature the pipeline then uses the header control keywords to produce interleaved and/or combined (stacked) image frames for further analysis. This includes generation of detected object catalogues, and astrometric and photometric calibration based on 2MASS. A more detailed description of the WFCAM processing is given in Irwin *et al.* (in preparation).

5.2 The WFCAM Science Archive

Data processing delivers standard nightly pipeline processed images and associated single passband catalogues, complete with astrometric and first-pass photometric calibrations and all associated ‘meta’ (descriptive) data in flat FITS files. These data are ingested into the archive on a more or less daily basis. To produce UKIDSS survey products however three more processes are needed - image stacking, source merging, and Quality Control (QC) filtering.

Source merging is computationally very intensive, UKIDSS catalogues are extremely large, and the VDFS system is designed to scale to the even larger expected VISTA products. For standard UKIDSS products therefore a relatively simple spatial pairing algorithm is used. A pairing radius of roughly $1''$ (varying between sub-surveys) is used, several times larger than the astrometric accuracy ($0.1''$), in order to allow merging of moving objects between epochs. Note that the WSA itself follows SDSS practice in storing a *neighbour table* for every source, so that much more flexible source matching algorithms can be applied later, which may be crucial when following up objects with rare colours and so on. More details of stacking, mosaicing, and source merging are given in Irwin *et al.* (in preparation) and Hambly *et al.* (in preparation).

The QC process is a joint responsibility of the UKIDSS consortium and the VDFS project and is a semi-automated process. The first aim is to remove data that is corrupted or unusable (for example due to bright moon ghosts). This is achieved partly by automated inspection of headers and data, and partly by visual inspection. The second aim is to deprecate a subset of data frames not achieving a standardised ‘survey quality’ by applying a series of cuts based on QC parameters derived from the images - for example, seeing, average stellar ellipticity, sky brightness and so on. These cuts are evolving with experience at each data release. Histograms of QC parameters are derived, and manual decisions taken on the cut levels, which are then applied automatically. Each sub-survey (LAS, UDS etc) has separate QC parameters. For example, in the EDR, the LAS seeing limit was $1.2''$, whereas for the UDS it was $0.9''$ and $0.8''$ at J and K respectively. The process is described more fully in the ‘Early Data Release (EDR)’ paper of Dye *et al.* (2006), and revised parameters for DR1 are provided in Warren *et al.* (2007a).

Image data volume is typically ~ 200 GBytes per night, with catalogue and descriptive data being typically $\sim 10\%$ of that figure. Hence, over the course of several years of observations it is anticipated that 10s/100s of Tbytes of catalogue/image data will be produced by survey operations with WFCAM. In order to enable science exploitation of these datasets, the concept of a ‘science archive’ has been developed as the final stage in the systems-engineered data flow system from instrument to end-user (Hambly *et al.* 2004b).

Finally, we note that the WSA has been developed throughout with Virtual Observatory compatibility in mind. The WSA exports VOTABLE, exposes its query interface as an ADQL web service, is published in VO registries, and provides access to AstroGrid VO tools such TopCat and MySpace.

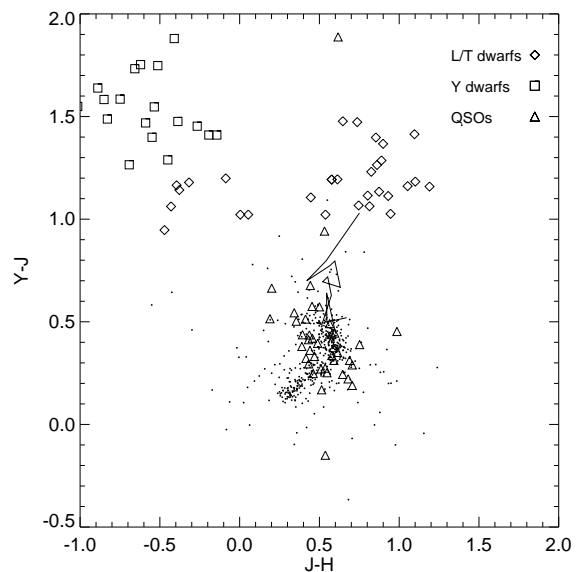

Figure 7. The $Y-J, J-H$ two colour diagram for a single tile observed in the LAS SV programme. Black dots show the data for stellar sources detected in the WFCAM data. Also shown are the synthetic colours of QSOs, L/T dwarfs, and model Y dwarfs. The solid line shows the positions of M dwarfs. The observation was targeted at a known T2 dwarf, SDSS J125454-012247 which is recovered with $Y-J=1.10$ and $J-H=0.54$.

The WFCAM Science Archive⁵ (WSA) is much more than a simple repository of the basic data products described previously. A commercial relational database management system (RDBMS) deployed on a mid-range, scalable hardware platform is used as the online storage into which all catalogue and meta data are ingested. This RDBMS acts as the backing store for a set of curation applications that produce enhanced database driven data products (both image products, e.g. broad-band/narrow-band difference images; and catalogue products, e.g. merged multi-colour, multi-epoch source lists). Moreover, the same relational data model is exposed to the users through a set of web-interface applications that provide extremely flexible user access to the enhanced database driven data products via a Structured Query Language interface. The primary purpose of the WSA is to provide user access to UKIDSS datasets, and a full description, along with typical usage examples, is given in Hambly *et al.* (in preparation). Step-by-step examples of WSA usage are also included in the UKIDSS EDR paper, Dye *et al.* (2006).

⁵ <http://surveys.roe.ac.uk/wsa>

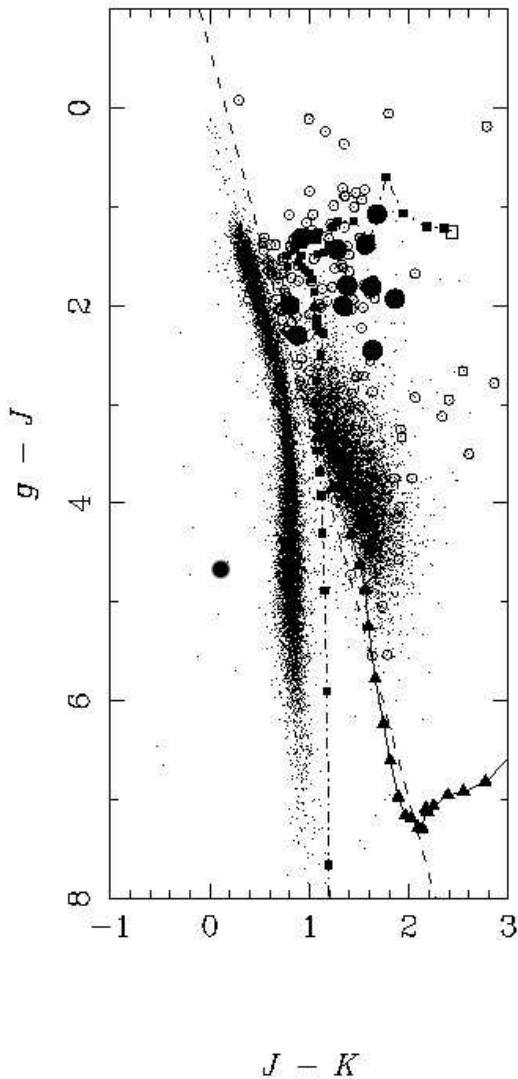

Figure 8. Illustration of the KX method from some 10 sq degs of science verification observations in high Galactic latitude fields. All detected objects in the range $14.5 < K < 16.5$ are plotted, totaling 21000 sources. Stars make up the long, thin cloud, and galaxies form the shorter cloud to the right. The solid squares are model quasar colours $0 < z < 8$, $\Delta z = 0.1$, from Hewett et al. (2006), with $z=0$ marked by the open square. Similarly triangles mark the model colours of an unevolving elliptical galaxy $0 < z < 3$, $\Delta z = 0.1$. The large filled circles are the 11 SDSS spectroscopically confirmed quasars in the observed fields, brighter than the fainter limit of $K=17$. The diagonal dashed line represents a possible KX selection criterion. Candidate quasars (of which there are 167) are compact sources to the right of the line, and are indicated by the open circles. Reddening vectors at different redshifts run approximately parallel to this line (Warren et al. 2000).

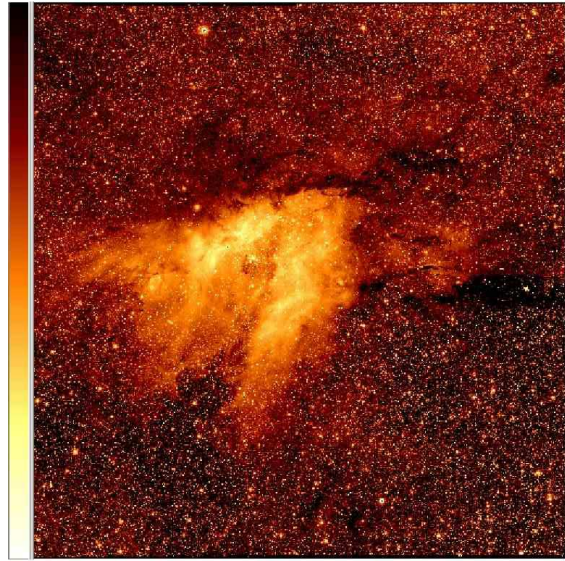

Figure 9. Central 25% of a GPS K-band tile pointed at M17, showing the richness of data in the GPS. The full tile contains 740305 sources.

6 SCIENCE VERIFICATION PROGRAMME

Because the consortium has no proprietary rights, and no formal role in deriving science results from the data (as opposed to facilitating their exploitation), in this paper we have avoided showing science results from the released data. Examples of early papers using UKIDSS data are given in section 7.3. However, the potential of UKIDSS can be well illustrated using the Science Verification data.

Following the technical commissioning of WFCAM, and before the commencement of formal survey operations in May 2005, the UKIDSS consortium undertook a modest set of test observations, as a ‘‘Science Verification (SV)’’ programme. These observations were aimed primarily at further technical commissioning, testing and tuning the implementation strategy, and exercising the data flow system. However the data collected have clearly demonstrated the scientific power of UKIDSS, and confirm the efficacy of the survey design. In this section we show some examples of science results from these SV data.

6.1 Science Verification results for the LAS

The LAS SV programme covered some 20 square degrees, achieving close (0.2mag) to the standard shallow depth in filters Y,J,H,K. One scientific aim was to test the likely recovery of cool brown dwarfs. The success of this is illustrated in Fig. 7, which shows data from a tile aimed at a known T2 dwarf, SDSS

J125454-012247 (Knapp *et al.* 2004). This object was indeed detected, and the colours found are consistent with those previously published. Other L and T dwarfs were also targeted and successfully detected. In this very limited area no new objects of significant interest have been found but that is in line with expectations. The LAS SV data were also used to verify the photometry and astrometry of the UKIDSS survey. Details of these tests are given in the EDR data release paper, Dye *et al.* (2006).

A second aim was to test the location of quasars by combining UKIDSS and SDSS colours. Figure 8 shows that the “K excess” method works extremely well. The stellar and galaxy sequences are cleanly distinguished. Point-like objects to the right of the dashed line are good quasar candidates. Known SDSS quasars in these fields are in the upper part of this region, but the UKIDSS SV data shows many more candidate quasars with similar colours. Additionally there are several candidates with much redder colours than the known quasars. These are candidate reddened quasars, and spectroscopy is required to investigate their nature. Several have colours similar to galaxies, but the overall colour spread of the candidates is much broader than for the galaxies. The quasars in these fields, if confirmed, will be at relatively modest redshift. Note that quasars move rapidly redder in g - J beyond $z \sim 3.8$. The very high redshift quasars that we hope to find will be much sparser on the sky, and in gJK will be hard to distinguish from cool brown dwarfs. Here, as explained in section 2.3, the Y - J colour will be crucial. Analysis of relevant data is still in progress and will be reported in a later paper.

6.2 Science Verification results for the GPS

The science verification data for the Galactic Plane Survey included a 0.75 deg^2 tile centred on M17 (a high mass star formation region). The M17 region has been well studied (eg. Jiang *et al.* 2002) and it provided a good test of the photometric reliability of the data in a nebulous region.

The central 25% of the M17 tile is shown in Figure 9 This illustrates the sensitivity of WFCAM to the structure and stellar population of distant star formation regions. By visual comparison of the WSA catalogue and the reduced image, it is clear that very few spurious sources are found in the archive but within the brightest nebosity the archival source lists become seriously incomplete, with almost all point sources being undetected. This problem occurs generally throughout the GPS in very bright nebulae, since the UKIDSS pipeline photometry is designed to detect resolved galaxies as well as point sources, and hence it attempts to interpret bright nebosity as a single extended source. Such very bright nebulae represent a tiny fraction of the total survey area. In general, more complete luminosity functions may be

derived in nebulous regions by performing independent photometry on the reduced data, using the zero points provided in the image headers.

At the present time only aperture photometry is available in the WFCAM Science Archive. One might expect the photometric precision to suffer considerably from the effects of source confusion. However the algorithm simultaneously fits the coordinates and fluxes of adjacent stars in small groups and divides up the fluxes between any overlapping apertures in a sensible manner (following principles described by Irwin 1985). Hence the resulting photometric quality is very good even in very crowded fields with source densities in excess of 10^6 per square degree, and is similar to the quality of results from profile fitting photometry, which is a far more time consuming process. (Detailed comparison of various photometry techniques will be given in Irwin *et al.* (in preparation)).

The quality of the photometry is illustrated in the two colour-colour diagrams in Figure 10, each of which shows those sources within a single detector array (13 arcminute field) that are listed as having well measured photometry (errors < 0.05 mag on each axis) in the WSA. The curves shown are for unreddened luminosity class V main sequence stars (lower curve) and luminosity class III giants (upper curve), using synthetic photometry from Hewett *et al.* (2006). The left hand panel shows a field at $(l, b) = 171.2, 4.8$, where there is very little extinction. Nearly all of the stars lie near the curves, and both the G-type to early M type main sequence and the giant branch are well represented. There are relatively few sources with colours consistent with those of late M dwarfs near the end of the class V sequence. Hence bona fide late M and L dwarfs should be detectable by follow up observations with a reasonable success rate, provided they have precise photometry. The task will become easier when proper motion information becomes available with the 2nd and 3rd epoch data.

The right hand panel of 10 illustrates a crowded field with high extinction at $(l, b) = 15.0, 0.0$. Despite significant source confusion, there is a clear separation between the reddened giant branch and the reddened main sequence. The majority of the stars with low reddening are K-type to early M type dwarf stars. Giant stars are generally more distant and suffer higher reddening, so the giant branch becomes clearly defined only at $(J - H) > 1.2$, $(H - K) > 0.6$. Some curvature of the reddening sequences is apparent, which we attribute to the change in the effective wavelengths of the JHK bandpasses at high reddening. The number of photometric outliers can be greatly reduced by using additional quality information in the archive, eg. using source ellipticity to remove binaries which are unresolved in one or two of the passbands. This will be explored fully in a later paper.

Since the main sequence curve is almost parallel to the reddening vector it appears that additional col-

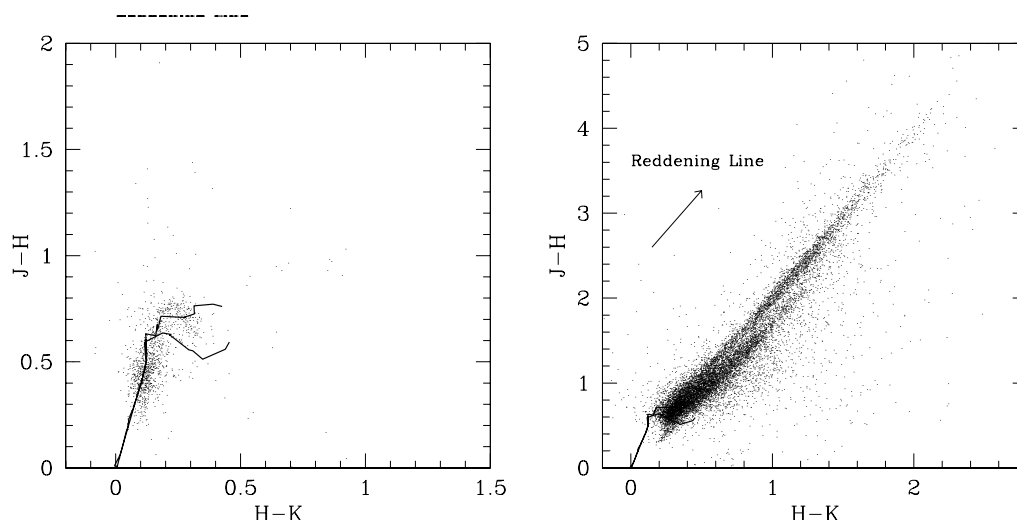

Figure 10. Two colour diagrams for two individual array detectors (12.8 arcmin fields), showing sources listed as having errors < 0.05 mag on each axis in the WSA. **Left hand panel** : an uncrowded field with low extinction at $(l, b)=171.2, 4.8$, showing 1236 sources. **Right Hand panel** : a crowded field with high extinction at $(l, b)=15.0, 0.0$, showing 12954 sources. In each panel the lower curves shows the locus of the main sequence, and the upper curve shows the locus of luminosity class III giants. Even in the crowded field the photometric precision is good enough to show the 0.25 mag vertical separation between the reddened giant sequence and the reddened main sequence stars. An approximate reddening vector is plotted in the right hand panel. Some curvature of the reddening sequences is seen in the data, which is attributed to the change in the effective bandpasses at high extinction.

ors will be required to permit precise photometric determinations of source extinction and hence spectral type and luminosity class. For blue sources this will be done with the aid of optical data from the IPHAS survey (www.iphas.org) while for very red sources mid infrared data from the SPITZER-GLIMPSE survey (www.astro.wisc.edu/sirtf/) of part of the galactic plane and later the NASA WISE survey of the whole sky (wise.ssl.berkeley.edu/news.html) may be useful.

Profile fitting photometry will be included in a future release of UKIDSS data if it is found to improve the photometric precision. Experiments with DAOPHOT in IRAF and a preliminary profile fitting scheme for the microstepped data (D. Wyn Evans, private comm.) indicate that it is unlikely to produce a major improvement over aperture photometry but it may be possible to reduce the number of photometric outliers and thereby aid the detection of sources with unusual colours.

In relatively uncrowded regions the aperture photometry reaches close to the target depths at J, H and K (see results in Warren *et al.* 2007). Source confusion does not significantly affect the measured depth ($K=18.1$) in the outer galaxy section of the GPS at $l=142-230$. Even in the inner galaxy section ($-2 < l < 107$) the reduction in sensitivity is < 0.5 mag in most fields. However the sensitivity suffers more in the most crowded parts of the mid-plane as the Galactic Centre is approached, eg. it is reduced by 1.5 mag at $l=15, b=0$.

A full analysis of the data quality in the GPS and some results from the SV data will be presented in a future paper (Lucas *et al.* in preparation).

6.3 Science Verification results for the GCS

Science verification observations for the GCS yielded 8 tiles in each of the three targets observable at that time: IC 4665, Upper Scorpius and Coma Berenices. In the case of IC 4665, the SV observations complete the required survey for that cluster. In Figure 11 we show a Z versus Z-J colour-magnitude diagram for Upper Scorpius. The observations cover 6 square degrees and approximately 100,000 point sources are detected. Nearly all of these are of course background stars, with perhaps some foreground stars. In Fig 11 we show only those sources with $J > 10.5$ and $Z > 11.5$. The main sequence and giant branch are clearly seen. In addition one can notice a clean sequence to the right of the diagram running from $(Z-J, Z)=(1.0, 12.0)$ to $(Z-J, Z)=(2.5, 19.0)$, which must be the cluster sequence. Candidate cluster members, plotted as large points in Fig. 11, have been isolated first by selection in the Z-J vs Z diagram, and then in Y-J vs J-K to eliminate field dwarfs. Objects brighter than $J=15.8$ are also detected in 2MASS, giving a proper motion estimate which allows a very reliable final determination of cluster membership. For fainter objects we have only the photometric information, but estimate that field contamination is less than 10%. (See Lodieu *et al.* (2007) for details).

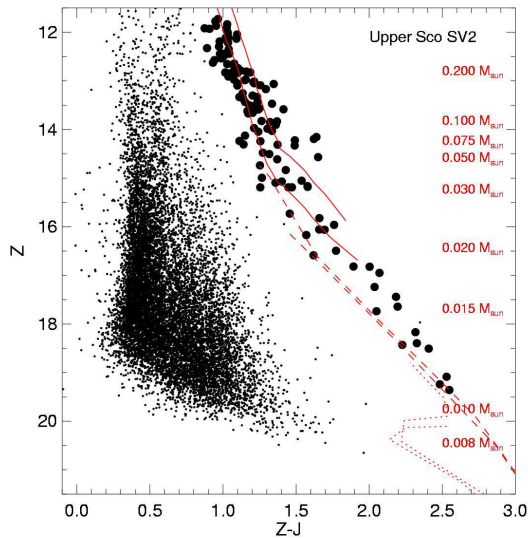

Figure 11. Z vs $Z-J$ diagram for six square degrees in the Upper Sco field, showing only those sources with $J > 10.5$ and $Z > 11.5$. Candidate cluster members have been isolated by colour cuts in multicolour space (see text). One in ten of the field sources are plotted, and all the cluster member candidates. Model isochrones are described in the text. The cluster sequence can be clearly seen following the models well. Objects on or to the right of the model isochrones, and so likely to be cluster members, are plotted as large points. The expected positions of objects of various masses are indicated. Sub-stellar objects are clearly detected.

Overplotted are 5 Myr theoretical isochrones shifted to a distance of 145pc, appropriate for the estimated age and distance of Upper Sco : BCAH98 or NextGen models (solid line; Baraffe *et al.* 1998), DUSTY or BCAH00 (dashed line; Chabrier *et al.* 2000), and COND03 (dotted line; Baraffe *et al.* 2003). These isochrones were specifically computed for the WFCAM filters (Isabelle Baraffe and France Allard; personal communication). On these isochrones we also indicate object masses. We can clearly see therefore that we are indeed locating brown dwarfs within the cluster and will be able to derive a substellar mass function all the way down to 10 Jupiter masses.

6.4 Science Verification results for the DXS and UDS

The DXS and UDS undertook a joint science verification programme to establish the performance of WFCAM for deeper exposures. Fig 12 shows the K-band number counts from an accumulated exposure of 1.5 hours (6 hours of data) on a single tile in the ELAIS-N1 field. Simulations show that the 50% completeness limit in this field is $K=20.3$, significantly shallower than the expected 5σ limit in this time.

This is partly but not wholly because of poorer than average seeing in the SV observations. The reason for this discrepancy is discussed in section 7. Note that this figure includes both stars and galaxies. For comparison, we show number counts from several other surveys. This figure illustrates the power of UKIDSS, as we can determine number counts accurately from a single tile. When the survey is complete, we will therefore be relatively immune to cosmic variance.

One of the scientific goals of DXS and UDS is to locate Extremely Red Objects (EROs). Again, with a tiny fraction of the eventual survey data we are already competitive with all previous studies. Using the same UKIDSS SV data as above, we cross-match with publicly available optical data from the INT Wide Field Camera Survey⁶, and select EROs as those with $R-K > 5$ down to a limit of $K=19$. This produces a sample of 1660 EROs. The reliability of this sample is limited by the optical data at $R=24$, not by the IR data at $K=19$. Fig. 13 shows the number counts of EROs in these data. Again, we have already duplicated most previous work in these science verification data.

7 SURVEY PROGRESS

The final version of this paper is being written in April 2007. We have made an ‘Early Data Release (EDR)’ (Dye *et al.* 2006), and First and Second Data Releases (DR1 and DR2; Warren *et al.* 2007a,b). The EDR and DR1 papers contain considerable detail on the areas covered, data quality achieved, QC cuts applied, example SQL queries for extracting science ready data, and so on, with the DR2 paper providing an incremental update. DR1 contains approximately 7% of the expected final dataset, with some surveys proceeding faster than others. Table 6 summarises the content of DR1.

7.1 Survey quality achieved

After filtering data through the QC process, UKIDSS is achieving its design goals, with the partial exception of depth in stacked surveys, which is expected to improve in later releases. Except where noted, the statistics quoted below refer to measurements made from the DR1 database. Distributions of these quantities are shown in Warren *et al.* (2007a).

Image Quality. The median seeing in DR1 is $0.82^{+0.15}_{-0.13}$ ”, and the median stellar ellipticity is $0.07^{+0.04}_{-0.02}$ (1σ ranges). These figures are expected to improve slightly in later releases ; nights used in the first half of DR1 had imperfect alignment of the optics and flexure correction. In QC filtering, seeing cuts

⁶ <http://www.ast.cam.ac.uk/~wfcSUR/>

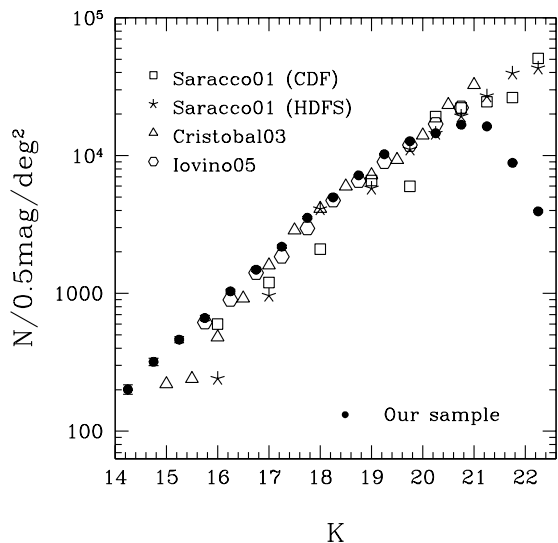

Figure 12. *K*-band number counts from six hours of UKIDSS DXS/UDS SV observations of a single tile in the ELAIS N1 field. Results from the literature are shown for comparison. Note that the UKIDSS number counts include both stars and galaxies.

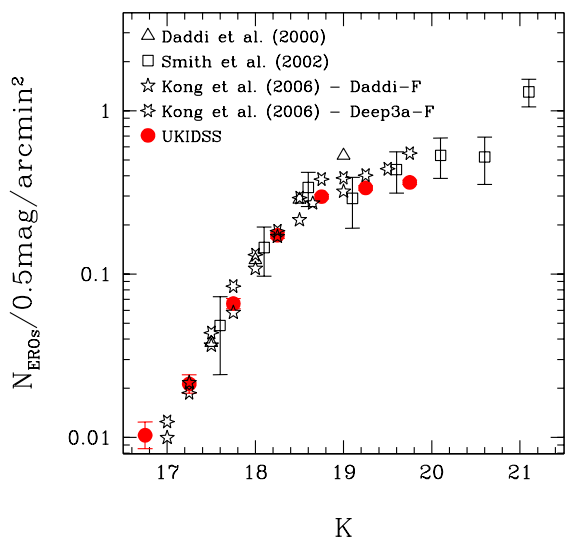

Figure 13. Number counts of Extremely Red Objects (EROs), taken from the same DXS/UDS SV field as in Figure 12, but selected to have $R - K > 5.0$. These are compared with ERO counts from the literature, although note that Smith *et al.* (2002) use a slightly different selection criterion ($R - K > 5.3$).

were applied to the various surveys, roughly as indicated in Table 2.

Photometric Accuracy. Calibration uses 2MASS stars over the whole of each frame, and the internal dispersion indicates that locally we are reaching the target accuracy of 0.02 mag RMS., and that frame gradients are negligible. We also have compared

the average colours of stars from field to field, which gives colour accuracies of 0.02 – 0.03 mag, indicating that photometric errors are less than 0.02 mag in all filters. The global uniformity is currently as good as the 2MASS survey itself allows, which is believed to be 2% (Nikolaev *et al.* 2000). As well as calibrating from 2MASS, we are collecting observations of UKIRT faint standards, with which we will check uniformity at faint magnitudes (Hodgkin *et al.* in preparation). All the above applies to an average star in an average field. The analysis of DR1 found some small but clear variation depending on stellar type and local extinction, indicating that some improvement is needed in colour transformations between the 2MASS and UKIDSS systems. These will be applied in DR2.

Astrometric Accuracy. Astrometric accuracy was considered in some detail in the EDR (Dye *et al.* 2006). As with photometry, the astrometric calibration is tied to 2MASS stars, which in turn are tied to the Tycho system. The global uniformity therefore assumes that of 2MASS, although this will in due course be checked independently. The precision of the astrometric solution changes with Galactic latitude, because of the number of 2MASS stars available for solution. The RMS accuracy varies from 50mas at low latitudes to 100mas at high latitudes.

Depth. The depth achieved in the shallow surveys is close to expectation. From LAS data in DR1, the median 5σ point source depth in the standard 40 second shots, compared to target depths is $Y=20.16$ (20.3), $J=19.56$ (19.5), $H=18.81$ (18.6), and $K=18.19$ (18.2). From the GCS, the Z depth achieved is $Z=20.36$ (20.4). For most surveys, this is a good guide to actual achieved catalogue depth, but in due course this will be analysed more fully in terms of completeness and reliability. For the GPS in particular, the effective depth is very sensitive to confusion, and so varies with position on the sky (see Warren *et al.* 2007). For the stacked surveys, experience so far has borne out what we found in the SV data - the depth achieved falls somewhat short of the naive \sqrt{N} extrapolation. In the current pipeline output for the DXS, we are a few tenths of a magnitude short of target. At the eventual depth of the UDS, $K=23$, we expect of the order 100 galaxies per sq. arcmin, which should produce significant correlated confusion noise, as seen in other very deep IR surveys, such as the ISAAC FIRES survey of Labbé *et al.* (2003). However, we are still some way short of this depth. The reason for the stacked survey depth discrepancy is currently unclear. It is possible that pipeline improvements and more careful analysis will remove much of this discrepancy. Further analysis will be provided in later data release papers.

Database utility. The VDFS pipeline and archive system has delivered more or less what was required for UKIDSS, including reduced data quality and the ability to perform catalogue queries online. There are known processing limitations, listed on the

Survey	Area deg ² all (any) filters	Filters	K-depth 5 σ Vega	Compn
LAS	190 (475)	YJHK	18.2	6%
GCS	52 (401)	ZYJHK	18.2	13%
GPS	77 (362)	JHKH ₂	18.1	7%
DXS	3.1 (6.9)	JK	20.7	11%
UDS	0.8 (0.8)	JK	21.6	4%

Table 6. Summary contents of the UKIDSS First Data Release (Warren *et al.* 2007). Depth achieved is shown only for the K-band, and the ‘all’ area is that with data achieving that depth and covered in all relevant bands. The completion estimate takes account of all filters, and areas with partial depth.

WSA web page. These are relatively minor, with two main exceptions. The first is that profile magnitudes have not yet been implemented, which is potentially important for GPS analysis. The second is that deep stacking is not yet optimal. For this reason, the UDS working group have created their own image stack and deep catalogue outside the VDFS system; however this has been supplied to the WSA and is currently used as the publicly available product. Both of these issues will be resolved for later releases.

Reliability and completeness. We have so far made only a preliminary study of completeness as a function of depth, or the number of spurious sources, for the various UKIDSS products. This is partly because they are *databases* rather than statistically defined catalogues. A number of different catalogues can be extracted from the databases, defined with different cuts on quality parameters etc. No single catalogue is perfect - rather these should be extracted by users of the UKIDSS databases for specific scientific purposes. However, as the UKIDSS consortium, we will provide the best possible quality flags, and in due course we will produce an analysis of representative catalogues as a guidance to users. Given that many scientific uses of UKIDSS will involve looking for rare or anomalous objects, reducing contamination by spurious sources due to data artefacts, and wrong colours due to incorrect band-merging, are both crucial. The frequency and nature of artefacts is discussed in Dye *et al.* (2006) and Warren *et al.* (2007), and source merging is discussed in detail in Hambly *et al.* (in preparation), but we have not yet estimated the density of spurious sources or incorrect mergers. Source variability can also mimic unusual colours, given that some passbands are measured at separate epochs. This can only be assessed by attempting the relevant science projects. When this issue clarifies, later data release papers will include an estimate of the problem.

7.2 Survey completion rate

Up to DR1 release, the rate at which the survey has accumulated has been slower than hoped. Raw data has been collected on average at 79% of the rate planned, and in addition 20% of data frames have failed our QC filtering, so that the net survey progress rate has been 63% of our goal. Since completion of DR1 observing, two major problems - bright moon ghosts, and an unexpectedly high data acquisition system overhead - have been solved. Our current estimate is that the net survey progress rate is now $\sim 80\%$ of goal. Within the first two years of UKIDSS, we expect to have completed approximately 2/3 of our two year plan. To achieve the full design parameters of Table 3 will take approximately 1150 nights. The fraction of UKIRT time dedicated to WFCAM is under review, so the number of years required, and/or the adjusted survey parameters, are currently uncertain.

7.3 First utilisation of UKIDSS

In section 6 we have shown analyses undertaken by the consortium with science verification data. Since EDR and DR1, the first open community exploitation of UKIDSS has begun. Use of the UKIDSS databases in the WSA has been extensive. As of the end of 2006, over a billion rows of catalogue data have been downloaded, and interesting results are starting to emerge. The first very high redshift quasar ($z=5.86$) has been found by Venemans *et al.* (2007). McLure *et al.* (2006) have reported the discovery of nine of the most luminous known Lyman break galaxies, at $5 < z < 6$ - they are surprisingly massive so soon (1.2 Gyr) after the Big Bang. A sample of 239 Distant red Galaxies (DRGs) at $2 < z < 3$ has been selected by Foucaud *et al.* (2007) and their angular correlation function measured. Cirasuolo *et al.* (2007) have measured the evolution of the K-band galaxy luminosity function to $z \simeq 2$. The coolest known brown dwarf (classified T8.5) has been found by Warren *et al.* (2007c; spectrum shown in Warren *et al.* 2006). Lodieu *et al.* (2007) have found 129 new brown dwarfs, a significant fraction of the total known, including a dozen below 20 Jupiter masses. Large new samples of quasars, distant galaxy clusters, and extremely red objects have been constructed by Chiu *et al.* (2007), Van Breukelen *et al.* (2006), and Simpson *et al.* (2006) respectively.

7.4 Survey releases

Data access policy for UKIDSS is set by the UKIRT Board, and is set out on the JAC web pages⁷. UKIDSS is intended to produce multi-use data of

⁷ <http://www.jach.hawaii.edu/UKIRT/surveys/UKIDSSdatapolicies.html>

general benefit to astronomers worldwide, but with a temporary advantage for the communities that developed the camera and surveys. Initially this meant UK astronomers, but now means any astronomer currently working in an ESO member state. The general principle is that the data are freely available to any such astronomer from the point of release, and available worldwide eighteen months later. (Note that individual members of the consortium have no privileged data access.) During the ESO-restricted phase, data access requires registration with the WSA. This is organised through a set of “community contacts” at astronomical institutions in ESO member states, who maintain their own databases of local users through the WSA system. Any reader who is not yet registered who believes they are eligible should contact their local community contact, or if necessary ask for a new community contact to be established. Fuller instructions and a list of current contacts is on the UKIDSS web page (<http://www.ukidss.org/archive/archive.html>).

It is intended to make UKIDSS data available in a series of well defined staged releases. As well as involving incrementally more data, releases will usually involve reprocessing of data from previous releases, with updated correction of artefacts and so on. Each release will therefore be documented by a paper describing the contents and limitations of that release. The first preliminary release, available from Feb 10th 2006, had a relatively small amount of data (about 1% of the expected total), and several known imperfections in the data processing. This was therefore labelled an “Early Data Release (EDR)”. It is described in more detail in Dye *et al.* (2006). The first full data release (DR1) took place on July 21st 2006. It contains 7% of the intended final data volume, and has substantially better data quality than the EDR in a variety of ways. It is described in Warren *et al.* (2007a). At the time of final revisions to this paper, the Second Data Release (DR2) has also recently taken place, with updated details in an online-only paper (Warren *et al.* 2007b).

Further releases are likely to take place thereafter every six months or so. Raw WFCAM data are available through the ESO archive system (<http://www.eso.org>) and through the CASU site (<http://archive.ast.cam.ac.uk/wfcam/>). All of the UKIDSS processed images and catalogues are accessible and queryable through the web-based WFCAM Science Archive (WSA : <http://surveys.roe.ac.uk/wsa>).

8 ACKNOWLEDGEMENTS

This paper is written on behalf of the entire UKIDSS consortium. The membership list can be found at <http://www.ukidss.org>. The formal authorship includes the heads of the various UKIDSS working

groups, plus a small number of other individuals. In addition to the bulk of the consortium, there are others we would like to thank. First and foremost, the UKIDSS enterprise would be impossible without the staff of UKIRT, the staff at UKATC who built WFCAM, and the staff of CASU and WFAU who built the data processing system. Next, we would like to note that much of UKIDSS, including its scientific ambition, design, data flow concepts, and release plan, has been built upon the preceding ideas and high professional standards of the SDSS and 2MASS teams. Finally we would like to thank the anonymous referee, whose detailed and thoughtful comments improved this paper significantly.

9 REFERENCES

- Allen, C.W., 1973, *Astrophysical Quantities*, 3rd edition (University of London; Athlone)
- Baraffe, I., Chabrier, G., Allard, F., Hauschildt, P. H. 1998, *A&A*, 337, 403
- Baraffe, I., Chabrier, G., Barman, T.S., Allard, F., Hauschildt, P. H. 2003, *A&A*, 402, 701
- Bell, E.F., McIntosh, D.H., Katz, N., Weinberg, M.D. 2003 *ApJS* 149, 289
- van Breukelen, C., Clewley, L., Bonfield, D.G., Rawlings, S., Jarvis, M.J., Barr, J.M., Foucaud, S., Almaini, O., Cirasuolo, M., Dalton, G., Dunlop, J.S., Edge, A.C., Hirst, P., McLure, R.J., Page, M.J., Sekiguchi, K., Simpson, C., Smail, I., Watson, M.G., 2006, *MNRAS*, 373, L26.
- Burrows, A., Sudarsky, D., and Lunine, J.I., 2003, *ApJ*, 596, 587.
- Casali, M.M., Adamson, A.A., Alves de Oliveira, C., *et al.* 2007, *A&A* 467, 777
- Chabrier, G., Baraffe, I., Allard, F., Hauschildt, P. H. 2000, *ApJ*, 542, 464
- Chiu, K., Richards, G.T., Hewett, P.C., Maddox, N., 2007, *MNRAS*, 375, 1180 ([astro-ph/0612608](http://arxiv.org/abs/astro-ph/0612608))
- Cristobal, D., Prieto, M., Balcells, M., Guzman, R., Cardiel, N., Serrano, A., Gallego, J., Pello, R. 2003, *Science with the GTC Eds. J. Espinosa, F. Lopez, and V. Martin* *Revista Mexicana de Astronomia y Astrofisica (Serie de Conferencias)* Vol. 16, pp. 267
- Cirasuolo, M., McLure, R.J., Dunlop, J.S., Almaini, O., Foucaud, S., Smail, I., Sekiguchi, K., Simpson, C., Eales, S., Dye, S., Watson, M.G., Page, M.J., Hirst, P., 2007, *MNRAS* submitted ([astro-ph/0609287](http://arxiv.org/abs/astro-ph/0609287))
- Daddi, E., Cimatti, A., Pozzetti, L., *et al.* 2000, *A&A*, 361, 535
- Dalton, G.B., Calswell, M., Ward, K., *et al.* 2004, *SPiE*, 5492, 988.
- Dye, S., Warren, S.J., Hambly, N.C., *et al.* 2006, *MNRAS*, 372, 1227.
- Egan M P, Price S D, 1996 *AJ* 112, 2862

- Fan, X., Strauss, M.A., Richards, G.T., *et al.* 2001, AJ, 121, 31.
- Foucaud, S., Almaini, O., Smail, I., Conselice, C.J., Lane, K.P., Edge, A.C., Simpson, C., Dunlop, J.S., McLure, R.J., Cirasuolo, M., Hirst, P., Watson, M.G., Page, M.J., 2007, MNRAS, 376, L20.
- Hambly, N. C., Hodgkin, S. T., Cossburn, M. R., Jameson, R. F., 1999, MNRAS, 303, 835.
- Hambly, N. C., MacGillivray, H. T., Read, M. A., *et al.* 2001 MNRAS 326, 1279.
- Hambly, N.C., Read, M., Mann, R., Sutorius, E., Bond, I., MacGillivray, H., Williams, P., Lawrence, A., 2004a, ASP Conf.Proc. 314 137
- Hambly, N.C., *et al.* , 2004b, In: Optimizing Scientific Return for Astronomy through Information Technologies, Proceedings of the SPIE, 5493, 423 (2004)
- Hasegawa T., Oka T., Sato F., Tsuboi M., Yamazaki A. 1998, in ‘The central region of the Galaxy and galaxies’, ed. Y.Sofue, Proc. IAU Symp. 184, p.171 (Dordrecht:Kluwer)
- Hawarden, T.G., Leggett, S. K., Letawsky, M.B., Ballantyne, D.R., Casali, M.M., 2001, MNRAS 325 563
- Hewett, P.C., Warren, S.J., Leggett, S.K., Hodgkin, S.L., 2006 MNRAS, 367, 454.
- Irwin M.J., 1985, MNRAS 214, 575.
- Iovino, A., McCracken, H. J., Garilli, B., *et al.* 2005, A&A 442, 423
- Jiang Z., Yao Y., Yang J., Ando M., Kato D., Kawai T., Kurita M., Nagata T., Nagayama T., Nakajima Y., Nagashima C., Sato S., Tamura M., Nakaya H., Sugitani K. 2002, AJ 577, 245
- Knapp G.R., Leggett S.K., Fan X. 2004, AJ 127 3553.
- Kong, X., Daddi, E., Arimoto, N., *et al.* 2006, ApJ 638 72.
- Labbé I., *et al.* , 2003, AJ, 125, 1107
- Leggett, S. K., Geballe, T. R., Fan, X., *et al.* 2000, ApJ, 536, L35.
- Leggett, S.K., F. Allard, F., Burgasser, A.J., 2005, Proceedings of the 13th Cool Stars Workshop, ed. F.Favata, ESA Special Publications Series, ESA SP-560, p.143 (astro-ph/0409389).
- Lodieu, N., Hambly, N.C., Jameson, R.F., Hodgkin, S.T., Carraro, G., Kendall, T.R., 2007, MNRAS, 374, 372.
- Lopez-Corredoira, M., Cabrera-Lavers, A., Garz, F., Hammersley, P. L., 2002, A&A, 394, 883
- Martín, E.L., Magazzù, A., 2007, AN, in press
- McLure, R.J., Cirasuolo, M., Dunlop, J.S., Sekiguchi, K., Almaini, O., Foucaud, S., Simpson, C., Watson, M.G., Hirst, P., Page, M.J., Smail, I., 2006, MNRAS 372, 357.
- Moraux, E., *et al.* , 2007, AN, in press
- Nikolaev, S., Weinberg, M.D., Skrutskie, M.F., Cutri, R.M., Wheelock, S.L., Gizis, J.E., Howard, E.M., 2000, AJ, 120, 3340.
- Puget, P., Stadler, E., Doyon, R., *et al.* 2004, SPIE, 5492, 978.
- Robichon, N., Arenou, F., Turon, C., Mermilliod, J.C., 1999, A&A, 345, 471
- Sabbey, C.N., Coppi, P., Oemler, A., 1998, PASP, 110, 1067
- Saracco, P., Giallongo, E., Cristiani, S., D’Odorico, S., Fontana, A., Iovino, A., Poli, F., Vanzella, E. 2001, A&A 375, 1
- Schneider D. P., Gunn J. E., Hoessel J. G., 1983, ApJ, 264, 337
- Simpson, S., Almaini, O., Cirasuolo, M., Dunlop, J., Foucaud, S., Hirst, P., Ivison, R., Page, M., Rawlings, S., Sekiguchi, K., Smail, I., Watson, M., 2006, MNRAS, 373, L21.
- Skrutskie M.F., Cutri R.M., Stiening, R., *et al.* 2006, AJ, 131, 1163.
- Smith, G.P., Smail, I., Kneib, J.-P, *et al.* , 2002, MNRAS, 330, 1.
- Songaila., A., Cowie, L.L., Hu, E.M., Gardner, J.P., 1994 ApJS, 94, 461.
- Ungerechts H, Thaddeus P, 1987 ApJS 63, 645
- Venemans, B.P., McMahon, R.G., Warren, S.J., Gonzalez-Solares, E.A., Hewett, P.C., D. J. Mortlock, D.J., Dye, S., Sharp, R.G., 2007, MNRAS, 376, 76
- Wang Q., Gotthelf E., & Lang C. 2002, Nature, 415, 148
- Warren, S.J., Hewett, P.C., Foltz, C.B, 2000, MNRAS, 312, 827
- Warren, S.J., Lawrence, A., Almaini, O., *et al.* , 2006, ESO Messenger, 126, 7
- Warren, S.J., Hambly, N.C., Dye, S., *et al.* 2007a, MNRAS, 375, 213.
- Warren, S.J., Cross, N.J.G., Dye, S., *et al.* 2007b, astro-ph/0703037.
- Warren, S.J., Mortlock, D.J., Leggett, S.K., *et al.* 2007c, MNRAS submitted.
- York, D.G., Adelman, J., Anderson, J.E., *et al.* 2000, AJ, 120, 1579
- de Zeeuw, P.T., Hoogerwerf, R., de Bruijne, J.H.J., 1999, AJ, 117 354