

FRACTALS AND THE DISTRIBUTION OF GALAXIES

Marcelo B. Ribeiro¹ & Alexandre Y. Miguelote²

Observatório Nacional–CNPq, Rio de Janeiro, Brazil

Abstract: This paper presents a review of the fractal approach for describing the large scale distribution of galaxies. We start by presenting a brief, but general, introduction to fractals, which emphasizes their empirical side and applications rather than their mathematical side. Then we discuss the standard correlation function analysis of galaxy catalogues and many observational facts that brought increasing doubts about the reliability of this method, paying special attention to the standard analysis implicit assumption of an eventual homogeneity of the distribution of galaxies. Some new statistical concepts for analysing this distribution is presented, and without the implicit assumption of homogeneity they bring support to the hypothesis that the distribution of galaxies does form a fractal system. The Pietronero-Wertz's single fractal (hierarchical) model is presented and discussed, together with the implications of this new approach for understanding galaxy clustering.

1 Introduction

The goal of modern cosmology is to find the large scale matter distribution and spacetime structure of the Universe from astronomical observations, and it dates back from the early days of observational cosmology the realization that in order to achieve this aim it is essential that an accurate empirical description of galaxy clustering be derived from the systematic observations of distant galaxies. As time has passed, this realization has become a program, which in the last decade or so took a great impulse forward due to improvements in astronomical data acquisition techniques and data analysis. As a result of that an enormous amount of data about the observable universe was accumulated in the form of the now well-known *redshift surveys*, and some widely accepted conclusions drawn from these data created a certain confidence in many researchers that such an accurate description of the distribution of galaxies was just about to being achieved. However, those conclusions are mainly based in a

¹ Present address: *Dept. Física Matemática, Instituto de Física–UFRJ, Caixa Postal 68528, Ilha do Fundão, Rio de Janeiro, RJ 21945-970, Brazil; E-mail: mbr@if.ufrj.br.*

² Former participant of the PIBIC program at Observatório Nacional–CNPq. Present address: *Engenharia de Sistemas e Computação, Coppe-UFRJ, Ilha do Fundão, Rio de Janeiro, Brazil; E-mail: yasuda@cos.ufrj.br.*

standard statistical analysis derived from a scenario provided by the standard Friedmannian cosmological models, which assume homogeneity and isotropy of the matter distribution, scenario which is still thought by many to be the best theoretical framework capable of explaining the large scale matter distribution and spacetime structure of the Universe.

The view outlined above, which now has become the orthodox homogeneous universe view, has, however, never been able to fully overcome some of its objections. In particular, many researchers felt in the past, and others still feel today, that the relativistic derived idea of an eventual homogenization of the *observed* matter distribution of the Universe is flawed, since, in their view, the empirical evidence collected from the systematic observation of distant cosmological sources also supports the claim that the universal distribution of matter will not eventually homogenize. Therefore, the critical voice claims that the large-scale distribution of matter in the Universe is intrinsically inhomogeneously distributed, from the smallest to the largest observed scales and, perhaps, indefinitely.

Despite this, it is a historical fact that the inhomogeneous view has never been as developed as the orthodox view, and perhaps the major cause for this situation was the lack of workable models supporting this inhomogeneous claim. There has been, however, one major exception, in the form of a hierarchical cosmological model advanced by Wertz (1970, 1971), although, for reasons that will be explained below, it has unfortunately remained largely ignored so far.

Nevertheless, by the mid 1980's those objections took a new vigour with the arrival of a new method for describing galaxy clustering based on ideas of a radically new geometrical perspective for the description of irregular patterns in nature: *the fractal geometry*.

In this review we intend to show the basic ideas behind this new approach for the galaxy clustering problem. We will not present the orthodox traditional view since it can be easily found, for instance, in Peebles (1980, 1993) and Davis (1997). Therefore, we shall concentrate ourselves in the challenging voice based on a new viewpoint about the statistical characterization of galaxy clustering, whose results go against many traditional expectations, and which keep open the possibility that the universe never becomes observationally homogeneous. The basic papers where this fractal view for the distribution of galaxies can be found are relatively recent. Most of what will be presented here is based on Pietronero (1987), Pietronero, Montuori and Sylos Labini (1997), and on the comprehensive reviews by Coleman and Pietronero (1992), and Sylos Labini, Montuori and Pietronero (1998).

The plan of the paper is as follows. In section 2 we present a brief, but general, introduction to fractals, which emphasizes their empirical side and applications, but without neglecting their basic mathematical concepts. Section 3 briefly presents the basic current analysis of the large scale distribution of galaxies, its difficulties and, finally, Pietronero-Wertz's single fractal (hierarchical) model that proposes an alternative point of view for describing and analysing this distribution, as well as some of the consequences of such an approach. The paper finishes with a discussion on some aspects of the current controversy about the fractal

approach for describing the distribution of galaxies.

2 Fractals

This section introduces a minimum background material on fractals necessary in this paper and which may be useful for readers not familiar with their basic ideas and methods. Therefore, we shall not present an extensive, let alone comprehensive, discussion of the subject, which can be found in Mandelbrot (1983), Feder (1988), Takayasu (1990) and Peitgen, Jürgens and Saupe (1992), if the reader is more interested in the intuitive notions associated with fractals and their applications, or in Barnsley (1988) and Falconer (1990) if the interest is more mathematical. The literature on this subject is currently growing at a bewildering pace and those books represent just a small selection that can be used for different purposes when dealing with fractals. This section consists mainly of a summary of a background material basically selected from these sources. The discussion starts on the mathematical aspects associated with fractals, but gradually there is a growing emphasis on applications.

2.1 On the “Definition” of Fractals

The name *fractal* was introduced by Benoit B. Mandelbrot to characterize geometrical figures which are not smooth or regular. By adopting the saying in Latin that *nomen est numen*,³ he decided to “exert the right of naming newly opened or newly settled territory landmarks.” Thus, he “coined *fractal* from the Latin adjective *fractus*. The corresponding Latin verb *frangere* means ‘to break:’ to create irregular fragments. It is therefore sensible (...) that, in addition to ‘fragmented’ (as in *fraction* or *refraction*), *fractus* should also mean ‘irregular’, both meanings being preserved in *fragment*” (Mandelbrot 1983, p. 4).

In attempting to define fractals mathematically, Mandelbrot (1983) offered the following: “A fractal is by definition a set for which the Hausdorff-Besicovitch dimension strictly exceeds the topological dimension”. We shall discuss later the Hausdorff dimension, but the important point here is that Mandelbrot himself has since retreated from this original tentative definition as it proved to be unsatisfactory, in the sense that it excluded some sets which ought to be regarded as fractals. In a private communication to J. Feder, Mandelbrot proposed instead the following loose tentative definition: “a fractal is a shape made of parts similar to the whole in some way” (Feder 1988, p. 11). Even so, in the school on “Fractal Geometry and Analysis” that took place in Montreal in 1989, and was attended by one of us (MBR)⁴, Mandelbrot declined to discuss the problem of definition by arguing that any one would be restrictive and, perhaps, it would be best to consider fractals as a collection of techniques and methods applicable in the study of these irregular, broken and self-similar geometrical patterns.

³ To name is to know.

⁴ See Bélair and Dubuc (1991).

Falconer (1990) offers the following point of view on this matter.

“The definition of a ‘fractal’ should be regarded in the same way as the biologist regards the definition of ‘life’. There is no hard and fast definition, but just a list of properties characteristic of a living thing, such as the ability to reproduce or to move or to exist to some extent independently of the environment. Most living things have most of the characteristics on the list, though there are living objects that are exceptions to each of them. In the same way, it seems best to regard a fractal as a set that has properties such as those listed below, rather than to look for a precise definition which will almost certainly exclude some interesting cases. (...) When we refer to a set F as a fractal, therefore, we will typically have the following in mind.

1. F has a fine structure, i.e., detail on arbitrarily small scales.
2. F is too irregular to be described in traditional geometrical language, both locally and globally.
3. Often F has some form of self-similarity, perhaps approximate or statistical.
4. Usually, the ‘fractal dimension’ of F (defined in some way) is greater than its topological dimension.
5. In most cases of interest F is defined in a very simple way, perhaps recursively.”

It is clear that Falconer’s “definition” of fractals includes Mandelbrot’s loose tentative one quoted above. Moreover, Falconer keeps open the possibility that a given fractal shape can be characterized by more than one definition of fractal dimension, and they do not necessarily need to coincide with each other, although they have in common the property of being able to take fractional values. Therefore, an important aspect of studying a fractal structure (once it is characterized as such by, say, at least being recognized as self-similar in some way) is the choice of a definition for fractal dimension that best applies to, or is derived from, the case in study. As the current trend appears to indicate that this absence of a strict definition for fractals will prevail, the word fractal can be, and in fact is, even among specialists, used as a generic noun, and sometimes as an adjective.

Fractal geometry has been considered a revolution in the way we are able to mathematically represent and study figures, sets and functions. In the past sets or functions that are not sufficiently smooth or regular tended to be ignored as “pathological” or considered as mathematical “monsters”, and not worthy of study, being regarded only as individual curiosities. Nowadays, there is a realization that a lot can and is worth being said about non-smooth sets. Besides, irregular and broken sets provide a much better representation of many phenomena than do the figures of classical geometry.

2.2 The Hausdorff Dimension

An important step in the understanding of fractal dimensions is for one to be introduced to the *Hausdorff-Besicovitch dimension* (often known simply as *Hausdorff dimension*). It was first introduced by F. Hausdorff in 1919 and developed later in the 1930’s by A. S. Besicovitch

and his students. It can take non-integer values and was found to coincide with many other definitions.

In obtaining the dimension that bears his name, Hausdorff used the idea of defining measures using covers of sets first proposed by C. Carathéodory in 1914. Here in this article, however, we shall avoid a formal mathematical demonstration of the Hausdorff measure, and keep the discussion in intuitive terms. We shall therefore offer an *illustration* of the Hausdorff measure whose final result is the same as achieved by the formal proof found, for instance, in Falconer (1990).

The basic question to answer is: how do we measure the “size” of a set F of points in space? A simple manner of measuring the length of curves, the area of surfaces or the volume of objects is to divide the space into small cubes of diameter δ as shown in figure 1. Small

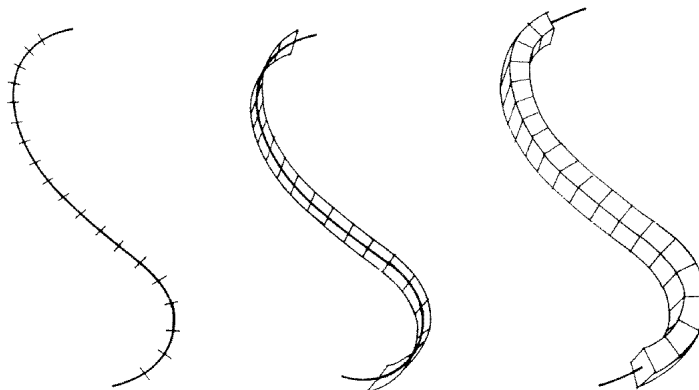

Figure 1: Measuring the “size” of curves (Feder 1988).

spheres of diameter δ could have been used instead. Then the curve can be measured by finding the number $N(\delta)$ of line segments of length δ needed to cover the line. Obviously for an ordinary curve we have $N(\delta) = L_*/\delta$. The length of the curve is given by

$$L = N(\delta)\delta \xrightarrow{\delta \rightarrow 0} L_*\delta^0.$$

In the limit $\delta \rightarrow 0$, the measure L becomes asymptotically equal to the length of the curve and is independent of δ .

In a similar way we can associate an area with the set of points defining a curve by obtaining the number of disks or squares needed to cover the curve. In the case of squares where each one has an area of δ^2 , the number of squares $N(\delta)$ gives an associated area

$$A = N(\delta)\delta^2 \xrightarrow{\delta \rightarrow 0} L_*\delta^1.$$

In a similar fashion the volume V associated with the line is given by

$$V = N(\delta)\delta^3 \xrightarrow{\delta \rightarrow 0} L_*\delta^2.$$

Now, for ordinary curves both A and V tend to zero as δ vanishes, and the only interesting measure is the length of the curve.

Let us consider now a set of points that define a surface as illustrated in figure 2. The normal measure is the area A , and so we have

$$A = N(\delta)\delta^2 \xrightarrow{\delta \rightarrow 0} A_*\delta^0.$$

Here we find that for an ordinary surface the number of squares needed to cover it is

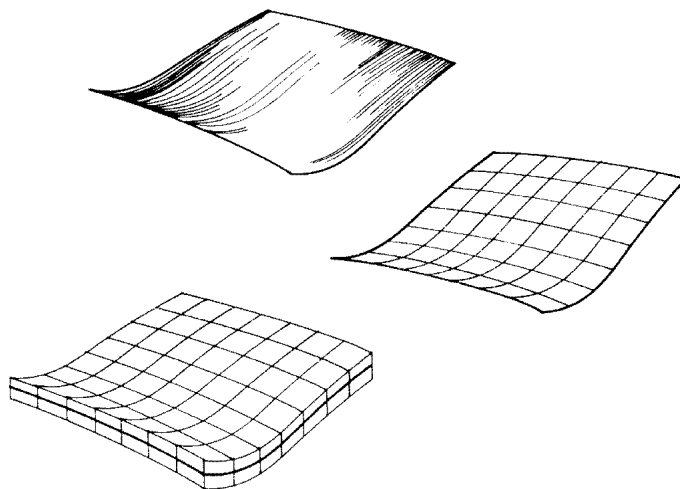

Figure 2: Measuring the “size” of a surface (Feder 1988).

$N(\delta) = A_*/\delta^2$ in limit of vanishing δ , where A_* is the area of the surface. We may associate a volume with the surface by forming the sum of the volumes of the cubes needed to cover the surface:

$$V = N(\delta)\delta^3 \xrightarrow{\delta \rightarrow 0} A_*\delta^1.$$

This volume vanishes as $\delta \rightarrow 0$, as expected.

Now, can we associate a *length* with a surface? Formally we can simply take the measure

$$L = N(\delta)\delta \rightarrow A_*\delta^{-1},$$

which diverges for $\delta \rightarrow 0$. This is a reasonable result since it is impossible to cover a surface with a finite number of line segments. We conclude that the only useful measure of a set of points defined by a surface in three-dimensional space is the area.

There are curves, however, that twist so badly that their length is infinite, but they are such that they fill the plane (they have the generic name of *Peano curves*⁵). Also there are surfaces that fold so wildly that they fill the space. We can discuss such strange sets of points if we generalize the measure of size just discussed.

⁵ See §2.3.1

So far, in order to give a measure of the size of a set F of points, in space we have taken a test function $h(\delta) = \gamma(d)\delta^d$ – a line, a square, a disk, a ball or a cube – and have covered the set to form the *measure* $H_d(F) = \sum h(\delta)$. For lines, squares and cubes we have the geometrical factor $\gamma(d) = 1$. In general we find that, as $\delta \rightarrow 0$, the measure $H_d(F)$ is either infinite or zero depending on the choice of d , the dimension of the measure. The Hausdorff dimension D of the set F is the *critical dimension* for which the measure $H_d(F)$ jumps from infinity to zero (see figure 3):

$$H_d(F) = \sum \gamma(d)\delta^d = \gamma(d)N(\delta)\delta^d \xrightarrow{\delta \rightarrow 0} \begin{cases} 0, & d > D, \\ \infty, & d < D. \end{cases} \quad (1)$$

The quantity $H_d(F)$ is called the d -measure of the set and its value for $d = D$ is often finite,

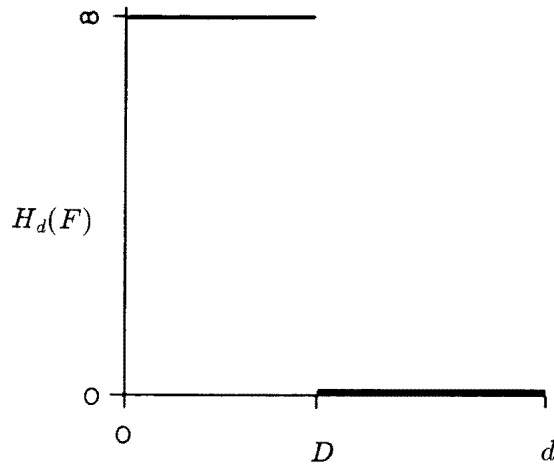

Figure 3: Graph of $H_d(F)$ against d for a set F . The Hausdorff dimension is the critical value of d at which the jump from ∞ to 0 occurs (Falconer 1990).

but may be zero or infinity. It is the position of the jump in H_d as function of d that is important. Note that this definition means the Hausdorff dimension D is a local property in the sense that it measures properties of sets of points in the limit of a vanishing diameter of size δ of the test function used to cover the set. It also follows that the D may depend on position. There are several points and details to be considered, but they are not important for us here (see Falconer 1990).

The familiar cases are $D = 1$ for lines, $D = 2$ for planes and surfaces and $D = 3$ for spheres and other finite volumes. There are innumerable sets, however, for which the Hausdorff dimension is noninteger and is said to be fractal. In other words, because the jump of the measure $H_d(F)$ can happen at noninteger values of d , when $H_d(F)$ is calculated for irregular and broken sets the value D where the jump actually occurs is usually noninteger.

2.3 Other Fractal Dimensions and Some Examples of Fractals

The illustration of the Hausdorff dimension shown previously may be very well from a mathematical point of view, but it is hard to get an intuition about the fractal dimension from it. Moreover, we do not have a clear picture of what this fractional value of dimension means. In order to try to answer these questions let us see different definitions of fractal dimension and some examples.

2.3.1 Similarity Dimension and Peano Curves

The fractals we discuss may be considered to be sets of points embedded in space. This space has the usual topological dimension which we are used to, and from a physicist's point of view it coincides with degrees of freedom defined by the number of independent variables. So the location of a point on a line is determined by one real number and a set of two independent real numbers is needed to define a plane. If we define dimension by degrees of freedom in this way, we can consider a d -dimensional space for any non-negative integer d . In fact, in mechanics it is conventional to consider the motion of m particles in 3 dimensions as being the motion of one particle in a $6m$ -dimensional space if we take each particle's location and momentum as independent.

The dimension defined by degrees of freedom seems very natural, but more than 100 years ago it was found to contain a serious flaw. In 1890 Giuseppe Peano described a curve that folds so wildly that it "fills" the plane. We shall describe below what we mean by *plane-filling curves* and how we can generate them, but let us keep this meaning in a qualitative and intuitive form for the moment. The important point is that those *Peano curves* can be drawn with a single stroke and they tend to cover the plane uniformly, being able not only to avoid self-intersection but also self-contact in some cases. Since the location of a point on the Peano curve, like a point in any curve, can be characterized with one real number, we become able to describe the position of any point on a plane with only one real number. Hence the degree of freedom, or the dimension, of this plane becomes 1, which contradicts the empirical value 2. This process of natural parameterization produced by the Peano "curves" was called *Peano motions* or *plane-filling motions* by Mandelbrot (1983, p. 58).

In order to see how Peano curves fill the plane, let us introduce first a new definition of dimension based on similarity. If we divide an unit line segment into N parts (see figure 4) we get at the end of the process each part of the segment scaled by a factor $\delta = 1/N$, which means $N\delta^1 = 1$. If we divide an unit square into N similar parts, each one is scaled by a factor $\delta = 1/N^{1/2}$ (if $N = 4$ the square is scaled by half the side length); so $N\delta^2 = 1$. Now if an unit cube is divided in N parts, each scaled by $\delta = 1/N^{1/3}$ (again if $N = 8$ the cube is scaled by half the side length), we have $N\delta^3 = 1$. Note that the exponents of δ correspond to the space dimensions in each case. Generalising this discussion we may say that for an object

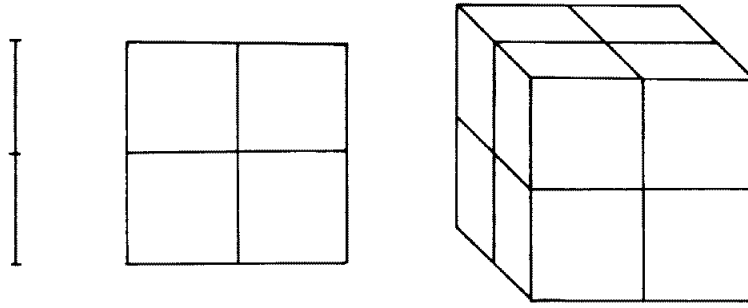

Figure 4: Dividing a segment, a square and a cube (Takayasu 1990).

of N parts, each scaled down from the whole by a ratio δ , the relation $N\delta^D = 1$ defines the *similarity dimension* D of the set as

$$D = \frac{\log N}{\log 1/\delta}. \quad (2)$$

The Hausdorff dimension described previously can be seen as a generalization of this similarity dimension. Unfortunately, similarity dimension is only meaningful for a small class of strictly self-similar sets.

Let us see some examples of calculations of the similarity dimension of sets. Figure 5 shows the construction of the von Koch curve, and any of its segments of unit length is composed of 4 sub-segments each of which is scaled down by a factor $1/3$ from its parent. Therefore, its similarity dimension is $D = \log 4 / \log 3 \cong 1.26$. This non-integer dimension, greater than one but less than two, reflects the properties of the curve. It somehow fills more space than a simple line ($D = 1$), but less than a Euclidean area of the plane ($D = 2$). The figure 5 also shows that the von Koch curve has a finite structure which is reflected in irregularities at all scales; nonetheless, this intricate structure stems from a basically simple construction. Whilst it is reasonable to call it a curve, it is too irregular to have tangents in the classical sense. A simple calculation on the von Koch curve shows that E_k is of length $\left(\frac{4}{3}\right)^k$; letting k tend to infinity implies that F has infinite length. On the other hand, F occupies zero area in the plane, so neither length nor area provides a very useful description of the size of F .

After this discussion we start to have a better idea of what those fractal dimensions mean. Roughly, a dimension provides a description of how much space a set fills. It is a measure of the prominence of the irregularities of a set when viewed at very small scales. We may regard the dimension as an index of complexity. We can therefore expect that a shape with a high dimension will be more complicated than another shape with a lower dimension.

A nice and mathematically fundamental example of this property are the plane-filling curves mentioned above, which we are now in position to discuss in a more quantitative

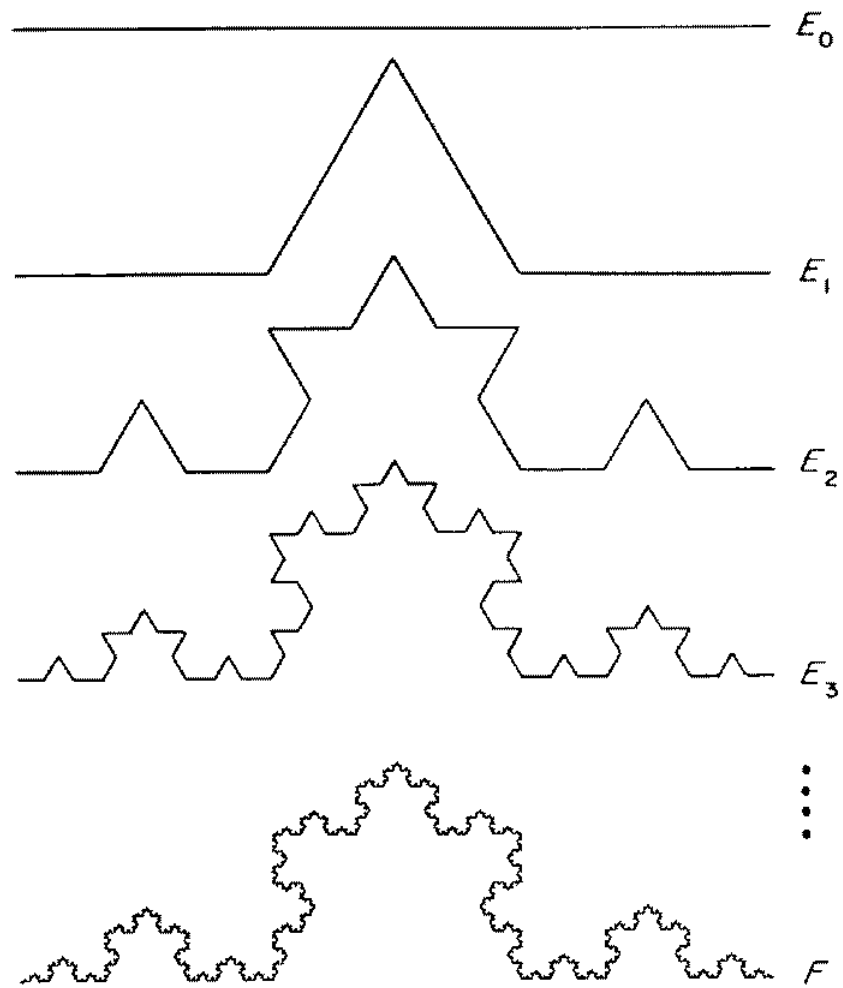

Figure 5: Construction of the von Koch curve F . At each stage, the middle third of each interval is replaced by the other two sides of an equilateral triangle (Falconer 1990).

manner. There are many different ways of constructing these plane-filling curves and here we shall take the original generator discussed by Peano. Figure 6 shows the construction of the curve and we can see that the generator self-contacts. The figure only shows the first two stages, but it is obvious that after a few iterations the pattern becomes so complex that paper, pencil and our hands turn out to be rather clumsy and inadequate tools to draw the figure, being unable to produce anything with much finer detail than that. Therefore, some sort of computer graphics is then necessary to obtain a detailed visualization of such curves. The important aspect of this construction is that the segment is divided in $N = 9$ parts, each

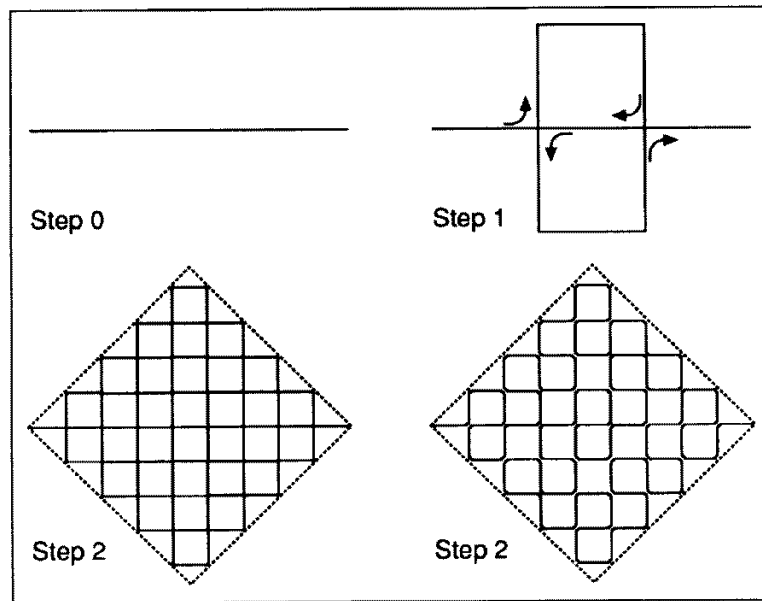

Figure 6: Construction of Peano's plane-filling curve with initiator and generator. In each step the segment is divided in $N = 9$ parts, each scaled down by $\delta = 1/3$. This means the similarity dimension is $D = 2$. For reasons of clarity the corners where the curve self-contacts have been slightly rounded (Peitgen, Jürgens and Saupe 1992).

scaled down by $\delta = 1/3$, which means the similarity dimension of the Peano curve is $D = 2$.

So we see that this curve has similarity dimension equals to the square, although it is a line which does not self-intersect. The removal of one single point cuts the curve in two pieces which means that its topological dimension is one. The self-contact points of the Peano curve are inevitable from a logical and intuitive point of view, and after an infinite number of iterations we effectively have a way of mapping a part of a plane by means of a topologically one-dimensional curve: given some patch of the plane, there is a curve which meets every point in that patch. The set becomes everywhere dense. The Peano curve is perfectly self-similar, which is shown very clearly in the figure. The generator used to construct the Peano curve is not the only possible one, and in fact there are many different ways of constructing such plane-filling curves using different generators, although they are generically known as

Peano curves. Mandelbrot (1983) shows many different and beautiful examples of different generators of Peano curves.

2.3.2 Coastlines

The Hausdorff and similarity dimensions defined so far provide definitions of fractal dimension for pure fractals, that is, classical fractal sets in a mathematically idealized way. Although some of these classical fractals can be used to model physical structures, what is necessary now is to discuss real fractal shapes which are encountered in natural phenomena. Hence, we need to apply as far as possible the mathematical concepts and tools developed so far in the study of real fractal structures, and when the mathematical tools are found to be inadequate or insufficient, we need to develop new ones to tackle the problem under study. If the existing tools prove inadequate, it is very likely that a specific definition of fractal dimension appropriate to the problem under consideration will have to be introduced. Let us see next two examples where we actually encounter such situations. The first is the classical problem of the length of coastlines, where a practical application of the equation (1) gives the necessary tools to characterize the shape.

The length of coastlines is the classical fractal problem that was characterized as such and solved by Mandelbrot. It provides a very interesting example of a fractal shape in nature and how our intuitive notion of rectifiable curves is rather slippery. What we shall attempt to show next is a brief and straightforward presentation of the problem and its solution, as nothing replaces the fascinating discussion made by Mandelbrot himself (Mandelbrot 1983).

Let us start with the figure 7 showing the southern part of Norway. The question in this case is: how long is the coast of Norway? On the scale of the map the deep fjords on the western coast show up clearly. The details of the southern part are more difficult to resolve, and if one sails there one finds rocks, islands, bays, faults and gorges that look much the same but do not show up even in detailed maps. This fact is absolutely intuitive and anyone who has walked along a beach and looked at the same beach in the map afterwards can testify it. So before answering the question of how long is the coast under analysis we have to decide on whether the coast of the islands should be included. And what about the rivers? Where does the fjord stop being a fjord and becomes a river? Sometimes this has an easy answer and sometimes not. And what about the tides? Are we discussing the length of the coast at low or high tide?

Despite these initial problems we may press ahead and try to measure the length of the coast by using an yardstick of length δ along the coastline of the map, and count the number of steps $N(\delta)$ needed to cover it entirely. If we choose a large yardstick then we would not have to bother about even the deepest fjords, and can estimate the length to be $L = \delta N(\delta)$. However, somebody could raise objections to this measurement based on the unanswered questions above, and we could try a smaller yardstick. This time the large fjords of figure 7 would contribute to the measured length, but the southeastern coast would still be taken

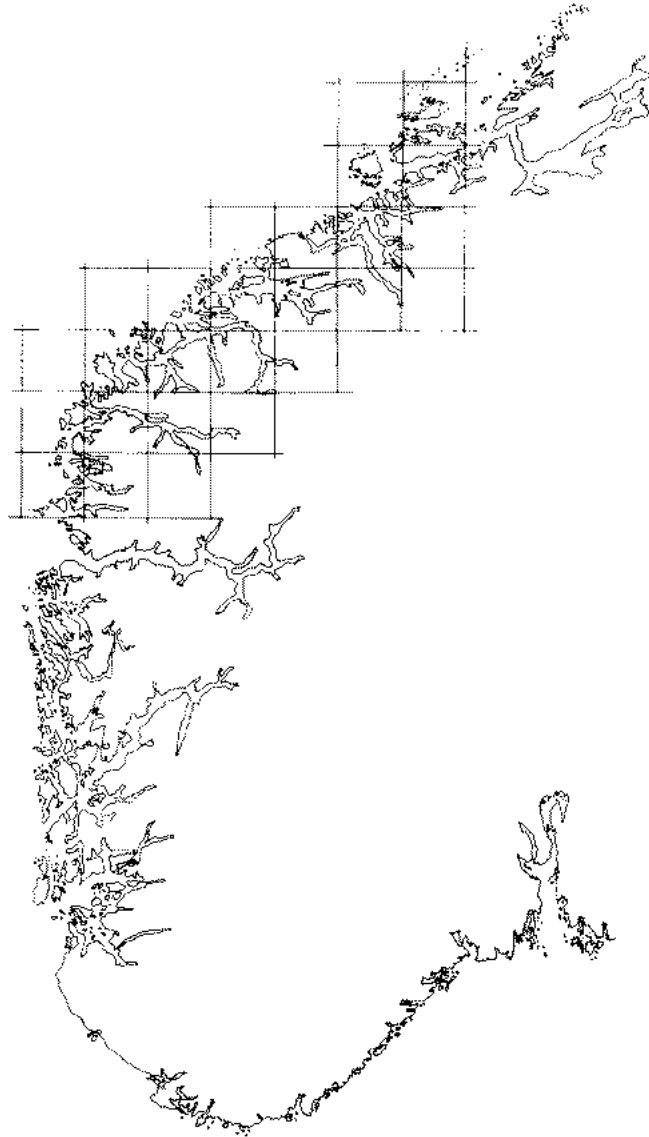

Figure 7: The coast of the southern part of Norway. The figure was traced from an atlas and digitized at about 1800×1200 pixels. The square grid indicated has spacing of $\delta \sim 50$ km (Feder 1988).

relatively easily in few measurements of the yardstick. Nevertheless, a serious discussion would demand more detailed maps, which in consequence reveal more details of the coast, meaning that a smaller yardstick is then made necessary. Clearly there is no end to this line of investigation and the problem becomes somewhat ridiculous. The coastline is as long as we want to make it. It is a nonrectifiable curve and, therefore, length is an inadequate concept to compare different coastlines as this measurement is not objective, that is, it depends on the yardstick chosen.

Coasts, which are obviously self-similar on nature, can, nevertheless, be characterized if we use a different method based on a practical use of equation (1). In figure 7 the coast of Norway has been covered with a set of squares with edge length δ , with the unit of length taken to equal the edge of the frame. Counting the number of squares needed to cover the coastline gives the number $N(\delta)$. If we proceed and find $N(\delta)$ for smaller values of δ we are able to plot a graph of $N(\delta)$ versus δ , for different grid sizes. Now it follows from equation (1) that asymptotically in the limit of small δ the following equation is valid:

$$N(\delta) \propto \frac{1}{\delta^D}. \quad (3)$$

So the fractal dimension D of the coastline can be determined by finding the slope of $\log N(\delta)$ plotted as a function of $\log \delta$. The resulting plot for the coastline shown in figure 7 is presented in figure 8, with $D \approx 1.52$, and the same method produces $D \approx 1.31$ for the coast of Britain. These two values agree with the intuition already associated with fractal dimensions in the sense that the more irregular coast, the Norwegian in this case, should have a higher value for D than the British coast. By means of equation (3) we can obtain the expression for the length of coastlines as

$$L \propto \delta^{1-D},$$

which shows its explicit dependence on the yardstick chosen. The dimension D in equation (3) is determined by counting the number of boxes needed to cover the set as a function of the box size. It is called *box counting dimension* or *box dimension*.

The box counting dimension proposes a systematic measurement which applies to any structure in the plane, and can be readily adapted for structures in the space. It is perhaps the most commonly used method of calculating dimensions and its dominance lies in the easy and automatic computability provided by the method, as it is straightforward to count boxes and maintain statistics allowing dimension calculation. The program can be carried out for shapes with and without self-similarity and, moreover, the objects may be embedded in higher dimensional spaces.

2.3.3 Cluster Dimension

Let us see now the application of fractal ideas to the problem of aggregation of fine particles, such as those of soot, where an appropriate fractal dimension has to be introduced. This kind of application of fractal concepts to real physical systems is under vigorous development at

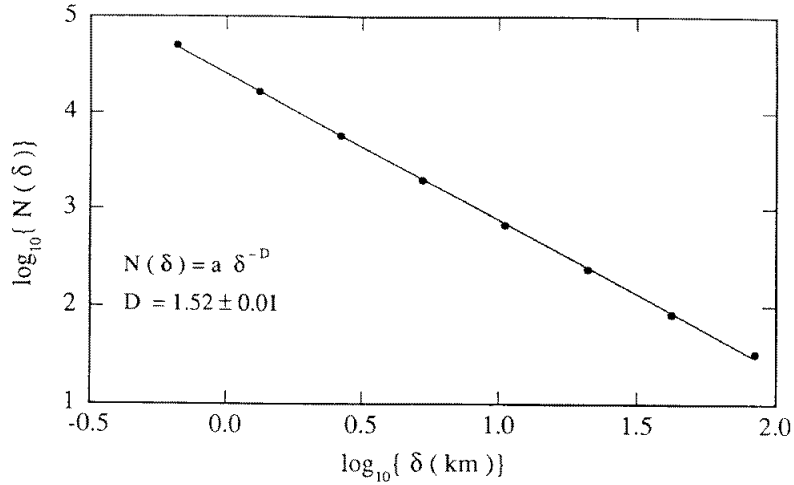

Figure 8: The number of ‘boxes’ of size δ needed to cover the coastline in the previous figure as a function of δ . The straight line is a fit of $N(\delta) \propto \delta^{-D}$ to the observations. The fractal dimension is $D \approx 1.52$ (Feder 1988).

present, inasmuch as it can be used to study such systems even in a laboratory, where they can be grown, or in computer simulations.

The Hausdorff dimension D in equation (1) requires the size δ of the covering sets to vanish, but as physical systems in general have a characteristic lower length scale, we need to take that into consideration in our physical applications of fractals. For instance, the problem of the length of coastlines *necessarily* involves a lower cutoff in its analysis as below certain scale, say, at the molecular level, we are no longer talking about coastlines. For the same reason we sometimes have to assume upper cutoffs to the fractal structures we are analysing. This highlights once more an important aspect of application of fractals to real physical phenomena: each problem must be carefully analysed not only to look for the appropriate fractal dimension (or dimensions as we may have more than one defined in the problem), but also to see to what extent the fractal hypothesis is valid to the case in study.

Let us see a specific example. In order to apply the ideas of the previous sections, we can replace a mathematical line by a linear chain of “molecules” or monomers. Figure 9 shows the replacement of a line by a chain of monomers, a two-dimensional set of points by a planar collection of monomers, and a volume by a packing of spheres. Let us call the radius R_0 the smallest length scale of the structure under study. In this case R_0 will be the radius of the monomers in figure 9. The number of monomers in a chain of length $L = 2R$ is

$$N = \left(\frac{R}{R_0}\right)^1.$$

For a group of monomers in a circular disk we have the proportionality

$$N \propto \left(\frac{R}{R_0}\right)^2.$$

For the three-dimensional close packing of spherical monomers into a spherical region of radius R , the number of monomers is

$$N \propto \left(\frac{R}{R_0}\right)^3.$$

By generalising these relations we may say that the number of particles and the cluster size measured by the smallest sphere of radius R containing the cluster is given by

$$N \propto \left(\frac{R}{R_0}\right)^D, \tag{4}$$

where D is the dimension of the distribution that may be non-integer, that is, fractal. Equation (4) is a *number-radius relation* and D is the *cluster fractal dimension* of the aggregation. The cluster fractal dimension is a measure of how the cluster fills the space it occupies.

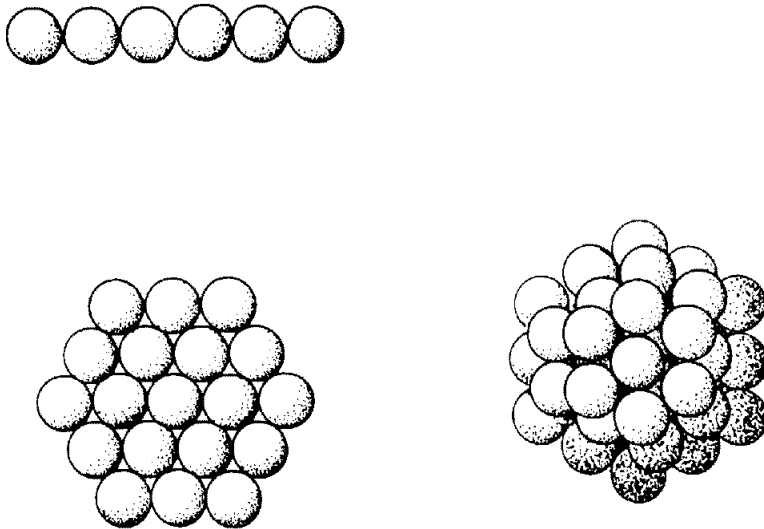

Figure 9: Simple aggregation of spherical monomers (Feder 1988).

A fractal cluster has the property of having a decreasing average density as the cluster size increases, in a way described by the exponent in the number radius relation. The average density will have the form

$$\rho(R) \sim R_0^{-D} R^{D-E}, \tag{5}$$

where E is the Euclidean dimension of the space where the cluster is placed. Therefore, a cluster is not necessarily fractal, even if it is porous or formed at random, as its density may be constant. Note that the shape of the cluster is *not* characterized by the cluster fractal dimension, although D does characterize, in a quantitative way, the cluster's feature of "filling" the space.

Figure 10 shows a very much studied type of cluster, obtained by the *diffusion-limited aggregation process* (DLA). In this process the cluster is started by a seed in the centre, and wandering monomers stick to the growing cluster when they reach it: if the random walker contacts the cluster, then it is added to it and another walker is released at a random position on the circle. This type of aggregation process produces clusters that have a fractal dimension $D = 1.71$ for diffusion in the plane. Numerical simulations show that the fractal dimension is $D = 2.50$ for clusters in three-dimensional space.

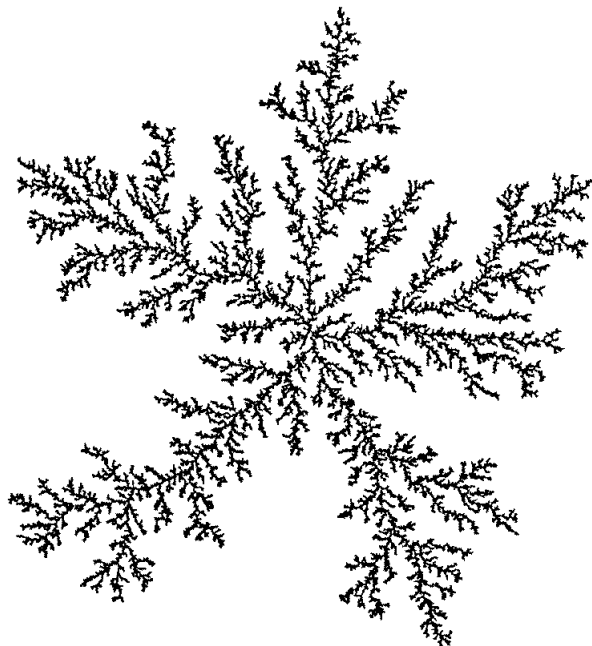

Figure 10: Random cluster containing 50,000 particles obtained from a two-dimensional diffusion-limited aggregation process (DLA) with $D = 1.71$ (Feder 1988).

Before closing this section, it seems appropriate to discuss something about the limitations of the fractal geometry. For this purpose we shall quote a paragraph from Peitgen, Jürgens and Saupe (1992, p. 244) which beautifully expresses this point.

“The concept of fractal dimension has inspired scientists to a host of interesting new work and fascinating speculations. Indeed, for a while it seemed as if the fractal dimensions would allow us to discover a new order in the world of complex phenomena and structures. This hope, however, has been dampened by some severe limitations. For one thing, there are several different dimensions which give different answers. We can also imagine that a structure is a mixture of different fractals, each one with a different value of box counting dimension. In such case the conglomerate will have a dimension which is simply the dimension of the component(s) with the largest dimension. That means the resulting number cannot be characteristic for the mixture. What we would really like to have is something more like a spectrum of numbers which gives information about the

distribution of fractal dimensions in a structure. This program has, in fact, been carried out and runs under the theme *multifractals*.”

For reasons of simplicity we shall not deal with multifractals in this paper.

As a final remark, as Pietronero (1988) has pointed out, the fractal concept provides a *description* of these irregular structures on nature, but it does not imply the formulation of a theory for them. Indeed, Mandelbrot has not produced a theory to explain how these structures actually arise from physical laws. A study of the interrelations between fractal geometry and physical phenomena is what may be called the “theory of fractals”, and forms the objective of intense activity in the field nowadays. This activity is basically divided in two main streams. The first tries to understand how it has come about that many shapes in nature present fractal properties. Hence, the basic question to answer is: where do fractals come from? The second approach is to assume as a matter of fact the existence of fractal structures and to study their physical properties. This generally consists of assuming a simple fractal model as a starting point and studying, for example, some basic physical property, like the diffusion on this structure.

As examples of such studies, there are the *fractal growth models*, which are based on a stochastic growth process in which the probability is defined through Laplace equation (*e.g.*, DLA process). They are considered the prototypes of many physical phenomena that generate fractal structures. As other examples, we have the *self-organized critical systems*, which are such that a state with critical properties is reached spontaneously, by means of an irreversible dynamical evolution of a complex system (*e.g.*, sandpile models). They pose problems similar to the fractal growth process, and use theoretical methods inspired by the latter, like the so-called “fixed scale transformation”, that allows to deal with irreversible dynamics of these process and to calculate analytically the fractal dimension.

3 The Fractal Hypothesis for the Distribution of Galaxies

In this section we shall discuss how the fractal concept can be used to study the large scale distribution of galaxies in the observed universe. We start with a brief summary of the standard methods used to study this distribution. Later we will see the problems of this orthodox analysis and the answers given to these problems when we assume that the large scale distribution of galaxies forms a self-similar fractal system. Some implications of the use of fractal ideas to describe the distribution of galaxies, like a possible crossover to homogeneity, are also presented.

3.1 The Standard Correlation Function Analysis

The standard statistical analysis assumes that the objects under discussion (galaxies) can be regarded as point particles that are distributed homogeneously on a sufficiently large scale. This means that we can meaningfully assign an average number density to the distribution

and, therefore, we can characterize the galaxy distribution in terms of the extent of the departures from uniformity on various scales. The correlation function as introduced in this field by P. J. E. Peebles around 25 years ago is basically the statistical tool that permits the quantitative study of this departure from homogeneity.

We shall discuss in a moment how to obtain the explicit form of the two-point correlation function, but it is important to point out right now two essential aspects of this method. First that this analysis fits very well in the standard Friedmannian cosmology which *assumes* spatial homogeneity, but it does not take into consideration any effect due to the curvature of the spacetime. In fact, this method neglects this problem altogether under the assumption that the scales under study are relatively small, although it does not offer an answer to the question of where we need to start worrying about the curvature effects. In other words, this analysis does not tell us what scales can no longer be considered relatively small.

Secondly that if the homogeneity assumption is not justified this analysis is *inapplicable*. Moreover, because this analysis starts by assuming the homogeneity of the distribution, *it does not offer any kind of test for the hypothesis itself*. In other words, *this correlation analysis cannot disprove the homogeneous hypothesis*.

Let us present now a straightforward discussion on how this statistic can be derived (Raine 1981). If the average number density of galaxies is $\bar{n} = N/V$ then we have to go on average a distance $(\bar{n})^{-1/3}$ from a given galaxy before another is encountered. This means that local departures from uniformity can be described if we specify the distance we actually go from any particular galaxy before encountering another. This will sometimes be larger than average, but sometimes less. Specifying this distance in each case is equivalent of giving the locations of all galaxies. This is an awkward way of doing things and does not solve the problem. What we require is a statistical description giving the probability of finding the nearest neighbour galaxy within a certain distance.

However, as the probability of finding a galaxy closer than, say, 50 kpc to the Milky Way is zero, and within a distance greater than this value is one, this is clearly not the sort of probability information we are after; what is necessary is some sort of average. Now we can think that the actual universe is a particular realization of some statistical distribution of galaxies, some statistical law, and the departure from randomness due to clustering will be represented by the fact that the average value over the statistical ensemble of this separation is less than $(\bar{n})^{-1/3}$.

In practice, however, we do not have a statistical ensemble from which the average value can be derived, so what we can do is to take a spatial average over the visible universe, or as much of it as has been catalogued, in place of an ensemble average. This only makes sense if the departure from homogeneity occurs on a scale smaller than the depth of the sample, so that the sample will statistically reflect the properties of the universe as a whole. In other words, we need to achieve a *fair sample* of the whole universe in order to fulfill this program, and this fair sample ought to be homogeneous, by assumption. If, for some reason, this fair

sample is not achieved, or is not achievable, that is, if the universe has no meaningful average density, this whole program breaks down.

For a completely random but homogeneous distribution of galaxies, the probability dP_1 of finding a galaxy in an infinitesimal volume dV_1 is proportional to dV_1 and to \bar{n} , and is independent of position. So we have

$$dP_1 = \frac{\bar{n}}{N} dV_1,$$

where N is the total number of galaxies in the sample. The meaning of the probability here is an average over the galaxy sample; the space is divided into volumes dV_1 and we count the ratio of those cells which contain a galaxy to the total number. The probability of finding two galaxies in a cell is of order $(dV_1)^2$, and so can be ignored in the limit $dV_1 \rightarrow 0$. It is important to state once more that this procedure only makes sense if the galaxies are distributed randomly on some scale less than that of the sample.

Suppose now that the galaxies were not clustered. In that case the probability dP_{12} of finding galaxies in volumes dV_1 and dV_2 is just the product $dP_1 dP_2$ of probabilities of finding each of the galaxies, since in a random distribution the positions of galaxies are uncorrelated. Now, if the galaxies were correlated we would have a departure from the random distribution and, therefore, the joint probability will differ from a simple product. The *two-point correlation function* $\xi(\vec{r}_1, \vec{r}_2)$ is by definition a function which determines the difference from a random distribution. So we put

$$dP_{12} = \left(\frac{\bar{n}}{N}\right)^2 [1 + \xi(\vec{r}_1, \vec{r}_2)] dV_1 dV_2 \quad (6)$$

as the expression of finding a pair of galaxies in volumes dV_1, dV_2 at positions \vec{r}_1, \vec{r}_2 . Obviously, the assumption of randomness on sufficiently large scales means that $\xi(\vec{r}_1, \vec{r}_2)$ must tend to zero if $|\vec{r}_1 - \vec{r}_2|$ is sufficiently large. In addition, the assumption of homogeneity means that ξ cannot depend on the location of the galaxy pair, but only on the distance $|\vec{r}_1 - \vec{r}_2|$ that separates them, as the probability must be independent of the location of the first galaxy. If ξ is positive we have an excess probability over a random distribution and, therefore, clustering. If ξ is negative we have anti-clustering. Obviously $\xi > -1$. The two-point correlation function can be extended to define n -point correlation functions, which are functions of $n - 1$ relative distances, but in practice computations have not been carried out beyond the four-point correlation function.

It is common practice to replace the description above using point particles by a continuum description. So if galaxies are thought to be the constituent parts of a fluid with variable density $n(\vec{r})$, and if the averaging over a volume V is carried out over scales large compared to the scale of clustering, we have

$$\frac{1}{V} \int_V n(\vec{r}) dV = \bar{n}, \quad (7)$$

where dV is an element of volume at \vec{r} . The joint probability of finding a galaxy in dV_1 at $\vec{r} + \vec{r}_1$ and in dV_2 at $\vec{r} + \vec{r}_2$ is given by

$$\left(\frac{1}{N}\right)^2 n(\vec{r} + \vec{r}_1)n(\vec{r} + \vec{r}_2)dV_1dV_2.$$

Averaging this equation over the sample gives

$$dP_{12} = \frac{1}{N^2V} \int_V n(\vec{r} + \vec{r}_1)n(\vec{r} + \vec{r}_2)dVdV_1dV_2.$$

Now if we compare the equation above with equation (6) we obtain

$$\bar{n}^2 [1 + \xi(\vec{\tau})] = \frac{1}{V} \int_V n(\vec{R})n(\vec{R} + \vec{\tau})dV, \quad (8)$$

where $\vec{\tau} = \vec{r}_2 - \vec{r}_1$, $\vec{R} = \vec{r} + \vec{r}_1$ and dV is the volume element at \vec{R} .

Related to the correlation function is the so-called *power spectrum* of the distribution, defined by the Fourier transform of the correlation function. It is also possible to define an *angular correlation function* which will express the probability of finding a pair of galaxies separated by a certain angle, and this is the function appropriate to studying catalogues of galaxies which contain only information on the positions of galaxies on the celestial sphere, that is, to studying the projected galactic distribution when the galaxy distances are not available. Further details about these two functions can be found, for instance, in Raine (1981, p. 10). Finally, for the sake of easy comparison with other works it is useful to write equation (8) in a slightly different notation:

$$\xi(r) = \frac{\langle n(\vec{r}_0)n(\vec{r}_0 + \vec{r}) \rangle}{\langle n \rangle^2} - 1. \quad (9)$$

The usual interpretation of the correlation function obtained from the data is as follows. When $\xi \gg 1$ the system is strongly correlated and for the region when $\xi \ll 1$ the system has small correlation. From direct calculations from catalogues it was found that at small values of r the function $\xi(r)$ can be characterized by a power law (Pietronero 1987; Davis et al. 1988; Geller 1989):

$$\xi(r) \approx Ar^{-\gamma}, \quad (\gamma \approx 1.7), \quad (10)$$

where A is a constant. This power law behaviour holds for galaxies and clusters of galaxies. The distance r_0 at which $\xi = 1$ is called the *correlation length*, and this implies that the system becomes essentially homogeneous for lengths appreciably larger than this characteristic length. This also implies that there should be no appreciable overdensities (superclusters) or underdensities (voids) extending over distances appreciably larger than r_0 .

3.2 Difficulties of the Standard Analysis

The first puzzling aspect found using the method just described is the difference in the amplitude A of the observed correlation function (10) when measured for galaxies and clusters

of galaxies. While the exponent γ is approximately 1.7 in both cases, for galaxies $A_G \simeq 20$ and for clusters $A_C \simeq 360$. Less accurately, superclusters of galaxies were found to have $A_{SC} \simeq 1000 - 1500$ (see Pietronero 1987 and references therein). The correlation length was found to be $r_0 \simeq 5 \text{ h}^{-1} \text{ Mpc}$ for galaxies and $r_0 \simeq 25 \text{ h}^{-1} \text{ Mpc}$ for clusters.

These are puzzling results, because as $A_C \simeq 18A_G$, clusters appear to be much more correlated than galaxies, although they are themselves made of galaxies. Similarly superclusters will then appear to be more correlated than clusters. From the interpretation of $\xi(r)$ described above, the galaxy distribution becomes homogeneous at the distance $\simeq 10\text{-}15 \text{ h}^{-1} \text{ Mpc}$ where $\xi(r)$ is found to become zero, while clusters and superclusters are actually observed at much larger distances, in fact up to the present observational limits.

The second difficulty of the standard analysis was first found by Einasto, Klypin and Saar (1986) and later confirmed by Davis et al. (1988) (see also Calzetti et al. 1987 and Coleman, Pietronero and Sanders 1988, Pietronero 1997). They found that the correlation length r_0 *increases with the sample size*. Figure 11 shows this dependence clearly, and it is evident that this result brings into question the notion of a universal galaxy correlation function.

The third problem of the standard analysis has to do with the homogeneity assumption itself and the possibility of achieving a fair sample, which should not be confused with a homogeneous sample as the standard analysis usually does. A fair sample is one in which there exists enough points from where we are able to derive some unambiguous statistical properties. Therefore *homogeneity must be regarded as a property of the sample and not a condition of its statistical validity*. Improvements in astronomical detection techniques, in particular the new sensors and automation, enabled astronomers to obtain a large amount of galaxy redshift measurements per night, and made it possible by the mid 1980's to map the distribution of galaxies in three dimensions. The picture that emerged from these surveys was far from the expected homogeneity: clusters of galaxies, voids and superclusters appeared in all scales, with no clear homogenization of the distribution. The first "slice" of the universe shown by de Lapparent, Geller and Huchra (1986) confirmed this inhomogeneity with very clear pictures. More striking is the comparison of these observed slices with a randomly generated distribution where the lack of homogenization of the observed samples is clear (see figure 12). Deeper surveys (Saunders et al. 1991) show no sign of any homogeneity being achieved so far, with the same self-similar structures still being identified in the samples.

Those problems together with the power law behaviour of $\xi(r)$ clearly call for an explanation, and while many have been proposed they usually deal with each of these issues separately. As we shall see, the fractal hypothesis, on the other hand, deals with all these problems as a whole and offers an explanation to each of them within the fractal picture. While we do not intend to claim that the fractal hypothesis is the only possible explanation to these problems, whether considering them together or separately, from now on in this paper we shall take the point of view that fractals offer an attractively simple description of the large scale distribution of galaxies and that the model offered by them deserves a

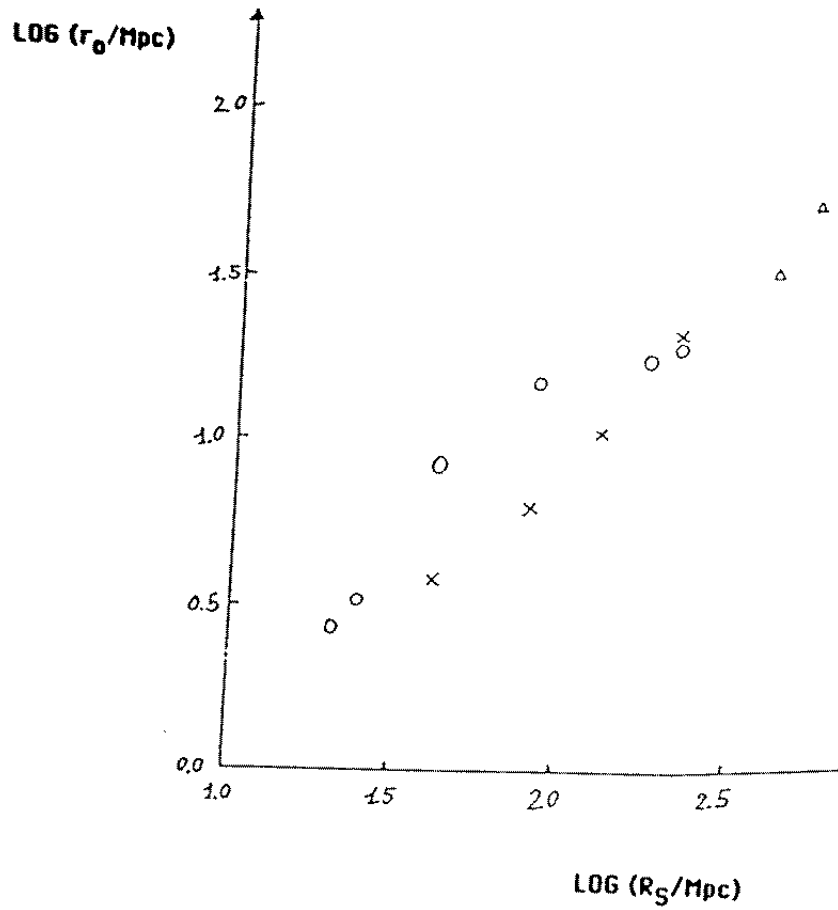

Figure 11: The behaviour of r_0 plotted against the sample size R_S found by Einasto, Klypin and Saar (1986). The different symbols (open circles, crosses and triangles) mean the different directions from where the samples were taken in the sky. (Calzetti et al. 1987). Further extensions of this behaviour, to around 100 Mpc, are shown in Pietronero (1997), fig. 2.

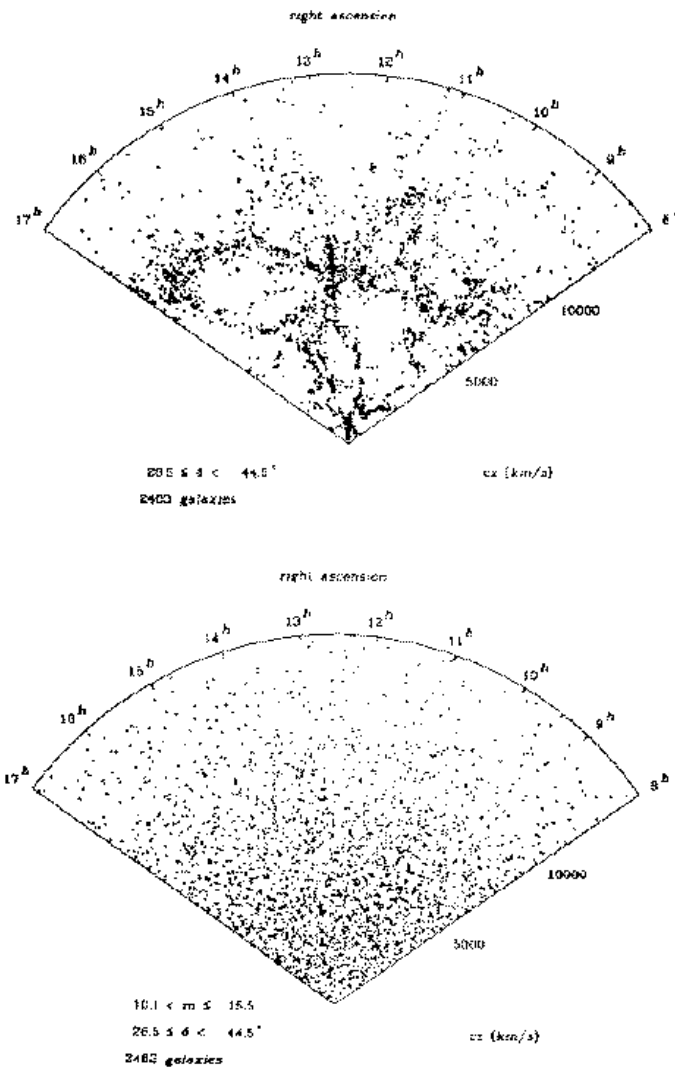

Figure 12: The picture on top shows the observed distribution of galaxies in the 18° wide slice centered at 35.5° . Voids and clusters are clearly visible as well as the lack of homogenization of the sample. The largest inhomogeneities are comparable with the size of the sample and, therefore, it is not large enough to be considered *fair*. The picture below shows a sample of 2483 randomly distributed points (Geller 1989).

deep, serious and unprejudiced investigation, either in a Newtonian or relativistic framework. From its basis, the fractal hypothesis in many ways represents a radical departure from the orthodox traditional view of an *observationally* homogeneous universe, which is challenged from its very foundations in many respects.

3.3 Correlation Analysis without Assumptions

Before we discuss the fractal model itself, it is convenient to look first at the statistical tools where a correlation appropriate to a fractal distribution can be derived. The method that is going to be introduced obviously does not imply the existence of a fractal distribution, but if it exists, it is able to describe it properly (see Pietronero 1987; Coleman and Pietronero 1992; Pietronero, Montuori and Sylos Labini 1997; Sylos Labini, Montuori and Pietronero 1998). The appropriate analysis of pair correlations should therefore be performed using methods that can check homogeneity or fractal properties without assuming *a priori* either one. This is not the case of the function $\xi(r)$, which is based on *a priori* and untested assumption of homogeneity. For this purpose it is useful to start with a basic discussion on the concept of correlation.

If the presence of an object at r_1 influences the probability of finding another object at r_2 these points are said to be correlated. So there is correlation at a distance \vec{r} from \vec{r}_0 if, on average,

$$G(r) = \langle n(\vec{r}_0)n(\vec{r}_0 + \vec{r}) \rangle \neq \langle n \rangle^2.$$

On the other hand there is no correlation if

$$G(r) \approx \langle n \rangle^2.$$

From this it is clear that non-trivial structures like voids or superclusters are made, by definition, from correlated points. Hence, the correlation length definition will only be meaningful if it separates correlated regions from uncorrelated ones. Figure 13 shows what would be the typical behaviour we would expect from the galaxy correlation if there is an upper cutoff to homogeneity. The power law decay will be eventually followed by a flat region that corresponds to the homogeneous distribution. In this case the correlation length λ_0 is the distance at which there is a change in the correlation $G(r)$: it changes from a power law behaviour to a homogeneous regime and the average density becomes the same, being independent of the position.

Actually in figure 13 we have a situation where the sample size R_S is larger than λ_0 . If we had $R_S < \lambda_0$, then the average density measured would correspond to an overdensity, different from the real average density of the distribution. The precise value of this overdensity would then depend explicitly on the sample radius, and in this case the function $\xi(r)$ becomes spurious because the normalization of correlated density by the average density (eq. 9) will depend explicitly on R_S . Only in the limiting case where $R_S \gg \lambda_0$ will the length r_0

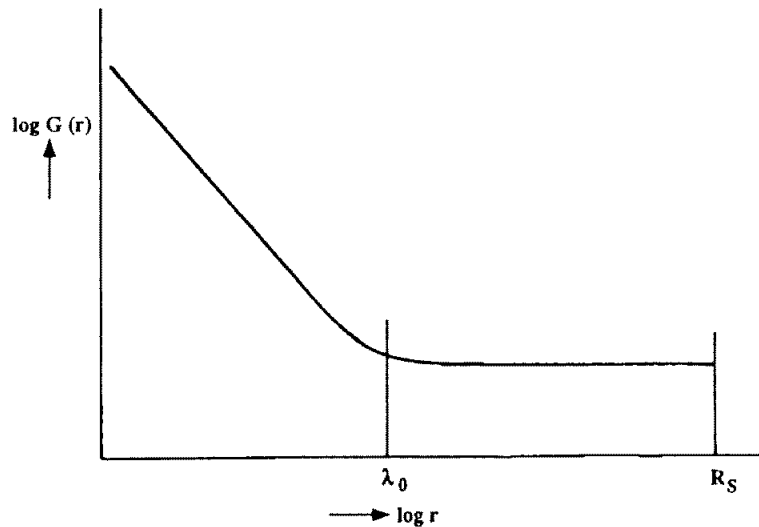

Figure 13: This illustration represents schematically the expected behaviour for the galaxy correlation density of a correlated system with a crossover to homogeneity. The flat behaviour of the function $G(r)$ beyond some correlation length λ_0 corresponds to the unambiguous sign of homogeneity (Coleman and Pietronero 1992).

indeed be related to the correlation length λ_0 ⁶. This is in fact the case for liquids, where the two-point correlation function $\xi(r)$ was originally introduced, as any reasonable sample size larger than some atomic scale for, say, water, will contain so many molecules that its average density is a well defined physical property. Because water has a well defined value for $\langle n \rangle$, the function $\xi(r)$ will be the same for a glass of water and for a lake, referring only to the physical properties of water and not to the size of the glass. However, by just looking at figure 12 it is quite clear that this is not the case for the distribution of galaxies. As pointed out by Geller (1989), at least up to the present observational limits the galaxy average density is not well defined.

The function $G(r)$ as defined above has, however, the factor $\langle n \rangle = N/V$ which may, in principle, be an explicit function of the sample's size scale. Therefore, it is appropriate to define the *conditional density* $\Gamma(r)$ as,

$$\Gamma(r) \equiv \frac{\langle n(\vec{r}_0)n(\vec{r}_0 + \vec{r}) \rangle}{\langle n \rangle}. \quad (11)$$

By the definition of the average number density of galaxies, we have

$$\langle n(\vec{r}_0)n(\vec{r}_0 + \vec{r}) \rangle = \frac{1}{V} \int_V n(\vec{r}_0)n(\vec{r}_0 + \vec{r})dV, \quad (12)$$

and together with $\langle n \rangle = N/V$, equation (11) becomes

$$\Gamma(r) = \frac{1}{N} \int_V n(\vec{r}_0)n(\vec{r}_0 + \vec{r})dV. \quad (13)$$

⁶ See §3.5.2 for the proof of this statement.

Assuming

$$n(\vec{r}) = \sum_{i=1}^N \delta(\vec{r} - \vec{r}_i),$$

and remembering that

$$\int_{-\infty}^{+\infty} \delta(x - y)\varphi(y)dy = \varphi(x), \quad \delta(x) = \delta(-x),$$

equation (13) may be rewritten as

$$\Gamma(r) = \frac{1}{N} \sum_{i=1}^N n(\vec{r}_i + \vec{r}) = \langle n(\vec{r}_i + \vec{r}) \rangle_i, \quad (14)$$

where $n(\vec{r}_i + \vec{r})$ is the conditional density of the i th object, and $\langle n(\vec{r}_i + \vec{r}) \rangle_i$ the final average that refers to all occupied points r_i . This corresponds to assigning an unit mass to all points occupied by galaxies, with the i th galaxy at \vec{r}_i and N being the total number of galaxies. Equation (14) measures the average density at distance r from an occupied point, and the volume V in that equation is purely nominal and should be such to include all objects, but it does not appear explicitly in equation (14). $\Gamma(r)$ is more convenient than $G(r)$ for comparing different catalogues since the size of the catalogue only appears via the combination $\frac{1}{N} \sum_{i=1}^N$ and this means that a larger sample volume will only increases the number of objects N . Hence a larger sample size implies a better statistic.

Equations (9) and (14) are simply related by

$$\xi(r) = \frac{\Gamma(r)}{\langle n \rangle} - 1. \quad (15)$$

We can also define the *conditional average density*

$$\Gamma^*(r) = \frac{1}{V} \int_V \Gamma(r) dV, \quad (16)$$

which gives the behaviour of the average density of a sphere of radius r centered around an occupied point averaged over all occupied points ⁷, and the *integrated conditional density*

$$I(r) = 4\pi \int_0^r r'^2 \Gamma(r') dr', \quad (17)$$

which is the number of galaxies of a spherical region of radius r .

Figure 14 shows the calculation of $\Gamma(r)$, $\Gamma^*(r)$ and $\xi(r)$ for the CfA redshift survey, where the absence of a homogenization of the distribution within the sample and the absence of any kind of correlation length are clear. This result brings strong support to the hypothesis that the large scale distribution of galaxies forms indeed a fractal system.

Table 1 shows the correlation properties of the galaxy distributions in terms of volume limited catalogues arising from most of the 50,000 redshift measurements that have been

⁷ See Coleman and Pietronero (1992) for a more detailed discussion on this subject with many examples of calculations of $\Gamma(r)$, $\Gamma^*(r)$ and $\xi(r)$ using test samples.

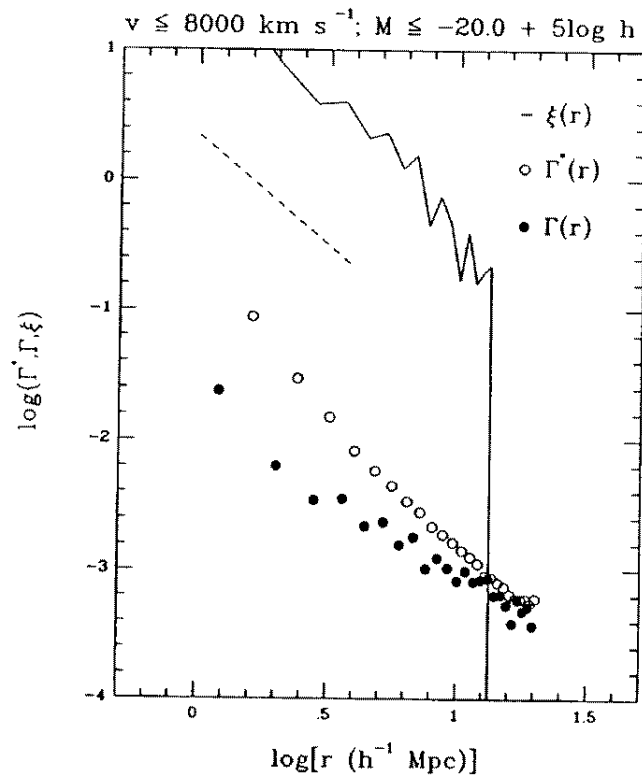

Figure 14: $\Gamma(r)$, $\Gamma^*(r)$ and $\xi(r)$ plotted as function of length scale for the CfA redshift survey. There is no indication of a homogenization of the sample and both $\Gamma(r)$ and $\xi(r)$ obey a power law, a result consistent with a fractal structure for the distribution of galaxies. The dashed line indicates a reference slope of -1.7 (Coleman, Pietronero and Sanders 1988).

Table 1: The volume limited catalogues are characterized by the following parameters: Ω (sr) is the solid angle, R_D (h^{-1} Mpc) is the depth of the catalogue, R_S (h^{-1} Mpc) is the radius of the largest sphere that can be contained in the catalogue volume, r_0 (h^{-1} Mpc) is the length at which $\xi(r_0) \equiv 1$, D is the fractal dimension and λ_0 (h^{-1} Mpc) is the eventual real crossover to homogeneity that this is actually never observed. The CfA2 and SSRS2 data are not yet available (Pietronero, Montuori and Sylos Labini 1997).

Sample	Ω	R_D	R_S	r_0	D	λ_0
CfA1	1.83	80	20	6	1.7 ± 0.2	> 80
CfA2	1.23	130	30	10	2.0	?
PP	0.9	130	30	10	2.0 ± 0.1	> 130
SSRS2	1.13	150	50	15	2.0	?
LEDA	4π	300	150	45	2.1 ± 0.2	> 150
LCRS	0.12	500	18	6	1.8 ± 0.2	> 500
IRAS	4π	80	40	4.5	2.0 ± 0.1	~ 15
ESP	0.006	700	10	5	1.9 ± 0.2	> 800

made to date. The samples are statistically rather good in relation to the fractal dimension D and the conditional density $\Gamma(r)$, and their properties are in agreement with each other.

While various authors consider these catalogs as *not fair*, because the contradiction between each other, Pietronero, Montuori and Sylos Labini (1997) show that this is due to the inappropriate methods of analysis. Figure 15 shows a density power law decay for many redshift surveys, and it is clear that we have well defined fractal correlations from 1 to 1000 h^{-1} Mpc with fractal dimension $D \approx 2$. This implies necessarily that the value of r_0 ($\xi(r_0) = 1$) will scale with sample size R_S ,⁸ which gives the limit of the statistical validity of the sample, as shown also from the specific data about r_0 in table 1. The smaller value of CfA1 was due to its limited size. At this same figure we can see the so-called Hubble-de Vaucouleurs paradox, which is caused by the coexistence between the Hubble law and the fractal distribution of luminous matter at the same scales (Pietronero, Montuori and Sylos Labini 1997).⁹

It is important to mention that there are effects which may conceal the true statistical behaviour of the samples. Those effects may lead to the conclusion that the sample under study is homogeneous, although such a conclusion would be wrong, since such homogeneity may appear not as a statistical property of the sample, but just as an effect of its finite size.

Figure 16 shows the behaviour of the density computed from the vertex of a conic sample. At very small distances we are not going to find any galaxy because the total number is rather

⁸ See §3.5.1 for an explanation of this effect under a fractal perspective.

⁹ See Ribeiro (1995) for a relativistic perspective of this “paradox”, where it is shown that this is just a result of a relativistic effect.

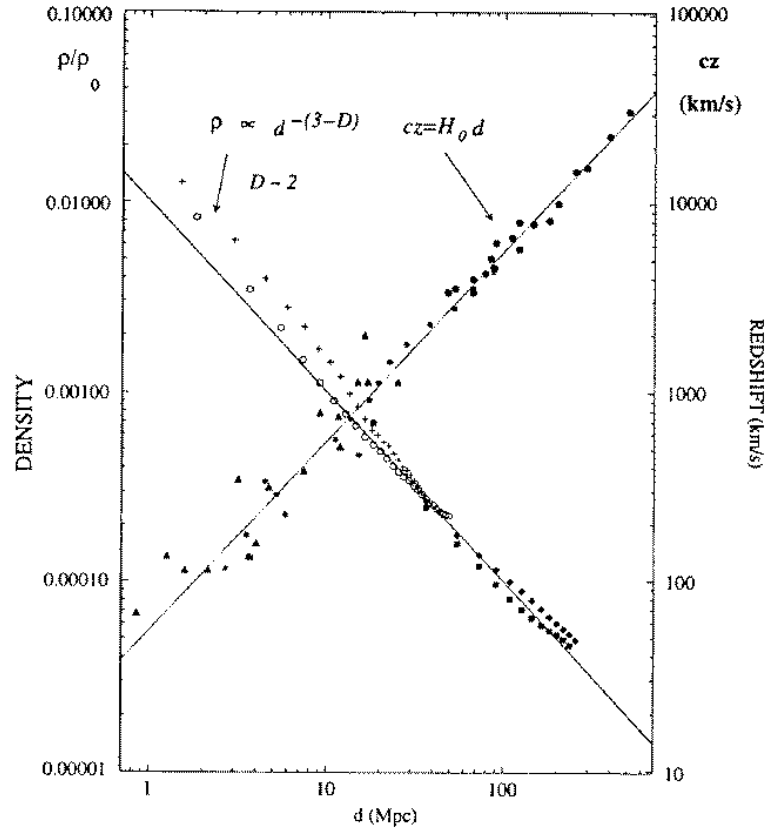

Figure 15: Conditional average density of galaxies plotted as function of distance (decreasing from left to right) for the following redshifts surveys: CfA1 (crosses), Perseus-Pisces (circles) and LEDA (squares). The solid line corresponds to $D = 2$. The Hubble redshift-distance is also shown in this graph. The dotted line corresponds to the Hubble law (increasing from left to right) with $H_0 = 55 \text{ km s}^{-1} \text{ Mpc}^{-1}$. This law is constructed from: galaxies with Cepheid-distances for $cz > 0$ (triangles), galaxies with Tully-Fisher (B-magnitudes) distances (stars), galaxies with SNIa-distances for $cz > 3000 \text{ km/s}$ (filled circles) (Pietronero, Montuori and Sylos Labini 1997).

small. After the Voronoi's length V , which is of the order of the mean particle separation, we begin to have signal but this is strongly affected by finite size effects. The correct scaling behaviour is reached for the region $r \geq \lambda$. In the intermediate region we have an apparent homogeneous distribution, but it is due to the finite size effects (Pietronero, Montuori and Sylos Labini 1997; Sylos Labini, Gabrielli, Montuori and Pietronero 1996; Sylos Labini, Montuori and Pietronero 1998).

As evidence that this new statistical approach is the appropriate method of analysis, we can see in figure 17 an agreement between various available redshift catalogues in the range of distances $0.1 - 1 \times 10^3 \text{ h}^{-1} \text{ Mpc}$. From this we can conclude that there is no tendency to homogeneity at this scale. In contrast to figure 17 we have figure 18 where the traditional analysis based on $\xi(r)$ for the same catalogues of figure 17 shows a strong conflict between these two analytical methods. Figure 18 shows that $\xi(r)$ is unable to say without any doubt if there is a homogeneous scale, and this is the main reason from where the concept of “*unfair sample*” is generated.

Another statistical analysis is the number counts and angular correlations. In figure 19 we show the behaviour of the number counts versus magnitude relation ($N(< m)$) with an exponent $\alpha = D/5$. At small scales $\alpha = 0.6 \pm 0.1$ ($D \approx 3$), which means that we have an apparent homogeneity. However, this is due to the finite size effects discussed above, while at larger scales the value 0.4 ($D \approx 2$) shows correlation properties of the sample in agreement with the results obtained for $\Gamma(r)$. In addition, the fact that the exponent 0.4 holds up to magnitudes 27–28 seems to indicate that the fractal structure may continue up to $2 - 3 \times 10^3 \text{ h}^{-1} \text{ Mpc}$ (Pietronero, Montuori and Sylos Labini 1997).

3.4 Pietronero-Wertz's Single Fractal (Hierarchical) Model

The single fractal model proposed by Pietronero (1987) is essentially an application of the cluster fractal dimension to the large scale distribution of galaxies, a straightforward analysis of the consequences of this fractal interpretation of the galactic system plus the proposal of new statistical tools to analyse the catalogues of galaxies, derived from his strong criticisms of the standard statistical analysis based on the two-point correlation function. He also studied the problem from a multifractal perspective. What we shall attempt to do here is to present a summary of the basic results related to the discussion above. Later in a review paper, Coleman and Pietronero (1992) extended the theory, with especial emphasis on multifractals and the angular correlation function, and added new results. Further extensions and results of this theory were also made in Sylos Labini, Montuori and Pietronero (1998).

Wertz's (1970, 1971) hierarchical model, on the other hand, was proposed at a time when fractal ideas had not yet appeared. However, these ideas were more or less implicit in his work, and as we shall see below, he ended up proposing a hierarchical model mathematically identical to Pietronero's single fractal model, but 17 years earlier. For this reason his work deserves to be quoted as being the first independent model where self-similar ideas were

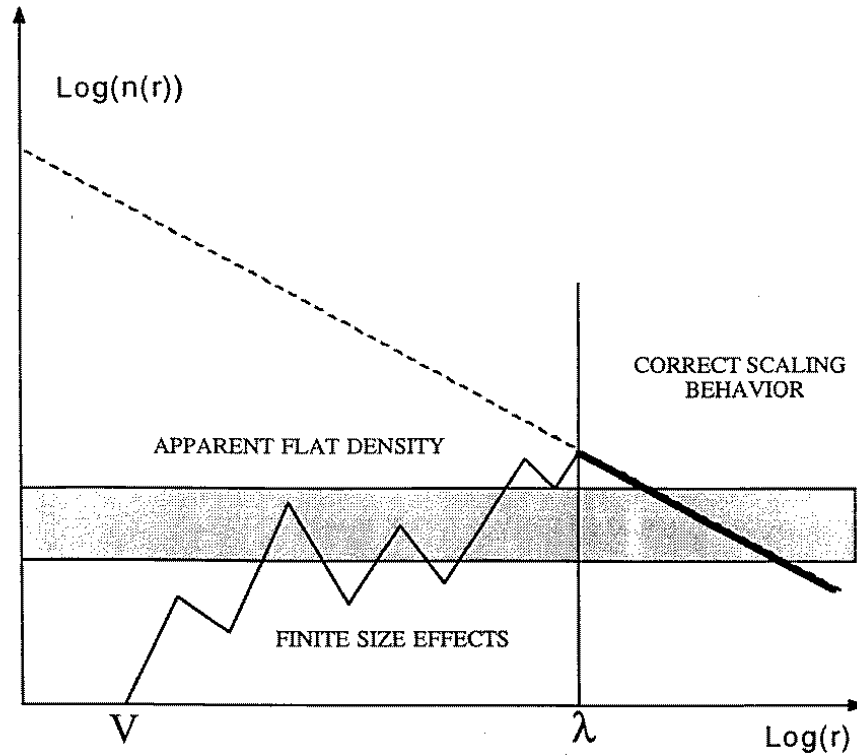

Figure 16: Schematic behaviour of the density computed from the vertex. Inside the Voronoi's length V (small distances), one finds almost no galaxies. After this length the number of galaxies starts to grow with a regime strongly affected by finite size fluctuations, and the density can be approximately roughly by a constant value, leading to an apparent exponent $D \approx 3$. Finally the scaling region $r \geq \lambda$ is reached (Pietronero, Montuori and Sylos Labini 1997; Sylos Labini, Gabrielli, Montuori and Pietronero 1996).

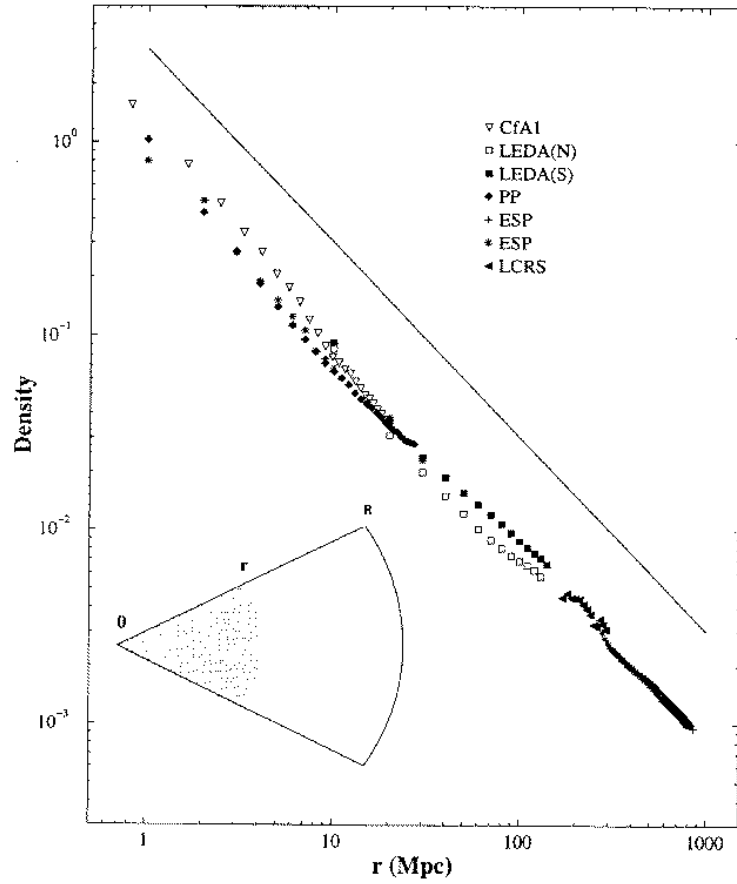

Figure 17: Full correlation for the various redshift catalogues in the range of distances $0.1 - 1 \times 10^3 h^{-1}$ Mpc. A reference line with a slope -1 is also shown ($D \approx 2$). In the insert it is shown a conic volume. The radial density is computed by counting all the galaxies up to a certain limit, and by dividing for the volume of this conic sample (Pietronero, Montuori and Sylos Labini 1997).

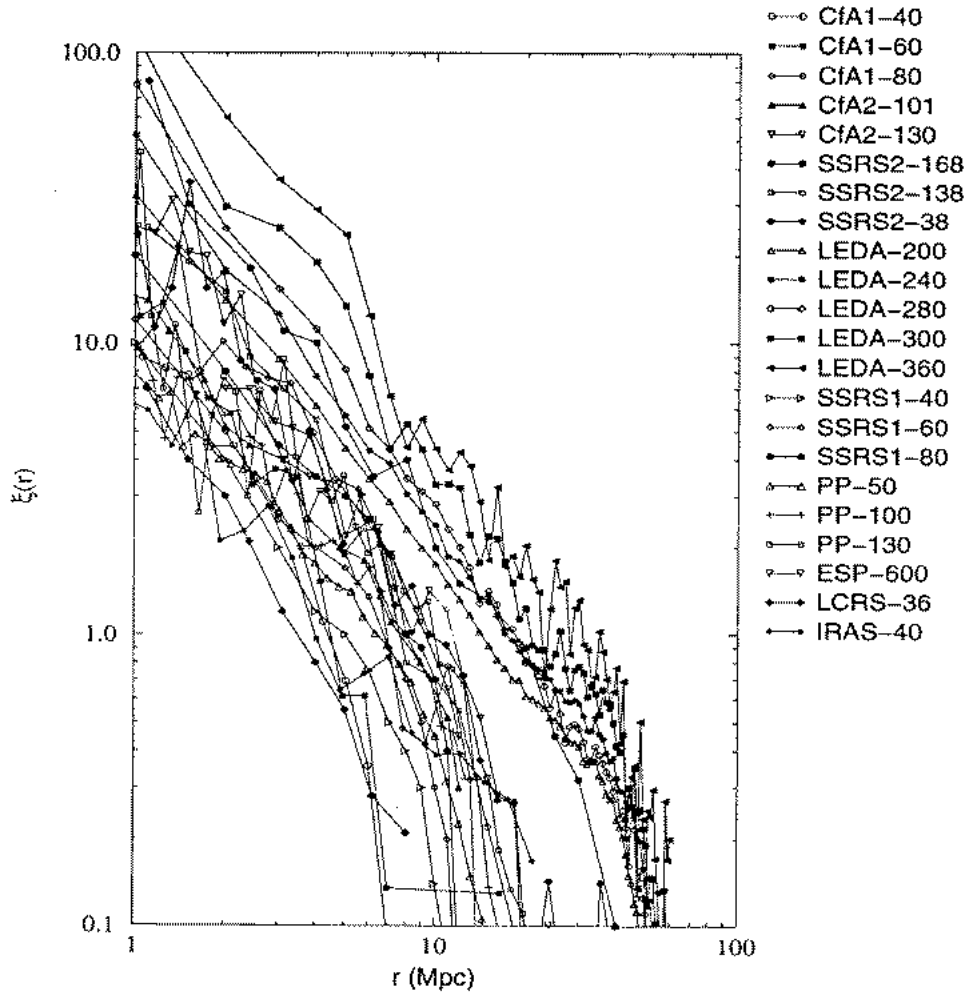

Figure 18: Graph of the function $\xi(r)$ versus the distance r (Mpc) for the same galaxy catalogues of figure 17. Here we can see rather confusing results generated by the *a priori* and untested assumption of homogeneity, which are not present in the real galaxy distribution (Pietronero, Montuori and Sylos Labini 1997).

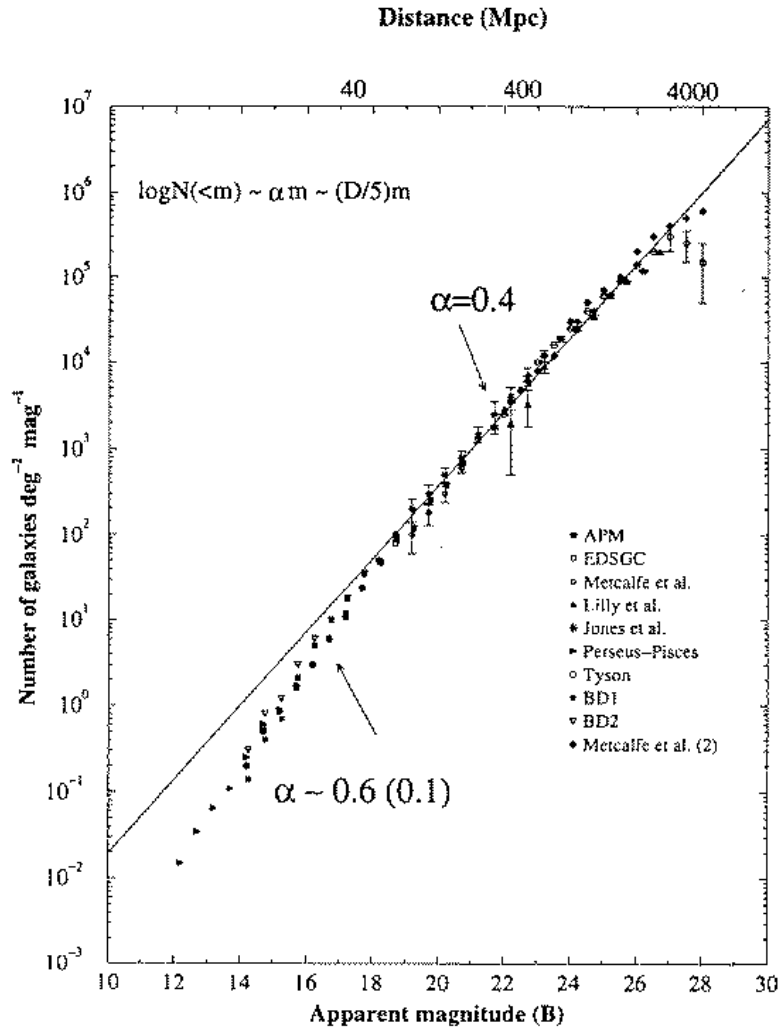

Figure 19: The galaxy number counts in the B -band from several surveys. In the range $12 \leq m \leq 19$ the counts show an exponent $\alpha = 0.6 \pm 0.1$, while in the range $19 \leq m \leq 28$ the exponent is $\alpha \approx 0.4$. The amplitude of galaxy number counts for $m \geq 19$ (solid line) is computed from the determination of the prefactor B of the density $n(r) = Br^{-(3-D)}$ at small scale and from the knowledge of the galaxy luminosity function. The distance is computed for a galaxy with $M = -16$ and the value used for H_0 is $75 \text{ km s}^{-1} \text{ Mpc}^{-1}$ (Pietronero, Montuori and Sylos Labini 1997).

applied in the study of the large scale distribution of galaxies. The reasons why Wertz's work was forgotten for so long lies on the shortcomings of its physical implications, as it will be shown below.

3.4.1 Pietronero's Single Fractal Model

The definition of the fractal dimension as made by Pietronero (1987) is slightly different than in the case of the cluster dimension discussed previously. Figure 20 shows a schematic representation of a fractal distribution of points. Clearly we have a self-similar distribution as more and more structure appears at smaller and smaller scales, with the structure at small scales being similar to the one at large scales. By starting from a point occupied by an object and counting how many objects are present within a volume characterized by a certain length

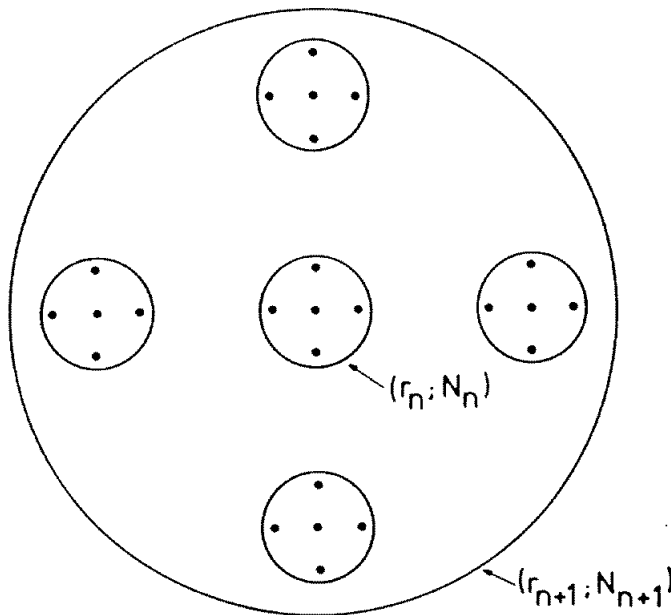

Figure 20: Schematic illustration of a deterministic fractal system from where a fractal dimension can be derived. The structure is self-similar, repeating itself at different scales (Pietronero 1987).

scale, we have that within a certain radius d_0 , there are N_0 objects; then within $d_1 = k d_0$ there are $N_1 = \tilde{k} N_0$ objects; in general, within

$$d_n = k^n d_0 \tag{18}$$

we have

$$N_n = \tilde{k}^n N_0 \tag{19}$$

objects. Generalizing this idea to a smooth relation, we can define a *generalized mass-length relation* between N and d of the type

$$N(d) = \sigma d^D, \quad (20)$$

where the fractal dimension

$$D = \frac{\log \tilde{k}}{\log k} \quad (21)$$

depends only on the rescaling factors k and \tilde{k} , and the prefactor σ is related to the lower cutoffs N_0 and d_0 ,

$$\sigma = \frac{N_0}{d_0^D}. \quad (22)$$

Equation (20) corresponds to a continuum limit for the discrete scaling relations.

Let us now suppose that a sample of radius R_S contains a portion of the fractal structure. If we assume it to be a sphere, then the sample volume is given by

$$V(R_S) = \frac{4}{3}\pi R_S^3,$$

which allows us, together with equation (20), to compute the average density $\langle n \rangle$ as being

$$\langle n \rangle = \frac{N(R_S)}{V(R_S)} = \frac{3\sigma}{4\pi} R_S^{-\gamma}, \quad \gamma = 3 - D. \quad (23)$$

This is the same type of power law expression obtained several years ago by de Vaucouleurs (1970), and equation (23) shows very clearly that the average density is not a well defined physical property for this sort of fractal system because it is a function of the sample size.

3.4.2 Wertz's Hierarchical Model

The hierarchical model advanced by Wertz (1970, 1971) was conceived at a time when fractal ideas had not yet appeared. So, in developing his model, Wertz was forced to start with a more conceptual discussion in order to offer “a clarification of what is meant by the ‘undefined notions’ which are the basis of any theory” (Wertz 1970, p. 3). Then he stated that “a cluster consists of an aggregate or gathering of ELEMENTS into a more or less well-defined group which can be to some extent distinguished from its surroundings by its greater density of elements. A HIERARCHICAL structure exists when *i*TH ORDER CLUSTERS are themselves elements of an (*i*+1)TH ORDER CLUSTER. Thus, galaxies (ZEROTH ORDER CLUSTERS) are grouped into FIRST ORDER CLUSTER. First order clusters are themselves grouped together to form SECOND ORDER CLUSTERS, etc, *ad infinitum*” (see figure 21).

Although this sort of discussion may be very well to start with, it demands a precise definition of what one means by a cluster in order to put those ideas on a more solid footing, otherwise the hierarchical structure one is talking about continues to be a somewhat vague notion. Wertz seemed to have realized this difficulty when later he added that “to say what percentage of galaxies occur in clusters is beyond the abilities of current observations and

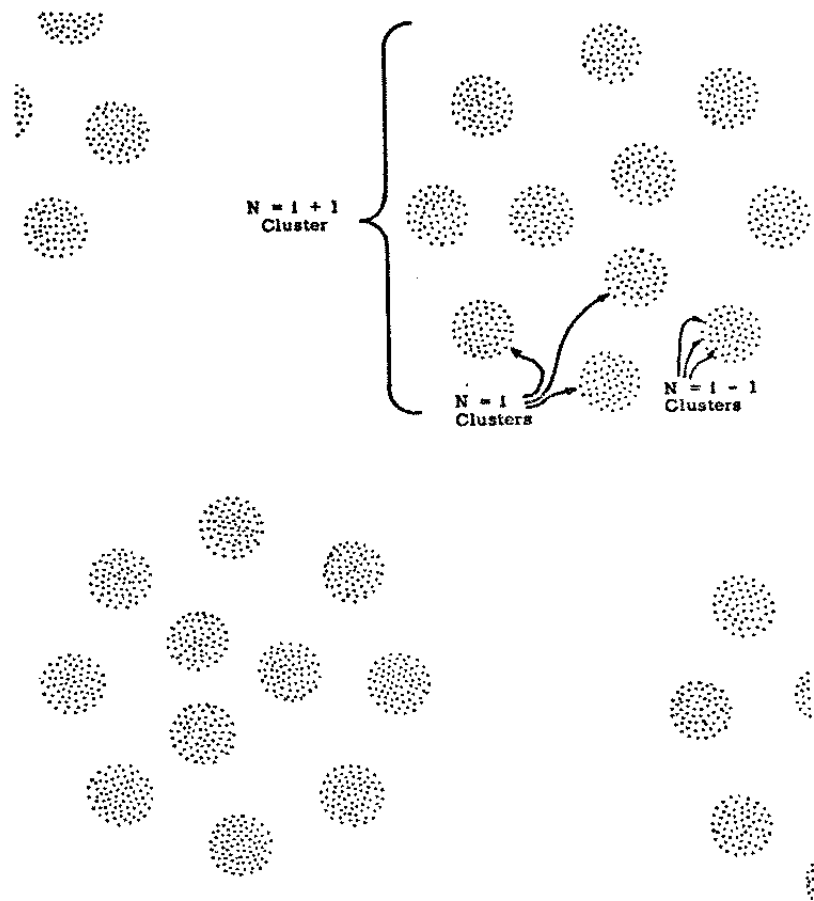

Figure 21: Reproduction from Wertz (1970, p. 25) of a rough sketch cross-section of a portion of an $N = i + 2$ cluster of a polka dot model.

involves the rather arbitrary judgment of what sort of grouping is to be called a cluster. (...) It should be pointed out that there is not a clear delineation between clusters and superclusters” (p. 8).

Despite this initially descriptive and somewhat vague discussion about hierarchical structure, which is basically a discussion about scaling in the fractal sense, Wertz did develop some more precise notions when he began to discuss specific models for hierarchy, and his starting point was to assume what he called the “universal density-radius relation”, that is, the de Vaucouleurs density power law, as a fundamental empirical fact to be taken into account in order to develop a hierarchical cosmology. Then if $M(x, r)$ is the total mass within a sphere of radius r centered on the point x , he defined the *volume density* ρ_v as being the average over a sphere of a given volume containing M . Thus

$$\rho_v(x, r) \equiv \frac{3M(x, r)}{4\pi r^3}, \quad (24)$$

and the *global density* was defined as being

$$\rho_g \equiv \lim_{r \rightarrow \infty} \rho_v(x, r). \quad (25)$$

A *pure hierarchy* is defined as a model universe which meets the following postulates:

- (i) for any positive value of r in a bounded region, the volume density has a maximum;
- (ii) the model is composed of only mass points with finite non-zero mean mass;
- (iii) the zero global density postulate: “for a pure hierarchy the global density exists and is zero everywhere” (see Wertz 1970, p. 18).

With this picture in mind, Wertz states that “in any model which involves clustering, there may or may not appear discrete lengths which represent clustering on different scales. If no such scales exist, one would have an INDEFINITE HIERARCHY in which clusters of every size were equally represented (...). At the other extreme is the DISCRETE HIERARCHY in which cluster sizes form a discrete spectrum and the elements of one size cluster are all clusters of the next lowest size” (p. 23). Then in order to describe *polka dot models*, that is, structures in a discrete hierarchy where the elements of a cluster are all of the same mass and are distributed regularly in the sense of crystal lattice points, it becomes necessary for one be able to assign some average properties. So if N is the order of a cluster, $N = i$ is a cluster of arbitrary order (figure 21), and at least in terms of averages a cluster of mass M_i , diameter D_i and composed of n_i elements, each of mass m_i and diameter d_i , has a density given by

$$\rho_i = \frac{6M_i}{\pi D_i^3}. \quad (26)$$

From the definitions of discrete hierarchy it is obvious that

$$M_{i-1} = n_{i-1}m_{i-1} = m_i, \quad (27)$$

and if the ratio of radii of clusters is

$$a_i \equiv \frac{D_i}{d_i} = \frac{D_i}{D_{i-1}}, \quad (28)$$

then the *dilution factor* is defined as

$$\phi_i \equiv \frac{\rho_{i-1}}{\rho_i} = \frac{a_i^3}{n_i} > 1, \quad (29)$$

and the *thinning rate* is given by

$$\theta_i \equiv \frac{\log(\rho_{i-1}/\rho_i)}{\log(D_i/D_{i-1})} = \frac{\log(a_i^3/n_i)}{\log a_i}. \quad (30)$$

A *regular polka dot model* is defined as the one whose number of elements per cluster n_i and the ratio of the radii of successive clusters a_i are both constants and independent of i , that is, n and a respectively. Consequently, the dilution factor and the thinning rate are both constants in those models,

$$\phi = \frac{a^3}{n}, \quad \theta = \frac{\log(a^3/n)}{\log a}. \quad (31)$$

The *continuous representation* of the regular polka dot model, which amounts essentially to writing the hierarchical model as a continuous distribution, is obtained if we consider r , the radius of spheres centered on the origin, as a continuous variable. Then, from equation (28) the radius of the elementary point mass r_0 , is given by

$$r_0 = \frac{R_1}{a}, \quad (32)$$

where R_N is the radius of a N th order cluster with M_N mass, V_N volume, and obviously that $R_0 = r_0$. It follows from equation (32) the relationship between N and r ,

$$r = a^N r_0, \quad (33)$$

where $R_N = r$.

Notice that by doing this continuous representation Wertz ended up obtaining an equation (eq. 33) which is nothing more than exactly equation (18) of Pietronero's single fractal model, although Wertz had reached it by means of a more convoluted reasoning. Actually, the critical hypothesis which makes his polka dot model essentially the same as Pietronero's fractal model was the assumption of regularity of the model because, in this case a and n become constants. Also notice that this continuous representation amounts to changing from discrete to an indefinite hierarchy, where in the latter the characteristic length scales for clustering are absent. Therefore, in this representation clusters (and voids) extend to all ranges where the hierarchy is defined, with their sizes extending to all scales between the inner and possible outer limits of the hierarchy. Hence, in this sense the continuous representation of the regular polka dot model has exactly the same sort of properties as the fractal model discussed by Pietronero.

From equation (27) we clearly get

$$M_N = n^N M_0, \quad (34)$$

which is equal to equation (19), except for the different notation, and hence the de Vaucouleurs density power law is easily obtained as

$$\rho_v = \frac{M_N}{V_N} = \left[\frac{3M_0}{4\pi r_0^{(\log n / \log a)}} \right] r^{-\theta}, \quad (35)$$

where θ is the thinning rate

$$\theta = 3 - \left(\frac{\log n}{\log a} \right). \quad (36)$$

Notice that equations (35) and (36) are exactly equations (23), where γ is now called the thinning rate. Finally, the *differential density*, called *conditional density* by Pietronero, is defined as

$$\rho_d \equiv \frac{1}{4\pi r^2} \frac{dM(r)}{dr} = \left(1 - \frac{\theta}{3} \right) \rho_v. \quad (37)$$

From the presentation above it is then clear that from a geometrical viewpoint Wertz's continuous representation of the regular polka dot model is nothing more than Pietronero's single fractal model. However, the two approaches may be distinguished from each other by some important conceptual differences. Basically, as Pietronero clearly defines the exponent of equation (20) as a fractal dimension, that immediately links his model to the theory of critical phenomena in physics, and also to nonlinear dynamical systems, bringing a completely new perspective to the study of the distribution of galaxies, with potentially new mathematical concepts and analytical tools to investigate this problem. In addition, he strongly emphasized the fundamental importance of scaling behaviour in the observed distribution of galaxies and the fundamental role of the exponent of the power law, as well as pointing out the appropriate mathematical tool to describe this distribution, namely the fractal dimension. Finally, as many fractals have a statistical nature, either in their description or in their construction, or both, and also are inhomogeneously distributed, the statistical methods capable of dealing with fractals must also be able to derive well-defined statistical properties even from inhomogeneous samples, fractals or not, where the average density may not be well-defined. Therefore, the fractal perspective brings together a completely new set of statistical tools capable of a comprehensive reinterpretation of the conclusions drawn upon the available data about the distribution of galaxies, and without any need of *a priori* assumptions about homogeneity.

All that is missing in Wertz's approach, and his thinning rate is just another parameter in his description of hierarchy, without any special physical meaning attached to it. Therefore, in this sense his contribution started and remained as an isolated work, ignored by most, and which could even be viewed simply as an ingenious way of modelling Charlier's hierarchy, but nothing more.

Nonetheless, it should be said that this discussion must not be viewed as a critique of Wertz's work, but simply as a realization of the fact that at Wertz's time nonlinear dynamics and fractal geometry were not as developed as at Pietronero's time, if developed at all, and therefore Wertz could not have benefitted from those ideas. Despite this it is interesting

to note that even with less data and mathematical concepts he was nevertheless able to go pretty far in discussing scaling behaviour in the distribution of galaxies, developing a model to describe it in the context of Newtonian cosmology, and even suggesting some possible ways of investigating relativistic hierarchical cosmology.

3.5 Consequences of the Single Fractal Model

As stated above, the fractal model shown in the previous section offers an attractively simple explanation for the results obtained when analysing the distribution of galaxies by means of the new statistical methods advanced by Pietronero and collaborators. Thus, when this statistic is applied to a fractal system some important results that can be related to the observed distribution of galaxies are obtained. Here in this subsection we shall discuss some straightforward results arising from the fractal approach to the galaxy clustering problem. But, before we start this discussion some important remarks must be made.

Firstly, although the fractal distribution never becomes homogeneous, it is a *statistically fair sample* in the sense mentioned above, which is contrary to the traditional lines where only a homogeneous sample is taken to be a fair one.

Secondly, a three dimensional galaxy distribution (figures 22a, b), which has fractal properties when studied in 3D, appears relatively homogeneous at some large angular scale (figure 22c), loosing some of its irregular characteristics when projected on an angular distribution. Due to this property of fractal structures, it is necessary great care when dealing with projected structures, as their fractal features may become hidden when dealing with 2D data (Coleman and Pietronero 1992; Pietronero, Montuori and Sylos Labini 1997).

Thirdly, the galaxy distribution has been studied also in terms of their mass (Pietronero 1987; Coleman and Pietronero 1992) and their luminosity distribution (Pietronero, Montuori and Sylos Labini 1997), which is a full distribution and not a simple set of points. The study of these distributions requires a generalization of the fractal dimension and the use of the concept of multifractals. In this case, we have different scaling properties for different regions of the system, while in the fractal case only one exponent characterizes the entire system. A multifractal analysis also shows a new important relation between the luminosity function (Schechter luminosity distribution) and the space correlation properties.

Finally, equation (23) shows the intrinsic inhomogeneity of the fractal system, and although we cannot yet rule out the possibility of an upper cutoff to homogeneity, if the fractal system were unlimited the average density will tend to zero at increasing distances. This possibility has provoked strong reactions from some authors as they assumed it to go against established ideas in cosmology and, therefore, could not accept it. Nevertheless, it is important to point out that such a traditional view is not as sound as it seems at first, inasmuch as Ribeiro (1992, 1993, 1994) showed that even Friedmannian cosmologies do allow Wertz's zero global density postulate under a specific relativistic interpretation.

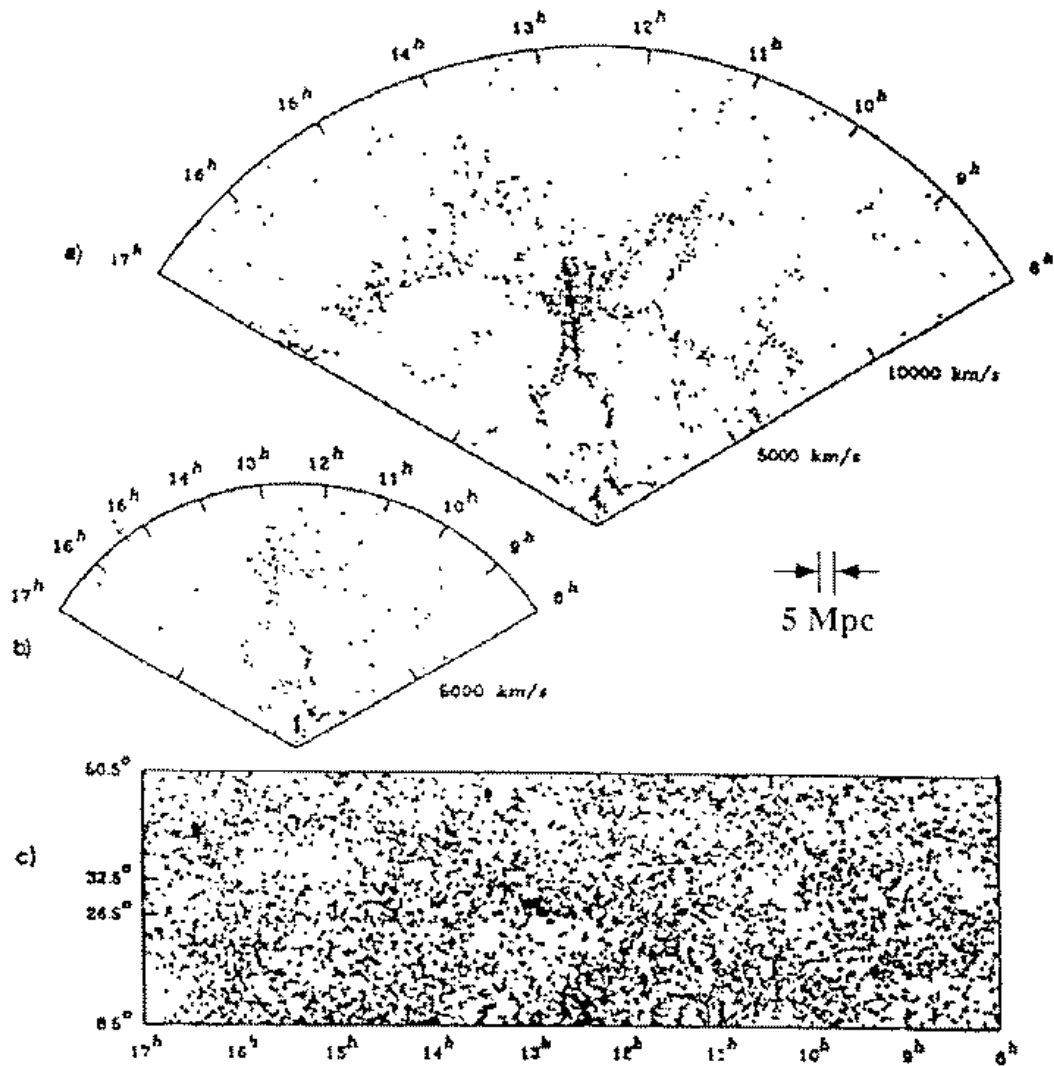

Figure 22: A slice of the three dimensional galaxy distribution (a) and (b) compared with the corresponding (c) angular distribution. Note that the angular distribution appears relatively homogeneous while the real three dimensional distribution in space is much more irregular. This picture shows the Great Wall which extends over the entire sample (at least $170 h^{-1}$ Mpc) (Pietronero, Montuori and Sylos Labini 1997).

3.5.1 Power Law Behaviour and Fractal Dimension

Pietronero (1987) defined the conditional density from an occupied point of the fractal system as being given by

$$\Gamma(r) = \frac{1}{S(r)} \frac{dN(r)}{dr} = \frac{D\sigma}{4\pi} r^{-\gamma}, \quad (38)$$

where $S(r)$ is the area of the spherical shell of radius r (this is the same as Wertz's differential density). Now by means of equations (15) and (23), it is straightforward to see that

$$\xi(r) = \left(\frac{3-\gamma}{3}\right) \left(\frac{r}{R_S}\right)^{-\gamma} - 1. \quad (39)$$

The two equations above show clearly the dependence of $\xi(r)$ on the sample size R_S while this is not the case for $\Gamma(r)$. It is clear therefore, that in a fractal system the function $\xi(r)$ mixes up the physical properties of the distribution with the sample size, an effect actually observed in analysis of catalogues, as seen above.

Since the correlation length r_0 is defined as the point at which $\xi(r) = 1$, we have

$$r_0 = \left(\frac{3-\gamma}{6}\right)^{1/\gamma} R_S, \quad (40)$$

which is dependent on R_S . Therefore, the fractal scenario explains the dependence of the correlation length r_0 with the sample size. The point at which $\xi(r) = 0$ is

$$r'_0 = \left(\frac{3-\gamma}{3}\right)^{1/\gamma} R_S. \quad (41)$$

For $r > r'_0$ the function $\xi(r)$ is negative and for $r \ll R_S$ it can be approximated by a power law,

$$\xi(r) \approx A(R_S)r^{-\gamma}, \quad (r \ll r_0), \quad (42)$$

where the two-point correlation function amplitude is given by

$$A(R_S) = \left(\frac{3-\gamma}{3}\right) R_S^\gamma. \quad (43)$$

Considering equation (10) obtained empirically, we then have a fractal dimension $D \approx 1.3$ for the distribution of galaxies in this model for small r . For larger r the fractal dimension is $D \approx 2$.

From these simple equations it is clear that with the exception of the exponent γ , all relevant features of the function $\xi(r)$ are related to the sample radius R_S and not to the intrinsic properties of the system.

Equation (43) allows us to obtain a new interpretation of the difference in the amplitude of the correlation (42). Considering now a sample radius R_G for the galaxy catalogue, the amplitude of the two-point correlation function is clearly given by

$$A_G = \left(\frac{3-\gamma}{3}\right) R_G^\gamma.$$

In the case of clusters we then have

$$A_C = \left(\frac{3-\gamma}{3}\right)R_C^\gamma.$$

The hypothesis of self-similarity means that it is the exponent of the power law which matters as giving the property of the structure. The amplitude is just a rescaling factor related to the size of the sample and the lower cutoff, without a direct physical meaning. As an example, under a rescaling of the length by a factor b such that $r \rightarrow r' = b \cdot r$, a self-similar function will be rescaled as the functional relation $f(r') = f(b \cdot r) \equiv A(b) \cdot f(r)$. This is clearly satisfied by power laws with any exponent. In fact, for $f(r) = f_0 r^D$ we have $f(r') = f_0 (br)^D = (b)^D \cdot f(r)$. Therefore, under the assumption of a single self-similar structure, the amplitudes A_G and A_C should be related by

$$\frac{A_C}{A_G} = \left(\frac{R_C}{R_G}\right)^\gamma. \quad (44)$$

Since for the galaxy and cluster catalogues we have $R_C \approx 5R_G$, equation (44) predicts (with $\gamma = 1.8$)

$$\frac{A_C}{A_G} \approx 18,$$

which is the value found for the discrepancy in the amplitudes. Note that this is a simple evaluation of the mismatch by a single deterministic fractal which does not take into account any stochastic process, which would be a more realistic situation in the case of the distribution of galaxies. This discussion shows therefore that correlations of clusters appear to be a continuation of galaxy correlations in larger scales, and the discrepancy in amplitudes simply means different observations of the same system at different depth samples.

So we see that the fractal hypothesis explains many of the puzzling problems so far encountered in the study of the large scale distribution of galaxies. It is important to say that this is accomplished with a model of remarkable simplicity, showing once more the strength of the fractal concept of dealing with this sort of complex problems. Therefore, from a theoretical point of view, due to the simplicity of the model and the strength of the concept, it becomes seductive to apply a fractal approach to modern cosmology.

3.5.2 Possible Crossover to Homogeneity

Until now we have seen that this new statistical approach shows no evidence for a homogeneous distribution of the visible matter on large scale, but we cannot yet exclude this possibility, as it may occur at some scale not yet observed.

As we saw in §3.3 the conditional density $\Gamma(r) = G(r)/\langle n \rangle$, obeys a power law for $r < \lambda_0$, and for $r \geq \lambda_0$ it is constant.

By equation (38), we have

$$\Gamma(r) = \frac{D\sigma}{4\pi} r^{-(3-D)}, \quad r < \lambda_0, \quad (45)$$

$$\Gamma(r) = n_0, \quad r \geq \lambda_0. \quad (46)$$

Then at λ_0 , we have

$$n_0 = \frac{D\sigma}{4\pi} \lambda_0^{-(3-D)}. \quad (47)$$

Therefore the function $\Gamma(r)$ has a power law behaviour up to λ_0 and it is constant thereafter.

The integrated conditional density (17) may be written as

$$I(r) = \sigma r^D, \quad r < \lambda_0, \quad (48)$$

$$I(r) = D\sigma\lambda_0^D \left(\frac{1}{D} - \frac{1}{3} \right) + \frac{1}{3} D\sigma\lambda_0^{-(3-D)}, \quad r \geq \lambda_0, \quad (49)$$

which is the total number of galaxies. The change in the power law from D to 3 indicates the crossover to length λ_0 .

If we want to consider the function $\xi(r)$ for a system with a crossover to homogeneity we have to specify our sample radius R_S ($R_S > \lambda_0$) explicitly. Considering that the density $\langle n \rangle$ is the total number of galaxies per volume unity of the sample, we have

$$\langle n \rangle = \frac{D\sigma}{4\pi} \lambda_0^{-(3-D)} \left[1 + \left(\frac{3}{D} - 1 \right) \left(\frac{\lambda_0}{R_S} \right)^3 \right] \quad (50)$$

and, considering equation (45) we obtain

$$\xi(r) = \frac{D\sigma}{4\pi} \frac{r^{-(3-D)}}{\langle n \rangle} - 1, \quad r < \lambda_0, \quad (51)$$

$$\xi(r) = \frac{D\sigma}{4\pi} \frac{\lambda_0^{-(3-D)}}{\langle n \rangle} - 1, \quad r \geq \lambda_0, \quad (52)$$

where the dependence of $\langle n \rangle$ on R_S implies that the point at which $\xi(r) = 0$ is a function of λ_0 and R_S . Then, the function $\xi(r)$, which is still inappropriate, becomes an appropriate tool only in the limiting case where $\lambda_0 \ll R_S$, in the sense that $\langle n \rangle$ becomes independent of R_S . Then, in this case we have

$$\langle n \rangle = \frac{D\sigma}{4\pi} \lambda_0^{-(3-D)}, \quad (53)$$

$$\xi(r) = \left(\frac{r}{\lambda_0} \right)^{-(3-D)} - 1, \quad r < \lambda_0, \quad (54)$$

$$\xi(r) = 0, \quad r \geq \lambda_0. \quad (55)$$

Only in this case the length r_0 is related to the correlation length λ_0 ,

$$r_0 = 2^{1/(D-3)} \lambda_0. \quad (56)$$

For the case $D \approx 2$ one has $r_0 = \lambda_0/2$.

4 Conclusions

In this paper we have studied the distribution of galaxies by means of a Newtonian fractal perspective. We began with a brief introduction to fractals, and in §3 we discussed a more appropriated statistical analysis for the large scale distribution of galaxies. We also discussed the fractal hypothesis itself which contrasts to the orthodox traditional view of an *observationally* homogeneous universe. We finished this section showing the Pietronero-Wertz's single fractal (hierarchical) model for describing and analysing the large scale distribution of galaxies and some of its consequences. In summary the main results of §3 are:

1. the employment of the two-point correlation function $\xi(r)$ for a statistical analysis of the galaxy distribution is problematic due to the *a priori* assumption of homogeneity. This assumption is hidden in the average density which does not seem to be a well defined physical property for the galaxy distribution because it is a function of the sample size, a result consistent with the fractal view of such a distribution. In order to solve this problem Pietronero (1987) introduced a new statistical approach for the galaxy distribution, which can test the assumption of homogeneity;
2. the comparison between two different methods of analysis shows that an inappropriate method leads to wrong conclusions in volume limited catalogues, due to its finite size and shallowness. Due to this they may wrongly be considered as not fair, as shown in table 1. So, an apparent homogeneous distribution in the region $V \leq r < \lambda$ of figure 16, where V is the Voronoi's length and λ is the inferior limit for reaching the correct scaling behaviour, is due to the finite size effects, and the correct scaling is reached for the region $r \geq \lambda$;
3. homogeneity must be regarded as a property of the sample and not a condition of its statistical validity;
4. the fractal model offers an attractively simple description of the galaxy distribution in the observed universe, and the results produced by the new statistical approach in the form of the conditional density $\Gamma(r)$ and its derived functions are consistent with this fractal picture. Therefore the galaxy catalogues available so far may be considered as statistically fair samples of this distribution, which is contrary to the traditional lines where only a homogeneous sample is considered to be fair;
5. from this new statistical approach we can see an agreement between various available redshift catalogues in the range of $0.1 - 10^3 \text{ h}^{-1} \text{ Mpc}$, as shown in figure 17, without any tendency to homogeneity at this scale. These redshift catalogues obey a density power law decay and have fractal dimension $D \approx 2$;
6. a three dimensional galaxy distribution, which has fractal properties when projected on an angular distribution, appears relatively homogeneous at some large scale;

7. the function $\xi(r)$ becomes an appropriate tool only in the limiting case where the sample size is much bigger than the new correlation scale, that is, when $\lambda_0 \ll R_S$, so that the orthodox correlation length r_0 is related only to the new correlation length λ_0 , and not to the sample size R_S .

Some authors, although recognizing the problems of the standard analysis, have argued against a fractal distribution from a somewhat unconvincing perspective. For example, Davis et al. (1988) have claimed that although their analysis confirm the dependence of the correlation length with the sample size, this effect cannot be explained by Pietronero's single fractal model because they found r_0 to be approximately proportional to the square root of the sample size, while it is linear in Pietronero's picture. Davis et al. (1988) nevertheless have offered only statistical explanations where it is not always clear what are the hidden hypotheses assumed by them. This point is of especial concern due to the current widespread practice of "correcting" the samples in order to "improve" them for "better" statistics. The problem with this sort of practice is that the homogeneous hypothesis is often implicit, and this fact considerably weakens that kind of statistical explanations.¹⁰

Another important point that ought to be said again about the fractal system as defined above is its total incompatibility with the two-point correlation function $\xi(r)$. The problem lies in the fact that this sort of fractal system does not have a well defined average density, at least in between upper and lower cutoffs. Ruffini, Song and Taraglio (1988) have, nonetheless, pointed out that there are fractal systems in which the average density does tend to a finite and non-zero value, which led them to suppose that this should be the case in cosmology. Although this is a reasonable point to raise, the problem with this argument, as we see it, is again the *a priori* assumption that this must be the case in cosmology, i.e., that in cosmology the average density ought to tend to a finite non-zero limit for very large distances. Obviously, behind this idea lies the homogeneous hypothesis which Ruffini, Song and Taraglio (1988) try to incorporate into the fractal cosmology, but, once again, by means of an untested argument. From a relativistic perspective, at first it would seem reasonable to think that this should be the case because the standard Friedmannian cosmology is spatially homogeneous, and as this is the most popular relativistic cosmological model, we would have to incorporate some sort of homogenization or upper cutoff in the model, sooner or later. However, as shown by Ribeiro (1992, 1993, 1994) this viewpoint may be a rather misleading approach to the problem as we can have an interpretation of the Friedmann models where they have no well defined average density.

The conceptual advantage of Pietronero's scenario is the absence of this sort of *a priori* reasoning, which means that it has the ability of describing properly the distribution of galaxies if it really forms a fractal structure. In other words, this scenario is able to free ourselves from the homogeneity hypothesis, putting us in a position to *test* whether or not

¹⁰ See Coleman and Pietronero (1992) for criticisms of this sort of practice and some examples of these "corrections" where the homogeneous hypothesis is actually implicit in those procedures.

the galaxies are actually distributed uniformly, rather than starting assuming it as so far has been mostly done in the literature concerning observational cosmology. If the distribution of galaxies does tend to homogeneity, this will be indicated in the measurements of the fractal dimension inasmuch as in such case it will tend to the value $D = 3$. Nevertheless, despite this advantage offered by the fractal picture, some researchers still claim that fractals bring “nothing new” to the galaxy clustering problem, while others, even if accepting fractals at small scales, insist on the need for an eventual homogeneity at an unspecified large scale. It is our point of view that it is best to allow this issue to be decided by the observations themselves, by the measurement of D , rather than be guided, or misguided, by untested assumptions on homogeneity as has been mostly done so far. In such case, great care must be exercised in order to avoid introducing in the tests the very hypotheses that they are supposed to verify. Currently there is a lot of controversy surrounding those points of homogenization or not at larger scales and the validity of the methods used, with claims and counter claims on the results published succeeding each other, and no apparent sight of a consensus being even close to being achieved. ¹¹

Acknowledgements

We are grateful to F. Sylos Labini for reading the original manuscript and for helpful comments. The financial support from FAPERJ and CNPq is, respectively, acknowledged by MBR and AYM.

References

- Barnsley, M. 1988, *Fractals Everywhere* (London: Academic Press).
- Baryshev, Y., Sylos Labini, F., Montuori, M. and Pietronero, L. 1994, *Vistas in Astron.*, 38, 419.
- Bélaïr, J. and Dubuc, S. (eds.) 1991, *Fractal Geometry and Analysis* (Dordrecht: Kluwer).
- Calzetti, D. et al. 1987, *Ap. Space Sci.*, 137, 101.
- Calzetti, D. and Giavalisco, M. 1991, in *Applying Fractals in Astronomy*, p. 119, ed. A. Heck and J. M. Perdang (Berlin: Springer-Verlag).
- Coleman, P. H. and Pietronero, L. 1992, *Phys. Reports*, 213, 311.

¹¹ The tip of the iceberg of this controversy can be seen in the following papers: Coleman, Pietronero and Sanders (1988); Peebles (1989); Calzetti and Giavalisco (1991); Coleman and Pietronero (1992); Maurogordato, Schaeffer and da Costa (1992); Peebles (1993, 1996); Davis (1997); Pietronero (1997); Pietronero, Montuori and Sylos Labini (1997); Coles (1998); Sylos Labini, Montuori and Pietronero (1998). Additional references about this debate can also be found at <http://www.phys.uniroma1.it/DOCS/PIL/pil.html>.

- Coleman, P. H., Pietronero, L. and Sanders, R. H. 1988, *A & A*, 200, L32.
- Coles, P. 1998, *Nature*, 391, 120.
- Davis, M. 1997, *Is the Universe Homogeneous on Large Scales?*, in *Critical Dialogues in Cosmology*, p. 13, ed. N. Turok (Singapore: World Scientific).
- Davis, M. et al. 1988, *ApJ*, 333, L9.
- de Vaucouleurs, G. 1970, *Science*, 167, 1203.
- Einasto, J. Klypin, A. A. and Saar, E. 1986, *M. N. R. A. S.* , 219, 457.
- Falconer, K. 1990, *Fractal Geometry: Mathematical Foundations and Applications* (Chichester: John Wiley and Sons).
- Feder, J. 1988, *Fractals* (New York: Plenum Press).
- Geller, M. 1989, *The Large-Scale Distribution of Galaxies*, in *Astronomy, Cosmology and Fundamental Physics*, p. 83, eds. M. Caffo, R. Fanti, G. Giacomelli and A. Renzini (Dordrecht: Kluwer Academic Publishers).
- de Lapparent, V., Geller, M. J. and Huchra, J. P. 1986, *ApJ*, 302, L1.
- Mandelbrot, B. B. 1983, *The Fractal Geometry of Nature* (New York: Freeman).
- Maurogordato, S., Schaeffer, R. and da Costa, L. N. 1992, *ApJ*, 390, 17.
- Peebles, P. J. E. 1980, *The Large-Scale Structure of the Universe* (Princeton University Press).
- Peebles, P. J. E. 1989, *Physica*, 38D, 273, [in *Fractals in Physics, Proc. of the International Conference honouring Benoit B. Mandelbrot on his 65th birthday*, p. 273, eds. A. Ahorony and J. Feder (North Holland)].
- Peebles, P. J. E. 1993, *Principles of Physical Cosmology* (Princeton University Press).
- Peebles, P. J. E. 1996, *circular letter to L. Pietronero*: available at <http://www.phys.uniroma1.it/DOCS/PIL/peebles.html>.
- Peitgen, H-O, Jürgens, H. and Saupe, D. 1992, *Fractals for the Classroom - Part One: Introduction to Fractals and Chaos* (New York: Springer-Verlag).
- Pietronero, L. 1987, *Physica*, 144A, 257.
- Pietronero, L. 1988, *Fractals in Physics: Introductory Concepts*, in *Order and Chaos in Nonlinear Physical Systems*, p. 277, ed. S. Lundqvist, N. H. March and M. P. Tosi (New York: Plenum Press).

- Pietronero, L. 1997, *circular letter to P. J. E. Peebles*: available at <http://www.phys.uniroma1.it/DOCS/PIL/lett-lp.ps>.
- Pietronero, L., Montuori, M. and Sylos Labini, F. 1997, *On the Fractal Structure of the Visible Universe*, in *Critical Dialogues in Cosmology*, p. 24, ed. N. Turok (Singapore: World Scientific).
- Raine, D. J. 1981, *The Isotropic Universe: An Introduction to Cosmology*, (Bristol: Adam Hilger).
- Ribeiro, M. B. 1992, *ApJ*, 395, 29.
- Ribeiro, M. B. 1993, *ApJ*, 415, 469.
- Ribeiro, M. B. 1994, *Relativistic Fractal Cosmologies*, in *Deterministic Chaos in General Relativity*, p. 269, ed. D. Hobill *et al.* (New York: Plenum Press).
- Ribeiro, M. B. 1995, *ApJ*, 441, 477.
- Ruffini, R., Song, D. J. and Taraglio, S. 1988, *A & A*, 190, 1.
- Saunders, W. et al. 1991, *Nature*, 349, 32.
- Sylos Labini, F., Gabrielli, A., Montuori, M. and Pietronero, L. 1996, *Physica A*, 226, 195.
- Sylos Labini, F., Montuori, M. and Pietronero, L. 1998, *Phys. Reports*, 293, 61.
- Takayasu, H. 1990, *Fractals in the Physical Sciences* (Manchester University Press).
- Wertz, J. R. 1970, *Newtonian Hierarchical Cosmology*, PhD thesis (University of Texas at Austin).
- Wertz, J. R. 1971, *ApJ*, 164, 227.