

MULTITERMINAL COUNTING STATISTICS

DMITRI A. BAGRETS, YULI V. NAZAROV

*Department of Applied Physics and
Delft Institute of Microelectronics and Submicronotechnology,
Delft University of Technology, Lorentzweg 1, 2628 CJ Delft,
The Netherlands*

Abstract. The review is given of the calculational schemes that allows for easy evaluation of full current statistics (FCS) in multi-terminal mesoscopic systems. First, the scattering approach by Levitov *et.al* to FCS is outlined. Then the multi-terminal FCS of the non-interacting electrons is considered. We show, that this theory appears to be a circuit theory of 2×2 matrices associated with Keldysh Green functions. Further on the FCS in the opposite situation of mesoscopic systems placed in a strong Coulomb blockade limit is discussed. We prove that the theory of FCS in this case turns out to be an elegant extension of the master equation approach. We illustrate both methods by applying them to the various three-terminal circuits. We study the FCS of electron transfer in the three-terminal chaotic quantum dot and compare it with the statistics of charge transfer in the Coulomb blockade island with three leads attached. We demonstrate that Coulomb interaction suppresses the relative probabilities of big current fluctuations. Finally, for the generic case of single resonance level the equivalence of scattering and master equation approach to FCS is established.

1. Introduction

The field of quantum noise in mesoscopic systems has been exploded during the last decade, some achievements being summarized in a recent review article. [1] While in classical systems shot noise is just a straightforward manifestation of discreteness of the electron charge, it can be used in quantum system as unique tool to reveal the information about the electron correlations and entanglement of various kinds. Measurement of fractional charge in Quantum Hall regime [2], noise measurements in atomic-size junctions [3], chaotic quantum dots[4] and superconductors [5, 6] are milestones of the field of quantum noise. Starting from the pioneering work of Büttiker[7], a special attention has been also paid to shot noise and noise

correlations in the "multi-terminal" circuits. The correlations of currents flowing to/from different terminals can, for instance, reveal Fermi statistics of electrons. Such cross-correlations have been recently seen experimentally in Ref. [8, 9, 10].

A very important step in the field of quantum noise has been made by Levitov *et. al.* in [11, 12] where an elegant theory of *full counting statistics* (FCS) has been presented. This theory provides an efficient way to investigate the current correlations in the mesoscopic systems. The FCS method concentrates on the evaluation of the probability distribution function of the numbers of electrons transferred to the given terminals during the given period of time. It yields not only the noise, but all higher moments of the charge transfer. The probability distribution also contains the fundamental information about big current fluctuations in the system.

Original FCS method [11, 12] was formulated for the scattering approach to mesoscopic transport. This made possible the study the statistics of the transport through the disordered metallic conductor [13] and the two-terminal chaotic cavity [14]. Muzykantskii and Khmelnitskii have generalized the original approach by Levitov *et. al.* to the case of the normal metal/superconducting contacts. The very recent application of the scattering approach is the counting statistics of the charge pumping in the open quantum dots [15, 16, 17].

However, scattering approach becomes unpractical in case of realistic layouts where the scattering matrix is multi-channel, random and cumbersome. For practical calculations one evaluates the FCS with the semi-classical Keldysh Green function method [18] or with its reduction called the circuit theory of mesoscopic transport [19]. The Keldysh method to FCS was first proposed by one of the authors. It has been applied to treat the effects of the weak localization corrections onto the FCS in the disordered metallic wires and later on to study the FCS in superconducting heterostructures [20].

The above researches address the FCS of the non-interacting electrons in case of common two-terminal geometry. Although the cross-correlations for several multi-terminal layouts have been understood [1], the evaluation of FCS encountered difficulties. For instance, an attempt to build up FCS with "minimal correlation approach" [21] has lead to contradictions [14]. Very few is known about FCS of interacting electrons [22, 23]. Since the interaction may bring correlations and entanglement of electron states the study of FCS of interacting electrons, particularly for the case of multi-terminal geometry, is both challenging and interesting.

In the present work we review the calculational scheme that allows for easy evaluation of FCS in multi-terminal mesoscopic systems. The paper is organized as follows. In the section II we outline the scattering approach by

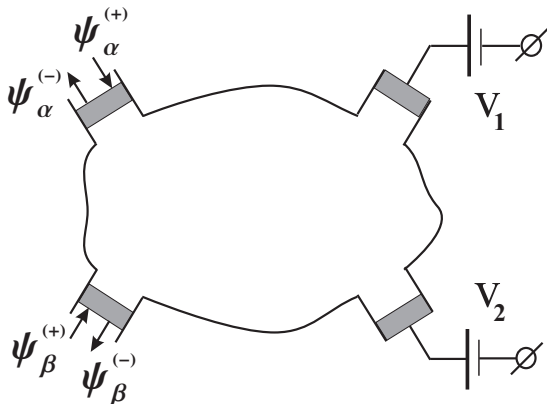

Figure 1. The "multi-terminal" mesoscopic conductor.

Levitov *et.al* to FCS. Section III is devoted to the multi-terminal FCS of the non-interacting electrons. We show, that this theory appears to be a circuit theory of 2×2 matrices associated with Keldysh Green functions [24]. In the section IV we concentrate on FCS in the opposite situation of mesoscopic systems placed in a strong Coulomb blockade limit. We prove that the FCS in this case turns out to be an elegant extension of the master equation approach. We illustrate both methods by applying them to the various three-terminal circuits. We study the FCS of electron transfer in the three-terminal chaotic quantum dot and compare it with the statistics of charge transfer in the Coulomb blockade island with three leads attached. We demonstrate that Coulomb interaction suppresses the relative probabilities of big current fluctuations. In section V we establish the equivalence of scattering and master equation approach to FCS, by considering the statistics of charge transfer through the single resonance level. Finally, we summarize the results in the section VI.

2. Scattering approach to FCS

In this section we review the current statistics of non-interacting electrons, using the ideas of general scattering approach to mesoscopic transport. The problem of FCS in this framework has been solved about a decade ago by Levitov *et. al* [11, 12]. Their work, concentrated on the two-terminal geometry [12], became widely cited. But, unfortunately, their preceding paper[11], devoted to multi-terminal systems as well, is only partially known. We will also demonstrate its relation to the current-current correlations in multi-terminal conductors, first investigated by M.Büttiker [7].

The most general mesoscopic system, eligible to scattering approach, is shown in Fig. 1. It is a phase coherent mesoscopic conductor, connected to macroscopic reservoirs (leads, terminals) by means of n external contacts ($n \geq 2$). We concern the situation when the system is placed in the non-equilibrium condition, thus each terminal α is characterized by a distribution function $f_\alpha(\varepsilon)$ of electrons over the energy. When the terminal is in local equilibrium at electro-chemical potential V_α and a temperature T_α , then $f_\alpha(\varepsilon)$ reduces to Fermi distribution $f_\alpha(\varepsilon) = \{1 + \exp[(\varepsilon - eV_\alpha)/kT_\alpha]\}^{-1}$.

The conductor is a region of disordered or chaotic scattering. The scattering within conductor is assumed to be elastic. This is true at sufficiently low energies, such that the energy dependent length of inelastic scattering exceeds the sample size. As to the terminals, it is conveniently to assume, that far from the contacts the longitudinal (along the lead) and transverse (across the lead) motion of electrons are separable. Then at fixed energy ε the transverse motion in the lead α is quantized and described by the integer index $n_\alpha = 1 \dots M_\alpha(\varepsilon)$, with $M_\alpha(\varepsilon)$ being the total number of propagating modes at given energy. Each n_α corresponds to one incoming to the contact and one outgoing from the contact α solution of the Schrödinger equation, which is usually referred as a scattering channel.

The idea behind the scattering approach is that the electron transport can be described as the one-particle scattering from the incoming channels to the outgoing channel in the leads. Very generally it can be described by a unitary scattering matrix $\hat{S}(\varepsilon)$. At given energy its dimension is equal to M , $M = \sum_\alpha M_\alpha$ being the total number of transport channels. The energy dependence of the scattering matrix is set by the "Thouless energy" $E_{\text{Th}} = \hbar/\tau_d$, τ_d being the traversal time through the system. At sufficiently low temperatures, voltages and frequencies, such that $\max\{eV, kT, \hbar\omega\} \ll E_{\text{Th}}$, one can conveniently disregard the energy dependence and concentrate on the scattering matrix $\hat{S}(E_F)$, taken at Fermi surface. Then the scattering approach gives the adequate description of the transport, provided the effects of Coulomb blockade can be neglected. This is justified, when the total conductance G of the sample is much larger than the conductance quantum $G_Q = e^2/2\pi\hbar$.

One starts by introducing the scattering matrix \hat{S} of electrons at a narrow energy strip $\sim \max(eV, kT) \ll E_{\text{Th}}$ in the vicinity of Fermi energy E_F . The S -matrix relates the amplitudes $\psi_{m,\beta}^{(+)}$ of incoming electrons to the amplitudes $\psi_{n,\alpha}^{(-)}$ of the outgoing ones (See Fig. 1):

$$\psi_{n,\alpha}^{(-)} = \sum_{m,\beta} S_{nm,\alpha\beta} \psi_{m,\beta}^{(+)} \quad (1)$$

Here Latin indexes (n, m) refer to the particular quantum scattering chan-

nel in given leads (α, β) . (See e.g. [1, 7, 30] for a more detailed introduction.) It is worth to mention that at this stage $\psi_{n,\alpha}^{(\pm)}$ correspond to the amplitude of the wave function in the *exterior* area of the contacts. Thus defined S -matrix incorporates the information about scattering in the whole system. This includes the scattering from the disordered/chaotic regions of the conductor as well as multiple reflections from external contacts.

Remarkably, the FCS can be expressed in terms of the scattering matrix in quite a general way. It has been shown by Levitov *et. al.* [11]. The FCS approach deals with the probability distribution $P(\{N_i\})$ for N_i electrons to be transferred through the terminal i during time interval t_0 . The detection time t_0 is assumed to be much greater than e/I , I being a typical current through the conductor. This ensures that in average $\bar{N}_i \gg 1$. The probability distribution $P(\{N_i\})$ can be conveniently expressed via generating function ("action") $\mathcal{S}(\{\chi_i\})$ by means of Fourier transform

$$P(\{N_i\}) = \int_{-\pi}^{\pi} \prod_i \frac{d\chi_i}{2\pi} e^{-\mathcal{S}(\{\chi_i\}) - i \sum_i N_i \chi_i}. \quad (2)$$

Here χ_i are the parameters of this generating function ("counting fields"), each of them being associated with a given terminal i . The generating function $\mathcal{S}(\{\chi_i\})$ contains the whole information about the irreducible moments of charge transfer through the system, as well as the information about big current fluctuations. Indeed, it follows from Exp. (2) that (higher-order) derivatives of \mathcal{S} with respect to χ_i , evaluated at $\chi_i = 0$, give (higher-order) irreducible moments of $P(\{N_i\})$. First derivatives yield average currents to terminals, second derivatives correspond to the noises and noise correlations.

The result of Levitov *et. al.* for the generating function $\mathcal{S}(\{\chi_i\})$ reads as follows. One considers the energy-dependent determinant

$$\mathcal{S}_E(\{\chi_i\}) = \ln \text{Det} \left(1 - \hat{f}_E + \hat{f}_E \hat{S}^\dagger \tilde{S} \right) \quad (3)$$

where the matrix $(\hat{f}_E)_{mn,\alpha\beta} = f_\alpha(E)$ is diagonal in the channel indexes (m, n) and the matrix \tilde{S} is defined as $\tilde{S}_{mn,\alpha\beta} = e^{i(\chi_\alpha - \chi_\beta)} S_{mn,\alpha\beta}$. It has been proved that this expression represents a characteristic function of the probability distribution of transmitted charge for electrons with energies in an infinitesimally narrow energy strip in the vicinity of E . After that the complete generating function $\mathcal{S}(\{\chi_i\})$ is just a sum over energies

$$\mathcal{S}(\{\chi_i\}) = t_0 \int \mathcal{S}_E(\{\chi_i\}) \frac{dE}{2\pi\hbar} \quad (4)$$

This expression reflects the fact that electrons at different energies are transferred independently, without interference. Therefore they yield additive independent contributions to the generating function.

The general results for the FCS, contained in Eqs. (3) and (4), provides the elegant way to derive the pioneering results of M. Büttiker [7], concerning the current-current correlations in the multiterminal conductors. One considers the correlation function

$$P_{\alpha\beta}(t-t') = \frac{1}{2} \left\langle \Delta \hat{I}_\alpha(t) \Delta \hat{I}_\beta(t') + \Delta \hat{I}_\beta(t') \Delta \hat{I}_\alpha(t) \right\rangle \quad (5)$$

of currents fluctuations in contacts α and β . The fluctuation $\Delta \hat{I}_\alpha(t)$ is defined as $\Delta \hat{I}_\alpha(t) = \hat{I}_\alpha(t) - \langle I_\alpha \rangle$, with $\hat{I}_\alpha(t)$ being the current operator in the lead α and $\langle I_\alpha \rangle$ being its mean steady value under given non-equilibrium conditions. The Fourier transform $P_{\alpha\beta}(\omega)$ of current-current correlations functions is sometimes referred to as noise power. Throughout this article we concentrate on zero-frequency (shot-noise) limit of current correlations $P_{\alpha\beta} \equiv P_{\alpha\beta}(\omega = 0)$. At low frequencies both $\langle I_\alpha \rangle$ and $P_{\alpha\beta}$ are readily expressed via the first (second) moments of number of transferred electrons through the corresponding leads

$$\langle I_\alpha \rangle = \frac{e}{t_0} \langle N_\alpha \rangle, \quad P_{\alpha\beta} = \frac{e^2}{t_0} \langle \Delta N_\alpha \Delta N_\beta \rangle \quad (6)$$

Therefore the second derivative $\frac{\partial^2}{\partial \chi_\alpha \partial \chi_\beta} \mathcal{S}(\{\chi_i\})$ of the action yields the result for the shot-noise correlation function $P_{\alpha\beta}$. It can be reduced to the following form

$$P_{\alpha\beta} = \frac{e^2}{\pi \hbar} \int dE \sum_{\gamma\mu} \text{Tr} \left\{ A_{\gamma\mu}^\alpha A_{\mu\gamma}^\beta \right\} f_\gamma(E) (1 - f_\mu(E)) \quad (7)$$

Here the matrix $A_{\gamma\mu}^\alpha$ is defined via S -matrix as

$$A_{\gamma\mu}^\alpha(E) = \delta_{\alpha\gamma} \delta_{\alpha\mu} - S_{\alpha\gamma}^\dagger(E) S_{\alpha\mu}(E) \quad (8)$$

This is precisely the result obtained by M. Büttiker prior the development of FCS approach.

Up to the moment the scattering matrix \hat{S} was not specified. In order to evaluate the FCS, one needs to construct such a matrix, so that to take into account the scattering properties of the concrete mesoscopic system at hand. To accomplish this task, one may proceed as follows. Very generally, one can separate a mesoscopic layout into primitive elements: nodes and connectors. The nodes are similar to the terminals, in the sense, that each of them can be characterized by some non-equilibrium isotropic distribution function of electrons over the energies. The illustrative example of the node is chaotic quantum dot. The scattering within the node is assumed

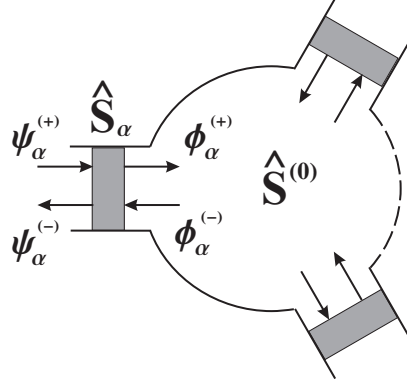

Figure 2. The building blocks of a scattering matrix of the multi-terminal chaotic quantum dot. The matrix \hat{S}_α describes the scattering due to the contact α . The matrix $\hat{S}^{(0)}$ describes the chaotic scattering within the dot.

to be random (chaotic). The connectors represent themselves either internal or external contacts in the systems, scattering properties of which are supposed to be known. The actual implementation of connectors can be quite different: quantum point contacts, tunnel junctions, diffusive wires, etc. The purpose of the above separation is to ascribe to each node and to connector the particular unitary scattering matrix with known properties. Then the scattering matrix \hat{S} of the entire system can be unambiguously expressed via these primitive scattering matrices.

We outline this scheme for the simple system, consisting of the single node only. A good example of such system is a multi-terminal chaotic quantum dot, shown in Fig. 2. It is coupled to n external reservoirs via n contacts. Each contact α is described by a unitary scattering matrix \hat{S}_α . (Its choice depends on the experimental realization of this given contact.) Let $\phi_{m,\alpha}^{(\pm)}$ be the coefficients of electron wave function, taken at the *interior* boundary of the contact. The amplitudes $\phi_{m,\alpha}^{(+)}$ and $\phi_{m,\alpha}^{(-)}$ correspond to the outgoing (incoming) waves from (to) the the contact α respectively, as shown in Fig. 2. The scattering matrix \hat{S}_α relates the vector $c^{\text{in}} = (\psi_\alpha^{(+)}, \phi_\alpha^{(-)})^T$ of the incident electron waves to the vector $c^{\text{out}} = (\psi_\alpha^{(-)}, \phi_\alpha^{(+)})^T$ of the outgoing waves:

$$c^{\text{out}} = \hat{S}_\alpha c^{\text{in}} = \begin{pmatrix} r_\alpha & t'_\alpha \\ t_\alpha & r'_\alpha \end{pmatrix} c^{\text{in}} \quad (9)$$

Here the square blocks r_α (r'_α) of the size $(M_\alpha \times M_\alpha)$ describe the electron reflection back to the reservoirs or back to the dot, respectively. The

off-diagonal blocks t_α (t'_α) of the same dimension are responsible for the transmission through the contact α .

Similarly, the chaotic scattering of electrons inside the dots is described by the scattering matrix $\hat{S}^{(0)}$. By analogy to Eq. (1), it relates within the dot amplitudes $\phi_{m,\beta}^{(+)}$ to $\phi_{n,\alpha}^{(-)}$, i.e.

$$\phi_{n,\alpha}^{(-)} = \sum_{m,\beta} S_{nm,\alpha\beta}^{(0)} \phi_{m,\beta}^{(+)} \quad (10)$$

The dimension ($M \times M$) of $\hat{S}^{(0)}$ is equal to that of the matrix \hat{S} .

It is possible now to express the scattering matrix \hat{S} of the entire sample in terms of \hat{S}_α ($\alpha = 1 \dots n$) and $\hat{S}^{(0)}$. One can use the set of equation (9) and (10) in order to find the linear relations between amplitudes $\psi^{(+)}$ and $\psi^{(-)}$. According to Eq. (1) it will uniquely determine the matrix elements of \hat{S}_α . The result reads:

$$\hat{S} = \hat{r} + \hat{t}' \hat{S}^{(0)} \frac{1}{1 - \hat{r}' \hat{S}^{(0)}} \hat{t} \quad (11)$$

Here \hat{r} (\hat{r}') and \hat{t} (\hat{t}') are block diagonal matrices with elements $\hat{r}_{mn,\alpha\beta} = \delta_{\alpha\beta}(\hat{r}_\alpha)_{mn}$ and $\hat{t}_{mn,\alpha\beta} = \delta_{\alpha\beta}(\hat{t}_\alpha)_{mn}$. The denominator of Eq. (11) describes the multiple reflection due to contacts within the dot. It can be verified, that \hat{S} is unitary, $\hat{S}^\dagger \hat{S} = 1$, provided $\hat{S}^{(0)}$ and \hat{S}_α are also unitary. The analogous construction of S -matrix can be in principle implemented for the more complicated layouts.

To evaluate FCS one substitutes \hat{S} into Eqs. (3) and (4) in the form (11). The matrices \hat{S}_α are fixed by the choice of the properties of the contacts. However, the matrix $\hat{S}^{(0)}$ is random describing chaotic scattering inside the dot. This means that the answer should be *averaged* over all possible realization of $\hat{S}^{(0)}$. A reasonable assumption is that $\hat{S}^{(0)}$ is uniformly distributed in the space of all unitary matrices [30].

Thereby one solves the problem for a single node. For less trivial system, comprising two and more nodes, the expression for the \hat{S} -matrix, corresponding to Eq. (11), becomes more involved. Moreover one has to average over unitary matrices separately for each node. Besides, to describe a simple system of diffusive wire one has eventually to go to the limit of infinitely many nodes. All this makes the scattering approach extremely inconvenient. Fortunately, one can treat these problems with a more flexible semiclassical Green function method, which we outline in the next section. It is applicable, since we assume that the conductance of the system $G \gg G_Q$.

3. Circuit theory of FCS in multi-terminal circuits

In this section we formulate the semiclassical theory of FCS of non-interacting electrons in case of multi-terminal geometry. Our approach is based on the Keldysh Green function method. We develop the scheme to evaluate the FCS in the arbitrary multi-terminal mesoscopic system. For that we will use the circuit theory of mesoscopic transport [19]. Next, we illustrate this scheme, considering the big fluctuations of current in the three-terminal chaotic quantum dot. In the end of the section we discuss the shot-noise correlations and give the convenient expressions that depend on the scattering properties of connectors only, and do not involve the scattering inside the cavity.

3.1. CIRCUIT THEORY APPROACH TO THE FCS.

We start by introducing current operators \hat{I}_i , each being associated with the current to/from a certain terminal i . Extending the method of [18] we introduce a Keldysh-type Green function defined by

$$\left(i \frac{\partial}{\partial t} - \hat{H} - \frac{1}{2} \bar{\tau}_3 \sum_i \chi_i(t) \hat{I}_i \right) \otimes \check{G}(t, t') = \delta(1 - 1') \quad (12)$$

Here we follow notations of a comprehensive review [25]: χ_i are time-dependent parameters, $\bar{\tau}_3$ is a 2×2 matrix in Keldysh space, \hat{H} is the one-particle Hamiltonian that incorporates all information about the system layout, including boundaries, defects and all kinds of elastic scattering. We use "hat", "bar" and "check" to denote operators in coordinate space, matrices in Keldysh space and operators in direct product of these spaces respectively. The current operator in Eq. (12), associated with the terminal i , is defined as $\hat{I}_i = \int d^3x \Psi^\dagger(\mathbf{p}/m) \Psi \nabla F_i(x)$. Here Ψ is the usual Fermi field operator and $\nabla F_i(x)$ is chosen such a way that the spatial integration is restricted to the cross-section and yields the total current through the given lead. The Eq. (12) defines the Green function unambiguously provided boundary conditions are satisfied: $\check{G}(t, t') \equiv \bar{G}(x, x'; t, t')$ approaches the common equilibrium Keldysh Green functions $\check{G}_i^{(0)}(t - t')$ provided x, x' are sufficiently far in the terminal i . These $\check{G}_i^{(0)}(t - t')$ incorporate information about the state of the terminals: their voltages V_i and temperatures T_i .

In the following we will operate with the cumulant generating function ("action") $S(\{\chi_i\})$ defined as a sum of all closed diagrams

$$e^{-S(\{\chi_i\})} = \left\langle T_\tau e^{i \sum_{i=1}^N \int_{-\infty}^{+\infty} d\tau \chi_i(\tau) \check{I}^{(i)}(\tau)} \tilde{T}_\tau e^{i \sum_{i=1}^N \int_{-\infty}^{+\infty} d\tau \chi_i(\tau) \check{I}^{(i)}(\tau)} \right\rangle \quad (13)$$

Here T_τ (\tilde{T}_τ) denotes the (anti) time ordering operator. One can see by traditional diagrammatic methods [25] that the expansion of $S(\{\chi_i\})$ in powers of $\chi_i(t)$ generates all possible irreducible diagrams for higher order correlators of $\hat{I}_i(t)$ and thereby incorporates all the information about statistics of charge transfer. If we limit our attention to low-frequency limit of current correlations, we can keep time-independent χ_i . In this case, the Green functions are functions of time difference only and the Eq.(12) separates in energy representation. Then the action $S(\{\chi_i\})$ can be conveniently expressed via the average χ -dependent currents $I_i(\{\chi_i\})$ in the following way

$$\frac{i}{t_0} \frac{\partial S}{\partial \chi_i} = I_i(\{\chi_i\}) \equiv \int \frac{d\varepsilon}{2\pi} \text{Tr} (\bar{\tau}_3 \hat{I}_i \check{G}(\varepsilon)) \quad (14)$$

where t_0 denotes the time of measurement. Thus defined cumulant generating functions allows to evaluate the probability for N_i electrons to be transferred to the terminal i during time interval t_0 in accordance with the general relation (2).

Up to the moment the above Eqs. (12) and (13) can be used to define the statistics of any quantum mechanical variable. However we are interested in the statistics of the *charge* transfer. Since the charge is the conserved quantity, the proper construction of current operators \hat{I}_i requires the gauge invariance of the Hamiltonian. Therefore fully quantum mechanical scheme includes the "counting" fields $\chi_i(t)$ as *gauge* fields. (See the contribution of L.Levitov in this book.) It means, that the initial physical Hamiltonian $H(\mathbf{q}, \mathbf{p})$ of the system should be replaced by the χ -dependent Hamiltonian $H_\chi = H(\mathbf{q}, \mathbf{p} - \frac{1}{2}\bar{\tau}_3 \sum_i \chi_i \nabla F_i)$. Thus the appearance of the "counting" fields in the problem is similar to the inclusion of a vector potential $\mathbf{A}(\mathbf{r})$ of an ordinary electromagnetic gauge field. The crucial difference is the change of sign of interaction at the forward and backward branches of the Keldysh contour, that is reflected by the presence of $\bar{\tau}_3$ matrix. Then the χ -dependent Green function obeys the equation of motion, written with the use of χ -dependent Hamiltonian H_χ . Accordingly, the "action" $S(\{\chi_i\})$ is defined as a sum of all closed diagrams with respect to the interaction $H_{\text{int}} = H_\chi - H$.

Thus defined constructions are locally gauge invariant with respect to rotation in the Keldysh space. In particular, the average current (14) is a conserved quantity, provided the current operator is defined as $\hat{I}_i = \partial H_\chi(t) / \partial \chi_i$. Therefore it is possible to perform the local gauge transformation $\psi' = \exp\{-(i/2)\bar{\tau}_3 \sum_i \chi_i F_i\} \psi$ in order to eliminate the χ -dependent terms from the equation of motion(12) [18, 20]. The χ -dependence of \check{G} is thereby transferred to the boundary conditions: the gauged Green function far in each terminal shall approach $\check{G}_i(\epsilon)$ defined as

$$\check{G}_i(\epsilon) = \exp(i\chi_i \bar{\tau}_3 / 2) \check{G}_i^{(0)}(\epsilon) \exp(-i\chi_i \bar{\tau}_3 / 2) \quad (15)$$

Here $\check{G}_i^{(0)}(\epsilon)$ corresponds to the equilibrium Keldysh Green function sufficiently far in the given terminal i . The precise form of the Green functions $\check{G}_i^{(0)}(\epsilon)$ will be explicitly given below in the text. [See Eq. (19)]

Let us also note that the modification of current operators \hat{I}_i by the "counting" fields can be safely omitted at energies near the Fermi surface, where one can linearize the electron spectrum. This is possible in the semiclassical approximation when the variation of ∇F_i is small at the scale of the Fermi wave length. Expanding the H_χ on the Fermi shell, one arrives to Eqs. (12) and (13). Afterwards it is feasible to verify the result (15), with making use of the semiclassical Eilenberger equations. (For the details we refer the reader to the paper of W.Belzig in this book.)

In the present form, the Eq. (12) with relations (15,14) solves the problem of determination of the FCS for any arbitrary system layout: one just has to find exact quantum-mechanical solution of a Green function problem. This is hardly constructive, and we proceed further by deriving a simplified semiclassical approach. First, we note that even in its exact quantum-mechanical form the Eq.(12) possesses an important property. We consider the quantity defined similar to standard definition of current density, $\bar{j}^\alpha(x, \epsilon) \equiv \lim_{x \rightarrow x'} (\nabla'^\alpha - \nabla^\alpha) \bar{G}(x, x'; \epsilon) / m$. By virtue of Eq.(12) this quantity conserves so that

$$\partial \bar{j}^\alpha(x, \epsilon) / \partial x^\alpha = 0 \quad (16)$$

This relation looks like the conservation law of particle current at a given energy. However, this relation contains more information since it is a conservation law for a 2×2 *matrix* current.

Next, we construct a theory which makes use of this conservation law. We concentrate on the semiclassical Green function in coinciding points, $\bar{G}(x, \epsilon) \equiv i\bar{G}(x, x'; \epsilon) / \pi\nu$, where ν is a density of states at Fermi energy. So defined Green function has been introduced in several semiclassical theories. [25, 26, 27] It satisfies the normalization condition $\bar{G}^2 = \bar{1}$. We relate the "current density" \bar{j} to gradients and/or changes of $\bar{G}(x)$, very much like the electric current density is related to the voltage in circuit theory of electric conductance. Following the approach of the circuit theory [19], we separate a mesoscopic layout into elements: nodes and connectors, so that the $\bar{G}(x)$ is constant across the nodes and drops across the connectors. One may associate a graph with each circuit, so that its lines (i, j) would denote the connectors, and internal and external vertices correspond to the nodes and terminals, respectively. (See Fig. 3) This separation of actual layout is rather heuristic, similar to separation of an electric conductor of a complicated geometry onto nodes and circuit theory elements. The bigger the number and the finer the mesh of the nodes and connectors, the better the circuit theory approximates the actual layout. The idea for this

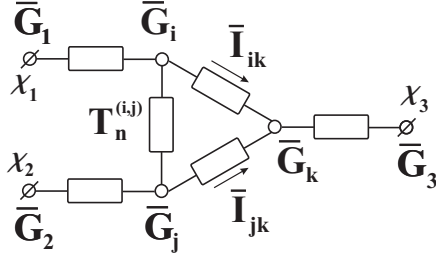

Figure 3. The graph of the circuit theory, associated with a 3 terminal mesoscopic system. $\bar{G}_1, \bar{G}_2, \bar{G}_3$ in the terminal are fixed by the boundary condition (15). T_n^{ij} define the transport properties of a connector. \bar{I}_{ik} and \bar{I}_{jk} denote the currents, flowing from the nodes i and j into the node k . χ_1, χ_2, χ_3 are counting fields in the terminals.

separation is completely analogous to the one considered in the section 2. The nodes are similar to the terminals, the difference is that \bar{G} is fixed in the terminals and yet to be determined in the nodes. The \bar{G} in nodes are determined from Kirchoff rules reflecting the conservation law (16): sum of the matrix currents from the node over all connectors should equal zero at each energy. For this, we should be able to express the matrix current via each connector as a function of two matrices $\bar{G}_{i,j}$ at its ends.

To accomplish this task, consider the connector (i, j) , linking to nodes i and j . It can be quite generally characterized by a set of transmission eigenvalues $T_n^{(ij)}$ [19, 27]. The problem to solve is to express matrix current \bar{I}_{ij} via the connector in terms of $\bar{G}_{i(j)}$. This problem shall be addressed by a more microscopic approach and was solved in [27] for Keldysh-Nambu matrix structure of \bar{G} . It is a good news that the derivation made in [27] does not depend on concrete matrix structure and can be used for the present problem without any modification yielding

$$\bar{I}_{ij} = \frac{1}{2\pi} \sum_n \int dE \frac{T_n^{(ij)} [\bar{G}_i, \bar{G}_j]}{4 + T_n^{(ij)} (\{\bar{G}_i, \bar{G}_j\} - 2)}. \quad (17)$$

Each connector (i, j) in the layout contributes to the total χ_i -dependent action (14). The corresponding S_{ij} contribution to the action should be found from the relation (14) and reads:[20]

$$S_{ij}(\chi) = \frac{-t_0}{2\pi} \sum_n \int dE \text{Tr} \ln \left[1 + \frac{1}{4} T_n^{(ij)} (\{\bar{G}_i, \bar{G}_j\} - 2) \right]. \quad (18)$$

Now we are ready to present a set of circuit theory rules that enables us to evaluate the FCS for an arbitrary mesoscopic layout.

- (i) The layout is separated onto terminals, nodes, and connectors.

(ii) The \bar{G}_j in each terminal j is fixed by relation (15) thus incorporating information about voltage, temperature and counting field χ in each node.

(iii) For each node k , the matrix current conservation yields a Kirchoff equation $\sum_i \bar{I}_{ik} = 0$, where the summation is going over all connectors (i, k) attached to node k , and \bar{I}_{ik} are expressed with (17) in terms of $\bar{G}_{i(k)}$.

(iv) The solution of resulting equations with condition $\bar{G}_k^2 = 1$ fixes \bar{G}_k in each node.

(v) The total action $S(\chi)$ is obtained by summing up the contributions $S_{ij}(\{\chi_i\})$ of individual connectors, those are given by (18): $S(\{\chi_i\}) = \sum_{(i,j)} S_{ij}(\{\chi_i\})$

(vi) The statistics of electron transfer is obtained from the relation (2).

In the end of this subsection we discuss the limits of applicability of the whole scheme. By virtue of semiclassical approach, the mesoscopic fluctuations coming from interference of electrons penetrating different connectors are disregarded. So that, we assume that conductivities of all connectors are much bigger than conductance quantum $e^2/\pi\hbar$. The same condition provides the absence of Coulomb blockade effects in the system. Besides, we have disregarded the possible processes of *inelastic relaxation* in the system. The latter can be eventually taken into account, since the use of Keldysh Green functions technique allows for perturbation treatment of interaction and relaxation. However, it would considerably complicate the scheme. The point is that the inelastic scattering would mix up the $\bar{G}(\varepsilon)$ at different energies, so that one can not solve the circuit theory equations separately at each energy.

3.2. THE STATISTICS OF CHARGE TRANSFER IN CHAOTIC QUANTUM DOTS

As an illustration of the above scheme, we will consider in the second part of this section the FCS of the 3-terminal chaotic quantum dot. The system is sketched in the inset of Fig. 2. The heuristic circuit, associated with this mesoscopic system is shown by dashed lines. It includes only 3 terminals, 3 arbitrary connectors, associated with the contacts, and the node $\{4\}$, representing the quantum dot itself. This separation is valid provided the cavity is in the *quantum* chaotic regime. (See [28] for definition). This regime corresponds to full isotropization of the Green function $\check{G}(x, x', \varepsilon)$ within the dot, so that $\bar{G}_4(\varepsilon)$ can be regarded as a constant at a given energy.

Since the normalization $\bar{G}_k^2 = 1$ holds for each vertex, we use the parametrization $\bar{G}_k = \mathbf{g}_k \cdot \boldsymbol{\tau}$, $\mathbf{g}_k \cdot \mathbf{g}_k = 1$. Here \mathbf{g}_k is a 3-D vector, and $\boldsymbol{\tau} = (\bar{\tau}_1, \bar{\tau}_2, \bar{\tau}_3)$. With the use of this parametrization the anticommutator $\{\bar{G}_i, \bar{G}_k\}$ is proportional to the unity matrix and takes the form of scalar product $\frac{1}{2}\{\bar{G}_i, \bar{G}_k\} = \mathbf{g}_i \cdot \mathbf{g}_k$. In the absence of counting fields the Green

functions in the terminals corresponds to the equilibrium Keldysh Green function [25]

$$\bar{G}_k^{(0)} = \begin{pmatrix} 1 - 2f_k & -2f_k \\ -2(1 - f_k) & 2f_k - 1 \end{pmatrix}, \quad (19)$$

where Fermi distribution function $f_k(E) = \{\exp[(E - eV_k)/T_k] + 1\}^{-1}$ accounts for the bias voltages V_k and the temperatures T_k in the terminals. The χ_i -dependence of $\bar{G}_k(\chi)$ is then given by Eq. (15).

We see that Green function $\bar{G}_4(\chi) = \mathbf{g}_4 \cdot \boldsymbol{\tau}$ in the dot is in fact the only function to find. For that, we proceed by applying the current conservation law, $\sum_{k=1}^3 \bar{I}_{k,4} = 0$, inside the dot. We present the currents $\bar{I}_{k,4}$ given by (17) in the form

$$\bar{I}_{k,4} = \frac{1}{2} Z_k(\mathbf{g}_k \cdot \mathbf{g}_4) [\bar{G}_k, \bar{G}_4], \quad (20)$$

where the scalar function $Z_k(x)$ incorporates the information about transmission eigenvalues in each connector k :

$$Z_k(x) \equiv \sum_n T_n^{(k,4)} / [2 + T_n^{(k,4)}(x - 1)]. \quad (21)$$

It can be evaluated for any particular distribution $\rho(T)$ of transmission eigenvalues in the given connector and completely defines its scattering properties. For a example, if we denote by $R_Q = \pi\hbar/e^2$ the resistance quantum, then $R_k^{-1} = 2R_Q^{-1}Z_k(1)$ is an inverse resistance of the connector. One can also express the Fano factor $F_k = \langle T(1 - T) \rangle / \langle T \rangle$, associated with the given connector as $F = 1 - 2(d/dx)\log Z_k(x)|_{x=1}$.

With the use of $Z_k(x)$ the conservation law can be efficiently rewritten as $[\sum_{k=1}^3 p^k \bar{G}_k, \bar{G}_4] = 0$, where $p^k = Z_k(\mathbf{g}_k \cdot \mathbf{g}_4)$. This relation suggests to

look for the vector \mathbf{g}_4 in the form $\mathbf{g}_4 = M^{-1} \sum_{k=1}^3 p^k \mathbf{g}_k$, with $M(\chi)$ being an unknown normalization constant. Using the normalization condition $\mathbf{g}_4 \cdot \mathbf{g}_4 = 1$ we obtain the following set of equations

$$p^i = Z_i \left(M^{-1} \sum_{j=1}^3 g_{ij}(\chi) p^j \right), \quad M^2 = \sum_{i,j=1}^3 g_{ij}(\chi) p^i p^j \quad (22)$$

where the scalar product $g_{ij}(\chi) = \mathbf{g}_i(\chi) \cdot \mathbf{g}_j(\chi)$ between terminal Green function is expressed in terms of Fermi distributions as follows

$$g_{ij}(\chi) = (1 - 2f_i)(1 - 2f_j) + 2e^{i(\chi_i - \chi_j)} f_i(1 - f_j) + 2e^{-i(\chi_i - \chi_j)} f_j(1 - f_i)$$

The Green function \bar{G}_4 then is found from the solution $\{p^i(\chi), M(\chi)\}$ of this set of equations. In the general situation the function $Z_k(x)$ takes the

form (21) and therefore Eq. (22) represents the set of non-linear equations. However, their solution can be relatively easy found numerically using the method of subsequent iterations.

The total action can be found by applying the rule (v) of circuit theory and reads

$$S(\chi) = \frac{t_0}{\pi} \sum_{i=1}^3 \int d\epsilon S_i(\mathbf{g}_i \cdot \mathbf{g}_4) \quad (23)$$

where

$$\mathbf{g}_i \cdot \mathbf{g}_4 = M^{-1}(\chi) \sum_{j=1}^3 g_{ij}(\chi) p^j(\chi) \quad (24)$$

Here partial contributions $S_k(x)$ from each connector in Eq. (23) has to be determined from the relation $\frac{\partial}{\partial x} S_k(x) = -Z_k(x)$, provided $S_k(1) = 0$. It follows from the Eqs. (14), (20) and normalization condition $\mathbf{g}_4 \cdot \mathbf{g}_4 = 1$.

We consider three particular types of connectors: tunnel(T), ballistic(B) and diffusive(D). Their corresponding contributions to action read as [18]:

$$S_T(x) = -\frac{1}{2}(R_0/R)(x-1), \quad (25)$$

$$S_B(x) = -(R_0/R) \log[(1+x)/2], \quad (26)$$

$$S_D(x) = -\frac{1}{4}(R_0/R) \log^2(x + \sqrt{x^2 - 1}) \quad (27)$$

with R being a resistance of the connector. The tunnel connector represents the tunnel junction, so that $T_n \ll 1$ for all n . Ballistic connector corresponds to the quantum point contact, with N open channels. The last expression comes from universal transmission distribution $\rho(T) = R_0/2RT\sqrt{1-T}$ for any diffusive contact.

Analytical results for FCS (23) can be readily obtained only for the system with tunnel connectors. To assess general situation we found \mathbf{g}_4 for given χ_i numerically. To find the probability distribution, we evaluated the integral (2) in the saddle point approximation, assuming χ_i has to be complex numbers. Saddle point approximation is always valid in the low frequency limit we consider, since in this case both action S and number of transmitted particles $N_i = I_i t_0/e \gg 1$. Due to the current conservation law only two of three counting fields χ_i are independent, and one can set $\chi_3 = 0$. The relevant saddle point of the function $\Omega(\chi) = S(\chi) + i\chi_1 I_1 t_0/e + i\chi_2 I_2 t_0/e$ always corresponds to purely imaginary numbers $\{\chi_1^*, \chi_2^*\}$. The probability reads $P(I_1, I_2) \approx \exp[-\Omega(\chi^*)]$. Evidently, $\Omega(\chi^*)$ is the Legendre transform of the action, and it can be regarded as implicit function on $I(\chi^*)$.

In the following we assume the shot noise regime $eV \gg kT$ when the thermal fluctuations can be disregarded. The energy integration in (23) becomes trivial, since $f_i(\epsilon) = 0$ or 1 , and it is sufficient to consider only the

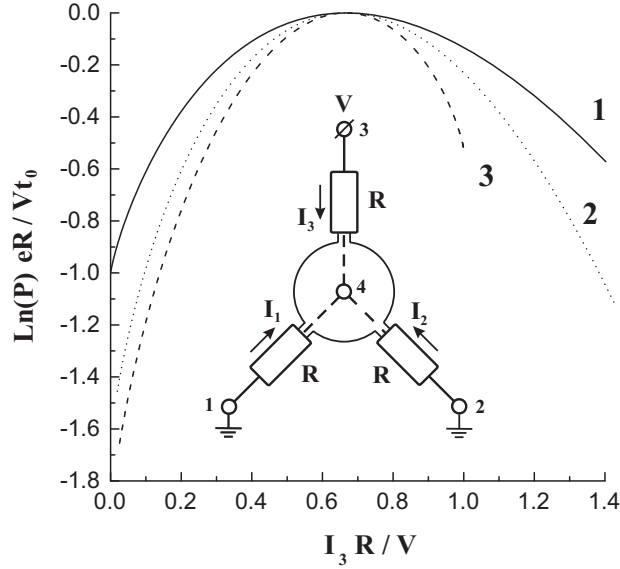

Figure 4. The logarithm of the current probabilities in the 3-terminal chaotic quantum dot as a function of I_3 , under condition $I_1 = I_2$. The insert presents the system configuration. The resistances R of all connectors are assumed to be equal. 1 - tunnel connectors, 2 - diffusive connectors, 3 - ballistic connectors.

case $V_1 = V_2 = 0$, $V_3 = V$. Any other possible setup can be reduced to the number of previous ones by appropriate subdividing a relevant energy strip. The results of these calculations are shown in Fig. 4 and 5. We see that the maximum of probability occurs at $I_1 = I_2 = -V/3R$, $I_3 = 2V/3R$. This simply reflects the usual Kirchoff rules. The current distribution $P(I_1, I_2)$ for a ballistic system is bounded. This stems from the fact, that each ballistic contact has a limited number N of open channels. Therefore any plausible current fluctuation in the given terminal may not exceed the threshold value of a current $I_s = NV/R_Q$ via the ballistic connector. Contrary to that, for the tunnel and diffusive type configurations any connector has an infinite number of partially open transmission channels. Therefore the range of current fluctuations is not bounded in this case.

From Fig. 4 and 5 it follows that the relative probabilities of big current fluctuations increase in the sequence ballistic \rightarrow diffusive \rightarrow tunnel. To reveal the origin of this behavior we proceed by considering the shot-noise cross-correlations P_{ij} , defined by Exp. (5). At zero frequency they can be found analytically via the relation $P_{ij} = -\frac{e^2}{t_0} \frac{\partial^2}{\partial \chi_i \partial \chi_j} S \Big|_{\chi=0}$. Taking into account, that the action $S(\{\chi_i\})$, regarded as function of χ_i , is implicitly determined

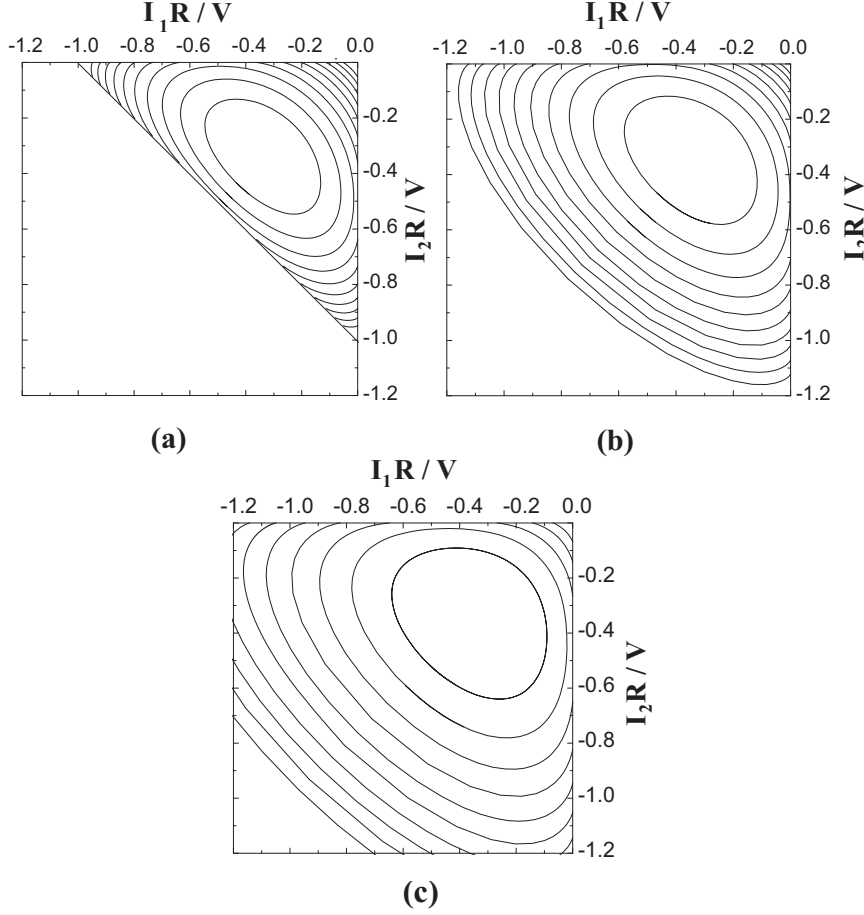

Figure 5. The contour maps of the current distribution $\log[P(I_1, I_2)]$ in the 3-terminal chaotic quantum dot for different configurations of connectors. (a) - ballistic connectors, (b) - diffusive connectors, (c) - tunnel connectors.

by Eq. (23) via the set of equations (22), we arrive to the following result

$$P_{ij} = -G_{ij}(T + \Theta_4) + R^{-1}\alpha_i\alpha_j(\bar{\Theta} - \Theta_i - \Theta_j) + \delta_{ij}R^{-1}\alpha_i\Theta_i \quad (28)$$

Here $\alpha_i = R/R_i$, $R^{-1} = \sum_i R_i^{-1}$,

$$G_{ij} = R^{-1}(\alpha_i\alpha_j - \delta_{ij}\alpha_i) \quad (29)$$

is a conductance matrix of the dot,

$$\Theta_4 = \int d\varepsilon \bar{f}(1 - \bar{f}), \quad \Theta_k = F_k \int d\varepsilon (f_k - \bar{f})^2, \quad \bar{\Theta} = \sum_{i=1}^3 \alpha_i \Theta_i \quad (30)$$

F_k is a Fano factor of the k -th connector and $\bar{f}(\varepsilon) = \sum_{i=1}^3 \alpha_i f_i(\varepsilon)$ is the non-equilibrium distribution function within the dot.

In case of ballistic contacts $F_k = 0$ and the first two terms of the result (28) reproduce the expression for the noise power obtained with the use of "minimal correlation" approach[21]. At zero temperature it also coincides with the result of random matrix theory [29], as we expected from the our consideration of scattering approach. At equilibrium $P_{ij} = -2TG_{ij}$ in accordance with the fluctuation-dissipation theorem. In the general situation each non-ideal connector with $F_k \neq 0$ gives the additive contribution to the cross-correlation function, which is linear in F_k . Thus we conclude that the current-current correlations in the chaotic quantum dot result from two contributions. The first one, proportional to $(T + \Theta_4)$, corresponds to the cross-correlation function P_{ij}^b of the chaotic cavity with ideal ballistic point contacts, which stems from the fluctuation of the distribution function \bar{f} within the dot. The second contribution, proportional to Θ_i , reflects the noise due to connectors.

To present the result for the cross-correlations it is also useful to introduce the (3×3) matrix F with elements $F_{ij} = P_{ij}/eI_\Sigma$, where $I_\Sigma = \sum_{i=1}^3 |I_i|$. The matrix F is a generalization of the Fano factor for the multi-terminal system. It is symmetric and obeys the relation $\sum_{i=1}^3 F_{ik} = 0$, which follows from the current conservation law. At zero temperature for the symmetric setup, shown in Fig. 4, it reads as

$$F = \frac{1}{36} \begin{pmatrix} 4 + 3F & -2 & -(2 + 3F) \\ -2 & 4 + 3F & -(2 + 3F) \\ -(2 + 3F) & -(2 + 3F) & 4 + 6F \end{pmatrix} \quad (31)$$

For a diffusive wire $F_D = 1/3$ and for a tunnel junction $F_T = 1$. Therefore at fixed average currents through connectors the Gaussian's currents fluctuations will increase in the sequence ballistic \rightarrow diffusive \rightarrow tunnel. As it was mention before similar behavior is also traced in the regime of the big current fluctuations. The essential point here is that the cross-correlations always persist regardless the concrete construction of the connectors.

4. FCS of Charge Transfer in Coulomb Blockade Systems

In the preceding sections we have considered the FCS of non-interacting electrons. It was assumed that the conductance G of the system is much greater than the quantum conductance $G_Q = e^2/\hbar$. It is known, that under opposite condition, $G \leq G_Q$, the effects of Coulomb blockade become important. This motivates us to study the statistics of charge transfer in the mesoscopic systems, placed in the limit of strong Coulomb interaction, $G \ll G_Q$. The electrons dynamics in this Coulomb blockade limit is fortu-

nately relatively simple, since the evolution of the system is governed by a master equation. The charge transfer is thus a classical stochastic process rather than the quantum mechanical one. Nevertheless the FCS is by no means trivial. In this section we elaborate the general approach to FCS in the systems, governed by master equation.

We begin this section by presenting the general model, which dynamics obeys the master equation. Further on we proceed with the proof of the central result of this section for the FCS in the master equation approach. We illustrate the general scheme by considering the statistics of charge transfer through the Coulomb blockade island with 3 leads attached and compare the FCS in this case with the results of the preceding section, i.e. for non-interacting electrons.

4.1. THE GENERAL MODEL

The dynamics of various systems can be described by master equation. For our purposes it is convenient to write it in the matrix form:

$$\frac{\partial}{\partial t}|p(t)\rangle = -\hat{L}|p(t)\rangle \quad (32)$$

where each element $p_n(t)$ of the vector $|p(t)\rangle$ is the probability to find the system in the state n . The matrix elements of operator \hat{L} are given by

$$L_{mn} = \delta_{nm}\gamma_n - \Gamma_{m\leftarrow n}, \quad \gamma_n = \sum_{m \neq n} \Gamma_{m\leftarrow n} \quad (33)$$

Here $\Gamma_{n\leftarrow m}$ stands for the transition rate from the state m to the state n , γ_n presents the total transition rate from the state n . The \hat{L} operator thus defined always has a zero eigenvalue, the corresponding eigenvector being the stationary solution of the master equation.

Coulomb blockade mesoscopic systems always obey Eq. (32). The main advantage of the master equation approach is a possibility of non-perturbative treatment of the interaction effects. Below we first consider the master equation description of the general model system. This will prepare us to the next section where we derive the FCS method.

The possible physical realization of the general model includes an array of Coulomb blockade quantum dots and a mesoscopic system with a number of resonant levels. Like in the preceding sections, it is convenient schematically to present the system as a graph (see Fig. 6) with each node α corresponding either to a single dot, a single resonant level or an external terminal. The line $k = (\alpha, \beta)$, connecting the nodes α and β , is associated with a possible electron transfer. Let M be the total number of nodes in this graph and L is a total number of lines. For a many-dot systems each line k

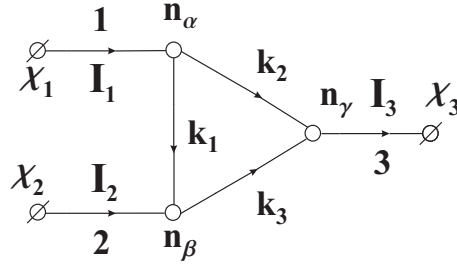

Figure 6. The graph of the general model (See the main text). The terminals are connected with the system via external junctions 1,2 and 3. The nodes α , β and γ are either resonant levels or dots, linked with each other by internal junctions k 's. The arrows denote the conventional direction of a current through each junction.

corresponds to the tunnel junction. For systems with many resonant levels it corresponds to the possible transition between different levels, so that it does not necessary correspond to electron transfer in space. There are N external junction $k = 1 \dots N$, ($N \leq L$), connecting the terminals with the system. The currents through these junctions are directly measurable and hence are of our interest.

The macro- or microscopic state of the general model is given by a set of occupation numbers $|n\rangle = |n_1, \dots, n_M\rangle$; n_α is equal to any integer for the array of quantum dots and refers to the excess charge on the island α ; in case of many resonant level n_α denotes the occupation number of a given level. Owing to the fact that $\sum_n L_{nm} = 0$, the \hat{L} operator has a zero eigenvalue. There are the right, $|p_0\rangle$, and the left, $\langle q_0|$, eigenvectors corresponding to this zero eigenvalue

$$\hat{L}|p_0\rangle = 0, \quad \langle q_0|\hat{L} = 0 \quad (34)$$

We assume that they are unique. This means that the system does not get stuck in any metastable state. The vector $|p_0\rangle$ gives the steady probability distribution and $\langle q_0| = (1, 1, \dots, 1)$.

It is also useful to present \hat{L} operator in the form

$$\hat{L} = \hat{\gamma} - \hat{\Gamma}, \quad \hat{\Gamma} = \sum_{k=1}^L (\hat{\Gamma}_k^{(+)} + \hat{\Gamma}_k^{(-)}) \quad (35)$$

where $\hat{\gamma}$ is the diagonal operator in the basis $|n\rangle$ of the system configuration and $\hat{\Gamma}_k^{(\pm)}$ is associated with the electron transfers through the line $k = (\alpha, \beta)$:

$$\hat{\gamma} = \sum_{\{n\}} |n\rangle \gamma(n) \langle n|, \quad \hat{\Gamma}_k^{(\pm)} = \sum_{\{n\}} |n'\rangle \Gamma_k^{(\pm)}(n) \langle n| \quad (36)$$

The state $|n'\rangle = |n_1, \dots, n'_\alpha, \dots, n'_\beta, \dots, n_M\rangle$ results from the state $|n\rangle$ by appropriate changing the corresponding occupation numbers: $n'_\alpha = n_\alpha - \sigma_k$, $n'_\beta = n_\beta + \sigma_k$, where $\sigma_k = \pm 1$ denotes the direction of the transition.

4.2. THE FCS IN THE MASTER EQUATION

In this section we derive the central result for the FCS of the charge transfer in the system, which dynamics obeys the master equation. We will solve this problem by making use of the property of the system, that its random evolution in time is the Markov stochastic process.

In what follows we will partially use notations of the book [31]. Let us consider the time interval $[-T/2, T/2]$. Suppose the system undergoes s transitions at random time moments τ_i , so that

$$+T/2 > \tau_1 > \tau_2 > \dots > \tau_{s-1} > \tau_s > -T/2 \quad (37)$$

This gives an elementary random sample $\zeta_s = (\tau_1, k_1, \sigma_1; \dots; \tau_s, k_s, \sigma_s)$. It corresponds to the set of subsequent events, when at time τ_i the tunneling happens via the junction k_i , $\sigma_i = \pm 1$ being the direction of the transition. The samples ζ_s constitute the set Ω of all possible random samples.

Then one defines the measure (or the probability) $d\mu(\zeta)$ at the set Ω . For this purpose we may very generally introduce the sequence of non-negative probabilities $Q_s(\{\tau_i, k_i, \sigma_i\}) \equiv Q(\tau_1, k_1, \sigma_1; \dots; \tau_s, k_s, \sigma_s) \geq 0$ defined in Ω so that

$$d\mu(\zeta) = Q_0 + \sum_{s=1}^{+\infty} \sum_{\{k_i, \sigma_i\}} Q_s(\{\tau_i, k_i, \sigma_i\}) d\tau_1 \dots d\tau_s \quad (38)$$

The functions Q are normalized according to the condition

$$\int_{\Omega} d\mu(\zeta) \equiv Q_0 + \sum_{s=1}^{+\infty} \sum_{\{k_i, \sigma_i\}} \int_{T/2 > \tau_1 > \dots > \tau_s > -T/2} \dots \int Q_s(\{\tau_i, k_i, \sigma_i\}) \prod_{i=1}^s d\tau_i = 1 \quad (39)$$

Each term in Exp. (38) corresponds to the probability of an elementary sample ζ_s .

To accomplish the preliminaries, we remind the concept of a stochastic process. Mathematically speaking, it can be any integrable function $\check{A}(t) \equiv A(t, \zeta)$ defined at the set Ω and parametrically depending on time. It is sometimes convenient to omit the explicit ζ dependence. We will use a "check" in this case to stress that the quantity in question is a random variable. Each stochastic process $A(t, \zeta)$ generates the sequence of time dependent functions $\{A_0(t), A_1(t, \tau_1, k_1, \sigma_1), \dots, A_s(t, \{\tau_i, k_i, \sigma_i\})\}$. Its average

$\langle \check{A}(t) \rangle_\Omega$ over the space Ω is defined as

$$\begin{aligned} \langle \check{A}(t) \rangle_\Omega &= \int_\Omega A(t, \zeta) d\mu(\zeta) \equiv A_0(t) Q_0 + \sum_{s=1}^{+\infty} \sum_{\{k_i, \sigma_i\}} \quad (40) \\ &\int_{T/2 > \tau_1 > \dots > \tau_s > -T/2} \cdots \int A_s(t, \{\tau_i, k_i, \sigma_i\}) Q_s(\{\tau_i, k_i, \sigma_i\}) \prod_{i=1}^s d\tau_i \end{aligned}$$

The analogous expression should be used, for instance, to define the correlations $\langle \check{A}(t_1) \check{B}(t_2) \rangle_\Omega$ between any two stochastic processes.

For the subsequent analysis we define the random process $\check{I}^{(k)}(t)$, corresponding to the classical current through the external junction $k \leq N$:

$$I^{(k)}(t, \zeta_s) = \sum_{i=1}^s e \sigma_i \delta(t - \tau_i) \delta(k - k_i) \quad (41)$$

Here σ_m is included to take into account the direction of the jump and $\delta(k - k_i) \equiv \delta_{k, k_i}$ is the Kronecker δ symbol. Given this definition at hand, we introduce the generating functional $S[\{\chi_i(t)\}]$ depending on N counting fields $\chi_i(\tau)$, each of them associated with a given terminal i :

$$\exp(-S[\{\chi_i(t)\}]) = \left\langle \exp \left\{ i \sum_{n=1}^N \int_{-\infty}^{+\infty} d\tau \chi_n(\tau) \check{I}^{(n)}(\tau) / e \right\} \right\rangle_\Omega \quad (42)$$

with the average defined by Eq.(40). Let us note the remarkable similarity of this classical expression with the quantum mechanical action (13). As before, in the low-frequency limit of current correlations one may use the time-independent counting fields χ_i . In this case the action $S[\{\chi_i\}]$ can be used to find the probability (2) of N_i electrons to be transferred through the terminal i during the time interval T .

The above definitions were rather general than constructive, since the probabilities Q have not been specified so far. To proceed, one has to relate them to transition rates of the master equation. We assume that at initial time $t = -T/2$ the system was in the state $\{n^{(s)}\}$. Then random sample ζ_s determines the evolution of charge configuration $\{n^{(s)}\} \rightarrow \{n^{(s-1)}\} \dots \{n^{(1)}\} \rightarrow \{n^{(0)}\}$ for subsequent moments of time. The choice of ζ_s specifies that the transition between neighboring charge states $\{n^{(i)}\}$ and $\{n^{(i-1)}\}$ occurs at time τ_i via the junction $k_i = (\alpha_i, \beta_i)$. Therefore the sequence $\{n^{(i)}\}$ is given by the relation $n_{\alpha_i}^{(i-1)} = n_{\alpha_i}^{(i)} - \sigma_{k_i}$, $n_{\beta_i}^{(i-1)} = n_{\beta_i}^{(i)} + \sigma_{k_i}$, and $n_\gamma^{(i-1)} = n_\gamma^{(i)}$ for all $\gamma \neq \alpha_i$ and β_i . To determine the probability

$Q_s(\{\tau_i, k_i, \sigma_i\})$ we note that (i) the sample ζ_s constitutes the Markov chain (ii) the conditional probability of the system to remain at state $n^{(i)}$ between the times τ_{i+1} and τ_i is proportional to $\exp[-\gamma(n^{(i)})(\tau_i - \tau_{i+1})]$; (iii) the probability that the transition occurs via the junction k_i during the time interval $d\tau_i$ at the moment τ_i is given by $\Gamma_{k_i}^{(\sigma_i)}(n^{(i)})d\tau_i$. These arguments suggest that Q 's have the form

$$\begin{aligned} Q_0 &= Z_0^{-1} \exp[-\gamma(n^{(s)})T] \\ Q_s(\{\tau_i, k_i, \sigma_i\}) &= Z_0^{-1} \exp[-\gamma(n^{(0)})(T/2 - \tau_1)] \Gamma_{k_1}^{(\sigma_1)}(n^{(1)}) \\ &\quad \exp[-\gamma(n^{(1)})(\tau_1 - \tau_2)] \Gamma_{k_2}^{(\sigma_2)}(n^{(2)}) \dots \exp[-\gamma(n^{(s-1)}) \\ &\quad (\tau_{s-1} - \tau_s)] \Gamma_{k_s}^{(\sigma_s)}(n^{(s)}) \exp[-\gamma(n^{(s)})(\tau_s + T/2)] \end{aligned} \quad (43)$$

where the constant Z_0 should be found from the normalization condition (39). As we will see below, $Z_0 = 1$.

The above correspondence between the random Markov chain ζ_s and the probabilities Q 's (43) allows one to evaluate the generating function (42). By definition (41) for any given ζ_s we have

$$\exp\left\{i \sum_{n=1}^N \int_{-\infty}^{+\infty} d\tau \chi_n(\tau) I^{(n)}(\tau, \zeta_s) / e\right\} = \prod_{i=1}^s \exp\{i\sigma_i \chi_{k_i}(\tau_i)\}$$

It is assumed here that $\chi_{k_i} = 0$ if the transition occurs via internal junction, $k_i > N$, thus no physically measurable current is generated in this case. The averaging of the latter expression over all possible configurations Ω with the weight $d\mu(\zeta)$ yields

$$\begin{aligned} Z[\{\chi_i(\tau)\}] &\equiv \exp(-S[\{\chi_i(\tau)\}]) = Q_0 + \\ &\sum_{s=1}^{+\infty} \sum_{\{k_i, \sigma_i\}} \int_{T/2 > \tau_1 > \dots > \tau_s > -T/2} \dots \int Q_s^\chi(\{\tau_i, k_i, \sigma_i\}) \prod_{i=1}^s d\tau_i \end{aligned} \quad (44)$$

The resulting expression resembles the normalization condition (39). Here the χ -dependent functions $Q_s^\chi(\{\tau_i, k_i, \sigma_i\})$ are defined similar to probabilities (43) with the only crucial difference that the rates $\Gamma_k^{(\sigma)}(n)$ should be replaced by $\Gamma_k^{(\sigma)}(n) \exp\{i\sigma_k \chi_k(\tau_k)\}$ if $k \leq N$.

The expression (44) can be written in the more compact and elegant way. For that, we introduce the χ -dependent linear operator \hat{L}_χ defined as

$$\begin{aligned} \hat{L}_\chi(\tau) &= \hat{\gamma} - \hat{\Gamma}_\chi(\tau), \\ \hat{\Gamma}_\chi(\tau) &= \sum_{k=1}^N (\hat{\Gamma}_k^{(+)} e^{i\chi_k(\tau)} + \hat{\Gamma}_k^{(-)} e^{-i\chi_k(\tau)}) + \sum_{k=N+1}^L (\hat{\Gamma}_k^{(+)} + \hat{\Gamma}_k^{(-)}) \end{aligned} \quad (45)$$

In line with consideration above we multiplied each operator $\hat{\Gamma}_k^{(\pm)}$ ($k = 1 \dots N$), that corresponds to the transition through the external junction, by an extra χ -dependent factor $e^{i\chi k(\tau)}$. The diagonal part and internal transition operators $\hat{\Gamma}_k^{(\pm)}$ with $k > N$ remained unchanged. Then we consider the evolution operator $\hat{U}_\chi(t_1, t_2)$ associated with (45). Since $\hat{L}_\chi(\tau)$ is in general time-dependent, $\hat{U}_\chi(t_1, t_2)$ is given by the time-ordered exponent

$$\hat{U}_\chi(t_1, t_2) = T_\tau \exp \left\{ - \int_{t_2}^{t_1} (\hat{\gamma}(\tau) - \hat{\Gamma}_\chi(\tau)) d\tau \right\} \quad (46)$$

The similar construction is widely used in quantum statistics. The difference in the present case is that the operator $\hat{U}_\chi(t_1, t_2)$ at $\chi = 0$ gives the evolution of probability rather than the amplitude of probability.

With the use of evolution operator (46) the generating function (44) can be cast into the form

$$Z[\{\chi_i(\tau)\}] = \langle q_0 | \hat{U}_\chi(T/2, -T/2) | n_s \rangle \quad (47)$$

To prove it we argue as follows. We exploit the fact that $\hat{\gamma}(\tau)$ and $\hat{\Gamma}(\tau)$ commute under the sign of time-ordering in Eq. (46) and regard $\hat{\Gamma}(\tau)$ as a perturbation. This gives the matrix element $\langle q_0 | \hat{U}_\chi(T/2, -T/2) | n_s \rangle$ in the form of series

$$\begin{aligned} \langle q_0 | \hat{U}_\chi(T/2, -T/2) | n_s \rangle &= \langle q_0 | e^{-\hat{\gamma}T} | p_0 \rangle + \\ &\sum_{s=1}^{+\infty} \langle q_0 | T_\tau \exp \left\{ - \int_{-T/2}^{T/2} \hat{\gamma}(\tau) d\tau \right\} \sum_{\mathbf{k}_s \boldsymbol{\sigma}_s} \int_{T/2 > \tau_1 > \dots > \tau_s > -T/2} \dots \int \\ &\hat{\Gamma}_{k_1}^{(\sigma_1)}(\tau_1) e^{i\sigma_1 \chi_{k_1}(\tau_{k_1})} \dots \hat{\Gamma}_{k_s}^{(\sigma_s)}(\tau_s) e^{i\sigma_s \chi_{k_s}(\tau_{k_s})} | p_0 \rangle \prod_{i=1}^s d\tau_i \end{aligned} \quad (48)$$

It follows from the definition (43) that each term in this series corresponds to the function $Q_s^X(\{\tau_i, k_i, \sigma_i\})$, namely

$$\begin{aligned} Q_0 &= \langle q_0 | e^{-\gamma T} | n_s \rangle \\ Q_s^X(\{\tau_i, k_i, \sigma_i\}) &= \langle q_0 | T_\tau \exp \left\{ - \int_{-T/2}^{T/2} \hat{\gamma}(\tau) d\tau \right\} \\ &\hat{\Gamma}_{k_1}^{(\sigma_1)}(\tau_1) e^{i\sigma_1 \chi_{k_1}(\tau_{k_1})} \dots \hat{\Gamma}_{k_s}^{(\sigma_s)}(\tau_s) e^{i\sigma_s \chi_{k_s}(\tau_{k_s})} | n_s \rangle \end{aligned} \quad (49)$$

Therefore Exp. (48) and (47) are reduced to the previous result (44). This completes the proof. Note, that owing to the property (34), $Z_0 =$

$\langle q_0 | \exp(-T\hat{L}) | n_s \rangle = 1$ identically at $\chi = 0$. Therefore the probabilities (43) are correctly normalized.

The Exp. (47) for the generating function $Z[\{\chi_i(t)\}]$ depends on the initial state $|n_s\rangle$ of the system. It can be shown that the choice of $|n_s\rangle$ does not affect the final results. We assume that $\chi_k(t) \rightarrow 0$ when $t \rightarrow -T/2$. Physically, it means that the measurement is limited in time. To be specific one may assume that $\chi_k(t) = 0$ when $-T/2 < t < -T/2 + \Delta t$ and $\chi_k(t) \neq 0$ if $t > -T/2 + \Delta t$. If the time interval Δt is sufficiently large as compared with the typical transition time Γ^{-1} , then the system will reach the steady state during this period of time. The latter follows from the fact that $\exp(-\hat{L}\Delta t)|n_s\rangle \rightarrow |p_0\rangle$ when $\Delta t \gg \Gamma^{-1}$. Thus one can substitute $|n_s\rangle$ to $|p_0\rangle$ in Exp. (47). Assuming also the limit $T \rightarrow \infty$, we arrive to the main result of this section

$$\exp(-S[\{\chi_i(t)\}]) = \langle q_0 | T_\tau \exp\left\{-\int_{-\infty}^{+\infty} \hat{L}_\chi(\tau) d\tau\right\} | p_0 \rangle \quad (50)$$

We see that the generating function can be written in the form of the averaged evolution operator. This operator corresponds to master equation with the rates modified by the counting fields $\chi_i(\tau)$.

Further simplification is valid in the low frequency limit of the current correlations, $\omega \ll \Gamma$. (Here Γ is a typical transition rate in the system.) This allows to set $\chi_k(t) = \chi_k$ when $0 \leq t \leq t_0$ and $\chi_k(t) = 0$ otherwise, where t_0 is a time of measurement. The action (50) then reduces to the

$$S(\{\chi_i\}) = t_0 \Lambda_{\min}(\{\chi_i\}) \quad (51)$$

where $\Lambda_{\min}(\{\chi_i\})$ is the minimum eigenvalue of the operator \hat{L}_χ . Thus the problem of statistics in the Coulomb blockade regime, provided the transition rates in the system are known, is merely a problem of the linear algebra.

4.3. THE STATISTICS OF CHARGE TRANSFER IN COULOMB BLOCKADE ISLAND.

In this subsection we use the developed method to study the current statistics in the three-terminal Coulomb blockade island. Its equivalent circuit is shown in Fig. 7. This circuit is an extension of the usual set-up of a conventional single electron transistor [32].

The island is in the Coulomb blockade regime, $R_k \gg R_Q = 2\pi\hbar/e^2$. In order to observe the Coulomb blockade effect the condition $k_B T \ll E_c = e^2/2C_\Sigma$ should be also satisfied. Here E_c is the charging energy of the island and $C_\Sigma = \sum_{i=1}^3 C_k + C_g$. We assume the temperature to be rather high,

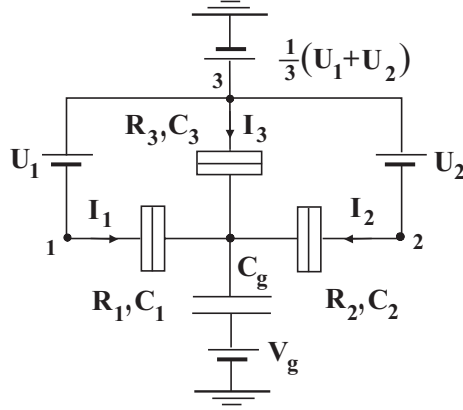

Figure 7. The equivalent circuit of the three-terminal Coulomb blockade island. The voltages $U_{1(2)}$ are used to control the bias between the 3d and the 1st (the 2nd) terminals: $U_{1(2)} = V_3 - V_{1(2)}$. The third terminal is biased at voltage $V_3 = (U_1 + U_2)/3$ with respect to the ground. This setup assures the condition $V_1 + V_2 + V_3 = 0$. Then gate voltage, V_g , can be used to control the offset charge $q_0 = C_g V_g$ on the island.

$k_B T \gg \Delta E$, with ΔE being the mean level spacing in the island, so that the discreteness of the energy spectrum in the island is not important. We also disregard the possible effects of co-tunneling.

Under the above conditions the 3-terminal island is described by the "orthodox" Coulomb blockade theory. In this theory the macroscopic state of Coulomb blockade island is uniquely determined by the excess charge $Q = ne$, which is quantized in terms of electron charge ($-e$). The charge Q can be changed only by $\pm e$ in course of one tunneling event. Therefore the master equation connects the given macroscopic state n with the neighboring states $n \pm 1$ only. The corresponding rates $\Gamma_{n\pm 1 \leftarrow n}$ of these transitions are equal to the sum of tunneling rates across all junctions: $\Gamma_{n\pm 1 \leftarrow n} = \sum_{k=1}^N \Gamma_{n\pm 1 \leftarrow n}^{(k)}$. The tunneling rate $\Gamma_{n\pm 1 \leftarrow n}^{(k)}$ across the junction k can be expressed via the electrostatic energy difference $\Delta E_{n\pm 1 \leftarrow n}^{(k)}$ between the initial (n) and final ($n \pm 1$) configurations

$$\Gamma_{n\pm 1 \leftarrow n}^{(k)} = \frac{1}{e^2 R_k} \frac{\Delta E_{n\pm 1 \leftarrow n}^{(k)}}{1 - \exp[-\Delta E_{n\pm 1 \leftarrow n}^{(k)}/k_B T]} \quad (52)$$

The evaluation of $\Delta E_{n\pm 1 \leftarrow n}^{(k)}$ can be done along the same lines as in the case of single electron transistor [32].

According to the general result (51) of the preceding subsection, one can find the FCS of the charge transfer through the island, by evaluating the minimum eigenvalue Λ_{\min} of the matrix \tilde{L}_χ . In case under consideration

this problem is reduced to the eigenvalue problem of the three-diagonal matrix:

$$(\Lambda - \gamma_n)p_n + \Gamma_{n \leftarrow n+1}^\chi p_{n+1} + \Gamma_{n \leftarrow n-1}^\chi p_{n-1} = 0 \quad (53)$$

where $\gamma_n = \Gamma_{n \leftarrow n-1} + \Gamma_{n \leftarrow n+1}$, and $\Gamma_{n \leftarrow n \pm 1}^\chi = \sum_{k=1}^N \Gamma_{n \pm 1 \leftarrow n}^{(k)} e^{\pm i\chi_k}$. The index $+$ ($-$) corresponds to electron transition from (to) the island.

To assess the FCS we have treated the related linear problem (53) numerically. We restrict the consideration to sufficiently low temperatures $k_B T \ll E_c$, so that the temperature dependence in rates (52) is non-essential. In this case $\Gamma_k^{(\pm)}(n) = \Delta E_{n \pm 1 \leftarrow n}^{(k)} / (e^2 R_k)$ when $\Delta E_{n \pm 1 \leftarrow n}^{(k)} \geq 0$ and $\Gamma_k^{(\pm)}(n) = 0$ otherwise. We have also assumed that $U_2 > U_1$ (See Fig. 7). The corresponding χ -dependent rates can be found from Exp. (52) and (45) and read as follows

$$\begin{aligned} \Gamma_{n+1 \leftarrow n}^\chi &= \Gamma_3^{(+)}(n) e^{i\chi_3} + \Gamma_1^{(+)}(n) \theta(q - 1/2 - n) e^{i\chi_1} \\ \Gamma_{n-1 \leftarrow n}^\chi &= \Gamma_2^{(-)}(n) e^{-i\chi_2} + \Gamma_1^{(-)}(n) \theta(n - q - 1/2) e^{-i\chi_1} \end{aligned} \quad (54)$$

where

$$\Gamma_k^{(\pm)}(n) = a_k^{(\pm)} \mp \left(n + \frac{C_g V_g}{e} \pm \frac{1}{2} \right) \frac{1}{R_k C_\Sigma} \quad (55)$$

and

$$\begin{aligned} a_3^{(+)} &= \frac{\tilde{C}_1 U_1 + \tilde{C}_2 U_2}{e R_3 C_\Sigma}, & a_2^{(-)} &= \frac{(\tilde{C}_1 + \tilde{C}_3) U_2 - \tilde{C}_1 U_1}{e R_2 C_\Sigma} \\ a_1^{(\pm)} &= \pm \frac{\tilde{C}_2 U_2 - (\tilde{C}_3 + \tilde{C}_2) U_1}{e R_1 C_\Sigma} \end{aligned}$$

The effective capacitances C_k are defined as $\tilde{C}_k = C_k + C_g/3$ and the point q is given by the relation

$$e q(U_1, U_2, V_g) = \tilde{C}_2 U_2 - (\tilde{C}_3 + \tilde{C}_2) U_1 - C_g V_g \quad (56)$$

The value q is non-integer in general. It satisfies the condition $\Gamma_1^{(-)}(q + 1/2) = \Gamma_1^{(+)}(q - 1/2) = 0$. The dimension of the \hat{L}_χ -matrix is equal to $n_{\max} - n_{\min}$, where $n_{\max}(n_{\min})$ can be found from the conditions $\Gamma_3^{(-)}(n) \geq 0$ ($\Gamma_1^{(+)}(n) \geq 0$). The value $e n_{\max}$, ($e n_{\min}$) gives the maximum (minimum) charge that can be in the island for a given voltages U_1 , U_2 and V_g .

We can see from the Exp. (54) that there are four elementary processes of charge transfer in the system at low temperatures, each of them being associated with the pre-factor $e^{\pm i\chi_k}$. The factors $e^{i\chi_3}$ and $e^{-i\chi_2}$ correspond to the charge transfer from the third terminal into the island and from the

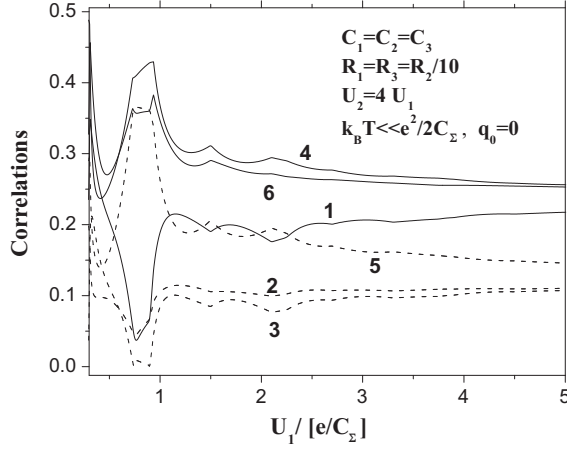

Figure 8. The matrix F of auto- and cross-shot noise correlation versus voltage U_1 for the 3-terminal quantum dot setup. Parameters are shown on the plot. (1) - F_{11} , (2) - $|F_{12}|$, (3) - $|F_{13}|$, (4) - F_{22} , (5) - $|F_{23}|$, (6) - F_{33} .

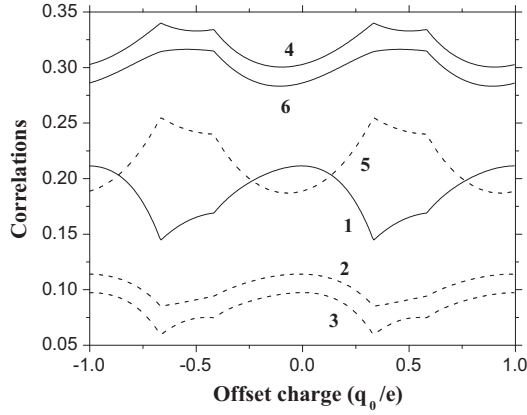

Figure 9. The matrix F of auto- and cross-shot noise correlation versus the offset charge for the 3-terminal quantum dot setup. Parameters are the same as on the Fig. 8. The voltage $U_1 = U_2/4 = 1.25e/C_\Sigma$. (1) - F_{11} , (2) - $|F_{12}|$, (3) - $|F_{13}|$, (4) - F_{22} , (5) - $|F_{23}|$, (6) - F_{33} .

island into the second terminal, respectively. Hence, the random current through the 3d (2nd) junctions always has the positive (negative) sign. Two factors $e^{\pm\chi_1}$ stem from the charge transfer through the first junction in the direction either from the island into the first contact or vice versa. Therefore the current I_1 fluctuates in both directions.

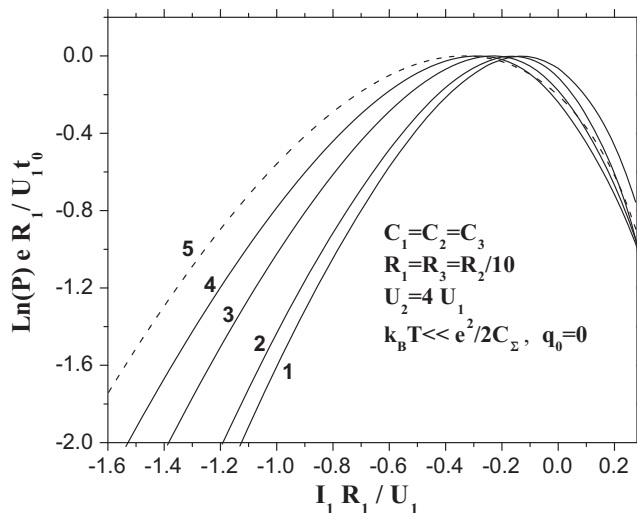

Figure 10. The logarithm of current distribution $\ln P(I_1, I_2)$ in the 3-terminal quantum dot as a function of current I_1 , under condition $I_2 = \langle I_2 \rangle$. Parameters are shown on the plot. (1) - $U_1 = 1.25 e/C_\Sigma$, (2) - $U_1 = 2.0 e/C_\Sigma$, (3) - $U_1 = 4.0 e/C_\Sigma$, (4) - $U_1 = 10.0 e/C_\Sigma$; curve (5) corresponds to the non-interacting regime.

Let us consider the shot noise correlations in the system. In Fig. 8 we give the illustrative example of the voltage dependence of the shot noise correlations F_{km} for a certain choice of parameters. The definition of matrix F_{km} is the same as we have used in the end of section 3. The Coulomb blockade features are strongly pronounced for an asymmetric setup only. The results shown in Fig. 8 correspond to $R_1 = R_3 = R_2/10$, $\tilde{C}_1 = \tilde{C}_2 = \tilde{C}_3$ and $U_2/U_1 = 4$. In Fig. 9 we show the dependence of the shot noise correlations on the offset charge for the same set of parameters and the value of $U_1 = 1.25 e/C_\Sigma$. The special points of both these dependences occur when either n_{\min} , n_{\max} or the integer part of q are changed by ± 1 . As the result one observes multi-periodic Coulomb blockade oscillations in the offset charge dependences.

We now proceed with the evaluation of the FCS. The action $S(\{\chi_i\})$ has been calculated with the use of (51). To find the probability distribution P we have evaluated the Fourier transform (2) in the saddle point approximation. It is applicable here, since we consider the low frequency limit only, $\omega \ll \Gamma$. In this limit both action S and number of transmitted particles $N_i = I_i t_0/e \gg 1$. Due to the current conservation $\sum_k I_k = 0$, only two currents are independent and the action $S(\{\chi_i\})$ depends on the differences $\chi_{ij} = \chi_i - \chi_j$ only. In what follows we have chosen I_1

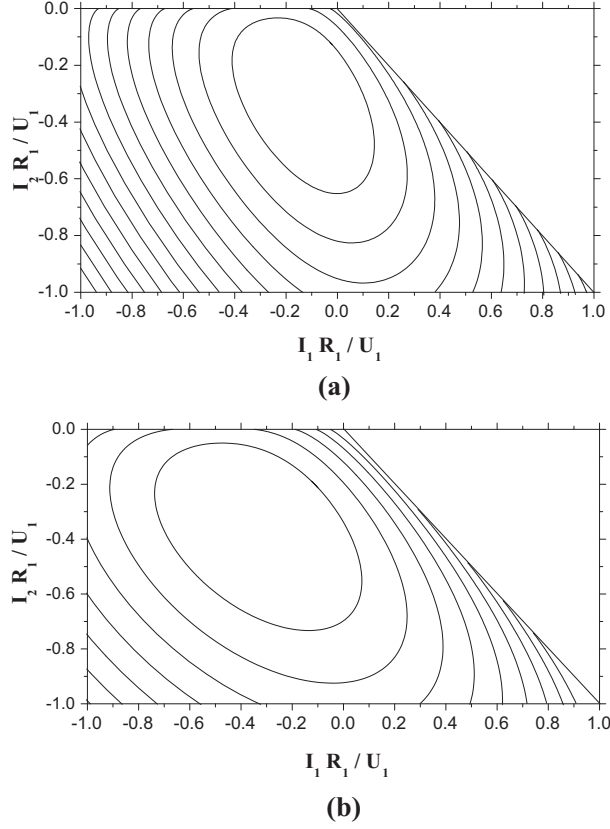

Figure 11. The contour maps of the current distribution $\log[P(I_1, I_2)]$ in the 3-terminal quantum dot. $U_1 = U_2/4.0 = 1.25 e/C_\Sigma$. (a) - Coulomb blockade island. Parameters are the same as in Fig. 10. (b) - Chaotic quantum dot.

and I_2 as the independent variables to plot the logarithm of probability $\ln P(I_1, I_2)$. In the saddle point approximation, with the exponential accuracy, it is given by $P(I_1, I_2) \sim e^{-\Omega(\chi^*)}$. Here χ^* is a saddle point of the function $\Omega(\chi) = S(\chi) + i\chi_1 I_1 t_0/e + i\chi_2 I_2 t_0/e$. The results for $\ln P(I_1, I_2)$ are shown in Figs. 10 and 11(a). From the contour map on Fig. 11(a) we see that $P(I_1, I_2)$ is non-zero in the region $I_1 < 0, I_2 < 0$ and in the region $I_1 \leq |I_2|$ provided $I_1 > 0$ and $I_2 < 0$. This range of plausible current fluctuations stems from the χ -dependence of rates (54). Any current fluctuation automatically satisfies the constrain $\sum_k I_k = 0$ and conditions $I_2 < 0$ and $I_3 > 0$.

Before discussing the results, let us set the reference point for such discussion. This reference will be the results of the previous section. We consider the FCS in the three-terminal chaotic quantum dot when its contacts

are tunnel junctions with resistances $R_k^{-1} \gg e^2/\pi\hbar$. In this limit the effects of interaction are negligible and electrons are scattered independently at different energies. Provided $U_2 > U_1$, the generating function $S(\{\chi_i\})$ in the given case is a sum of the two independent processes (23)

$$S(\chi_1, \chi_2, \chi_3) = S_1(\chi_1, \chi_2, \chi_3) + S_2(\chi_1, \chi_2, \chi_3) \quad (57)$$

Here

$$S_1(\chi_1, \chi_2, \chi_3) = \frac{U_1 t_0}{2e} \left\{ G_1 + G_2 + G_3 - \sqrt{(G_1 + G_2 - G_3)^2 + 4G_3 e^{i\chi_3} (G_1 e^{-i\chi_1} + G_2 e^{-i\chi_2})} \right\}$$

$$S_2(\chi_1, \chi_2, \chi_3) = \frac{(U_2 - U_1) t_0}{2e} \left\{ G_1 + G_2 + G_3 - \sqrt{(G_1 + G_3 - G_2)^2 + 4G_2 e^{-i\chi_2} (G_1 e^{i\chi_1} + G_3 e^{i\chi_3})} \right\}$$

and $G_k = R_k^{-1}$ are the conductances of the junctions.

The logarithm of probability $\ln P_0(I_1, I_2)$, evaluated with the use of statistics (57), is shown by the dashed line in Fig. 10. Its contour map for the same values of parameters is separately presented in Fig. 11(b). The maximum of $\ln P_0(I_1, I_2)$, as expected, occur at $\bar{I}_1 = \bar{I}_2 = U_1/3R_1$.

Comparing the FCS in the Coulomb blockade and non-interacting limits we can draw the following conclusions. In spite of the different regimes, we see that the qualitative dependence of probabilities versus the currents is similar for both cases. The probability distribution in both cases has a single maximum, corresponding to the average values of currents. The tails of distribution are essentially non-Gaussian both in the weak and strong interacting limit. The statistics approaches to the Gaussian-type one in the strong Coulomb blockade limit only, when the applied voltage to the system is only few above the Coulomb blockade threshold. (See curves 1 and 2 in Fig. 10) At higher applied voltages the probability distribution has a tendency to approach to the current distribution of the non-interacting system. However, they never become identical, even in the limit $U_{1,2} \gg e/C_\Sigma$. (Curves 4 and 5). The same is true for the shot-noise correlations. Generally, we conclude that the Coulomb interaction always suppresses the relative probabilities of big current fluctuations. This stems from the fact that any big current fluctuation in Coulomb blockade dot is related with the large accumulation (or depletion) of the charge on the island. The latter process results in the excess of electrostatic energy. Therefore the relative probability of such fluctuation is decreased, as compared to the probability of the similar current fluctuation in the non-interacting regime.

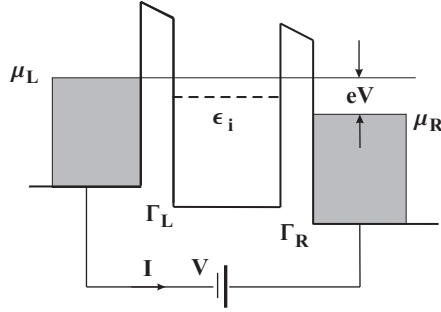

Figure 12. The single resonant level system, formed by the two tunnel barriers. The resonant level in the quantum well is shown by the dashed line.

5. The equivalence of scattering and master equation approaches to the FCS

In this section we evaluate the FCS in the generic case of a single resonant level, shown in Fig. 12. We consider only the non-interacting spinless electrons and demonstrate the equivalence of scattering and master equation approaches to the FCS in the framework of this model.

We start by considering the FCS in the master equation framework. It is applicable, provided the applied voltage or the temperature are not too low, i.e. $\max\{eV, k_B T\} \gg \hbar\Gamma_{L(R)}$. Here $\Gamma_{L(R)}$ denote the quantum-mechanical tunneling rates from the left (right) electrode onto the resonant level. The system can be found in the two microscopic states only: one with no electron on the level, and another with a single electron. Then the transition rates involved reads as

$$\begin{aligned}\Gamma_{1\leftarrow 0} &= \Gamma_L f_L(\epsilon_i) + \Gamma_R f_R(\epsilon_i) \\ \Gamma_{0\leftarrow 1} &= \Gamma_L [1 - f_L(\epsilon_i)] + \Gamma_R [1 - f_R(\epsilon_i)]\end{aligned}\quad (58)$$

Here the indices $\{0\}$ and $\{1\}$ denote the microscopic state with no and one electron on the level. Fermi function $f_{L(R)}(\epsilon) = (1 + \exp[(\epsilon - \mu_{L(R)})/kT])^{-1}$ accounts for the filling factor in the left (right) lead and ϵ_i is the position of the resonant level.

Following the definition (45) and the expression for the rates (58), the \hat{L}_χ -matrix of the single resonant level model reads as

$$\hat{L}_\chi = \begin{pmatrix} \Gamma_{1\leftarrow 0} & -\Gamma_{0\leftarrow 1}(\chi) \\ -\Gamma_{1\leftarrow 0}(\chi) & \Gamma_{0\leftarrow 1} \end{pmatrix}\quad (59)$$

where

$$\begin{aligned}\Gamma_{1\leftarrow 0}(\chi) &= \Gamma_L f_L e^{-i\chi_1} + \Gamma_R f_R e^{-i\chi_2} \\ \Gamma_{0\leftarrow 1}(\chi) &= \Gamma_L (1 - f_L) e^{i\chi_1} + \Gamma_R (1 - f_R) e^{i\chi_2}\end{aligned}\quad (60)$$

Evaluating the minimum eigenvalue of this matrix we obtain the current statistics in the following form

$$\begin{aligned}S(\chi) &= \frac{t_0}{2} \left\{ \Gamma_L + \Gamma_R - \sqrt{\mathcal{D}(\chi)} \right\} \\ \mathcal{D}(\chi) &= (\Gamma_L + \Gamma_R)^2 + 4\Gamma_L \Gamma_R [f_{(-)}(\epsilon_i)(e^{-i\chi} - 1) + f_{(+)}(\epsilon_i)(e^{i\chi} - 1)]\end{aligned}\quad (61)$$

Here $f_{(-)}(\epsilon_i) = f_L(\epsilon_i)[1 - f_R(\epsilon_i)]$, $f_{(+)}(\epsilon_i) = f_R(\epsilon_i)[1 - f_L(\epsilon_i)]$ and $\chi = \chi_1 - \chi_2$.

Since the electrons above are assumed to be non-interacting, one might have come to the same result in the framework of the pioneering approach by Levitov *et.al.*[12]. We will show now that it is indeed the case.

According to Ref. [12] the general expression for the current statistics through a single contact reads as

$$\begin{aligned}S(\chi) &= -\frac{t_0}{2\pi} \sum_n \int d\epsilon \ln \left\{ 1 + T_n(\epsilon) \times \right. \\ &\quad \left. \left(f_L(\epsilon)[1 - f_R(\epsilon)](e^{-i\chi} - 1) + f_R(\epsilon)[1 - f_L(\epsilon)](e^{i\chi} - 1) \right) \right\}\end{aligned}\quad (62)$$

It is valid for any two-terminal geometry provided the region between two electrodes can be described by the one-particle scattering approach. $T_n(\epsilon)$ is a set of transmission eigenvalues which are in general energy-dependent. For a resonant level there is a single resonant transmission eigen-value $T_r(\epsilon)$, its energy dependence being given by the Breit-Wigner formula

$$T_r(\epsilon) = \frac{\Gamma_L \Gamma_R}{(\epsilon - \epsilon_i)^2 + (\Gamma_L + \Gamma_R)^2/4}\quad (63)$$

The result (62, 63) is more general, than Exp. (61), obtained by means of master equation. If electrons do not interact, the Exp. (62) is valid for any temperature. It can be simplified in the regime $k_B T \gg \hbar \Gamma$. As we will show, in this limit the general result (62) coincides with the result (61) of master equation. It is easier to perform the calculation if one first evaluates the χ -dependent current $I(\chi) = (ie/t_0)\partial S/\partial \chi$. It reads

$$\begin{aligned}I(\chi) &= \frac{1}{2\pi} \int d\epsilon [f_{(+)}(\epsilon)e^{i\chi} - f_{(-)}(\epsilon)e^{-i\chi}] \times \\ &\quad \left\{ T_r^{-1}(\epsilon) + [f_{(-)}(\epsilon)(e^{-i\chi} - 1) + f_{(+)}(\epsilon)(e^{i\chi} - 1)] \right\}\end{aligned}\quad (64)$$

Let us consider the situation when the resonant level is placed between the chemical potentials $\mu_{L\{R\}}$ in the leads. Since we assumed that $k_B T \gg \Gamma_{L(R)}$, the main contribution comes from the Lorentz peak and one can put $\epsilon = \epsilon_i$ in the Fermi functions. Therefore we left only with the two poles $\epsilon_{1(2)} = \epsilon_i \pm i\sqrt{\mathcal{D}(\chi)}/2$ under the integrand (64). Closing the integration contour in the upper or lower half-plane we arrive at

$$I(\chi) = e \Gamma_L \Gamma_R [f_{(+)}(\epsilon_i) e^{i\chi} - f_{(-)}(\epsilon_i) e^{-i\chi}] / \sqrt{\mathcal{D}(\chi)}$$

Integrating it over χ one finds for the $S(\chi) = (t_0/ie) \int_0^\chi I(\chi') d\chi'$ the result (61) obtained by means of master equation.

Thus, we have verified the correspondence between two approaches to statistics in the non-interacting regime. We have shown that one can reproduce the statistics (61) on substituting $T_r(\epsilon)$ into the Exp. (62) and assuming the regime $k_B T \gg \hbar\Gamma$. As it was discussed previously, this is the condition, when the master equation approach, and hence its consequence (61), are valid.

6. Summary

We have reviewed here a constructive theory of counting statistics for electron transfer in multi-terminal mesoscopic systems. We have covered two opposite limit of weak and strong interaction. For the case of weakly interacting electrons, when the conductance of the system $G \gg G_Q$, the theory of FCS reduces to a circuit theory of 2×2 matrices associated with Keldysh Green functions. In the Coulomb blockade limit, $G \ll G_Q$, the FCS methods turns out to be an extension of the usual master equation approach. We have applied these methods to study the FCS of charge transfer through the three-terminal quantum dot. Surprisingly, the FCS has a similar qualitative features both in weakly and strongly interacting regimes. We found that Coulomb interaction suppresses the relative probabilities of big current fluctuations in the dot. We have also reviewed the scattering approach to FCS in multi-terminal circuits. Then by considering the generic model of a single resonance level, we have established the equivalence of scattering and master equation approaches to FCS.

The theories presented enables one for easy theoretical prediction of the FCS for a given practical layout. Thereby they facilitate experimental activities in this direction. Up to now, only the noise has been measured. In our opinion, the measurements of FCS can be easily performed with *threshold detectors* that produce a signal provided the current in a certain terminal exceeds the threshold value. If the threshold value exceeds the average current, the detector will be switched by this relatively improbable

fluctuation of the current. The signal rate will be thus proportional to the probability of these fluctuations $P(I)$, the value given by the theory of FCS.

References

1. Ya. M. Blanter and M. Büttiker, Phys. Rep. **336**, 1 (2000).
2. L. Saminadayar, D. C. Glattli, Y. Jin, and B. Etienne, Phys. Rev. Lett. **79**, 2526 (1997). ; R. de-Picciotto, M. Reznikov, M. Heiblum, V. Umansky, G. Bunin, and D. Mahalu, Nature **389**, 162 (1997).
3. R. Cron, M. F. Goffman, D. Esteve, and C. Urbina, Phys. Rev. Lett. **86**, 4104 (2001).
4. S. Oberholzer, E. V. Sukhorukov, C. Strunk, C. Schönenberger. T. Heinzel, and M. Holland, Phys. Rev. Lett. **86**, 2114 (2001)
5. A. A. Kozhevnikov, R. J. Schoelkopf, and D. E. Prober, Phys. Rev. Lett **84**, 3398 (2000).
6. X. Jehl *et al.*, Nature (London) **405**, 50 (2000).
7. M. Büttiker, Phys. Rev. B **46**, 12485 (1992).
8. R. C. Liu, B. Odom, Y. Yamamoto, and S. Tarucha, Nature **391**, 263 (1998)
9. W. D. Oliver, J. Kim, R. C. Liu, Y. Yamamoto, Science, **284**, 299 (1999)
10. M. Henny, S. Oberholzer, C. Strunk, T. Heizel, K. Ensslin, M. Holland, C. Schönenberger, Science **284**, 296 (1999).
11. L. S. Levitov and G. B. Lesovik, JETP Lett. **58**, 230 (1993).
12. L. S. Levitov, H.-W. Lee, and G. B. Lesovik, Journal of Mathematical Physics, **37** (1996) 10.
13. H. Lee, L. S. Levitov, A. Yu. Yakovets, Phys. Rev. B, **51**, 4079 (1995)
14. Ya. M. Blanter, H. Schomerus, and C.W.J. Beenakker, Physica E **11**, 1 (2001).
15. A. Andreev and A. Kamenev, Phys. Rev. Lett., **85**, 1294 (2000)
16. L. S. Levitov, arXiv: cond-mat/0103617, see also the contribution to the present book
17. Y. Makhlin and A. D. Mirlin, Phys. Rev. Lett., **87**, 276803 (2001)
18. Yu. V. Nazarov, Ann. Phys. (Leipzig) **8** Spec. Issue, SI-193 (1999), cond-mat/9908143.
19. Yu. V. Nazarov, *Generalized Ohm's Law*, in: Quantum Dynamics of Submicron Structures, eds. H. Cerdeira, B. Kramer, G. Schoen, Kluwer, 1995, p. 687.
20. W. Belzig and Yu. V. Nazarov, Phys. Rev. Lett., **87**, 067006 (2001); W. Belzig and Yu. V. Nazarov, Phys. Rev. Lett., **87**, 197006 (2001).
21. Ya. M. Blanter, E. V. Sukhorukov, Phys. Rev. Lett. **84**, 1280 (2000).
22. A. V. Andreev and E. G. Mishchenko Phys. Rev. B **64**, 233316 (2001)
23. M.-S. Choi, F. Plastina, and R. Fazio Phys. Rev. Lett. **87**, 116601 (2001)
24. Yu. V. Nazarov, D. A. Bagrets, Phys. Rev. Lett. **88**, 196801 (2002)
25. J. Rammer and H. Smith, Rev. Mod. Phys. **58**, 323 (1986).
26. A. I. Larkin and Yu. V. Ovchinnikov, Sov. Phys. JETP **41**, 960 (1975); Sov. Phys. JETP **46**, 155 (1977).
27. Yu. V. Nazarov, Superlattices Microst. **25**, 1221 (1999).
28. O. Agam, I. Aleiner and A. Larkin, Phys. Rev. Lett., **85**, 3153 (2000).
29. S. A. van Langen, M. Büttiker, Phys. Rev. B., **56**, R1680 (1997)
30. C.W.J. Beenakker, Rev. Mod. Phys., **69**, 731, (1997)
31. N.G. van Kampen, *Stochastic processes in physics and chemistry*, Rev. and enl. edition, Elsevier Science Publishes B.V., North-Holland, 1992
32. G.-L. Ingold, Yu. V. Nazarov, in *Single Charge Tunneling*, NATO ASI Series B: **294**, ed. H. Grabert, M. H. Devoret (NewYork, 1992)