

# Mutual Composite Fermion and composite Boson approaches to balanced and imbalanced bilayer quantum Hall system: an electronic analogy of the Helium 4 system

Jinwu Ye

Department of Physics, The Pennsylvania State University, University Park, PA, 16802

(Dated: November 8, 2018)

We use both Mutual Composite Fermion (MCF) and Composite Boson (CB) approach to study balanced and im-balanced Bi-Layer Quantum Hall systems (BLQH) and make critical comparisons between the two approaches. We find the CB approach is superior to the MCF approach in studying ground states with different kinds of broken symmetries. In the phase representation of the CB theory, we first study the Excitonic superfluid state (ESF). The theory puts spin and charge degree freedoms in the same footing, explicitly bring out the spin-charge connection and classify all the possible excitations in a systematic way. Then in the dual density representation of the CB theory, we study possible intermediate phases as the distance increases. We propose there are two critical distances  $d_{c1} < d_{c2}$  and three phases as the distance increases. When  $0 < d < d_{c1}$ , the system is in the ESF state which breaks the internal  $U(1)$  symmetry, when  $d_{c1} < d < d_{c2}$ , the system is in an Pseudo-spin density wave ( PSDW ) state which breaks the translational symmetry, there is a first order transition at  $d_{c1}$  driven by the collapsing of magneto-roton minimum at a finite wavevector in the pseudo-spin channel. When  $d_{c2} < d < \infty$ , the system becomes two weakly coupled  $\nu = 1/2$  Composite Fermion Fermi Liquid ( FL) state. There is also a first order transition at  $d = d_{c2}$ . We construct a quantum Ginzburg Landau action to describe the transition from ESF to PSDW which break the two completely different symmetries. By using the QGL action, we explicitly show that the PSDW takes a square lattice and analyze in detail the properties of the PSDW at zero and finite temperature. We also suggest that the correlated hopping of vacancies in the active and passive layers in the PSDW state leads to very large and temperature dependent drag consistent with the experimental data. Then we study the effects of imbalance on both ESF and PSDW. In the ESF side, the system supports continuously changing fractional charges as the imbalance changes. In the PSDW side, there are two quantum phase transitions from the commensurate excitonic solid to an in-commensurate excitonic solid and then to the excitonic superfluid state. We also comment on the effects of disorders and compare our results with the previous work. The very rich and interesting phases and phase transitions in the pseudo-spin channel in the BLQH is quite similar to those in  $^4He$  system with the distance playing the role of the pressure. A BLQH system in a periodic potential is also discussed. The Quantum Hall state to Wigner crystal transition in single layer Quantum Hall system is studied.

## I. INTRODUCTION

### (1) Experimental Observations

Extensive attention has been lavished on Fractional Quantum Hall Effects (FQHE) in multicomponent systems since the pioneering work by Halperin<sup>1</sup>. These components could be the spins of electrons when the Zeeman coupling is very small or layer indices in multi-layered system. In particular, spin-polarized Bilayer Quantum Hall systems at total filling factor  $\nu_T = 1$  have been under enormous experimental and theoretical investigations over the last decade<sup>2</sup>. When the interlayer separation  $d$  is sufficiently large, the bilayer system decouples into two separate compressible  $\nu = 1/2$  layers. Earlier experiments exhibited a strong suppression of the tunneling current at low biases<sup>3</sup>. However, when  $d$  is smaller than a critical distance  $d_c$ , even in the absence of interlayer tunneling, the system undergoes a quantum phase transition into a novel spontaneous interlayer coherent incompressible phase<sup>2</sup>. At low temperature, with extremely small interlayer tunneling amplitude, Spielman *et al* discovered a very pronounced narrow zero bias peak in this interlayer coherent incompressible state<sup>4</sup>. M. Kel-

logg *et al* also observed quantized Hall drag resistance at  $h/e^{25}$ . In recent counterflow experiments, it was found that both linear longitudinal and Hall resistances take activated forms and vanish only in the low temperature limit<sup>6</sup>.

### (2) Theoretical achievements

Starting from Halperin's 111 wavefunction Eqn.A1 which describes a bi-layer system with  $N_1$  ( $N_2$ ) electrons in the top (bottom) layer ( the total number of electrons is  $N = N_1 + N_2$  ), using various methods, several authors discovered a Neutral Gapless Mode (NGM) with linear dispersion relation  $\omega \sim vk$  and that there is a finite temperature Kosterlitz-Thouless (KT) phase transition associated with this NGM<sup>8,9,10</sup>. By treating the two layer indices as two pseudo-spin indices, Girvin, Macdonald and collaborators mapped the bilayer system into a Easy Plane Quantum Ferromagnet (EPQFM)<sup>2,11,12</sup> ( which is equivalent to the Excitonic Superfluid ). They established the mapping by projecting the Hamiltonian of the BLQH onto the Lowest Landau Level (LLL) and then using subsequent Hartree-Fock (HF) approximation and gradient expansion ( called LLL+HF in the following ). In the picture of EPQFM<sup>2</sup>, the canonical ensemble with

definite  $S^z = N_1 - N_2 = 0$  is replaced by Grand canonical ensemble with fluctuating  $S^z$ . The relative fluctuation of  $S^z$  is at the order of  $1/\sqrt{N} \rightarrow 0$  as  $N \rightarrow \infty$ . By drawing the analogy with superconductivity where canonical ensemble with definite number of Cooper pairs is shown to be equivalent to BCS wavefunction which is a grand canonical ensemble with indefinite number of Cooper pairs, the authors in<sup>2,11,12</sup> argued this trial wavefunction is a good approximation to the exact ground state. The low energy excitations above the ground state is given by an effective 2 + 1 dimensional XY model. There are 4 flavors of topological defects called "merons" which carry fractional charges  $\pm 1/2$  and also have  $\pm$  vorticities. They have logarithmic divergent self energies and are bound into pairs at low temperature. The lowest energy excitations carry charge  $\pm e$  which are a meron pair with opposite vorticity, but the same charge. There is a finite temperature phase transition at  $T_{KT}$  where bound states of the 4 flavors of merons are broken into free merons. The large longitudinal resistivity ( $\sim 1k\Omega$ ) observed in<sup>4</sup> at very low temperature indicated that these meron pairs are highly mobil. In the presence of small tunneling, they<sup>2,11</sup> found that when the applied in-plane magnetic field is larger than a critical field  $B_{||}^*$ , there is a phase transition from a commensurate state to an incommensurate state (C-IC) with broken translational symmetries. When  $B > B_{||}^*$ , there is a finite temperature KT transition which restores the translation symmetry by means of dislocations in the domain wall structure in the incommensurate phase. Starting from the EPQFM approach, several groups investigated  $I-V$  curves in the presence of small tunneling<sup>13</sup>. In addition to the work mentioned above, there are also many other works done on BLQH. For example, several authors applied different versions of composite fermion Chern-Simon theory to study BLQH systems in<sup>16,17,19</sup>.

### (3) Discrepancies between theory and the experiments.

Despite the intensive theoretical research in<sup>2,8,9,10,11,12</sup>, there are still many serious discrepancies between theory and the experiments. According to the present theories, in the Excitonic Superfluid (ESF) state, there should be the interlayer tunneling Josephson effect, finite temperature KT transition and vanishing linear longitudinal and Hall resistances in the counterflow channel below the KT transition temperature. Unfortunately, all these characteristics have never been observed in the experiments. Although it appears certain that the dramatic conductance peak observed at  $d < d_c$  is due to the collective NGM in the ESF state, no theory can explain the magnitude of zero bias peak conductance which, though enormously enhanced, does not exceed  $10^{-2} \frac{e^2}{h}$ , its width and its dependence on proximity to the ESF state boundary (see, however, the most recent work<sup>14</sup>). All the previous calculations predicted that the in-plane field will split the zero bias peak into two side peaks, but the experiments showed that although there are two tiny shoulders appearing,

the central peak stay. The excess dissipation observed in the counterflow experiments<sup>6</sup> appears to vanish only as  $T \rightarrow 0$  limit. The origin of the excess dissipation remains an important unresolved question. But it was argued in<sup>7</sup> that the origin may come from disorders induced mobil vortices.

### (4) Open problems in SLQH and BLQH

One of the remaining outstanding problems in single layer quantum Hall (SLQH) system is to understand the quantum phase transitions from QH to QH or QH to insulating state as tuning the magnetic field at a fixed electron density or vice versa. Similarly, one of the remaining outstanding problems in BLQH is to understand novel phases and quantum phase transitions as changing the distance between the two layers. When the distance is smaller than  $d_{c1}$ , the system is in the ESF state, while it is sufficiently large, the system becomes two weakly coupled  $\nu = 1/2$  Composite Fermion Fermi Liquid (FL) state. There could be a direct first order transition between the two states as indicated in some numerical calculations<sup>15</sup>. However, the experimental observations that both zero voltage tunneling peak<sup>4</sup> and the Hall drag resistivity<sup>5</sup> develop very gradually when  $d \sim d_{c1}$  suggest the transition at  $d = d_{c1}$  is a 2nd order phase transition. Although there are very little dissipations in both the ESF and FL, the experiment<sup>20</sup> discovered strong enhancement of drag and dissipations in a large intermediate distance range. These experimental observations suggest that there must be intermediate phases between the two phases. Unfortunately, so far, the nature of the intermediate phase, especially the quantum phase transition between the ESF and the intermediate phase was not systematically investigated. The outstanding problems in both SLQH and BLQH will be addressed in this paper.

### (5) Advances in Helium 4 system

A superfluid is a fluid that can flow through the tiniest channels or cracks without viscosity. The phenomenon of superfluidity was first observed in the two isotopes of Helium:  $^4He$  and  $^3He$  which become superfluids below the transition temperatures  $T_c = 2.18K$  and  $T_c = 2.4mK$  respectively<sup>21,22</sup>. Recently, a PSU group lead by Chan found some signature of a possible supersolid state in  $^4He$  at low temperature  $T < 200 mK$  and high pressure  $p > p_c \sim 25 bar$ . The authors in<sup>25,26,27</sup> argued that there may be vacancies even at  $T = 0$  whose condensation leads to the supersolid  $^4He$ . In<sup>28</sup>, the author constructed a Ginsburg Landau (GL) theory to map out the  $^4He$  phase diagram, analyze carefully the conditions for the existence of the supersolid (SS) and study all the phases and phase transitions in a unified framework. I introduced a single parameter  $g$  which is the coupling between the normal solid (NS) component and superfluid (SF) component in the GL theory. If  $g = g_v < 0$ , I explicitly showed that there are two scenarios (1) If  $|g_v|$  is sufficiently small, then the normal solid is a commensurate solid (C-NS). The C-NS still does not have a particle-hole symmetry, it is a vacancy-like NS where the

excitation energy of a vacancy is lower than that of an interstitial, therefore named NS-v. Then for the first time, we construct a quantum Ginsburg-Landau theory (QGL) to study the SF to NS-v transition and explicitly derive the Feymann relation from the QGL (2) If  $|g_v|$  is sufficiently large, then a vacancy induced SS ( SS-v ) exists at sufficient low temperature. The critical temperature  $T_{SS-v}$  becomes an effective measure of the coupling strength  $g_v$ . The analogy between ESF in the pseudospin channel in the BLQH and the superfluid in  ${}^4\text{He}$  was explored by many previous work<sup>2,8,9,10,11,12</sup>. In this paper, we push this analogy to deeper and broader contexts. We find that the very rich and interesting phases and phase transitions in the pseudo-spin channel in the BLQH is quite similar to those in  ${}^4\text{He}$  system with the distance playing the role of the pressure.

(6) *The analogy between BLQH and Helium 4 to be explored in this paper*

In this paper, we use both Mutual Composite Fermion ( MCF)<sup>33,34,35</sup> and Composite Boson ( CB) approaches<sup>37,38</sup> to study balanced and im-balanced BLQH systems. We identify many problems with MCF approach. Then we develop a simple and effective CB theory which naturally avoids all the problems suffered in the MCF approach. The CB theory not only can describe many crucial properties of the ESF elegantly, it can also be applied to study the possible novel intermediate phase with broken translational symmetry and the quantum phase transitions between these different ground states. Therefore the CB approach is superior to the MCF approach in describing the BLQH where ground states with different kinds of broken symmetries may happen as the distance changes. By using this CB theory in its phase representation, we first study the excitonic superfluid ( ESF ) state. The theory naturally puts spin and charge degree freedoms in the same footing, explicitly bring out the spin-charge connection and classify all the possible excitations in a systematic way. Then by using the CB theory in its dual density representation and inspired by the insights achieved from the QGL theory developed in<sup>28</sup> to describe the superfluid to solid and supersolid transition in  ${}^4\text{He}$ , we explore many similarities and also some difference between the BLQH and the  ${}^4\text{He}$  system. Our understanding on phases and phase transitions in  ${}^4\text{He}$  system can shed considerably lights on the phase and phase transitions in BLQH with the pressure playing the role of the distance. For balanced BLQH, there are two critical distances  $d_{c1} < d_{c2}$ . When  $0 < d < d_{c1}$ , the system is in the ESF state, when  $d_{c1} < d < d_{c2}$ , the system is in the Pseudo-spin density wave ( PSDW) state, there is a first order transition at  $d_{c1}$  driven by magneto-roton minimum collapsing at a finite wavevector in the pseudo-spin channel. When  $d_{c2} < d < \infty$ , the PSDW melts into two weakly coupled  $\nu = 1/2$  Composite Fermion Fermi Liquid ( CFLL) state. There is a also first order transition at  $d = d_{c2}$ . However, disorders could smear the two first order transitions into two second order transitions. The transition from the ESF to the PSDW is unusual because

the two states break two completely different symmetries: the global internal  $U(1)$  symmetry and the translational symmetry respectively. We construct an effective theory in the dual density representation to describe this novel quantum phase transition. We find the transition is very similar to the superfluid to normal solid transition in  ${}^4\text{He}$  system with the distance playing the role of the pressure.

(7) *Experimental setup*

Consider a bi-layer system with  $N_1$  (  $N_2$  ) electrons in left ( right ) layer and with interlayer distance  $d$  in the presence of magnetic field  $\vec{B} = \nabla \times \vec{A}$  ( Fig.1):

$$\begin{aligned} H &= H_0 + H_{int} \\ H_0 &= \int d^2x c_\alpha^\dagger(\vec{x}) \frac{(-i\hbar\nabla + \frac{e}{c}\vec{A}(\vec{x}))^2}{2m} c_\alpha(\vec{x}) \\ H_{int} &= \frac{1}{2} \int d^2x d^2x' \delta\rho_\alpha(\vec{x}) V_{\alpha\beta}(\vec{x} - \vec{x}') \delta\rho_\beta(\vec{x}') \end{aligned} \quad (1)$$

where electrons have *bare* mass  $m$  and carry charge  $-e$ ,  $c_\alpha, \alpha = 1, 2$  are electron operators in top and bottom layers,  $\delta\rho_\alpha(\vec{x}) = c_\alpha^\dagger(\vec{x})c_\alpha(\vec{x}) - n_\alpha, \alpha = 1, 2$  are normal ordered electron densities on each layer. The intralayer interactions are  $V_{11} = V_{22} = e^2/\epsilon r$ , while interlayer interaction is  $V_{12} = V_{21} = e^2/\epsilon\sqrt{r^2 + d^2}$  where  $\epsilon$  is the dielectric constant. For imbalanced bi-layers,  $n_1 \neq n_2$ , but the background positive charges are still the same in the two layers, the chemical potential term is already included in  $H_{int}$  in Eqn.1. There are two limits: (1) Weak tunneling limit  $\Delta_{SAS} \ll \frac{e^2d}{\epsilon}$ . (2) Strong tunneling limit  $\Delta_{SAS} \gg \frac{e^2d}{\epsilon}$  where the bilayer system becomes essentially the same as a single layer. In this paper, we only consider the non-trivial weak tunneling limit at total filling factor  $\nu_T = \nu_1 + \nu_2 = 1$ . For simplicity, we set  $\Delta_{SAS} = 0$  in the Eqn.1.

(8) *The organization of the paper*

The rest of the paper is organized as follows. In section II, we use a MCF theory to study the BLQH. We achieve some limited success, but also run into many troublesome problems. In section III, we use a CB theory which puts spin and charge sector on the same footing to study the BLQH. We demonstrate why this CB theory naturally avoid all the problems suffered in the MCF approach. We also compare the CB approach with the EPQFM approach and point out advantages and limitations of both approaches. In section IV which is the key section of this paper, we push the CB theory further to analyze carefully the instability in the pseudo-spin channel which lead to the PSDW state and study its properties at both zero and finite temperatures. We also point out the important physical consequences of possible quantum fluctuation generated vacancies in the PSDW state. We also compare our results with previous ones on the intermediate phase. We study the effects of imbalance on both ESF and PSDW in the corresponding sections III and IV. In the final section, we summarized the main results of the paper and concluded that CB theory is superior to MCF approach in BLQH systems with ground

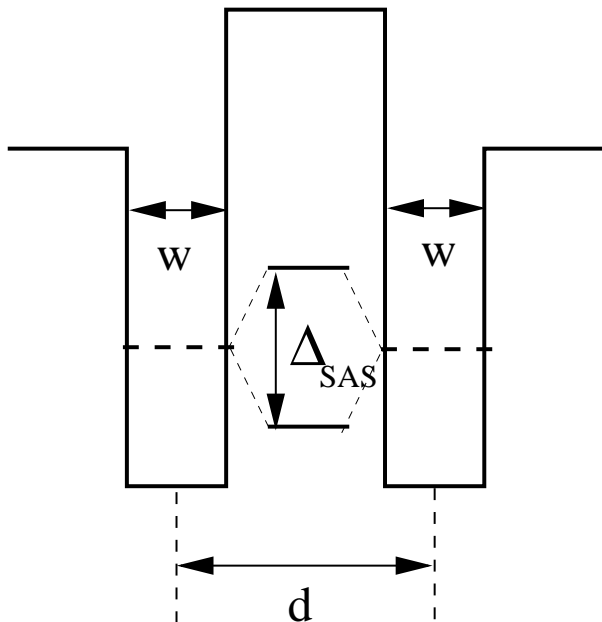

FIG. 1: A fabricated bilayer quantum Hall system. The quantum well width  $w$ , the well center to well center distance  $d$  and the magnetic length  $l$  (which is the average distance between electrons in each well) are all of the same order  $\sim 100\text{\AA}$ .  $\Delta_{SAS}$  is the tunneling between the two wells.

states of different broken symmetries. In Appendix A, we evaluate the meron fractional charges from its trial wavefunction in imbalanced case. In Appendix B, we investigate one of the outstanding problems in SLQH: the Quantum Hall state to Wigner crystal state transition in SLQH. In appendix C, we study phases and phase transitions in a BLQH in a periodic potential and two other closely related interesting models.

## II. MUTUAL COMPOSITE FERMION APPROACH: LIMITED SUCCESS AND FAILURE

In parallel to advances in bi-layer QH systems, much progress has been made on novel physics involving quasi-particles and vortices in high temperature superconductors. Anderson employed a single-valued singular gauge transformation to study the quasi-particle energy spectrum in the vortex lattice state<sup>29</sup>. By employing the Anderson transformation, the author studied the quasi-particle transport in random vortex array in the mixed state<sup>30</sup>. The author also extended the Anderson singular gauge transformation for static vortices to a mutual singular gauge transformation for quantum fluctuation generated dynamic vortices<sup>31</sup>. By using this dynamic gauge transformation, the author investigated the zero temperature quantum phase transition from  $d$ -wave superconductor to underdoped side by assuming the transition is driven by the condensations of quantum fluctuation generated vortices<sup>31</sup>. In this section, by employing

essentially the same singular gauge transformation used to study the interactions between quasi-particles and vortices in high temperature superconductors, we revisit the bi-layer QH systems.

### (1) Singular Gauge Transformation:

Performing a single-valued singular gauge transformation (SGT)<sup>31,32</sup>:

$$U = e^{i\tilde{\phi} \int d^2x \int d^2x' \rho_1(\vec{x}) \arg(\vec{x} - \vec{x}') \rho_2(\vec{x}')}, \quad \tilde{\phi} = 1 \quad (2)$$

we can transform the above Hamiltonian into:

$$H_0 = \int d^2x \psi_\alpha^\dagger(\vec{x}) \frac{(-i\hbar\vec{\nabla} + \frac{e}{c}\vec{A}(\vec{x}) - \hbar\vec{a}_\alpha(\vec{x}))^2}{2m} \psi_\alpha(\vec{x}) \quad (3)$$

where the transformed fermion is given by:

$$\begin{aligned} \psi_1(\vec{x}) &= U c_1(\vec{x}) U^{-1} = c_1(\vec{x}) e^{i \int d^2x' \arg(\vec{x} - \vec{x}') \rho_2(\vec{x}')} \\ \psi_2(\vec{x}) &= U c_2(\vec{x}) U^{-1} = c_2(\vec{x}) e^{i \int d^2x' \arg(\vec{x}' - \vec{x}) \rho_1(\vec{x}')} \end{aligned} \quad (4)$$

and the two mutual Chern-Simon (CS) gauge fields  $a_\alpha$  satisfies:  $\nabla \cdot \vec{a}_\alpha = 0, \nabla \times \vec{a}_\alpha = 2\pi\rho_{\bar{\alpha}}(\vec{x})$  (See Fig.2a). Obviously, the interaction term is unaffected by the singular-gauge transformation. Note that it is  $\arg(\vec{x} - \vec{x}')$  appearing in  $\psi_1(\vec{x})$ , while  $\arg(\vec{x}' - \vec{x})$  appearing in  $\psi_2(\vec{x})$  in Eqn.4. This subtle difference is crucial to prove all the commutation relations are kept intact by the single-valued singular gauge transformation Eqn.2. Note also that  $\arg(\vec{x}' - \vec{x})$  works equally well in Eqn.2.

It is easy to check that in single layer system where  $\rho_1 = \rho_2 = \rho$ , Eqn.2 reduces to the conventional singular gauge transformation employed in<sup>35</sup>:

$$\psi_a(\vec{x}) = e^{i2 \int d^2x' \arg(\vec{x} - \vec{x}') \rho_a(\vec{x}')} c_a(\vec{x}) \quad (5)$$

where  $\rho_a(\vec{x}) = c_a^\dagger(\vec{x})c_a(\vec{x})$  is the electron density in layer  $a = 1, 2$ . It puts *two* flux quanta in the opposite direction to the external magnetic field at the position of each electron (Fig. 1 b). On the average, a CF feels a reduced effective field which is the external magnetic field minus the attached flux quanta.

For  $\nu_T = 1$  bi-layer system, Eqn.4 puts *one* flux quantum in one layer in the opposite direction to the external magnetic field at the position directly above or below each electron in the other layer (Fig.2 a).

On the average, a Mutual Composite Fermion (MCF) in each layer feels a reduced effective field which is the external magnetic field minus the inserted flux quanta in this layer. In single layer system, it is essential to attach even number of flux quanta to keep Fermi statistics intact. The two attached flux quanta are moving together with the associated electron. However, in bi-layer system, inserting one flux quantum does keep Fermi statistics intact. The inserted one flux quantum in one layer is moving together with its associated electron in the other layer. If choosing  $\tilde{\phi}=1/2$ , the transformation is not single-valued, the statistics is changed from fermion

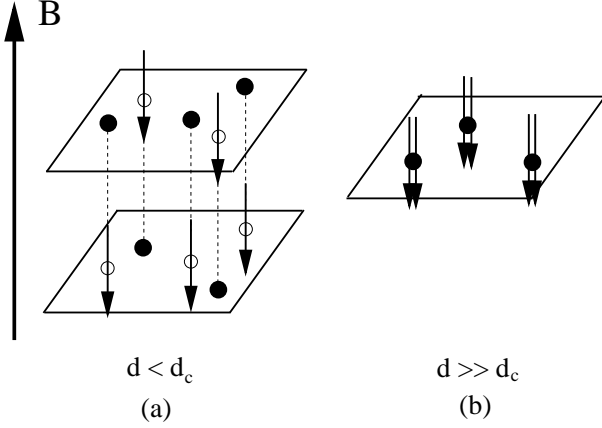

FIG. 2: Contrast the flux attachment in Eqn.2 (a) with that in Eqn.5 (b). In (a), there is one flux quantum in layer 1 when there is an electron directly downstairs in layer 2 and there is one flux quantum in layer 2 when there is an electron directly upstairs in layer 1. One can compare Fig. 1a with Fig. 2. For simplicity, we only show three electrons in the top layer and two electrons in the bottom layer.

to boson, this choice will be pursued in the next section on Composite boson approach.

### (2) Mean field theory:

In the following, we put  $\hbar = c = e = \epsilon = 1$ . At total filling factor  $\nu_T = 1$ ,  $\nabla \times \vec{A} = 2\pi n$  where  $n = n_1 + n_2$  is the total average electron density. By absorbing the average values of C-S gauge fields  $\nabla \times \langle \vec{a}_\alpha \rangle = 2\pi n_\alpha$  into the external gauge potential  $\vec{A}_\alpha^* = \vec{A} - \langle \vec{a}_\alpha \rangle$ , we have:

$$H_0 = \int d^2x \psi_\alpha^\dagger(\vec{x}) \frac{(-i\vec{\nabla} + \vec{A}_\alpha^*(\vec{x}) - \delta\vec{a}_\alpha(\vec{x}))^2}{2m} \psi_\alpha(\vec{x}) \quad (6)$$

where  $\nabla \times \vec{A}_\alpha^* = 2\pi n_\alpha$  and  $\nabla \times \delta\vec{a}_\alpha = 2\pi\delta\rho_\alpha(\vec{x})$  are the deviations from the corresponding average density ( In the following, we will simply use  $a_\alpha$  to stand for these deviations).

When  $d < d_c$ , the strong inter-layer interactions renormalize the bare mass into two effective masses  $m_\alpha^*$ <sup>36</sup>. MCF in each layer feel effective magnetic field  $B_\alpha^* = \nabla \times \vec{A}_\alpha^* = 2\pi n_\alpha$ , therefore fill exactly one MCF Landau level. The energy gaps are simply the cyclotron gaps of the MCF Landau levels  $\omega_{c\alpha}^* = \frac{B_\alpha^*}{m_\alpha^*}$ .

### (3) Fractional charges:

Let's look at the charge of quasi-particles created by MCF field operators  $\psi_\alpha^\dagger(\vec{x})$ . Intuitively, inserting  $\psi_1^\dagger(\vec{x})$  on layer 1 not only inserts an electron in layer 1 at position  $\vec{x}$ , but also pushes  $\nu_2 = \frac{N_2}{N}$  electrons in layer 2 into its boundary, therefore induces a local charge deficit at  $\vec{x}$  in layer 2 which carries charge  $\nu_2$ , the total charge at  $\vec{x}$  is  $e_1^* = -1 + \nu_2 = -\nu_1$ . If  $\vec{x}$  and  $\vec{y}$  are two points far apart, then the product of operators  $\psi_1^\dagger(\vec{x})\psi_1(\vec{y})$  in layer 1 will create a pair of fractional charges  $\pm e_1^*$  at positions  $\vec{x}$  and  $\vec{y}$  with the charge gap  $\hbar\omega_{c1}^*$ . Similarly, inserting  $\psi_2^\dagger(\vec{x})$  in

layer 2 will create a charge  $e_2^* = -1 + \nu_1 = -\nu_2$  at  $\vec{x}$  ( note that  $e_1^* + e_2^* = -1$  ). The product of operators  $\psi_2^\dagger(\vec{x})\psi_2(\vec{y})$  in layer 2 will create a pair of fractional charges  $\pm e_2^*$  at  $\vec{x}$  and  $\vec{y}$  with the charge gap  $\hbar\omega_{c2}^*$ . Only when the two layers are identical  $N_1 = N_2$ ,  $e_1^* = e_2^* = -1/2$  which carries fractional charge of even denominators. In general, the imbalanced bilayer system supports continuously changing total fractional charges in the thermodynamic limit.

The above arguments give the correct *total* fractional charges  $\pm e_1^*, \pm e_2^*$ . However, it can not determine the *relative* charge distributions between the two layers. At mean field level, the energies of all the possible relative charge differences are degenerate. The lowest energy configuration can only be determined by fluctuations. The above arguments are at most intuitive. The much more rigorous and elegant topological arguments can only be given in the composite boson theory of the next section.

### (4) Fluctuations:

When considering fluctuations around the MCF mean field theory, it is convenient to go to Lagrangian<sup>36</sup>:

$$\begin{aligned} \mathcal{L} = & \psi_\alpha^\dagger(\partial_\tau - ia_0^\alpha)\psi_\alpha + \psi_\alpha^\dagger \frac{(-i\vec{\nabla} + \vec{A}_\alpha^* - \vec{a}_\alpha)^2}{2m_\alpha^*} \psi_\alpha \\ & + ia_0^\alpha n_\alpha + \frac{iq}{2\pi}(\sigma_1)_{\alpha\beta} a_0^\alpha a_0^\beta \\ & + \frac{q}{4\pi}(a_t^1 a_t^1 + a_t^2 a_t^2 + 2e^{-qd} a_t^1 a_t^2) \end{aligned} \quad (7)$$

where the constraints have been used to rewrite the Coulomb interactions and  $a_t^\alpha$  is the transverse spatial component of gauge field in Coulomb gauge  $\nabla \cdot \vec{a}_\alpha = 0$ <sup>35,76,77</sup> ( In Lorenz invariant gauge the second to the last term becomes the mutual C-S term<sup>31</sup>  $\frac{i}{4\pi}(\sigma_1)_{\alpha\beta}\epsilon_{\mu\nu\lambda} a_\mu^\alpha \partial_\nu a_\lambda^\beta$  where  $\alpha, \beta$  refer to layer indices, while  $\mu, \nu, \lambda$  refer to space-time indices ). The Hamiltonian has local  $U(1)_1 \times U(1)_2$  gauge symmetry which corresponds to the invariance under  $\psi_\alpha(\vec{x}) \rightarrow e^{i\theta_\alpha(\vec{x})}\psi_\alpha(\vec{x})$ ,  $a_\mu^\alpha \rightarrow a_\mu^\alpha + \partial_\mu\theta_\alpha$ .

Integrating out MCF  $\psi_1, \psi_2$  to one-loop and carefully expanding the interlayer Coulomb interaction to the necessary order in the long-wavelength limit leads to:

$$\begin{aligned} \mathcal{L} = & \frac{iq}{2\pi} a_0^+ a_t^+ + \frac{q}{4\pi} (a_t^+)^2 \\ & + \frac{\epsilon_+}{4} q^2 (a_0^+)^2 + \frac{1}{4} (\epsilon_+ \omega^2 + (\chi_+ - \frac{d}{2\pi}) q^2) (a_t^+)^2 \\ & + \frac{\epsilon_+}{4} q^2 (a_0^-)^2 + \frac{1}{4} (\epsilon_+ \omega^2 + (\chi_+ + \frac{d}{2\pi}) q^2) (a_t^-)^2 \\ & + \frac{\epsilon_-}{2} q^2 a_0^+ a_0^- + \frac{1}{2} (\epsilon_- \omega^2 + \chi_- q^2) a_t^+ a_t^- + \dots \end{aligned} \quad (8)$$

where  $\dots$  are higher gradient terms and  $a_t^\alpha$  is the transverse component of gauge field in Coulomb gauge  $\nabla \cdot \vec{a}_\alpha = 0$ <sup>35,76,77</sup>,  $a_\mu^\pm = a_\mu^1 \pm a_\mu^2$  and  $\epsilon_\pm = \frac{1}{2}(\epsilon_1 \pm \epsilon_2)$ ,  $\chi_\pm = \frac{1}{2}(\chi_1 \pm \chi_2)$ .  $a^+$  (  $a^-$  ) stands for the total ( relative ) density fluctuation.  $a_\mu^-$  is the NGM identified previously<sup>8,9,10</sup>. The dielectric constants  $\epsilon_\alpha = \frac{m_\alpha^*}{2\pi B_\alpha}$  and the susceptibilities  $\chi_\alpha = \frac{1}{2\pi m_\alpha^*}$  were calculated in single layer system in<sup>34</sup>.

The first two terms are C-S term and Coulomb interaction term for + gauge field which take exactly the same forms as in a single layer system<sup>35</sup>. The third and the fourth terms are non-relativistic Maxwell terms for + and - modes respectively. The last two terms couple + mode to - mode. Integrating out + modes leads to  $\epsilon_-^2 q^3 (a_0^-)^2 + \epsilon_- (\epsilon_- \omega^2 + \chi_- q^2) (iqa_0^- a_t^-)$  which are sub-leading to the Maxwell term of  $a_0^-, a_t^-$ . In fact, these terms break Time reversal and Parity, in principle, a C-S term  $iqa_0^- a_t^-$  will be generated under RG sense. However, the coefficient of this generated C-S term could be so small that it can be neglected except at experimentally unattainable low temperatures.

(5) *Neutral Gapless modes:*

For simplicity, we only consider the balanced case and will comment on im-balanced case later. Note that  $\nabla \times \vec{a}^- = 2\pi\delta\rho$  where  $\delta\rho = \delta\rho_2(\vec{x}) - \delta\rho_1(\vec{x})$  is the relative density fluctuation of the two layers. Introducing a variable  $\phi$  which is conjugate to  $\delta\rho(\vec{x})$ , namely  $[\phi(\vec{x}), \delta\rho(\vec{x}')] = i\delta(\vec{x} - \vec{x}')$ , we can write a spin-wave Hamiltonian density:

$$\mathcal{H} = \frac{1}{2}\chi_s^{-1}(\delta\rho)^2 + \frac{1}{2}\rho_s(\nabla\phi)^2 \quad (9)$$

If  $\delta\rho$  is treated as a continuous variable, then  $\phi$  is a free field varying from  $-\infty$  to  $\infty$ . By integrating out  $\delta\rho$ , we get the  $\phi$  representation:

$$\mathcal{L}_\phi = \frac{1}{2}\chi_s(\partial_\tau\phi)^2 + \frac{1}{2}\rho_s(\nabla\phi)^2 \quad (10)$$

Integrating out  $\phi$ , we get an effective action density in the  $\delta\rho$  representation which is dual to the above  $\phi$  representation:

$$\mathcal{L}_\rho = \frac{1}{2}\chi_s^{-1}(\delta\rho)^2 + \frac{1}{2}\rho_s^{-1}\left(\frac{\omega}{q}\right)^2(\delta\rho)^2 \quad (11)$$

Plugging the constraint  $\nabla \times \vec{a}^- = 2\pi\delta\rho$  into Eqn.11, we get:

$$\mathcal{L}_a = \frac{1}{2}(\rho_s^{-1}\omega^2 + \chi_s^{-1}q^2)(a_t^-)^2 \quad (12)$$

This is consistent with the well-known fact that a *pure* 2 + 1 dimensional  $U(1)$  gauge field is dual to a 2 + 1 dimensional Gaussian model which does not have any topological excitations<sup>62</sup>. Comparing Eqn.12 with Eqn.8 ( for simplicity, we take  $N_1 = N_2$  ), we get  $\rho_s = \hbar\omega_c^*/\pi$ ,  $\chi_s = [2\pi^2(\chi + \frac{d}{2\pi})]^{-1}$ . So the spin stiffness scales as the cyclotron gap and the finite charge gap of MCF implies finite spin stiffness. In order to compare with experimental data in<sup>4,5</sup>, we have to put back  $\hbar, c, e, \epsilon$  and find the spin-wave velocity:

$$v^2 = \rho_s/\chi_s = \frac{(\omega_c^*)^2}{\pi n} + \left(\frac{\alpha c}{\epsilon}\right)\left(\frac{d}{l}\right)\frac{\omega_c^*}{\sqrt{2\pi n}} \quad (13)$$

where  $n$  is the total density,  $l$  is the magnetic length and  $\alpha \sim 1/137$  is the fine structure constant. Note that

the correct expansion of interlayer Coulomb interaction is crucial to get the second term.

By measuring the transport properties at finite temperature, the authors in<sup>5</sup> found the activation gap  $E_A \sim 0.4K$ . By setting  $E_A = \hbar\omega_c^*$  and plugging the experimental parameters  $n = 5.2 \times 10^{10} \text{cm}^{-2}$ ,  $d/l = 1.61$ ,  $\epsilon = 12.6$  into Eqn.13, we find that the first term is  $1.65 \times 10^{10} (\text{cm/s})^2$ , the second term is  $2.54 \times 10^{12} (\text{cm/s})^2$  which is two orders of magnitude bigger than the first term. Finally, we find  $v \sim 1.59 \times 10^6 \text{cm/s}$  which is dominated by the second term. This value is in good agreement with  $v \sim 1.4 \times 10^6 \text{cm/s}$  found in<sup>4</sup>.

(6) *Topological excitations:*

As discussed in the previous paragraph, at mean field theory, there are four kinds of gapped excitations with total fractional charges  $\pm e_1^* = \pm\nu_1$  and  $\pm e_2^* = \pm\nu_2$  which, for example, can be excited by finite temperature close to  $\hbar\omega_c^*$ . But their relative charge distributions between the two layers are undetermined. In fact, all the possible excitations can be characterized by their  $(a^+, a^-)$  charges  $(q_+, q_-)$ . For example, the four kinds of excitations are denoted by  $(\pm\nu_1, q_-), (\pm\nu_2, q_-)$ . For  $\nu_1 = \nu_2$ , they reduce to two sets:  $(\pm\frac{1}{2}, q_-)$ . If  $\delta\rho$  in Eqn.9 is treated as a discrete variable, then  $0 < \phi < 2\pi$  is an angle variable.  $q_-$  must be integers  $0, \pm 1, \dots$ . Exchanging  $a^+$  leads to  $1/r$  interaction between the four sets of beasts. While exchanging  $a^-$  leads to logarithmic interactions which lead to a bound state between two beasts with opposite  $q_- \neq 0$ . The energy of this bound state with length  $L$  is  $E_b = \Delta_+ + \Delta_- + q_+^2 \frac{\epsilon^2}{L} + q^2 \hbar\omega_c^* \ln L/l$  where  $\Delta_+$  and  $\Delta_-$  are the core energies of QH and QP respectively.

An important question to ask is what is the gluing conditions ( or selection rules ) of  $(q_+, q_-)$  for the realizable excitations ? Namely, what is spin (  $q_-$  ) and charge (  $q_+$  ) connection ? Two specific questions are: (1) Is there a charge neutral vortex excitation with  $(0, \pm 1)$  ? Being charge neutral, this kind of excitation is a bosonic excitation. (2) Is there a charge  $\pm 1/2$  and spin neutral excitation  $(\pm 1/2, 0)$  ? If they do exist, then the QP and QH pair with  $q_- = 0$  have the lowest energy  $\hbar\omega_c^* = \Delta_+ + \Delta_-$ . They decouple from  $a^-$  gauge field, therefore interact with each other only with  $1/r$  interaction and are asymptotically free even at  $T = 0$  just like those in single layer system. Their charges are evenly distributed in the two layers ( namely carry fractional charges  $\pm 1/4$  in each separate layer ). They are deconfined  $\pm 1/2$  excitations which are completely different excitations from merons which are confined logarithmically.

Unfortunately, the spin-charge connection is far from obvious in this MCF approach. So little can be said about these two possibilities. In the composite boson approach to be presented in the next section, both interesting possibilities are ruled out.

(7) *Extension to other filling factors:*

Let's briefly discuss  $\nu_T = 1/2$  bilayer system. It is well known that this state is described by Halperin's 331 state<sup>1</sup>. In this state, the singular gauge transformation  $U = e^{i \int d^2x \int d^2x' U_{\alpha\beta\rho\alpha}(\vec{x}) \text{arg}(\vec{x} - \vec{x}') \rho_\beta(\vec{x}')$  where the matrix

$U = \frac{1}{2} \begin{pmatrix} 2 & 1 \\ 1 & 2 \end{pmatrix}$  attached two intralayer flux quanta and one interlayer flux quantum to electrons to form Entangled Composite Fermions (ECF). At layer 1 (layer 2), the filling factor of ECF is  $\nu_1^* = \frac{N_1}{N_2}$  ( $\nu_2^* = \frac{N_2}{N_1}$ ). Only when the two layers are identical  $N_1 = N_2$ , we get  $\nu_1^* = \nu_2^* = 1$  QH states on both layers, therefore  $\nu_T = 1/2$  system lacks interlayer coherence.

(8) *Comparison with another version of CF approach:*

It is instructive to compare our MCF picture developed in this section with the earlier pictures proposed in<sup>17</sup>. When  $N_1 = N_2$ , the authors in<sup>17</sup> attached  $\phi = 2$  flux quanta of layer 2 to electrons in layer 1 or vice versa to form interlayer composite fermions so that at mean field theory, CF in each layer form a compressible Fermi liquid. They conjectured that  $a^-$  gauge field fluctuation mediates an attractive interaction between CF in different layers which leads to a (likely p-wave) pairing instability. This pairing between CF in different layers opens an energy gap. But no systematic theory is developed along this picture. In the MCF picture studied in this section, there is a *charge* gap which is equal to the cyclotron gap even at mean field theory which is robust against any gauge field fluctuation.

(9) *Interlayer tunneling:*

The interlayer tunneling term is:

$$H_t = tc_1^\dagger(\vec{x})c_2(\vec{x}) + h.c. \quad (14)$$

Substituting Eqn.4 into above equation leads to:

$$H_t = t\psi_1^\dagger(\vec{x})e^{i\int d^2x' [arg(\vec{x}-\vec{x}')\rho_2(\vec{x}') - arg(\vec{x}'-\vec{x})\rho_1(\vec{x}')]}\psi_2(\vec{x}) + h.c. \quad (15)$$

This is a very awkward equation to deal with.

The authors in<sup>9</sup> pointed out that the tunneling process of an electron from one layer to the other corresponds to an instanton in the  $2 + 1$  dimensional compact QED. They applied the results of Polyakov on instanton- anti-instanton plasma on  $2+1$  dimensional compact QED and found the effective action:

$$\mathcal{L} = \frac{1}{g^2}(\partial_\mu\chi)^2 + \frac{t}{2\pi l^2} \cos \chi \quad (16)$$

where  $g$  is the  $U(1)$  gauge coupling constant given in Eqn.10. In the original work of Polyakov,  $\chi$  is a non-compact field  $-\infty < \chi < \infty$ . The compactness of  $\chi$  was forced in an ad hoc way in<sup>9</sup>. Note that the compactness of QED has nothing to do with the compactness of  $\chi$ .

(10) *Summary of limited success of MCF theory:*

We use a Mutual Composite Fermion (MCF) picture to explain the interlayer coherent incompressible phase at  $d < d_c$ . This MCF is a generalization of Composite Fermion (CF) in single layer QH systems to bilayer QH systems<sup>33,34,35,36</sup>. In the mean field picture, MCF in each layer fill exactly  $\nu^* = 1$  MCF Landau level. There are four kinds of gapped quasi-particles (QP) and quasi-holes (QH) with total fractional charges  $\pm e_1^* = \pm\nu_1, \pm e_2^* =$

$\pm\nu_2$  ( For  $\nu_1 = \nu_2 = 1/2$ , they reduce to two sets ). When considering the fluctuations above the  $\nu^* = 1$  MCF QH states, we identify the NGM with linear dispersion relation  $\omega \sim vk$  and determine  $v$  in terms of experimental measurable quantities. When interpreting the activation gap  $E_A$  found in<sup>5</sup> in terms of the cyclotron gap of the  $\nu^* = 1$  MCF Landau level, we calculate  $v$  and find its value is in good agreement with the value determined in<sup>4</sup>. Tentatively, we intend to classify all the possible excitations in terms of  $a^+$  and  $a^-$  charges ( $q_+, q_-$ ).

(11) *Serious problems with MCF approach:*

Despite the success of the MCF approach mentioned above, there are many serious drawbacks of this approach. We list some of them in the following.

(a) The determination of the fractional charges is at most intuitive. A convincing determination can only be firmly established from the CB approach to be discussed in the next section. Furthermore, the MCF still carries charge 1, while the QP or QH carry charge  $\pm 1/2$ . An extension of Murthy-Shankar formalism<sup>36</sup> in SLQH to BLQH may be needed to express physics in terms of these  $\pm 1/2$  QP and QH.

(b) It is easy to see that the spin wave dispersion in Eqn.13 remains linear  $\omega \sim vk$  even in the  $d \rightarrow 0$  limit. This contradicts with the well established fact that in the  $d \rightarrow 0$  limit, the linear dispersion relation will be replaced by quadratic Ferromagnetic spin-wave dispersion relation  $\omega \sim k^2$  due to the enlarged  $SU(2)$  symmetry at  $d \rightarrow 0$ . This is because the flux attachment singular gauge transformation Eqn.2 breaks  $SU(2)$  symmetry at very beginning even in the  $d \rightarrow 0$  limit.

(c) The broken symmetry in the ground state is not obvious without resorting to the (111) wavefunction. The physics of exciton pairing can not be captured. The origin of the gapless mode is not clear.

(d) The compactness of the angle  $\phi$  in Eqn.10 was put in by hand in an ad hoc way.

(e) The spin-charge connection in ( $q_+, q_-$ ) can not be determined.

(f) The interlayer tunneling term can not be derived in a straight-forward way. See section III-E.

(g) In the imbalanced case, there are two MCF cyclotron gaps  $\hbar\omega_{c\alpha}^*$  at mean field theory. However, there is only one charge gap in the system. It is not known how to reconcile this discrepancy within MCF approach.

(h) It is not known how to push the MCF theory further to study the very interesting and novel Pseudo-spin density wave state to be discussed in section IV.

In the following, we will show that the alternative CB approach not only can achieve all the results in this section, but also can get rid of all these drawbacks naturally. Most importantly, it can be used to address the novel state: Pseudo-spin density wave state in intermediate distances.

### III. COMPOSITE BOSON APPROACH: EXCITONIC SUPERFLUID STATE

Composite boson approach originated from Girvin and Macdonald's off-diagonal long range order<sup>37</sup>, formulated in terms of Chern-Simon Ginsburg- Landau theory<sup>38</sup>. It has been successfully applied to Laughlin's series  $\nu = \frac{1}{2s+1}$ <sup>38</sup>. It has also been applied to BLQH<sup>10,12</sup>. Unfortunately, it may not be applied to study Jain's series at  $\nu = \frac{p}{2sp \pm 1}$  with  $p \neq 1$  and  $\nu = 1/2$  Fermi Liquid system. In this section, we applied CSGL theory to study both balanced and im-balanced bi-layer QH system. Instead of integrating out the charge degree of freedoms which was done in all the previous CB approach<sup>10,11</sup>, we keep charge and spin degree of freedoms on the same footing and explicitly stress the spin and charge connection. We study how the imbalance affects various physical quantities such as spin wave velocity, the meron pair distance and energy, the critical in-plane field for commensurate-incommensurate transition, etc.

We can rewrite  $H_{int}$  in Eqn.1 as:

$$\begin{aligned} H_{int} &= \frac{1}{2}\delta\rho_1 V \delta\rho_1 + \frac{1}{2}\delta\rho_2 V \delta\rho_2 + \delta\rho_1 \tilde{V} \delta\rho_2 \\ &= \frac{1}{2}\delta\rho_+ V_+ \delta\rho_+ + \frac{1}{2}\delta\rho_- V_- \delta\rho_- \end{aligned} \quad (17)$$

where  $V = V_{11} = V_{22} = \frac{2\pi e^2}{\epsilon q}$ ,  $\tilde{V} = V_{12} = \frac{2\pi e^2}{\epsilon q} e^{-qd}$ ,  $V_{\pm} = \frac{V \pm \tilde{V}}{2}$  and  $\delta\rho_{\pm} = \delta\rho_1 \pm \delta\rho_2$ .

Performing a singular gauge transformation<sup>31,32</sup>:

$$\phi_a(\vec{x}) = e^{i \int d^2 x' \arg(\vec{x} - \vec{x}') \rho(\vec{x}')} c_a(\vec{x}) \quad (18)$$

where  $\rho(\vec{x}) = c_1^\dagger(\vec{x})c_1(\vec{x}) + c_2^\dagger(\vec{x})c_2(\vec{x})$  is the total density of the bi-layer system. Note that this transformation treats both  $c_1$  and  $c_2$  on the same footing ( See Fig.3). This is reasonable only when the distance between the two layers is sufficiently small.

It can be shown that  $\phi_a(\vec{x})$  satisfies all the boson commutation relations. It can be shown that this SGT is the same as that in Eqn.2 if we choose  $\tilde{\phi} = 1/2$  and replace both  $\rho_1$  and  $\rho_2$  by  $\rho = \rho_1 + \rho_2$ . Because the SGT with  $\tilde{\phi} = 1/2$  in Eqn.2 is not single-valued, the statistics is changed from fermion to boson.

We can transform the Hamiltonian Eqn.1 into the Lagrangian in Coulomb gauge:

$$\begin{aligned} \mathcal{L} &= \phi_a^\dagger (\partial_\tau - ia_0) \phi_a + \phi_a^\dagger(\vec{x}) \frac{(-i\hbar \vec{\nabla} + \frac{\epsilon}{c} \vec{A}(\vec{x}) - \hbar \vec{a}(\vec{x}))^2}{2m} \phi_a(\vec{x}) \\ &+ \frac{1}{2} \int d^2 x' \delta\rho(\vec{x}) V_+(\vec{x} - \vec{x}') \delta\rho(\vec{x}') \\ &+ \frac{1}{2} \int d^2 x' \delta\rho_-(\vec{x}) V_-(\vec{x} - \vec{x}') \delta\rho_-(\vec{x}') - \frac{i}{2\pi} a_0 (\nabla \times \vec{a}) \end{aligned} \quad (19)$$

In Coulomb gauge, integrating out  $a_0$  leads to the constraint:  $\nabla \times \vec{a} = 2\pi \phi_a^\dagger \phi_a$ . Note that if setting  $V_- = 0$ , then the above equation is identical to a single layer with

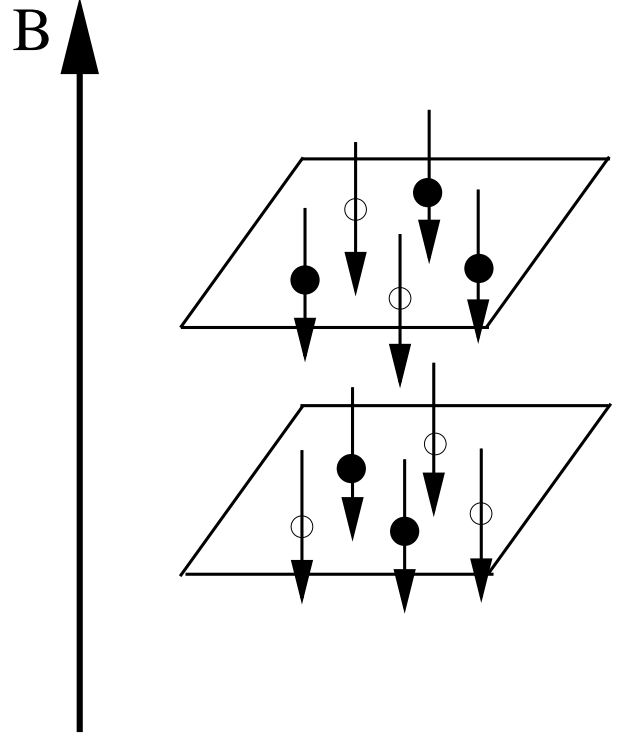

FIG. 3: The flux attachment given by Eqn.18. There is one flux quantum penetrating both layers wherever there is one electron. It does not matter this electron is in layer 1 or 2. One can compare this Fig. with Fig. 1a. For simplicity, we only show three electrons in the top layer and two electrons in the bottom layer.

spin in the absence of Zeeman term, so the Lagrangian has a  $SU(2)$  pseudo-spin symmetry. The  $V_-$  term breaks the  $SU(2)$  symmetry into  $U(1)$  symmetry. In the BLQH  $V_- > 0$ , so the system is in the Easy-plane limit.

By taking full advantage of the easy-plane anisotropy shown in Eqn.19, we can write the two bosons in terms of magnitude and phase

$$\phi_a = \sqrt{\bar{\rho}_a + \delta\rho_a} e^{i\theta_a} \quad (20)$$

The boson commutation relations imply that  $[\delta\rho_a(\vec{x}), \theta_b(\vec{x}')] = i\hbar \delta_{ab} \delta(\vec{x} - \vec{x}')$ .

We can see Eqn.19 has a local  $U(1)$  gauge symmetry  $\theta_a \rightarrow \theta_a + \chi$ ,  $a_\mu \rightarrow a_\mu + \partial_\mu \chi$  and also a global  $U(1)$  symmetry  $\theta_1 \rightarrow \theta_1 + \chi$ ,  $\theta_2 \rightarrow \theta_2 - \chi$ . We denote the symmetry by  $U(1)_L \times U(1)_G$ .

Absorbing the external gauge potential  $\vec{A}$  into  $\vec{a}$  and substituting Eqn.20 into Eqn.19, we get:

$$\begin{aligned} \mathcal{L} &= \frac{1}{2} \partial_\tau \delta\rho^+ + \frac{1}{2} \bar{\rho}_+ i \partial_\tau \theta_+ + \frac{i}{2} \delta\rho^+ (\partial_\tau \theta^+ - 2a_0) \\ &+ \frac{\bar{\rho}_a + \delta\rho_a}{2m} (\nabla \theta_a - \vec{a})^2 + \frac{1}{2} \delta\rho^+ V_+(\vec{q}) \delta\rho^+ - \frac{i}{2\pi} a_0 (\nabla \times \vec{a}) \\ &+ \frac{i}{2} (\delta\rho^- + \bar{\rho}_-) \partial_\tau \theta^- + \frac{1}{2} \delta\rho^- V_-(\vec{q}) \delta\rho^- \end{aligned} \quad (21)$$



where  $\delta\rho^\pm = \delta\rho_1 \pm \delta\rho_2$ ,  $\bar{\rho}_\pm = \bar{\rho}_1 \pm \bar{\rho}_2$ ,  $\theta_\pm = \theta_1 \pm \theta_2$ . They satisfy the commutation relations  $[\delta\rho_\alpha(\vec{x}), \theta_\beta(\vec{x}')] = 2i\hbar\delta_{\alpha\beta}\delta(\vec{x} - \vec{x}')$  where  $\alpha, \beta = \pm$ .

It is easy to see that the symmetry is  $U(1)_+ \times U(1)_-$  where  $U(1)_+$  is a local gauge symmetry, while  $U(1)_-$  is a global symmetry. We also note that it is  $\delta\rho^- + \bar{\rho}_- = (\delta\rho_1 - \delta\rho_2) + (\bar{\rho}_1 - \bar{\rho}_2) = \rho_1 - \rho_2$  which is conjugate to the phase  $\theta_-$ , namely,  $[\delta\rho^-(\vec{x}) + \bar{\rho}_-, \theta_-(\vec{x}')] = 2i\hbar\delta(\vec{x} - \vec{x}')$ . In the following, for the simplicity of notation, we redefine  $\delta\rho^- = \rho_1 - \rho_2$ , then the last two terms in Eqn.21 becomes:

$$\frac{i}{2}\delta\rho^- \partial_\tau \theta^- + \frac{1}{2}\delta\rho^- V_-(\vec{q})\delta\rho^- - h_z \delta\rho^- \quad (22)$$

where  $h_z = V_- \bar{\rho}_- = V_-(\bar{\rho}_1 - \bar{\rho}_2)$  plays a role like a Zeeman field.

By expressing the spatial gradient term in Eqn.21 in terms of  $(\delta\rho_+, \theta_+)$  and  $(\delta\rho_-, \theta_-)$ , we find

$$\begin{aligned} \mathcal{L} = & i\delta\rho^+ \left( \frac{1}{2} \partial_\tau \theta^+ - a_0 \right) + \frac{\bar{\rho}}{2m} \left[ \frac{1}{2} \nabla \theta_+ + \frac{1}{2} (\nu_1 - \nu_2) \nabla \theta_- - \vec{a} \right]^2 \langle \theta_+(-\vec{q}) \theta_+(\vec{q}) \rangle = \int_{-\infty}^{\infty} \frac{d\omega}{2\pi} \langle \theta_+(-\vec{q}, -\omega) \theta_+(\vec{q}, \omega) \rangle \\ & + \frac{1}{2} \delta\rho^+ V_+(\vec{q}) \delta\rho^+ - \frac{i}{2\pi} a_0 (\nabla \times \vec{a}) \\ & + \frac{i}{2} \delta\rho^- \partial_\tau \theta^- + \frac{\bar{\rho}f}{2m} \left( \frac{1}{2} \nabla \theta_- \right)^2 + \frac{1}{2} \delta\rho^- V_-(\vec{q}) \delta\rho^- - h_z \delta\rho^- \end{aligned} \quad (23)$$

where  $f = 4\nu_1\nu_2$  which is equal to 1 at the balanced case.

Plus the extra terms due to the magnitude fluctuations in the spatial gradient terms:

$$\begin{aligned} \frac{\delta\rho_a}{2m} (\nabla \theta_a - \vec{a})^2 = & \frac{\delta\rho^+}{2m} \left[ \left( \frac{1}{2} \nabla \theta_+ - \vec{a} \right)^2 + \left( \frac{1}{2} \nabla \theta_- \right)^2 \right] \\ & + \frac{\delta\rho^-}{2m} \left( \frac{1}{2} \nabla \theta_+ - \vec{a} \right) \cdot \nabla \theta_- \end{aligned} \quad (24)$$

Note that in Eqn.24 both  $\delta\rho^+$  and  $\delta\rho^-$  couple to terms with two spatial gradients, therefore can be dropped relative to the terms in Eqn.23 which contains just one temporal gradient.

In the following, we will discuss balanced and imbalanced cases separately:

### A. Balanced case $\nu_1 = \nu_2 = 1/2$

Putting  $\nu_1 = \nu_2 = 1/2$  and  $h_z = 0$  into Eqn.23, we get the Lagrangian in the balanced case:

$$\begin{aligned} \mathcal{L} = & i\delta\rho^+ \left( \frac{1}{2} \partial_\tau \theta^+ - a_0 \right) + \frac{\bar{\rho}}{2m} \left( \frac{1}{2} \nabla \theta_+ - \vec{a} \right)^2 \\ & + \frac{1}{2} \delta\rho^+ V_+(\vec{q}) \delta\rho^+ - \frac{i}{2\pi} a_0 (\nabla \times \vec{a}) \\ & + \frac{i}{2} \delta\rho^- \partial_\tau \theta^- + \frac{\bar{\rho}}{2m} \left( \frac{1}{2} \nabla \theta_- \right)^2 + \frac{1}{2} \delta\rho^- V_-(\vec{q}) \delta\rho^- \end{aligned} \quad (25)$$

In the balanced case, the symmetry is enlarged to  $U(1)_L \times U(1)_G \times Z_2$  where the global  $Z_2$  symmetry is the exchange symmetry between layer 1 and layer 2. At temperatures much lower than the vortex excitation energy, we can neglect vortex configurations in Eqn.25 and

only consider the low energy spin-wave excitation. The charge sector ( $\theta^+$  mode) and spin sector ( $\theta^-$  mode) are essentially decoupled.

#### (1) Off-diagonal algebraic order in the charge sector:

The charge sector is essentially the same as the CSGL action in BLQH. Using the constraint  $a_t = \frac{2\pi\delta\rho^+}{q}$ , neglecting vortex excitations in the ground state and integrating out  $\delta\rho^+$  leads to the effective action of  $\theta_+$ :

$$\mathcal{L}_c = \frac{1}{8} \theta_+(-\vec{q}, -\omega) \left[ \frac{\omega^2 + \omega_q^2}{V_+(q) + \frac{4\pi^2 \bar{\rho}}{m} \frac{1}{q^2}} \right] \theta_+(\vec{q}, \omega) \quad (26)$$

where  $\omega_q^2 = \omega_c^2 + \frac{\bar{\rho}}{m} q^2 V_+(q)$  and  $\omega_c = \frac{2\pi\bar{\rho}}{m}$  is the cyclotron frequency.

From Eqn.26, we can find the equal time correlator of  $\theta_+$ :

$$\begin{aligned} \langle e^{i(\theta_+(\vec{x}) - \theta_+(\vec{y}))} \rangle = & \frac{1}{|x - y|^2} \end{aligned} \quad (28)$$

Note that if we define  $\tilde{\theta}_+ = \frac{\theta_1 + \theta_2}{2} = \theta_+/2$ , then  $\langle e^{i(\tilde{\theta}_+(\vec{x}) - \tilde{\theta}_+(\vec{y}))} \rangle = \frac{1}{|x - y|^{1/2}}$  which takes exactly the same form as that in  $\nu = 1$  SLQH. However, when considering vortex excitations to be discussed in the following  $e^{i\tilde{\theta}_+(\vec{x})}$  may not be single valued, therefore the fundamental angle variable is  $\theta_+$  instead of  $\tilde{\theta}_+$ .

#### (2) Spin-wave excitation:

While the spin sector has a neutral gapless mode. Integrating out  $\delta\rho^-$  leads to

$$\mathcal{L}_s = \frac{1}{2V_-(\vec{q})} \left( \frac{1}{2} \partial_\tau \theta^- \right)^2 + \frac{\bar{\rho}}{2m} \left( \frac{1}{2} \nabla \theta_- \right)^2 \quad (29)$$

where the dispersion relation of spin wave can be extracted:

$$\omega^2 = \left[ \frac{\bar{\rho}}{m} V_-(\vec{q}) \right] q^2 = v^2(q) q^2 \quad (30)$$

In the long wavelength limit:

$$V_-(\vec{q}) = \frac{\pi e^2}{\epsilon} \left( d - \frac{1}{2} d^2 q + \frac{1}{6} d^3 q^2 + \dots \right), \quad qd \ll 1 \quad (31)$$

The spin wave velocity is:

$$v_0^2 = v^2(q=0) = \frac{\bar{\rho}}{m} \frac{\pi e^2}{\epsilon} d = \frac{e^2}{m\epsilon} \sqrt{\frac{\pi\bar{\rho}}{2}} \frac{d}{l} \quad (32)$$

Eqn.32 shows that the spin wave velocity should increase as  $\sqrt{d}$  when  $d < d_c$ . At  $d = 0$ ,  $v = 0$ . This is expected, because at  $d = 0$  the  $U(1)_G$  symmetry is

enlarged to  $SU(2)_G$ , the spin wave of isotropic ferromagnet  $\omega \sim k^2$ . By plugging the experimental parameters  $m \sim 0.07m_e$  which is the band mass of  $GaAs$ ,  $\bar{\rho} = 5.2 \times 10^{10} \text{cm}^{-2}$ ,  $d/l = 1.61$ ,  $\epsilon = 12.6$  into Eqn.32, we find that  $v \sim 1.14 \times 10^7 \text{cm/s}$ . This value is about 8 times larger than the experimental value. Although Quantum fluctuations will renormalize down the spin stiffness from  $\rho_{bare} = \bar{\rho}$  to  $\rho_{eff} < \bar{\rho}$ , it is known that CSLG theory can not give precise numerical values on energy gaps even in SLQH. In fact, the spin stiffness  $\rho_s$  which is defined as  $\frac{\rho_s}{2}(\nabla\theta_-)^2$  in Eqn.29 should be determined by the inter-layer Coulomb interaction instead of being dependent of the band mass  $m$ .

### (3) Topological excitations:

Any topological excitations are characterized by two winding numbers  $\Delta\theta_1 = 2\pi m_1, \Delta\theta_2 = 2\pi m_2$ , or equivalently,  $\Delta\theta_+ = 2\pi(m_1 + m_2) = 2\pi m_+, \Delta\theta_- = 2\pi(m_1 - m_2) = 2\pi m_-$ . It is important to realize that the two fundamental angles are  $\theta_1, \theta_2$  instead of  $\theta_+, \theta_-$ .  $m_1, m_2$  are two independent integers, while  $m_+, m_-$  are not, because  $m_+ - m_- = 2m_2$  which has to be an even integer.

There are following 4 kinds of topological excitations:  $\Delta\theta_1 = \pm 2\pi, \Delta\theta_2 = 0$  or  $\Delta\theta_1 = 0, \Delta\theta_2 = \pm 2\pi$ . Namely  $(m_1, m_2) = (\pm 1, 0)$  or  $(m_1, m_2) = (0, \pm 1)$ . They correspond to inserting one flux quantum in layer 1 or 2, in the same or opposite direction as the external magnetic field. Let's classify all the topological excitations in terms of  $(q, m_-)$  where charge  $q$  is the fractional charge of the topological excitations in the following table.

$(m_1, m_2)$	(1, 0)	(-1, 0)	(0, 1)	(0, -1)
$m_-$	1	-1	-1	1
$m_+$	1	-1	1	-1
$q$	1/2	-1/2	1/2	-1/2

Table 1: The fractional charge in the balanced case

The fractional charges in Table 1 were determined from the constraint  $\nabla \times \vec{a} = 2\pi\delta\rho$  and the finiteness of the energy in the charge sector:

$$q = \frac{1}{2\pi} \oint \vec{a} \cdot d\vec{l} = \frac{1}{2\pi} \times \frac{1}{2} \oint \nabla\theta^+ \cdot d\vec{l} = \frac{1}{2} m_+ \quad (33)$$

$m_- = \pm 1$  gives the vorticities which lead to logarithmic interaction between the merons, while  $q = \pm 1/2$  lead to  $1/r$  interaction. Therefore merons are confined into the following two possible pairs at low temperature. (1) Charge neutral pairs:  $(\pm 1/2, \pm 1)$  or  $(\pm 1/2, \mp 1)$ . The NGM will turn into charge neutral pairs at large wavevectors ( or short distance ). The pair behaves as a boson. (2) Charge 1 pair  $(1/2, \pm 1)$  or charge -1 pair  $(-1/2, \pm 1)$ . The pair behaves as a fermion. They are the lowest charged excitations in BLQH and the main dissipation sources for the charge transports. A duality transformation ( See Eqn.42 ) can be easily performed to express low energy physics in terms of the dynamics of these topological excitations. There is a possible Kosterlitz-Thouless (KT) transition above which the meron pairs are liberated into free meron.

The MCF picture in the last section points to two interesting possibilities (1) There maybe Charge neutral bosonic excitations with  $(0, \pm 1)$ : Note that  $m_+ = 0$  implies  $m_1 = -m_2 = m$  and  $m_- = 2m$ . For  $m = 1$ , it corresponds to inserting one flux quantum in layer 1 in one direction and one flux quantum in layer 2 in the opposite direction. So only  $(0, \pm 2)$  exist, while  $(0, \pm 1)$  do not exist. (2) There may be deconfined ( or free )  $1/2$  charged excitations. Because any excitations with non-vanishing  $m_-$  will be confined, so any deconfined excitations must have  $m_- = 0$  which implies  $m_1 = m_2 = m$  and  $m_+ = 2m$ . We find the charge  $q = \frac{1}{2}m_+ = m$  must be an integer. This proof rigorously rules out the possibility of the existence of deconfined fractional charges. We conclude that *any deconfined charge must be an integral charge*.  $m_1 = m_2 = 1$  corresponds to inserting one flux quantum through both layers which is conventional charge 1 excitation. Splitting the two fluxes will turn into a meron pair with the same charge.

### (4) Comparison with the LLL+HF approach

It is constructive to compare the spin ( - ) sector of Eqn.25 with the EPQHF Hamiltonian achieved by the microscopic LLL+HF approach in<sup>12</sup>:

$$\begin{aligned} \mathcal{L} = & i\frac{\rho}{2}\vec{A}(\vec{m}) \cdot \partial_\tau \vec{m} + \beta_m(m_z)^2 - Cqm_z(-\vec{q})m_z(\vec{q}) \\ & + \frac{\rho_A}{2}(\nabla m_z)^2 + \frac{\rho_E}{2}[(\nabla m_x)^2 + (\nabla m_y)^2] \end{aligned} \quad (34)$$

where  $\nabla_{\vec{m}} \times \vec{A} = \vec{m}$ ,  $\beta_m \sim d^2$ ,  $C = \frac{e^2 d^2}{16\pi\epsilon}$ ,  $\rho_A = \frac{e^2}{16\pi\epsilon l} \int_0^\infty dx x^2 \exp(-x^2/2) = \frac{e^2}{16\sqrt{2\pi}\epsilon l}$  is determined by the intralayer interaction and  $\rho_E = \frac{e^2}{16\pi\epsilon l} \int_0^\infty dx x^2 \exp(-x^2/2 - dx/l)$  is determined by the interlayer interaction. Note that all these numbers are achieved by assuming that the ground state wavefunction is Halperin's 111 wavefunction even at finite  $d$ . However as shown in<sup>39,65</sup>, the wavefunction at any finite  $d$  is *qualitatively* different from Halperin's (111) wavefunction which is good only at  $d = 0$ . So the numbers calculated by the LLL+HF based on (111) wavefunctions may not even have qualitatively correct distance dependence.

In the above equation, the first term is the Berry phase term, the second term is the mass ( or capacitance ) term, this term leads to the easy-plane anisotropy which suppresses the relative density fluctuations between the two layers, the third term is nonanalytic in the wave vector due to the long range nature of the Coulomb interaction, the fourth term is the spin stiffness term for  $m_z$  and the fifth term is the spin stiffness term for easy-plane. At  $d = 0$ ,  $\beta_m = C = 0, \rho_A = \rho_E = \frac{e^2}{16\sqrt{2\pi}\epsilon l}$ , then  $\mathcal{L}$  in Eqn.34 reduces to the  $SU(2)$  symmetric QH ferromagnet as it should be. Note that the value of  $\rho_A = \rho_E$  at  $d = 0$  is exact, because the ground state wavefunction is exactly the Halperin (111) wavefunction, while at any finite  $d$ , the estimates of  $\rho_A \neq \rho_E$  by HF approximation may be crude, because we still do not know what is the exact groundstate wavefunction which may be qualitatively different from the (111) wavefunction<sup>12,39</sup>. In the

presence of the easy-plane ( $\beta_m$ ) term,  $C$  and  $\rho_A$  terms are subleading, therefore, can be dropped in the long wavelength limit. However, they are still very important if there is a instability happening at finite wavevector as shown in section III-B.

If taking the symmetry breaking direction to be along the  $\hat{x}$  direction, we can write  $m_x = \sqrt{1 - m_z^2} \cos \theta$ ,  $m_y = \sqrt{1 - m_z^2} \sin \theta$ ,  $m_z$  with  $m_z \sim 0$ ,  $\theta \sim 0$ . Substituting the parameterizations into the Berry phase term in Eqn.34, we find the Berry phase term to be  $i\frac{\rho}{4}m_z\partial_\tau\theta$ , if identifying  $m_z = 2\delta\rho_-$ , it is the same as the linear derivative ( $\frac{1}{2}\delta\rho_-\partial_\tau\theta^-$ ) term in the spin sector of Eqn.25. However, we can see the leading term in Eqn.31 which leads to the capacitive term is  $\sim d$ , but in Eqn.34, it is  $\sim d^2$ , while the Monte-Carlo simulation in spherical geometry in<sup>39</sup> indicates it is  $\sim d$ . The subleading term in Eqn.31 is non-analytic  $\sim q$  instead of  $\sim q^2$ , this is due to the long-range behavior of the Coulomb interaction. This non-analytic term is the same as that in Eqn.34 if identifying  $m_z = 2\delta\rho_-$ . The third term in Eqn.31 leads to a  $(\nabla m_z)^2$  term with a coefficient  $\sim d^3$ , while the coefficient of  $(\nabla m_z)^2$  term in Eqn.34 is  $\rho_A$  which approaches the constant  $\frac{e^2}{16\sqrt{2\pi}\epsilon l}$  as  $d \rightarrow 0$  as dictated by  $SU(2)$  symmetry at  $d = 0$ . The difficulty to recover  $SU(2)$  symmetric limit at  $d = 0$  from the CB approach is due to that the decomposition Eqn.20 in our CB approach takes advantage of the easy-plane anisotropy from the very beginning. This is similar to Abelian bosonization versus Non-Abelian bosonization in one dimensional Luttinger liquid or multi-channel Kondo model<sup>40</sup>. The last ( $\rho_E$ ) term in Eqn.34 becomes  $\frac{\rho_E}{2}(\nabla\theta)^2$ .

By this detailed comparison between the CB approach and the microscopic LLL+HF approach, we find that the two approaches lead to exactly the same functional form in the spin sector, some coefficients such as the *Berry phase* term and the *non-analytic term* are the same, while some other coefficients such as the easy-plane term and spin stiffness term are not. Unfortunately, it is very difficult to incorporate the LLL projection in the CB approach. As suggested in<sup>12</sup>, we should simply take some coefficients in CB approach as phenomenological values to be fitted into microscopic LLL+HF calculations or numerical calculations or eventually experimental data. The advantage of CB approach is that it also keeps the charge + sector explicitly, therefore treat the QH effects in the charge sector and the inter-layer phase coherence in the spin sector at the same footing. While the charge sector in the LLL+HF approach is completely integrated out.

Most of the results achieved in this subsection were achieved before<sup>2,11,12</sup> in microscopic calculations where the charge fluctuations were integrated out, the LLL projections were explicitly performed and HF approximations were made. Here, we reproduce these old results in a very simple way which keeps both spin and charge in the same footing and bring out the spin-charge connection in a very transparent way. We also classify all the

possible excitations in this effective CB approach.

In the next section, we will look at the effects of imbalance.

## B. Im-balanced case $\nu_1 \neq \nu_2$

(1) *Off-diagonal algebraic order and Spin-wave excitation:*

In the im-balanced case, the second term in Eqn.23 includes the coupling between spin sector and charge sector even when neglecting vortex excitations. Expanding this term, we find the effective action of the coupled  $\theta_+$  and  $\theta_-$  modes:

$$\begin{aligned} \mathcal{L}_c = & \frac{1}{8}\theta_+(-\vec{q}, -\omega)\left[\frac{\omega^2 + \omega_q^2}{V_+(q) + \frac{4\pi^2\bar{\rho}}{m}\frac{1}{q^2}}\right]\theta_+(\vec{q}, \omega) \\ & + \frac{1}{8}\theta_-(-\vec{q}, -\omega)\left[\frac{\omega^2}{V_-(\vec{q})} + \frac{\bar{\rho}}{m}q^2\right]\theta_-(\vec{q}, \omega) \\ & + \frac{\bar{\rho}}{4m}(\nu_1 - \nu_2)q^2\theta_-(-\vec{q}, -\omega)\theta_+(\vec{q}, \omega) \end{aligned} \quad (35)$$

where we safely dropped a linear derivative term in  $\theta_-$  in Eqn. 23 in the Interlayer Coherent QH state. However, the linear derivative term will be shown to play important role in the PSDW to be discussed in section IV.B. From Eqn.35, we can identify the three propagators:

$$\begin{aligned} \langle \theta_+\theta_+ \rangle &= \frac{(\frac{4m}{\bar{\rho}q^2})(\omega^2 + v^2q^2)\omega_q^2}{\omega^4 + \omega^2(\omega_q^2 + v^2q^2) + fv^2q^2\omega_q^2} \\ \langle \theta_-\theta_- \rangle &= \frac{4V_-(q)(\omega^2 + \omega_q^2)}{\omega^4 + \omega^2(\omega_q^2 + v^2q^2) + fv^2q^2\omega_q^2} \\ \langle \theta_+\theta_- \rangle &= \frac{-4(\nu_1 - \nu_2)V_-(q)\omega_q^2}{\omega^4 + \omega^2(\omega_q^2 + v^2q^2) + fv^2q^2\omega_q^2} \end{aligned} \quad (36)$$

where  $f = 4\nu_1\nu_2 \leq 1$ ,  $\omega_q^2 = \omega_c^2 + \frac{\bar{\rho}}{m}q^2V_+(q)$ , the cyclotron frequency  $\omega_c = \frac{2\pi\bar{\rho}}{m}$  and the spin wave velocity in the balanced case  $v^2 = v^2(q) = \frac{\bar{\rho}}{m}V_-(\vec{q})$  were defined in Eqn.30.

Performing the frequency integral of the first equation in Eqn.36 carefully, we find the *leading term* of the equal time correlator of  $\theta_+$  stays the same as the balanced case Eqn.27:

$$\langle \theta_+(-\vec{q})\theta_+(\vec{q}) \rangle = 2 \times \frac{2\pi}{q^2} + O\left(\frac{1}{q}\right) \quad (37)$$

which leads to the same algebraic order exponent 2 as in the balanced case Eqn.28.

We conclude that the algebraic order in the charge sector is independent of the imbalance. This maybe expected, because the total filling factor  $\nu_T = 1$  stays the same.

In the  $q, \omega \rightarrow 0$  limit, we can extract the leading terms of the  $\theta_-\theta_-$  propagator:

$$\langle \theta_-\theta_- \rangle = \frac{4V_-(q)}{\omega^2 + fv_0^2q^2} \quad (38)$$

where  $v_0^2 = v^2(q=0)$  and we can identify the spin wave velocity in the im-balanced case:

$$v_{im}^2 = fv_0^2 = 4\nu_1\nu_2v_0^2 = 4\nu_1(1-\nu_2)v_0^2 \quad (39)$$

which shows that the spin-wave velocity attains its maximum at the balanced case and decreases parabolically as the im-balance increases. The corresponding KT transition temperature  $T_{KT}$  also decreases parabolically as the im-balance increases.

Similarly, in the  $q, \omega \rightarrow 0$  limit, we can extract the leading terms in the  $\theta_+\theta_-$  propagator:

$$\langle \theta_+\theta_- \rangle = \frac{-4V_-(q)(\nu_1 - \nu_2)}{\omega^2 + fv^2q^2} = -(\nu_1 - \nu_2) \langle \theta_-\theta_- \rangle \quad (40)$$

which shows that the behavior of  $\langle \theta_+\theta_- \rangle$  is dictated by that of  $\langle \theta_-\theta_- \rangle$  instead of  $\langle \theta_+\theta_+ \rangle$ .

When the vortex excitations to be discussed in the following are included, the spin wave velocity will be renormalized down. As analyzed in detail in the last subsection, it is hard to incorporate the Lowest Landau Level (LLL) projection in the CB approach, so the spin wave velocity can only taken as a phenomenological parameter to be fitted to the microscopic LLL calculations or experiments, its precise dependence on imbalance can only be determined by experiments.

### (2) Topological excitations

There are following 4 kinds of topological excitations:  $\Delta\theta_1 = \pm 2\pi, \Delta\theta_2 = 0$  or  $\Delta\theta_1 = 0, \Delta\theta_2 = \pm 2\pi$ . Namely  $(m_1, m_2) = (\pm 1, 0)$  or  $(m_1, m_2) = (0, \pm 1)$ . We can classify all the possible topological excitations in terms of  $(q, m_-)$  in the following table.

$(m_1, m_2)$	$(1, 0)$	$(-1, 0)$	$(0, 1)$	$(0, -1)$
$m_-$	1	-1	-1	1
$m_+$	1	-1	1	-1
$q$	$\nu_1$	$-\nu_1$	$\nu_2$	$-\nu_2$

Table 2: The fractional charge in im-balanced case

The fractional charges in table 2 were determined from the constraint  $\nabla \times \vec{a} = 2\pi\delta\rho$  and the finiteness of the energy in the charge sector:

$$q = \frac{1}{2\pi} \oint \vec{a} \cdot d\vec{l} = \frac{1}{2\pi} \times \frac{1}{2} \oint [\nabla\theta^+ + (\nu_1 - \nu_2)\nabla\theta^-] \cdot d\vec{l} = \frac{1}{2} [m_+ + (\nu_1 - \nu_2)m_-] \quad (41)$$

In contrast to the balanced case where  $q$  only depends on  $m_+$ ,  $q$  depends on  $m_+, m_-$  and the filling factors  $\nu_1, \nu_2$ . Just like in balance case, any deconfined excitations with  $(m_- = 0, m_+ = 2m)$  have charges  $q = \frac{1}{2}m_+ = m$  which must be integers. While the charge of  $(m_+ = 0, m_- = 2m)$  is  $q = (\nu_1 - \nu_2)m$  which is charge neutral only at the balanced case.

The merons listed in table 2 are confined into the following two possible pairs at low temperature. (1) Charge neutral pairs:  $(\pm\nu_1, \pm 1)$  or  $(\pm\nu_2, \mp 1)$ . They behave as

bosons. The NGM will turn into charge neutral pairs at large wavevectors. (2) Charge 1 pair  $(\nu_1, 1) + (\nu_2, -1)$  or charge  $-1$  pair  $(-\nu_1, -1) + (-\nu_2, 1)$ . They behave as fermions. They are the lowest charged excitations in BLQH and the main dissipation sources for the charge transports.

In appendix A, we will calculate the meron fractional charges from its trial wavefunction and find they are the same as those listed in table 2.

### (3) Dual action

A duality transformation can be easily performed to express low energy physics in terms of the dynamics of these topological excitations. Performing the duality transformation on Eqn.23 leads to the dual action in terms of the vortex degree of freedoms  $J_\mu^{v\pm} = \frac{1}{2\pi}\epsilon_{\mu\nu\lambda}\partial_\mu\partial_\nu\theta_\pm = J_\mu^{v1} \pm J_\mu^{v2}$  and the corresponding dual gauge fields  $b_\mu^\pm$ :

$$\begin{aligned} \mathcal{L}_d = & -i\pi b_\mu^+ \epsilon_{\mu\nu\lambda} \partial_\nu b_\lambda^+ - iA_{s\mu}^+ \epsilon_{\mu\nu\lambda} \partial_\nu b_\lambda^+ + i\pi b_\mu^+ J_\mu^{v+} \\ & + \frac{m}{2\rho f} (\partial_\alpha b_0^+ - \partial_0 b_\alpha^+)^2 + \frac{1}{2} (\nabla \times \vec{b}^+) V_+(\vec{q}) (\nabla \times \vec{b}^+) \\ & - iA_{s\mu}^- \epsilon_{\mu\nu\lambda} \partial_\nu b_\lambda^- + i\pi b_\mu^- J_\mu^{v-} - h_z (\nabla \times \vec{b}^-) \\ & + \frac{m}{2\rho f} (\partial_\alpha b_0^- - \partial_0 b_\alpha^-)^2 + \frac{1}{2} (\nabla \times \vec{b}^-) V_-(\vec{q}) (\nabla \times \vec{b}^-) \\ & - \frac{m}{\rho f} (\nu_1 - \nu_2) (\partial_\beta b_0^- - \partial_0 b_\beta^-) (\partial_\beta b_0^+ - \partial_0 b_\beta^+) \quad (42) \end{aligned}$$

where  $A_{s\mu}^\pm = A_{s\mu}^1 \pm A_{s\mu}^2$  are the two source fields. The  $+$  sector stands for the charge sector which is essentially the same as SLQH. While the spin ( $-$ ) sector of this dual action takes similar form as a 3D superconductor in an external magnetic field  $h_z$  shown in Eqn.63. The last term which stands for the coupling between the charge and the spin sector can be shown to be irrelevant in the ILCQH state. The spin wave velocity in Eqn.39 can also be easily extracted from this dual action. This dual action was used to derive the ground state, quasi-hole and a pair of quasi-hole wavefunctions in<sup>65</sup>.

It is constructive to compare this dual action derived from the CB approach with the action derived from MCF approach Eqn.8. We find the following three differences: (1) The topological vortex degree of freedoms  $J_\mu^{v\pm}$  are missing in Eqn.8. These vortex degree of freedoms are needed to make the variable  $\phi$  in Eqn.10 to be an angle variable  $0 < \phi < 2\pi$ . (2) The  $\chi_+, \chi_-$  terms in Eqn.8 are extra spurious terms. These extra spurious terms break  $SU(2)$  symmetry even in the  $d \rightarrow 0$  limit. (3) The linear term  $-h_z(\nabla \times \vec{b}^-)$  is missing in Eqn.8. This linear term is not important in the interlayer coherent excitonic superfluid state, but it is very important in the in-coherent excitonic solid state to be discussed in the following subsection. Indeed, if we drop all the  $\chi_+, \chi_-$  terms, use bare mass and also add the topological vortex currents and the linear term by hands in Eqn.8, then Eqn.8 will be identical to Eqn. 42. We conclude that Eqn. 23 and 42 from CB approach are the correct and complete effective actions.

#### (4) Energy of a meron pair

We can also look at the static energy of a charge 1 meron pair consisting a meron with charge  $\nu_1$  and charge  $\nu_2$  separated by a distance  $R$ :

$$E_{mp} = E_{1c} + E_{2c} + \frac{\nu_1\nu_2 e^2}{R} + 2\pi f\rho_{s0} \ln \frac{R}{R_c} \quad (43)$$

where  $E_{1c}, E_{2c}$  are the core energies of meron 1 ( charge  $\nu_1$  ) and meron 2 ( charge  $\nu_2$  ) respectively,  $R_c$  is the core size of an isolated meron,  $\rho_{s0} = \frac{\bar{\rho}}{8m}$  is the spin stiffness at the balanced case.

Minimizing  $E_{mp}$  with respect to  $R$  leads to an optimal separation:  $R_o = \frac{e^2}{8\pi\rho_{s0}}$  which is independent of the imbalance. Namely, the optimal separation of a meron pair remains the same as one tunes the imbalance. Plugging  $R_o$  into Eqn.43 leads to the optimal energy of a meron pair:

$$E_o = E_{1c} + E_{2c} + \nu_1(1 - \nu_1)\left(\frac{e^2}{R_o} + 8\pi\rho_{s0} \ln \frac{R_o}{R_c}\right) \quad (44)$$

Because of logarithmic dependence on  $R_c$ , we can neglect the  $\nu_1$  dependence in  $R_c$ , then the second term in Eqn.44 decreases parabolically as im-balance increases. Unfortunately, it is hard to know the  $\nu_1$  dependence of  $E_{1c}, E_{2c}$  and  $R_c$  from an effective theory, so the dependence of the energy gap  $E_o$  on  $\nu_1$  is still unknown.

### C. Interlayer tunneling

Note that in contrast to MCF, the same phase factor appears in the singular gauge transformation Eqn.18 for the two layers  $a = 1, 2$  which get canceled exactly in  $H_t$ :

$$\begin{aligned} H_t &= t\phi_1^\dagger(\vec{x})\phi_2(\vec{x}) + h.c. = 2t\sqrt{\bar{\rho}_1\bar{\rho}_2} \cos(\theta_1 - \theta_2) \\ &= 2t\bar{\rho}\sqrt{\nu_1\nu_2} \cos\theta_- \end{aligned} \quad (45)$$

where the exciton operator is  $c_1^\dagger c_2 = \phi_1^\dagger \phi_2 = \bar{\rho}\sqrt{\nu_1\nu_2}e^{i\theta_-} \sim \psi_-$ .

In the presence of in-plane magnetic field  $B_{||} = (B_x, B_y)$ , the effective Lagrangian is:

$$\begin{aligned} \mathcal{L}_s &= \frac{1}{2V_-(\bar{q})} \left(\frac{1}{2}\partial_\tau\theta^- + ih_z\right)^2 + \frac{\bar{\rho}}{2m}\nu_1\nu_2(\nabla\theta_-)^2 \\ &+ 2t\bar{\rho}\sqrt{\nu_1\nu_2} \cos(\theta_- - Q_\alpha x_\alpha) \end{aligned} \quad (46)$$

where  $x_\alpha = (x, y)$ ,  $Q_\alpha = \left(-\frac{2\pi dB_y}{\phi_0}, \frac{2\pi dB_x}{\phi_0}\right)$ .

In balanced case, it was found that when the applied in-plane magnetic field is larger than a critical field  $B > B_{||}^* \sim (t_0/\rho_{s0})^{1/2}$ , there is a phase transition from a commensurate state to an incommensurate state with broken translational symmetry. When  $B > B_{||}^*$ , there is a finite temperature KT transition which restores the translation symmetry by means of dislocations in the domain wall structure in the incommensurate phase.

As can be seen from Eqn.46,  $\rho_s \sim \nu_1\nu_2$ , while  $t \sim \sqrt{\nu_1\nu_2}$ , so the critical field  $B_{||}^* \sim (t/\rho_s)^{1/2} \sim (\nu_1\nu_2)^{-1/4}$  increases as one tunes the im-balance.

### D. Summary

In summary of this section, the effective CB theory can be used to lead to correct algebraic off-diagonal long range order, low energy functional forms, classification of both spin wave and topological excitations. But it may not be used to get correct values of many physical measurable quantities such as spin wave velocity, its precise dependence on the imbalance and the energy of a meron pair. The EPQFM approach is a microscopic one which takes care of LLL projection from the very beginning. However, the charge sector was explicitly projected out, the connection and coupling between the charge sector which displays Fractional Quantum Hall effect and the spin sector which displays interlayer phase coherence was not obvious in this approach. While in the CB theory, it is hard to incorporate the LLL projection ( see however the attempt made in<sup>36</sup> ), some parameters can only be taken as phenomenological parameters to be fitted into the microscopic LLL+HF calculations or experimental data as discussed in section III. The two approaches are complimentary to each other. The biggest advantage of the CB approach is that it can be extended to capture competing orders even at microscopic length scales, so can also be used to describe novel phases and phase transitions as the layer distance changes to be discussed in the next section.

### IV. COMPOSITE BOSON APPROACH: PSEUDO-SPIN DENSITY WAVE STATE

The discussions in the last section are in the homogeneous exciton superfluid state, now we will study the instability of this ESF state as the distance is increased. As stated in the introduction, when the distance is smaller than  $d_{c1}$ , the system is in the ESF state, while it is sufficiently large, the system becomes two weakly coupled  $\nu = 1/2$  Composite Fermion Fermi Liquid (FL) state. There could be a direct first order transition between the two states. However, the experimental observations that both zero voltage tunneling peak<sup>4</sup> and the Hall drag resistivity<sup>5</sup> develop very gradually when  $d \sim d_{c1}$  suggest the transition at  $d = d_{c1}$  is a 2nd order phase transition. Although there are very little dissipations in both the ESF and FL, the experiment<sup>20</sup> discovered strong enhancement of drag and dissipations in an intermediate distance regime. These experimental observations suggest that there must be intermediate phases between the two phases. In this section, we will study the nature of the intermediate phase.

In this section, by combining the composite boson method developed in the last section with the Ginzburg-Landau theory developed in<sup>28</sup>, we explore the similarity between the <sup>4</sup>He system and the BLQH step by step. In the dual *density* representation of Eqn.21, we propose a Pseudo-spin density wave ( PSDW ) state which breaks translational symmetry as the candidate of the intermedi-

ate phase. We also construct a novel effective Ginzburg-Landau theory to study the novel transition from the ESF to the PSDW. Inspired by recent possible discovery of supersolid in  ${}^4\text{He}$ <sup>23,24,28</sup>, we also discuss important physical consequences of quantum fluctuation generated vacancies in the PSDW state. Just like in the last section, we study the balanced case first, then the effects of imbalance.

### A. Balanced case

#### (1) Collapsing of magneto-roton minimum

As shown in III-A-4, the spin stiffness  $\frac{\bar{p}}{2m}$  and the  $V_-(q)$  in Eqn.29 should be replaced by the effective ones calculated by the LLL+HF approximation:  $\rho_E$  and  $V_E(q)$ .

$$\mathcal{L}_s = \frac{1}{2V_E(\vec{q})} \left( \frac{1}{2} \partial_\tau \theta^- \right)^2 + \rho_E \left( \frac{1}{2} \nabla \theta^- \right)^2 \quad (47)$$

where  $V_E(q) = a - bq + cq^2$ ,  $a, b, c > 0$ ,  $a \sim d^2$ ,  $b \sim d^2$ , but  $c$  remains a constant at small distances<sup>42</sup>. As explained in the last subsection, the non-analytic term is due to the long-range Coulomb interaction which survives the LLL projection.

In order to study the instability of the ESF to the formation of PSDW, one need to write the dispersion relation Eqn.30 to include higher orders of momentum:

$$\omega^2 = [2\rho_E V_E(\vec{q})]q^2 = q^2(a - bq + cq^2) \quad (48)$$

As shown in<sup>28</sup>, the advantage to extend the dispersion relation beyond the leading order is that the QGL action can even capture possible phase transitions between competing orders due to competing interactions on microscopic length scales. As explained in the last section, in the LLL-HF approach in<sup>12</sup>, these coefficients were found to be  $a \sim d^2$ ,  $b \sim d^2$ , but  $c$  remains a constant at small distances. By looking at the two conditions  $\omega^2|_{q=q_0} = 0$  and  $\frac{d\omega^2}{dq}|_{q=q_0} = 0$ , it can be shown that the dispersion curve Eqn.48 indeed has the shape shown in Fig.5a. When  $b \sim d^2 < b_c = 2\sqrt{ac} \sim d$ , the magneto-roton minimum has a gap at  $q = q_0 = \sqrt{a/c} \sim d$ , the system in the ESF state, this is always the case when the distance  $d$  is sufficiently small ( Fig.4). However, when  $b = b_c$ , the magneto-roton minimum collapses at  $q = q_0$  which signifies the instability of the ESF to some density wave formation as shown in<sup>28</sup>. When  $b \sim d^2 > b_c = 2\sqrt{ac} \sim d$ , the minimum drops to negative and is replaced by the stable density wave formation, the system gets to the PSDW state, this is always the case when the distance  $d$  is sufficiently large ( Fig.4).

The phenomenon of the collapsing of the magneto-roton minimum as the distance increases was also seen in the numerical calculations in the LLL+HF approaches<sup>56</sup>. It was estimated that  $q_0 l \sim 1$ , so the lattice constant of

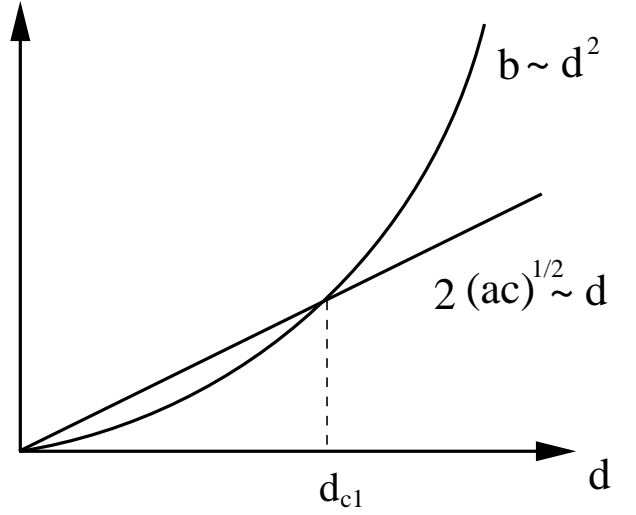

FIG. 4: The critical distance  $d_{c1}$ .

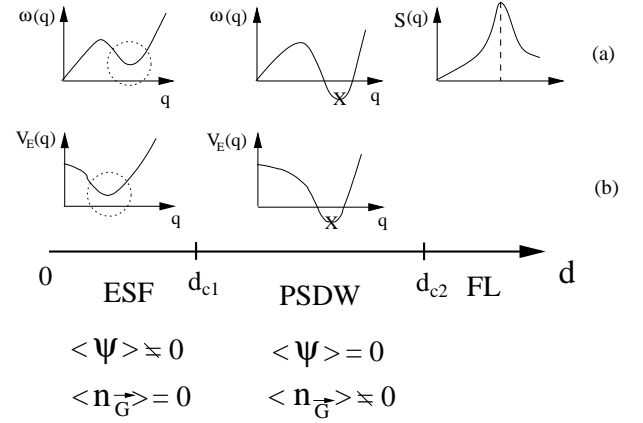

FIG. 5: The zero temperature phase diagram in the balanced case as the distance between the two layers increases. ESF where  $\langle \psi \rangle \neq 0$ ,  $\langle n_{\vec{G}} \rangle = 0$  stands for excitonic superfluid, PSDW where  $\langle \psi \rangle = 0$ ,  $\langle n_{\vec{G}} \rangle \neq 0$  stands for pseudo-spin density wave phase, FL stands for Fermi Liquid. (a) Energy dispersion relation  $\omega(q)$  in these phases. (b)  $V_E(q)$  in these phases. The cross in the PSDW means the negative minimum value of  $V_E(q)$  is replaced by the PSDW. The order parameters are also shown. In fact, the instability happens before the minimum touches zero.

the PSDW is of the same order of magnetic length  $l$  which is  $\sim 100\text{\AA}$ . The critical distance  $d_{c1}$  is also of the same order of the magnetic length.

#### (2) Instability in the density channel

From Eqns.25,29,30, we can see that it is the original instability in  $V_E(q) = a - bq + cq^2$  which leads to the magneto-roton minimum in the Fig.5. By looking at the two conditions  $V_E(\vec{q})|_{q=q_0} = 0$  and  $\frac{dV_E(\vec{q})}{dq}|_{q=q_0} = 0$ , it is easy to see that  $V_E(q)$  indeed has the shape shown in Fig.5b. When  $b \sim d^2 < b_c = 2\sqrt{ac} \sim d$ , the minimum of  $V_E(q)$  at  $q = q_0 = \sqrt{a/c} \sim d$  has a gap, the system is in

the ESF state, this is always the case when the distance  $d$  is sufficiently small. However, when  $b = b_c$ , the minimum collapses and  $S(q)$  diverges at  $q = q_0$  ( Fig.5a), which signifies the instability of the ESF to an exciton normal solid (PSDW) formation. When  $b \sim d^2 > b_c = 2\sqrt{ac} \sim d$ , the minimum drops to negative, the system gets to the PSDW state, this is always the case when the distance  $d$  is sufficiently large. These conditions are essentially the same as those achieved by looking at the dispersion relation  $\omega$  in Fig.5a.

(3) *Effective action in the dual density representation*

In Eqn.29,  $\delta\rho_-$  was integrated out in favor of the phase field  $\theta_-$ . Because the original instability comes from the density-density interaction, it is important to do the opposite: integrating out the phase field in favor of the density operator in the original action Eqn.25. Neglecting the vortex excitations in  $\theta_-$  and integrating out the  $\theta_-$  in Eqn.47 leads to:

$$\mathcal{L}[\delta\rho_-] = \frac{1}{2}\delta\rho^-(-\vec{q}, -\omega_n)\left[\frac{\omega_n^2}{2\rho_E q^2} + V_E(\vec{q})\right]\delta\rho^-(\vec{q}, \omega_n) \quad (49)$$

where we can identify the dynamic pseudo-spin density-density correlation function:

$$S_-(\vec{q}, \omega_n) = \langle \delta\rho^-(-\vec{q}, -\omega_n)\delta\rho^-(\vec{q}, \omega_n) \rangle = \frac{2\rho_E q^2}{\omega_n^2 + v^2(q)q^2} \quad (50)$$

where  $v^2(q) = 2\rho_E V_E(q)$  is the spin wave velocity defined in Eqn.30.

From the pole of the dynamic density-density correlation function, we can identify the speed of sound wave which is exactly the same as the spin wave velocity. This should not be too surprising. As shown in liquid  ${}^4\text{He}$ , the speed of sound is exactly the same as the phonon velocity. Here, in the context of excitonic superfluid, we explicitly prove that the sound speed is indeed the same as the spin wave velocity.

From the analytical continuation  $i\omega_n \rightarrow \omega + i\delta$  in Eqn.50, we can identify the dynamic structure factor:  $S_-(\vec{q}, \omega) = S_-(q)\delta(\omega - v(q)q)$  where  $S_-(q) = \rho_E q\pi/v(q)$  is the equal time pseudo-spin correlation function shown in Fig.5a. As  $q \rightarrow 0$ ,  $S_-(q) \rightarrow q$ . The *Feymann relation* in BLQH which relates the dispersion relation to the equal time structure factor is

$$\omega(q) = \frac{\rho_E \pi q^2}{S_-(q)} \quad (51)$$

which takes exactly the same form as the Feymann relation in superfluid  ${}^4\text{He}$ . Obviously, the  $V_E(q)$  in the Fig.5b leads to the magneto-roton dispersion  $\omega^2 = q^2 V_E(q)$  in the Fig.5a.

Because the instability happens near  $q = q_0$  instead of  $q = 0$ , so the transition in Fig5 is *not* driven by vortex unbinding transitions like in 3D XY model, so the vortices remain tightly bound near the transition<sup>45</sup>. So integrating out the vortex excitations in  $\theta_-$  will only generate

*weak* interactions among the pseudo-spin density  $\delta\rho_-$ :

$$\begin{aligned} \mathcal{L}[\delta\rho_-] &= \frac{1}{2}\delta\rho^-(-\vec{q}, -\omega)\left[\frac{\omega_n^2}{2\rho_E q^2} + V_E(\vec{q})\right]\delta\rho^-(\vec{q}, \omega) \\ &+ u(\delta\rho_-)^4 + w(\delta\rho_-)^6 + \dots \end{aligned} \quad (52)$$

where the momentum and frequency conservation in the quartic and sixth order term is assumed.

In sharp contrast to the conventional classical normal liquid (NL) to normal solid (NS) transition<sup>49</sup>, the possible cubic interaction term  $(\delta\rho_-)^3$  is forbidden by the  $Z_2$  exchange symmetry between the two layers  $\delta\rho_- \rightarrow -\delta\rho_-$ . Note that the  $(\omega_n/q)^2$  term in the first term stands for the quantum fluctuations of  $\delta\rho_-$  which is absent in the classical NL to NS transition. The density representation Eqn.52 is dual to the phase representation Eqn.29. However, the phase representation Eqn.29 contains explicitly the superfluid order parameter  $\psi_- \sim e^{i\theta_-}$  which can be used to characterize the superfluid order in the ESF phase. All the results in the ESF state are achieved from phase representation in the last section. While in Eqn.52, the only signature of the superfluid phonon mode is encoded in the density sound mode, because the order parameter  $\psi_-$  is integrated out, the superfluid order is hidden, so it is not as powerful as the phase representation in describing the ESF state. However, as shown in the following, when describing the transition from the ESF to the PSDW, the density representation Eqn.53 has a big advantage over the phase representation.

Expanding  $V_E(q)$  near the minimum  $q_0$  in the Fig. 3 leads Eqn.52 to the quantum Ginsburg-Landau action to describe the ESF to the PSDW transition:

$$\begin{aligned} \mathcal{L}[\delta\rho_-] &= \frac{1}{2}\delta\rho^- [A_\rho \omega_n^2 + r + c(q^2 - q_0^2)^2] \delta\rho^- \\ &+ u(\delta\rho_-)^4 + w(\delta\rho_-)^6 + \dots \end{aligned} \quad (53)$$

where  $A_\rho \sim \frac{1}{2\rho_E q_0^2}$  which is non-critical across the transition.

Because near  $q_0$ , the coefficient  $A_\rho$  of  $\omega_n^2$  in Eqn.53 is a constant in the density representation, while the corresponding quantity  $A_\theta \sim S_-(q)$  in the phase representation Eqn.47 is divergent, so Eqn.47 breaks down as  $q \rightarrow q_0^-$  and may not be used to describe the ESF to the PSDW transition.

It is constructive to compare the QGL Eqn.53 to describe the ESF to the PSDW in 2+1 dimensional BLQH with that in 3+1 dimensional  ${}^4\text{He}$  to describe the superfluid to normal solid transition<sup>28</sup>:

$$\begin{aligned} \mathcal{L}[\delta n] &= \frac{1}{2}\delta n [A_n \omega_n^2 + r + c(q^2 - q_0^2)^2] \delta n \\ &- w(\delta n)^3 + u(\delta n)^4 + \dots \end{aligned} \quad (54)$$

where  $r \sim p_{c1} - p$  and  $A_\rho \sim \frac{1}{\rho_s q_0^2}$  which is non-critical across the transition.

The most crucial difference between Eqn.53 and Eqn.54 is the absence of the cubic term in Eqn.53 and the presence of the cubic term in Eqn.54. As shown in the

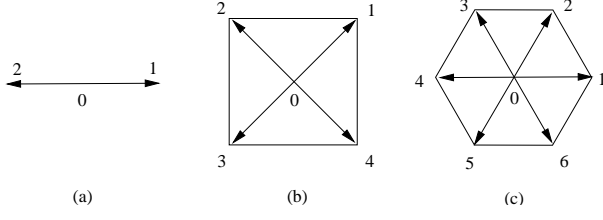

FIG. 6: 2,4,6 shortest reciprocal lattice vectors in a (a) stripe (b) square lattice (c) triangular lattice

following, this crucial difference make the lowest energy lattice structure different in the two systems. Drawing the analogy of the familiar He4 phase diagram at  $T = 0$  discussed in<sup>28</sup>, we may assume the divergence of  $S^-(q)$  at  $q = q_0$  leads to the PSDW state in the Fig.5. In Eqn.53,  $r$  is the gap of  $V_E(q)$  at the minimum which tunes the transition from the ESF to the PSDW. This is a Brazovskii type transition<sup>48</sup> described by a  $n = 1$  component  $(d + 1, d)$  quantum Lifshitz action ( with  $d = 2$  in BLQH )<sup>49</sup>. Due to the absence of the cubic term, the transition is 2nd order at mean field level. However, as shown by renormalization group analysis in<sup>28</sup>, the fluctuations will drive the transition into a 1st order transition.

#### (4) Lattice structures of the PSDW phase

In the ESF,  $r > 0$  and  $\langle \delta\rho_- \rangle = 0$  is uniform. In the PSDW,  $r < 0$  and  $\langle \delta\rho_- \rangle = \sum_{\vec{G}} n(\vec{G})e^{i\vec{G}\cdot\vec{x}}$ ,  $n(0) = 0$  takes a lattice structure. In two dimension, the most common lattices are 1d stripe embedded in two dimension, square and triangular lattices. The shortest reciprocal lattice vectors of the three lattices were shown in Fig.5 (a) and (b) and (c) respectively.

(a) P=2:  $\vec{Q}_1 = -\vec{Q}_2 = \vec{Q}$  are a pair of anti-nodal points ( Fig.6a ). They are the two shortest reciprocal lattice vectors generating a 1 dimensional lattice embedded in a 2 dimensional system. The 1d stripe will lead to transport anisotropy which was not seen in experiments, so will not be considered any more in the following.

(b) P=4:  $\vec{Q}_3 = -\vec{Q}_1, \vec{Q}_4 = -\vec{Q}_2, \vec{Q}_1 \cdot \vec{Q}_2 = 0, \vec{Q}_i, i = 1, 2, 3, 4$  form the 4 corners of a square ( Fig.6b ). They are the four shortest reciprocal lattice vectors generating a 2 dimensional square lattice.

(c) P=6.  $\vec{Q}_i, i = 1, 2, 3, 4, 5, 6$  form the 6 corners of a hexagon ( Fig.6c ). They consist of the 6 shortest reciprocal lattice vectors generating a 2 dimensional triangular lattice.

If thinking Eqn.54 as at  $2 + 1$  dimension, it can be shown that the triangular lattice ( Fig.6c ) is the favorite lattice for the normal solid. As shown in the appendix B, due to the cubic term, the triangular lattice is also the favorite lattice for the Wegner crystal (WC) in the QH to WC transition in the SLQH. However, due to the absence of the cubic term in Eqn.53, in the following, we will show that the favorite lattice is the square lattice. At mean field level, we can ignore the  $\omega$  dependence in Eqn.53. Substituting  $\langle \delta\rho_- \rangle = \sum_{\vec{G}} n(\vec{G})e^{i\vec{G}\cdot\vec{x}}$  into Eqn.53 leads

to:

$$f_n = \sum_{\vec{G}} \frac{1}{2} r_{\vec{G}} |n_{\vec{G}}|^2 + u \sum_{\vec{G}} n_{\vec{G}_1} n_{\vec{G}_2} n_{\vec{G}_3} n_{\vec{G}_4} \delta_{\vec{G}_1 + \vec{G}_2 + \vec{G}_3 + \vec{G}_4, 0} + v \sum_{\vec{G}} n_{\vec{G}_1} n_{\vec{G}_2} n_{\vec{G}_3} n_{\vec{G}_4} n_{\vec{G}_5} n_{\vec{G}_6} \delta_{\vec{G}_1 + \vec{G}_2 + \vec{G}_3 + \vec{G}_4 + \vec{G}_5 + \vec{G}_6, 0} \quad (55)$$

where  $u$  could be positive or negative,  $v > 0$  is always positive to keep the system stable.

From Eqn.55, we can compare the ground state energy of the two most commonly seen lattices: square lattice ( Fig.6b ) and triangular lattice ( Fig.6c ). Square ( triangular ) lattice has  $m = 4$  (  $m = 6$  ) shortest reciprocal lattice vectors  $G = 2\pi/a$  where  $a$  is the lattice constant in a given layer ( Fig.6 ). For the quadratic and quartic terms, all the contributions come from the paired reciprocal lattice vectors ( Fig.6b and 6c ). For the sixth order term, in square lattice, all the contributions are still from the paired reciprocal lattice vectors ( Fig.6b ), however, in triangular lattice, there is an *additional* contribution from a triangle where  $\vec{G}_1 + \vec{G}_2 + \vec{G}_3 = 0$  ( Fig.6c ). It is this *extra* contribution which make a crucial difference between the square lattice and the triangular lattice. Following<sup>49</sup>, after scaling  $n_{\vec{G}} \rightarrow m^{-1/2} n_{\vec{G}}$  to make the quadratic term the same for both lattices, then Eqn.55 is simplified to:

$$f_\alpha = \frac{1}{2} r_{\vec{G}} |n_{\vec{G}}|^2 + u_\alpha |n_{\vec{G}}|^4 + v_\alpha |n_{\vec{G}}|^6 \quad (56)$$

where  $u_\square = u_\Delta = 3u$  for both square and triangular lattice and  $v_\square = 18v, v_\Delta = 18v + 20/3v$  for square and triangular lattice respectively. Obviously . The mean field phase diagram of Eqn.56 is well known: If  $u > 0$  (  $u < 0$  ), there is 2nd ( 1st ) order transition, there is a tri-critical point at  $u = 0$ . Minimizing  $f$  with respect to  $n_{\vec{G}}$  leads to  $n_{\vec{G}} = n_\alpha = (-2u_\alpha + \sqrt{4u_\alpha^2 - 6v_\alpha t})/6v_\alpha$  which holds for both  $u_\alpha > 0$  and  $u_\alpha < 0$ . Obviously,  $n_\Delta \neq n_\square$ . From Eqn.56, we can see that because  $v_\Delta > v_\square$ , for any given  $n$ ,  $f_\square(n) < f_\Delta(n)$ , then  $f_\square(n_\square) < f_\square(n_\Delta) < f_\Delta(n_\Delta)$ , namely, *the square lattice is the favorite lattice*. So it has three elastic constants instead of two. Neglecting zero-point quantum fluctuations,  $\langle \delta\rho_- \rangle = \sum_i \delta(\vec{x} - \vec{R}_i) - \sum_i \delta(\vec{x} - \vec{R}_i - \vec{l})$  where the  $\vec{l} = \frac{1}{2}(\vec{a}_1 + \vec{a}_2)$  is the shift of the square lattice in the bottom layer relative to that in the top layer ( Fig.2).

This PSDW state not only breaks the translational symmetry, but also the  $Z_2$  exchange symmetry. It is very rare to get a 2d square lattice, because it is not a close packed lattice. Due to the special  $Z_2$  symmetry of BLQH, we show it indeed can be realized in BLQH. The system is compressible with gapless phonon excitations determined by the 3 elastic constants.

#### (5) Light scattering from the PSDW state

It is very interesting to see if soft X-ray or light scattering experiments<sup>60</sup> can directly test the existence of the PSDW when  $d_{c1} < d < d_{c2}$ . The *in-plane* light scattering intensity from the PSDW is  $I(\vec{K}) \sim |S(\vec{K})|^2$  where



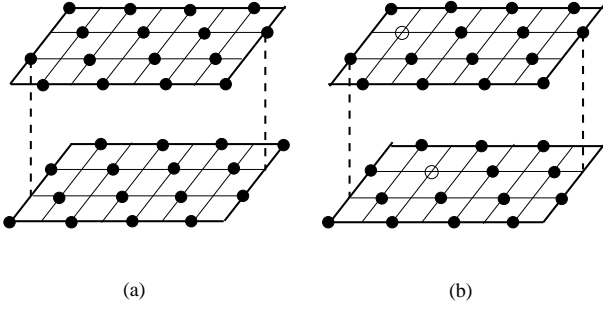

FIG. 7: (a) The charge distribution of the PSDW in a square lattice. The "up" pseudo-spins take sublattice A, while the "down" pseudo-spins take sublattice B. (b) In general, there are quantum and thermal fluctuation generated vacancies in both layers denoted by a  $\circ$ .

$S(\vec{K})$  is the structure factor and  $\vec{K} = \frac{2\pi}{a}(\vec{i} + \vec{j})$  is the 2d in-plane reciprocal lattice vector of the square PSDW. For  $\vec{l} = \frac{a}{2}(\vec{i} + \vec{j})$ ,  $S(\vec{K}) = 1 - e^{i\vec{K} \cdot \vec{l}} = 1 - (-1)^{m+n}$  which is 0 and 2 for even and odd  $m+n$  respectively. The *in-plane* light scattering experiments<sup>60</sup> probe the intralayer shift  $\vec{l}$  in the Fig.7, in principle, it can be performed in the BLQH. Note that the large zero-point quantum fluctuations may diminish the light scattering intensity by a Debye-Waller factor<sup>28</sup>.

The *out of-plane* light scattering intensity from the PSDW follows the Bragg diffraction law  $2d \sin \theta = n\lambda$  where  $\theta$  is the angle between the light ray and the 2d plane and the  $\lambda$  is the wavelength of the light. It doubles or vanishes when  $n$  is an integer or a half integer. The *out of-plane* light scattering experiments probe the interlayer distance  $d$  in the Fig.7, but it is quite difficult to perform due to several *GaAs/AlGaAs* layers above the 2d electron gas.

#### (6) Vacancies, disorders and Coulomb Drag in the PSDW state

In principle, the  $\delta\rho_+$  mode in Eqn.23 should also be included. It stands for the translational (or sliding) motion of the PSDW lattice. However, any weak disorders will pin this PSDW state to make it an insulating state (INS). The insulating state also has a charge gap which has a completely different origin than that in the QH state. Because there are charge gaps on both sides of the ESF/QH to PSDW/INS transition, it is valid to integrate out the charge  $\delta\rho_+$  sector and focus on the spin sector in studying the two phases and the transition in Fig.5. Disorders will smear the 1st order transition from the ESF to the PSDW into a 2nd order transition. It was argued in<sup>4</sup> that disorders in real samples are so strong that they may even have destroyed the ESF state, so they may also transfer the long range lattice orders of the PSDW into short range ones. This fact makes the observation of the lattice structure by light scattering difficult. Being an insulating state, the PSDW state will not show any quantized Hall plateau and any zero-bias interlayer tunneling peak. The two square lattices in the top and bottom layer are

locked together, so it will show huge Coulomb drag. However, vacancies generated by the large zero-point quantum fluctuations may play important roles in the drag ( Fig.2b ). As the distance increases to the critical distance  $d_{c1}$  in Fig.1, the ESF turns into the PSDW whose lattice constant  $a = \sqrt{4\pi}l$  is completely fixed by the filling factor  $\nu_1 = 1/2$ , so it may not completely match the instability point  $1/q_0$ . Due to this slight mismatch, the resulting PSDW is likely to be an *in-commensurate* solid where the total number of sites  $N_s$  may not be the same as the total number of sites  $N$  even at  $T = 0$ . As the distance increases further  $d_{c1} < d < d_{c2}$  in Fig.1, the PSDW lattice constant is still *locked* at  $a = \sqrt{4\pi}l$ . Assuming zero-point quantum fluctuations favor vacancies over interstitials, so there are vacancies  $n_0$  even at  $T = 0$  in each layer. At finite temperature, there are also thermally generated vacancies  $n_a(T) \sim e^{-\Delta_v/T}$  where  $\Delta_v$  is the vacancy excitation energy. So the total number of vacancies at any  $T$  is  $n_v(T) = n_0 + n_a(T)$ . Obviously, the vacancies in top layer are strongly correlated with those in the bottom layer. The drag in the weakly coupled FL regime  $d > d_{c2}$  was shown to be very small and goes like  $T^{4/3}$  at low  $T$ <sup>43</sup>. The drag in the ESF regime  $d < d_{c1}$  is also small and goes like  $e^{-\Delta_{QH}/T}$  at low  $T$ . The drags in both states are due to momentum transfer between electrons in the two layers. However, in the PSDW, the holes are hopping on the square lattice, as shown in<sup>44</sup>, the microscopic origin of the drag is due to the correlated character of hopping transports of the vacancies between the active and passive layers, it leads to a very large drag. We can estimate the resistance in the active layer as  $R \sim 1/n_v(T)$ . As shown in<sup>44</sup>, the drag resistance in the passive layer is  $R_D \sim \alpha_D R$  where  $\alpha_D$  should not be too small. This temperature dependence is indeed consistent with that found in the experiment<sup>20</sup>: starting from 200mK,  $R_D$  increases exponentially until to 50mK and then saturates. This behavior is marked different than that at both small and large distance where the system is in the ESF and FL regimes respectively. We suggest that in the presence of disorders, all the properties of the PSDW are consistent with the experimental observations in<sup>4,5,20</sup> on the intermediate phase. The effects of very small imbalance on the PSDW phase will be investigated in IV-B-3 and was found to naturally explain the small imbalance experiment in<sup>58</sup>. All these facts suggest that the intermediate phase can be identified as the PSDW.

#### (7) Finite temperature phase diagram

Due to the spontaneous translational symmetry breaking in the PSDW, there are also Goldstone modes in the spin sector which are the two lattice phonons  $\vec{u}(\vec{r})$  in 2 dimension. The translational order is characterized by  $n_{\vec{Q}_m}(\vec{r}) = e^{i\vec{Q}_m \cdot \vec{u}}$ , the orientational order is characterized by  $\psi_{or} = e^{i4\phi}$  for the square lattice where  $\phi = \frac{1}{2}\hat{z} \cdot \nabla \times \vec{u}$  ( in contrast,  $\psi_{or} = e^{i6\phi}$  for the hexagonal lattice ). It is known that at any finite temperature at  $d = 2$ , there is no true long range order except possible long-range orientational order. The square lattice has 3 elastic constants

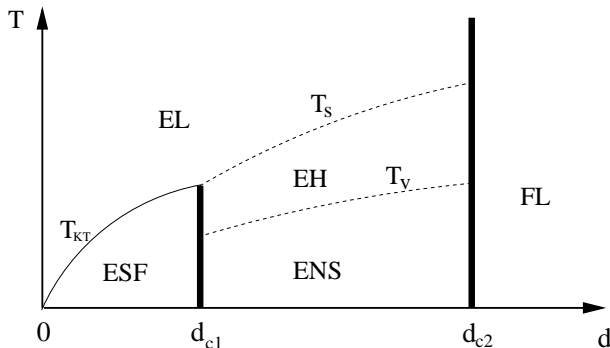

FIG. 8: The Finite temperature phase diagram in the balanced case as the distance between the two layers increases. ESF stands for excitonic superfluid with only algebraic ODLRO. PSDW stands for Pseudo-spin density wave with only algebraic translational order and true orientational order. The EH stands for the exciton hexatic phase with only algebraic orientational order. FL stands for Fermi Liquid.  $T_{KT}$  is the KT transition temperature driven by vortex unbinding in the phase  $\theta_{\perp}$ .  $T_v$  is the vector Coulomb gas transition temperature driven by dislocation unbinding.  $T_s$  is the scalar Coulomb gas transition temperature driven by disclination unbinding.

( due to higher symmetry, the hexagonal lattice only has 2 ). We assume the Kosterlitz-Thouless-Halperin-Nelson-Young ( KTHNY ) theory<sup>47</sup> designed for hexagonal lattice also work for the PSDW square lattice in Fig.7. When interlayer distance  $d = 0$ , the symmetry is  $SU(2)$ , the broken symmetry state at  $T = 0$  in Fig. 3 is immediately destroyed at any finite  $T$  in Fig.8. The system becomes the exciton liquid (EL). When  $0 < d < d_{c1}$ , the true long-range ordered PSDW in Fig.5 has only algebraic ODLRO in Fig.8, there is a finite temperature KT transition above which the system is in the EL. When  $d_{c1} < d < d_{c2}$ , the true long-range ordered translational order in Fig.5 has only algebraic one, but true orientational order. There could also be a dislocation driven transition at  $T = T_v$  in the universality class of 2d vector Coulomb gas with the correlation length exponent  $\nu_v = 0.37$ . The system is in the Exciton Hexatic ( EH ) phase with short range translational order and algebraic orientational order. There could also be a disclination driven transition at  $T = T_s$  in the universality class of KT transition ( scalar Coulomb gas ) with the correlation length exponent  $\nu_s = 1/2$ . The system becomes the EL phase. The finite temperature phase diagram is shown in Fig.8.

#### (8) The PSDW to the FL transition

In Fig.5, as the distance increases to  $d_{c2}$ , the PSDW will melt into the two weakly coupled FL. The flux attachment transformation Eqn.18 which treats the electrons in the two layers on the same footing breaks down and a completely different flux attachment transformation within a single layer to transform an electron into a

Composite Fermion Eqn.5 must be used<sup>35</sup>. At  $d < d_{c2}$ , it is the composite boson to feel zero field, they either condense into the phase ordered ESF or the density ordered PSDW states, while at  $d > d_{c2}$ , it is the composite fermion to feel zero field, they form a Fermi surface. Unfortunately, because completely different actions are needed in the two sides of the transition at  $d = d_{c2}$ , this quantum phase transition can not be addressed in this paper and remains an interesting open question.

#### (9) General arguments on the existence of the PSDW state

When the distance between the two layers is very large, intralayer correlations dominate, a crystalline state is not favorable. When the distance is sufficiently small, due to the strong interlayer correlation, electrons in the top layer pair with the holes in the bottom layer to form excitons, it is essentially a bosonic system in the pseudo-spin channel. As shown in all the experiments<sup>4,5,20</sup>, the strong interlayer correlations go well beyond the regime of the ESF phase. At  $T = 0$ , any bosonic system has to be ordered in some way, namely, breaks some sort of symmetry. If it is a homogeneous state, then it is phases ordered which breaks some internal symmetry such as global  $U(1)$  symmetry, this is the ESF phase where the kinetic energy of the excitons dominate. It happens at very small distance  $d < d_{c1}$ . If it is an inhomogeneous state, then it is density ordered which break translational symmetry, this is the PSDW phase where the potential energy of the excitons dominate. This happens at some intermediate distances  $d_{c1} < d < d_{c2}$ . There is no other possibilities. Some exotic state such as exciton liquid which does not break any symmetry is very unlikely<sup>45</sup>

In the following, we will discuss the effects of the imbalance on Fig.5

### B. Imbalanced case

#### (1) The shape of the magnetoroton minimum

In order to see how the imbalance affects the shape of the dispersion curve shown in the Fig.5a, we need to push Eqn.38 to the order  $q^4$ :

$$\omega_{imb}^2 = f\omega^2 - f(1-f)\frac{v_0^4 q^4}{\omega_c^2} \quad (57)$$

where  $f = 4\nu_1\nu_2$  and  $\omega^2$  is defined in Eqn.48.

Scaling out the common factor  $f$ , one can see  $a$  and  $b$  stay the same, while  $c$  is reduced by the imbalance. Therefore  $q_0$  increases, namely, the lattice constant  $a$  of the PSDW may decrease ( See Fig.10 ). While  $b_c$  decreases, namely, the critical distance  $d_{c1}$  also decreases. Unfortunately, as warned in Sec.III.D, the CB approach may not describe the magnetoroton minimum shape dependence on imbalance correctly. In the subsection (3), we will approach the phase boundary from the PSDW side.

#### (2) Dual density representation in the ESF state

Just like in the balanced case, in order to focus on the *original* instability, we need to keep  $\delta\rho_-$ . The form of Eqn.35 before integrating out  $\delta\rho_-$  is

$$\begin{aligned} \mathcal{L}_c = & \frac{1}{8}\theta_+(-\vec{q}, -\omega)\left[\frac{\omega^2 + \omega_q^2}{V_+(q) + \frac{4\pi^2\bar{\rho}}{m}\frac{1}{q^2}}\right]\theta_+(\vec{q}, \omega) \\ & + \frac{\bar{\rho}}{4m}(\nu_1 - \nu_2)q^2\theta_-(-\vec{q}, -\omega)\theta_+(\vec{q}, \omega) \\ & + \frac{i}{2}\delta\rho^-\partial_\tau\theta^- + \frac{\bar{\rho}}{2m}\left(\frac{1}{2}\nabla\theta_-\right)^2 + \frac{1}{2}\delta\rho^-V_-(\vec{q})\delta\rho^- - h_z\delta\rho^- \end{aligned} \quad (58)$$

Obviously, integrating out  $\delta\rho_-$  and dropping out the linear derivative term in  $\theta^-$ , we recover Eqn.35.

By defining  $\delta\rho_- = \frac{h_z}{a} + \delta\rho'_-$ , we can absorb the last linear term in Eqn.58 into the quadratic term. Integrating out both  $\theta_+$  and  $\theta_-$  leads to:

$$\mathcal{L}[\delta\rho'_-] = \frac{1}{2}\delta\rho'_-(-\vec{q}, -\omega)\left[\frac{m\omega^2}{\bar{\rho}q^2}\left(\frac{\omega^2 + \omega_q^2}{\omega^2 + f\omega_q^2}\right) + V_-(\vec{q})\right]\delta\rho'_-(\vec{q}, \omega) \quad (59)$$

where we can identify the dynamic pseudo-spin density-density correlation function  $S'(\vec{q}, \omega) = \langle \delta\rho'_- \delta\rho'_- \rangle$ :

$$\langle \delta\rho'_- \delta\rho'_- \rangle = \frac{\frac{\bar{\rho}}{m}q^2(\omega^2 + f\omega_q^2)}{\omega^4 + \omega^2(\omega_q^2 + v^2q^2) + f v^2 q^2 \omega_q^2} \quad (60)$$

where  $v^2 = v^2(q)$  was defined in Eqn.30. Obviously  $S'(\vec{q}, \omega = 0) = \frac{1}{V_-(q)}$ .

Again, From the pole of the dynamic density-density correlation function Eqn.60, we can identify the speed of sound wave in the imbalanced case which is exactly the same as the spin wave velocity in the imbalanced case Eqn.57 achieved from the phase representation. From both the phase representation in Sec.III and the density representation in this subsection, we conclude that imbalance is irrelevant in the ESF side, but it may play important role in the PSDW side to be discussed in the following.

(3) *The quantum phase transitions driven by small imbalances in the PSDW state*

As shown in section III, the imbalance is irrelevant in the ESF side, but we expect it is important in the PSDW side. Starting from the ESF side, it would be useful to calculate how the mageto-roton minimum depends on the imbalance, this was attempted in (1). As said in (1), the precise dependence of  $d_{c1}$  on the imbalance is hard to achieve from the CB effective theory. Here we take a different strategy: starting from the PSDW side and studying how a small imbalance affects the PSDW. If the imbalance is sufficiently small, we expect the C-PSDW at the balanced case in Fig.7a is a very good reference state. In the following, we ignore the small number of vacancies in the PSDW shown in Fig.7b. Because it is a square lattice with the "up" pseudospins taking sublattice *A* and the "down" pseudospins taking sublattice *B*, it is reasonable to start from a lattice model from the PSDW side. If we think the PSDW as a charge density wave (CDW) of bosons at half filling on a square lattice,

then we can view the ESF to the PSDW as a superfluid to CDW transition in a boson Hubbard model of *hard core* bosons near half filling hopping on square lattice of bosons:

$$\begin{aligned} H = & -t \sum_{\langle ij \rangle} (b_i^\dagger b_j + h.c.) - \mu \sum_i n_i \\ & + V_1 \sum_{\langle ij \rangle} (n_i - 1/2)(n_j - 1/2) \\ & + V_2 \sum_{\langle\langle ik \rangle\rangle} (n_i - 1/2)(n_k - 1/2) + \dots \end{aligned} \quad (61)$$

where  $S^+ = b^\dagger = c_1^\dagger c_2$ ,  $S^- = b = c_2^\dagger c_1$ ,  $S^z = \frac{1}{2}(c_1^\dagger c_1 - c_2^\dagger c_2) = b^\dagger b - 1/2$  are the pseudo-spin density and boson operators. At the total filling factor  $\nu_T = 1$ , we can impose the local constraint  $c_1^\dagger c_1 + c_2^\dagger c_2 = 1$ .  $n_i = b_i^\dagger b_i$  is the boson density,  $t$  is the nearest neighbor hopping amplitude,  $V_1, V_2$  are the nearest and next nearest neighbor repulsive interactions between the bosons. The  $\dots$  may include further neighbor interactions. Because of the long-rang Coulomb interaction in Eqn.23, it is important to keep all the long-range interactions in the lattice model Eqn.19. If the chemical potential  $\mu = 0$ , the bosons are at the half filling  $\langle n_i \rangle = 1/2$  which corresponds to the balanced case  $\nu = 1/2$ . The particle-hole symmetry of Eqn.19 corresponds to the  $Z_2$  exchange symmetry of the BLQH. If the chemical potential  $\mu \neq 0$ , the bosons are slightly away from the half filling which corresponds to the slightly imbalanced case.

The boson Hubbard model Eqn. 61 in square lattice at generic commensurate filling factors  $f = p/q$  ( $p, q$  are relative prime numbers) were systematically studied in<sup>50</sup> by performing the charge-vortex duality transformation. Recently, we applied the dual approach to study extended boson Hubbard model Eqn.61 in bipartite lattices such as square and honeycomb lattice which maybe directly relevant to the Helium 4 and Hydrogen adsorbed on various structures of substrates<sup>52,53</sup>. The key result achieved in this paper is that there are two consecutive transitions at zero temperature *driven by the coverage*: a Commensurate-Charge Density Wave (CDW) at half filling to a narrow window of supersolid, then to an Incommensurate-CDW. In the Ising limit, the supersolid is a CDW supersolid; whereas in the easy-plane limit, it is a valence bond supersolid. The first transition is a second order one in the same universality as the Mott insulator to the superfluid transition, therefore has the exact critical exponents  $z = 2, \nu = 1/2, \eta = 0$  (with possible logarithmic corrections). The second is a first order transition. In the following, we simply straightforwardly apply the results near half filling in the square lattice achieved in<sup>51</sup> to the present problem on square lattice near half filling. At  $q = 2$ , there are two dual vortex fields  $\psi_a$  and  $\psi_b$ . Moving *slightly* away from half filling  $f = 1/2$  corresponds to adding a small *mean* dual magnetic field  $H \sim \delta f = f - 1/2$  in the dual action. The most general action invariant under all the MSG trans-

formation laws upto quartic terms is<sup>50,51</sup>:

$$\mathcal{L} = \sum_{\alpha=a/b} |(\partial_\mu - iA_\mu)\psi_\alpha|^2 + r|\psi_\alpha|^2 + \frac{1}{4}(\epsilon_{\mu\nu\lambda}\partial_\nu A_\lambda - 2\pi\delta f\delta_{\mu\tau})^2 + \gamma_0(|\psi_a|^2 + |\psi_b|^2)^2 - \gamma_1(|\psi_a|^2 - |\psi_b|^2)^2 + \dots$$

where  $A_\mu$  is a non-compact  $U(1)$  gauge field. Upto the quartic level, Eqn.62 is the same in square lattice and in honeycomb lattice. If  $r > 0$ , the system is in the superfluid state  $\langle \psi_l \rangle = 0$  for every  $l = a/b$ . If  $r < 0$ , the system is in the insulating state  $\langle \psi_l \rangle \neq 0$  for at least one  $l$ . We assume  $r < 0$  in Eqn.62, so the system is in the insulating state.  $\gamma_1 > 0$  ( $\gamma_1 < 0$ ) corresponds to the Ising ( or Easy-plane ) limit. The insulating state takes the CDW state ( or valence bond solid (VBS) state ).

In the balanced case  $\delta f = 0$ , the SF to the VBS transition in the easy plane limit was argued to be 2nd order through a novel deconfined quantum critical point<sup>54</sup>. However, the boson Hubbard model Eqn.19 on the PSDW side corresponds to the Ising limit in the dual model Eqn.62, therefore  $\gamma_1 > 0$ . The SF to the CDW transition in the Ising limit is first order. This is consistent with the first order ESF to PSDW transition driven by the collapsing of magnetoroton minimum studied in Sec.IV-A.

In the CDW order side, the mean field solution is  $\psi_a = 1, \psi_b = 0$  or vice versa. In the slightly imbalance case  $\delta f \neq 0$ , setting  $\psi_b = 0$  in Eqn.62 leads to:

$$\mathcal{L} = |(\partial_\mu - iA_\mu)\psi_a|^2 + r|\psi_a|^2 + \gamma_0|\psi_a|^4 + \dots + \frac{1}{4}(\nabla \times \vec{A} - 2\pi\delta f)^2 \quad (63)$$

where  $\rho_A = \psi_a^\dagger \psi_a$  should be interpreted as the vacancy number, while the vortices in its phase winding are interpreted as boson number. Of course, a negative imbalance can simply achieved by a particle hole transformation  $\psi_a \rightarrow \psi_a^\dagger, \delta f \rightarrow -\delta f$  in Eqn.63.

Eqn.63 has the structure identical to the conventional  $q = 1$  component Ginzburg-Landau model for a type II " superconductor " in a "magnetic" field. It was well known that as the magnetic field increases, there are two first order phase transitions:  $H < H_{c1}$ , the system is in the Messiner phase,  $H_{c1} < H < H_{c2}$ , it is in the vortex lattice phase,  $H > H_{c2}$  it is in the normal phase. In the present boson problem with the nearest neighbor interaction  $V_1 > 0$  in Eqn.61 which stabilizes the CDW state at  $f = 1/2$ , this corresponds to C-CDW to IC-CDW to superfluid transition shown in Fig.9a. Transferring back to the original BLQH problem, the small imbalance will first drive the C-PSDW to the In-commensurate normal solid (IC-PSDW), then drive a 1st order transition from the IC-PSDW to the ESF shown in Fig.9b.

As shown in Fig.9b, the bias voltage increases, the imbalance will first introduce interstitials in the top layer and vacancies in the bottom layer, namely, turn the C-PSDW into the IC-PSDW whose charge distributions are

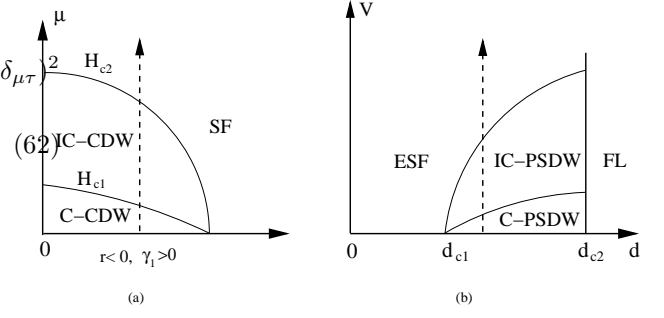

FIG. 9: (a) The phase diagram of the boson Hubbard model Eqn.19 slightly away from the half filling.  $\mu$  is the chemical potential. (b) The bias voltage  $V$  versus distance  $d$  phase diagram at zero temperature. IC-PSDW stands for the incommensurate PSDW. The dashed line is the experimental path investigated in<sup>58</sup>. All the transitions are first order transitions.

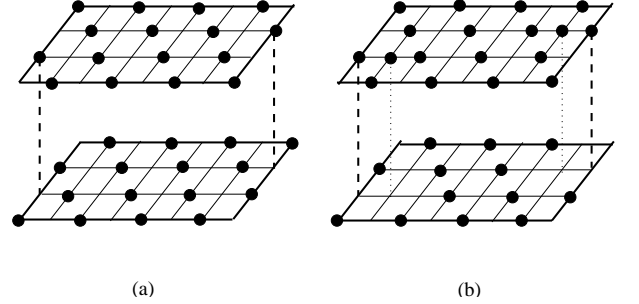

FIG. 10: (a) The charge distribution of the PSDW in a square lattice. The dashed line stand for "up" pseudo-spins which take sublattice A, while "down" pseudo-spins take sublattice B. (b) The charge distribution of the IC-PSDW in a square lattice. The dotted line stand for "inverted" pseudo-spins which play the role of interstitials in the top layer or vacancies in the bottom layer. The number of interstitials in the top layer is equal to that of vacancies in the bottom layer. Compare with Fig.7

shown in Fig.7 and 10 respectively, then the whole IC-PSDW melts into the ESF through a 1st order transition.

The dashed line in Fig.9b was investigated in a recent experiment<sup>58</sup>. But the first phase transition in Fig.9b was not paid attention in the experiment where the phase diagram was drawn against fixed charge imbalance  $h_z$  instead of fixed bias voltage  $V$ . So the C-PSDW phase was crushed into the horizontal axis. A simple mean field argument leads to the linear scaling of the second transition line  $V \sim d - d_{c1}$ . A parabolic behavior  $h_z^2 \sim d - d_{c1}$  was found for the shape of the second transition at very small imbalances. Disorders will smear all the 1st order transitions in Fig.9b into 2nd order transitions. The disorders may also transfer the long range lattice orders of the C-PSDW and IC-PSDW into short range ones. The fact make the observation of the commensurate and incommensurate lattice structures by

light scattering experiment<sup>60</sup> difficult. We expect the disorders may transform the linear behavior  $V \sim d - d_{c1}$  in clean case to the parabolic one  $h_z^2 \sim d - d_{c1}$  in the dirty case. In the presence of disorders, all the properties of the C-PSDW and IC-PSDW are consistent with all the experimental observations in<sup>58</sup> on the intermediate phase at small imbalance.

When the distance of the two layers is further increased to larger than a second critical distance  $d_{c2}$ , then all the signature of the interlayer coherent state are lost, the two layers are decoupled into two separate  $\nu = 1/2$  CF Fermi liquid state ( Fig.1b ). We expect that there is a level crossing and associated first order transition at  $d_{c2}$ . When  $d > d_{c2}$ , increasing the bias voltage may not transform the two decoupled FL state back into the ESF.

#### (4) Large imbalance

At large imbalance, all the states in Fig.5 at the balanced case are not good reference states anymore. Fig. 7 is valid only for small imbalance such that  $\nu_1, \nu_2$  do not fall onto any fractional Quantum Hall plateaus for separate layers. For large imbalance such as two layers with  $\nu_1 = 1/3, \nu_2 = 2/3$  still with  $\nu_T = 1$ , then the two weakly coupled layers show  $\nu_1 = 1/3$  and  $\nu_2 = 2/3$  fractional Quantum Hall states separately when  $d > d_{c2}$ . Because there are intralayer gaps, they are more robust against the interlayer correlations, we expect  $d_{c2}$  for  $\nu_1 = 1/3, \nu_2 = 2/3$  to be *smaller* than  $\nu_1 = \nu_2 = 1/2$ . If we bring them closer, there could be a direct 1st order transition at  $d_{c1} = d_{c2}$  from the weakly coupled pair to the ESF, or through a narrow regime of IC-PSDW. The extreme imbalanced case  $\nu_1 \ll 1, \nu_2 = 1 - \nu_1 \sim 1$  where coupled electron and hole Wigner crystal (EHWC) was discussed in<sup>75</sup>. As shown in the appendix B, we believe this EHWC should take a triangular lattice in contrast to the square lattice at the balanced case.

### C. Comparison with earlier work

Although the ESF phase and FL phase at the two extreme distances are well established, the picture of how the ESF phase evolves into the two weakly-coupled FL states is still not clear, namely, the nature of the intermediate phase at  $d_{c1} < d < d_{c2}$  is still under debate. There are previous work also based on the instability due to magnetoroton minimum collapsing<sup>69</sup>. These work proposed different kinds of translational symmetry breaking ground states as candidates of the intermediate state. All these previous work used either HF approximation or trial wavefunctions approximation. Especially, Cote, Brey and Macdonald in<sup>69</sup> found that the lowest energy lattice structure of the PSDW is square lattice. The microscopic calculations are powerful and accurate in studying quantum Hall states with a bulk gap in SLQH or BLQH systems, but its accuracy and power drop considerably in the  $\nu = 1/2$  FL system in SLQH and the  $\nu = 1$  BLQH system with a broken symmetry state and its associated Goldstone mode. The Quantum Ginsburg-

Landau theory presented in this paper is complementary to and goes well beyond the previous microscopic calculations. As shown in the text, our QGL theory Eqn.53 very quickly and firmly leads to the conclusion that the square lattice is the most favorite lattice. We also explicitly point out the hopping mechanism for the large Coulomb drag in the PSDW state. The two approaches are complementary to each other and reach similar conclusions. Furthermore, the QGL theory circumvents the difficulty associated with the unknown wavefunction at any finite  $d$ <sup>39</sup> and treat both the interlayer and the intralayer correlations on the same footing, so can be used to capture competing orders on microscopic length scales and naturally leads to the PSDW as the intermediate state which breaks translational symmetry. The theory puts the ESF state and the PSDW state on the same footing, characterize the symmetry breaking patterns in the two states by corresponding order parameters and describe the universality class of the quantum phase transition between the two states. It can also be used to determine the nature, properties and lattice structure of the PSDW state. The properties of the PSDW proposed in this paper are also consistent with earlier experimental observations in<sup>70</sup>.

By the microscopic LLL+ HF approach, the authors in<sup>55,56,57</sup> claimed that the transition at  $h_z = 0, d = d_{c1}$  is an instability through a 1st order transition to a pseudospin density wave state driven by the gap closing of magneto-roton minimum at a finite wave-vector. Starting from the ESF side, their numerical results indicated that the imbalance increases the spin stiffness and also the critical distance  $d_{c1}$ . All the calculations in LLL+HF approach assumes that the ground state wavefunction at any finite  $d$  is still the (111) wavefunction. However as shown in<sup>39,65</sup>, the wavefunction at any finite  $d$  is *qualitatively* different from the (111) wavefunction which is good only at  $d = 0$ . So the excitation spectra in the ESF side calculated by the LLL+HF based on the (111) wavefunction may not have quantitatively correct distance dependence. The LLL+HF theory in<sup>56</sup> completely breaks down in the PSDW side. Furthermore, in this LLL+HF approach, the charge fluctuations are completely integrated out, therefore can not address the interplay between the QH effects in the charge sector and the interlayer phase coherence in the spin sector. The CB field theory approach in this paper circumvents this difficulty associated with the unknown wavefunction at any finite  $d$  (see Sec.V) and was used to show how the pseudo-spin density wave state is formed and its properties. We look at the effects of small imbalance from the PSDW side and map its effect as a chemical potential of a hard core bosons hopping on a square lattice near half filling, namely, mapping Fig.9a to Fig.9b. Our upper phase boundary in Fig.9b is consistent with that in<sup>56</sup>. We also worked out the lattice structures of the C-PSDW and IC-PSDW and the whole physical picture along the dashed line in Fig.9b. However, as pointed out in Sec.III, it is hard to incorporate the LLL projection in the CB. Some parameters can only be estimated in the LLL+HF

approaches. So the CB approach in this paper and the microscopic LLL+HF approach in<sup>56</sup> are complementary to each other.

There are other proposals which are not based on the collapsing of magneto-roton minimum. Recently, a trial wavefunction involving the coexistence of composite bosons and composite fermions at finite distance was proposed in<sup>66</sup>. However, it seems to the author that there is no phase transitions in this CF-CB coexistence trial wavefunction. This is in-consistent with the experimental observations. As further elucidated in Sec.V wavefunction approach is unlikely to be efficient in describing transitions. The authors in<sup>67</sup> argued that the state  $d_{c1} < d < d_{c2}$  is a phase separated state between the ESF and the FL. Based on this phase separation picture, Wang investigated the effect of the interlayer tunneling<sup>68</sup>.

## V. CONCLUSIONS

### (1) Comments on different approaches in SLQH

Three common approaches to SLQH systems are the wavefunction ( or first quantization )<sup>33,59</sup>, Composite Fermion Field Theory (CFFT)<sup>34,35,36</sup> and Composite Boson Field Theory (CBFT) approaches<sup>37,38</sup>. The Wavefunction approach has been very successfully applied to study SLQH at Jain's series at  $\nu = \frac{p}{2sp \pm 1}$ . CFFT has been used to study the CF Fermi liquid at  $\nu = 1/2$  which is at the end point of Jain's series in the limit  $p \rightarrow \infty$ . However, there are many problems with CFFT approach whose equivalence to the wavefunction approach is still not obvious even in SLQH. These problems have been vigorously addressed in<sup>36</sup>. CBFT approach has so far been only limited to Laughlin's series  $\nu = \frac{1}{2s+1}$  which is only a  $p = 1$  subset of Jain's series. It can not be used in any simple way to study  $p > 1$  Jain series and  $\nu = 1/2$  CF Fermi liquid. Despite having played very important roles historically, except describing topological properties elegantly, both CFFT and CBFT have not been able to give much new information beyond those achieved in the wavefunction approach in describing bulk Quantum Hall States. One of main reasons for the success of the wavefunction approach is that there is a gap in the bulk, suitable wavefunctions<sup>33,59</sup> can describe both the ground-state and low energy excitations quite accurately. Its accuracy can be checked easily by exact diagonalization in a finite size system whose size is beyond only a few magnetic length. Spherical geometry can be used to get rid of edge state effects quite efficiently. However, there are at least three exceptions even in SLQH which can not be described in the framework of wavefunction approach (1) The CF Fermi liquid at  $\nu = 1/2$ . Because it is a gapless system, the wavefunction may not be very useful. unfortunately, a simple field theory description is still lacking. (2) The edge state: because the gap vanishes on the edge, field theory is very convenient to study the gapless edge excitations<sup>71</sup> (3) The quantum phase transition from QH to QH or QH to insulating state. It is known that wave-

function approach is not convenient to describe any phase transition. A Field Theory is the most powerful method to study phase transitions. Unfortunately, so far, no field theory has been able to describe the transitions except in some artificial lattice models<sup>76,77</sup>. In appendix B, we will construct a quantum Ginsburg Landau theory to describe QH to WC transition.

### (2) Summary of our results on BLQH

As shown in<sup>39,65</sup>, because of the gapless nature, at any finite  $d$ , the wavefunction is qualitatively different from the (111) wavefunction, so the wavefunction approach to BLQH is far less powerful in BLQH than in SLQH. So Field theory approaches are much more powerful in BLQH than in SLQH, especially in the pseudo-spin sector which contains the new phenomena not displayed in SLQH. In this paper, we used both CFFT and CBFT approach to study the balanced and im-balanced BLQH systems. In Section II, we used a MCF approach to study balanced and im-balanced BLQH systems. We achieved some limited success, but also run into many troublesome problems. We explicitly identified these problems and motivated the alternative CB approach. Extension of Murthy-Shankar's formalism<sup>36</sup> in SLQH to BLQH is not expected to fix these problems. In Section III, we developed a simple and effective CB theory to study the BLQH. The CB theory naturally fixed all the problems suffered in the MCF theory presented in Sec. II. By using this CB theory in its phase representation, we first studied the excitonic superfluid state and re-derived many previous results in a simple and transparent way. The theory puts spin and charge degree freedoms in the same footing, explicitly brought out the spin-charge connection in a straightforward way and classified all the possible excitations in a systematic way. We made detailed comparisons between the spin sector of the CB theory with EPQFM derived from microscopic LLL approach. Although some parameters in the spin sector can only be taken as phenomenological parameters, the functional form is identical to the EPQFM. In Sec. III, using this CB theory in its dual density representation, we then analyzed the instability in the pseudo-spin sector and found the magneto-roton minimum collapsing leads to a new ground state which breaks the translational symmetry: Pseudo-spin density wave ( PSDW ) state. We proposed that for balanced BLQH, there are two critical distances  $d_{c1} < d_{c2}$ . When  $0 < d < d_{c1}$ , the system is in the ESF state, when  $d_{c1} < d < d_{c2}$ , the system is in the PSDW state, there is a first order transition at  $d_{c1}$  driven by the collapsing of magneto-roton minimum in the pseudo-spin channel. When  $d_{c2} < d < \infty$ , the PSDW melts into two weakly coupled  $\nu = 1/2$  Composite Fermion Fermi Liquid (CFFL) state. There is also a first order transition at  $d = d_{c2}$ . However, disorders could smear the two first order transitions into two second order transitions. The transition from the ESF to the PSDW is unusual because the two states break two completely different symmetries: the global internal  $U(1)$  symmetry and the translational symmetry respectively. We construct an effective theory

in the dual density representation to describe this novel quantum phase transition. The effective action is a  $n = 1$  component  $(d+1, d)$  with  $d = 2$  quantum Lifshitz action. The most favorable lattice is a square lattice instead of a hexagonal lattice. Because a 2d square lattice is not a close packed lattice, so it is hard to be realized experimentally. This is probably the only experimental realization of a 2d square lattice in any 2 dimensional system. The ESF to PSDW transition is similar to the superfluid to normal solid transition in  ${}^4\text{He}$  system with the distance playing the role of the pressure. The correlated hopping of vacancies in the active and passive layers in the PSDW state leads to very large and temperature dependent drag consistent with the experimental data. The PSDW could be the true ground state responsible for all the experimental observations in intermediate distances. We also applied the CB theory to study the effects of imbalance on both the ESF and the PSDW side in corresponding sect. III and IV. On the ESF side, as we tune the im-balance, the system supports continuously changing fractional charges, We also derived the dual action of the CB theory in terms of topological currents and dual gauge fields. By comparing this dual action with the action derived from MCF theory, we can explicitly identify the missing and the arti-facts of the MCF approach in section II. On the PSDW side, we map the square lattice PSDW at the balanced case into a hard core bosons hopping on a square lattice at half filling, then adding a small imbalance in the BLQH corresponds to adding a small chemical potential in the boson model. Through this mapping, we find the imbalance drives two quantum phase transitions: the first one is from the commensurate PSDW state to an incommensurate PSDW (IC-PSDW), the second one is from IC-PSDW state to the ESF state. Both transitions are first order transitions. We discuss the effects of disorders and finite temperature. We compare our results with the previous results achieved from the LLL+HF approach, the other proposals on the possible intermediate phases and available experimental data. We concluded that CBFT approach is superior than CFFT approach in the BLQH having ground states with different kinds of broken symmetries. It would be interesting to see if the PSDW can also be achieved in Tri-layer quantum Hall systems studied in<sup>64</sup>. Only the interlayer coherent (111) state was discussed in this paper, it can be easily generalized to other interlayer coherent  $(m, m, m)$  ( with  $m$  odd ) states at total filling factors  $\nu_T = 1/m$ .

### (3) General remarks on bosonic and fermionic approaches

It is general true that when there is an ordered state with broken symmetry and an associated order parameter, bosonic approach is superior than fermionic approach. It is well known that the bosonic approach can be easily applied to capture competing orders at long wavelength scales. As explicitly and systematically shown in<sup>28</sup> and this paper, it can also be used to capture competing orders at microscopic length scales. For exam-

ple, in Quantum Antiferromagnet, fermionic approach can only address the disordered phase<sup>72</sup>, while bosonic approach<sup>73</sup> can address not only the disordered phase, but also the ordered phase with broken symmetry and the quantum phase transition between the disordered phase and ordered phase. Similarly, in quantum spin glass, bosonic approach can study spin liquid, spin glass and the quantum phase transition between the two, while the fermionic representation can only study the spin liquid phase<sup>74</sup>. In SLQH system, there is only algebraic long range order, but no broken symmetry and no true ordered state, so CF approach could be very successful. Fermionic theory can be even used to describe QH to insulating transitions. For example, the QH to insulating transitions in a periodic potential was described in terms of 2 + 1 dimensional Dirac fermion<sup>76,77</sup>. For general BLQH  $(m, m', n)$  states with  $m, m'$  are odd and  $mm' - n^2 \neq 0$ , because there are no broken symmetry in the ground states and no associated gapless Goldstone modes, we expect the Composite Fermion approach works better. For example,  $(3, 3, 1)$  state at  $\nu_T = 1/2$  can be described in terms of the Entangled Composite Fermion (ECF) discussed at section II. While  $(m, m, m)$  BLQH system has a true  $U(1)$  broken symmetry ground state and an associated order parameter and a Goldstone mode, the CB approach becomes more effective as demonstrated in this paper. Most importantly, we use the CB approach to explore the PSDW state which breaks the translational symmetry instead of the  $U(1)$  symmetry.

### (4) The synthesis of roton collapsing in $d = 1, 2, 3$

As shown in<sup>75</sup>, due to the long-range Coulomb interactions between electrons, in the effective low energy theory describing the edge reconstruction in the FQHE, there are also two low energy sectors at  $k = 0$  and  $k = k_r$ . It is the magneto-roton minimum collapsing at  $k = k_r$  is responsible for edge reconstruction in the edge state of FQHE. In one dimensional edge, the roton manifold at  $k = k_r$  becomes two disconnected points. Of course, 1 dimension is always special. Higher dimensions could be completely different. This paper showed that the magneto-roton minimum collapsing at  $d = 2$  leads to the PSDW state. At 2d, the roton manifold at  $k = k_r$  is a circle. In<sup>28</sup>, it was shown that the roton minimum collapsing driven by pressure could lead to a normal solid or a supersolid state in  ${}^4\text{He}$ . At 3d, the roton manifold at  $k = k_r$  is a sphere. Combining all these results, we find that the roton minimum collapsing could lead to novel physics in all possible experimental accessible dimensions.

### Acknowledgement

I thank M. Chan, H. Fertig, E. Fradkin, S. M. Girvin, B. Halperin, J. K. Jain, Longhua Jiang, A. H. MacDonald, G. Murthy and Jun Zhu for helpful discussions. I also thank Prof. Haiqing Lin for hospitality during my visit at Chinese University of Hong Kong in the summer of 2004.

## APPENDIX A: MERON FRACTIONAL CHARGES IN IMBALANCED CASE

In this appendix, we will evaluate the fractional charges of merons in imbalanced case from their wavefunctions and find they are indeed the same as those listed in Table 2. We will first discuss the ground state wavefunction, then the meron wavefunction. The balanced case was discussed in<sup>39</sup>. Here we extend the analysis to the imbalanced case.

### 1. Ground state wavefunction in first and second quantization:

In first quantization, the ground state trial wavefunction of BLQH in  $d \rightarrow 0$  limit is Halperin's (111) state<sup>1</sup>:

$$\Psi_{111}(z, w) = \prod_{i=1}^{N_1} \prod_{j=1}^{N_2} (z_i - w_j) \prod_{i < j}^{N_1} (z_i - z_j) \prod_{i < j}^{N_2} (w_i - w_j) \quad (\text{A1})$$

where  $z$  and  $w$  are the coordinates in layer 1 and layer 2 respectively. As explicitly written, there are  $N_1$  electrons in the top layer and  $N_2$  electrons in the upper layer.

In the EPQFM picture<sup>2,8</sup>, the ground state EPQFM wavefunction was written in second quantization form:

$$|G; \theta, \phi \rangle = \prod_{m=0}^{M-1} (\cos \frac{\theta}{2} C_{m\uparrow}^\dagger + \sin \frac{\theta}{2} e^{i\phi} C_{m\downarrow}^\dagger) |0 \rangle \quad (\text{A2})$$

where  $M = N$  is the angular momentum quantum number corresponding to the edge of the system.

In the following, we will show that the EPQFM wavefunction in the second quantization form of Eqn.A2 is equivalent to (111) wavefunction in Eqn.A1.

The wavefunction Eqn.A2 can also be interpreted as the pairing of an electron in one layer and a hole in another which leads to exciton condensation. It is easy to show that the charges on the top layer are  $N_1 = N \cos^2 \theta/2 = N\nu_1$ , while charges on the bottom layer are  $N_2 = N \sin^2 \theta/2 = N\nu_2$ . Obviously  $N_1 + N_2 = N$ .

We can expand Eqn.A2 into:

$$|G; \theta, \phi \rangle = (\cos \frac{\theta}{2})^N \sum_{N_1=0}^N \frac{\sqrt{N!}}{N_1! N_2!} (\tan \frac{\theta}{2})^{N_2} e^{iN_2\phi} \sum_{k_1, \dots, k_N} (-1)^{P(k_1, \dots, k_N)} C_{k_1, \uparrow}^\dagger \dots C_{k_{N_1}, \uparrow}^\dagger C_{k_{N_1+1}, \downarrow}^\dagger \dots C_{k_{N_1+N_2}, \downarrow}^\dagger \quad (\text{A3})$$

where  $N = N_1 + N_2$  and  $P$  is the permutation of  $N$  variables.

Projecting onto the state with  $N_1$  electrons in layer 1 and  $N_2$  electrons in layer 2

$$|G; \theta, N_1, N_2 \rangle = \int_0^{2\pi} \frac{d\phi}{2\pi} e^{-iN_2\phi} |G; \theta, \phi \rangle \quad (\text{A4})$$

and then transforming into the first quantization form leads to:

$$|G; \theta, N_1, N_2 \rangle = (\cos \frac{\theta}{2})^N (\tan \frac{\theta}{2})^{N_2} \frac{\sqrt{N!}}{N_1! N_2!} \sum_{k_1, \dots, k_N} (-1)^{P(k_1, \dots, k_N)} \frac{1}{\sqrt{N!}} \mathcal{A}[\phi_{k_1}(z_1) \dots \phi_{k_{N_1}}(z_{N_1}) \phi_{k_{N_1+1}}(w_1) \dots \phi_{k_N}(w_{N_2}) (1, \uparrow) \dots (N_1, \uparrow) (N_1 + 1, \downarrow) \dots (N, \downarrow)] \quad (\text{A5})$$

where  $\mathcal{A}$  stands for anti-symmetrization.

Moving the summation over the orbital states into  $\mathcal{A}$ , the sum is essentially the (111) state:

$$\sum_{k_1, \dots, k_N} (-1)^{P(k_1, \dots, k_N)} \phi_{k_1}(z_1) \dots \phi_{k_{N_1}}(z_{N_1}) \phi_{k_{N_1+1}}(w_1) \dots \phi_{k_N}(w_{N_2}) = \prod_{i=1}^{N_1} \prod_{j=1}^{N_2} (z_i - w_j) \prod_{i < j}^{N_1} (z_i - z_j) \prod_{i < j}^{N_2} (w_i - w_j) = \psi_{111}(z, w) \quad (\text{A6})$$

Finally

$$|G; \theta, N_1, N_2 \rangle = (\cos \frac{\theta}{2})^N (\tan \frac{\theta}{2})^{N_2} \frac{1}{N_1! N_2!} \mathcal{A}[\psi_{111}(z, w) (1, \uparrow) \dots (N_1, \uparrow) (N_1 + 1, \downarrow) \dots (N, \downarrow)] \quad (\text{A7})$$

This concludes that the orbital part of the projection of the EPQFM wavefunction Eqn.A2 onto  $(N_1, N_2)$  sector is exactly the same as (111) state. If putting  $\theta = \pi/2$ , we recover the balanced case in<sup>39</sup>. It is clear that the (111) wavefunctions with different  $(N_1, N_2)$  provide a complete basis, the ground state wavefunction Eqn.A2 can be expanded in terms of this basis, the angle  $\theta$  controls the expansion coefficients.  $\theta = \pi/2 (\neq \pi/2)$  corresponds to the balanced (imbalanced) case.

### 2. The fractional charges of merons

In the subsection, we will calculate the fractional charges of the excitations above the the (111) state.

The charge density on each of the layers in the ground state Eqn.A2 is:

$$\rho_{G1}(z) = \nu_1 \sum_{m=0}^{M-1} |\phi_i(z)|^2, \quad \rho_{G2}(z) = \nu_2 \sum_{m=0}^{M-1} |\phi_i(z)|^2 \quad (\text{A8})$$

The wavefunction of a meron in the bottom layer is:

$$|M, \theta, \phi, 2 \rangle = \prod_{m=0}^{M-1} (\cos \theta/2 C_{m\uparrow}^\dagger + \sin \theta/2 e^{i\phi} C_{m+1\downarrow}^\dagger) |0 \rangle \quad (\text{A9})$$

The charge density on each layer is:

$$\rho_{m1}(z) = \nu_1 \sum_{m=0}^{M-1} |\phi_i(z)|^2, \quad \rho_{m2}(z) = \nu_2 \sum_{m=1}^M |\phi_i(z)|^2 \quad (\text{A10})$$



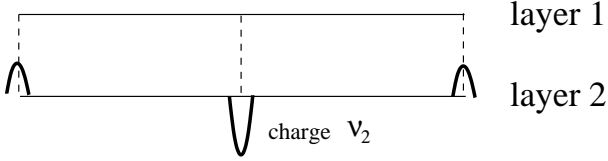

FIG. 11: The charge densities of the smallest meron wavefunction

Subtracting Eqn.A8 from Eqn.A10 leads to the fractional charge of the meron:

$$\delta\rho_{m1}(z) = 0, \quad \delta\rho_{m2}(z) = -\nu_2[|\phi_0(z)|^2 - |\phi_M(z)|^2] \quad (\text{A11})$$

The charges in top layer remains untouched, while  $\nu_2$  charge is moved from the origin to the boundary ( Fig.1 ), namely, there is a hole with charge  $\nu_2$  at the origin and extra charge  $-\nu_2$  at the boundary.

As concluded in<sup>39</sup>, because the meron wavefunction ignores the strong interlayer correlation, the charge distributions will be strongly modified by the neutral gapless mode. However, as shown in III B (2), the total charge is a topological property. Although the meron wavefunction may not even be a qualitatively a good one, it still should give a correct answer on the total charge. Indeed, Eqn. A11 gives the correct total charge  $\nu_2$  listed in Table 2.

## APPENDIX B: QUANTUM HALL STATE TO WIGNER CRYSTAL TRANSITION IN SINGLE LAYER QH SYSTEMS

Despite the success of wavefunction approach in SLQH, the nature of quantum phase transitions from QH to insulating state is beyond the scope of the wavefunction approach. It remains one of the outstanding problems in QH. Field theory is a must to study the transitions. Quantum Hall transitions in periodic potential in the presence of Coulomb interaction was investigated in<sup>76</sup> in terms of Dirac fermion. The effects of both Coulomb interaction and disorders on the transition were discussed in<sup>77</sup>. But these investigations may not be directly relevant to the real QH transitions which happen in a continuous system. In this appendix, inspired by the ESF to PSDW transition investigated in Sec.IV, we study the QH to Wigner Crystal (WC) transition in SLQH.

It is instructive to point out the difference between SLQH and BLQH. In the SLQH, there is no true symmetry breaking, the collective mode at  $k = 0$  turns out to be a local maximum. There is still a magneto-roton minimum at  $q_0 \sim l$  (Fig.B1), the collapsing of the minimum also signifies the collapsing of the QH gap, the system gets to a possible Wigner crystal state (Fig.B1). Due to lack of true symmetry breaking, it is not known how to characterize the QH order by a local order parameter.

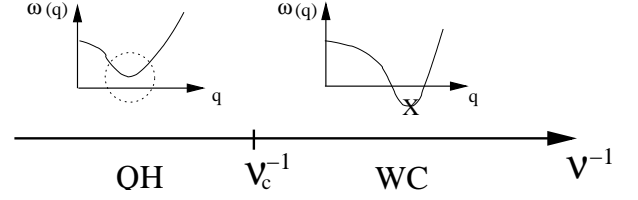

FIG. 12: The zero temperature phase diagram in a single layer quantum Hall system as the filling factor  $\nu$  changes. QH stands for Quantum Hall state, WC stands for Wigner Crystal state. The dispersion relations of the collective modes in the two phases are also shown. The cross in the WC means the negative magneto-roton minimum is replaced by the WC formation.

The QH states may possess possible topological orders which need to be characterized by non-local order parameters. So QH and WC also have two completely different orders: topological order and translational order. In the BLQH, the pseudo-spin sector is a charge neutral sector, as shown in<sup>28</sup>, both low energy modes at  $k = 0$  and  $k = k_0$  are important. The collapsing of the magneto-roton minimum in the charge neutral sector leads to the PSDW in Fig.5.

At fixed electron density, as the magnetic field increases, the filling factor  $\nu$  decreases, strong Quantum Hall states are discovered in  $\nu = 1/3, 1/5, 1/7$ , but not in  $1/9$  where the system may be in the WC state. The WC state will be pinned by disorders and become an insulating state. The quantum Ginsburg-Landau action to describe the QH to the WC transition is:

$$\begin{aligned} \mathcal{L}_{wc}[\delta\rho] = & \frac{1}{2}\delta\rho(-\vec{q}, -\omega)[A_\rho\omega^2 + r + c(q^2 - q_0^2)^2]\delta\rho(\vec{q}, \omega) \\ & - w(\delta\rho)^3 + u(\delta\rho)^4 + \dots \end{aligned} \quad (\text{B1})$$

where  $\rho = c^\dagger c$  is the electron density,  $\delta\rho = \rho - \rho_0$  is the deviation from the average electron density, the momentum and frequency conservations in the cubic and quartic terms are assumed.

In sharp contrast to the QGL action to describe the ESF to the PSDW transition Eqn.53 where the possible cubic interaction term is forbidden by the  $Z_2$  exchange symmetry between the two layers, the cubic term is allowed. So Eqn.B1 is similar to that Eqn.54 describing the SF to NS transition in Helium 4, except the former is in  $2 + 1$  dimension and the latter is in  $3 + 1$  dimension. Unfortunately, the QH order is not transparent in Eqn.B1.

In Eqn.B1,  $r$  is the magneto-roton minimum at  $q = q_0$  which tunes the 1st order transition from the QH to the WC. In the QH fluid state,  $r > 0$  and  $\rho$  is uniform,  $\langle \delta\rho \rangle = 0$ . In the WC,  $r < 0$  and  $\langle \delta\rho \rangle = \sum_{\vec{G}} n(\vec{G}) e^{i\vec{G}\cdot\vec{x}}$  where  $\prime$  stands for the sum over all non-zero reciprocal lattice vectors takes a lattice structure. Due to the cubic term, it can be shown that the most favorable lattice structure is the hexagonal lattice Fig.6c. This is in sharp

contrast to the PSDW square lattice Fig.5 in BLQH.

Disorders will turn the 1st order transition into a 2nd order one, so scaling behaviors at low temperature are expected. As shown in<sup>76,77</sup>, Coulomb interactions will make the dynamic exponent of the 2nd order transition  $z = 1$ . We believe the Coulomb interaction is automatically incorporated in the action Eqn.B1. How to incorporate the effects of disorder into the action remains an outstanding problem.

### APPENDIX C: BILAYER QUANTUM HALL SYSTEM IN A PERIODIC POTENTIAL

The Bilayer quantum Hall system in a periodic potential can be described by the following relativistic model:

$$\mathcal{L}_b = |(\partial_\mu - ia_\mu)z_i|^2 + m^2|z|^2 + u|z|^4 + \frac{i}{4\pi\theta}\epsilon_{\mu\nu\lambda}a_\mu\partial_\nu a_\lambda + U(|z_1|^2 - |z_2|^2)^2 \quad (\text{C1})$$

where  $i = 1, 2$  are the two components,  $|z|^2 = |z_1|^2 + |z_2|^2$ ,  $\theta$  is the statistical angle and  $U > 0$  ( $U < 0$ ) plays the role of the easy-plane ( Ising ) anisotropy which breaks the symmetry in the pseudo-spin sector from  $SU(2)$  down to  $U(1) \times Z_2$ .

The SLQH case with just one complex field was investigated in<sup>79</sup>. It can be considered as a model describing the transition from a quantum Hall state to a Mott insulator (MI) in a periodic potential as the strength of the periodic potential is varied. The fermionic version of the QH to MI transition in a periodic potential was investigated in<sup>76,77</sup>. In both bosonic and fermionic versions, the CS term is exactly marginal, the transition is a second order transition with continuously changing exponents depending on the statistical angle  $\theta$ . One can view Eqn.C1 to describe the transition in a BLQH system in a two 2-dimensional periodic potentials as the distance between the two layers is varied. We assume there is a critical distance  $d_c$  such that  $m^2(d < d_c) < 0$ ,  $m^2(d = d_c) = 0$ ,  $m^2(d > d_c) > 0$ . Due to the exact marginality of the CS term, we expect the transition is still 2nd order with continuously changing exponents depending on the statistical angle  $\theta$ .

In the imbalanced case, we add a Zeeman-like term to Eqn.C1

$$\mathcal{L}_{imb} = \mathcal{L}_b - h_z(|z_1|^2 - |z_2|^2) \quad (\text{C2})$$

The advantage of the relativistic theory Eqn.C2 over the non-relativistic model Eqn.23 in the main text is that it puts the fluctuations of spin sector and charge sector at the same footing. Of course, its physics could be different from the real BLQH studied in the main text, but it is also interesting in its own right. It would be also interesting to compare its phases and phase diagram with those of the real BLQH discussed in the main text. In the following, we will first work out the phase diagrams

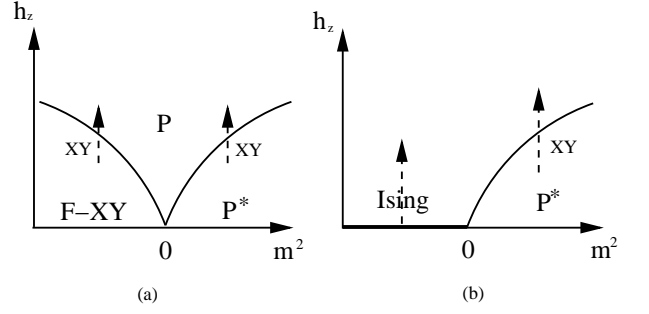

FIG. 13: The phase diagram of Eqn.C3 at  $T = 0$  (a) Easy-plane limit  $U > 0$  is self-dual. The three phases: XY Ferromagnet (  $F - XY$  ), exotic paramagnet (  $P^*$  ) and paramagnet (  $P$  ) meet at the Tetra- quantum critical point which is a deconfined quantum critical point<sup>78</sup>. The  $P^*$  phase has a gapless photon mode. (b) Ising limit  $U < 0$ , the transition from the Ising ordered phase to the  $P^*$  may be first order driven by gauge field fluctuations indicated by a dot.

of two closely related models with non-compact and compact Maxwell gauge theories in (a) and (b), then we study the phase diagram of Eqn.C2 in (c).

(a) *Two component non-compact Maxwell theory*

If replacing the CS term in Eqn.C2 by a *non-compact* Maxwell term, we get

$$\mathcal{L}_{non} = |(\partial_\mu - ia_\mu)z_i|^2 + m^2|z|^2 + u|z|^4 + \frac{1}{4e^2}(f_{\mu\nu})^2 + U(|z_1|^2 - |z_2|^2)^2 - h_z(|z_1|^2 - |z_2|^2) \quad (\text{C3})$$

where  $f_{\mu\nu} = \partial_\mu a_\nu - \partial_\nu a_\mu$ .

This model had been studied in<sup>78</sup> in both isotropic  $U = 0$  and easy plane  $U > 0$  limit. Here we also study the Ising limit  $U < 0$ . In the easy-plane limit  $U > 0$ , the model was shown to be self-dual and there is a 2nd order transition through a deconfined quantum critical point<sup>78</sup>. Under the duality transformation, the spin and charge sectors exchange their roles on the two sides of the QCP. There is one QPT driven by the imbalance on both sides of the QCP which are XY and inverted XY transitions respectively, so the two transitions on the two sides are indeed dual to each other ( Fig.C1a )<sup>78</sup>. In the Ising limit  $U < 0$ , on the  $P^*$  side, the transition is still in the universality class of the inverted XY transition, but in the Ising order side, there is no transition, the theory is not self-dual anymore ( Fig.C1b ). The transition may even be a 1st order transition driven by the gauge field fluctuations.

The finite temperature phase diagram at the balanced case  $h_z = 0$  is shown in the Fig.2. There is one QPT driven by the temperature on both sides of the QCP which is in the universality class of the KT transition ( Fig.C2a )<sup>78</sup>. In the Ising limit  $U < 0$ , on the  $P^*$  side, the transition is still in the universality class of the KT transition, but in the Ising ordered side, the transition is in the universality class of the Ising transition, the theory

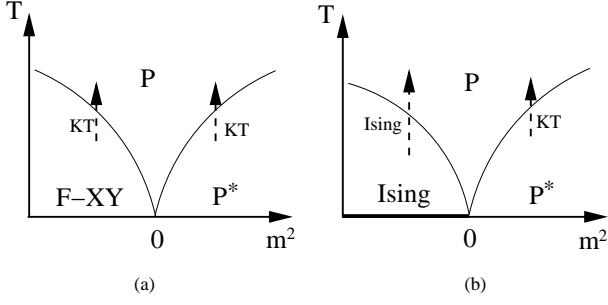

FIG. 14: The finite temperature phase diagram of Eqn.C3 at  $h_z = 0$ . (a) Easy-plane limit  $U > 0$  which is self dual. (b) Ising limit  $U < 0$  which is not self dual

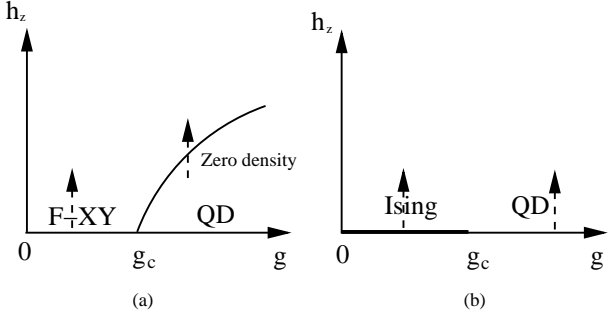

FIG. 15: The phase diagram of the Eqn.C4 at  $T = 0$ . (a) Easy-plane limit  $U > 0$  (b) Ising limit  $U < 0$ .

is not self-dual anymore.( Fig.C2b ).

### (b) Two component Compact Maxwell theory

However, if the Maxwell term in Eqn.C3 is *compact*, then the compact gauge field confine the  $z_\alpha$  fields into a single unit vector  $\vec{n} = z_\alpha^* (\vec{\sigma})_{\alpha\beta} z_\beta$ , it can be shown that the compact model becomes:

$$\mathcal{L}_{comp} = \frac{1}{2g} (\partial_\mu \vec{n})^2 + U(n_z)^2 - h_z n_z \quad (\text{C4})$$

In the easy plane limit, the model is *dual* to a one component superconductor in an external magnetic field  $h_z$  as described by Eqn.63. So there is one ( two ) QPT(s) for type I ( type II ) superconductor on the QD side only driven by the imbalance. The type II case was already shown in Fig.9. The type I case was shown in Fig.C3a. The zero density transition was discussed in<sup>51</sup>, it has the exact exponent  $z = 2, \nu = 1, \eta = 0$ . In the Ising limit, there is no transition on both sides as shown in Fig.C3b.

The finite temperature phase diagram at the balanced case  $h_z = 0$  is shown in the Fig.C4. On the ordered side, there is a KT transition in the easy-plane limit ( Fig.C4a ) and an Ising transition in the Ising limit ( Fig.C4b ).

So the phase diagram of the two component Maxwell

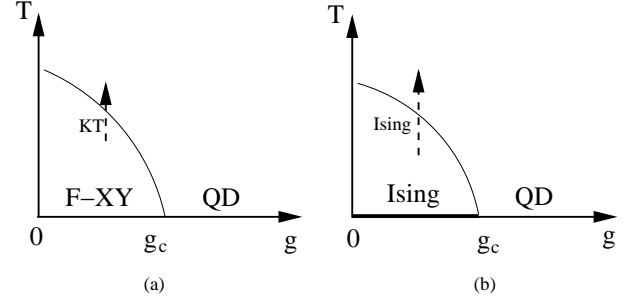

FIG. 16: The finite temperature phase diagram of Eqn.C4 (a) Easy-plane limit  $U > 0$  (b) Ising limit  $U < 0$ .

theory is very different depending on the Maxwell term is compact or non-compact.

### (c) Two components Chern-Simon theory

In the present model Eqn.C2 with the CS term, it was shown in<sup>80</sup> that in a pure compact Maxwell-Chern-Simon theory, monopoles are linearly confined by a string of magnetic flux due to the CS term. Following the procedures in<sup>73</sup>, it is easy to see that in the model Eqn.C2 where the two component relativistic bosonic matter fields  $z_\alpha, \alpha = 1, 2$  are coupled to a compact CS term, the monopoles remain confined, therefore the two component bosonic fields are deconfined. So the CS term is compact or not in Eqn.C2 will not lead to qualitative changes in the phase diagram. In the balanced case  $h_z = 0$ , in the easy-plane limit, due to the  $Z_2$  symmetry,  $z_1$  and  $z_2$  have to condense at the same time. When  $d < d_c$  ( $m^2 < 0$ ), the system is in the ILCQH which is a Quantum Hall state with  $\nu = 1$  integer Hall conductance  $\sigma_{xy} = e^2/h$  with a charge gap and a superfluid state with gapless Goldstone mode in the spin sector. While  $d > d_c$  ( $m^2 > 0$ ), the system is in a quantum disordered state with a spin gap, but charge gapless. In the imbalanced case  $h_z > 0$ , because  $z_1$  and  $z_2$  are *deconfined*, they do not have to condense at the same distance anymore. In the following, we discuss the Easy plane and Ising limit respectively. (1) Easy-plane limit,  $U > 0$  ( Fig.C5a ): On the QD side, when  $h_z > m^2$ ,  $z_1$  becomes condensed, the QPT is in the same universality class as the QH transition in a single layer system, namely, one component complex scalar coupled to a CS gauge field in  $2 + 1$  dimension. Let's call this transition: QD-SLQH. Starting from the SLQH at fixed  $h_z$ , if decreasing the distance further, the  $z_2$  will also condense, the system will get into the BLQH state with interlayer phase coherence, let's call this transition: SLQH-BLQH, because the  $U(1)$  CS gauge field is already broken by the  $z_1$  condensation, this transition is in the 3d XY universality class as shown in Fig.C5a. We can look at the transition from a different way: on the ILCQH side, when  $h_z > -m^2$ ,  $z_2$  becomes uncondensed. Obviously, the two transitions are not self-dual, in contrast to the non-compact Maxwell case in Fig.1. The QCP at  $d = d_c$  in Fig.C5a is essentially a Tetra-quantum-critical point. (2) Ising limit  $U < 0$  ( Fig.C5b

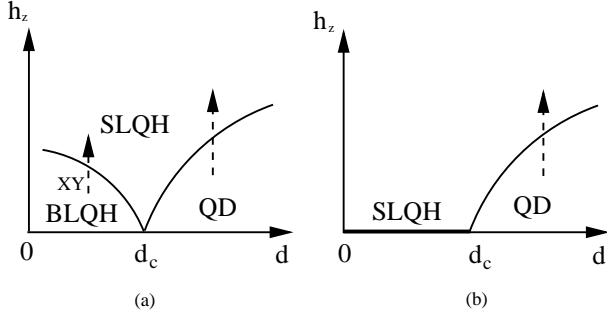

FIG. 17: The phase diagram of of Eqn.C2 at  $T = 0$ . (a) Easy-plane limit  $U > 0$ , there are three phases meeting at the Tetra-quantum critical point: (1) Bilayer Quantum Hall state with interlayer coherence  $\langle z_1 \rangle \neq 0, \langle z_2 \rangle \neq 0$  ( BLQH+ILCH ) (2) Single Quantum Hall state  $\langle z_1 \rangle \neq 0, \langle z_2 \rangle = 0$  (SLQH ) (3) Quantum Disordered state  $\langle z_1 \rangle = \langle z_2 \rangle = 0$ . (b) Ising limit  $U < 0$ , there is no BLQH state. The SLQH and the QD meets at a Bi-quantum critical point.

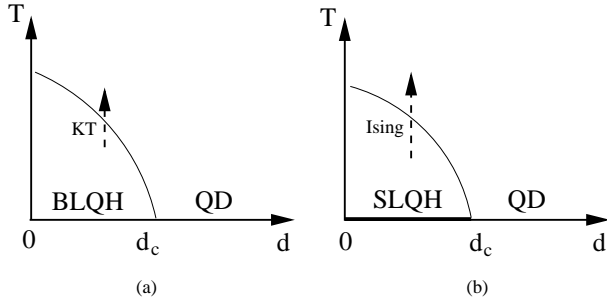

FIG. 18: The finite temperature phase diagram of Eqn.C2. (a) Easy-plane limit  $U > 0$  (b) Ising limit  $U < 0$

). At the balanced case, on the ordered side, there is only a SLQH state which has no gapless Goldstone mode, so there is no BLQH state. At finite  $h_z$ , there is a QD-SLQH transition in the disordered side, while there is no transition in the SLQH side. Note that the transitions in both easy plane limit (a) and Ising limit (b) are second order due to the exact marginality of the CS term, even the theory is not self-dual in both cases. This is in sharp contrast to the corresponding phase diagram Fig.C1 in the non-compact Maxwell theory.

The finite temperature phase diagram at the balanced case  $h_z = 0$  is shown in the Fig.C6. On the ordered side, there is a KT transition in the easy-plane limit ( Fig.C6a ) and an Ising transition in the Ising limit ( Fig.C6b ). Fig.C6 is similar to Fig.C4 to some extent.

One can compare Fig.C5(a) ( Fig.C6(a) ) with Fig.9(b) ( Fig.8 ) in the main text. As expected, they are different, because they are two different systems. The former is the BLQH system in a periodic potential, while the latter is the real BLQH in a continuous system.

- 
- <sup>1</sup> B. I. Halperin, *Helv. Phys. Acta* 56, 75 (1983); *Surf. Sci.* 305, 1 (1994)
- <sup>2</sup> For reviews of bilayer quantum Hall systems, see S. M. Girvin and A. H. MacDonald, in *Perspectives in Quantum Hall Effects*, edited by S. Das Sarma and Aron Pinczuk ( Wiley, New York, 1997).
- <sup>3</sup> J. P. Eisenstein, L. N. Pfeiffer and K. W. West, *Phys. Rev. Lett.* 69, 3804 (1992); Song He, P. M. Platzman and B. I. Halperin, *Phys. Rev. Lett.* 71, 777 (1993).
- <sup>4</sup> I. B. Spielman *et al*, *Phys. Rev. Lett.* 84, 5808 (2000). *ibid*, 87, 036803 (2001).
- <sup>5</sup> M. Kellogg, *et al*, *Phys. Rev. Lett.* 88, 126804 (2002).
- <sup>6</sup> M. Kellogg, *et al*, *cond-mat/0401521*.
- <sup>7</sup> J.P. Eisenstein and A.H. MacDonald, *cond-mat/0404113*.
- <sup>8</sup> H. Fertig, *Phys. Rev. B* 40, 1087 (1989).
- <sup>9</sup> X. G. Wen and A. Zee, *Phys. Rev. Lett.* 69, 1811 (1992).
- <sup>10</sup> Z. F. Ezawa and A. Iwazaki, *Phys. Rev. B.* 47, 7259; 48, 15189 (1993). *Phys. Rev. Lett.* 70, 3119 (1993).
- <sup>11</sup> Kun Yang *et al*, *Phys. Rev. Lett.* 72, 732 (1994). *Phys. Rev. B* 54, 11644 (1996).
- <sup>12</sup> K. Moon *et al*, *Phys. Rev. B* 51, 5138 (1995).
- <sup>13</sup> A. Stern, S. M. Girvin, A. H. MacDonald and N. Ma, *ibid* 86, 1829 (2001). Y. N. Joglekar and A. H. MacDonald, *Phys. Rev. Lett.* 87, 196802 (2001), Ziqiang Wang, *Phys. Rev. Lett.* 94, 176804 (2005).
- <sup>14</sup> Enrico Rossi, Alvaro S. Nnez, A.H. MacDonald, *Phys. Rev. Lett.* 95, 266804 (2005).
- <sup>15</sup> J. Schliemann, S. M. Girvin, A. H. MacDonald, *Phys. Rev. Lett.* 86, 1849 (2001).
- <sup>16</sup> A. López and E. Fradkin, *Phys. Rev. B* 51, 4347 (1995); *ibid*, 63, 085306, 2001. See also a review article by the two authors in *Composite Fermions: A unified view of the Quantum Hall Regime*, edited by Olle Heinonen. World Scientific (Singapore, 1998).
- <sup>17</sup> Yong Baek Kim *et al*, *cond-mat/0011459*.
- <sup>18</sup> M. Y. Veillette, L. Balents and M. P. A. Fisher, *Phys. Rev. B.* 66, 155401 (2002). Due to using  $\tilde{\phi} = 2$ , the authors concluded that the mutual Hall drag resistivity is  $2h/e^2$  which is in-consistent with the experimental result in<sup>5</sup>.
- <sup>19</sup> V. W. Scarola and J. K. Jain, *Phys. Rev. B* 64, 085313 (2001).
- <sup>20</sup> M. Kellogg, *et al*, *Phys. Rev. Lett.* 90, 246801 (2003).
- <sup>21</sup> P. Kapitza, *Nature* 141, 74 (1938).
- <sup>22</sup> D. D. Osheroff, R. C. Richardson, and D. M. Lee, *Phys. Rev. Lett.* 28, 885C888 (1972)
- <sup>23</sup> E. Kim and M. H. W. Chan, *Nature* 427, 225 - 227 (15 Jan

- 2004).
- <sup>24</sup> E. Kim and M. H. W. Chan, *Science* 24 September 2004; 305: 1941-1944.
- <sup>25</sup> A. Andreev and I. Lifshitz, *Sov. Phys. JETP* **29**, 1107 (1969).
- <sup>26</sup> G. V. Chester, *Phys. Rev. A* **2**, 256 (1970).
- <sup>27</sup> P. W. Anderson, W. F. Brinkman, David A. Huse, *Science* 18, 310: 1164-1166 (2005).
- <sup>28</sup> Jinwu Ye, *Phys. Rev. Lett.* 97, 125302 (2006); *cond-mat/0603269*,
- <sup>29</sup> P. W. Anderson, *cond-mat/9812063*.
- <sup>30</sup> Jinwu Ye, *Phys. Rev. Lett.* 86, 316 (2001).
- <sup>31</sup> Jinwu Ye, *Phys. Rev. Lett.* 87, 227003 (2001); *Phys. Rev. B.* 65, 214505 (2002).
- <sup>32</sup> The concept of MCF was implied previously in<sup>9,16,19</sup> in different languages. Here, we explicitly write down the relation between a MCF and an original electron by Eqn.2 which is more convenient to the following developments in the paper.
- <sup>33</sup> J. K. Jain, *Phys. Rev. Lett.* 63, 199 (1989).
- <sup>34</sup> A. Lopez and E. Fradkin, *Phys. Rev. B.* 44, 5246 (1991).
- <sup>35</sup> B. I. Halperin, P. A. Lee and N. Read, *Phys. Rev. B* 47, 7312 (1993).
- <sup>36</sup> See the review by G. Murthy and R. Shankar, *Rev. of Mod. Phys.* 75, 1101, 2003.
- <sup>37</sup> S. M. Girvin and A. H. Macdonald, *Phys. Rev. Lett.* 58, 1252 (1987).
- <sup>38</sup> S. Z. Zhang, T. H. Hansson and S. Kivelson, *Phys. Rev. Lett.* 62, 82 (1989). S. Z. Zhang, *Int. J. Mod. Phys. B* 6, 25 (1992).
- <sup>39</sup> Gun Sang Jeon and Jinwu Ye, *Phys. Rev. B* 71, 035348 (2005).
- <sup>40</sup> For discussions on relations between Abelian bosonization and Non-Abelian bosonization approaches to multi-channel Kondo model, see Jinwu Ye, *Phys. Rev. Lett.* 77, 3224 (1996).
- <sup>41</sup> Feymann originally conceived the 3d roton as drifting vortex loop. But this point of view is very controversial. If taking this view, then the 3d roton condensation can be considered as the vortex loop condensation. In 2d BLQH, the magneto-roton condensation in Fig.11 may be considered as that of the charge neutral meron pairs listed below Eqn.33 and Eqn.41.
- <sup>42</sup> In charge neutral superfluid  $^4He$ , the roton dispersion relation is  $\omega^2 \sim q^2(a - bq^2 + cq^4)$ . See<sup>28</sup>.
- <sup>43</sup> I. Ussishkin and A. Stern, *Phys. Rev. B*, 56, 4013 (1997); S. Sakhi, *Phys. Rev. B*, 56, 4098 (1997); Y. B. Kim and A.J. Millis, *Physica E (Amsterdam)* 4, 171 (1999).
- <sup>44</sup> M.E. Raikh and F. von Oppen, *Phys. Rev. Lett.* 89, 106601 (2002). V. M. Apalkov and M. E. Raikh, *Phys. Rev. B* 71, 245109 (2005).
- <sup>45</sup> If the transition were at  $q = 0$  in the Fig.5, the intermediate phase would be a featureless Exciton Liquid (EL) phase which respects all the symmetries even at  $T = 0$ . This kind of phase is extremely unlikely despite it was claimed by several authors in different contexts. This transition at  $q = 0$  will be discussed in the appendix C. This EL phase is the same as the quantum disordered (QD) phase in Fig.C3a and Fig.C4a.
- <sup>46</sup> Jinwu Ye, unpublished.
- <sup>47</sup> For a nice review on the KTHNY theory on two dimensional lattice, see the wonderful book by P. M. Chaikin and T. C. Lubensky, *Principles of Condensed Matter Physics*, Cambridge university press, 1995. Note that the hexatic phase in the KTHNY theory is still not convincingly established in experiments.
- <sup>48</sup> S. A. Brazovskii, *JETP* 41, 85 (1975).
- <sup>49</sup> For discussions on Classical Lifshitz Point (CLP) and their applications in nematic to smectic-A and -C transitions in liquid crystal, see the book in<sup>47</sup>.
- <sup>50</sup> L. Balents, L. Bartosch, A. Burkov, S. Sachdev, K. Sengupta, *Phys. Rev. B* 71, 144508 (2005).
- <sup>51</sup> Jinwu Ye, *cond-mat/0503113*.
- <sup>52</sup> P. A. Crowell and J. D. Reppy, *Phys. Rev. Lett.* 70, 3291C3294 (1993); *Phys. Rev. B* 53, 2701C2718 (1996).
- <sup>53</sup> H. Wiechert and K. Kortmann, *Phys. Rev. B* 70, 125410 (2004).
- <sup>54</sup> T. Senthil *et. al*, *Science* 303, 1490 (2004); *Phys. Rev. B* 70, 144407 (2004).
- <sup>55</sup> C. B. Hanna, *Bull. Am. Phys. Soc.* 42, 553 (1997)
- <sup>56</sup> Y. N. Joglekar and A. H. Macdonald, *Phys. Rev. B* 65, 235319 (2002).
- <sup>57</sup> W. R. Clarke, *et. al*, preprint
- <sup>58</sup> I.B. Spielman, *et al*, *cond-mat/0406067*.
- <sup>59</sup> Laughlin, in *The Quantum Hall Effects*, 2nd ed. edited by R. E. Prange and S. M. Girvin (Springer-Verlag, New York, 1990).
- <sup>60</sup> For light scattering experiments, see Aron Pinczuk, Chap. 8 in the book in<sup>2</sup>.
- <sup>61</sup> I thank B. Halperin for discussions leading to this point.
- <sup>62</sup> M. Peskin, *Ann. Phys.* 113, 122 (1978); C. Dasgupta and B. I. Halperin, *Phys. Rev. Lett.* 47, 1556 (1981).
- <sup>63</sup> Kun Yang, *Phys. Rev. Lett.* 87, 056802 (2001).
- <sup>64</sup> Jinwu Ye, *Phys. Rev. B* 71, 125314 (2005).
- <sup>65</sup> Longhua Jiang and Jinwu Ye, *Phys. Rev. B* 74, 245311 (2006).
- <sup>66</sup> S. Simon, E. H. Rezayi and M. V. Milovanovic, *Phys. Rev. Lett.* 91, 046803 (2003) .
- <sup>67</sup> A. Stern and B. I. Halperin, *Phys. Rev. Lett.* 88, 106801 (2002).
- <sup>68</sup> Ziqiang Wang, *Phys. Rev. Lett.* 92, 136803 (2004).
- <sup>69</sup> L. Brey, *Phys. Rev. Lett.* 65, 903 (1990); R. Cote, L. Brey and A. H. Macdonald, *Phys. Rev. B* 46, 10239 (1992); X. M. Chen and J. J. Quinn, *Phys. Rev. Lett.* 67, 895 (1991), *Phys. Rev. B* 45, 11054 (1992), *Phys. Rev. B* 47, 3999 (1993); L. Zheng and H. A. Fertig, *Phys. Rev. B* 52, 12282 (1995) S. Narasimhan and Tin-Lun Ho, *Phys. Rev. B* 52, 12291 (1995)
- <sup>70</sup> H. C. Manoharan, *et al*, *Phys. Rev. Lett.* 77, 1813 (1996); M. Shayegan in Chap. 9 in the book in<sup>2</sup>.
- <sup>71</sup> X. G. Wen, *Advances in Physics*, 44, 405-473 (1995).
- <sup>72</sup> I. Affleck and J. B. Marston, *Phys. Rev. B* 37, 3774 (1988).
- <sup>73</sup> N. Read and S. Sachdev, *Phys. Rev. B* 42, 4568 (1990).
- <sup>74</sup> S. Sachdev and Jinwu Ye, *Phys. Rev. Lett.* 70, 3339 (1993).
- <sup>75</sup> Kun Yang, *Phys. Rev. Lett.* 91, 036802 (2003).
- <sup>76</sup> Jinwu Ye and S. Sachdev, *Phys. Rev. Lett.* 80, 5409 (1998).
- <sup>77</sup> Jinwu Ye, *Phys. Rev. B* 60, 8290 (1999).
- <sup>78</sup> O I. Motrunich and A. Vishwanath; *cond-mat/0311222*.
- <sup>79</sup> X. G. Wen and Y. S. Wu; *Phys. Rev. Lett.* 70, 1501 (1993).
- <sup>80</sup> P. D. Pisarski, *Phys. Rev. D* 34, 3851 (1986); I. Affleck, *et. al*, *Nucl. Phys. B* 328, 575 (1989); M. C. Diamantini *et al*; *Phys. Rev. Lett.* 71, 1969 (1993).