

Modeling of the Peeling Process of Pressure-sensitive Adhesive Tapes with the Combination of Maxwell Elements

Katsuhiko SATO^{1*} and Akihiko TODA^{2†}

¹*Department of Pure and Applied Sciences, University of Tokyo, Komaba, Meguro-ku, Tokyo 153-8902, Japan*

²*Faculty of Integrated Arts and Sciences, Hiroshima University, Higashi-Hiroshima 739-8521, Japan*

A simple model for the peeling process of pressure-sensitive adhesive tape is presented. The model consists of linear springs and dashpots and can be solved analytically. Based on the modeling, the curved profile of the peeling tape is spontaneously determined in terms of viscoelastic properties of adhesives. Using this model, two experimental results are discussed: critical peel rates in the peel force and the peel rate dependence of the detachment process of adhesive from the substrate.

KEYWORDS: adhesive, Maxwell element, critical rates

1. Introduction

The behaviors of the peeling process of pressure-sensitive adhesive tape are very complex and interesting: (i) The peel force curve against the peel rate sometimes has two or three local maximums (Fig. 1).^{1,2} This fact implies that we will observe self-excited oscillation of the peel force, if the adhesive tape is peeled at a rate in the negative slope in Fig. 1.^{1,3} (ii) We observe fingerlike instabilities at the peel line, which is the interface between the adhesive and the rigid substrate (Fig. 2), and the front of failure waves along the peel line.⁴ (iii) In some adhesives, we observe caves inside the adhesive.⁶ The appearance of the caves indicates the flow of the adhesive; the adhesives are polymer melts with viscoelasticity.

In this paper, in order to describe the peeling system with viscoelastic adhesives, we present a simple model made of linear strings and dashpots and solve it analytically. A few attempts have already been made to incorporate the viscoelastic properties.^{7,8} The advantage of our modeling is on the spontaneous determination of the curved profile of the peeling tape with the viscoelastic adhesives.

Taking the advantage, we shall discuss the followings: (i) "critical peel rate" at which the peel force curve takes a local maximum and (ii) the positive dependence of the peel force on the peel rate, which is not trivial. Actually, it is not straightforward to derive positive dependence, and we approach this difficulty by considering more microscopic picture at the

*E-mail address: sato@complex.c.u-tokyo.ac.jp

†E-mail address: atoda@hiroshima-u.ac.jp

interface between the adhesive and the substrate in § 4.

2. Model

2.1 Frame of the model

We shall consider the system in two dimensions of the x-y plane in Fig. 2. In practice, there is z-direction dependence of the system with fingerlike instabilities along the peel line. However, with small amplitude of the fingering, this assumption will be justified.

The adhesive is represented by a set of linear springs (A) with spring constant k/N where N is the number of the springs per unit length along the x axis. These springs are numbered along the x axis as indicated in Fig. 3; k corresponds to the modulus of elasticity of the adhesive E_a and will be represented as $k = E_a\omega/y_0$ for the adhesive with the width ω and initial thickness y_0 . These springs can be elongated only along the y axis. We shall call this part of the model just "element"; the element will be replaced by another element, such as a series connection of linear spring and dashpot (the so-called Maxwell element) or various linear combinations of linear springs and dashpots.

Secondly, corresponding to the backing tape shown in Fig. 2, we consider flexible joints which connect adjoining springs (A) and are represented by linear springs (B) with spring constant NK , as shown in Fig. 3. This modeling assumes that the backing tape is a thin elastic object without bending; K corresponds to the modulus of elasticity of the backing tape E_b and will be represented as $K = E_b\omega\delta$ for the backing tape with the width ω and thickness δ . We admit that it is more realistic to describe the backing tape as a beam with flexural rigidity.¹⁰ However, if we adopt the bending of the beam, the equation system becomes much more complex, as shown in Appendix A, and the results are not essentially different from the results with the flexible joint of the linear springs (B). Therefore, we adopt this simpler model of the linear springs (B) as the flexible joint in the main part of the following discussion. In terms of the rigid substrate, it is represented by a horizontal line (C) (the x axis) as in Fig. 2. It is assumed that all elements and springs (B) are massless.

We impose on the elements a condition that the bottom of each element is detached from the line (C) when the force applied to the element becomes some critical value σ_c/N . Imposing this condition on the element corresponds to the situation where the adhesive is detached from the substrate when the normal stress of the adhesive at the interface reaches the critical value σ_c/w . Until § 4, we assume that the quantity σ_c is constant; the possibility of the peel rate dependence of σ_c is discussed in § 4. As a natural boundary condition, we assume there is no force at $x = \infty$.

Under these assumptions, let us now consider the following situation: the linear springs (A) and (B) are settled in the range $[-\infty, \infty]$ and there is no force acting on the springs in the initial stage. At $t = -\infty$, we begin to lift up quasi-statically one spring (B) at the left end at $x = -\infty$; since we move it quasi-statically, the force balance holds for every element at

every moment. We suppose that the force applied to the element at $x = 0$ reaches the critical value σ_c/N at $t = 0$ (we call such an element the “edge” of the elements hereafter because it is the boundary between the elements having left the substrate and the elements sticking to the substrate).

Under such situation, let us now try to obtain the shape of the curve drawn by the top ends of the elements (we call this curve “flexible joint’s curve” for brevity). First, we consider the force balance equation at the i -th element ($i > 0$):

$$-\frac{k}{N}f_i - NK(f_i - f_{i+1}) + NK(f_{i-1} - f_i) = 0, \quad (1)$$

where f_i is the y coordinate of the top end of the i -th element. From the conditions at $i = 0$ and $i = \infty$, we obtain the following relations:

$$\frac{k}{N}f_0 = \frac{\sigma_c}{N} \quad (2)$$

$$f_\infty = 0. \quad (3)$$

Taking the limit $N \rightarrow \infty$ in these relations and rewriting the coordinate f_i by $f(x)$ through the relation $x = \frac{i}{N}$, we obtain the equation for the flexible joint’s curve and its boundary conditions from (1)-(3):

$$Kf''(x) = kf(x) \quad (4)$$

$$Kf''(0) = \sigma_c \quad (5)$$

$$f(\infty) = 0 \quad (6)$$

where the prime over the function f means its derivative with respect to x . Solving eq. (4) under the boundary conditions (5) and (6), we have

$$f(x) = \frac{\alpha^2 \sigma_c}{K} e^{-x/\alpha}, \quad (7)$$

where $\alpha = \sqrt{\frac{K}{k}}$; α characterizes the range where the elements are stretched (we call this length the “stretching length” for brevity).

From the force balance relation at the 0th element, the peel force F applied to the spring (B) at $x = 0$ is represented by the flexible joint’s curve f , as follows,

$$F = \frac{k}{N}f_0 + NK(f_0 - f_1). \quad (8)$$

Then, after taking the limit $N \rightarrow \infty$, we have

$$F = -Kf'(0) \quad (9)$$

which implies for this model that

$$F = \alpha\sigma_c. \quad (10)$$

It is noted that the flexible joint's curve obtained in our modeling with more complex elements comprised of linear combination of springs and dashpots is also of the exponential form as

$$f(x) = f(0) e^{-x/\beta}, \quad (11)$$

where $f(0)$ and β are some positive constants; the proof is given in Appendix B. From the boundary condition (5) which is satisfied with more complex elements, $f(0)$ is turned out to be $f(0) = \beta^2 \sigma_c / K$. Then, with the general relationship (9) which is also satisfied with more complex elements, the peel force always has the form of

$$F = \beta \sigma_c. \quad (12)$$

This relation means that the peel force is given by the multiplication of the critical stress σ_c and the stretching length β . In the present modeling, this stretching length β is spontaneously determined in terms of the elastic modulus of the adhesive, k , and of the flexible joint, K . Therefore, when we keep both the elastic modulus of the flexible joint K and the critical stress σ_c constant, the peel force monotonically decreases as the adhesive gets stiffer with larger k . This relation becomes important in understanding the behavior with viscoelastic elements showing v dependence of k , as discussed in the following.

2.2 Case of Maxwell elements

As mentioned in § 1, since the adhesive is a polymer melt with visco-elasticity, it is more plausible to describe the adhesive in terms of Maxwell element of serial connection of spring and dashpot with spring constant, k , and viscosity, η . For the serial connection of spring and dashpot, the force acting on the element is given as $ky_1 = \eta \dot{y}_2$, where y_1 and y_2 represent the displacements of the spring and dashpot, and the dot over y_2 means its time derivative; the total displacement y is given as $y = y_1 + y_2$. The general solution of this system gives the applied force as $k \int_{-\infty}^t e^{-\frac{t-t'}{\tau}} \dot{y}(t') dt'$, where $\tau = \eta/k$ is the relaxation time of the Maxwell element.

Suppose that the spring (B) at the left end is lifted up with constant speed v at $t = -\infty$ and the system is in the steady state, then the y coordinate of the i -th element sticking to the substrate will be expressed as $f(i/N - vt)$. If the edge of the elements reaches $x = 0$ at $t = 0$, we get the following equation of $f(x)$ for the limit of $N \rightarrow \infty$ from the force balance at the i -th element ($i > 0$):

$$K f''(x) = k \int_{-\infty}^0 e^{t'/\tau} \dot{f}(x - vt') dt', \quad (13)$$

where x corresponds to i/N . It is useful to note that the visco-elastic properties of the element appears only in the right hand side of the above equation. The boundary conditions are the same as eqs. (5) and (6).

Suppose that the solution of this equation has an exponential form of eq. (11) and substitute it into eq. (13), then we get an algebraic equation for β :

$$\beta^2 - \frac{\alpha^2}{v\tau}\beta - \alpha^2 = 0. \quad (14)$$

where the condition $\beta > 0$ is set by the boundary condition (6), and hence

$$\beta = \frac{\alpha^2}{2v\tau} + \frac{1}{2}\sqrt{\left(\frac{\alpha^2}{v\tau}\right)^2 + 4\alpha^2}. \quad (15)$$

Using the boundary condition (5), we get $f(x) = (\beta^2\sigma_c/K)e^{-x/\beta}$ and we obtain the peel force represented as eq. (12) from the relationship (9). We have plotted in Fig. 5 the peel force F against the peel rate v for $\tau = 1$, $k = 1$, $K = 1$, and $\sigma_c = 1$.

For the case of Maxwell element with viscoelasticity, the exponential deformation brings an additional feature that the whole elements behave in a similar way; *i.e.* all elements behave as a viscous liquid at low peel rate and as an elastic solid at high rate, as shown in the following expression of the applied force to each element,

$$k \int_{-\infty}^0 e^{t'/\tau} \dot{f}(x - vt') dt' = \frac{v\tau\alpha}{1 + v\tau\alpha} kf(x) = \frac{1}{1 + v\tau\alpha} \eta \dot{f}(x) \quad (16)$$

In this sense, this system of peeling adhesive tape is essentially different from the system of a fracture of adhesive studied by de Gennes,¹¹ where the behavior of an viscoelastic adhesive depends on the position in the system. As the consequence of this behavior at the limiting of $v \rightarrow 0$, the stretching length β expressed by eq. (15) and consequently the peel force F diverges at $v = 0$, as shown in Fig. 5. The divergence of the peel force at $v = 0$ is obviously unrealistic. In the next section, we introduce more realistic model with a combination of springs and dashpots to describe the adhesive of polymer melt with slight cross-links.

We finally comment on the stability of this system. In the present analysis, the expression of $f(x - vt)$ assumes the instantaneous adjustment to the stationary state and hence assumes the stability. From the stability analysis of an analogous situation,⁵ we can put one comment to justify the assumption. If the whole system is hard enough to transfer the change in applied load to the elements in a shorter time interval in comparison with the relaxation time of the elements, the faster rate of detachment of the elements immediately brings smaller applied force on the elements under the condition of constant speed of lifting so that the detachment rate becomes slower, and vice versa. That is, for the hard system, the peeling edge tends to move with constant speed equal to the lifting velocity.

3. Explanation of Two Critical Peel Rates in Terms of the Model

As mentioned above, the adhesive is a polymer melt with small portions of cross-linking. The visco-elastic properties of the response to the deformation can be represented by two characteristic times; they are the times characterizing the transitions among the glass-like response for fast deformations, the rubber-like responses with entanglements behaving as

temporal cross-links and with true cross-linking for intermediate and slow rates of deformation, respectively, which are denoted by τ_g and τ_r ($\tau_g < \tau_r$), respectively.⁹

Thus we should construct the element of the model so as to have two relaxation times, as shown in Fig. 6, which consists of one linear spring with spring constant k and two different Maxwell elements which are specified by the elastic constants, k_r and k_g , and viscous constants, η_r and η_g , respectively; these quantities are related to the relaxation times τ_r and τ_g as: $\tau_r = \eta_r/k_r$ and $\tau_g = \eta_g/k_g$. We call each part of the element "spring (I)", "Maxwell element (II)" and "Maxwell element (III)," respectively. Note that spring (I) represents the effect of the cross-linked polymer within the adhesive.

The equation for $f(x)$ is

$$f''(x) = \alpha^{-2}f(x) + \alpha_r^{-2} \int_{-\infty}^0 e^{t'/\tau_r} \dot{f}(x - vt') dt' + \alpha_g^{-2} \int_{-\infty}^0 e^{t'/\tau_r} \dot{f}(x - vt') dt' \quad (17)$$

where $\alpha = \sqrt{K/k}$, $\alpha_r = \sqrt{K/k_r}$, and $\alpha_g = \sqrt{K/k_g}$. The boundary conditions are the same as eqs. (5) and (6).

The peel force is given as eq. (12). The stretching length β is the positive root of the following algebraic equation

$$\beta^{-2} = \alpha^{-2} + \alpha_r^{-2} v \tau_r / (\beta + v \tau_r) + \alpha_g^{-2} v \tau_g / (\beta + v \tau_g). \quad (18)$$

Plotting the peel force F against the logarithm of the peel rate v , as shown in Fig. 7, we can find two critical peel rates labelled by v_1 and v_2 . These two peel rates v_1 and v_2 corresponds to the rates at which the elastic modulus of the element gradually changes from k to $k + k_r$, and from $k + k_r$ to $k + k_r + k_g$, respectively, with increasing peel rate.

At a very low rate, Maxwell elements (II) and (III) do not contribute to the elastic modulus of the element because the elements have already been relaxed. Thus the elastic modulus of the element turns out to be k only, which is contributed by the spring (I). From the result around (7), the "stretching length" in that case is given by $\sqrt{K/k}$. Then, the time required for elongating each element until its detachment from the substrate is estimated to be $(1/v)\sqrt{K/k}$, where v is the peel rate (we call the time "stretching time"). As the peel rate increases, the stretching time $(1/v)\sqrt{K/k}$ gets closer to the relaxation time of Maxwell element (II), τ_r , and hence the elastic modulus of the element gradually changes from k to $k + k_r$. Thus the peel rate v_1 is estimated as,

$$v_1 = \frac{1}{\tau_r} \sqrt{\frac{K}{k}} \quad (19)$$

By the same logic, we can also estimate the peel rate, v_2 as,

$$v_2 = \frac{1}{\tau_g} \sqrt{\frac{K}{k + k_r}}, \quad (20)$$

In Fig. 7; we can actually see that the evaluated v_1 and v_2 correspond to the boundaries of the ranges.

As shown in Fig. 7, in our model with constant critical stress for the detachment σ_c , the peel force curve is a decreasing function of the peel rate and does not reproduce the experimental results of the positive slope. If σ_c is an increasing function of the peel rate, the peel force curve will then recover the positive dependence on peel rate with small regions having negative slopes around the two critical rates v_1 and v_2 . Then, the peel force curve will become very similar to the experimental results schematically shown in Fig. 1.

Of course, we cannot readily say the reason for the dependence of the critical normal stress σ_c on the peel rate (we are giving one possibility of the peel rate dependence of the critical stress in the next section), but it is probably obvious that the appearance of the two critical rates in the experiment is due to the changes in elastic modulus of the adhesive. Actually, by a lot of investigators, this relationship between the change in elastic modulus of the adhesive and the critical peel rates has been postulated.¹ We have succeeded in showing the relation between the critical peel rates and the relaxation times of the adhesive in terms of the quantities characterizing the viscoelastic properties of the adhesives.

4. On the Peel Rate Dependence of the Critical Normal Stress σ_c

As discussed in the previous section, if we calculate the peel force in our model with constant critical stress σ_c for detachment, we inevitably observe negative slope of the peel force, which is completely different from the experimental results even in the qualitative sense. Thus we must discuss the reason for the discrepancy in the slope in more detail.

The element of our model is a reduced one representing some part of the adhesive with finite size, so that the element can be considered to consist of more microscopic parts, such as polymer chains. So we can consider the bottom ends of the elements as the assembly of more microscopic parts as illustrated in Fig. 8 (we call them “small springs”).

Since these small springs are microscopic objects such as polymer chains, it is reasonable to assume that their processes of detachment and attachment are stochastic; each small spring is stochastically detached and attached to the substrate with some probabilities which generally depend on the force applied to the small spring.

We expect that the small springs are detached from the substrate more often as the applied force gets larger. We may also expect that the attachment process of each small spring depends on the applied force. But the dependence will be weaker, because the detached small springs will stay close to the substrate and will attach to the substrate almost equally for finite applied force. Thus we shall write down the time evolution equation for the amount A of small springs being attached to the substrate (which is a normalized quantity) as:

$$\frac{dA(t)}{dt} = -\frac{A(t)}{\tau_-(\sigma(t), A(t))} + \frac{1 - A(t)}{\tau_+}, \quad (21)$$

$$\equiv G(\sigma(t), A(t)) \quad (22)$$

$$\tau_-(\sigma, A) = \tau_0 \exp\left[\frac{U - \ell\sigma/A}{k_B T}\right] \quad (23)$$

$$\tau_+ = \tau_0 \quad (24)$$

where σ is the tensile force acting on the whole element; σ/A is the force acting on each small spring, ℓ is a constant having the dimensions of length, which corresponds to the width of the potential hole representing the attachment of small springs to the substrate. τ_0 is a constant with the dimension of time, U is a quantity representing the depth of the potential minimum, k_B is the Boltzmann constant, and T is the temperature of the system. When the quantity A vanishes the element leaves from the substrate.

We first examine the stationary case, i.e., where σ is independent of time. Solving the equation $G(\sigma, A) = 0$ for A and remembering that the sign of $\partial G(\sigma, A)/\partial A$ determines the linear stability of the solution, we readily find that the equation system has its reasonable solution only when σ is smaller than some critical value σ_s determined by the two equations $G(\sigma_s, A) = 0$ and $\partial G(\sigma_s, A)/\partial A = 0$; namely, σ_s is given by the following equation,

$$\sigma_s + \ln\left(\frac{\sigma_s}{k_B T}\right) = U - k_B T. \quad (25)$$

If σ is smaller than σ_s , A finally reaches a finite value in the steady state and the element is kept sticking to the substrate. If σ is larger than σ_s , on the other hand, A finally vanishes and the element is detached from the substrate.

The behavior with time-dependent σ is different from the stationary case. In our model, since the flexible joint's curve always has an exponential form, each element is subjected to σ varying exponentially with time; *i.e.* $\sigma(t) = e^{v't}$, in which v' is a parameter of a positive value. In such situation, σ at the detaching moment, σ_c , depends on the rate v' because of the finite relaxation time in the detachment process; A does not vanish immediately. We plot σ_c against the logarithm of v' in Fig. 9, where we have taken as the initial condition $A(t = 0) = A_0$ where A_0 is the stationary value of A for $\sigma = 0$ because it is natural to assume that there is no force action on each element before the peeling process starting (the explicit value is $A_0 = 0.999547$). Owing to the positive dependence on v' of σ_c , the positive slope will appear in the peel force curve as we usually observe experimentally.

5. Discussion and Conclusion

We presented a simple model to describe the peeling system, which is only made of linear springs and dashpots and solved the system analytically. With this modeling, the curved shape of the tape during the peeling is spontaneously determined in terms of the viscoelastic properties of the adhesive tape. The advantage of this characteristic is utilized in the discussion of the two critical peel rates being related with the viscoelastic properties of the adhesives.

We discussed in § 4 the possibility of the peel rate dependence of the critical stress for detachment; if σ_c is constant we can only predict negative slope of the peel force which is in

contradiction with experimental results. In order to explain the dependence, we considered the microscopic picture of the element consisting of small springs repeating attachment and detachment to the substrate. We admit that there may be other possibilities for the peel rate dependence of the “effective” critical stress, *e.g.*, the z dependence of the peel line with large amplitude of the fingering, etc. We have to carefully consider those possibilities theoretically and experimentally.

Acknowledgment

The authors thank Mr M. Ohtsuki (Tokyo University), Drs Y. Yamazaki (Waseda University) and T. Mizuguchi (Osaka Prefecture University) for valuable discussions. This research was supported by the 21st Century Center of Excellence Program of the Ministry of Education, Culture, Sports, Science, and Technology, Japan and by a Grant-in-Aid for Scientific Research from the Ministry of Education, Culture, Sports, Science and Technology of Japan.

Appendix A: Case of Bending Beam as the Backing Tape

We consider the backing tape as a beam with flexural rigidity $K_b = E_b I_{yy}$, where E_b represents the modulus of elasticity of the backing tape and I_{yy} is the moment of the inertia of area and is expressed as $I_{yy} = w\delta^3/12$ for the backing tape with the width w and thickness δ . The differential equation and its solution for the case of elastic adhesive has been obtained by Bikerman¹⁰ in the following way. Firstly, the differential equation of the curved profile of the beam $f(x)$ is given as,¹²

$$K_b \frac{d^4 f(x)}{dx^4} = -k f(x), \quad (\text{A}\cdot 1)$$

where k has the same meaning as in our modeling of the adhesive with springs (A): $k = E_a \omega / y_0$ for the adhesive with the modulus of elasticity E_a , the width ω and initial thickness y_0 . The boundary conditions are

$$K_b f''''(0) = -\sigma_c, \quad (\text{A}\cdot 2)$$

$$f(\infty) = 0 \quad (\text{A}\cdot 3)$$

and additionally from the moment of force and its balance at $x = 0$

$$f''(0) = 0, \quad (\text{A}\cdot 4)$$

$$F = K_b f'''(0). \quad (\text{A}\cdot 5)$$

Solving the differential equation (A.1) under the boundary conditions (A.2)-(A.4), we have

$$f(x) = \frac{\sigma_c}{k} e^{-x/\alpha_b} \cos(x/\alpha_b), \quad (\text{A}\cdot 6)$$

where $\alpha_b = (4K_b/k)^{1/4}$. The peel force F is then given from eq. (A.5) as,

$$F = \frac{\alpha}{2} \sigma_c \quad (\text{A}\cdot 7)$$

In the case of Maxwell elements having coefficients k and η , we can construct the equation system and solve it in a similar way. The differential equation for $f(x)$ is

$$\frac{d^4 f(x)}{dx^4} = -4\alpha_b^{-4} \int_{-\infty}^0 e^{t'/\tau} \dot{f}(x - vt') dt', \quad (\text{A}\cdot 8)$$

$$l(x) = \frac{1}{\tau} \int_{-\infty}^0 e^{t'/\tau} f(x - vt) dt \quad (\text{A}\cdot 9)$$

The boundary conditions and the relationship between F and f are the same as (A.2)-(A.5).

Supposing that f has the form $f(x) = Ae^{-x/\beta}$ and substituting this form in (A.8), we then have an algebraic equation for β ,

$$4\beta^4 + \frac{\alpha_b^4}{v\tau}\beta + \alpha_b^4 = 0 \quad (\text{A}\cdot 10)$$

Note that the real part of the root of this equation must be positive to satisfy the condition (A.3). We can find two such solutions; we denote them as $\beta_1^{-1} = \omega + i\gamma$ and $\beta_2^{-1} = \omega - i\gamma$, where both ω and γ are positive. Then, we can write f as

$$f(x) = Ae^{-\omega x} \cos(\gamma x + \theta), \quad (\text{A}\cdot 11)$$

where $\theta = \cos^{-1} \frac{2\omega\gamma}{\omega^2 + \gamma^2}$ ($0 < \theta < \pi$) and

$$A = \frac{1}{2\omega\gamma(\omega^2 + \gamma^2)} \frac{\sigma_c}{K_b} \quad (\text{A}\cdot 12)$$

which have been determined from (A.2) and (A.4). We can calculate the peel force from (A.5), (A.11) and (A.12),

$$F = \frac{1}{2\omega} \sigma_c \quad (\text{A}\cdot 13)$$

We plotted the peel force against the peel rate v in Fig. 10 for $K_b = 1.25, k = 1, \tau = 1$ and $\sigma_c = 1$. It should be noted that this result is essentially the same as the result of our modeling with the flexible joints of springs (B) shown in Fig. 5 in the following sense; (i) the peel force monotonically decreases with the peel rate; (ii) the peel force is saturated around some characteristic peel rate, which is estimated as $(1/\tau)(4K_b/k)^{1/4}$. (In the case of springs (B) it is estimated as $(1/\tau)(K/k)^{1/2}$.)

Appendix B: Proof of the Form $f(x) = f(0) e^{-x/\beta}$ for the Flexible Joints of Linear Spring (B)

In our model with the linear springs (B) as the flexible joint, whatever the linear combination of linear springs and dashpots, the equation for $f(x)$ necessarily takes the form as:

$$f''(x) = af(x) + b \dot{f}(x - vt) \Big|_{t=0} + \sum_{i=1}^M c_i \int_{-\infty}^0 e^{t'/\tau_i} \dot{f}(x - vt') dt'. \quad (\text{B}\cdot 1)$$

Here, a , b , and c_i ($i = 1, \dots, M$) are some non-negative constants and at least one of them must be nonzero, τ_i is the i -th relaxation time of the system, and the dot over f stands for the

differentiation of f with respect to time. For a parallel combination of spring, dashpot and Maxell elements, there is a direct correspondence between the elements and the terms in the r.h.s. of (B·1); the first term corresponds to the spring, the second term dashpot, and the third term Maxell elements. For more general combination, the expression of (B·1) still holds though there is no such correspondence.

Assume that the solution of (B·1) takes the exponential form of eq. (11) and substitute this form in (B·1), then we get an algebraic equation for β :

$$\beta^{-2} = a + bv\beta^{-1} + \sum_{i=1}^M c_i \frac{v\tau_i}{\beta + v\tau_i}. \quad (\text{B}\cdot 2)$$

We prove that the algebraic eq. (B·2) has one and only one positive solution. Let us first introduce a variable $\xi = 1/\beta$ and consider a function of ξ defined on the interval $[0, \infty]$,

$$g(\beta) = \xi^2 - a - bv\xi - \sum_{i=1}^M c_i \frac{v\tau_i\xi}{1 + v\tau_i\xi}. \quad (\text{B}\cdot 3)$$

We can readily find that $g''(\xi) > 0$ for all non-negative ξ , i.e., g is a convex function of ξ on that interval. On the other hand, for $a = 0$, we see that $g(0) = 0$ and $g'(0) < 0$ because at least one of b and c_i must be positive. For $a > 0$, we see that $g(0) < 0$. Noting $g(\infty) > 0$ and remembering that g is a convex function with respect to ξ , we readily see that the equation $g(\xi) = 0$ has one and only one positive solution and accordingly so does the eq. (B·2) for β ; we thus see the existence of a solution taking the form (11).

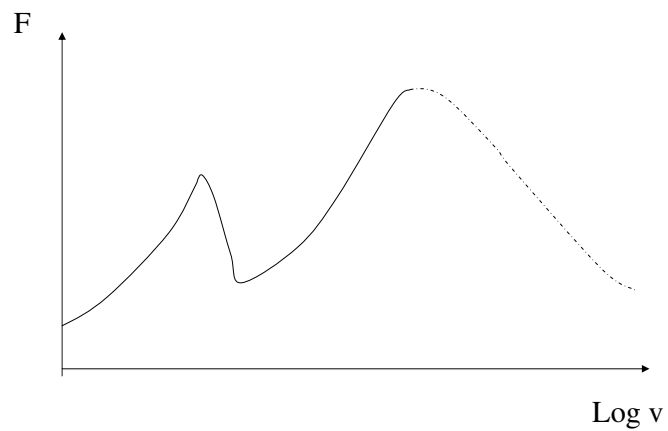

Fig. 1. Schematic picture of the peel force against peel rate observed experimentally. The solid line indicates the peel force when the system is in the steady state, while the dashed line indicates the average value of the peel force; oscillation never stops in that rate region.

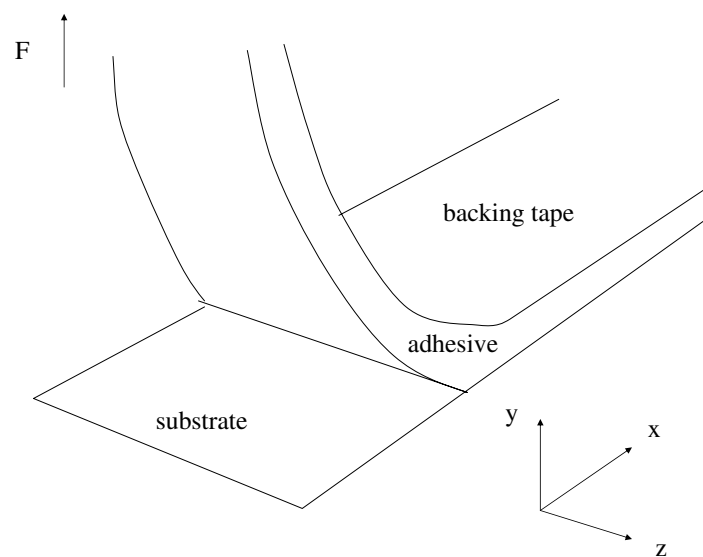

Fig. 2. Schematic illustration of the experimental system.

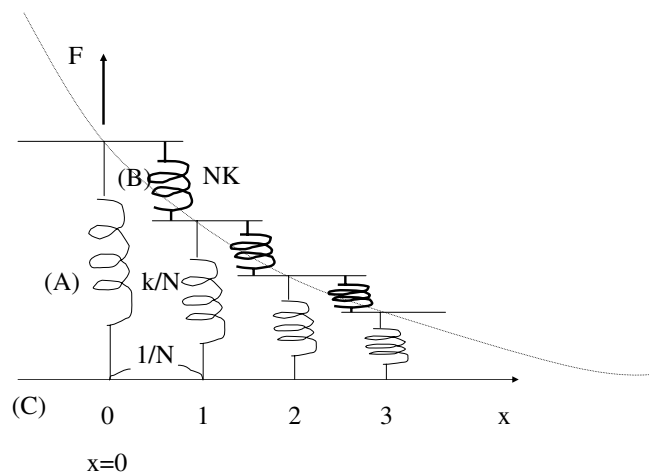

Fig. 3. Schematic picture of the prototype of the model with spring elements.

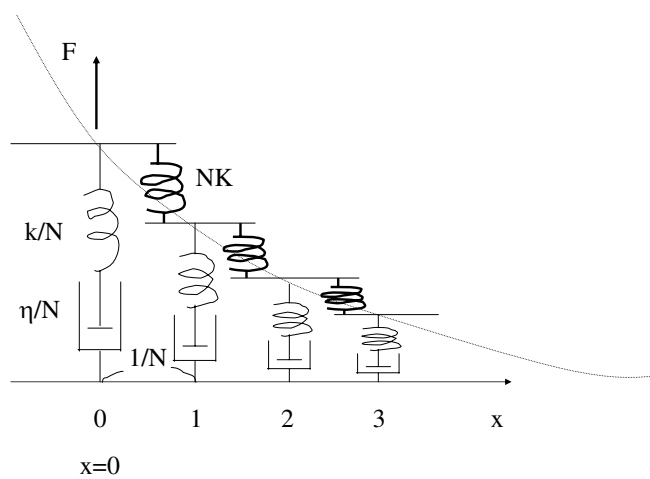

Fig. 4. Schematic picture of the model in the case of Maxwell element.

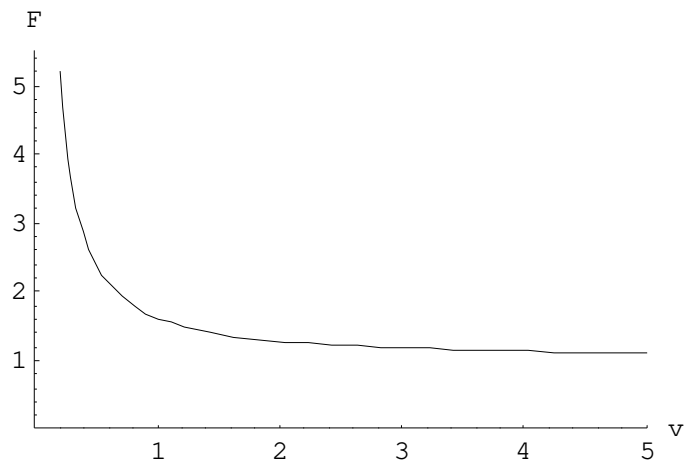

Fig. 5. The peel force against the peel rate with constant $\sigma_c (=1)$ obtained in the case of linear springs (B) with $K = 1$; where the element of the model is a Maxwell element with $\tau = 1$ and $k = 1$

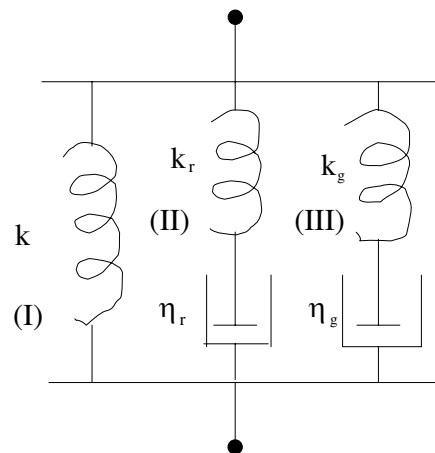

Fig. 6. Schematic picture of the element representing adhesive. The element has two relaxation times and the elasticity due to cross-links within the adhesive.

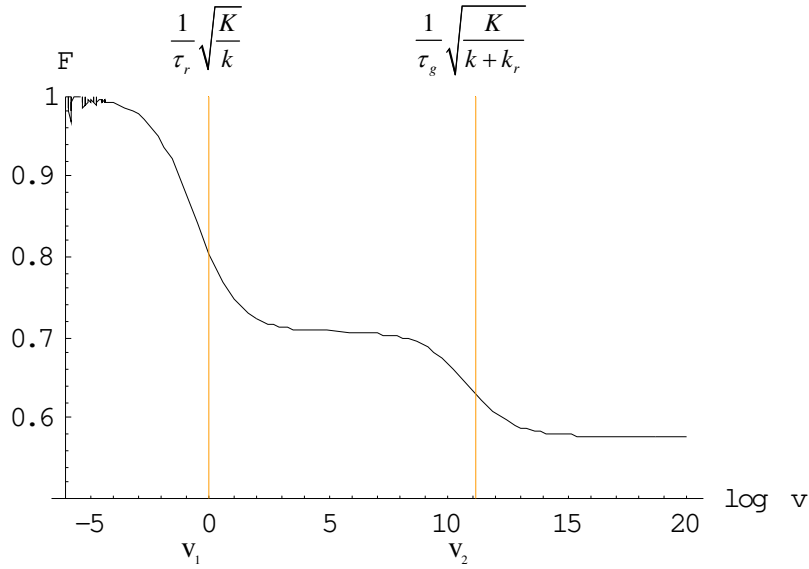

Fig. 7. The plot of peel force against the logarithm of the peel rate calculated from eqs. (12) and (18). Parameters are $\tau_g = 0.00001$, $\tau_r = 1$, $K = 1$, $k = 1$, $k_r = 1$, $\sigma_c = 1$, and $k_g = 1$. The gray line indicates v_1 and v_2 evaluated from eqs. (19) and (20).

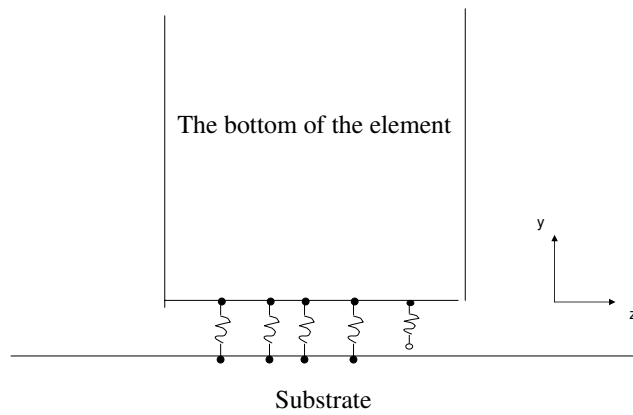

Fig. 8. Enlarged schematic picture of the bottom of the element. We shall consider the bottom of the element as an object consisting of small springs which are supposed to be detached and attached to the substrate stochastically.

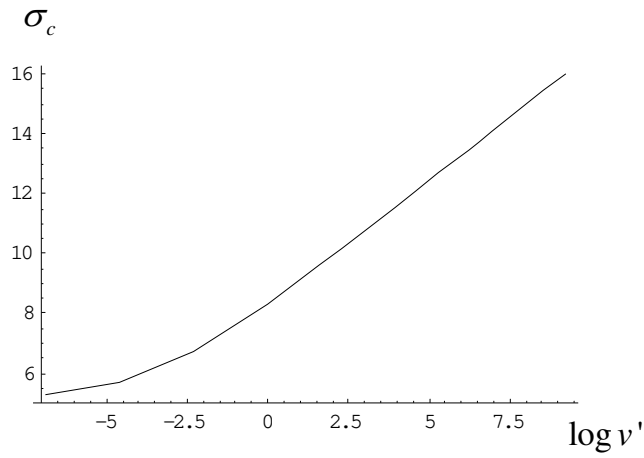

Fig. 9. Plot of σ_c against $\log v'$ calculated from eq. (21) with $\sigma(t) = e^{v't}$. The parameter values in the calculation are $\tau = 10$, $k_B T = 1$, $\ell = 1$, and $U = 7.7$. For these parameter values, $\sigma_s = 5.0734$.

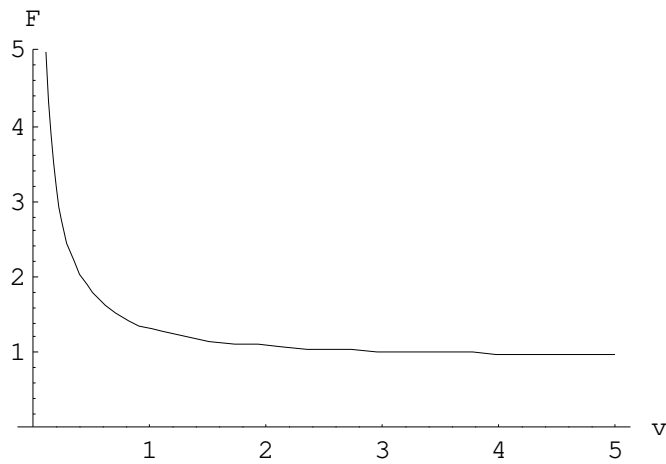

Fig. 10. The peel force against the peel rate with constant $\sigma_c (=1)$ obtained in the case of bending beam with $K_b = 1.25$; where the element of the model is a Maxwell element with $\tau = 1$ and $k = 1$, corresponding to Fig. 5 for the flexible joints of linear springs (B).

References

- 1) D. Satas: Handbook of pressure sensitive adhesive technology, edited by D. Satas, New York: Van Nostrand Reinhold, 1989, 2nd ed, Chap. 5.
- 2) D.H. Kaelble: J. Adhesion **1** (1969) 102.
- 3) Y. Yamazaki and A. Toda: Journal of the Physical Society of Japan **71** (2002) 1618.
- 4) R. J. Fields and M. F. Ashby: Philosophical Magazine **33** (1976) 33.
- 5) K. Sato: Progress of Theoretical Physics **102** (1999) 37.
- 6) Y. Urhama: J. Adhesion, **31** (1989) 47.
- 7) D.W. Aubrey: Adhesion 8, edited by K.W. Allen, Elsevier, 1984, Chap. 2.
- 8) H. Mizumachi: Journal of applied polymer science **30** (1985) 2675.
- 9) John D. Ferry: *Viscoelastic properties of polymers* (Wiley, New York, 1970) 2nd ed., pp 41-43.
- 10) J.J. Bikerman: Journal of applied physics **12** (1957) 1484.
- 11) P.G. de Gennes: Langmuir **12** (1996) 4497.
- 12) S.H. Crandall and N.C. Dahl: *An introduction to the mechanics of solids* (McGraw Hill, New York, 1959) Chap. 8.