

Residual Kondo effect in quantum dot coupled to half-metallic ferromagnets

Mariusz Krawiec

Institute of Physics and Nanotechnology Center, M. Curie-Skłodowska University, Pl. M. Curie-Skłodowskiej 1, 20-031 Lublin, Poland

E-mail: krawiec@kft.umcs.lublin.pl

Abstract. We study the Kondo effect in a quantum dot coupled to half-metallic ferromagnetic electrodes in the regime of strong on-dot correlations. Using the equation of motion technique for nonequilibrium Green functions in the slave boson representation we show that the Kondo effect is not completely suppressed for anti-parallel leads magnetization. In the parallel configuration there is no Kondo effect but there is an effect associated with elastic cotunneling which in turn leads to similar behavior of the local (on-dot) density of states (LDOS) as the usual Kondo effect. Namely, the LDOS shows the temperature dependent resonance at the Fermi energy which splits with the bias voltage and the magnetic field. Moreover, unlike for non-magnetic or not fully polarized ferromagnetic leads the only minority spin electrons can form such resonance in the density of states. However, this resonance cannot be observed directly in the transport measurements and we give some clues how to identify the effect in such systems.

PACS numbers: 75.20.Hr, 72.15.Qm, 72.25.-b

1. Introduction

Nowadays spin dependent phenomena play important role in the mesoscopic systems as they lead to potential applications in nanotechnology (spintronics) [1, 2] and quantum computing [2, 3]. Moreover new transport and thermodynamic phenomena can be observed in spintronic devices which are associated with the spin of the electron rather than the charge. Those include tunnel magnetoresistance (TMR) in magnetic tunnel junctions [4], spin dependent Andreev reflections [5], non-monotonic behavior of the superconducting transition temperature [6] and spontaneous currents in ferromagnet - superconductor proximity systems [7] or Kondo effect [8] in quantum dots (QD) coupled to the ferromagnetic leads [9]-[27].

The Kondo effect is a prime example of the many body physics in the quantum dot systems, i.e. formation of the many body singlet state by the on-dot spin and the conduction electron spins. This state gives rise to the resonance at the Fermi energy in the QD density of states and zero-bias maximum in differential conductance. The Kondo effect was predicted a long time ago [28]-[30], extensively studied theoretically [31]-[34] and confirmed in series of beautiful experiments [35]-[39] in the QD coupled to the normal (non-magnetic) leads.

If the normal leads are replaced by the ferromagnetic ones, the spin degrees of freedom start to play significant role in the transport and thermodynamic properties of the system, eventually leading to new phenomena. One of such new effects is the splitting of the Kondo resonance [12, 18, 19, 20, 25, 26] due to the spin dependent quantum charge fluctuations induced by the tunneling between QD and spin polarized leads. Remarkably it is possible to recover the full Kondo effect (no splitting) by applying of the external magnetic field [12, 19, 25, 26]. The splitting of the Kondo resonance strongly depends on the alignment as well as on the magnitude of the lead magnetizations. In particular when the magnetizations in both leads point in opposite directions (anti-parallel alignment), the full equilibrium Kondo effect survives for all values of the polarizations and there is no splitting of the zero energy resonance. In the differential conductance however the zero bias resonance is getting smaller and smaller as the leads become more polarized, finally leading to complete disappearance of the Kondo anomaly. On the other hand, in parallel configuration (magnetizations in both leads are parallel to each other) the Kondo resonance is split and gets suppressed when the magnitude of the polarization is being increased.

The presence of ferromagnetism in the electrodes can also lead to the quantum critical point with non-Fermi liquid behavior. It was shown recently [40] that the competition of spin waves (collective low energy excitations in a ferromagnet) and the Kondo effect is responsible for such a behavior. In this case the critical Kondo effect manifests itself in a fractional power law dependences of the conductance on temperature, and AC conductance and thermal noise on frequency ω . Thus the QD system with ferromagnetic electrodes can help us to understand the quantum critical phenomena in heavy fermions and other correlated electron systems.

In the present paper we show that if the leads are fully polarized, so the density of states in the leads is non-zero for one electron spin direction only, there is the Kondo effect, provided leads are in anti-parallel magnetization configuration. On the other hand in the parallel configuration there is no usual Kondo effect but there is an effect associated with elastic cotunneling which leads to similar behavior of density of states as in usual Kondo effect. Moreover, this effect occurs only in the minority spin electron channel when there is an unpaired spin on the dot and strong on-dot Coulomb interactions, i.e. when QD is in the Coulomb blockade regime.

The paper is organized as follows: in the Sec. 2 theoretical description of the QD coupled to the external leads is presented. Sec. 3 is devoted to various elastic and inelastic cotunneling processes in the case of half-metallic leads. In the rest of the paper the numerical results concerning the density of states (Sec. 4), applying of the external magnetic field (Sec. 5) and the transport properties (Sec. 6) are discussed, and finally, some conclusions are presented in the Sec. 7.

2. The Model

Our system under consideration is represented by the single impurity Anderson model Hamiltonian in the limit of strong on-dot Coulomb interaction ($U \rightarrow \infty$) in the slave boson representation where the real on-dot electron operator d_σ is replaced by the product of the boson b and the fermion f_σ operators ($d_\sigma = b^+ f_\sigma$) [41, 42]:

$$H = \sum_{\lambda\mathbf{k}\sigma} \epsilon_{\lambda\mathbf{k}\sigma} c_{\lambda\mathbf{k}\sigma}^+ c_{\lambda\mathbf{k}\sigma} + \sum_{\sigma} \varepsilon_{\sigma} f_{\sigma}^+ f_{\sigma} + \sum_{\lambda\mathbf{k}} (V_{\lambda\mathbf{k}\sigma} c_{\lambda\mathbf{k}\sigma}^+ b^+ f_{\sigma} + H.c.), \quad (1)$$

where $c_{\lambda\mathbf{k}\sigma}$ stands for the electrons with the single particle energy $\epsilon_{\lambda\mathbf{k}\sigma}$, the wave vector \mathbf{k} and the spin σ in the lead $\lambda = L, R$. ε_{σ} denotes the dot energy level and $V_{\lambda\mathbf{k}}$ is the hybridization matrix element between the electrons on the dot and those in the leads.

Within the Keldysh formalism [43], the total current $I = \sum_{\sigma} I_{\sigma}$ flowing through the quantum dot is given in the form:

$$I = \frac{e}{\hbar} \sum_{\sigma} \int d\omega \frac{\Gamma_{L\sigma}(\omega) \Gamma_{R\sigma}(\omega)}{\Gamma_{L\sigma}(\omega) + \Gamma_{R\sigma}(\omega)} [f_L(\omega) - f_R(\omega)] \rho_{\sigma}(\omega), \quad (2)$$

where we have introduced the elastic rate $\Gamma_{\lambda\sigma}(\omega) = \sum_{\mathbf{k}} |V_{\lambda\mathbf{k}}|^2 \delta(\omega - \epsilon_{\lambda\mathbf{k}\sigma})$, and $\rho_{\sigma}(\omega)$ is the spectral function of the dot retarded Green's function $G_{\sigma}^r(\omega)$, calculated within the equation of motion technique (EOM) in the slave boson representation [34, 44].

As is well known the EOM technique is reliable in the high temperature regime, however it also qualitatively captures the Kondo physics [34]. Moreover the EOM is the one of very few techniques which allows to study nonequilibrium properties of the spin polarized QD system.

Within this approach the dot retarded Green's function reads:

$$G_{\sigma}^r(\omega) = \frac{1 - \langle n_{-\sigma} \rangle}{\omega - \varepsilon_{\sigma} - \Sigma_{0\sigma}(\omega) - \Sigma_{I\sigma}(\omega) + i0^+}, \quad (3)$$

with non-interacting ($U = 0$)

$$\Sigma_{0\sigma}(\omega) = \sum_{\lambda\mathbf{k}} \frac{|V_{\lambda\mathbf{k}}|^2}{\omega - \epsilon_{\lambda\mathbf{k}\sigma}}, \quad (4)$$

and interacting self-energy

$$\Sigma_{I\sigma}(\omega) = \sum_{\lambda\mathbf{k}} \frac{|V_{\lambda\mathbf{k}}|^2 f_{\lambda}(\epsilon_{\lambda\mathbf{k}-\sigma})}{\omega - \epsilon_{\lambda\mathbf{k}-\sigma} - \varepsilon_{-\sigma} + \varepsilon_{\sigma}}, \quad (5)$$

which is responsible for the generation of the Kondo effect. $\langle n_{\sigma} \rangle$ is the average occupation on the QD, calculated under nonequilibrium within the standard scheme [34, 44].

To get the splitting of the Kondo resonance in the presence of the ferromagnetic leads we follow Ref. [12] and replace ε_{σ} on the r.h.s. of the Eq. (5) by $\tilde{\varepsilon}_{\sigma}$, which is found from the self-consistency relation

$$\tilde{\varepsilon}_{\sigma} = \varepsilon_{\sigma} + \text{Re}[\Sigma_{0\sigma}(\tilde{\varepsilon}_{\sigma}) + \Sigma_{I\sigma}(\tilde{\varepsilon}_{\sigma})]. \quad (6)$$

In numerical calculations we have chosen $\Gamma = \sum_{\lambda\sigma} \Gamma_{\lambda\sigma} = 1$ as an energy unit. The magnetization in the lead λ is defined as $p_{\lambda} = \frac{\Gamma_{\lambda\uparrow} - \Gamma_{\lambda\downarrow}}{\Gamma_{\lambda\uparrow} + \Gamma_{\lambda\downarrow}}$. For half-metallic leads (HM) we have $\Gamma_{L\uparrow} = \Gamma_{R\uparrow} = 0.5$ and $\Gamma_{L\downarrow} = \Gamma_{R\downarrow} = 0$ in the parallel configuration, while $\Gamma_{L\uparrow} = \Gamma_{R\downarrow} = 0.5$ and $\Gamma_{L\downarrow} = \Gamma_{R\uparrow} = 0$ in the anti-parallel configuration.

3. Tunneling processes

Before the presentation of the numerical results let us discuss various tunneling processes, associated with the second generation of Green functions obtained in the EOM procedure. They are the second order processes in the hybridization and describe elastic and inelastic cotunneling. The cotunneling is a process which leaves the charge on the dot unchanged. Moreover, elastic cotunneling does not change spin on the dot either, thus it leaves the dot in its ground state. On the other hand, the inelastic one changes the ground state [45].

As is well known the EOM approach is a non-perturbative technique, and one cannot assume that those processes are fully taken into account. They are rather incorporated in the calculations only qualitatively. It should be stressed that they are likely not the only processes as one may get the other processes of the same order or contributions to the ones discussed here, while going further in EOM procedure, i.e. calculating higher generation GFs. Unfortunately, an exact solution of the model is not known, and for the present purposes it is enough to consider those, shown in Fig. 1.

In Fig. 1 we show such elastic and inelastic single barrier (left panels) and double barrier (right panels) cotunneling processes which start from the spin up electron in the lead L and spin down electron on the dot (Coulomb blockade regime). There are also processes which start from lead R and can be obtained by replacing $L \rightarrow R$. In general, for not fully polarized leads there are processes for opposite spins ($\sigma \rightarrow -\sigma$) but in the case of half-metallic ferromagnetic leads in parallel configuration they are not allowed

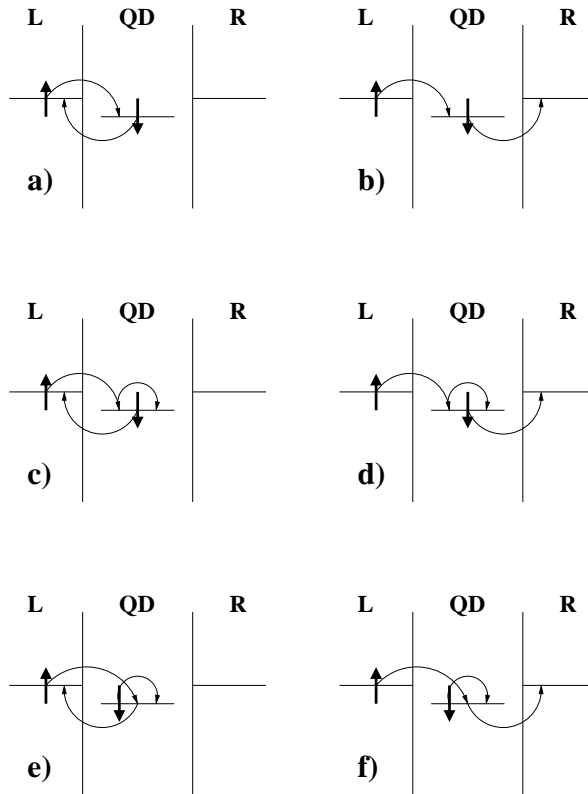

Figure 1. Various tunneling processes associated with second generation Green functions in the present EOM approach. For simplicity we have shown only processes starting from the left electrode. The remained ones can be obtained by replacing $L \rightarrow R$ and $\sigma \rightarrow -\sigma$ (see discussion in the text. Left panels show single barrier cotunneling and right panels - double barrier cotunneling events. Panels a) and b) show usual inelastic cotunneling, leading to the Kondo effect, changing the spin on the dot and in one or both electrodes. c) and d) are similar to a) and b) with additional annihilation and creation of the spin on the dot. All above processes change spin on the dot and in the lead(s). The processes displayed in panels e) and f) lead to the same final spin state on the dot (elastic cotunneling). In general the only processes contributed to the current across the dot are associated with double barrier cotunneling, displayed in panels b), d) and f). In the case of half-metallic ferromagnetic leads in the anti-parallel configuration the allowed processes are those in b), d) and e), but they do not contribute to the current, while in parallel configuration they are those displayed in e) and f) with the only f) giving a contribution to the current.

due to lack of the density of states for minority spin electrons in the leads. We do not show the processes with the same spins on the dot and in the lead, as well as those with empty dot state.

Panels a) and b) show the processes in which the electron with spin up tunnels from the lead L onto the dot and the electron with spin down tunnels from the dot into the lead L (a) or R (b)), describing inelastic cotunneling and leading to the usual Kondo effect, as the spin on the dot is changed. Similar situation is displayed in c) and d), namely, the dot starts with spin down and ends with spin up. However, during this

tunneling event, additionally, the spin up electron on the dot is annihilated and created. Those are renormalized inelastic cotunneling processes. In all above processes the spin on the dot and in the lead(s) is flipped, so those are the Kondo related processes. There are two more processes, shown in e) and f), in which there is no spin flip. The process starts with spin up in the lead L and ends with the same spin in lead L (e)) or R (f)). Similarly, the initial and the final spin state on the dot remains the same. Thus they describe also renormalized but elastic cotunneling, as the ground state remains unchanged. Both processes lead, as we shall see later on, to similar main features of the dot density of states as in usual Kondo effect.

As one can read off from Fig. 1, all the processes are allowed only if the leads are not polarized (paramagnetic) or not fully polarized. Moreover, the only processes contributed to the current across the dot are double barrier cotunneling processes, shown in b), d) and f).

In the case of the half-metallic ferromagnetic leads in anti-parallel (AP) configuration, the allowed processes are those shown in b), d) and e). However, they do not give any contribution to the current. In fact, processes b) and d), as they describe double barrier cotunneling, allow for the tunneling but once the electron with the spin down tunnels off the dot into the lead R, the spin up electron can tunnel from the lead L onto the dot and the further tunneling is blocked. The only possibility is the opposite process, namely, the spin up electron tunnels from the dot into the lead L and the spin down electron from the lead R tunnels onto the dot. Thus, in this case the electron transport is completely blocked. The process shown in e) also does not contribute to the current as in this case the electron starts and ends in the same lead (single barrier cotunneling). As a result, in the case of AP configuration there is no current through the quantum dot.

On the other hand, in the case of the half-metallic leads in parallel (P) configuration there is one process giving a contribution to the current. This is the process shown in Fig. 1f), coming from the Coulomb interaction. In this case the process starts with spin up in the lead L and ends with the same spin in the lead R, thus not changing the ground state (double barrier elastic cotunneling). Note that the inelastic cotunneling is not allowed in this case. This process at zero temperature has a finite probability in the Coulomb blockade only, i.e. when the dot energy level is below the Fermi energy of the electrodes, and there is strong on-dot Coulomb interaction. Moreover, this process is allowed only when the dot is occupied by spin down electron. It gives a non-zero contribution to the dot density of states below the Fermi level (shifted by $\varepsilon_{\uparrow} - \varepsilon_{\downarrow}$ in the parallel configuration) only (see Fig. 2 (bottom panel) and Fig. 4 (top panel)). It is shown in the next section that this process leads to similar main behavior of the density of states of the dot as the usual Kondo effect.

4. Density of states

In the Fig. 2 we show the spin resolved nonequilibrium ($\mu_R = -\mu_L = 0.2$) density of states (DOS) of the quantum dot coupled to the external leads. Top panel shows

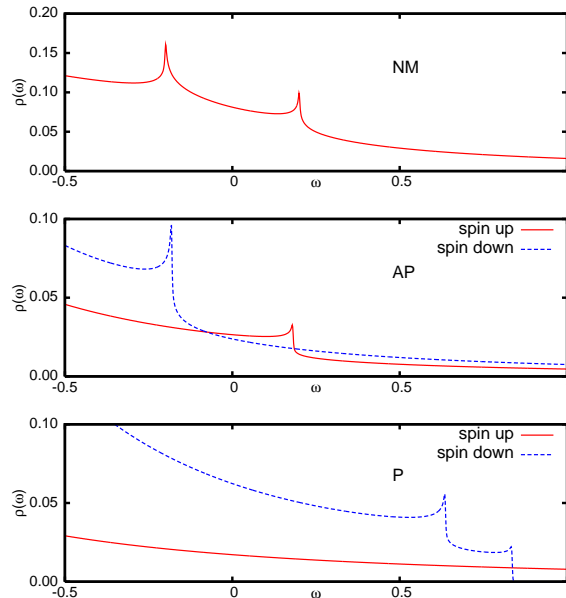

Figure 2. Nonequilibrium ($\mu_R = -\mu_L = 0.2$) density of states of the quantum dot coupled to non-magnetic (top panel), half-metallic leads in anti-parallel configuration (middle panel) and in parallel configuration (bottom panel). The solid (dashed) line shows the spin up (down) electron DOS. The model parameters are: $\varepsilon_\uparrow = \varepsilon_\downarrow = -2$, $T = 10^{-3}$. All energies are measured in units of Γ .

the usual DOS of the QD with non-magnetic (NM) leads where two Abrikosov-Suhl resonances located at the chemical potentials of the leads can be observed. The middle panel displays the DOS of the QD coupled to the half-metallic electrodes in anti-parallel (AP) configuration ($p_L = -p_R = 1$). It is worthwhile to note that we have now spin up Kondo resonance at $\omega = \mu_R$ (solid line) and no resonance at $\omega = \mu_L$. In this case the spin up on the dot is screened by the spins down in the lead R ($\Gamma_{R\downarrow} \neq 0$). For spin down electrons situation is opposite, the spin down on the dot is screened by the spins up in the lead L ($\Gamma_{L\uparrow} \neq 0$) and therefore there is a resonance for $\omega = \mu_L$ and lack of it for $\omega = \mu_R$. This is different from general case of $p < 1$, where two resonances at both chemical potentials are present (similarly as in non-magnetic case) [12].

Situation is quite different in the parallel (P) configuration ($p_L = p_R = 1$) where the spin up DOS (solid line in the bottom panel of the Fig.2) shows no signatures of the Kondo effect as the spin up on the dot cannot be screened by spins down in either lead ($\Gamma_{L\downarrow} = \Gamma_{R\downarrow} = 0$). However, in the spin down channel the residual Kondo-like state can be produced due to the processes shown in the Fig.1e) and f). This manifests itself in two resonances in the DOS located at $\omega = \Delta\varepsilon + \mu_\lambda$ (see dashed line in the bottom panel of the Fig. 2), where $\Delta\varepsilon = \varepsilon_\uparrow - \varepsilon_\downarrow$ is the splitting due to the ferromagnetic leads.

Such splitting has been also observed in general case of FM ($p < 1$) leads, where the charge fluctuations play significant role, i.e. when $2|\varepsilon_d| \neq U$ [12, 19, 20]. Note that in AP configuration there is no such splitting, again, in agreement with general case of $p < 1$ polarization [12, 19, 20].

Another important effect is a cutoff of the one of the resonances at the energy $\omega = \Delta\varepsilon + \mu_R$. This indicates that there is no direct tunneling of the spin down electrons and the resulting density of states comes from the virtual processes shown in Fig. 1e) and f) only, as discussed in Sec. 3.

Figure 3 shows the low temperature dependence of the full width at the half maximum (FWHM) of the narrow (Kondo) resonance in the density of states near ω_K , which equals to the Fermi energy ($\mu_L = \mu_R = 0$) when QD is coupled to the non-magnetic or half-metallic leads in AP configuration and $\omega_K = \Delta\varepsilon$ for half-metallic leads in P configuration. The points with errorbars show numerically found values of the

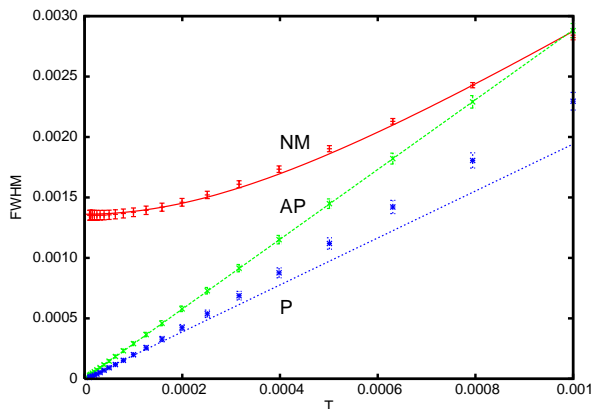

Figure 3. The low temperature behavior of the full width at the half maximum (FWHM) of the narrow (Kondo) resonance in NM, AP and P configurations.

FWHM. The Kondo temperatures in all cases have been found by fitting the function $FWHM = \sqrt{T_K^2 + aT^2}$ to those points. In the NM case it gives $T_K = 1.36 \cdot 10^{-3}$ while in the AP - $T_K = 1.07 \cdot 10^{-5}$. The lower T_K in AP configuration stems from the fact that the Kondo state in this case is formed by the electron spins in one lead only for a given direction of the spin on the dot. In the P configuration T_K is equal to zero as in this case there is no Kondo effect. Moreover in the P configuration the FWHM significantly deviates from the linear behavior for higher temperatures. On the other hand in the NM and AP configurations it is still linear above $T = 10^{-2}$ (not shown in the Fig. 3).

5. Compensation by the external magnetic field

Now, the question arises if the residual Kondo-like effect in P configuration can be compensated by the external magnetic field B . Compensation in this case means no splitting of the dot energy levels $\Delta\varepsilon = 0$. In the Fig. 4 we show the equilibrium ($\mu_L = \mu_R = 0$) spin down (top panel) and spin up (bottom panel) density of states

for different values of B field. As it is evident, magnetic field shifts the spin down

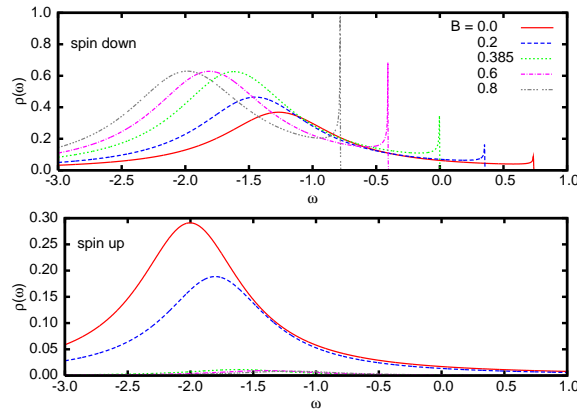

Figure 4. Equilibrium ($\mu_L = \mu_R = 0$) spin down (top panel) and spin up (bottom panel) density of states for various values of the external magnetic field indicated in the figure. At $B = B_{\text{comp}} = 0.385$ there is no splitting of the dot energy level, thus the Kondo effect is compensated. Note strong suppression of the spin up density of states for $B \geq B_{\text{comp}}$.

Kondo resonance and at $B = B_{\text{comp}} = 0.385$ it reaches the Fermi energy. No splitting $\Delta\varepsilon$ is observed in this case. Note that the Kondo resonance rapidly grows as B field is increased while the broad resonance around the dot energy level initially also grows up but for $B > B_{\text{comp}}$ remains almost unchanged (position of it changes only). The spin up density of states (bottom panel) shows different behavior. Namely, the broad charge fluctuation resonance starts to decrease with increasing of the B field and at $B = B_{\text{comp}}$ is remarkably small. This effect is associated with the change of the average occupation for different spin directions on the dot ($\langle n_\sigma \rangle$). When the B field increases, ε_\uparrow moves towards the Fermi energy while ε_\downarrow moves in opposite direction and therefore $\langle n_\uparrow \rangle$ decreases while $\langle n_\downarrow \rangle$ increases its value. This is clearly seen in the Fig. 5, where the occupations of the dot for both spin directions are shown. As one can see the spin up (down) occupation number decreases (increases) with the increasing of the external magnetic field B . As soon as the B field exceeds $B_{\text{comp}} = 0.385$, so one can think in this case about overcompensated residual Kondo-like effect, both occupation numbers remain almost constant, strictly speaking, they change very slowly towards 1 in the spin down channel (fully occupied state) and 0 in the spin up channel (empty state).

Corresponding non-equilibrium density of states for different magnetic fields is shown in Fig. 6. While the behavior is similar to that shown in Fig. 3, except the fact that there are two resonances now, one can see larger spin up density of states at $B = B_{\text{comp}}$. This is simply due to the smaller value of the spin down electron occupation number.

As we have seen the residual Kondo-like effect can be compensated by the external magnetic field. However, the compensation in this case means something different than in general case of $p < 1$. First of all, we have to remember that there is only one

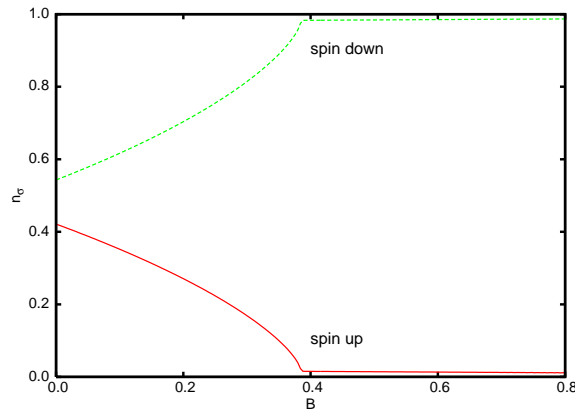

Figure 5. Evolution of the average spin dependent occupation number with the external magnetic field B . Note that with increasing of the B field the spin polarization (difference between the occupation of the spin up and the spin down electrons) also increases and remains almost constant (changes very slowly) for $B > B_{\text{comp}} = 0.385$.

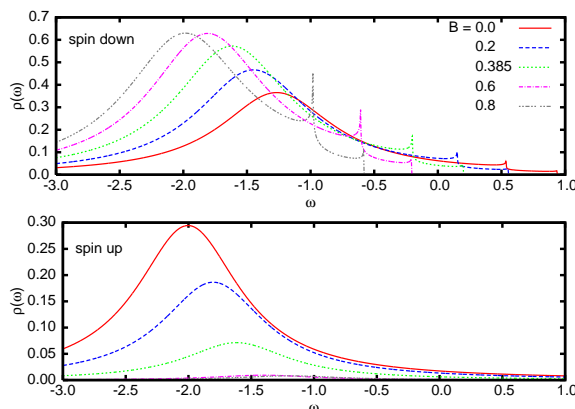

Figure 6. Non-equilibrium ($\mu_L = -\mu_R = -0.2$) spin down (top panel) and spin up (bottom panel) density of states for the same values of the external magnetic field as in Fig. 3.

resonance (for one spin direction only) in the DOS, which can be shifted to the Fermi energy by the external magnetic field. This is what we call the compensation. In general case of $p < 1$ there are two resonances (for both spin directions) in the DOS, which can be moved to the Fermi energy. Moreover, as it has been shown [12, 19], the occupations for both spin directions become equal at $B = B_{\text{comp}}$ - there is no spin polarization for such external magnetic field. In the case of HM ($p = 1$) leads, there is non-zero spin polarization, i.e. $\langle n_{\uparrow} \rangle \neq \langle n_{\downarrow} \rangle$ (see the Fig.5). Consequently, the spin on the dot cannot be fully screened by the spins in the leads, and there is no Kondo effect in the common sense. This is the main and important difference between the compensation effect in the case of HM and FM ($p < 1$) leads.

Finally, we would like to comment on the compensation of the Kondo effect in general case of the $p < 1$ within the present approach and compare it to the other

works known in the literature [12, 19, 20]. The obtained results and the conclusions are qualitatively the same as in the papers mentioned above. However, the values of the B_{comp} in the present work differs from those in Ref. [12] due to the fact that we have assumed spin dependent bandwidths in electrodes in order to have the densities of states in the leads normalized to 1. For this reason our approach gives the values of the B_{comp} smaller than those of Ref. [12], also obtained within EOM technique. Without this normalization requirement we get perfect quantitative agreement with that approach.

All this shows clear evidence of the usual Kondo effect in the DOS of the quantum dot coupled to the half-metallic ferromagnets in AP configuration and similar cotunneling related effect in P configurations. In both cases the density of states shows the splitting of the zero energy resonance caused by the nonequilibrium conditions ($\mu_L \neq \mu_R$) or the exchange field coming from the electrodes in P configuration and finally the compensation of it by the external magnetic field. Unfortunately, it is not possible to measure directly the density of states in transport experiments and the problem arises how to confirm this effect experimentally. In AP configuration there is Kondo effect for both spin directions but the tunneling current is zero in both cases due to the product of $\Gamma_{L\sigma}(\omega)\Gamma_{R\sigma}(\omega)$ (see Eq.(2)), which vanishes (see also discussion in the previous section). On the other hand, in P configuration the cotunneling related effect is present for minority spin electrons but there is no density of states in the electrodes for this spin direction. Hopefully, in this case presence of the effect in the minority electron channel modifies also the transport properties in the other channel, therefore in general it is possible to get some information on this effect.

6. Transport properties

Figure 7 shows the temperature dependence of the linear conductance $G = \frac{dI}{dV}|_{V \rightarrow 0}$ for different values of the external magnetic field B . At zero magnetic field conductance of QD coupled to the half-metallic leads is almost constant at low temperatures (panel a)), similarly as for QD with ferromagnetic leads where the polarization is $p = 0.8$ (panel b)). When B field increases, G of HM starts to decrease, unlike for FM system, where it grows up, and finally the Kondo effect is fully compensated at $B_{\text{comp}} = 0.165$. In HM system at $B = B_{\text{comp}} = 0.385$ (note that B_{comp} are different in HM and FM systems, simply due to different lead polarizations), the conductance decreases with T and at low temperatures is an order of magnitude smaller than at $B = 0$. The decrease of G is related to the suppression of the DOS in majority spin channel, as it can be read off from the Fig. 4. Such behavior of the conductance remains in agreement with the results obtained within numerical renormalization group technique (see the Fig. 4b) of Ref. [19]), where G is plotted as a function of the polarization for $B = B_{\text{comp}}$. For almost all values of the polarizations p the conductance is equal for both spin directions, except for p close to 1, where the G becomes spin polarized. In our case of $p = 1$, the conductance is fully polarized, as the only one spin channel contributes to the transport.

We have also calculated G in HM (panel c)) and FM (d)) system without elastic

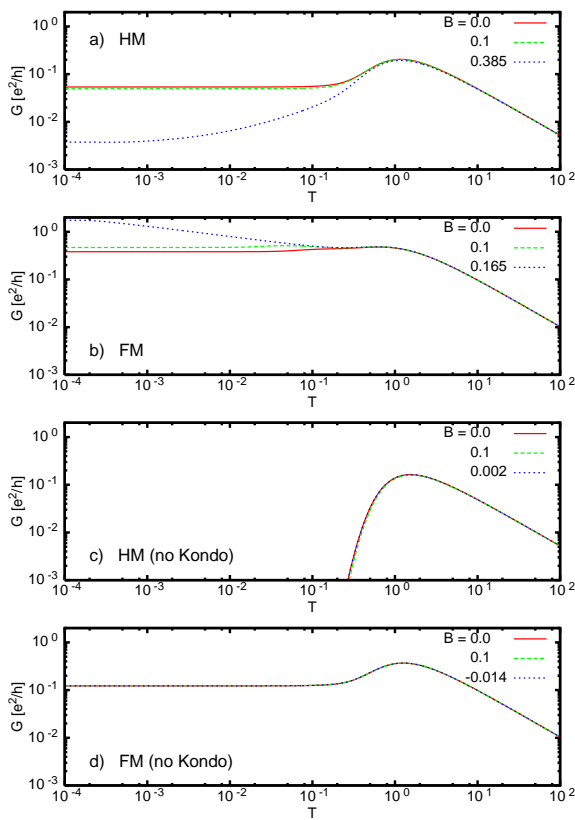

Figure 7. The linear conductance as a function of the temperature for the quantum dot coupled to the half-metallic a) and ferromagnetic leads b) with polarization $p = 0.8$. Note different behavior with respect to the external magnetic field. For ferromagnetic leads b) it is possible to get usual Kondo effect by tuning of the magnetic field. For half-metallic leads applying of the magnetic field $B = B_{\text{comp}}$ suppresses the conductance. Panels c) and d) show the same as a) and b) respectively with neglected cotunneling like correlations.

cotunneling and Kondo like correlations taken into account, neglecting interacting self-energy $\Sigma_{I\sigma}(\omega)$ in Eq.(3), which corresponds to skipping of all tunneling processes shown in the Fig. 1. It is clearly seen that the whole low temperature contribution to the conductance of QD with HM leads is due to the renormalized elastic cotunneling processes and therefore we can conclude that non-zero G is a signature of this effect. Conductance of QD coupled to FM leads without cotunneling correlations (panel d)) shows similar behavior as G for HM leads with those processes (panel a)) at $B = 0$. However, lack of the B dependence in this case can easily distinguish it from general case of QD coupled to HM leads. Therefore, such spectacular behavior of the conductance of the QD with HM leads can be, in general, possible to observe in transport measurements.

Additional insight into the problem can be reached from the behavior of the differential conductance vs bias voltage $eV = \mu_L - \mu_R$, displayed in the Fig. 8. As one can see in the figure (panel a)) there are temperature dependent small kinks at $eV = \pm\Delta\varepsilon$. For comparison the differential conductance of QD coupled to FM electrodes

with $p = 0.8$ is also shown (panel b)). As the temperature grows up, those kinks become suppressed. This is an additional clue which can be verified experimentally. We have observed no such kinks neither in HM nor in FM system without cotunneling like correlations taken into account.

7. Conclusions

In conclusion we have studied the properties of the quantum dot coupled to the half-metallic leads. In the case of parallel configuration, the effect associated with elastic cotunneling, which leads to similar behavior of the density of states, can be observed. The density of states shows the splitting of the zero energy resonance caused by the nonequilibrium conditions ($\mu_L \neq \mu_R$) or the exchange field coming from the electrodes and finally the compensation of it by the external magnetic field. However the compensation means the shift of the resonance (in the DOS) to the Fermi energy only, without additional conditions of equal occupations and equal conductances for both spin directions, as in the case of $p < 1$. This effect can be observed experimentally measuring the temperature dependence of the linear and differential conductances in the external magnetic field. On the other hand, in the case of AP configuration, the DOS shows usual Kondo effect but the transport is completely suppressed.

Acknowledgments

The author would like to thank Professor K. I. Wysokiński for valuable discussions and critical reading of the manuscript. This work has been supported by the KBN Grant No. 1 P03B 004 28.

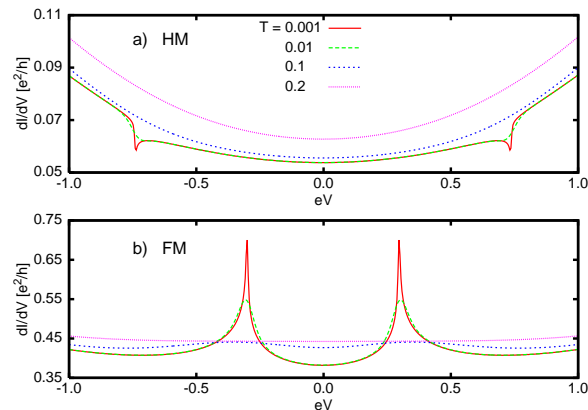

Figure 8. Differential conductance dI/dV of the QD coupled to HM a) and FM b) electrodes for various temperatures.

References

- [1] G. A. Prinz, *Science* **282**, 1660 (1998).
- [2] *Semiconductor Spintronics and Quantum Computation*, ed. D. Awschalom, D. Loss, D. Samarth, Springer, New York (2002).
- [3] D. Loss, D. P. DiVincenzo, *Phys. Rev.* **A57**, 120 (1998).
- [4] *Spin Dependent Transport in Magnetic Nanostructures*, ed. S. Maekawa, T. Shinjo, Taylor & Francis, London and New York (2002).
- [5] M. J. M. de Jong, C. W. J. Beenakker, *Phys. Rev. Lett.* **74**, 1657 (1995).
- [6] Y. A. Izyumov, Y. N. Proshin, M. G. Khusainov, *Phys. Usp.* **45**, 109 (2002).
- [7] M. Krawiec, B. L. Györfly, J. F. Annett, *Phys. Rev.* **B66**, 172505 (2002); *Eur. Phys. J.* **B32**, 163 (2003); *Physica C* **387**, 7 (2003); *Phys. Rev.* **B70**, 134519 (2004).
- [8] A. C. Hewson, *The Kondo Problem to Heavy Fermions*, Cambridge University Press, Cambridge, (1993).
- [9] A. N. Pasupathy, R. C. Bialczak, J. Martinek, J. E. Grose, L. A. K. Donev, P. L. McEuen, D. C. Ralph, *Science* **306**, 85 (2004).
- [10] J. Nygard, W. F. Koehl, N. Mason, L. DiCarlo, C. M. Marcus, cond-mat/0410467.
- [11] N. Sergueev, Q. F. Sun, H. Guo, B. G. Wang, J. Wang, *Phys. Rev.* **B65**, 165303 (2002).
- [12] J. Martinek, Y. Utsumi, H. Imamura, J. Barnaś, S. Maekawa, J. König, G. Schön, *Phys. Rev. Lett.* **91**, 127203 (2003).
- [13] R. Lu, Z. -R. Liu, cond-mat/0210350.
- [14] P. Zhang, Q. K. Xue, Y. P. Wang, X. C. Xie, *Phys. Rev. Lett.* **89**, 286803 (2002).
- [15] J. Ma, B. Dong, X. L. Lei, *Commun. Theor. Phys.* **43**, 341 (2005).
- [16] B. R. Bulka, S. Lipiński, *Phys. Rev.* **B67**, 024404 (2003).
- [17] R. López, D. Sánchez, *Phys. Rev. Lett.* **90**, 116602 (2003).
- [18] B. Dong, H. L. Cui, S. Y. Liu, X. L. Lei, *J. Phys.: Condens. Matt.* **15**, 8435 (2003).
- [19] J. Martinek, M. Sindel, L. Borda, J. Barnaś, J. König, G. Schön, J. von Delft, *Phys. Rev. Lett.* **91**, 247202 (2003).
- [20] M. -S. Choi, D. Sanchez, R. Lopez, *Phys. Rev. Lett.* **92**, 056601 (2004).
- [21] J. Ma, X. L. Lei, *Europhys. Lett.* **67**, 432 (2004).
- [22] J. König, J. Martinek, J. Barnaś, G. Schön, *CFN Lectures on Functional Nanostructures*, Eds. K. Busch et al., *Lecture Notes in Physics* **658**, Springer, 145 (2005).
- [23] J. Martinek, M. Sindel, L. Borda, J. Barnaś, R. Bulla, J. König, G. Schön, S. Maekawa, J. von Delft, cond-mat/0406323.
- [24] Y. Tanaka, N. Kawakami, *J. Phys. Soc. Japan* **73**, 2795 (2004).
- [25] D. Sanchez, R. Lopez, M. -S. Choi, *J. Supercond.* **18**, 251 (2005).
- [26] Y. Utsumi, J. Martinek, G. Schön, H. Imamura, S. Maekawa, cond-mat/0501172.
- [27] R. Świrkowicz, M. Wilczynski, J. Barnaś, cond-mat/0501605.
- [28] L. I. Glazman, M. E. Raikh, *JETP Lett.* **47**, 452 (1988).
- [29] T. K. Ng, P. A. Lee, *Phys. Rev. Lett.* **61**, 1768 (1988).
- [30] A. Kawabata, *J. Phys. Soc. Japan* **60**, 3222 (1991).
- [31] Y. Meir, N. S. Wingreen, P. A. Lee, *Phys. Rev. Lett.* **66**, 3048 (1991); *Phys. Rev. Lett.* **70**, 2601 (1993).
- [32] S. Hershfield, J. H. Davies, J. W. Wilkins, *Phys. Rev. Lett.* **67**, 3720 (1991); *Phys. Rev.* **B46**, 7046 (1992).
- [33] N. S. Wingreen, Y. Meir, *Phys. Rev.* **B49**, 11 040 (1994).
- [34] M. Krawiec, K. I. Wysokiński, *Phys. Rev.* **B66**, 165408 (2002).
- [35] D. Goldhaber-Gordon, H. Shtrikman, D. Mahalu, D. Abusch-Magder, U. Meirav, M. A. Kastner, *Nature* **391**, 156 (1998).
- [36] S. M. Cronenwett, T. H. Oosterkamp, L. P. Kouwenhoven, *Science* **281**, 540 (1998).
- [37] J. Schmid, J. Weis, K. Eberl, K. von Klitzing, *Physica B* **256-258**, 182 (1998); *Phys. Rev. Lett.*

- 84**, 5824 (2000).
- [38] F. Simmel, R. H. Blick, J. P. Kotthaus, W. Wegscheider, M. Bichler, Phys. Rev. Lett. **83**, 804 (1999).
- [39] S. Sasaki, S. De Franceschi, J. M. Elzerman, W. G. van der Wiel, M. Eto, S. Tarucha, L. P. Kouwenhoven, Nature **405**, 764 (2000).
- [40] S. Kirchner, L. Zhu, Q. Si, D. Natelson, Proc. Natl. Acad. Sci. USA **102**, 18824 (2005).
- [41] P. Coleman, Phys. Rev. **B29**, 3035 (1984).
- [42] J. C. Le Guillou, E. Ragoucy, Phys. Rev. **B52**, 2403 (1999).
- [43] H. Haug, A. P. Jauho, *Quantum Kinetics in Transport and Optics of Semiconductors*, Springer, Berlin (1996).
- [44] M. Krawiec, K. I. Wysokiński, Solid State Commun. **115**, 141 (2000).
- [45] D. V. Averin, Yu. V. Nazarov, in *Single Charge Tunneling*, Eds. H. Grabert, M. H. Devoret, Plenum Press (1992), NATO ASI Series B 294, p. 217.