

Aggregates of rod-coil diblock copolymers adsorbed at a surface

C. Nowak, T.A. Vilgis

Max-Planck-Institut für Polymerforschung, Ackermannweg 10, 55128 Mainz, Germany

The behaviour of rod-coil diblock copolymers close to a surface is discussed by using extended scaling methods. The copolymers are immersed in selective solvent such that the rods are likely to aggregate to gain energy. The rods are assumed to align only parallel to each other, such that they gain a maximum energy by forming liquid crystalline structures. If an aggregate of these copolymers adsorbs with the rods parallel to the surface the rods shift with respect to each other to allow for the chains to gain entropy. It is shown that this shift decays with increasing distance from the surface. The profile of this decay away from the surface is calculated by minimisation of the total free energy of the system. The stability of such an adsorbed aggregate and other possible configurations are discussed as well.

PACS numbers: 82.35.Gh Polymers on surfaces; 82.35.Jk Copolymers, phase transitions, structure; 36.20.Ey Conformation (statistics and dynamics)

I. INTRODUCTION

Rod-coil copolymers in selective solvents show a rich phase behaviour. Depending on the chain length and the solvent quality they may form cylindrical micelles or lamellar sheets. Similar phases can be found in melts of rod-coil copolymers. These systems are therefore widely studied in the literature [1, 2, 3, 4, 5, 6, 7, 8, 9, 10]. Less extensive are the studies on a single multiblock polymer composed of stiff rods which are connected by flexible chain spacers, see [11, 12, 13, 14]. It was shown, that these polymers can also form micellar and multi-micellar structures. The structural behaviour of dissolved rod-coil copolymers in the presence of a surface is far less understood. Rod-coil polymers grafted to a repulsive surface are shown to form 'turnip'- or 'jellyfish'-like micelles on top of the surface [15]. However, to our knowledge there exists no study of rod-coil polymers in the presence of an attractive surface.

In this paper we consider rod-coil diblock copolymers in selective solvent close to a surface which is highly attractive for the rods and neutral to the flexible parts of the copolymer. Further, the solvent is assumed to be poor for the rods, such that they align and tend to form aggregates, and good for the chains. In addition it is assumed that the rods have a certain chemical modification, such that they prefer to be parallel oriented with respect to each rather than antiparallel. The aggregation behaviour of such rod-coil copolymers, showing parallel alignment of the rods only, has been investigated experimentally and computationally, see [16, 17, 18]. We assume the energy penalty for antiparallel alignment of two rods to be much higher than the energy penalty for these rods being fully exposed to the solvent. In aggregates of these copolymers the flexible parts therefore stick out in one direction only, see Fig.(5). If such an aggregate adsorbs with the rods parallel to the surface, the rods shift with respect to each other to allow for the chains to gain entropy, see Fig.(1). The nature of this shift will be examined in the following.

For simplicity we consider a quasi two-dimensional sys-

tem. That means the width of the system in y -direction is equal to the rod diameter d . This system can be viewed as a narrow slice of a system with infinite extension in y -direction. Each of the diblock copolymers under consideration is composed of a stiff rod of length L and diameter d to which a fully flexible chain of N monomers with monomer size b is grafted. The solvent is characterised by an energy penalty γ per unit area of a rod exposed to the solvent. The energy gain $-\kappa$ per unit area of a rod for being in contact with the surface has to be chosen such that an aggregate actually adsorbs to the surface without dissociating into single rod-coil copolymers.

The paper is organised as follows. In a first naive approach one would assume a constant shift of the rods with respect to each other. This assumption leads to an artefact in the shifting behaviour, as we show in the appendix. The calculations in the appendix are presented in some detail because some of the intermediate results are used in section II and III. In a more sophisticated approach the shift is allowed to vary with distance from the surface such that it can develop a profile. This approach to the problem is presented in section II. Some remarks on the stability of the adsorbed structure and the corresponding range of values for κ are made in section III. In section IV we finish with a brief discussion of the results of the foregoing sections.

II. PROFILE OF THE SHIFT

When an aggregate of rod-coil copolymers becomes adsorbed by a strongly attractive surface, an additional confinement for the corona of the free chains may introduce new effects. One possibility is that the entropy penalty of the confinement of the corona chains due to the wedge defined by the surface and the rod aggregate prevents adsorption. Another extreme effect can be the destruction of the aggregate. In between, the balance between entropy and energy can be such, that the rods are shifted with respect to each other to allow for the chains to gain entropy. If this shift does not get to large, the rods stay

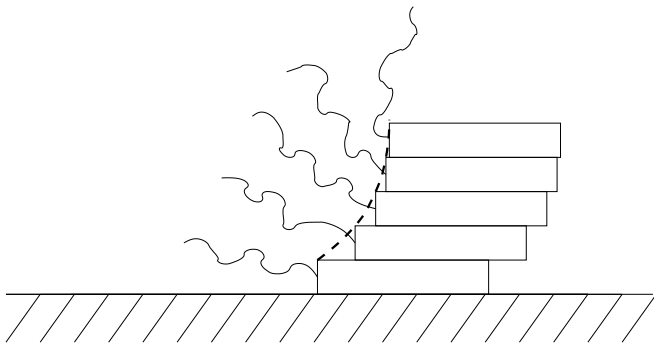

FIG. 1: Aggregate of rod-coil copolymers adsorbed at a surface. The shift of the rods with respect to each other decays with increasing distance from the surface.

together. Such conformations appear possible whenever the defect energy is balanced by the gain of entropy due to reduction of the wedge confinement.

The most naive assumption that the shift may be constant, i.e., it forms a line with a certain slope, turns out to be unphysical in many respects (see Appendix). Therefore it is necessary to introduce a curved deviation of the shift for each successive rod, which results from a total balance of all entropic and enthalpic contributions.

We present in this section the basic model which allows us to calculate the shift of the rods as a function of distance from the surface. From intuition we expect the rods close to the surface to shift more than the rods further away from the surface, since for the corresponding chains close to the surface there is more entropy to gain than for the ones further away. Therefore we expect an equilibrium conformation similar to the one shown in Fig.(1).

The dashed line in Fig.(1) can be interpreted as the profile of the shift l as a function of the distance x from the surface. The chains are described by a local Flory-type model similar to the one used in [19] to describe a finite polymer brush. In this model the free energy of the system is given by the sum of an elastic term and an excluded volume term for the chains plus a term which quantifies the energy penalty for the additional rod surface exposed to the solvent due to the shift. We construct the free energy such that it is a function of the splay of the chains $u(x)$ - see Fig.(2) - and the shift of the rods $l(x)$. At all positions x we can safely assume $l(x)$ to be small compared to the height h of the brush-like structure formed by the chains. If the shift l would be of the same order as h , the chains would hardly see each other, so there would be no driving force for a shift. Hence we can assume h to be constant for all x . The height is given by the equilibrium height of a polymer brush in good solvent, i.e. $h = 4^{-1/3} b N (b/d)^{2/3}$. The excluded volume parameter v is set to $v = b^3$ for simplicity.

Fig.(2) helps to define and explain how the excluded volume term of the free energy for the shift geometry is constructed. Note, that it is only a sketch. The ratio of

shift l to brush height is much smaller than depicted in Fig.(2). A chain starts at the rod and ends at the line

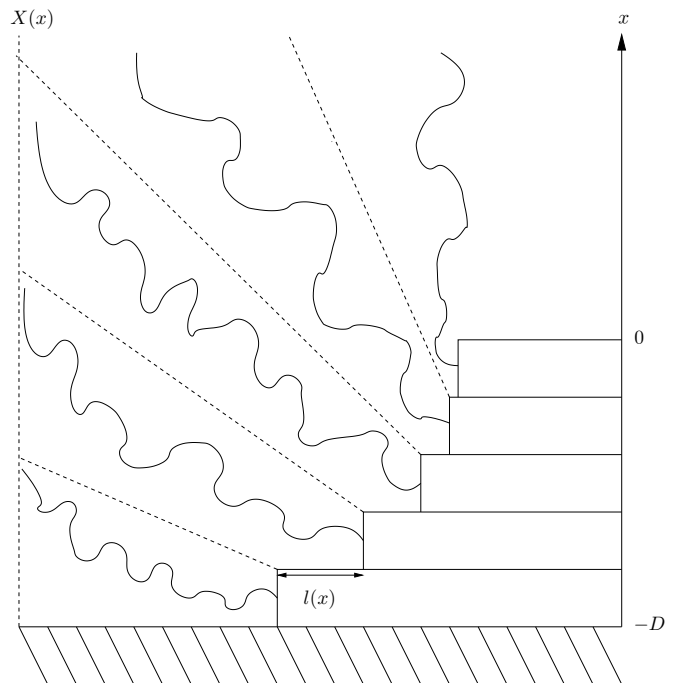

FIG. 2: This sketch shows the spatial segments or boxes filled by each chain. They get larger with increasing distance from the surface. The shift at each position x is denoted by $l(x)$. x ranges from $-D$ at the surface to 0 at the last rod. The splay of the chains is given by $u(x) = X(x) - x$.

$X(x)$ shown in Fig.(2). It is assumed to fill the volume of the box given by the dashed lines around the chains. We are aware that this assumption is not valid for the chains far away from the surface but for these chains the contribution of the excluded volume term is certainly very small. Hence the assumption does not affect the total free energy in a significant way. The splay $u(x)$ is given by $X(x) - x$. To explain how to calculate the volume available to each chain, Fig.(3) shows a larger sketch of one of the dashed boxes surrounding each chain in Fig.(2).

Inasmuch as we are going to consider a quasi two-dimensional system only, the volume is given by the grey area in Fig.(3) times the diameter of the rods d . The area $A_i^{(0)}$ shaded in light grey is given by $h(d + \Delta u_i/2)$, where $\Delta u_i = u_i - u_{i-1}$. It is the area $A_i^{(l)}$ shaded in dark grey where the shift of the rods $l(x)$ comes into play. It is given by

$$A_i^{(l)} = h q_i - \frac{1}{2} l_i q_i. \quad (1)$$

As can be seen from Fig.(3) the length q_i is given by

$$q_i = l_i \frac{u_{i-1}}{h} = l_i \frac{u_i - \Delta u_i}{h} \quad (2)$$

$$\Rightarrow A_i^{(l)} = l_i (u_i - \Delta u_i) \cdot \left(1 - \frac{l_i}{2h}\right). \quad (3)$$

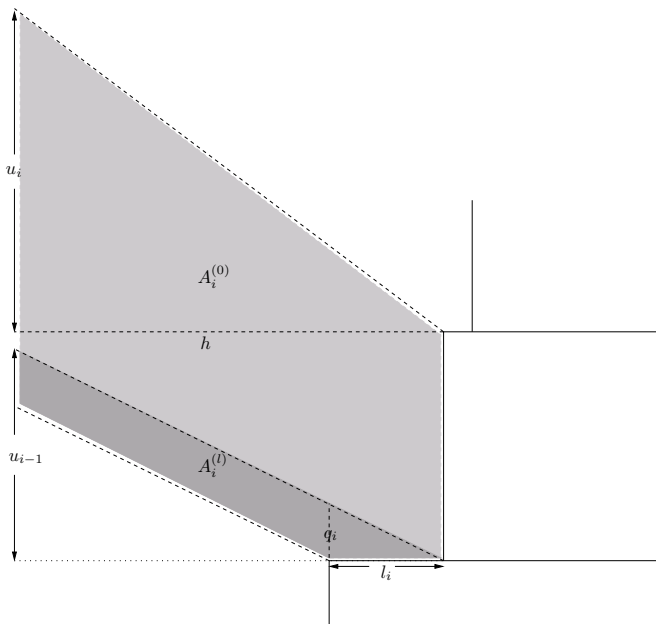

FIG. 3: This figure shows how the volume occupied by each chain is calculated as a function of splay u and shift l .

Since we assumed l_i to be small compared to h , the term in the last brackets in Eq.(3) can be approximated by 1. In Fig.(3) this corresponds to double counting the area of the small triangle with the catheti q_i and l_i .

In order to construct a free energy functional that could be minimised with respect to the shift and splay shapes $l(x)$ and $u(x)$ we take the continuum limit: $l_i \rightarrow l(x)$, $u_i \rightarrow u(x)$, $\Delta u_i \rightarrow du'(x)$. Taking the continuum limit and adding the two contributions, the total volume $V(x)$ available to a chain at position x is given by

$$V(x) = d^2 h (1 + u'(x)/2) + dl(x)(u(x) - du'(x)). \quad (4)$$

The elastic term of the free energy is given by a contribution proportional to h^2 representing the stretching of the chains away from the rods and a contribution proportional to $u(x)^2$ representing the stretching of the chains parallel to the rods. The energy penalty for the additional area of a rod at position i exposed to the solvent as a function of the shift l_i is simply given by $2\gamma l_i d$. The complete free energy functional can now be constructed.

$$\beta F = 2 \int_{-D}^0 dx \beta \gamma l(x) + \frac{1}{N b^2 d} \int_{-D}^0 dx [u(x)^2 + h^2] + \frac{N^2 b^3}{2d} \int_{-D}^0 dx \left[\frac{1}{hd^2(1 + u'(x)/2) + dl(x)(u(x) - du'(x))} \right]$$

For simplicity we dropped all terms which do not depend on either l or u . As already mentioned the excluded volume parameter v is set to $v = b^3$.

The excluded volume term in Eq.(5) was constructed assuming constant density of monomers for each chain within the box of volume V (Eq.(4)). The monomer density close to the rods is larger than the one further away from the rods and therefore this assumption tends to underestimate the excluded volume energy. However, it is the standard approximation used in Flory-type models and has been proven to be sufficient to describe the behaviour of a finite polymer brush, see [19].

The total length D of the rod aggregate perpendicular to the surface is assumed to be $D \geq h$. This is explicitly needed in the appendix.

Fig.(2) shows that the rod at the surface has zero shift since there is no other rod underneath with respect to which it could shift. So for the rod-coil copolymer at the surface the integrand in Eq.(5) reduces to the one in Eq.(A1) in the appendix (with $\sigma = 1/d^2$). This of course also means that the equation for the shift (Eq.(8) below) is only valid from the second rod on (as counted from the surface).

To calculate the equilibrium shift $l(x)$ it is necessary to compute the Euler-Lagrange equations from a functional minimisation of Eq.(5) with respect to $u(x)$ and $l(x)$. The Euler-Lagrange equation for the splay $u(x)$ has the first integral

$$2\beta\gamma l(x) + \frac{u(x)^2 + h^2}{N b^2 d} + \frac{N^2 b^3}{d} \left[\frac{1}{hd^2(2 + u'(x)) + 2dl(x)(u(x) - du'(x))} + \frac{(h - 2l(x)) u'(x)}{(hd(2 + u'(x)) + 2l(x)(u(x) - du'(x)))^2} \right] = C_1. \quad (6)$$

Variation of the free energy functional in Eq.(5) with respect to $l(x)$ yields

$$2\beta\gamma + \frac{2N^2 b^3}{d^2} \left[\frac{u(x) - du'(x)}{(hd(2 + u'(x)) + 2l(x)(u(x) - du'(x)))^2} \right] = 0. \quad (7)$$

The quadratic Eq.(7) can be solved for the shift $l(x)$.

$$l(x) = \frac{\left(\frac{b^3 N^2}{d^2 \beta \gamma} (u(x) - du'(x)) \right)^{\frac{1}{2}} - hd(2 + u'(x))}{2(u - du'(x))} \quad (8)$$

Inserting the expression for the shift - i.e. Eq.(8) - into Eq.(6) results in a complicated, highly nonlinear differential equation which cannot be solved exactly. However, the overall effect of the shift on the free energy is certainly smaller than the overall effect of the splay. Thus it is a reasonable approximation to calculate the solution for the splay at zero shift and to use this as an approximation for the splay u in Eq.(8). We are aware that this approximation breaks down when the splay becomes very small close to the surface. Nevertheless, for zero splay the shift should be constant. The shape of the profile of the shift away from the surface at finite splay can therefore be calculated within this approximation.

Now we calculate an approximate solution of the splay u for zero l . If the shift $l(x)$ in Eq.(6) is set identical zero, the differential equation reduces to

$$\frac{u(x)^2 + h^2}{Nb^2d} + \frac{2N^2b^3}{hd^3} \left[\frac{1 + u'(x)}{(2 + u'(x))^2} \right] = C_1 \quad (9)$$

$$\Rightarrow u^2 + 8h^2 \frac{1 + u'}{(2 + u')^2} = C_2 \quad (10)$$

which is Eq.(A2) from the appendix as should be. It is convenient to introduce dimensionless variables $\tilde{u} = u/(\sqrt{8}h)$, $\tilde{x} = x/(\sqrt{8}h)$ and $\tilde{C}_2 = C_2/(8h^2)$. Eq.(10) can be integrated for arbitrary \tilde{C}_2 which leads to an implicit equation for the splay $\tilde{u}(\tilde{x})$ similar to Eq.(A3)

$$2\tilde{u}_0 - 2\tilde{u} + \ln \left[2\tilde{u} + (1 - 4\tilde{C}_2 + 4\tilde{u}^2)^{1/2} \right] - \ln \left[2\tilde{u}_0 + (1 - 4\tilde{C}_2 + 4\tilde{u}_0^2)^{1/2} \right] = 4\tilde{x}. \quad (11)$$

Note that $-\tilde{D} \leq \tilde{x} \leq 0$. The integration constant \tilde{C}_2 can be determined by using the boundary condition $\tilde{u}(-\tilde{D}) = 0$ - i.e. zero splay at the surface, see Fig.(2).

$$\tilde{C}_2 = \frac{1}{4} \left(1 - \tilde{u}_0^2 \sinh \left[2\tilde{D} + \tilde{u}_0 \right]^{-2} + \tilde{u}_0^2 \cosh \left[2\tilde{D} + \tilde{u}_0 \right]^{-2} \right) \quad (12)$$

The chain furthest away from the surface at $x = 0$ can topple over completely and is therefore allowed a splay $u_0 = h$ or $\tilde{u}_0 = 1/\sqrt{8}$. Therewith Eqs.(11,12) reduce to

$$1/\sqrt{2} - 2\tilde{u} + \ln \left[2\tilde{u} + (1 - 4\tilde{C}_2 + 4\tilde{u}^2)^{1/2} \right] - \ln \left[1/\sqrt{2} + (3/2 - 4\tilde{C}_2)^{1/2} \right] = 4\tilde{x}, \quad (13)$$

$$\tilde{C}_2 = \frac{1}{8} \left(2 - \sinh \left[4\tilde{D} + 1/\sqrt{2} \right]^{-2} \right). \quad (14)$$

It is not possible at this stage to resolve Eq.(13) with respect to the splay u . However, we know x as a function of u , u' as a function of u (see Eq.(10)) and l as function of u and u' . Hence for a certain set of parameters, we can plot the shift l as a function of x by either numerically resolving Eq.(13) or by showing a parameter plot of l versus x , using u as a parameter. This is done for a characteristic set of parameters in Fig.(4). The plot demonstrates that our assumption for the profile of the splay - Fig.(1) - was indeed reasonable. The shift increases from the furthest rod towards the surface until it reaches its maximum value in a reasonable form.

We are now going to estimate the threshold value of γ above which the energy penalty for additional rod-solvent exposure becomes too large for a shift to occur.

The shift is identical zero if the right hand side of Eq.(8) is less or equal to zero for all x .

$$\frac{\left(\frac{b^3 N^2}{d^2 \beta \gamma} (u(x) - du'(x)) \right)^{\frac{1}{2}} - hd(2 + u'(x))}{2(u - du'(x))} \leq 0$$

$$\Rightarrow \beta \gamma \geq \frac{b^3 N^2 (u(x) - du'(x))}{h^2 d^4 (2 + u'(x))^2}. \quad (15)$$

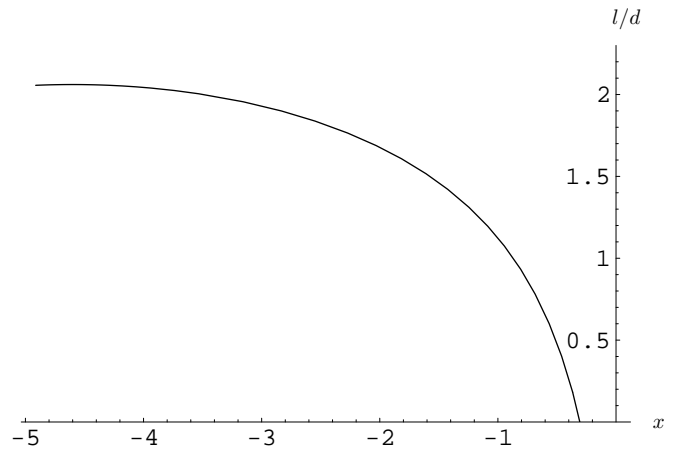

FIG. 4: The shift l is plotted as a function of negative distance. The rod furthest from the surface is located at $x = 0$, compare Fig.(2). Parameters: $N = 700$, $b/d = 0.1$, $\beta \gamma d^2 = 1$

To find an upper limit for the threshold value γ_c we note that the maximum value of the shift is $u_0 = h$. An upper estimate for $(u(x) - du'(x))/(2 + u'(x))^2$ is therefore given by $4h$. The upper limit for γ_c is thus given by

$$\beta \gamma_c \approx \frac{b^3 N^2}{4hd^4} \approx 0.4 \frac{N}{d^2} \left(\frac{b}{d} \right)^{\frac{4}{3}}. \quad (16)$$

For the set of parameters chosen in Fig.(4) this yields the rough estimate of $\beta \gamma_c d^2 \approx 13$.

In this section an attempt was made to describe a variable shift $l(x)$. For values of the splay $u(x)$ which are large enough to dominate the effect of the shift, we found a set of equations (8, 13, 14) which determine l as a function of u and u as a function of x . Although it is not possible to resolve Eq.(13) with respect to u , the profile of the shift can be plotted for a certain set of parameters, see Fig.(4). In this section we always assumed that the adsorbed aggregate is internally stable and does not disintegrate in the sense that single copolymers leave the aggregate. Therefore we are going to discuss in the next section under which conditions the adsorbed aggregate is stable and which other configurations are possible.

III. STABILITY

In section II we assumed that an attached configuration of f rod-coil copolymers at a surface as it is pictured in Fig.(1) is stable. There are three other possible configurations.

In this quasi two-dimensional system only one rod is in contact with the surface. Therefore a possible configuration is the one shown in Fig.(5), where one single copolymer is adsorbed at the surface and the others form a detached sheet. We call such a situation detached configuration in the following. The rods in the detached sheet might also prefer a shifted geometry. We refrain

from a discussion of this shift, since this paper is mainly concerned with the behaviour of a complete aggregate in contact with a surface.

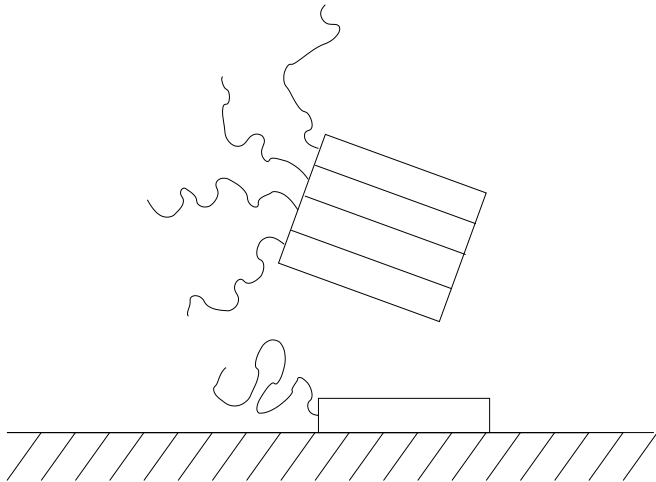

FIG. 5: For long chains a detachment of the aggregate from the rod adsorbed to the surface might be preferable.

The energy of the rod-surface contact in the detached configuration is the same as for the attached one. A configuration with different contact energy is the mushroom-like one as depicted in Fig.(6). This configuration is al-

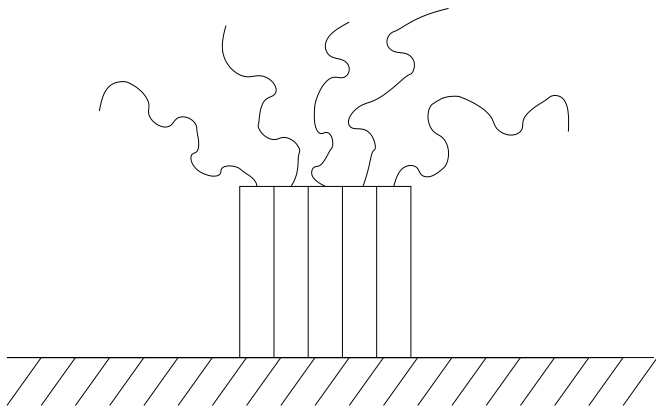

FIG. 6: Another possible configuration: The aggregated rods adsorb perpendicular to the surface. This configuration is preferable for large aggregates.

ways preferable to a complete detachment of the aggregate since in the latter case the system would gain no contact energy.

The last possible configuration is a complete dissociation of the aggregate into single copolymers due to the presence of the attractive surface. These single copolymers then adsorb individually at the surface, see Fig.(7). This configuration yields the highest gain of contact energy. However, it is also the configuration with the highest energy penalty for exposure of rod surface to the solvent. For very high contact energy, i.e. $\kappa \gg \gamma$, the system always dissociates. On the other hand, if κ is to

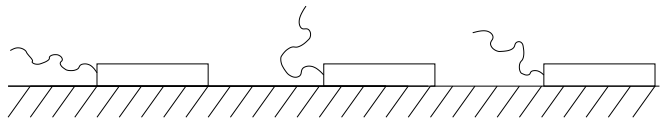

FIG. 7: The aggregate dissociates and the individual rods adsorb at the surface. This configuration is preferred for large κ .

small the system might prefer the mushroom configuration even for long rods, since it allows for the chains to gain entropy without much increase in exposure of the rods to the solvent.

By estimating the free energies of these configurations and comparing them with the one of the attached configuration, it is possible to find the range of κ in which the attached configuration is stable. To achieve this at least approximatively we calculate the free energy of the attached configuration with zero shift. It gives a slight overestimation of the free energy of the configuration considered in section II. However, we still get a rough estimate for the parameter range in which the attached configuration is stable. At zero shift the chains form a finite brush. Its free energy is calculated in the appendix and given by Eq.(A11). One side of the brush is free and therefore allowed a splay of $u_0 = h$, the other side is confined by the surface, i.e. $u_D = 0$. The length D is given by fd . The free energy of the attached configuration then reads

$$\beta F_{attach} = \frac{1}{Nb^2d} \left[3fdh^2 - \left(\frac{7}{6} - \frac{1}{\sqrt{2}} \right) h^3 \right]. \quad (17)$$

We use this as a reference energy and add energy gains and penalties due to rod-surface contact or rod-solvent exposure to the free energies of the other configurations.

Compared to the attached configuration the contact energy of the mushroom differs by $\kappa(Ld - fd^2)$. The chains can also be described as a finite brush. Here both ends are free and are therefore allowed a splay of $u_0 = u_D = h$. The free energy of the mushroom configuration is hence given by

$$\begin{aligned} \beta F_{mushroom} &= \kappa (dL - fd^2) \\ &+ \frac{1}{Nb^2d} \left[3fdh^2 - \left(\frac{7}{3} - \sqrt{2} \right) h^3 \right]. \end{aligned} \quad (18)$$

The attached configuration is preferred to the mushroom configuration if $F_{attach} < F_{mushroom}$. This yields the following condition for κ

$$\beta\kappa > \frac{0.12N^2}{Ld - fd^2} \left(\frac{b}{d} \right)^3. \quad (19)$$

This is the lower bound for κ . To get the upper bound the free energy of the dissociated copolymers - see Fig.(7) - has to be estimated.

Compared to the attached configuration the dissociated one yields a contact energy gain of $-(f-1)\kappa Ld$.

But on the other hand it also gives rise to an additional energy penalty of $2(f-1)\gamma Ld$. Within this Flory-type theory the flexible chains of the individual copolymers at the surface can be treated as free ones and their free energy can be neglected. Comparison of F_{attach} and $2(f-1)\gamma Ld - (f-1)\kappa Ld$ yields the upper limit of κ above which the system dissociates:

$$\beta\kappa < 2\beta\gamma - \frac{1}{(f-1)Ld^2} \left[1.2fdN \left(\frac{b}{d}\right)^{\frac{4}{3}} - 0.12N^2b \left(\frac{b}{d}\right)^2 \right] \quad (20)$$

Within this range of values for κ the attached configuration can actually be stable. For the parameters chosen in Fig.(4), $N = 700, b/d = 0.1, \beta\gamma d^2 = 1$ and $L/d = 80, f = 30$, this range is given by $1.18 < \beta\kappa d^2 < 1.52$.

It is also of interest to keep κ and γ fixed and to investigate at which combination of molecular properties of the copolymers which configuration is preferred. We focus here on the length of the rods L and the number of chain monomers N . In the following the critical rod lengths which separate each two of the possible configurations from each other are calculated as functions of N and of the other parameters. Since it depends on the specific combination of parameters, especially on γ and κ , which configurations are neighbouring in $L-N$ space, all possible critical rod lengths are calculated. Note, that not all possible phase boundaries can exist for one given set of parameters. For each one to exist, the set of parameters have to be chosen appropriately.

Eq.(19) can be rearranged such that it gives the critical rod length below which the system changes from the attached to the mushroom configuration.

$$L_{mushroom}^{attach} \approx fd + 0.12 \frac{N^2b}{\beta\kappa d^2} \left(\frac{b}{d}\right)^2 \quad (21)$$

Comparison of $F_{mushroom}$ with the energy of the dissociated configuration yields the rod length $L_{dissociate}^{mushroom}$ which separates the mushroom from the dissociated configuration.

$$L_{dissociate}^{mushroom} \approx \frac{1.2fdN \left(\frac{b}{d}\right)^{4/3} - 0.24N^2b \left(\frac{b}{d}\right)^2 - fd\beta\kappa d^2}{2(f-1)\beta\gamma d^2 - f\beta\kappa d^2} \quad (22)$$

In case of rather large κ (close to the upper limit) there might exist a rod length which directly separates the attached configuration from the dissociated configuration. It is found to be

$$L_{dissociate}^{attach} \approx \frac{1.2fdN \left(\frac{b}{d}\right)^{4/3} - 0.12N^2b \left(\frac{b}{d}\right)^2}{(f-1)(2\beta\gamma d^2 - \beta\kappa d^2)}. \quad (23)$$

To calculate the boundaries of the detached configuration (see Fig.(5)), its free energy has to be estimated. As already mentioned above, this configuration might also prefer a shifted geometry. But since we already estimated F_{attach} for zero shift, it is sufficient to calculate also F_{detach} for a rectangular sheet without shift. Compared to the attached configuration the free energy of the

detached configuration has a contribution from two additional rod surfaces exposed to the solvent, which is given by $2Ld\gamma$. The free energy of the chains of the detached sheet is similar to the one of the mushroom configuration, with $D = f - 1$. The free energy of the chain of the single copolymer can be neglected as in the case of dissociation. F_{detach} is hence given by

$$\beta F_{detach} = 2Ld\beta\gamma + \frac{1}{Nb^2d} \left[3(f-1)dh^2 - \left(\frac{7}{3} - \sqrt{2}\right) h^3 \right]. \quad (24)$$

The rod length L_{attach}^{detach} which separates the detached and the attached configuration can now be estimated.

$$L_{attach}^{detach} \approx 0.6 \frac{N}{d\beta\gamma} \left(\frac{b}{d}\right)^{\frac{4}{3}} + 0.06 \frac{N^2}{d\beta\gamma} \left(\frac{b}{d}\right)^3 \quad (25)$$

However, in $L-N$ space the detached configuration might sit in between the mushroom and the dissociated configuration. This is indeed the case for a wide range of parameters. Therefore equating Eq.(18) and Eq.(24) gives the rod length which separates mushroom and detached configuration.

$$L_{detach}^{mushroom} \approx \left(fd - 1.2 \frac{Nd}{\beta\kappa d^2} \left(\frac{b}{d}\right)^{\frac{4}{3}} \right) \left(1 - \frac{\gamma}{\kappa}\right)^{-1} \quad (26)$$

The length $L_{dissociate}^{detach}$ which separates the detached from the dissociated configuration is found to be

$$L_{dissociate}^{detach} \approx \frac{1.2(f-1)dN \left(\frac{b}{d}\right)^{4/3} - 0.24N^2b \left(\frac{b}{d}\right)^2}{2(f-2)\beta\gamma d^2 - (f-1)\beta\kappa d^2}. \quad (27)$$

In the conclusions we use these critical rod lengths to calculate one phase diagram in $L-N$ space for a typical set of parameters as an example.

In this section it was shown that the configuration pictured in Fig.(1) can be stable within a certain range of values for κ . There are three other possible configurations as shown in Fig.(5), Fig.(6) and Fig.(7).

IV. CONCLUSION

A discussion of rod-coil copolymer aggregates adsorbed at a surface in a two dimensional approximation was presented. The aggregates form because of a selective solvent, poor for the rods and good for the chains. Due to their chemical structure the rods only align parallel to each other. The surface is assumed to be attractive for the rods and neutral with respect to the chains. If the aggregate adsorbs with the rods parallel to the surface, the rods shift with respect to each other to allow for the chains to gain entropy and to therefore lower their confinement energy. If the shift is assumed to be constant for all rods, the system shows an artificial behaviour. This can be seen from the considerations in the appendix.

In section II we constructed a model which allows for the shift to vary. It was possible to partially solve this model and to show that away from the surface the shift decays. Close to the surface the splay of the chains is close to zero and therefore the shift is basically constant. The region further away from the surface is the interesting one showing the decay profile of the shift, see Fig.(4).

In section III we showed that the configuration considered in section II can actually be stable within a certain range of contact energies between rods and surface. This range was calculated. Three other possible configurations were also discussed, see Figs.(5,6,7). These considerations allow us to plot a phase diagram of the configurations in L - N space, which - for a typical set of parameters - is shown in Fig.(8). The contact energy

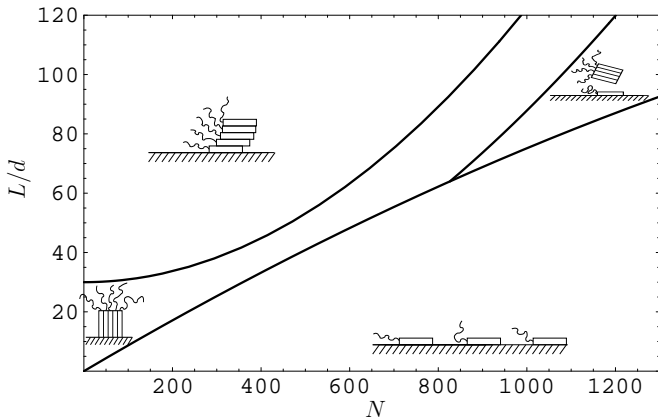

FIG. 8: Configurations of the rod-coil copolymers at the surface. Parameters: $b/d = 0.1$, $f = 30$, $\beta\gamma d^2 = 1$, $\beta\kappa d^2 = 1.3$

per unit area κ is chosen such that there exists a region in L - N space in which the entropy loss of the confined chains is compensated by the energy gain due to rod-surface contact. But it is also chosen to be not much larger than the rod-rod contact energy γ , since otherwise the aggregate would dissociate. However, for very long chains the aggregate always dissociates into single copolymers which then individually adsorb. Nevertheless, Fig.(8) shows that there is indeed a broad region in L - N space in which the attached configuration is stable and the rods shift with respect to each as discussed in section II.

For further considerations in the future it would be of interest to study the behaviour of a finite three dimensional aggregate adsorbed with the rods parallel to the surface. We expect the profile of the shift to form a two dimensional surface with the innermost rods close to the surface showing the maximum shift.

APPENDIX A: CONSTANT SHIFT

Despite the fact that the assumption of a constant shift appears unphysical and leads to contradictory results we are discussing it in this appendix in some detail. It is a

useful example to define the arising problems in a clear way.

The rods are assumed to shift a constant distance with respect to each other as shown in Fig.(9). The characteristic quantity related to this shift is the angle α . This angle can be calculated by calculating the free energy of the entire system and minimising it with respect to α .

The additional free energy per rod due to the shift is given by the additional surface of the rod exposed to the solvent $F_{rod} = 2\gamma d^2 \tan \alpha$. To calculate the free energy of the chains we treat them as if they would form a finite brush grafted to the surface shown as a thick line in Fig.(9). For a finite brush the trajectories of the single polymer chains are not all perpendicular to the grafting surface as for an infinite one. The polymer chains show a splay u . Fig.(9) illustrates how this quantity is defined; that is, $u(x) = X(x) - x$. The first chain is allowed a splay of $u_0 = h \tan \alpha$ due to the surface, where h is the brush height given by $h = 4^{-1/3} b N \sigma^{1/3} b^{2/3}$. The last chain can topple over completely and is therefore allowed a splay $u_L = h$. The grafting density σ is a function of α as well. It is given by $\sigma(\alpha) = \cos(\alpha)/d^2$. As in section II a Flory-type approach is used to describe the free energy of the finite brush following the lines of [19]. Each chain fills a box of volume $h\sigma^{-1}(1 + u'/2)$, with $u' = du/dx$. The free energy for the finite brush is then given by

$$\beta F_{brush} = \frac{d}{Nb^2} \sigma \left(\int_0^D dx [u(x)^2 + h^2] + 4h^2 \int_0^D dx \left[\frac{1}{2 + u'} \right] \right), \quad (A1)$$

where D represents the total length of the brush. For our system of aggregates of rod-coil copolymers it is given by $D(\alpha) = fd \cos(\alpha)$. The first integral of the Euler-Lagrange equation for the splay $u(x)$ obtained from Eq.(A1) is given by

$$u^2 + 8h^2 \frac{1 + u'}{(2 + u')^2} = C. \quad (A2)$$

Eq.(A1) does not distinguish between positive and negative splay. Hence we have to separate our system into two finite brushes which meet at the chain with zero splay, see Fig.(9). This chain has to be determined by an equilibrium condition (total length of the brush D).

It is convenient to introduce dimensionless variables $\tilde{u} = u/(\sqrt{8}h)$, $\tilde{x} = x/(\sqrt{8}h)$ and $\tilde{C} = C/(8h^2)$. Eq.(A2) can be integrated for arbitrary \tilde{C} which leads to

$$\begin{aligned} I = & 2\tilde{u} - 2\tilde{u}_D - \ln \left[2\tilde{u} + (1 - 4\tilde{C} + 4\tilde{u}^2)^{1/2} \right] \\ & + \ln \left[2\tilde{u}_D + (1 - 4\tilde{C} + 4\tilde{u}_D^2)^{1/2} \right] = 4(\tilde{D} - \tilde{x}_0 - \tilde{x}). \end{aligned} \quad (A3)$$

The integration constant can now be calculated by using the condition $2I(\tilde{u} = 0) - I(\tilde{u} = \tilde{u}_0)$

$$\begin{aligned} \tilde{C} = & \frac{1}{4} \left(1 - (\tilde{u}_0 + \tilde{u}_D)^2 \sinh[2\tilde{D} + \tilde{u}_0 + \tilde{u}_D]^{-2} \right. \\ & \left. + (\tilde{u}_0 - \tilde{u}_D)^2 \cosh[2\tilde{D} + \tilde{u}_0 + \tilde{u}_D]^{-2} \right). \end{aligned} \quad (A4)$$

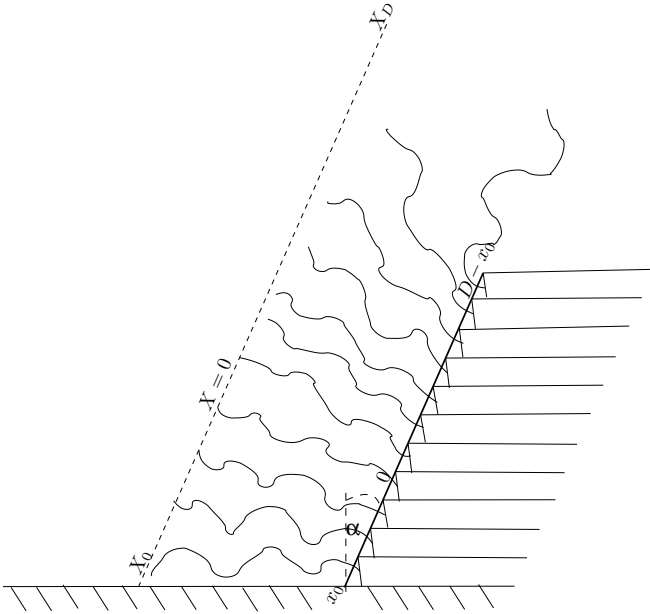

FIG. 9: Aggregate of rod-coil copolymers adsorbed at a surface. The rods are all shifted with respect to each other by the same distance. The shift is characterised by the angle α . This sketch shows how we define the x -range and the splay. Note: $u(x) = X(x) - x$, i.e. $u_0 = X_0 - x_0$ and $u_D = X_D - (D - x_0)$.

The free energy in Eq.(A1) cannot be integrated directly using the implicit solution for the splay \tilde{u} , Eq.(A3). Therefore we have to find an appropriate approximation. It can be shown that $1 - 4\tilde{C} \approx 0$ for all u_0 if $D \geq h$. Hence Eq.(A3) can be very well approximated as

$$2\tilde{u} - 2\tilde{u}_D - \ln \left[\frac{\tilde{u}}{\tilde{u}_D} \right] \tilde{u} = 4(\tilde{D} - \tilde{x}_0 - \tilde{x}),$$

$$\text{for } \tilde{u} \geq \tilde{u}_c = \frac{1}{2}(1 - 4\tilde{C})^{1/2}. \quad (\text{A5})$$

For $0 \leq \tilde{u} \leq \tilde{u}_c$ we can choose a linear approximation.

To calculate the free energy we have to perform the following integration

$$\int d\tilde{x} \left[\tilde{u}^2 + \frac{1}{2(2 + \tilde{u}')} \right]. \quad (\text{A6})$$

We first consider the regime $0 \leq \tilde{u} \leq \tilde{u}_c$:

$$\tilde{u}'(\tilde{x} \leq \tilde{x}_c) \ll 2 \Rightarrow \frac{1}{2(2 + \tilde{u}')} \approx \frac{1}{4}, \quad \tilde{u}_c^2 \ll \frac{1}{4} \quad (\text{A7})$$

The integral in Eq.(A6) in the interval $[0, \tilde{x}_c]$ can therefore safely be approximated by

$$\int_0^{\tilde{x}_c} d\tilde{x} \left[\tilde{u}^2 + \frac{1}{2(2 + \tilde{u}')} \right] = \frac{1}{4}\tilde{x}_c. \quad (\text{A8})$$

In the interval $[\tilde{x}_c, \tilde{D} - \tilde{x}_0]$ the approximation for the splay, Eq.(A5), is valid. The integral in Eq.(A6) can

then be rewritten in the following form

$$\int_{\tilde{x}_c}^{\tilde{D} - \tilde{x}_0} d\tilde{x} \left[\tilde{u}^2 + \frac{1}{2(2 + \tilde{u}')} \right]$$

$$= \frac{1}{2} \int_{\tilde{x}_c}^{\tilde{D} - \tilde{x}_0} d\tilde{x} \left[\tilde{u}\tilde{u}' - \tilde{u}^2\tilde{u}' - \frac{\tilde{u}'}{4} + \frac{1}{2} \right]$$

$$= \left[\frac{\tilde{x}}{4} - \frac{\tilde{u}}{8} + \frac{\tilde{u}^2}{4} - \frac{\tilde{u}^3}{6} \right]_{\tilde{x}_c}^{\tilde{D} - \tilde{x}_0}. \quad (\text{A9})$$

By construction $\tilde{u}(\tilde{x}_c) = \tilde{u}_c \ll 1$, see Eq.(A5). Therefore the integral in Eq.(A6) in the limits $[0, \tilde{D} - \tilde{x}_0]$ can be very well approximated by making use of Eqs.(A8,A9):

$$\int_0^{\tilde{D} - \tilde{x}_0} d\tilde{x} \left[\tilde{u}^2 + \frac{1}{2(2 + \tilde{u}')} \right] = \frac{\tilde{D} - \tilde{x}_0}{4} - \frac{\tilde{u}_D}{8} + \frac{\tilde{u}_D^2}{4} - \frac{\tilde{u}_D^3}{6}. \quad (\text{A10})$$

So far we calculated only one part of the brush. The one from the “zero splay chain” to the open end. In Fig.(9) this is the right part from 0 to $D - x_0$. The left part from 0 to x_0 or rather from the “zero splay chain” to the surface can be calculated completely analogous replacing $\tilde{D} - \tilde{x}_0$ with \tilde{x}_0 and \tilde{u}_D with \tilde{u}_0 . Adding up the results for both parts in both intervals, accounting for the prefactors in Eq.(A1) and converting back to variables carrying dimensions we get as a final result for the free energy of the chains forming the finite brush

$$\beta F_{brush} = \frac{d}{Nb^2} \sigma \left[3Dh^2 - h^2(u_0 + u_D) + \frac{h}{\sqrt{2}}(u_0^2 + u_D^2) - \frac{1}{6}(u_0^3 + u_D^3) \right]. \quad (\text{A11})$$

Plugging in the α -dependent expressions for σ , D , u_0 and u_D and adding F_{rod} we get the α -dependent part of the total free energy of the system.

$$\beta F(\alpha) = 2f\beta\gamma d^2 \tan(\alpha) + \frac{3}{4^{2/3}} fN \left(\frac{b}{d} \right)^{4/3} \cos(\alpha)^{2/3}$$

$$+ \frac{N^2}{4} \left(\frac{b}{d} \right)^3 \cos^2(\alpha) \times$$

$$\left[\frac{1}{\sqrt{2}} - \frac{7}{6} - \tan(\alpha) + \frac{\tan^2(\alpha)}{\sqrt{2}} - \frac{\tan^3(\alpha)}{6} \right] \quad (\text{A12})$$

This equation is only valid for $0 \leq \alpha \leq \pi/4$, since $u_0(\pi/4) = h = u_D$. In the interval $\pi/4 < \alpha < \pi/2$ the splay at the surface remains constant at its maximum value $u_0 = h$, and the term in square brackets in Eq.(A12) reduces to $[\sqrt{2} - 7/3]$.

There are two regimes in each of which the above free energy, Eq.(A12), shows a different behaviour. The regime where the chains are rather short shows a first

order like transition. With decreasing γ there is a jump from a stable phase with no shift ($\alpha = 0$) to a stable phase with a large shift ($\alpha \gg 0$). The other regime in which the chains are rather long shows a second order transition from a stable phase with $\alpha = 0$ to a phase with finite α .

As a criterion to distinguished these two regimes the chain length can be used. The chain length N_t which separates these two regimes is given by $N_t \approx 1.4f \left(\frac{d}{b}\right)^{5/3}$. For $N < N_t$ the transition is first order like and continuous for $N > N_t$. This condition can be interpreted such that for $N < N_t$ the second term in the free energy (Eq.(A12)) dominates the third term. The second term solely represents the effect of decreasing grafting density, whereas the third term also represents the effect of increasing splay of the chains close to surface. Therefore, if the grafting density effect is dominant, the transition is similar to the tilting transition observed in lamellar structures of rod-coil copolymers, see e.g. [4]. Since then the minimum in the free energy is essentially given by the balance of $\tan \alpha$ (first term) and $\cos \alpha$ (second term) there cannot be a continuous transition with a minimum at small values of α . To illustrate this behaviour, the free energy as a function of α for different values of γ is plotted in Fig.(10).

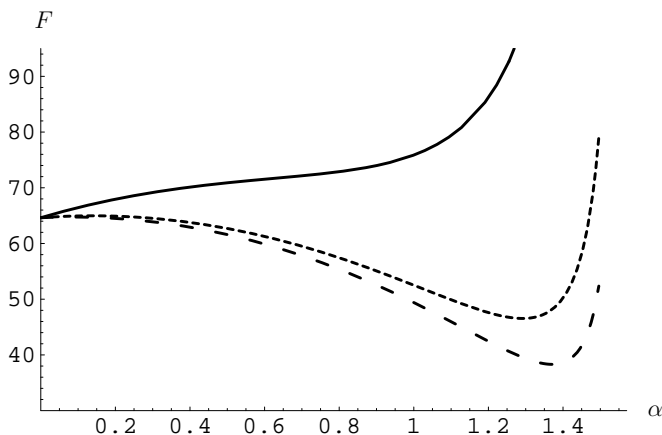

FIG. 10: This plot shows the dependence of the free energy in units of kT on α for different values of γ in the regime $N < N_t$. Parameters: $f = 10, b/d = 0.2, N = 50, \beta\gamma d^2 = 1$ (upper curve), 0.25, 0.15 (lower curve). In this regime the effect of decreasing grafting density with increasing α dominates the effect of the splay of the coils close to the surface.

For $N \geq N_t$ the third term in the free energy, Eq.(A12), gets equal to or bigger than the second term. This means that the increase in splay of the chains close to the surface becomes important. Since u_0 scales with $\tan \alpha$ like the contribution of the rods (F_{rod}) does, a continuous transition is now possible. The dependence of the free energy on α for different values of γ is shown in Fig.(11).

The assumption of the shift to be constant is an oversimplification. The crossover from one regime ($N \geq N_t$) in which a shift develops continuously to a regime ($N < N_t$) in which the system shows a first order transition like jump from zero shift to large finite shift is an unphysical artefact of this approximation. Only in the limit of a very large number of copolymers f forming one lamellar like aggregate the constant shift assumption might be reasonable. However, in this limit the effect of the surface becomes negligible and the system always shows a tilting transition - compare [4] - even if not in contact with the surface.

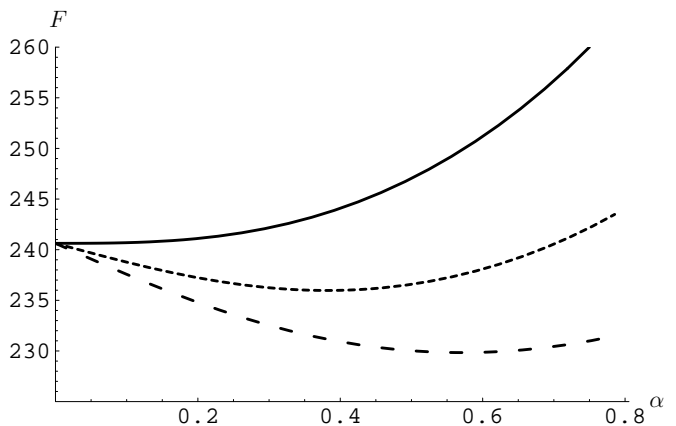

FIG. 11: This plot shows the dependence of the free energy in units of kT on α for different values of γ in the regime $N > N_t$. Parameters: $f = 10, b/d = 0.2, N = 200, \beta\gamma d^2 = 4$ (upper curve), 3, 2.5 (lower curve). In this regime the effect of increasing splay of the chains close to the surface determines the behaviour of the free energy.

[1] Dowell, F., Phys. Rev. A **28**, 3520; 3526 (1983).
 [2] Semenov, A.N. and Vasilenko, S.V., Sov. Phys. JETP **63**, 70 (1986).
 [3] Halperin, A., Europhys. Lett. **10**, 549, (1989).
 [4] Halperin, A., Macromolecules **23**, 2724 (1990).
 [5] Vilgis, T.A. and Halperin, A., Macromolecules **24**, 2090 (1991).
 [6] Williams, D.R.M. and Fredrickson, G.H., Macro-

molecules **25**, 3561 (1992).
 [7] Holyst, R. and Schick, M., J. Chem. Phys. **96**, 721; 730 (1992).
 [8] Holyst, R. and Vilgis, T.A., Macromol. Theory Simul. **5**, 573 (1996).
 [9] Matsen, M. W. and Barrett, C., J. Chem. Phys. **109**, 4108 (1998).
 [10] Friedel, P. et al, Macromol. Theory Simul. **11**, 785 (2002).

- [11] Grosberg, A.Y. and Khokhlov, A.R., *Adv. Polym. Sci.* **41**, 53 (1981).
- [12] Semenov, A.N. and Subbotin, A.V., *Sov. Phys. JETP* **74**, 660 (1992).
- [13] Nowak, C. and Vilgis, T.A., *Europhys. Lett.* **68**, 44 (2004).
- [14] Nowak, C., Rostiashvili, V.G. and Vilgis, T.A., *Macromol. Chem. Phys.* **206**, 112 (2005).
- [15] Sevick, E.M. and Williams, D.R.M., *Colloids Surf. A* **130**, 387 (1997).
- [16] Stupp, S.I. et al., *Science* **276**, 384 (1997).
- [17] Stupp, S.I. et al., *MRS Bull.* **25**, 42 (2000).
- [18] Sayar, M. and Stupp, S.I., *Macromolecules* **34**, 7135 (2001).
- [19] T.A. Vilgis, A. Johner and J.-F. Joanny, *Phys. Chem. Chem. Phys.* **1**, 2077 (1999).