

# Anomalous density dependence of static friction in sand

Viktor K. Horváth<sup>1</sup>, Imre M. Jánosi<sup>2†</sup>, and Péter J. Vella<sup>3</sup>

<sup>1</sup> Department of Atomic Physics, Eötvös University, Puskin utca 5-7., 1088 Budapest, Hungary

<sup>2</sup> Höchstleistungsrechenzentrum, KFA-Jülich, 52425 Jülich, Germany

<sup>3</sup> Laboratory for Information Technology, Eötvös University, Múzeum körút 6-8, 1088 Budapest, Hungary

(to appear in PRE August 1996)

We measured experimentally the static friction force  $F_s$  on the surface of a glass rod immersed in dry sand. We observed that  $F_s$  is extremely sensitive to the closeness of packing of grains. A linear increase of the grain-density yields to an exponentially increasing friction force. We also report on a novel periodicity of  $F_s$  during gradual pulling out of the rod. Our observations demonstrate the central role of grain bridges and arches in the macroscopic properties of granular packings.

Recently, there is a considerably increasing interest in static and dynamic properties of granular materials [1–3]. One of the basic problems is to attribute the macroscopic properties of granular materials to the microscopic characteristics of grains. A well known example is a sandpile which exhibits an inclined free surface of a specific angle, the angle of repose. Individual grains build up the slope by the action of microscopic frictional forces at the particle contacts. It is remarkable that this angle of repose still cannot be computed from the microscopic characteristics of grains. Although current efforts on large scale computer simulations [4] have revealed promising details of dynamical processes involving grains, experimental investigations of granular packings still play pioneering role in the exploration of the physical nature of granular materials.

There are a few general laws relating the magnitude of friction force to principal macroscopically observable variables [5–7]. The basic one states that the friction force  $F$  depends on the normal force  $L$  acting between the surfaces as  $F = \mu L^n$ , where  $\mu$  is the coefficient of friction, and  $n \approx 1$  is the so called load index. The force  $F_s$  required to start sliding is greater than the force  $F_d$  maintaining the motion. Assuming that  $n$  does not depend on the dynamics, this difference has led to the notion of two coefficients: One for the static friction  $\mu_s = F_s/L^n$  and one for the dynamic friction  $\mu_d = F_d/L^n < \mu_s$ . Another law, usually referred as Amontons’s law, states that the friction force is independent of the apparent contact area. Both quantitative laws are generally well obeyed, exceptions to them are rarities, and the deviations remain within a few percent in most cases of sliding coherent *solid bodies* [5–7].

One of the first formulations of a macroscopic friction coefficient for *granular materials* is attributed to Coulomb (1773), who defined it as the tangent of the angle of repose. Recent measurements [8] support the idea that horizontal granular layers sliding on each other obey the general friction laws, too. However, some reports on related experiments suggest that granular materials may have very unusual properties, and one should consider carefully the application of such “fundamental” principles, like friction laws. For instance, Allen [9] found

that the angle of repose of different granules depends strongly on the fractional concentration  $C$ , which is defined as the total volume of the grains over the total volume of packing (grains and voids). Also, the interaction on powder-wall contacts generally do not obey these laws [10]. In some cases the friction was found to be directly proportional to the apparent contact area, and quite sensitive to the normal load [10]. An important feature of the powder-wall contacts is that the grains have some freedom of movement with respect to their neighbors, therefore the particles may contribute more or less independently to the overall friction along the wall.

In order to get insight into this problem, we performed measurements with a simple but sensitive experimental setup (Fig. 1). Over a long period of time similar setups have been used occasionally for related experiments [11–13] (see below), however to our best knowledge, none of them revealed the phenomena presented in this work.

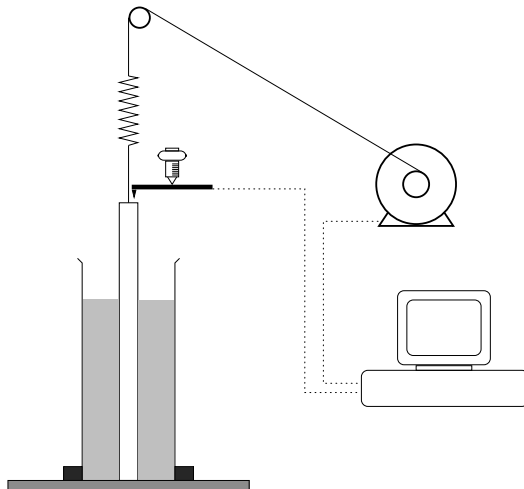

FIG. 1. Schematic of the experimental setup. A glass rod is pulled out from sand by a calibrated steel spring. The elongation of the spring is adjusted and measured by a computer controlled stepping motor. The slip of the rod is detected by closing an electrical circuit between the top of the rod and an external obstacle. The gap between the rod and the obstacle is adjustable precisely by a micrometer screw.

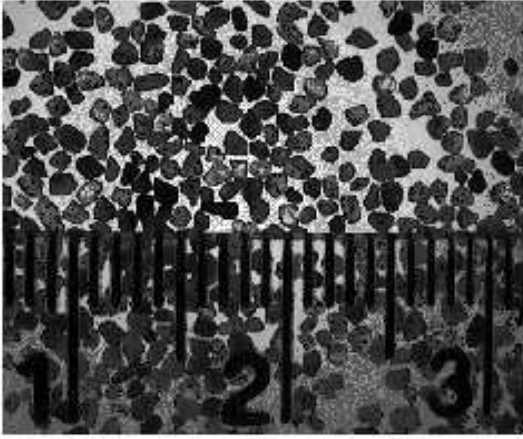

FIG. 2. Videomicrograph of the sand grains with a characteristic size of  $\sim 1$  mm used in the experiment. The distance between two minor markers on the ruler is 1 mm. The sand with a typical grain-size of  $\sim 0.08$  mm (not shown) has similar irregular shapes.

Our setup consists of a quartz-glass cylinder with an inner diameter of  $D = 51.5$  mm, which is vertically fixed on a precision balance. A glass rod of diameter  $d = 10.0$  mm is hung centrally into the cylinder. A thin copper sheet for electrical contact and a small hook were glued to the top of the rod. The pulling out force is transmitted by a calibrated steel spring connected to the hook. This spring can be elongated by a computer controlled stepping motor. The spring and the axis of the motor is connected by a special twisted scale-wire of high flexibility and very low tensile modulus. An important part of the setup is an obstacle fixed *centrally* above the rod to an outer frame. The distance between the top of the rod and the obstacle can be adjusted precisely by a micrometer screw. If the upward moving rod hits the tip of the obstacle, an electrical circuit signals to the computer to stop the motor. The measured quantity is the number of steps performed by the stepping motor, from which the elongation of the spring and then the force can be obtained.

In order to measure the absolute value of the pull-out force, we had to define a reference point for the experiments. Prior to each experiments we measured the weight  $W_0$  of the cylinder filled with the same amount of sand as used in the actual experiment. Next, we removed the sand, inserted the rod into the cylinder and filled the cylinder again with the sand. Then we rotated the motor until the weight of the system had decreased to  $W_0$ . At this position the weight of the rod is balanced exactly by the spring-force, thus we defined this as the reference point for the given packing. Further steps of the motor involved decreasing weight which was directly related to the pulling force of the elongated spring. The calibration of the spring was performed by measuring the weight decrease from  $W_0$  versus the elongation steps of

the spring with the rod temporarily fixed to the cylinder. According to this calibration, all experiments were performed in the linear regime of the spring of modulus  $K = 21.3173 \pm 0.0004$  N/m.

We used two types of sharp (irregularly shaped) quartz-sand, one with a characteristic grain-size of 1 mm (see Fig. 2), and another of 0.08 mm. Both have the same specific weight  $\gamma = 2.59 \pm 0.03$  g/cm<sup>3</sup>. The sand was thoroughly washed and dried to remove intergranular dust and other contaminations. To start an experiment, we measured the height of the filling, set the system to the reference position and moved the obstacle away from the top of the rod by a given distance  $\delta h$ .

The measurements are performed in two different ways. In the first series of experiments, the spring is elongated by the stepping motor until the rod hits the obstacle. Then the spring is released *fully*, and we move the rod back to the bottom of the cylinder. We rotate the motor to the reference position and repeat the same measurement again. Note that the amplitude of the vertical motion  $\delta h$  was much less than the average grain size, therefore no grains could move under the rod. Typical results are shown in Fig. 3. Based on a series of measurements, we observed that a given fractional concentration  $C$  is not a precise control parameter of the *first* pull-out friction force  $F_1$ . Although we always applied the same filling procedure, used the same amount of sand, and started an experiment only if we obtained the same filling heights within 2%, the result scattered within the range of  $F_1 \approx 0.9 \pm 0.5$  N in the case of Fig. 3. The mean value and the scatter are based on 10 realizations, in each case the pulling-pushing cycle was repeated more than 20 times.

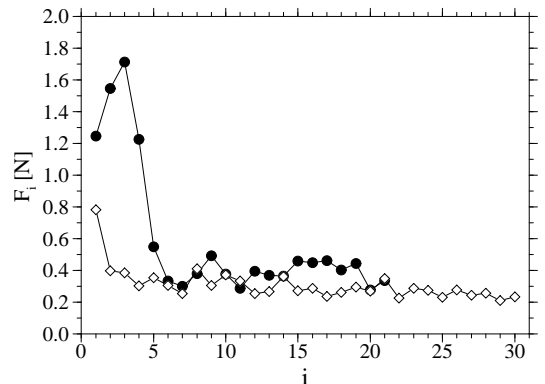

FIG. 3. Two series of pulling-pushing measurements with the same amount of loose packed sand of  $\sim 1$  mm grain-size,  $m = 745$  g. The vertical axis shows the static friction force  $F_i$  at the  $i$ th pull, after each attempts the measuring spring was released and the rod pushed back to the original position. The allowed amplitude of the rod motion was  $\delta h = 150 \pm 5$   $\mu$ m. The height of both fillings was  $24.4 \pm 0.2$  cm (i.e. the fractional concentration  $C = 0.590 \pm 0.009$ ).

Also, the way of reaching an asymptotic force can be very different. Usually we observed initially a decrease of the friction force  $F_i$  at repeated cycles. This “weakening” is shown by white diamonds in Fig. 3. However, in some cases we observed an opposite tendency during the first few pull out steps. Such a “strengthening” is demonstrated in Fig. 3 by the first three filled circles. We found that the asymptotic value  $F_a$  of the pullout force for a given filling-mass is independent from the first pull-out force  $F_1$  and depends only on the fractional concentration  $C$ . The numerical value of the asymptotic force in Fig. 3 is  $F_a = 0.28 \pm 0.09$  N.

During our experiments, we never observed macroscopic rearrangement of the filling, or some visible change on the surface. These would suggest the expansion of the packing, i.e. macroscopic dilatancy. Therefore we think that the change of the force in repeated attempts is a consequence of microscopic rearrangements along the wall of the rod. Such rearrangements can happen if some small voids cave in, or some grains rotate into another position, which does not effect the stability of the overall filling. After several “polishing” cycles, probably the structure finds a static configuration at which the pullout force shows a saturation.

As for the filling height ( $h$ ) dependence of the first pull-out force  $F_1$ , Dahmane and Molodtsov [13] performed related experiments at a constant fractional concentration  $C$ . They obtained the empirical formula [13]

$$F_1(h) = \mu_s P \gamma \frac{ah^3}{(b+h)^2} \quad , \quad (1)$$

where  $\mu_s$  is a rod-coating dependent coefficient of static friction,  $P$  is the perimeter of the rod,  $\gamma$  is the specific weight of the granular material,  $a$  and  $b$  are (positive) empirical constants with dimensions of length. Their main result is that the pullout force  $F_1$  does not depend on the radial position and the shape of the cross section of the rod [13]. We carried out a few independent tests in loose packed sand to check the filling height dependence of  $F_a$  in the range of  $10 < z < 25$  cm. Our results are consistent with Eq. (1), which involves approximately a linear dependence on  $z$ , apart from very shallow fillings.

Next, we performed repeated pullout measurements in a different way. The beginning of the experiment was identical to the procedure described above. After the first measurement, the spring was set to the *new* reference position according to the increased height of the rod, but instead of moving the rod back to the initial depth, the obstacle was moved away from the top of the rod again by the same distance  $\delta h$ . Thus the rod was allowed to move out a larger distance step by step. Additionally to the previously described weakening and strengthening, we observed a novel oscillatory behavior. In Fig. 4, a representative result is plotted for sand of typical grain size of 1 mm. Note that halving the distance  $\delta h$  between

subsequent steps does *not* affect the period length, but doubles the number of data points in one period. For relatively loose fillings ( $C \approx 0.6$ ) this period length is roughly 1/3 of the grain size, and seemingly does not depend on the filling height in the range of  $9 < h < 16$  cm. We could not observe clear periodicity using the sand of smaller grain size. Larger packing densities involve much larger pull-out forces (see below), which cover this oscillation and make its observation much harder. It is interesting to note that although the period length is reproducible for the same conditions, the initial phase changes randomly from sample to sample. In Figure 4, we horizontally shifted the second series (empty diamonds) by  $\Delta h = 0.15$  mm to make the periodicity more transparent.

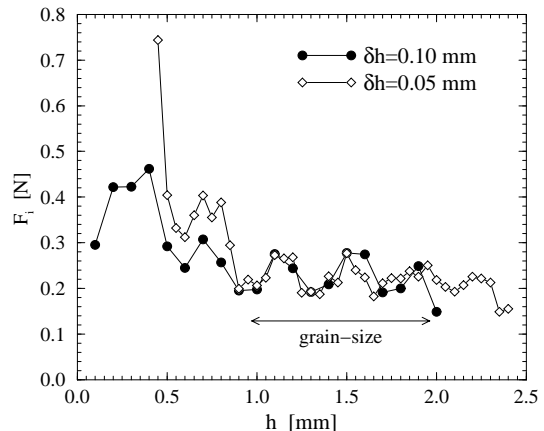

FIG. 4. Static friction versus rod height in a gradual pull-out experiment at two different step sizes. After each pulling the measuring spring was released, and a new measurement was performed without changing the rod position. The filling height of sand of  $\sim 1$  mm grain-size was  $16.3 \pm 0.2$  cm, loose packing case ( $C \approx 0.578$ ). The series of step size  $50 \pm 1 \mu\text{m}$  (empty diamonds) is shifted horizontally to indicate the constant period length. The arrow shows the typical grain-size.

This random phase-shift can be related to the opposite tendency of the observed weakening and strengthening in the previous experiments. In Figure 4., apart from the oscillation, we can also observe a global decrease of the friction force versus the *total distance* of the repeated pull-out steps. We can identify two different regimes depending on the total pull-out distance. First, within the size of one grain diameter we observe a fast, non-linear decay of the friction force, this is in analogy with the weakening found by the pulling-pushing experiments. For longer distance of pull-out, the average value of the force (averaged over one oscillatory period) decreases continuously further, but much slower than at the beginning. On one hand, this slow decay might be related to the decreasing total contact area. On the other hand, the appearing free void under the tip of the rod

might contribute to the decay, giving a freedom grains to move slightly in underneath the rod. We return to this point below. We mention here that large fluctuations and sometimes oscillations were reported also by Meftah et al. [14] in a different *shearing* experiment of two-dimensional packings. Although these oscillations are apparently inherent properties of granular systems, a satisfactory theoretical explanation of them is missing.

Next we turn to the effect of the closeness of granular packings. Already in 1931, Jenkin [11] reported on a series of unsuccessful measurements for friction coefficients of sand. Without providing data, he noted that the *closeness of packing* of the grains was an essential factor in determining the behavior and the irreproducibility of the results. Experimentally, we changed the density of the sand by vibrating the cylinder vertically with 50 Hz by an electromagnet. The amplitude of vibration was well below the fluidization limit. During compaction, the rod was kept fixed at the central position. We followed the increase of density by detecting the decrease of the height. Longer time of vibrating resulted in a larger density. The typical effect of increased closeness of packing is illustrated in Fig. 5. During repeated attempts, the pull-out force showed a weakening tendency in the densified packing again, but its value saturated at a higher level than the asymptotic value for the previously measured loose packing. We stress that strengthening and clear oscillation were never observed after compacting, which suggests that strengthening in loose packings might be closely related to the observed force-oscillations at low densities.

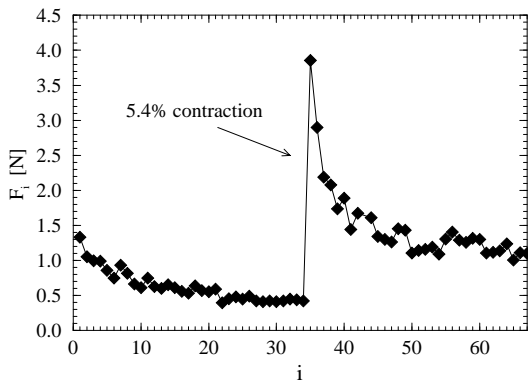

FIG. 5. The effect of increased density on the static friction  $F_i$  (pulling-pushing experiment). At the beginning, the density of the filling was  $\rho = 1.524 \pm 0.015$  g/cm<sup>3</sup> ( $C = 0.588 \pm 0.009$ ), after the saturation of the force the filling was compacted to a value of  $\rho = 1.606 \pm 0.015$  g/cm<sup>3</sup> ( $C = 0.620 \pm 0.009$ ). The other parameters are the same than in Fig. 3.

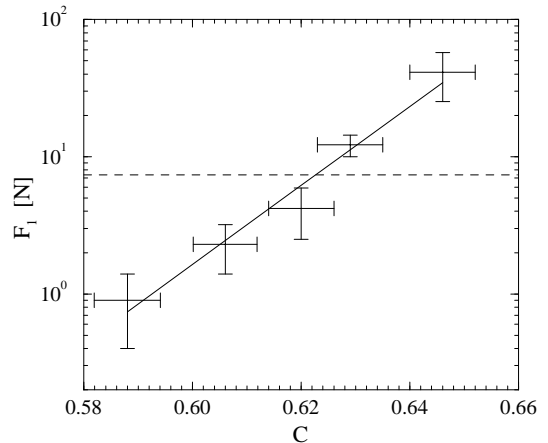

FIG. 6. First pull-out force  $F_1$  as a function of fractional concentration  $C$ . The mass of the fillings was  $745 \pm 0.05$  g.  $C$  was obtained by height measurement. The error bars represent sample to sample fluctuations of 10 realizations with  $\sim 1$  mm grain-size and 3-5 realizations with the finer sand at each  $C$  values. The solid line shows an exponential fit [see Eq. (2)], the dashed line indicates the weight of the filling.

We measured the density dependence of the first pull-out force using a fixed amount of sand, the result is shown in Fig. 6. Surprisingly, the force does not depend on the grain size, both type of sands gave practically the same result. Apparently the density dependence is exponential:

$$F_1(C) = \kappa e^{C/C^*} \quad , \quad (2)$$

where  $C^* \approx 0.015$  and  $\kappa$  are fitting parameters [ $\ln(\kappa) = -39.265$ ]. Obviously the domain of validity for Eq. (2) is bounded by a minimal and a maximal possible packing concentration, which is approximately the interval  $0.54 < C < 0.68$  for natural quartz sands in air [9].

There is no easy way to attribute the first pull-out force  $F_1$  to macroscopic variables. For small densities of the packing, the total load on the wall  $L$  should be proportional to the weight of the sand (indicated by a dashed line in Fig. 6), because in this case mostly gravity induces normal forces in the system. Then one may explain the increase of  $F_1$  by the fact that densification increases the real contact area along the surface of the rod, although the apparent contact area decreases. This effect is limited by an increase of average coordination number in the packing, therefore it can not account for such a large increase of the friction force. Moreover gravity itself can not induce larger normal force than the total weight of the sand.

It is well-known, however, that shearing can induce normal forces in granular packings, too [15]. Indeed, the observation that the friction force can exceed the total weight of the sand (see Fig. 6.) indicates that shear-induced normal forces dominate for dense packings.

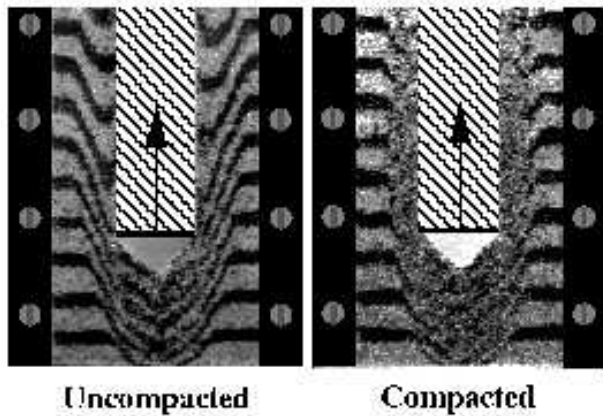

FIG. 7. Quasi-2D visualization of the local rearrangement of sand due to the upward movement of the rod. The black layers formed by the same type of sand colored with ink. The internal width of the cell is 120 mm, the depth is 12 mm. In both cases we filled the cell to the same height with sand of average grain size 1 mm, the compaction was 4.9% (right picture).

The force distribution is not homogeneous in granular materials [16]. Interparticle forces are transmitted by a discrete number of irregular contact paths, the grain bridges or arches. The dominant feature leading to force chains is the strong disorder of the packing, which causes a highly irregular distribution of weights on grains. Recent observations [16] show that the force distribution spans over a wide range, and has an exponential tail. This indicates that very strong contact-forces may be present. At deformations, individual grain bridges collapse and could be replaced by new ones. The bridges can fail in many ways: By the fracture of a grain or the bounding surface, by slip between grains or between a grain and the bounding surface. The slipping mechanism of bridge failure is basically based on spatial rearrangements. This rearrangement is connected to the well known phenomenon of dilatancy, i.e. grains need an extra volume to roll or slip over each other.

In order to visualize the movement of sand grains while the rod is pulled out, we built a quasi-2D version of the experimental setup bounded by two parallel plexiglass plates. Although the different geometry is expected to effect the behavior of the system, we do believe that some global aspects of the dynamics is preserved. To make the local rearrangement of the sand grains more transparent, we layered colored and normal sand in horizontal strips. In Fig. 7. we show the resulting pictures after pulling out the rod by a distance of  $h = 43$  mm. We observed that at dense packings the flow-regime extends to a smaller distance both longitudinally and laterally, while the mixing inside is much stronger. (This mixing is not a consequence of compaction, note the clear separation of layers in the unperturbed regions.) This shows that shearing in a compacted assembly results in strong local

rearrangements along the wall of the rod, while moderate but extended structural changes are characteristic in loose packings. Since the free void space is reduced in a dense medium, we can conclude that local rearrangements should be associated with larger contact forces at higher fractional concentrations.

This observation also suggests an explanation for the slow decay of the average friction force at gradual pullout (see Fig. 4). If the pullout distance of the rod is larger than the average grain-size, the void under the tip gives a free volume for grains to move in. Although the flow under the rod involves only a few grains at a height of 1 – 2 mm, the release of strong local contact forces at around the tip can result in a macroscopically observable decrease of the pullout force.

We suggest that local dilatancy furnishes the key to understand the force strengthening (Fig. 3), as well as periodicity (Fig. 4) in loose packings. There is enough free volume inside the packing given by the interparticle voids, thus bridges can collapse and build up without a macroscopic volume expansion. In close packings, however, similar local rearrangements are hindered by geometrical constraints, therefore some grain bridges can support very large forces. Since we did not observe macroscopic dilatancy in our measurements, we can conclude that the main bridge failure mechanism in this case is probably slip at the boundary surface.

We are grateful to G. Batrouni, J. Hajdu, H. Herrmann, J. Kertész, F. Radjai, Gy. Radnai, I. Szabó and D. Wolf for many discussions. This work was partially supported by the Hungarian National Science Foundation (OTKA) under grants No. F17310 and No. F014967. One of us (V.K.H.) thanks for the Foundation for Research and Higher Education for the Zoltán Magyary scholarship.

---

† Permanent address: Department of Atomic Physics, Eötvös University, Puskin utca 5-7, 1088 Budapest, Hungary.

- [1] J. Biarez, and R. Gourves, eds., *Powders and Grains* (Balkema, Rotterdam, 1989).
- [2] D. Bideau, and A. Hansen, eds., *Disorder and Granular Media* (North-Holland, Amsterdam, 1993).
- [3] A. Mehta, ed., *Granular Matter: An Interdisciplinary Approach* (Springer-Verlag, New York, 1994).
- [4] K. Ichiki, and H. Hayakawa, *Phys. Rev.* **E 52**, 658 (1995); T. Pöschel, and V. Buchholtz, *J. Phys. (Paris) I* **5**, 1431 (1995); G. Ristow, and H. J. Herrmann, *Phys. Rev.* **E 50**, R5 (1994); A. Károlyi, and J. Kertész, in *Proc. of the 6th Joint EPS-APS Int. Conf. on Physics Computing*, ed. R. Gruber, and M. Tomassini (EPS, Geneva, 1994) p. 675; J. A. C. Gallas, H. J. Herrmann, and S. Sokolowski, *Phys.*

- Rev. Lett. **69**, 1371 (1992).
- [5] F. P. Bowden, and D. Tabor, *The Friction and Lubrication of Solids* (Oxford Univ. Press, Oxford, 1964).
- [6] E. Rabinowicz, *Friction and Wear of Materials* (John Wiley & Sons, New York, 1965).
- [7] F. Heslot et al., Phys. Rev. **E 49**, 4973 (1994).
- [8] J. Duran, and T. Mazozi, private communication.
- [9] J. R. L. Allen, J. Geol. **78**, 326 (1970); Geol. Mijnbouw. **49**, 13 (1970).
- [10] B. J. Briscoe, in *Physics of Granular Media*, eds. D. Bideau, and J. Dodds (Nova Science, New York, 1991)
- [11] C. F. Jenkin, Proc. Roy. Soc. London **A 131**, 53 (1931).
- [12] K. Wiegardt, Ann. Rev. Fluid. Mech. **7**, 89 (1975).
- [13] C. Dahmane, and Y. Molodtsov, in *Powders & Grains 93*, ed. C. Thornton (Balkema, Rotterdam, 1993) p. 369.
- [14] W. Meftah et al., in *Powders & Grains 93*, ed. C. Thornton (Balkema, Rotterdam, 1993) p. 173.
- [15] P. A. Thompson, and G. S. Grest, Phys. Rev. Lett. **67**, 1751 (1991).
- [16] C.-h. Liu et al., SCIENCE **269**, 513 (1995).