

Multiaccess Channels with State Known to Some Encoders and Independent Messages

Shiva Prasad Kotagiri and J. Nicholas Laneman.

Abstract

We consider a state-dependent multiaccess channel (MAC) with state *non-causally* known to some encoders. For simplicity of exposition, we focus on a two-encoder model in which *one* of the encoders has non-causal access to the channel state. The results can in principle be extended to any number of encoders with a subset of them being informed. We derive an inner bound for the capacity region in the general discrete memoryless case and specialize to a binary noiseless case. In binary noiseless case, we compare the inner bounds with trivial outer bounds obtained by providing the noiseless channel state to the decoder. In the case of maximum entropy channel state, we obtain the capacity region for binary noiseless MAC with one informed encoder by deriving a non-trivial outer bound for this case.

For a Gaussian state-dependent MAC with one encoder being informed of the channel state, we present an inner bound by applying a slightly generalized dirty paper coding (GDPC) at the informed encoder that allows for partial state cancellation, and a trivial outer bound by providing channel state to the decoder also. In particular, if the channel input is negatively correlated with the channel state in the random coding distribution, then GDPC can be interpreted as partial state cancellation followed by standard dirty paper coding. The uninformed encoders benefit from the state cancellation in terms of achievable rates, however, appears that GDPC cannot completely eliminate the effect of the channel state on the achievable rate region, in contrast to the case of all encoders being informed. In the case of infinite state variance, we analyze how the uninformed encoder benefits from the informed encoder's actions using the inner bound and also provide a non-trivial outer bound for this case which is better than the trivial outer bound.

Index Terms

Multiple access channel (MAC), channel state, dirty paper coding (DPC).

I. INTRODUCTION

We consider a state-dependent multiaccess channel (MAC) with noiseless channel state non-causally known to only some, but not all, encoders. The simplest example of a communication system under investigation is shown in Figure 1, in which two encoders communicate to a single decoder through a state-dependent MAC $p(y|x_1, x_2, s)$ controlled by the channel state S . We assume that one of the encoders has non-causal access to the noiseless channel state. The results can in principle be extended to any number of encoders with a subset of them being informed of the noiseless channel state. The informed encoder and the uninformed encoder want to send messages W_1 and W_2 , respectively, to the decoder in n channel uses. The informed encoder, provided with both W_1 and the channel state S^n , generates the codeword X_1^n . The uninformed encoder, provided only with W_2 , generates the codeword X_2^n . The decoder, upon receiving the channel output Y^n , estimates both messages W_1 and W_2 from Y^n . In this paper, our goal is to study the capacity region of this model.

Part of this work was published in Allerton Conference on Communications and Control, Monticello, IL, USA, October 2004

This work has been supported in part by NSF grants CCF05-46618 and CNS06-26595, the Indiana 21st Century Fund, and a Graduate Fellowship from the Center for Applied Mathematics at the University of Notre Dame

ShivaPrasad Kotagiri and J. Nicholas Laneman are with Department of Electrical Engineering, University of Notre Dame, Notre Dame, IN 46556, Email: skotagir@gmail.com, jnl@nd.edu

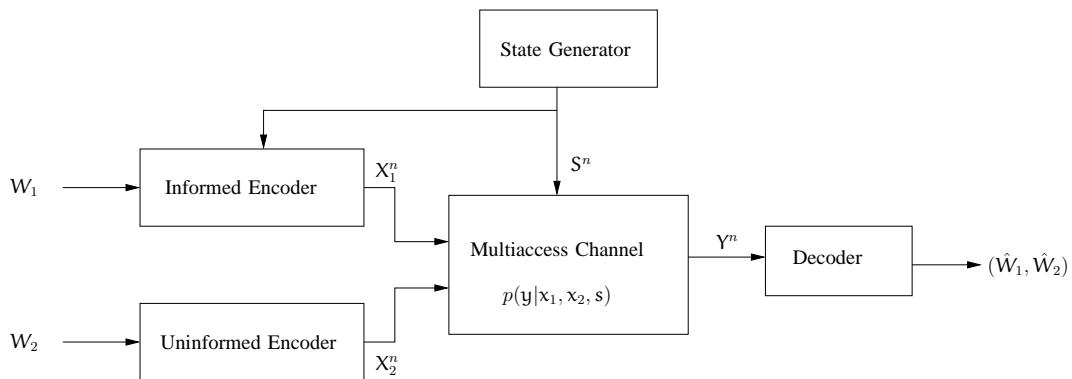

Fig. 1. State-dependent multiaccess channel with channel state non-causally known to one encoder.

A. Motivation

State-dependent channel models with state available at the encoder can be used to model IE [2], [3], [4], [5]. Information embedding (IE) is a recent area of digital media research with many applications, including: passive and active copyright protection (digital watermarking); embedding important control, descriptive, or reference information into a given signal; and covert communications [1]. IE enables encoding a message into a host signal (digital image, audio, video) such that it is perceptually and statistically undetectable. Given the various applications and advantages of IE, it is important to study fundamental performance limits of these schemes. The information theory community has been studying performance limits of such models in which random parameters capture fading in a wireless environment, interference from other users [6], or the host sequence in IE and data hiding applications [2], [3], [4], [5], [7].

The state-dependent models with channel state available at the encoders can also be used to model communication systems with cognitive radios. Because of growing demand for bandwidth in wireless systems, some secondary users with *cognitive* capabilities are introduced into an existing primary communication system to use the frequency spectrum more efficiently [8]. These cognitive devices are supposed to be capable of obtaining knowledge about the primary communication that takes place in the channel and adapt their coding schemes to remove the effect of interference caused by the primary communication systems to increase spectral efficiency. The state in such models can be viewed as the signal of the primary communication that takes place in the same channel, and the informed encoders can be viewed as cognitive users. The model considered in the paper can be viewed as a secondary multiaccess communication system with some cognitive and non-cognitive users introduced into the existing primary communication system. The cognitive users are capable of non-causally obtaining the channel state or the signal of the primary communication system. In this paper, we are interested in studying the achievable rates of the secondary multiaccess communication system with some cognitive users. Joint design of the primary and the secondary networks is studied in [9], [10].

B. Background

The study of state-dependent models or channels with random parameters, primarily for single-user channels, is initiated with Shannon himself. Shannon studies the single-user discrete memoryless (DM) channels $p(y|x, s)$ with causal channel state at the encoder [11]. Here, X , Y , and S are the channel input, output, and state respectively. Salehi studies the capacity of these models when different noisy observations of the channel state are causally known to the encoder and the decoder [12]. Caire and Shamai extend the results of [12] to channels with memory [13].

Single-user DM state-dependent channels with memoryless state non-causally known to the encoder are studied in [14], [15] in the context of computer memories with defects. Gel'fand-Pinsker derive the

capacity of these models, which is given by [16]

$$C = \max_{p(\mathbf{u}|\mathbf{s}), \mathbf{X}=f(\mathbf{u},\mathbf{S})} [\mathbb{I}(\mathbf{U}; \mathbf{Y}) - \mathbb{I}(\mathbf{U}; \mathbf{S})] \quad (1)$$

where \mathbf{U} is an auxiliary random variable, and \mathbf{X} is a deterministic function of (\mathbf{U}, \mathbf{S}) . Single-user DM channels with two state components, one component non-causally known to the encoder and another component known to the decoder, are studied in [17].

Costa studies the memoryless additive white Gaussian state-dependent channel of the form $\mathbf{Y}^n = \mathbf{X}^n + \mathbf{S}^n + \mathbf{Z}^n$, where \mathbf{X}^n is the channel input with power constraint $\frac{1}{n} \sum_{i=1}^n X_i^2 \leq P$, \mathbf{S}^n is the memoryless state vector whose elements are non-causally known to the encoder and are zero-mean Gaussian random variables with variance Q , and \mathbf{Z}^n is the memoryless additive noise vector whose elements are zero mean Gaussian random variables with variance N and are independent of the channel input and the state. The capacity of this model is given by [18]:

$$C = \frac{1}{2} \log \left(1 + \frac{P}{N} \right). \quad (2)$$

In terms of the capacity, the result (2) indicates that non-causal state at the encoder is equivalent to state at the decoder or no state in the channel. The so-called *dirty paper coding* (DPC) scheme used to achieve the capacity (2) suggests that allocating power for explicit state cancellation is not optimal, i.e., the channel input \mathbf{X} is uncorrelated with the channel state \mathbf{S} in the random coding distribution [18].

For state-dependent models with non-causal state at the encoder, although much is known about the single user case, the theory is less well developed for multi-user cases. Several groups of researchers [19], [20] study the memoryless additive Gaussian state-dependent MAC of the form $\mathbf{Y}^n = \mathbf{X}_1^n + \mathbf{X}_2^n + \mathbf{S}^n + \mathbf{Z}^n$, where: \mathbf{X}_1^n and \mathbf{X}_2^n are the channel inputs with average power constraints $\frac{1}{n} \sum_{i=1}^n X_{1,i}^2 \leq P_1$ and $\frac{1}{n} \sum_{i=1}^n X_{2,i}^2 \leq P_2$, respectively, \mathbf{S}^n is the memoryless channel state vector whose elements are non-causally known at *both* the encoders and are zero-mean Gaussian random variables with variance Q , and \mathbf{Z}^n is the memoryless additive noise vector whose elements are zero-mean Gaussian random variables with variance N and are independent of the channel inputs and the channel state. The capacity region of this model is the set of rate pairs (R_1, R_2) satisfying

$$R_1 \leq \frac{1}{2} \log \left(1 + \frac{P_1}{N} \right) \quad (3a)$$

$$R_2 \leq \frac{1}{2} \log \left(1 + \frac{P_2}{N} \right) \quad (3b)$$

$$R_1 + R_2 \leq \frac{1}{2} \log \left(1 + \frac{P_1 + P_2}{N} \right). \quad (3c)$$

As in the single-user Gaussian model, the capacity region (3) indicates that the channel state has no effect on the capacity region if it is non-causally known to both the encoders. Similar to the single-user additive Gaussian models with channel state, DPC at both the encoders achieves (3) and explicit state cancellation is not optimal in terms of the capacity region. It is interesting to study the capacity region for the Gaussian MAC with non-causal channel state at one encoder because DPC cannot be applied at the uninformed encoder.

For the DM case, the state-dependent MAC with state at one encoder is considered in [21], [22], [23] when the informed encoder knows the message of the uninformed encoder. For the Gaussian case in the same scenario, the capacity region is obtained in [22], [24] by deriving non-trivial outer bounds. It is shown that the generalized dirty paper coding (GDPC) achieves the capacity region. The model considered in this paper from the view of lattice coding is also considered in [25]. Cemal and Steinberg study the state-dependent MAC in which rate-constrained state is known to the encoders and full state is known to the decoder [26]. State-dependent Broadcast channels with state available at the encoder have also been studied in the DM case [27], [28] and the Gaussian case [29].

C. Main Contributions and Organization of the paper

We derive an inner bound for the model shown in Figure 1 for the DM case and then specialize to a binary noiseless case. General outer bounds for these models have been obtained in [30], however, at present, these bounds do not coincide with our inner bounds and are not computable due to lack of bounds on the cardinalities of the auxiliary random variables. In binary noiseless case, the informed encoder uses a slightly generalized binary DPC, in which the random coding distribution has channel input random variable correlated to the channel state. If the binary channel state is a Bernoulli(q) random variable with $q < 0.5$, we compare the inner bound with a trivial outer bound obtained by providing the channel state to the decoder, and the bounds do not meet. If $q = 0.5$, we obtain the capacity region by deriving a non-trivial outer bound.

We also derive an inner bound for an additive white Gaussian state-dependent MAC similar to [19], [20], but in the asymmetric case in which one of the encoders has non-causal access to the state. For the inner bound, the informed encoder uses a generalized dirty paper coding (GDPC) scheme in which the random coding distribution exhibits arbitrary correlation between the channel input from the informed encoder and the channel state. The inner bound using GDPC is compared with a trivial outer bound obtained by providing channel state to the decoder. If the channel input from the informed encoder is negatively correlated with the channel state, then GDPC can be interpreted as partial state cancellation followed by standard dirty paper coding. We observe that, in terms of achievable rate region, the informed encoder with GDPC can assist the uninformed encoders. However, in contrast to the case of channel state available at all the encoders [19], [20], it appears that GDPC cannot completely eliminate the effect of the channel state on the capacity region for the Gaussian case.

We also study the Gaussian case if the channel state has asymptotically large variance Q , i.e., $Q \rightarrow \infty$. Interestingly, the uninformed encoders can benefit from the informed encoder's actions. In contrast to the case of $Q < \infty$ in which the informed encoder uses GDPC, we show that the standard DPC is sufficient to help the uninformed encoder as $Q \rightarrow \infty$. In this latter case, explicit state cancellation is not useful because it is impossible to explicitly cancel the channel state using the finite power of the informed encoder.

We organize the rest of the paper as follows. In Section II, we define some notation and the capacity region. In Section III, we study a general inner bound for the capacity region of the model in Figure 1 for a DM MAC and also specialize to a binary noiseless case. In this section, we also derive the capacity region of the binary noiseless MAC with maximum entropy channel state. In Section IV, we study inner and outer bounds on the capacity region of the model in Figure 1 for a memoryless Gaussian state-dependent MAC and also study the inner and outer bounds for the capacity region of this model in the case of large channel state variance. Section V concludes the paper.

II. NOTATIONS AND DEFINITIONS

Throughout the paper, the notation x is used to denote the realization of the random variable $X \sim p(x)$. The notation X_1^n represents the sequence $X_{1,1}, X_{1,2}, \dots, X_{1,n}$, and the notation $X_{1,i}^n$ represents the sequence $X_{1,i}, X_{1,i+1}, \dots, X_{1,n}$. Calligraphic letters are used to denote the random variable's alphabet, e.g., $X \in \mathcal{X}$. The notation $\text{cl}\{\mathcal{A}\}$ and $\text{co}\{\mathcal{A}\}$ denote the closure operation and convex hull operation on set \mathcal{A} , respectively.

We consider a memoryless state-dependent MAC, denoted $p(y|x_1, x_2, s)$, whose output $Y \in \mathcal{Y}$ is controlled by the channel input pair $(X_1, X_2) \in (\mathcal{X}_1, \mathcal{X}_2)$ and along with the channel state $S \in \mathcal{S}$. These alphabets are discrete sets and the set of real numbers for the discrete case and the Gaussian case, respectively. We assume that S_i at any time instant i is identically independently drawn (i.i.d.) according to a probability law $p(s)$. As shown in Figure 1, the state-dependent MAC is embedded in some environment in which channel state is non-causally known to one encoder.

The informed encoder, provided with the non-causal channel state, wants to send message W_1 to the decoder and the uninformed encoder wants to send W_2 to the decoder. The message sources at the informed

encoder and the uninformed encoder produce random integers

$$W_1 \in \{1, 2, \dots, M_1\} \quad \text{and} \quad W_2 \in \{1, 2, \dots, M_2\},$$

respectively, at the beginning of each block of n channel uses. We assume that the messages are independent and the probability of each pair of messages ($W_1 = w_1, W_2 = w_2$) is given by $\frac{1}{M_1 M_2}$.

Definition 1: A $(\lceil 2^{nR_1} \rceil, \lceil 2^{nR_2} \rceil, n)$ code consists of encoding functions

$$f_1^n : \mathcal{S}^n \times \mathcal{W}_1 \rightarrow \mathcal{X}_1^n \quad \text{and} \quad f_2^n : \mathcal{W}_2 \rightarrow \mathcal{X}_2^n$$

at the informed encoder and the uninformed encoder, respectively, and a decoding function

$$g^n : \mathcal{Y}^n \rightarrow (\mathcal{W}_1 \times \mathcal{W}_2),$$

where $\mathcal{W}_i = \{1, 2, \dots, \lceil 2^{nR_i} \rceil\}$ for $i = 1, 2$.

From a $(\lceil 2^{nR_1} \rceil, \lceil 2^{nR_2} \rceil, n)$ code, the sequences X_1^n and X_2^n from the informed encoder and the uninformed encoder, respectively, are transmitted without feedback across a state-dependent MAC $p(\mathbf{y}|\mathbf{x}_1, \mathbf{x}_2, \mathbf{s})$ modeled as a discrete memoryless conditional probability distribution, so that

$$\Pr(Y^n = \mathbf{y}^n | s^n, \mathbf{x}_1^n, \mathbf{x}_2^n) = \prod_{j=1}^n p(y_j | x_{1,j}, x_{2,j}, s_j). \quad (4)$$

The decoder, upon receiving the channel output Y^n , attempts to reconstruct the messages. The average probability of error is defined as $P_e^n = \Pr[g(Y^n) \neq (W_1, W_2)]$.

Definition 2: A rate pair (R_1, R_2) is said to be achievable if there exists a sequence of $(\lceil 2^{nR_1} \rceil, \lceil 2^{nR_2} \rceil, n)$ codes (f_1^n, f_2^n, g^n) with $\lim_{n \rightarrow \infty} P_e^n = 0$.

Definition 3: The capacity region \mathcal{C} is the closure the set of achievable rate pairs (R_1, R_2) .

Definition 4: For given $p(\mathbf{s})$ and $p(\mathbf{y}|\mathbf{x}_1, \mathbf{x}_2, \mathbf{s})$, let \mathcal{P}^i be the collection of random variables $(Q, S, \mathbf{U}_1, X_1, X_2, Y)$ with probability laws

$$\begin{aligned} p(\mathbf{q}, \mathbf{s}, \mathbf{u}_1, \mathbf{x}_1, \mathbf{x}_2, \mathbf{y}) &= p(\mathbf{q})p(\mathbf{s})p(\mathbf{u}_1|\mathbf{s}, \mathbf{q})p(\mathbf{x}_1|\mathbf{u}_1, \mathbf{s}, \mathbf{q})p(\mathbf{x}_2|\mathbf{q}) \\ &\quad \times p(\mathbf{y}|\mathbf{x}_1, \mathbf{x}_2, \mathbf{q}), \end{aligned}$$

where Q and \mathbf{U}_1 are auxiliary random variables.

III. DISCRETE MEMORYLESS CASE

In this section, we derive an inner bound for the capacity region of the model shown in Figure 1 for a general DM MAC and then specialize to a binary noiseless MAC. In this section, we consider $\mathcal{X}_1, \mathcal{X}_2, \mathcal{S}$, and \mathcal{Y} to all be discrete and finite alphabets, and all probability distributions are to be interpreted as probability mass functions.

A. Inner Bound for the Capacity Region

The following theorem provides an inner bound for the DM case.

Theorem 1: Let \mathcal{R}^i be the closure of all rate pairs (R_1, R_2) satisfying

$$R_1 < \mathbb{I}(\mathbf{U}_1; Y | X_2, Q) - \mathbb{I}(\mathbf{U}_1; S | Q) \quad (5a)$$

$$R_2 < \mathbb{I}(X_2; Y | \mathbf{U}_1, Q) \quad (5b)$$

$$R_1 + R_2 < \mathbb{I}(\mathbf{U}_1, X_2; Y | Q) - \mathbb{I}(\mathbf{U}_1; S | Q) \quad (5c)$$

for some random vector $(Q, S, \mathbf{U}_1, X_1, X_2, Y) \in \mathcal{P}^i$, where $Q \in \mathcal{Q}$ and $\mathbf{U}_1 \in \mathcal{U}_1$ are auxiliary random variables with $|\mathcal{Q}| \leq 4$ and $|\mathcal{U}_1| \leq |\mathcal{X}_1| |\mathcal{X}_2| |\mathcal{S}| + 4$, respectively. Then the capacity region \mathcal{C} of the DM MAC with one informed encoder satisfies $\mathcal{R}^i \subseteq \mathcal{C}$.

Proof: The above inner bound can be proved by essentially combining random channel coding for the DM MAC [31] and random channel coding with non-causal state at the encoders [16]. For completeness, a proof using joint decoding is given in Appendix A.

Remarks:

- The inner bound of Theorem 1 can be obtained by applying Gel'fand-Pinsker coding [16] at the informed encoder. At the uninformed encoder, the codebook is generated in the same way as for a regular DM MAC [31].
- The region \mathcal{R}^i in Theorem 1 is convex due to the auxiliary time-sharing random variable Q .
- The inner bound \mathcal{R}^i of Theorem 1 can also be obtained by time-sharing between two successive decoding schemes, i.e., decoding one encoder's message first and using the decoded codeword and the channel output to decode the other encoder's message. On one hand consider first decoding the message of the informed encoder. Following [16], if $R_1 < \mathbb{I}(\mathbf{U}_1; Y) - \mathbb{I}(\mathbf{U}_1; S)$, we can decode the codeword \mathbf{U}_1^n of the informed encoder with arbitrarily low probability of error. Now, we use \mathbf{U}_1^n along with Y^n to decode X_2^n . Under these conditions, if $R_2 < \mathbb{I}(X_2; Y|\mathbf{U}_1)$, then we can decode the message of the uninformed encoder with arbitrarily low probability of error. On the other hand, if we change the decoding order of the two messages, the constraints are $R_2 < \mathbb{I}(X_2; Y)$ and $R_1 < \mathbb{I}(\mathbf{U}_1; Y|X_2) - \mathbb{I}(\mathbf{U}_1; S)$. By time-sharing between these two successive decoding schemes and taking the convex closure, we can obtain the inner bound \mathcal{R}^i of Theorem 1.

B. Binary Noiseless Example

In this section, we specialize Theorem 1 to a binary noiseless state-dependent MAC of the form $Y^n = X_1^n \oplus X_2^n \oplus S^n$, where: X_1^n and X_2^n are channel inputs with the number of binary ones in X_1^n and X_2^n less than or equal to np_1 , $0 \leq p_1 \leq 1$, and np_2 , $0 \leq p_2 \leq 1$, respectively; S^n is the memoryless state vector whose elements are non-causally known to one encoder and are i.i.d. Bernoulli(q) random variables, $0 \leq q \leq 1$; and \oplus represents modulo-2 addition. By symmetry, we assume that $p_1 \leq 0.5$, $p_2 \leq 0.5$, and $q \leq 0.5$.

1) *Inner and Outer Bounds:* The following corollary gives an inner bound for the capacity region of the binary noiseless MAC by applying a slightly generalized binary DPC at the informed encoder in which the channel input X_1 and the channel state S are correlated.

Definition 5: Let $\mathcal{R}^i(a_{10}, a_{01})$ be the set of all rate pairs (R_1, R_2) satisfying

$$R_1 < (1 - q)\mathbb{H}_b(a_{10}) + q\mathbb{H}_b(a_{01}) \quad (6a)$$

$$R_2 < \mathbb{H}_b(p_2) \quad (6b)$$

$$\begin{aligned} R_1 + R_2 &< (1 - q)\mathbb{H}_b(a_{10}) + q\mathbb{H}_b(a_{01}) \\ &+ \mathbb{H}_b(p_2 * [qa_{01} + (1 - q)a_{10}]) \\ &- \mathbb{H}_b(qa_{01} + (1 - q)a_{10}), \end{aligned} \quad (6c)$$

for $(a_{10}, a_{01}) \in \mathcal{A}$, where

$$\mathcal{A} := \{(x, y) : 0 \leq x, y \leq 1, \text{ and } (1 - q)x + q(1 - y) \leq p_1\},$$

and $\mathbb{H}_b(\gamma) := -\gamma \log_2(\gamma) - (1 - \gamma) \log_2(1 - \gamma)$, and $x * y := x(1 - y) + y(1 - x)$. Let

$$\mathcal{R}_{\text{BIN}}^i := \text{cl}\{\text{co}\{\cup_{(a_{10}, a_{01}) \in \mathcal{A}} \mathcal{R}^i(a_{10}, a_{01})\}\}.$$

Corollary 1: The capacity region \mathcal{C}_{BIN} for the binary noiseless state-dependent MAC with one informed encoder satisfies $\mathcal{R}_{\text{BIN}}^i \subseteq \mathcal{C}_{\text{BIN}}$.

Proof: Encoding and decoding are similar to encoding and decoding explained for the general DM case above. The informed encoder uses generalized binary DPC in which the random coding distribution allows arbitrary correlation between the channel input from the informed encoder and the known state. We consider $\mathbf{U}_1 = X_1 \oplus S$ and $X_2 \sim \text{Bernoulli}(p_2)$, where: X_1 is related to S by $a_{01} = P(X_1 = 0|S = 1)$ and $a_{10} = P(X_1 = 1|S = 0)$ with a_{01} and a_{10} chosen such that $P(X_1 = 1) \leq p_1$. We compute the region

$\mathcal{R}^i(a_{10}, a_{01})$ defined in (1) using the probability mass function of X_2 and the auxiliary random variable U_1 for all $(a_{10}, a_{01}) \in \mathcal{A}$, and deterministic Q to obtain the region $\mathcal{R}_{\text{BIN}}^i$ in (5). We use deterministic Q to compute the region in the binary case because we explicitly take the convex hull of unions of the regions computed with distributions. This completes the proof.

The following proposition provides a trivial outer bound for the capacity region of the binary noiseless MAC with one informed encoder. We do not provide a proof because this outer bound can be easily obtained if we provide the channel state to the decoder.

Proposition 1: Let $\mathcal{R}_{\text{BIN}}^o$ be the set of all rate pairs (R_1, R_2) satisfying

$$R_1 \leq \mathbb{H}_b(p_1) \quad (7a)$$

$$R_2 \leq \mathbb{H}_b(p_2) \quad (7b)$$

$$R_1 + R_2 \leq \begin{cases} \mathbb{H}_b(p_1 + p_2) & \text{if } 0 \leq p_1 + p_2 < 0.5 \\ 1 & \text{if } 0.5 \leq p_1 + p_2 \leq 1 \end{cases} \quad (7c)$$

Then the capacity region \mathcal{C}_{BIN} for the binary noiseless MAC with one informed encoder satisfies $\mathcal{C}_{\text{BIN}} \subseteq \mathcal{R}_{\text{BIN}}^o$.

2) *Numerical Example:* Figure 2 depicts the inner bound using generalized binary DPC specified in Corollary 1 and the outer bound specified in Proposition 1 for the case in which $p_1 = 0.1$, $p_2 = 0.4$, and $q = 0.2$. Also shown for comparison are the following: an inner bound using binary DPC alone, or the generalized DPC with $a_{10} = p_1$ and $a_{01} = 1 - p_1$; and the inner bound for the capacity region of the case in which the state is known to neither the encoders nor the decoder.

These results show that the inner bound obtained by generalized binary DPC is larger than that obtained using binary DPC [32], and suggest that the informed encoder can help the uninformed encoder using binary DPC [32] as well as generalized binary DPC. Even though state is known to only one encoder, both the encoders can benefit in terms of achievable rates compared to the case in which state is unavailable at the encoder and the decoder.

3) *Maximum Entropy State:* In this section, we discuss how the uninformed encoder benefits from the actions of the informed encoder even if $q = 0.5$ so that $\mathbb{H}_b(S) = 1$. The following corollary provides the capacity region of the noiseless binary MAC with one informed encoder in this case.

Corollary 2: For the given input constraints (p_1, p_2) and $q = 0.5$, the capacity region of the binary noiseless MAC with one informed encoder is the set of rate pairs (R_1, R_2) satisfying

$$R_2 \leq \mathbb{H}_b(p_2) \quad (8a)$$

$$R_1 + R_2 \leq \mathbb{H}_b(p_1). \quad (8b)$$

Proof: The region (2) is achieved if the informed encoder employs the generalized binary DPC with $a_{10} = p_1$ and $a_{01} = 1 - p_1$ or the standard binary DPC. We obtain (8) from (6) by substituting $a_{10} = p_1$ and $a_{01} = 1 - p_1$ in (6). A converse proof for the above capacity region is given in Appendix B.

Remarks

- From (8), we see that the uninformed encoder can achieve rates below $\min\{\mathbb{H}_b(p_1), \mathbb{H}_b(p_2)\}$ though the channel has maximum entropy state. Let us investigate how the uninformed encoder can benefit from the informed encoder's actions even in this case using successive decoding in which U_1^n is decoded first using Y^n and then X_2^n is decoded using Y^n and U_1^n . The informed encoder applies the standard binary DPC, i.e., $a_{10} = p_1$ and $a_{01} = (1 - p_1)$ in generalized binary DPC, to generate its codewords, and the uninformed encoder uses a Bernoulli(\tilde{p}_2) random variable to generate its codewords, where $\tilde{p}_2 \leq p_2$. In the case of maximum entropy state, U_1^n can be decoded first with arbitrary low probability of error if R_1 satisfies

$$R_1 < \mathbb{H}_b(p_1) - \mathbb{H}_b(\tilde{p}_2). \quad (9)$$

for $\tilde{p}_2 \leq p_2$ and $\tilde{p}_2 \leq p_1$. The channel output can be written as $Y_i = U_{1,i} \oplus X_{2,i}$ because $U_{1,i} = X_{1,i} \oplus S_i$ for $i \in \{1, 2, \dots, n\}$. Using U_1^n , we can generate a new channel output for decoding X_2^n as

$$\tilde{Y}_i = Y_i \oplus U_{1,i} = X_{2,i}$$

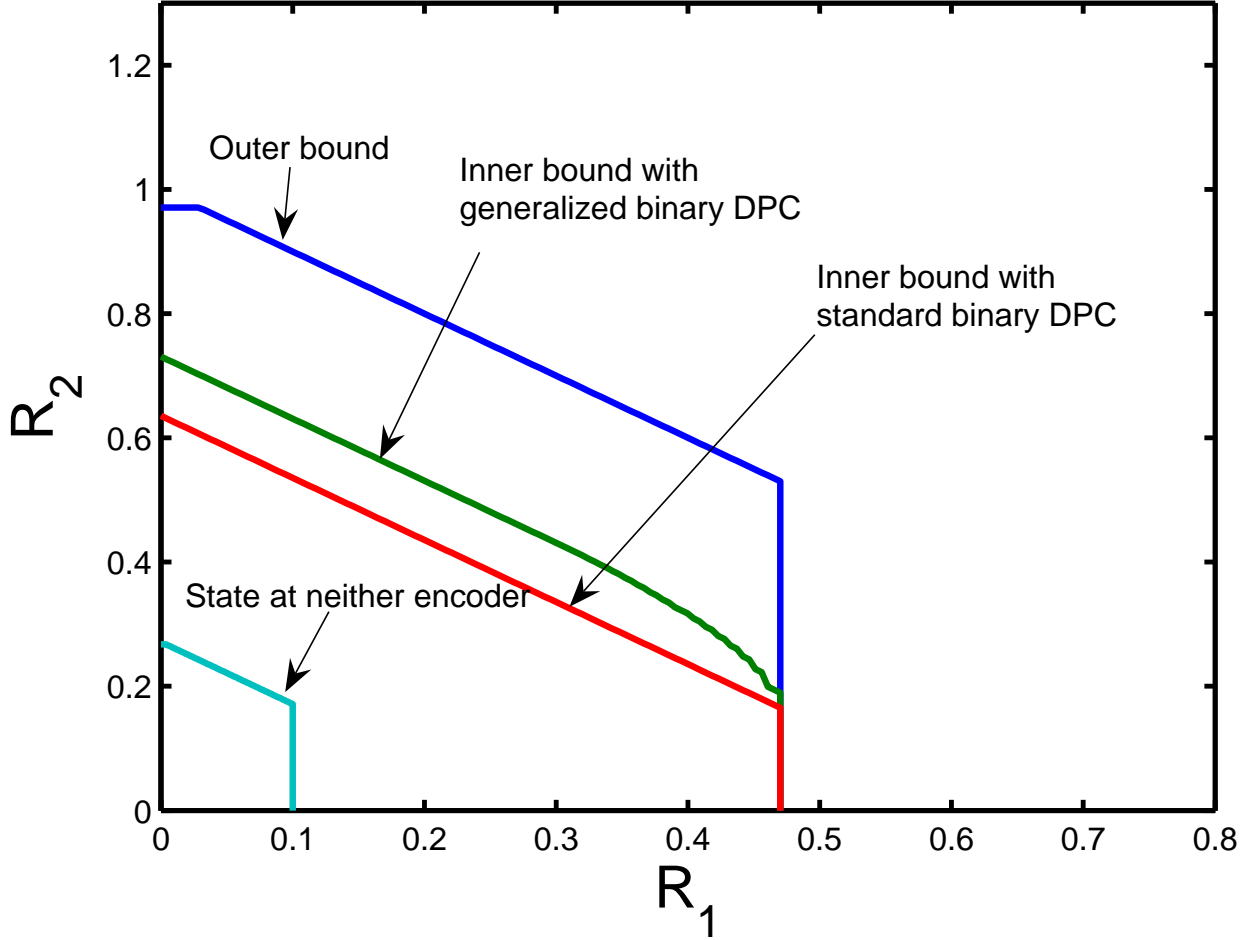

Fig. 2. A numerical example of the binary noiseless multiple access channel with $p_1 = 0.1$, $p_2 = 0.4$, $q = 0.2$.

for $i \in \{1, 2, \dots, n\}$. Since there is no binary noise present in \tilde{Y}^n for decoding X_2^n , the message of the uninformed encoder can be decoded with arbitrarily low probability of error if $R_2 < \mathbb{H}_b(\tilde{p}_2)$ for \tilde{p}_2 satisfying both $\tilde{p}_2 \leq p_1$ and $\tilde{p}_2 \leq p_2$.

Then the bound on R_2 can be written as

$$R_2 < \min\{\mathbb{H}_b(p_1), \mathbb{H}_b(p_2)\}.$$

If $p_1 > p_2$, we can achieve $R_2 < \mathbb{H}_b(p_2)$ as if there were no state in the channel, though the maximum entropy binary state is present in the channel and the state is not known to the uninformed encoder.

If $p_1 \leq p_2$, the uninformed encoder can still achieve positive rates, i.e., $R_2 < \mathbb{H}_b(p_1)$.

- Let us now discuss how the informed encoder achieves rate below $\mathbb{H}_b(p_1)$ using successive decoding in the reverse order, i.e., X_2^n is decoded first using Y^n and then U_1^n is decoded using Y^n and X_2^n . If $q = 0.5$, X_2^n can be decoded with arbitrary low probability of error if $R_2 < [\mathbb{H}_b(p_2 * (p_1 * 0.5)) - \mathbb{H}_b(p_1 * 0.5)] = 0$. This means that only $R_2 = 0$ is achievable. Then $R_1 < \mathbb{H}_b(p_1)$ is achievable with $a_{10} = p_1$ and $a_{01} = 1 - p_1$.

Let us illustrate the case of maximum entropy binary state with numerical examples. Figure 3 illustrates the inner bound given in Corollary 2 for $q = 0.5$ and $p_2 = 0.3$ in two cases $p_1 = 0.2$ ($p_1 \leq p_2$) and $p_1 = 0.4$ ($p_1 > p_2$). In both cases, these numerical examples suggest that the uninformed encoder achieves positive rates from the actions of the informed encoder as discussed above. In the case of $p_1 = 0.4$

($p_1 > p_2$), the informed encoder can still achieve $\mathbb{H}_b(p_2)$ though the channel state has high entropy and is not known to the uninformed encoder, and the informed encoder has input constraint $p_1 = 0.4$.

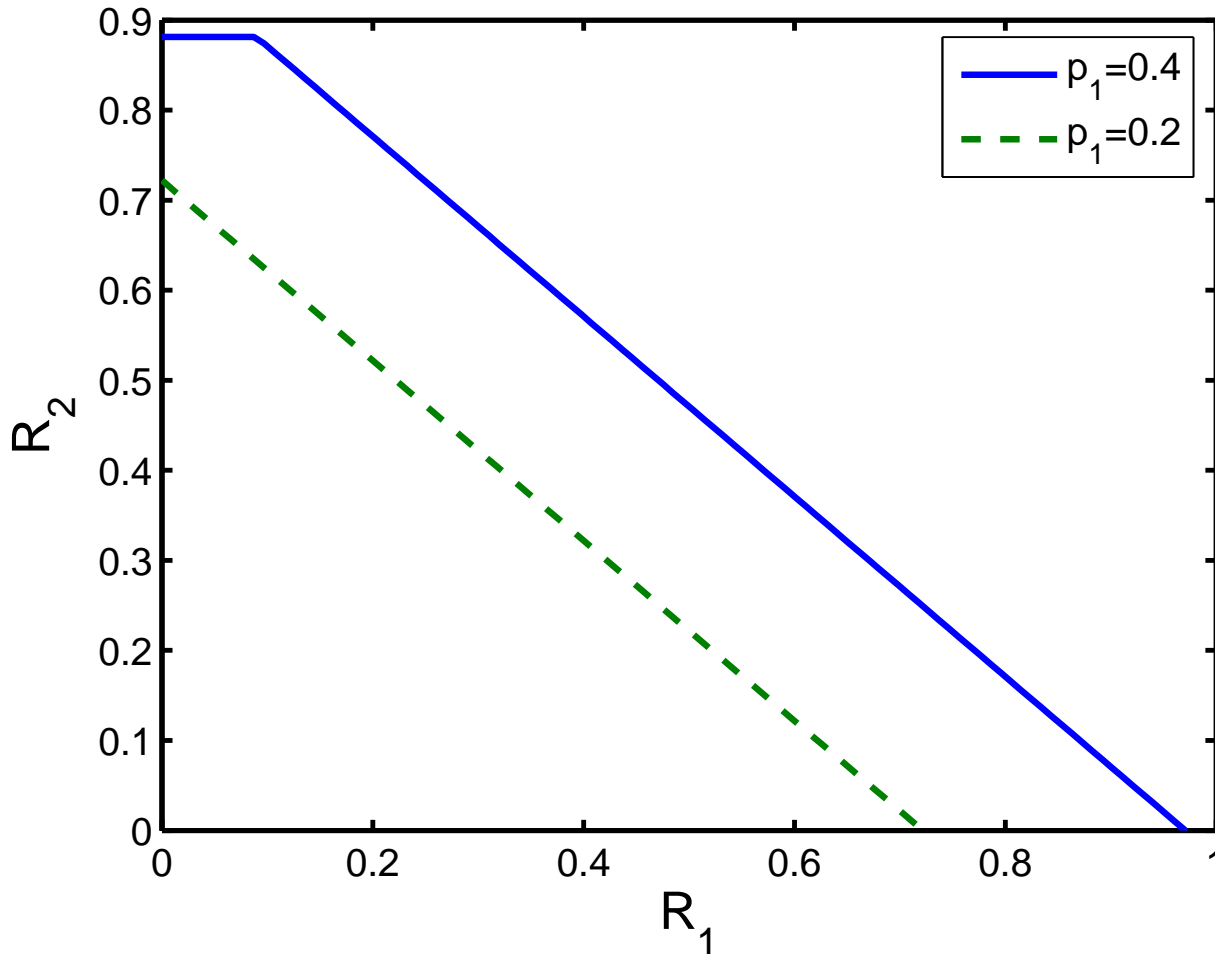

Fig. 3. The capacity region of the binary noiseless MAC with maximum entropy binary state, i.e., $q = 0.5$, and $p_2 = 0.3$.

IV. GAUSSIAN MEMORYLESS CASE

In this section, we develop inner and outer bounds for the memoryless Gaussian case. The additive Gaussian MAC with one informed encoder is shown in Figure 4. The output of the channel is $Y^n = X_1^n + X_2^n + S^n + Z^n$, where: X_1^n and X_2^n are the channel inputs with average power constraints $\sum_{i=1}^n X_{1,i}^2 \leq nP_1$ and $\sum_{i=1}^n X_{2,i}^2 \leq nP_2$ with probability one, respectively; S^n is the memoryless state vector whose elements are zero-mean Gaussian random variables with variance Q ; and Z^n is the memoryless additive noise vector whose elements are zero-mean Gaussian random variables with variance N and independent of the channel inputs and the state.

A. Inner and Outer Bounds on the Capacity Region

The following definition and theorem give an inner bound for the Gaussian MAC with one informed encoder. To obtain the inner bound for this case, we apply generalized dirty paper coding (GDPC) at the informed encoder.

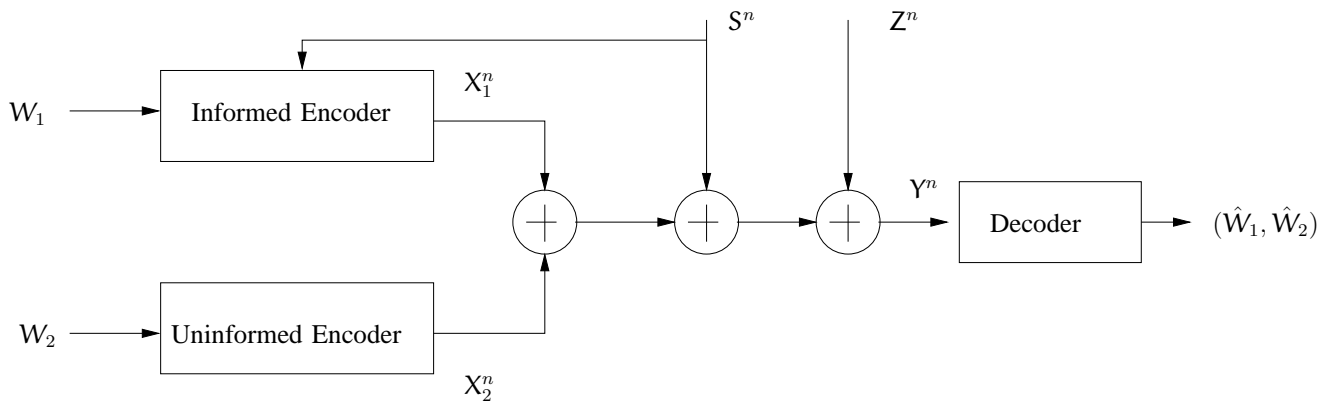

Fig. 4. Gaussian state-dependent multiaccess channel with channel state non-causally known to one encoder.

Definition 6: Let

$$r_1(\rho, \alpha) := \frac{1}{2} \log \left(\frac{P_1(1 - \rho^2)(P_1 + Q + 2\rho\sqrt{P_1Q} + N)}{P_1Q(1 - \rho^2)(1 - \alpha)^2 + N(P_1 + \alpha^2Q + 2\alpha\rho\sqrt{P_1Q})} \right) \quad (10a)$$

$$r_2(\rho, \alpha) := \frac{1}{2} \log \left(1 + \frac{P_2}{N + \frac{P_1Q(1 - \rho^2)(1 - \alpha)^2}{(P_1 + \alpha^2Q + 2\alpha\rho\sqrt{P_1Q})}} \right) \quad (10b)$$

$$r_3(\rho, \alpha) := \frac{1}{2} \log \left(\frac{P_1(1 - \rho^2)(P_1 + P_2 + Q + 2\rho\sqrt{P_1Q} + N)}{P_1Q(1 - \rho^2)(1 - \alpha)^2 + N(P_1 + \alpha^2Q + 2\alpha\rho\sqrt{P_1Q})} \right) \quad (10c)$$

for a given $-1 \leq \rho \leq 0$, and a given $\alpha \in \mathcal{A}(\rho)$, where

$$\mathcal{A}(\rho) = \{x \in \mathbb{R} : r_1(\rho, x) \geq 0, r_2(\rho, x) \geq 0, r_3(\rho, x) \geq 0\}.$$

Theorem 2: Let $\mathcal{R}^i(\rho, \alpha)$ be the set of all rate pairs (R_1, R_2) satisfying $R_1 < r_1(\rho, \alpha)$, $R_2 < r_2(\rho, \alpha)$, and $R_1 + R_2 < r_3(\rho, \alpha)$ for given $-1 \leq \rho \leq 0$ and $\alpha \in \mathcal{A}(\rho)$. Let

$$\mathcal{R}_G^i = \text{cl}\{\text{co}\{\cup_{-1 \leq \rho \leq 0, \alpha \in \mathcal{A}(\rho)} \mathcal{R}^i(\rho, \alpha)\}\}. \quad (11)$$

Then the capacity region \mathcal{C}_G of the Gaussian MAC with one informed encoder satisfies $\mathcal{R}_G^i \subseteq \mathcal{C}_G$.

Proof: Our results for the DM MAC can readily be extended to memoryless channels with discrete time and continuous alphabets using standard techniques [33]. The informed encoder uses GDPC in which the random coding distribution allows arbitrary correlation between the channel input from the informed encoder and the known channel state. Fix a correlation parameter $-1 \leq \rho \leq 0$. We then consider the auxiliary random variable $U_1 = X_1 + \alpha S$, where α is a real number whose range will be discussed later, X_1 and S are correlated with correlation coefficient ρ , $X_1 \sim \mathcal{N}(0, P_1)$, and $S \sim \mathcal{N}(0, Q)$. We consider $X_2 \sim \mathcal{N}(0, P_2)$. Encoding and decoding are performed similar to the proof of Theorem 1 in Section A. In this case, we assume that q is deterministic because time sharing of regions with different distributions is accomplished by explicitly taking convex hull of union of regions with different distributions. We evaluate (5) using the jointly Gaussian distribution of random variables S, U_1, X_1, X_2, Z , and Y for a given (ρ, α) and obtain $\mathcal{R}^i(\rho, \alpha)$. Also note that we restrict α to $\mathcal{A}(\rho) = \{\alpha : \alpha \in \mathbb{R}, r_1(\rho, \alpha) \geq 0, r_2(\rho, \alpha) \geq 0, r_3(\rho, \alpha) \geq 0\}$ for a given ρ . By varying ρ and α , we obtain different achievable rate regions $\mathcal{R}^i(\rho, \alpha)$. Taking the union of regions $\mathcal{R}^i(\rho, \alpha)$ obtained by varying ρ and α followed by taking the closure and the convex hull operations completes the proof.

Remarks

- In both standard DPC [18] and GDPC, the auxiliary random variable is given by $U_1 = X_1 + \alpha S$. In GDPC, $X_1 \sim \mathcal{N}(0, P_1)$ and $S \sim \mathcal{N}(0, Q)$ are jointly correlated with correlation coefficient ρ , whereas in the standard DPC, they are uncorrelated. If the channel input X_1 is negatively correlated with the

channel state S , then GDPC can be viewed as partial state cancellation followed by standard DPC. To see this, let us assume that ρ is negative and denote \hat{X}_1 as a linear estimate of X_1 from αS under the minimum mean square error (MMSE) criterion. Accordingly, $\hat{X}_1 = \alpha \rho \sqrt{\frac{P_1}{Q}} S$. We can rewrite the auxiliary random variable U_1 as follows

$$\begin{aligned} U_1 &= (X_1 - \hat{X}_1) + \hat{X}_1 + \alpha S \\ &= X_{1,w} + \alpha \left(1 + \rho \sqrt{\frac{P_1}{Q}} \right) S \\ &= X_{1,w} + \alpha \left(1 - \sqrt{\frac{\gamma P_1}{Q}} \right) S \\ &= X_{1,w} + \alpha \hat{S} \end{aligned} \tag{12}$$

where $\gamma = \rho^2 \in (0, 1]$, \hat{S} can be viewed as the remaining state after state cancellation using power γP_1 , and $X_{1,w}$ is error with variance $(1 - \gamma)P_1$ and is uncorrelated with \hat{S} . GDPC with negative correlation coefficient ρ can be interpreted as standard DPC with power $(1 - \gamma)P_1$ applied on the remaining state \hat{S} after state cancellation using power γP_1 .

- In this paper, we focus on the two-encoder model in which one is informed and the other is uninformed, but the concepts can be extended to the model with any number of uninformed and informed encoders. The informed encoders apply GDPC to help the uninformed encoders. Following [19], [20], the informed encoders cannot be affected from the actions of the other informed encoders because the informed encoders can eliminate the effect of the remaining state on their transmission after the state cancellation by them.

The following proposition gives a trivial outer bound for the capacity region of the Gaussian MAC with one informed encoder. We do not provide a proof because this bound is the capacity region of the additive white Gaussian MAC with *all* informed encoders [19], [20], the capacity region of the additive white Gaussian MAC with state known to only the decoder, and the capacity region of the additive white Gaussian MAC without state.

Proposition 2: Let \mathcal{R}_G^o be the set of all rate pairs (R_1, R_2) satisfying

$$R_1 \leq \frac{1}{2} \log \left(1 + \frac{P_1}{N} \right) \tag{13a}$$

$$R_2 \leq \frac{1}{2} \log \left(1 + \frac{P_2}{N} \right) \tag{13b}$$

$$R_1 + R_2 \leq \frac{1}{2} \log \left(1 + \frac{P_1 + P_2}{N} \right). \tag{13c}$$

Then the capacity region \mathcal{C}_G for the Gaussian MAC with one informed encoder satisfies $\mathcal{C}_G \subseteq \mathcal{R}_G^o$.

B. Numerical Example

Figure 5 depicts the inner bound using GDPC given in Theorem 2 and the outer bound specified in Proposition 2 for the case in which $P_1 = 15$, $P_2 = 50$, $Q = 20$, and $N = 60$. Also shown for comparison are the following: an inner bound using DPC alone, or GDPC with $\rho = 0$ and α as parameter; and the capacity region for the case in which the the state is unavailable at the encoders and the decoder.

These results suggest that the informed encoder can help the uninformed encoder using DPC as well as GDPC. Even though the state is known only at one encoder, both the encoders benefit from this situation by allowing negative correlation between the channel input X_1 and the state S at the informed encoder, since the negative correlation allows the informed encoder to partially cancel the state. The achievable rate region $\mathcal{R}^i(0, \alpha)$ obtained by applying DPC [18] with α as a parameter is always contained in \mathcal{R}_G^i in

(11). In contrast to the case of state available to both the encoders [19], [20], GDPC is not sufficient to completely mitigate the effect of state on the capacity region.

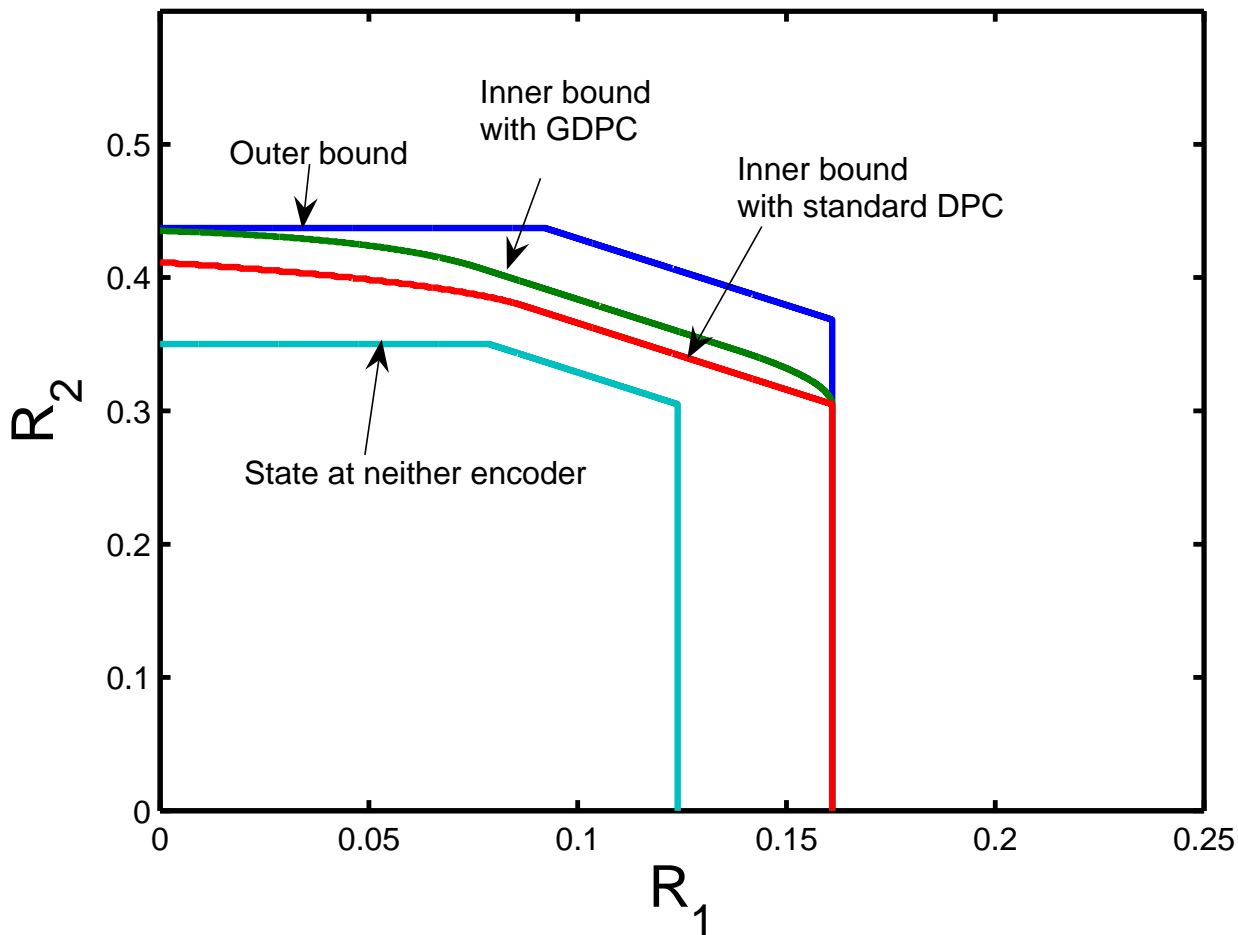

Fig. 5. An achievable region for Gaussian MAC with $P_1 = 15$, $P_2 = 50$, $Q = 20$, and $N = 60$.

Figure 6 illustrates how the maximum rate of the uninformed encoder $R_{2,\max}$ varies with the channel state variance Q if $R_1 = 0$, for $P_2 = 50$, and $N = 60$. As shown in Figure 6, $R_{2,\max}$ decreases as Q increases because the variance of remaining state also increases following state cancellation by the informed encoder. The decrease in $R_{2,\max}$ is slower as P_1 increases because the informed encoder can help the uninformed encoder more in terms of achievable rates as its power increases.

C. Asymptotic Analysis

In this section, we discuss the inner bound in Theorem 2 as $Q \rightarrow \infty$.

Definition 7: Let $\tilde{\mathcal{R}}^i(\rho, \alpha)$ be the set of all rate pairs (R_1, R_2) satisfying $R_1 < \tilde{r}_1(\rho, \alpha)$, $R_2 < \tilde{r}_2(\rho, \alpha)$, and $R_1 + R_2 < \tilde{r}_3(\rho, \alpha)$ for a given $-1 \leq \rho \leq 0$ and $\alpha \in \tilde{\mathcal{A}}(\rho) = \{x \in \mathbb{R} : 0 \leq x \leq \frac{2P_1(1-\rho^2)}{P_1(1-\rho^2)+N}\}$, where

$$\tilde{r}_1(\rho, \alpha) = \lim_{Q \rightarrow \infty} r_1(\rho, \alpha) = \frac{1}{2} \log \left(\frac{P_1(1-\rho^2)}{P_1(1-\rho^2)(1-\alpha)^2 + \alpha^2 N} \right) \quad (14a)$$

¹ $r_i(\rho, \alpha)$ for $i = 1, 2, 3$ is defined in (10) and is function of Q , though variable Q is not mentioned in the notation $r_i(\rho, \alpha)$.

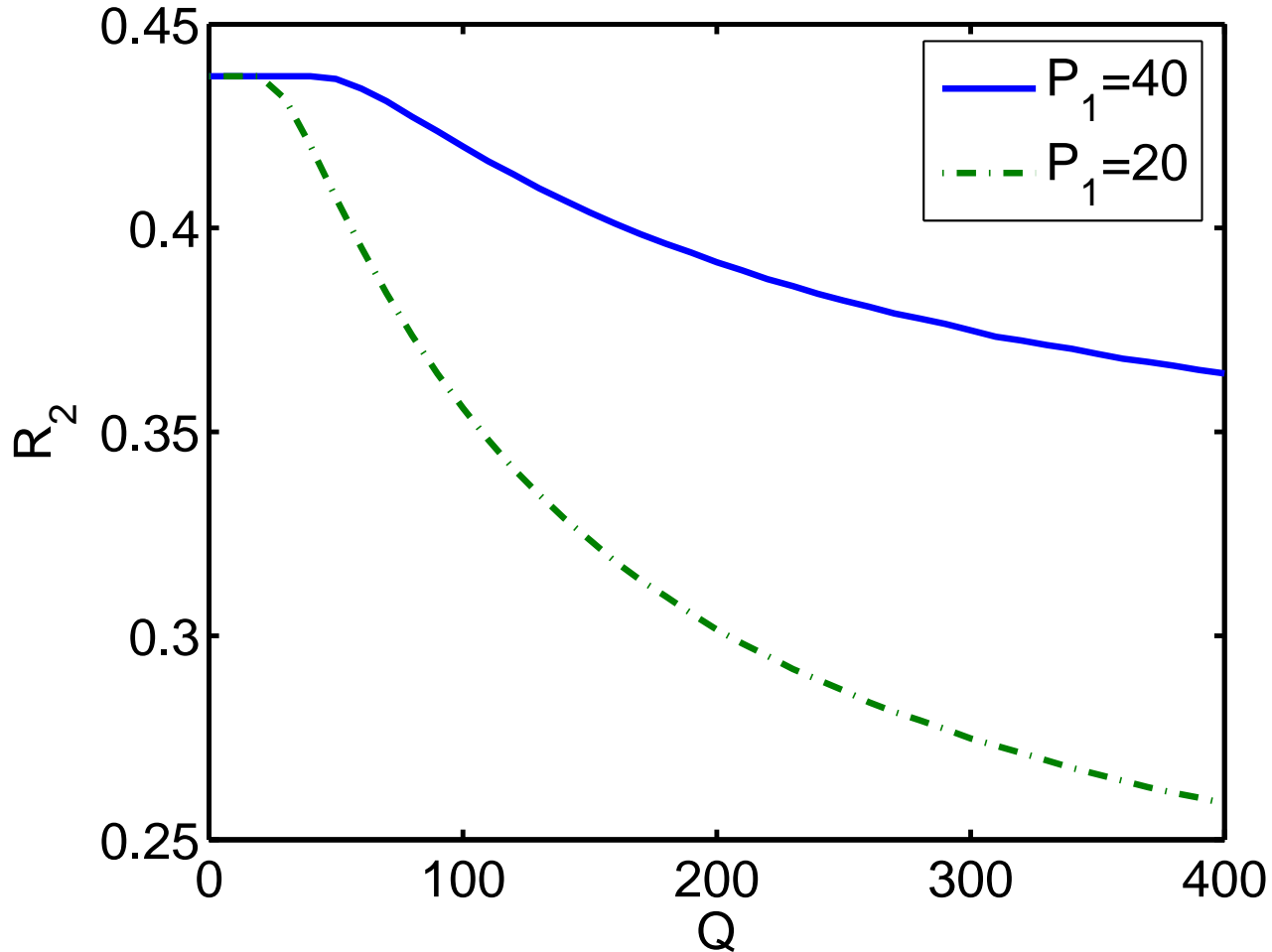

Fig. 6. Variation of the maximum rate of uninformed encoder $R_{2,\max}$ with the channel state variance Q when $R_1 = 0$, $P_2 = 50$, and $N = 60$.

$$\tilde{r}_2(\rho, \alpha) = \lim_{Q \rightarrow \infty} r_2(\rho, \alpha) = \frac{1}{2} \log \left(1 + \frac{P_2}{N + \frac{P_1(1-\rho^2)(1-\alpha)^2}{\alpha^2}} \right) \quad (14b)$$

$$\tilde{r}_3(\rho, \alpha) = \lim_{Q \rightarrow \infty} r_3(\rho, \alpha) = \frac{1}{2} \log \left(\frac{P_1(1-\rho^2)}{P_1(1-\rho^2)(1-\alpha)^2 + \alpha^2 N} \right). \quad (14c)$$

Corollary 3: As the variance of the state becomes very large, i.e., $Q \rightarrow \infty$, an inner bound for the capacity region of the Gaussian MAC with one informed encoder is given by

$$\tilde{\mathcal{R}}_G^i = \text{cl}\{\text{co}\{\cup_{-1 \leq \rho \leq 0, \alpha \in \mathcal{A}(\rho)} \tilde{\mathcal{R}}^i(\rho, \alpha)\}\}.$$

Remarks:

- Let us investigate how the uninformed encoder can benefit from the informed encoder's actions even as $Q \rightarrow \infty$. For this discussion, consider successive decoding in which the auxiliary codeword U_1^n of the informed encoder is decoded first using the channel output Y^n and then the codeword X_2^n of the uninformed encoder is decoded using Y^n and U_1^n . In the limit as $Q \rightarrow \infty$, U_1^n can be decoded first with arbitrary low probability of error if R_1 satisfies

$$R_1 < \frac{1}{2} \log \left(\frac{P_1(1-\rho^2)}{P_1(1-\rho^2)(1-\alpha)^2 + \alpha^2(P_2 + N)} \right), \quad (15)$$

where $\rho \in [-1, 0]$ and $0 \leq \alpha \leq \frac{2P_1(1-\rho^2)}{P_1(1-\rho^2) + P_2 + N}$. The right hand side of (15) is obtained by calculating

the expression $\mathbb{I}(\mathbf{U}_1; \mathbf{Y}) - \mathbb{I}(\mathbf{U}_1, \mathbf{S})$ for the assumed jointly Gaussian distribution and letting $Q \rightarrow \infty$. The channel output can be written as $Y_i = \mathbf{U}_{1,i} + \mathbf{X}_{2,i} + (1 - \alpha)\mathbf{S}_i + \mathbf{Z}_i$ because $\mathbf{U}_{1,i} = \mathbf{X}_{1,i} + \alpha\mathbf{S}_i$ for $i \in \{1, 2, \dots, n\}$. The estimate of $(1 - \alpha)\mathbf{S}_i$ using $\mathbf{U}_{1,i}$ is denoted as $\hat{\mathbf{S}}_i$ for $i \in \{1, 2, \dots, n\}$. Using $\hat{\mathbf{S}}^n$ and \mathbf{U}_1^n , we can generate a new channel output for decoding \mathbf{X}_2^n as

$$\tilde{Y}_i = Y_i - \mathbf{U}_{1,i} - \hat{\mathbf{S}}_i = \mathbf{X}_{2,i} + \mathbf{Z}_i + ((1 - \alpha)\mathbf{S}_i - \hat{\mathbf{S}}_i)$$

for $i \in \{1, 2, \dots, n\}$. Since all random variables are identical, we omit the subscript i for further discussion. The variance of total noise present in elements of $\tilde{\mathbf{Y}}^n$ for decoding \mathbf{X}_2^n is $N + \frac{P_1(1-\rho^2)(1-\alpha)^2}{\alpha^2}$, where N is the variance of \mathbf{Z} , and $\frac{P_1(1-\rho^2)(1-\alpha)^2}{\alpha^2}$ is the error of estimating $(1 - \alpha)\mathbf{S}$ from \mathbf{U}_1 . Then the message of the uninformed encoder can be decoded with arbitrarily low probability of error if $R_2 < \lim_{Q \rightarrow \infty} r_2(\rho, \alpha)$ for given $\rho \in [-1, 0]$ and $0 \leq \alpha \leq \frac{2P_1(1-\rho^2)}{P_1(1-\rho^2) + P_2 + N}$. Even if the variance of the state becomes infinite, nonzero rate for the uninformed encoder can be achieved because the estimation error is finite for $\rho \in [-1, 0]$ due to the increase of the variance of \mathbf{U}_1 with the increase of the state variance.

Our aim is to minimize the variance of the estimation error $((1 - \alpha)\mathbf{S} - \hat{\mathbf{S}})$ to maximize $r_2(\rho, \alpha)$ over ρ and α . Since the right hand side of (15) becomes non-negative for $0 \leq \alpha \leq \frac{2P_1(1-\rho^2)}{P_1(1-\rho^2) + P_2 + N}$ and $\rho \in [-1, 0]$, we consider only these values. The variance of the estimation error is decreasing in both $\rho \in [-1, 0]$ and $\alpha \in [0, 1]$ and is increasing in the remaining range of α . Then $r_2(\rho, \alpha)$ achieves its maximum at $\rho = 0$ and $\alpha = \min\{1, \frac{2P_1}{P_1 + P_2 + N}\}$. If $P_1 \geq P_2 + N$, so that R_1 is nonnegative, then

$$R_2 < \frac{1}{2} \log \left(1 + \frac{P_2}{N} \right)$$

is achievable. In this case, the uninformed encoder fully benefits from actions of the informed encoder, specifically from its auxiliary codewords, even though the variance of interfering state is very large. If $P_1 < P_2 + N$, then $R_2 < \lim_{Q \rightarrow \infty} r_2(0, \alpha^*)$ is achievable where $\alpha^* = \frac{2P_1}{P_1 + P_2 + N}$. In either case, GDPC with $\rho = 0$ is optimal in terms of assisting the uninformed encoder, contrary to the case of finite state variance. This makes sense because, if the state has infinite variance, then it is impossible for the informed encoder to explicitly cancel it with finite power.

- To investigate how the informed encoder achieves its maximum rate, let us consider successive decoding in the reverse order in which \mathbf{X}_2^n is decoded first using \mathbf{Y}^n and then \mathbf{U}_1^n is decoded using \mathbf{Y}^n and \mathbf{X}_2^n . As $Q \rightarrow \infty$, \mathbf{X}_2^n can be decoded with arbitrary low probability of error if $R_2 < \lim_{Q \rightarrow \infty} \mathbb{I}(\mathbf{X}_2, \mathbf{Y}) = 0$. This means that only $R_2 = 0$ is achievable. Then $R_1 < \frac{1}{2} \log \left(1 + \frac{P_1}{N} \right)$ is achievable with $\rho = 0$ and $\alpha = \frac{P_1}{P_1 + N}$.

The following proposition gives an outer bound for the Gaussian MAC with one informed encoder as $Q \rightarrow \infty$.

Proposition 3: As $Q \rightarrow \infty$, an outer bound for the capacity region of the Gaussian MAC with one informed encoder is the set of rate pairs (R_1, R_2) satisfying

$$R_2 \leq \frac{1}{2} \log \left(1 + \frac{P_2}{N} \right) \quad (16a)$$

$$R_1 + R_2 \leq \frac{1}{2} \log \left(1 + \frac{P_1}{N} \right). \quad (16b)$$

We do not provide a proof of the above proposition because the proof is similar to the converse proof given in Appendix B. The outer bound in Proposition 3 is better than the trivial outer bound in Proposition 2 obtained by giving the channel state to the decoder.

Finally, let us discuss the case of strong additive Gaussian channel state, i.e., $Q \rightarrow \infty$, with numerical examples. Figure 7 and Figure 8 illustrate the inner bound in Corollary 3 and the outer bound in Proposition 3 in two cases, $P_1 = 50$ ($P_1 \leq P_2 + N$) and $P_1 = 120$ ($P_1 > P_2 + N$), respectively, for $P_2 = 50$ and $N = 60$. In both cases, the uninformed encoder achieves positive rates from the actions of

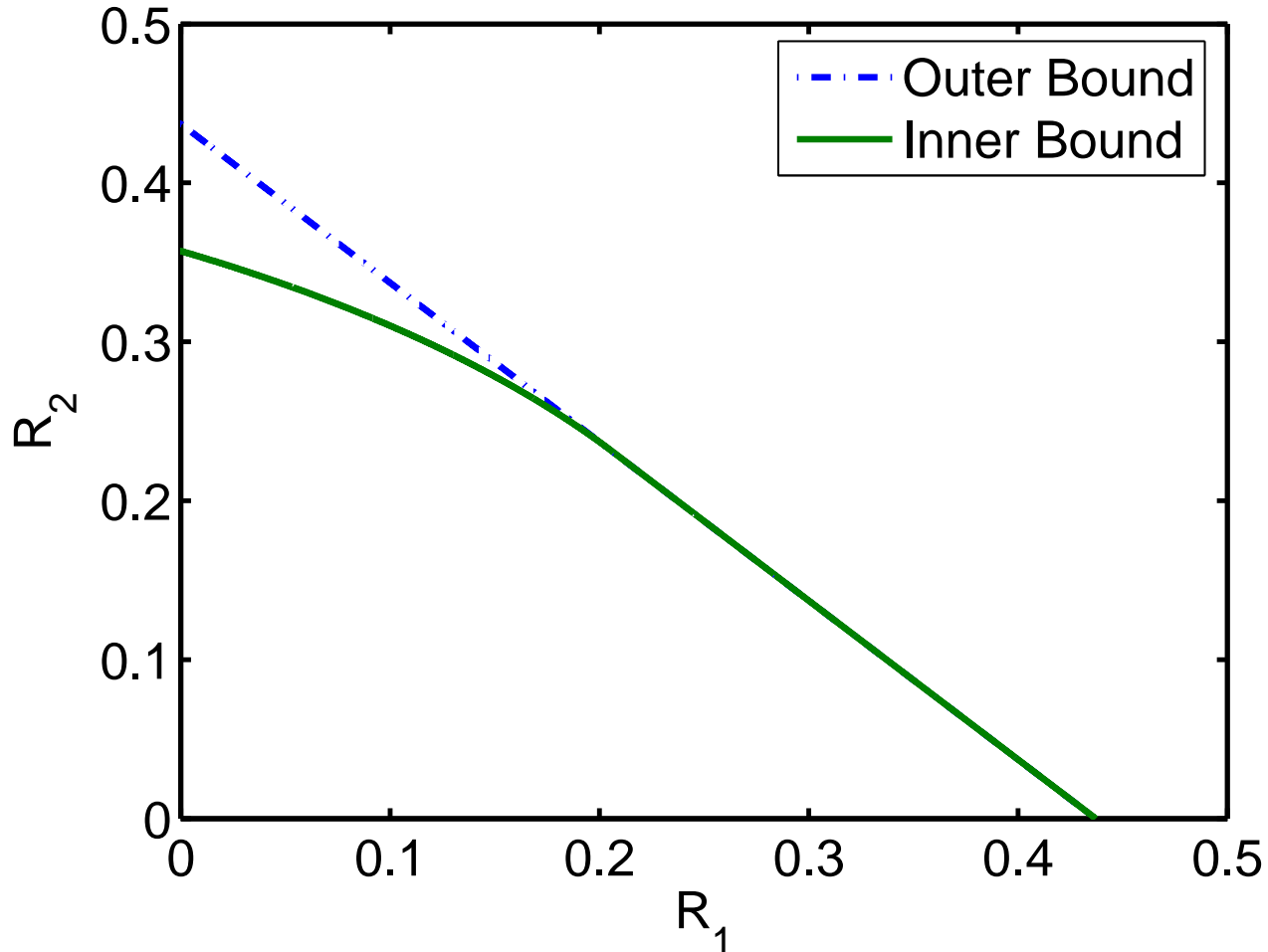

Fig. 7. The inner and outer bounds for the capacity region of the Gaussian MAC with one informed encoder in the strong additive Gaussian state case, i.e., $Q \rightarrow \infty$, for $P_1 = 50$ ($P_1 \leq P_2 + N$), $P_2 = 50$ and $N = 60$.

the informed encoder as discussed above. In the case of $P_1 = 120$ ($P_1 > P_2 + N$), the informed encoder can still achieve $\frac{1}{2} \log(1 + \frac{P_2}{N})$, though the additive channel state is very strong and is not known to the uninformed encoder, and the informed encoder has finite power.

As P_1 increases and $P_1 \geq P_2 + N$, in the strong additive Gaussian state case, the inner bound in Corollary 3 and the outer bound in Proposition 3 meet asymptotically. Thus, we obtain the capacity region for $P_1 \rightarrow \infty$ and $P_1 \geq P_2 + N$. For the very large values of P_1 , the outer bound given in Proposition 3 is achieved asymptotically with $\alpha = 1$. Figure 9 shows the inner bound in the strong additive state case which is also compared with the outer bound in Proposition 3 for the very large values of P_1 , i.e., $P_1 = 2000$.

V. CONCLUSIONS

In this paper, we considered a state-dependent MAC with state known to some, but not all, encoders. We derived an inner bound for the DM case and specialized to a noiseless binary case using generalized binary DPC. If the channel state is a Bernoulli(q) random variable with $q < 0.5$, we compared the inner bound in the binary case with a trivial outer bound obtained by providing the channel state to only the decoder. The inner bound obtained by generalized binary DPC does not meet the trivial outer bound for $q < 0.5$. For $q = 0.5$, we obtain the capacity region for binary noiseless case by deriving a non-trivial outer bound.

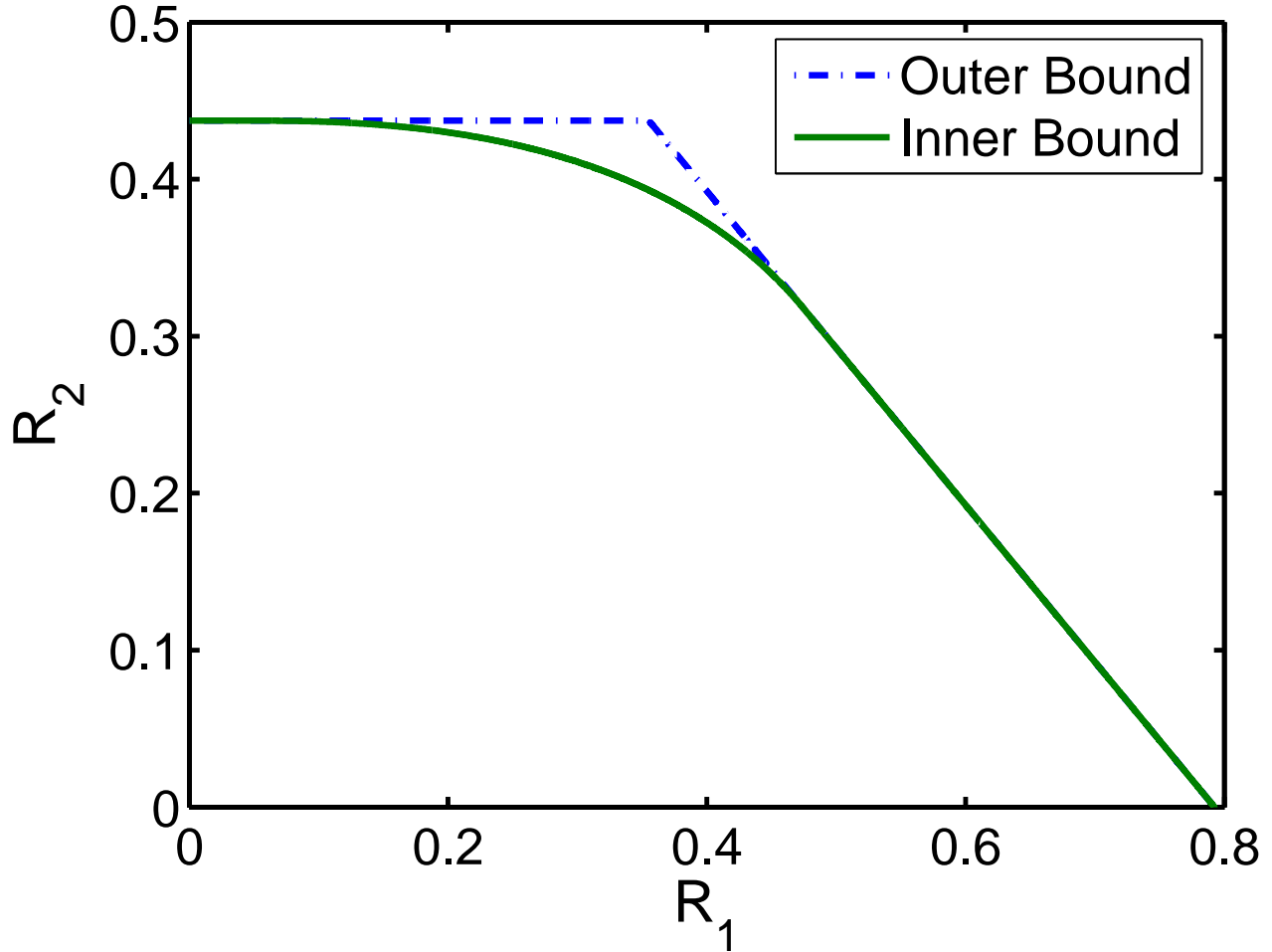

Fig. 8. The inner and outer bounds for the capacity region of the Gaussian MAC with one informed encoder in the strong additive Gaussian state case, i.e., $Q \rightarrow \infty$, for $P_1 = 120$ ($P_1 > P_2 + N$), $P_2 = 50$ and $N = 60$.

For the Gaussian case, we also derived an inner bound using GDPC and an outer bound by providing the channel state to the decoder also. It appears that the uninformed encoder benefits from GDPC because explicit state cancellation is present in GDPC. In the case of strong Gaussian state, i.e., the variance of state going to infinity, we also specialized the inner bound and analyzed how the uninformed encoder benefits from the auxiliary codewords of the informed encoder even in this case because explicit state cancellation is not helpful for this case. In the case of strong channel state, we also derived a non-trivial outer bound which is tighter than the trivial outer bound. These bounds asymptotically meet if $P_1 \rightarrow \infty$ and $P_1 \geq P_2 + N$. From results in the special cases of both the binary case and the Gaussian case, we note that the inner bounds meet the non-trivial outer bounds. From the results and observations in this paper, we would like to conclude that we are not able to show that random coding techniques and inner bounds in this paper achieve the capacity region due to lack of non-trivial outer bounds in all cases for this problem.

APPENDIX

We denote the set of jointly strongly typical sequences [31], [34] with distribution $p(x, y)$ as $T_\epsilon^n[X, Y]$. We define $T_\epsilon^n[X, Y|x^n]$ as the following

$$T_\epsilon^n[X, Y|x^n] = \{y^n : (x^n, y^n) \in T_\epsilon^n[X, Y]\}.$$

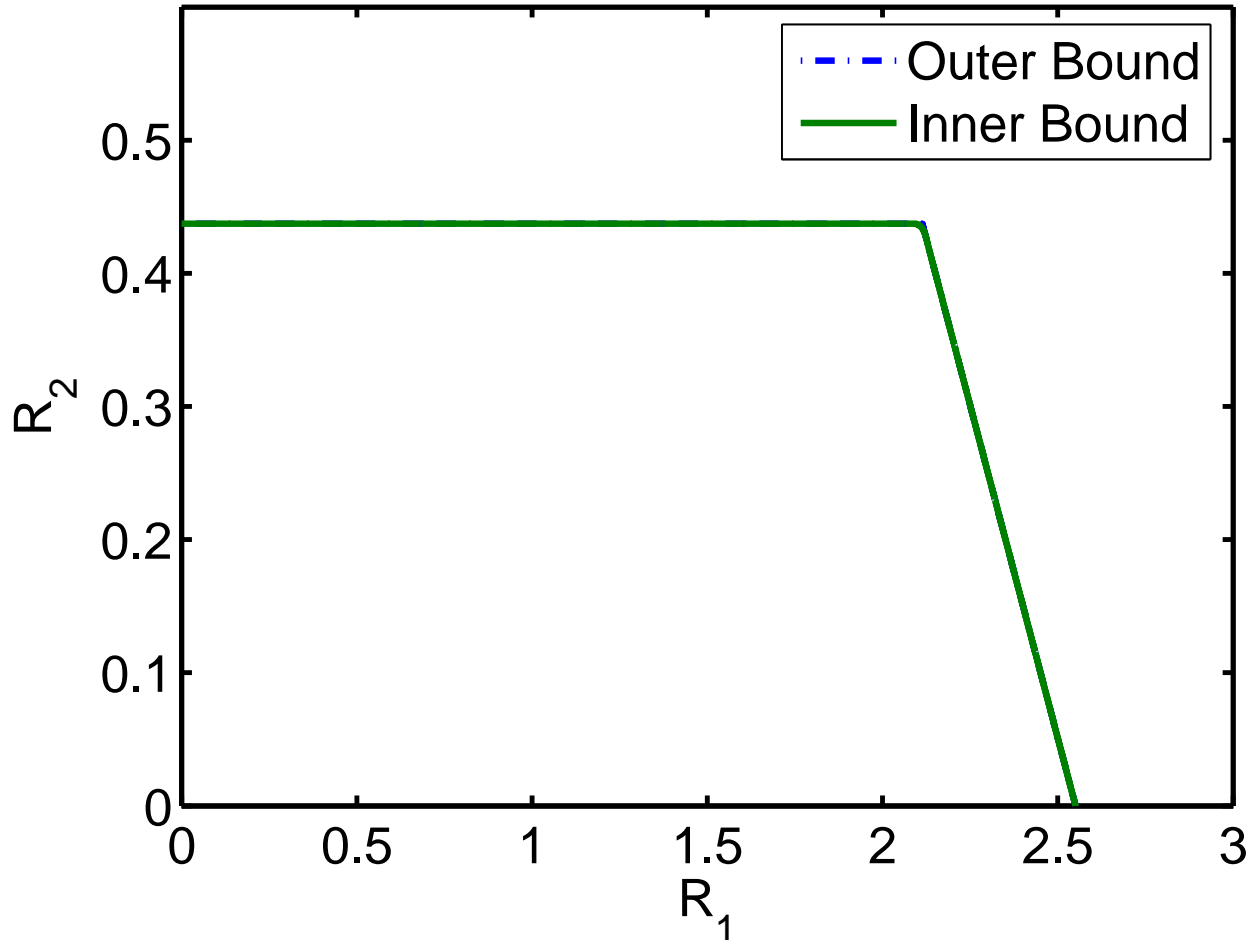

Fig. 9. The inner and outer bounds for the capacity region of the Gaussian MAC with one informed encoder in the strong additive Gaussian state case, i.e., $Q \rightarrow \infty$, for $P_1 = 2000, P_2 = 50$ and $N = 60$.

A. Proof of Theorem 1

In this section, we construct a sequence of codes $(\lceil 2^{nR_1} \rceil, \lceil 2^{nR_2} \rceil, n)$ with $P_e^n \rightarrow 0$ as $n \rightarrow \infty$ if (R_1, R_2) satisfies Equation (5). The random coding used in this section is a combination of Gel'fand-Pinsker coding [16] and coding for MAC [31]. This random coding is not a new technique but it is included for completeness. Fix $\epsilon > 0$ and take $(Q, S, \mathcal{U}_1, X_1, X_2, Y) \in \mathcal{P}^i$.

1) Encoding and Decoding:

- **Encoding:** The encoding strategy at the two encoders is as follows. Let $M_1 = 2^{n(R_1 - 4\epsilon)}$, $M_2 = 2^{n(R_2 - 2\epsilon)}$, and $J = 2^{n(\mathbb{I}(\mathcal{U}_1; S|Q) + 2\epsilon)}$. At the informed encoder, where the state is available, generate JM_1 sequences $\mathcal{U}_1^n(q^n, m_1, j)$, whose elements are drawn i.i.d. with $p(u_1|q)$, for each time sharing random sequence Q^n , where $1 \leq m_1 \leq M_1$, and $1 \leq j \leq J$. Here, m_1 indexes bins and j indexes sequences within a particular bin m_1 . For encoding, given state $S^n = s^n$, time sharing sequence $Q^n = q^n$ and message $W_1 \in \{1, 2, \dots, M_1\}$, look in bin W_1 for a sequence $\mathcal{U}_1^n(q^n, W_1, j)$, $1 \leq j \leq J$, such that $\mathcal{U}_1^n(q^n, W_1, j) \in T_\epsilon^n[Q, \mathcal{U}, S|q^n, s^n]$. Then the informed encoder generates X_1^n from $(\mathcal{U}_1^n, S^n, Q^n)$ according to probability law $\prod_{j=1}^n p(x_{1,j}|u_{1,j}, s_j, q_j)$.

At the uninformed encoder, sequences $X_2^n(q^n, m_2)$, whose elements are drawn i.i.d. with $p(x_2|q)$, are generated for each time sharing sequence $Q^n = q^n$, where $1 \leq m_2 \leq M_2$. The uninformed encoder chooses $X_2^n(q^n, W_2)$ to send the message $W_2 \in \{1, 2, \dots, M_2\}$ for a given time-sharing sequence $Q^n = q^n$ and sends the codeword X_2^n .

Given the inputs and the state, the decoder receives Y^n according to conditional probability distribution $\prod_i p(y_i | s_i, x_{1,i}, x_{2,i})$. It is assumed that the time-sharing sequence $Q^n = q^n$ is non-causally known to both the encoders and the decoder.

- **Decoding:** The decoder, upon receiving the sequence Y^n , chooses a pair $(U_1^n(q^n, m_1, j), X_2^n(m_2))$, $1 \leq m_1 \leq M_1$, $1 \leq j \leq J$, and $1 \leq m_2 \leq M_2$ such that $(U_1^n(q^n, m_1, j), X_2^n(q^n, m_2)) \in T_\epsilon^n[Q, U_1, X_2, Y | q^n, Y^n]$. If such a pair exists and is unique, the decoder declares that $(\hat{W}_1, \hat{W}_2) = (m_1, m_2)$. Otherwise, the decoder declares an error.

2) *Analysis of Probability of Error:* The average probability of error is given by

$$\begin{aligned} P_e^n &= \sum_{s^n \in \mathcal{S}^n, q^n \in \mathcal{Q}^n} p(s^n) p(q^n) \Pr[\text{error} | s^n, q^n] \\ &\leq \sum_{s^n \notin T_\epsilon^n[\mathcal{S}]} p(s^n) + \sum_{q^n \notin T_\epsilon^n[\mathcal{Q}]} p(q^n) \\ &\quad + \sum_{s^n \in T_\epsilon^n[\mathcal{S}], q^n \in T_\epsilon^n[\mathcal{Q}]} p(q^n) \Pr[\text{error} | s^n, q^n]. \end{aligned} \quad (17)$$

The first term, $\Pr[s^n \notin T_\epsilon^n[\mathcal{S}]]$, and the second term, $\Pr[q^n \notin T_\epsilon^n[\mathcal{Q}]]$, in the right hand side expression of (17) go to zero as $n \rightarrow \infty$ by the strong asymptotic equipartition property (AEP) [31].

Without loss of generality, we can assume that $(W_1, W_2) = (1, 1)$ is sent, time sharing sequence is $Q^n = q^n$, and state realization is $S^n = s^n$. The probability of error is given by the conditional probability of error given $(W_1, W_2) = (1, 1)$, $Q^n = q^n \in T_\epsilon^n[\mathcal{Q}]$, and $S^n = s^n \in T_\epsilon^n[\mathcal{S}]$.

- Let E_1 be the event that there is no sequence $U_1^n(q^n, W_1, j)$ such that $U_1^n(q^n, 1, j) \in T_\epsilon^n[Q, U_1, S | q^n, s^n]$. For any $U_1^n(q^n, 1, j)$ and $S^n = s^n$ generated independently according to $\prod p(u_{1i} | q_i)$ and $\prod p(s_i)$, respectively, the probability that there exists at least one j such that $U_1^n(q^n, 1, j) \in T_\epsilon^n[Q, U, S | q^n, s^n]$ is greater than $(1 - \epsilon)2^{-n(\mathbb{I}(U_1; S | Q) + \epsilon)}$ for n sufficiently large. There are J number of such U_1^n 's in each bin. The probability of event E_1 , the probability that there is no U_1^n for a given s^n in a particular bin, is therefore bounded by

$$\Pr[E_1] \leq [1 - (1 - \epsilon)2^{-n(\mathbb{I}(U_1; S | Q) + \epsilon)}]^{2^{n(\mathbb{I}(U_1; S | Q) + 2\epsilon)}}. \quad (18)$$

Taking the natural logarithm on both sides of (18), we obtain

$$\begin{aligned} \ln(\Pr[E_1]) &\leq 2^{n(\mathbb{I}(U_1; S | Q) + 2\epsilon)} \ln[1 - (1 - \epsilon)2^{-n(\mathbb{I}(U_1; S | Q) + \epsilon)}] \\ &\stackrel{(a)}{\leq} -2^{n(\mathbb{I}(U_1; S | Q) + 2\epsilon)} (1 - \epsilon)2^{-n(\mathbb{I}(U_1; S | Q) + \epsilon)} \\ &= -(1 - \epsilon)2^{n\epsilon}, \end{aligned} \quad (19)$$

where (a) follows from the inequality $\ln(q) \leq (q - 1)$. From (19), $\Pr[E_1] \rightarrow 0$ as $n \rightarrow \infty$.

Under the event E_1^c , we can also assume that a particular sequence $U_1^n(q^n, 1, 1)$ in bin 1 is jointly strongly typical with $S^n = s^n$. Thus, codewords X_1^n corresponding to the pair $(U_1^n(q^n, 1, 1), s^n)$ and X_2^n corresponding to $X_2^n(q^n, 1)$ are sent from the informed and the uninformed encoders, respectively.

- Let E_2 be the event that

$$(U_1^n(q^n, 1, 1), X_2^n(q^n, 1), Y^n) \notin T_\epsilon^n[Q, U_1, X_2, Y | q^n].$$

The Markov lemma [31] ensures jointly strong typicality of $(q^n, s^n, U_1^n(q^n, 1, 1), X_2^n(q^n, 1), Y^n)$ with high probability if $(q^n, s^n, U_1^n(q^n, 1, 1), X_1^n)$ is jointly strongly typical and $(q^n, X_2^n(1))$ is jointly strongly typical. We can conclude that $\Pr[E_2 | E_1^c] \rightarrow 0$ as $n \rightarrow \infty$.

- Let E_3 be the event that

$$U_1^n(q^n, m_1, j) \in T_\epsilon^n[Q, U_1, X_2, Y | q^n, Y^n, X_2^n(q^n, 1)].$$

The probability that $\mathbf{U}_1^n(q^n, m_1, j) \in T_\epsilon^n[\mathbf{Q}, \mathbf{U}_1, \mathbf{X}_2, \mathbf{Y} | q^n, \mathbf{Y}^n, \mathbf{X}_2^n(q^n, 1)]$ for $(m_1 = 1$ and $j \neq 1)$, or $(m_1 \neq 1$ and $1 \leq j \leq J)$, is less than $2^{-n(\mathbb{I}(\mathbf{U}_1; \mathbf{Y} | \mathbf{X}_2, \mathbf{Q}) - \epsilon)}$ for sufficiently large n . There are approximately JM_1 (exactly $JM_1 - 1$) such \mathbf{U}_1^n sequences in the codebook. Thus, the conditional probability of event E_3 given E_1^c and E_2^c is upper bounded by

$$\Pr[E_3 | E_1^c, E_2^c] \leq 2^{-n(\mathbb{I}(\mathbf{U}_1; \mathbf{Y} | \mathbf{X}_2, \mathbf{Q}) - \mathbb{I}(\mathbf{U}_1; \mathbf{S} | \mathbf{Q}) - R_1 + \epsilon)}. \quad (20)$$

From (20), $\Pr[E_3 | E_1^c, E_2^c] \rightarrow 0$ as $n \rightarrow \infty$ if $R_1 < \mathbb{I}(\mathbf{U}_1; \mathbf{Y} | \mathbf{X}_2, \mathbf{Q}) - \mathbb{I}(\mathbf{U}_1; \mathbf{S} | \mathbf{Q})$ and $\epsilon > 0$.

- Let E_4 be the event that

$$\mathbf{X}_2^n(q^n, m_2) \in T_\epsilon^n[\mathbf{Q}, \mathbf{U}_1, \mathbf{X}_2, \mathbf{Y} | q^n, \mathbf{Y}^n, \mathbf{U}_1^n(q^n, 1, 1)]$$

for $m_2 \neq 1$. The probability that $\mathbf{X}_2^n(q^n, m_2) \in T_\epsilon^n[\mathbf{Q}, \mathbf{U}_1, \mathbf{X}_2, \mathbf{Y} | q^n, \mathbf{Y}^n, \mathbf{U}_1^n(q^n, 1, 1)]$ for $m_2 \neq 1$ is less than $2^{-n(\mathbb{I}(\mathbf{X}_2; \mathbf{Y} | \mathbf{U}_1, \mathbf{Q}) - \epsilon)}$ for sufficiently large n . There are approximately $M_2 = 2^{n(R_2 - 2\epsilon)}$ such \mathbf{X}_2^n sequences in the codebook. Thus, the conditional probability of event E_4 given E_1^c and E_2^c is upper bounded by

$$\Pr[E_4 | E_1^c, E_2^c] \leq 2^{-n(\mathbb{I}(\mathbf{X}_2; \mathbf{Y} | \mathbf{U}_1, \mathbf{Q}) - R_2 + \epsilon)}. \quad (21)$$

From (21), $\Pr[E_4 | E_1^c, E_2^c] \rightarrow 0$ as $n \rightarrow \infty$ if $R_2 < \mathbb{I}(\mathbf{X}_2; \mathbf{Y} | \mathbf{U}_1, \mathbf{Q})$.

- Finally, let E_5 be the event that

$$(\mathbf{U}_1^n(q^n, m_1, j), \mathbf{X}_2^n(q^n, m_2)) \in T_\epsilon^n[\mathbf{Q}, \mathbf{U}_1, \mathbf{X}_2, \mathbf{Y} | q^n, \mathbf{Y}^n]$$

for $((m_1 = 1$ and $j \neq 1)$, or $(m_1 \neq 1$ and $1 \leq j \leq J))$, and $m_2 \neq 1$. The probability that $(\mathbf{U}_1^n(q^n, m_1, j), \mathbf{X}_2^n(q^n, m_2)) \in T_\epsilon^n[\mathbf{Q}, \mathbf{U}_1, \mathbf{X}_2, \mathbf{Y} | q^n, \mathbf{Y}^n]$ for $m_1 \neq 1$, $1 \leq j \leq J$, and $m_2 \neq 1$ is less than $2^{-n(\mathbb{I}(\mathbf{U}_1, \mathbf{X}_2; \mathbf{Y} | \mathbf{Q}) - \epsilon)}$, for sufficiently large n . There are approximately JM_1 sequences \mathbf{U}_1^n and M_2 sequences \mathbf{X}_2^n in the codebook. Thus, the conditional probability of event E_5 given E_1^c and E_2^c is upper bounded by

$$\Pr[E_5 | E_1^c, E_2^c] \leq 2^{-n(\mathbb{I}(\mathbf{U}_1, \mathbf{X}_2; \mathbf{Y} | \mathbf{Q}) - \mathbb{I}(\mathbf{U}_1; \mathbf{S} | \mathbf{Q}) - (R_1 + R_2) + 3\epsilon)}. \quad (22)$$

From (22), the $\Pr[E_5 | E_1^c, E_2^c] \rightarrow 0$ as $n \rightarrow \infty$ if $R_1 + R_2 < \mathbb{I}(\mathbf{U}_1, \mathbf{X}_2; \mathbf{Y} | \mathbf{Q}) - \mathbb{I}(\mathbf{U}_1; \mathbf{S} | \mathbf{Q})$.

In terms of these events, $\Pr[\text{error} | s^n, q^n]$ in (17) can be upper-bounded via the union bound, and the fact that probabilities are less than one, as

$$\begin{aligned} \Pr[\text{error} | s^n, q^n] &\leq \Pr[E_1] + \Pr[E_2 | E_1^c] + \Pr[E_3 | E_1^c, E_2^c] \\ &\quad + \Pr[E_4 | E_1^c, E_2^c] + \Pr[E_5 | E_1^c, E_2^c]. \end{aligned} \quad (23)$$

From (23), it can be easily seen that $\Pr[\text{error} | s^n, q^n] \rightarrow 0$ as $n \rightarrow \infty$. Therefore, the probability of error P_e^n goes to zero as $n \rightarrow \infty$ from (17) and completes the proof.

B. Converse for the Capacity Region in Corollary 2

In this section, we show that (R_1, R_2) satisfies (8) for any given sequence of binary codes $(\lceil 2^{nR_1} \rceil, \lceil 2^{nR_2} \rceil, n)$ for the noiseless binary state-dependent MAC with $q = 0.5$ and one informed encoder satisfying $\lim_{n \rightarrow \infty} P_e^n = 0$.

Let us first bound the rate of the uninformed encoder as follows.

$$\begin{aligned} nR_2 &\leq \mathbb{H}(\mathbf{W}_2) \\ &= \mathbb{H}(\mathbf{W}_2 | \mathbf{W}_1, \mathbf{S}^n) \\ &\stackrel{(a)}{\leq} \mathbb{I}(\mathbf{W}_2; \mathbf{Y}^n | \mathbf{W}_1, \mathbf{S}^n) + n\epsilon_n \\ &\stackrel{(b)}{\leq} \sum_{j=1}^n \mathbb{I}(\mathbf{X}_{2,j}; \mathbf{Y}_j | \mathbf{X}_{1,j}, \mathbf{S}_j) + n\epsilon_n \end{aligned}$$

$$\begin{aligned}
&= \sum_{j=1}^n \mathbb{H}(X_{2,j}) + n\epsilon_n \\
&\stackrel{(c)}{=} \sum_{j=1}^n \mathbb{H}_b(p_{2,j}) + n\epsilon_n \\
&\stackrel{(d)}{\leq} n\mathbb{H}_b\left(\frac{1}{n} \sum_{j=1}^n p_{2,j}\right) + n\epsilon_n \\
&\stackrel{(e)}{\leq} n\mathbb{H}_b(p_2) + n\epsilon_n,
\end{aligned} \tag{24}$$

where:

(a) follows from Fano's inequality and $\epsilon_n \rightarrow 0$ as $P_e^n \rightarrow 0$,

(b) follows from the fact that X_1^n and X_2^n are deterministic functions of (W_1, S^n) and (W_2) , respectively, the memoryless property of the channel, and $\mathbb{H}(Y_j|X_1^n, S^n, W_1) \leq \mathbb{H}(Y_j|X_{1,j}, S_j)$,

(c) follows from the fact that $X_{2,j}$ is a Bernoulli($p_{2,j}$) satisfying $\frac{1}{n} \sum_{j=1}^n p_{2,j} \leq p_2$,

(d) follows from the fact that the binary entropy function is a concave function,

(e) follows from the fact that the binary entropy function is a monotone increasing function in the interval between 0 and 0.5, and $\frac{1}{n} \sum_{j=1}^n p_{2,j} \leq p_2 \leq 0.5$.

Let us bound $R_1 + R_2$ as follows.

$$\begin{aligned}
n(R_1 + R_2) &\leq \mathbb{H}(W_1, W_2) \\
&\stackrel{(a)}{=} \mathbb{I}(W_1, W_2; Y^n) + n\epsilon_n \\
&= \mathbb{H}(Y^n) - \mathbb{H}(Y^n|W_1, W_2, S^n) \\
&\quad + \mathbb{H}(Y^n|W_1, W_2, S^n) - \mathbb{H}(Y^n|W_1, W_2) + n\epsilon_n \\
&= \mathbb{I}(W_1, W_2, S^n; Y^n) - \mathbb{I}(S^n; Y^n|W_1, W_2) + n\epsilon_n \\
&\stackrel{(b)}{=} \mathbb{I}(X_1^n, X_2^n, S^n; Y^n) - \mathbb{I}(S^n; Y^n|W_1, W_2, X_2^n) + n\epsilon_n \\
&= \sum_{j=1}^n [\mathbb{H}(Y_j|Y^{j-1}) - \mathbb{H}(Y_j|Y^{j-1}, X_1^n, X_2^n, S^n) \\
&\quad - \mathbb{H}(S_j|W_1, W_2, X_2^n, S^{j-1}) \\
&\quad + \mathbb{H}(S_j|W_1, W_2, X_2^n, S^{j-1}, Y^n)] + n\epsilon_n \\
&\stackrel{(c)}{\leq} \sum_{j=1}^n [\mathbb{H}(Y_j) - \mathbb{H}(Y_j|X_{1,j}, X_{2,j}, S_j) \\
&\quad - \mathbb{H}(S_j) + \mathbb{H}(S_j|X_{2,j}, Y_j)] + n\epsilon_n \\
&= \sum_{j=1}^n [\mathbb{I}(X_{1,j}, X_{2,j}, S_j; Y_j) - \mathbb{I}(X_{2,j}, Y_j; S_j)] + n\epsilon_n \\
&\stackrel{(d)}{=} \sum_{j=1}^n [\mathbb{I}(X_{2,j}; Y_j) + \mathbb{I}(S_j; Y_j|X_{2,j}) \\
&\quad + \mathbb{I}(X_{1,j}; Y_j|X_{2,j}, S_j) - \mathbb{I}(S_j; Y_j|X_{2,j})] + n\epsilon_n \\
&= \sum_{j=1}^n [\mathbb{I}(X_{2,j}; Y_j) + \mathbb{I}(X_{1,j}; Y_j|X_{2,j}, S_j)] + n\epsilon_n \\
&\stackrel{(e)}{=} \sum_{j=1}^n [\mathbb{I}(X_{2,j}; Y_j) + \mathbb{H}(X_{1,j}|S_j)] + n\epsilon_n
\end{aligned}$$

$$\begin{aligned}
& \stackrel{(f)}{=} \sum_{j=1}^n [\mathbb{H}_b(p_{2,j} * (0.5(a_{10,j} + a_{01,j}))) \\
& \quad - \mathbb{H}_b(0.5(a_{10,j} + a_{01,j})) \\
& \quad + 0.5\mathbb{H}_b(a_{10,j}) + 0.5\mathbb{H}_b(a_{01,j})] + n\epsilon_n \\
& \stackrel{(g)}{\leq} \sum_{j=1}^n \mathbb{H}_b(p_{1,j}) + n\epsilon_n \\
& \stackrel{(h)}{\leq} n\mathbb{H}_b\left(\frac{1}{n} \sum_{j=1}^n p_{1,j}\right) + n\epsilon_n \\
& \stackrel{(i)}{\leq} n\mathbb{H}_b(p_1) + n\epsilon_n, \tag{25}
\end{aligned}$$

where:

- (a) follows from Fano's inequality and $\epsilon_n \rightarrow 0$ as $P_e^n \rightarrow 0$,
(b) follows from the fact that X_1^n and X_2^n are deterministic functions of (W_1, S^n) and W_2 , respectively, and the memoryless property of the channel
(c) follows from the fact that $\mathbb{H}(Y_j|Y^{j-1}) \leq \mathbb{H}(Y_j)$, $\mathbb{H}(Y_j|Y^{j-1}, X_1^n, X_2^n, S^n) = \mathbb{H}(Y_j|X_{1,j}, X_{2,j}, S_j)$, $\mathbb{H}(S_j|W_1, W_2, X_2^n) = \mathbb{H}(S_j)$, and $\mathbb{H}(S_j|W_1, W_2, X_2^n, Y^n) \leq \mathbb{H}(S_j|X_{2,j}, Y_j)$,
(d) follows from the fact that $\mathbb{I}(S_j; X_{2,j}) = 0$,
(e) follows from the fact that $\mathbb{H}(Y_j|X_{2,j}, S_j) = \mathbb{H}(X_{1,j}|S_j)$ and $\mathbb{H}(Y_j|X_{1,j}, X_{2,j}, S_j) = 0$,
(f) follows from the fact that the $X_{2,j}$ is a Bernoulli($p_{2,j}$) random variable with $\sum_{j=1}^n p_{2,j} \leq np_2$; and $X_{1,j}$ is correlated to S_j with $a_{10,j} = \Pr(X_{1,j} = 1|S_j = 0)$ and $a_{01,j} = \Pr(X_{1,j} = 0|S_j = 1)$ satisfying

$$\begin{aligned}
\Pr(X_{1,j} = 1) &= p_{1,j} = \Pr(S_j = 1)\Pr(X_{1,j} = 1|S_j = 1) \\
&\quad + \Pr(S_j = 0)\Pr(X_{1,j} = 1|S_j = 0) \\
&= 0.5(a_{10,j} + (1 - a_{01,j})),
\end{aligned}$$

(g) follows from the fact that the term $[\mathbb{H}_b(p_{2,j} * (0.5(a_{10,j} + a_{01,j}))) - \mathbb{H}_b(0.5(a_{10,j} + a_{01,j})) + 0.5\mathbb{H}_b(a_{10,j}) + 0.5\mathbb{H}_b(a_{01,j})]$ is maximized under the constraint $0.5(a_{10,j} + (1 - a_{01,j})) = p_{1,j}$ for values $a_{10,j} = p_{1,j}$ and $a_{01,j} = 1 - p_{1,j}$, and the maximum value of the term $[\mathbb{H}_b(p_{2,j} * (0.5(a_{10,j} + a_{01,j}))) - \mathbb{H}_b(0.5(a_{10,j} + a_{01,j})) + 0.5\mathbb{H}_b(a_{10,j}) + 0.5\mathbb{H}_b(a_{01,j})]$ is $\mathbb{H}(p_{1,j})$

(h) follows from the concavity property of the binary entropy function,

(i) follows from the fact that the binary entropy function is a monotone increasing function in the interval between 0 and 0.5, and $\frac{1}{n} \sum_{j=1}^n p_{1,j} \leq p_1 \leq 0.5$.

From (24) and (25), we can conclude that the rate pair (R_1, R_2) satisfies (8) by letting n go to ∞ .

REFERENCES

- [1] M. D. Swanson, M. Kobayashi, and A. H. Tewfik, "Multimedia Data-Embedding and Watermarking Technologies," in *Proc. IEEE Int. Conf. Communications (ICC)*, vol. 2, 1998, pp. 823–827.
- [2] B. Chen, "Design and Analysis of Digital Watermarking, Information Embedding, and Data Hiding Systems," Ph.D. dissertation, Massachusetts Institute of Technology, Cambridge, MA, 2000.
- [3] B. Chen and G. W. Wornell, "Quantization Index Modulation: A Class of Provably Good Methods for Digital Watermarking and Information Embedding," *IEEE Trans. Inform. Theory*, vol. 47, no. 4, pp. 1423–1443, May 2001.
- [4] P. Moulin and J. O'Sullivan, "Information-theoretic Analysis of Information Hiding," *IEEE Trans. Inform. Theory*, vol. 49, pp. 563–593, 2003.
- [5] A. S. Cohen, "The Gaussian Watermarking Game," *IEEE Trans. Inform. Theory*, vol. vol.48, pp. 1639–1669, June 2002.
- [6] G. Caire and S. S. (Shitz), "On achievable throughput of a multi-antenna Gaussian broadcast channel," *IEEE Trans. Inform. Theory*, vol. 49, no. 7, pp. 1691–1706, July 2003.
- [7] T. Kalker and F. Willems, "Capacity Bounds and Constructions for Reversible Data-hiding," in *Proc. Int. Conf. Digital Signal Processing*, 2002, pp. 71–76.
- [8] J. Mitola, "Cognitive Radio: an Integrated Agent Architecture for Software Defined Radio," Ph.D. dissertation, Royal Institute of Technology, Stockholm, Sweden, 2000.

- [9] N. Devroye, P. Mitran, and V. Tarokh, "Achievable Rates in Cognitive Channels," *IEEE Trans. Inform. Theory*, vol. 52, pp. 1813–1827, May 2006.
- [10] A. Jovicic and P. Viswanath, "Cognitive Radio: An Information-Theoretic Perspective," submitted to *IEEE Trans. on Information Theory*.
- [11] C. E. Shannon, "Channels with Side Information at the transmitter," *IBM J. Res. Devel.*, vol. vol.2, pp. 289–293, 1958.
- [12] M. Salehi, "Capacity and coding for memories with real-time noisy defect information at encoder and decoder," *Proc. Inst. Elec. Eng.-Pt.I.*, vol. vol.139, pp. 113–117, April 1992.
- [13] G. Caire and S. Shamai, "On the Capacity of Some Channels with Channel State Information," *IEEE Trans. Inform. Theory*, vol. 45, September 1999.
- [14] A. V. Kusnetsov and B. S. Tsybakov, "Coding in a Memory with Defective Cells," *Probl. Peredach. Inform.*, vol. vol.10, no. 2, pp. 52–60, April/June 1974.
- [15] C. Heegard and A. E. Gamal, "On the Capacities of Computer Memories with Defects," *IEEE Trans. Inform. Theory*, vol. vol.IT-29, pp. 731–739, September 1983.
- [16] S. I. Gel'fand and M. S. Pinsker, "Coding for Channel with Random Parameters," *Probl. Contr. and Information Theory*, vol. 9, no. 1, pp. pp.19–31, 1980.
- [17] T. Cover and M. Chiang, "Duality Between Channel Capacity and Rate Distortion with Two-sided State Information," *IEEE Trans. Inform. Theory*, vol. 48, pp. 1629–1638, June 2002.
- [18] M. H. M. Costa, "Writing on Dirty Paper," *IEEE Trans. Inform. Theory*, vol. vol.IT-29, pp. 439–441, May 1983.
- [19] S. I. Gel'fand and M. S. Pinsker, "On Gaussian Channels with Random Parameters," in *Proc. IEEE Int. Symp. Information Theory (ISIT)*, 1983.
- [20] Y. H. Kim, A. Sutivong, and S. Sigurjónsson, "Multiple User Writing on Dirty Paper," in *Proc. IEEE Int. Symp. Information Theory (ISIT)*, June 27 - July 2 2004.
- [21] A. Somekh-Baruch, S. Shamai, and S. Verdú, "Cooperative Encoding with Asymmetric State Information at the Transmitters," in *Proc. Allerton Conf. Communications, Control, and Computing*, 2006.
- [22] —, "Cooperative Multiple Access Encoding with States Available at One Transmitter," in *Proc. IEEE Int. Symp. Information Theory (ISIT)*, June 24 - June 29 2007.
- [23] S. Kotagiri and J. N. Laneman, "Multiaccess Channels with State Known to One Encoder: A Case of Degraded Message Sets," in *Proc. IEEE Int. Symp. Information Theory (ISIT)*, June 24 - June 29 2007.
- [24] A. Somekh-Baruch, S. S. (Shitz), and S. Verdú, "Cooperative Multiple Access Encoding with States Available at One Transmitter," submitted to *Tran. Info. Theory*, 2007.
- [25] T. Philosof, A. Khisti, U. Erez, and R. Zamir, "Lattice Strategies for the Dirty Multiple Access Channel," in *Proc. IEEE Int. Symp. Information Theory (ISIT)*, June 24 - June 29 2007.
- [26] Y. CemaI and Y. Steinberg, "Multiple Access Channel with Partial State Information at the Encoders," *IEEE Trans. Inform. Theory*, vol. vol.IT-51, pp. 3992–4003, November 2005.
- [27] Y. Steinberg and S. Shamai, "Achievable Rates for the Broadcast Channel with States Known at the Transmitter," in *Proc. IEEE Int. Symp. Information Theory (ISIT)*, September 4 – September 9 2005.
- [28] Y. Steinberg, "Coding for the Degraded Broadcast Channel with Random parameters, with Causal and Noncausal Side Information," *IEEE Trans. Inform. Theory*, vol. vol.51, pp. 2867–2877, August 2005.
- [29] A. Khisti, U. Erez, and G. W. Wornell, "Writing on Many Pieces of Dirty Paper at Once: The Binary Case," in *Proc. IEEE Int. Symp. Information Theory (ISIT)*, June 27 – July 2 2004.
- [30] S. P. Kotagiri, "State-Dependent Networks with Side Information and Partial State Recovery ," Ph.D. dissertation, University of Notre Dame, Notre Dame, IN, Dec. 2007.
- [31] T. M. Cover and J. A. Thomas, *Elements of Information Theory*. New York: John Wiley & Sons, Inc., 1991.
- [32] R. Zamir, S. Shamai, and U. Erez, "Nested Linear/Lattice Codes for Structured Multiterminal Binning," *IEEE Trans. Inform. Theory*, vol. vol.IT-48, pp. 1250–1276, June 2002.
- [33] R. G. Gallager, *Information Theory Reliable Communication*. New York: Wiley, 1968.
- [34] I. Csiszár and J. Körner, Eds., *Information Theory: Coding Theorems for Discrete Memoryless Systems*. New York: Academic Press Inc., 1981.