

Is the gravitational action additive?

Dieter Brill*

Department of Physics, University of Maryland,
College Park, MD 20742

and

Geoff Hayward†

Institute of Theoretical Physics,
412 Avadh Bhatia Physics Laboratory, University of Alberta,
Edmonton, AB, Canada T6G 2J1

PACS: 04.20.Cv, 04.60-m

Abstract

The gravitational action is not always additive in the usual sense. We provide a general prescription for the change in action that results when different portions of the boundary of a spacetime are topologically identified. We discuss possible implications for the superposition law of quantum gravity. We present a definition of ‘generalized additivity’ which does hold for arbitrary spacetime composition.

*e-mail: brill@umdhep.umd.edu

†e-mail: hayward@phys.ualberta.ca

1 Introduction

It is widely believed that, when a spacetime is cut up into several parts, the actions for the parts, considered separately, sum up to yield the action for the spacetime taken as a whole. In fact, Hawking has argued [1] that additivity of the action in this sense is actually *necessary* in order to obtain the appropriate superposition behavior for quantum gravitational propagation amplitudes. Viewed from a broader perspective, this form of additivity would require that the action for a spacetime (which need not be connected) be invariant under topological identifications of isometric surfaces on its boundary.

Yet, as has been pointed out by Hartle and Sorkin in the context of Euclidean Regge calculus [2], the gravitational action is not always additive in this sense. Here we consider the context of continuum general relativity and provide a general prescription for the ‘residue’; that is, a prescription for the change in action that results when one topologically identifies isometric surfaces on the boundary of a spacetime. We then argue that in order to maintain ‘additivity’, we must broaden this concept to allow for a finite action associated with certain identification surfaces themselves. In this broader sense, the action is always additive.

In this paper we establish that there is a sense in which the action is additive and a sense in which it is not. It is therefore useful to adopt appropriate terminology at the outset. If the action is additive in the usual sense (e.g. the sense used both by Hawking and by Hartle and Sorkin) we will call it ‘invariant under identification of boundary surfaces’ or, equivalently, ‘invariant under spacetime composition’. In Section 4, we will define a broader sense of additivity, which we refer to as ‘generalized additivity’.

Let us now consider the gravitational action for a spacetime $\{g^{ab}, \mathcal{M}\}$ with a boundary $\{h^{ab}, B\}$, of fixed intrinsic geometry. When the unit normal varies continuously over the boundary, the action is given by [3, 4],

$$I = \frac{1}{16\pi} \int_{\mathcal{M}} (R - 2\Lambda) (-g)^{1/2} d^4x - \varepsilon \frac{1}{8\pi} \int_B K(\varepsilon h)^{1/2} d^3x + C, \quad (1)$$

where $\varepsilon = +1$ ($= -1$) when the boundary is spacelike (timelike), where K_{ab} is the extrinsic curvature of the boundary, and where C is some undetermined functional of the boundary’s intrinsic geometry.

When the boundary includes sharp 2-dimensional ‘edges’ or ‘joints’ (i.e. 2-surfaces at which the unit normal changes direction discontinuously) there are additional corrections to (1) [5, 6, 2, 7]. The effect of the joint’s extrinsic geometry is simply a finite additive contribution to the action. This contri-

bution depends on whether the joint is spacelike, timelike, or null (i.e. on whether the square of its area form is positive, negative, or zero). A timelike joint contributes to the action

$$\frac{1}{8\pi} \int \Theta (-\sigma)^{1/2} d^2x + \mathcal{C}[\sigma_{ab}] \quad (2)$$

where Θ is the angle between the outward pointing boundary normals on either side of the 2-surface¹, σ_{ab} is the intrinsic two-metric of the 2-surface, and \mathcal{C} is an arbitrary functional of σ_{ab} . Spacelike joints contribute to the action,

$$\frac{1}{8\pi} \int \eta (\sigma)^{1/2} d^2x + \mathcal{C}[\sigma_{ab}] \quad (3)$$

where η is the local boost parameter. Null joints make no contribution to the action (except possibly through \mathcal{C}), essentially because their 2-volume vanishes.

Now consider the following general procedure by which a spacetime can be topologically reconfigured. Let $\{g^{ab}, \mathcal{M}\}$ be a spacetime (not necessarily connected) with boundary $\{h^{ab}, B\}$ (Figure 1). Construct from this spacetime a new spacetime, $\{g^{ab}, \widetilde{\mathcal{M}}\}$ with boundary $\{h^{ab}, \widetilde{B}\}$, by identifying topologically similar surfaces S_1 and S_2 on B to form a single surface S . Assume that

¹Here Θ is considered positive if these normals are diverging, and negative if they are converging. A similar convention determines the sign of η of equation (3) below.

the surfaces to be identified are isometric, but allow for a jump in extrinsic curvature between them. Let \widehat{S} be the closure of S and let S_{int} be the interior of S . Define $\bar{S} \equiv S - S_{\text{int}}$ to be the portion of the boundary of S that is included in S . Similarly, define $\bar{S}^* \equiv \widehat{S} - S$ to be the portion of the boundary of S that is not included in S .

The behavior of the action (1) under spacetime composition depends critically on the 2-surfaces \bar{S} and \bar{S}^* . (If these vanish, then the action is invariant under the composition.) In general, these 2-surfaces may include portions that are timelike, spacelike, or null. Since null joints do not contribute to the action, only the timelike and spacelike portions of \bar{S} and \bar{S}^* could conceivably contribute to a change in the action when S_1 and S_2 are topologically identified.

2 Identifying surfaces with timelike boundary

For simplicity, first focus on the case in which the boundary of the identification surface S is entirely timelike, in which $S = \widehat{S}$ (so $\bar{S}^* = 0$), and in which the ‘outer sides’ of S_1 and S_2 are identified (see Figure 2(a)).

Now compare the total action before (I) and after (\tilde{I}) we identify S_1

and S_2 . After identification, a jump discontinuity in the extrinsic curvature across S_{int} contributes

$$\frac{\varepsilon}{8\pi} \int_{S_{\text{int}}} K|_{-}^{+} (\varepsilon h)^{1/2} d^3x \quad (4)$$

to the action, which is the same as the contribution due to S_1 and S_2 before identification (because extrinsic curvature contributions along S_{int} for S_1 and S_2 are defined with respect to oppositely oriented unit normals). Thus we find

$$I - \tilde{I} = \frac{1}{8\pi} \int_{\bar{S}} (\Theta_1 + \Theta_2 - \Theta) (-\sigma)^{1/2} d^2x + C - \tilde{C}, \quad (5)$$

where Θ_1 and Θ_2 are the angles between outward pointing normals at \bar{S}_1 and \bar{S}_2 before identification. Noting that $\Theta = \Theta_1 + \Theta_2 - \pi$ (see Figure 2(b), and Ref. [2]), we obtain,

$$I - \tilde{I} = A[\bar{S}]/8 + C - \tilde{C}, \quad (6)$$

where $A[\bar{S}]$ is the area of \bar{S} . Clearly, the right hand side of (6) does not vanish for arbitrary C .

Define the ‘residue’ $\mathcal{R}[S]$, associated with identifying surfaces S_1 and S_2 to form a surface S , as the difference between the value of the action before identification and its value after identification for the case that all C ’s vanish. It is not difficult to extrapolate from the above example to obtain a general

prescription for the residue associated with S when \bar{S} and \bar{S}^* are everywhere timelike. We obtain

$$\mathcal{R}[S] = \lambda A[\bar{S}]/8 - \lambda A[\bar{S}^*]/8 \quad (7)$$

where $\lambda = +1$ if the outer sides of S_i have been identified and $\lambda = -1$ if the inner sides of S_i have been identified.

A special class of the topological identifications considered above occurs when different portions of B are identified at isolated 2-surfaces. Such identifications can be of interest in the treatment of horizon thermodynamics and cosmic string dynamics. In these cases the inclusion or exclusion of an isolated 2-surface can have important implications for the global properties of the spacetime. We can derive the residue associated with this class of identifications with the aid of equation (7) and a simple limiting procedure.

For instance, reconsider the example discussed above (i.e. with $S \equiv \hat{S}$ and outer sides of S_1 and S_2 identified) in the limit that S collapses on some timelike 2-surface, J (see Figure 3). Take the topology of S to be $J \times \bar{I}$ where \bar{I} corresponds to a closed interval. Now let a coordinate ε parametrize the interval so that S can be decomposed into a family of 2-surfaces, $J_{(\varepsilon)}$.

Suppose that $-\varepsilon_0 < \varepsilon < +\varepsilon_0$ and take the limit $\varepsilon_0 \rightarrow 0$. We obtain,

$$\begin{aligned} \mathcal{R}[J] &= A[J_{(-\varepsilon_0)}]/8 + A[J_{(+\varepsilon_0)}]/8 \\ &= A[J]/4. \end{aligned} \tag{8}$$

To obtain the residues associated with more complicated topological identifications, one can combine sequences of simple topological identifications at 3-surfaces and 2-surfaces of the form described above. In such cases, a diagram algebra can be a valuable aid (see Figure 4).

3 Identifying surfaces with spacelike boundary

Let us now examine whether spacelike portions of \bar{S} contribute to the residue. Again, suppose that a spacetime $\{g^{ab}, \mathcal{M}\}$ is topologically reconfigured to form a new spacetime $\{g^{ab}, \widetilde{\mathcal{M}}\}$ by identifying boundary surfaces S_1 and S_2 to form a single surface S . First, consider the special case in which $S = \widehat{S}$ with \bar{S} entirely spacelike. Furthermore, for definiteness, suppose that S is spacelike and $B - S$ is timelike in the neighborhood of \bar{S} (see Figure 5).

In the 2-space orthogonal to \bar{S}_1 , let n_1^a be the unit vector tangent to S_1 and pointing outward; let u_1^a be the future pointing unit vector tangent to $B - S_1$; and let \tilde{u}_1^a be the future pointing normal to n_1^a . Similarly, let u_2^a and

n_2^a be past and outward pointing unit normals at \bar{S}_2 . Before identification we have [5], $\eta_1 = \sinh^{-1}(u_1 \cdot n_1)$ and $\eta_2 = \sinh^{-1}(u_2 \cdot n_2)$. After identification we have $\eta = \cosh^{-1}(n_1 \cdot n_2)$. Now express u_2^a and n_2^a in terms of vectors on \bar{S}_1 :

$$\begin{aligned} u_2^a &= -u_1^a \\ n_2^a &= n_1^a \cosh \eta + \tilde{u}_1^a \sinh \eta. \end{aligned} \tag{9}$$

Use (9), the definition of η_2 , and the fact that $u_1 \cdot \tilde{u}_1 = -\cosh \eta_1$, to find

$$\begin{aligned} \eta_2 &= \sinh^{-1}(u_2 \cdot n_2) \\ &= -\sinh^{-1}(u_1 \cdot (n_1^a \cosh \eta + \tilde{u}_1^a \sinh \eta)) \\ &= -\sinh^{-1}(\sinh \eta_1 \cosh \eta - \cosh \eta_1 \sinh \eta) \\ &= \eta - \eta_1. \end{aligned} \tag{10}$$

Now an analysis parallel to that done in the previous section yields

$$\begin{aligned} I - \tilde{I} &= \frac{1}{8\pi} \int_{\bar{S}} (\eta_1 + \eta_2 - \eta) (-\sigma)^{1/2} d^2x + C - \tilde{C} \\ &= C - \tilde{C}. \end{aligned} \tag{11}$$

Setting $C = 0$, we have that *the residue associated with \bar{S} vanishes*.

Numerous other examples can be constructed in which the identification surface has a spacelike boundary. For instance, one can choose the identifi-

cation surface to be timelike rather than spacelike. Also, one can consider cases in which the unit normals at \bar{S}_1 and \bar{S}_2 are differently oriented (e.g. all timelike or all spacelike or some other combination of spacelike and timelike). By analysis parallel to that conducted above, we find in each case that the residue associated with the spacelike boundary of the identification surface is zero.

4 Composition invariance and the problem of superposition

According to the path integral ansatz for quantum gravity, the amplitude for propagation from a state $|\mathbf{g}_i, S_i\rangle$ to a state $|\mathbf{g}_f, S_f\rangle$ is

$$\langle \mathbf{g}_f, S_f | \mathbf{g}_i, S_i \rangle = \int \mathcal{D}[g] \exp iI[g]. \quad (12)$$

To obtain proper superposition behavior, we require

$$\langle \mathbf{g}_f, S_f | \mathbf{g}_i, S_i \rangle = \sum_{\mathbf{g}} \langle \mathbf{g}_f, S_f | \mathbf{g}, S \rangle \langle \mathbf{g}, S | \mathbf{g}_i, S_i \rangle. \quad (13)$$

It is often claimed (see, for instance, Ref. [1]) that equation (13) can be satisfied only if the action is invariant under topological identifications of boundary surfaces. How then do the results of Sections 2 and 3 affect the superposition behavior of quantum gravitational propagators?

Consider first the most common case where the surfaces S_i , S , and S_f are spacelike, compact, and joined at their boundaries by a timelike tube at large radius. The regions to the future and past of S then have a joint at the boundary of S that might result in a residue. However, if S is a spacelike hypersurface, its boundary must also be spacelike. From the results of Section 3 we can now conclude that in fact the boundary of S will *not* contribute to the residue. Thus, if we consider only propagation between *spacelike* surfaces, the propagator will always have the proper superposition behavior when $C = 0$. (Other choices of C are also consistent with superposition, but in this case $C \neq 0$ is not required to achieve proper superposition behavior.)

On the other hand, if S is timelike it may well have a timelike boundary with a non-zero residue. More importantly, in the case of Euclideanized general relativity, the boundary of *any* identification surface always contributes to the action (up to an overall minus sign) as though it were timelike and, hence, contributes to the residue. In such cases, can one recover the superposition law?

The issue whether equation (13) strictly requires invariance of the action under topological identifications of boundary surfaces depends on the measure for the path integral on the left hand side and its relation to the measure

implicit in the sum over intervening surfaces on the right hand side. In the absence of a prescription for either measure, it is not possible to say whether invariance of the action is strictly required. In fact, the behavior of the action under spacetime composition combined with the requirement that equation (13) be obeyed might provide useful insight into the appropriate measure for quantum gravity.

However, if we adopt the view that invariance of the action under composition is desirable, then it is appropriate to explore whether there is any special choice for C that renders the action invariant under spacetime composition. Let us briefly examine this possibility.

First, note that if C is truly a functional of *only* the intrinsic geometry of the boundary, then no choice of C can render the action invariant under arbitrary spacetime compositions. If there were such a choice, then $C - \tilde{C}$ would equal the residue. Yet, while $C - \tilde{C}$ would be a functional of only the intrinsic geometry of the boundary, the residue also depends on whether the inner or outer sides of S are identified. Hence, $C - \tilde{C}$ could not equal the residue for arbitrary spacetime compositions.

If one broadens the class of allowed C so that they can depend not only on the intrinsic geometry of the boundary but also on its embedding in some

reference spacetime, it *is* possible to ensure invariance of the action for special classes of spacetime compositions. One could choose C so that I would actually represent a ‘relative action’; that is, the difference between the ‘bare action’ and the action associated with some fixed reference state satisfying the same boundary conditions. [For example, one could take Minkowski space as the reference state. This would be equivalent to adopting the Gibbons/Hawking prescription for C [4].] When one varies the action functional, the reference state would be kept fixed so it would have no effect on the equations of motion. Also, because the reference action behaves in precisely the same manner as the bare action under spacetime composition, invariance of the relative action would be guaranteed.

Yet, while a given prescription for the reference state can restore invariance of the action in special cases of spacetime composition, no such ‘relative action’ prescription can ever be defined for arbitrary spacetimes and arbitrary compositions of them. The problem, of course, lies in the requirement that the reference state provide an isometric embedding of the boundary geometry. The only state that can satisfy this requirement for arbitrary slicings of a given spacetime is the spacetime itself. Hence, no *independent* reference state can be defined for arbitrary compositions of arbitrary spacetimes.

We conclude that while special choices of C may restore invariance of the action for special spacetime compositions, it appears that there is no way to choose C which will restore invariance for arbitrary spacetime compositions. In any case, one would hope that if the action is to be ‘additive’ it should be so regardless of one’s choice of C . This suggests adopting a broader definition of ‘additivity’.

5 Generalized Additivity

Suppose a spacetime $\{g_{ab}, \widetilde{\mathcal{M}}\}$ is obtained from another spacetime $\{g_{ab}, \mathcal{M}\}$ either by: (1) topologically identifying isometric sub-manifolds of \mathcal{M} to form a single submanifold \mathcal{T} of $\widetilde{\mathcal{M}}$ (see Figure 6), or (2) by simply removing from \mathcal{M} a submanifold \mathcal{T} . We will say that an action exhibits ‘generalized additivity’ if

$$I[\widetilde{\mathcal{M}}] = I[\mathcal{M}] - I[\mathcal{T}]. \quad (14)$$

We do not require that either \mathcal{M} or $\widetilde{\mathcal{M}}$ be connected and we stress that \mathcal{T} may be a region of finite 4-volume. In fact, in the latter case it is easy to show that equation (14) holds, essentially because the contributions from *all* the boundaries, including those of \mathcal{T} , add up correctly. In other words, whenever identifications are made on regions of finite 4-volume, generalized

additivity holds.

From this type of identification we can recover spacetime composition as defined in Section 1 by going to a limit where \mathcal{T} collapses on a surface S .

The general composition law then reduces to

$$I[\widetilde{\mathcal{M}}] = I[\mathcal{M}] - I[S]. \quad (15)$$

In this case it is possible to show that

$$I[\mathcal{T}] \rightarrow I[S] = \mathcal{R}[S] + \text{terms dependent on } C. \quad (16)$$

In other words, when $C = 0$ it is appropriate to interpret the residue as a *finite action associated with the identification surface* itself. More generally, when $C \neq 0$ we should interpret the change in the action due to identification of S as an action associated with this surface.

We conclude that in this generalized sense, the action is always additive. The only ‘unexpected’ result is that when a 4-manifold collapses on a surface with timelike boundary, its action does not vanish (for arbitrary C).

6 Discussion

At this point, some comments are in order. First, we may not expect the action to be invariant when topology change is involved. By identifying

one or more boundary surfaces, we can transform a spacetime of a given topology to an spacetime of a different topology. Equation (7) can then be used to determine how the action of a spacetime changes subject to the changes in topology. One particularly important application of this is in the realm of gravitational thermodynamics. In the Euclidean sector, the residue associated with placing a boundary just outside an event horizon is given by equation (8). This residue can be understood as the entropy associated with the horizon.

Second, we note that the question of whether or not the action is additive cannot be divorced from the question of what constraints are to be imposed along the identification surface and, in particular, at its boundary. All the analysis of Sections 2 and 3 supposes that the intrinsic geometry (and only the intrinsic geometry) is to be held fixed along S . If different constraints are imposed along S , the behavior of the action under spacetime composition must be re-examined.

Third, we note that General Relativity is not the only theory in which the action additivity problem needs to be analyzed and resolved. Any theory that ascribes a finite action to the identification surface or its boundary may have non-vanishing residues. This includes, for example, higher order gravity

theories and non-minimal couplings to other fields. The results for timelike vs. spacelike joints, and definition of generalized additivity, would follow the pattern set in the Sections above.

As a final note, it is worth observing that the quasilocal energy that arises out of the Hamiltonian formulation of general relativity [8, 9, 10] is also non-additive in the ‘usual sense’ (i.e. it is not invariant under identification of boundary surfaces). By exactly repeating the analysis performed above in one less dimension—that is, by identifying of portions of the 2-dimensional boundaries of 3-dimensional spaces—one derives the residues associated with addition of quasilocal energies. A more detailed discussion of this phenomenon will follow in a separate publication.

Acknowledgments: It is a pleasure to thank Bill Unruh, Don Witt, Kristin Schleich, Jonathan Simon, and Valrey Frolov for valuable discussions on this subject. GH is grateful to the National Science and Engineering Council of Canada and the Canadian Institute for Theoretical Astrophysics for supporting this research.

References

- [1] S. W. Hawking, in *Einstein Centenary Survey*, ed. S. W. Hawking and W. Israel (Cambridge University Press, Cambridge, 1979).
- [2] J. B. Hartle and R. Sorkin, *General Relativity and Gravitation* **13**, 541 (1981).
- [3] J. W. York, Jr., *Phys. Rev. Lett.* **28**, 1082 (1972).
- [4] G. W. Gibbons and S. W. Hawking, *Phys. Rev. D* **15**, 2752 (1977).
- [5] G. Hayward, *Phys. Rev. D* **47**, 3275 (1993).
- [6] D. Brill, *Phys. Rev. D* **46**, 1560 (1992).
- [7] E. Farhi, A. H. Guth, J. Guven, *Nucl. Phys.* **B339**, 417 (1990).
- [8] J. D. Brown and J. W. York, Jr., *Phys. Rev. D* **47**, 1407 (1993).
- [9] G. Hayward and Ken Wong, *Phys. Rev. D* **46**, 620 (1992).
- [10] G. Hayward and Ken Wong, *Phys. Rev. D* **47**, 4778 (1993).

List of Figure Captions

1. (a) Spacetime $\{g^{ab}, \mathcal{M}\}$ with boundary $\{h^{ab}, B\}$ is topologically reconfigured to form a new spacetime $\{g_{ab}, \widetilde{\mathcal{M}}\}$ with boundary $\{h^{ab}, \widetilde{B}\}$.
 (b) This is achieved by topologically identifying surfaces S_1 and S_2 to form a single surface S . The behavior of the action under the topological identification is affected by the joints at \bar{S} (marked in bold) and \bar{S}^* .

2. (a) By topologically identifying S_1 and S_2 , the spacetime $\{g^{ab}, \mathcal{M}\}$ becomes a new spacetime $\{g_{ab}, \widetilde{\mathcal{M}}\}$. Note that $\widehat{S} = S$ so $\bar{S}^* = 0$.
 (b) at timelike joints \bar{S}_1 and \bar{S}_2 the unit normal changes direction by angles Θ_1 and Θ_2 , respectively. After identification, the unit normal changes direction by an angle Θ . Note that $\Theta = \Theta_1 + \Theta_2 - \pi$.

3. (a) The identification surface has topology $J \times \bar{I}$. A coordinate ε parametrizes \bar{I} with $-\varepsilon_0 < \varepsilon < +\varepsilon_0$. Thus, S can be decomposed into a family of 2-surfaces, $J_{(\varepsilon)}$.
 (b) In the limit that $\varepsilon_0 \rightarrow 0$, the identification surface collapses on the 2-surface J .

4. A diagram algebra is useful to keep track of the residue for complicated

identification surfaces. A solid dot represents a joint, which contributes to the action one quarter of its area. An empty bar represents a 3-surface, which contributes to the action negative one eighth the area of its 2-boundary surfaces.

5. Topological identification at a spacelike hypersurface with spacelike boundary. In the 2-space orthogonal to \bar{S}_1 , n_1^a is the outward pointing unit vector tangent to S_1 , u_1^a is the future pointing unit vector tangent to $B - S_1$, and \tilde{u}_1^a is the future pointing normal to n_1^a . Similarly, u_2^a and n_2^a are, respectively, past and outward pointing unit normals at \bar{S}_2 .
6. A spacetime $\{g_{ab}, \mathcal{M}\}$ is transformed into a new spacetime $\{g_{ab}, \tilde{\mathcal{M}}\}$ by topologically identifying two submanifolds to form a single region \mathcal{T} .

This figure "fig1-1.png" is available in "png" format from:

<http://arxiv.org/ps/gr-qc/9403018v2>

This figure "fig2-1.png" is available in "png" format from:

<http://arxiv.org/ps/gr-qc/9403018v2>

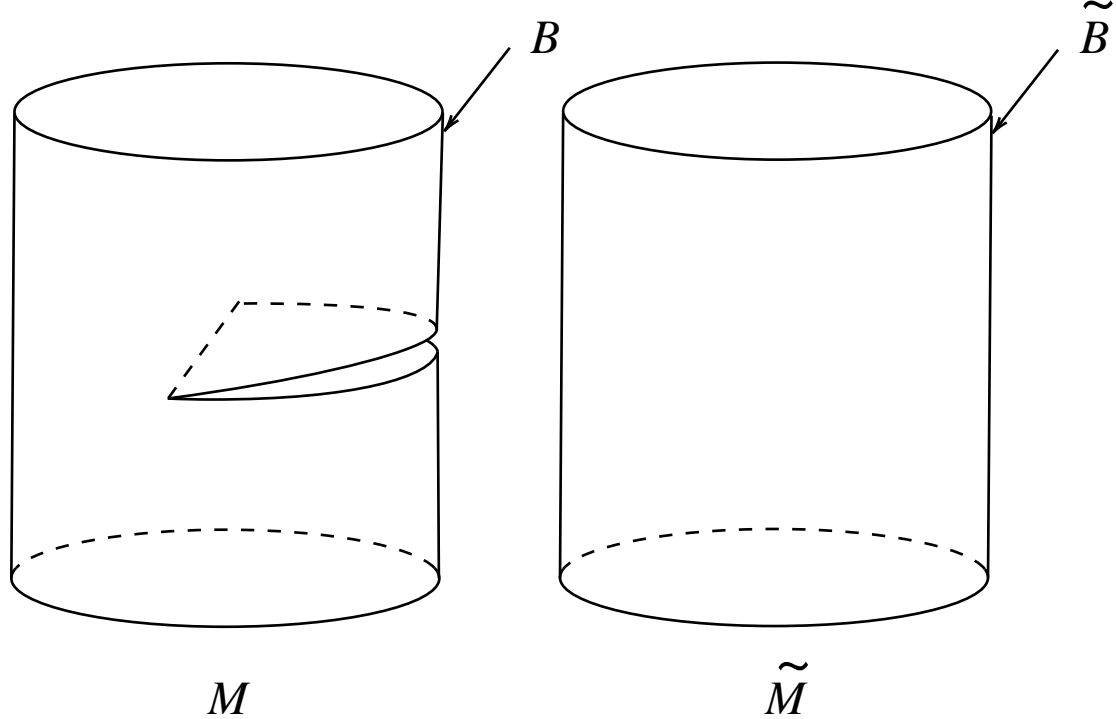
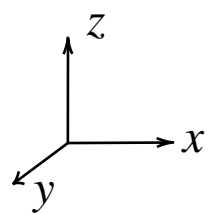

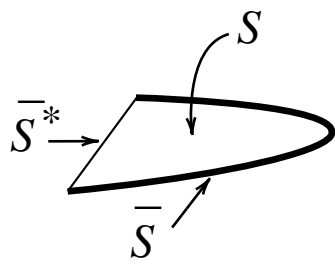
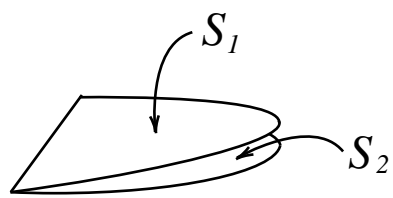

This figure "fig1-2.png" is available in "png" format from:

<http://arxiv.org/ps/gr-qc/9403018v2>

This figure "fig2-2.png" is available in "png" format from:

<http://arxiv.org/ps/gr-qc/9403018v2>

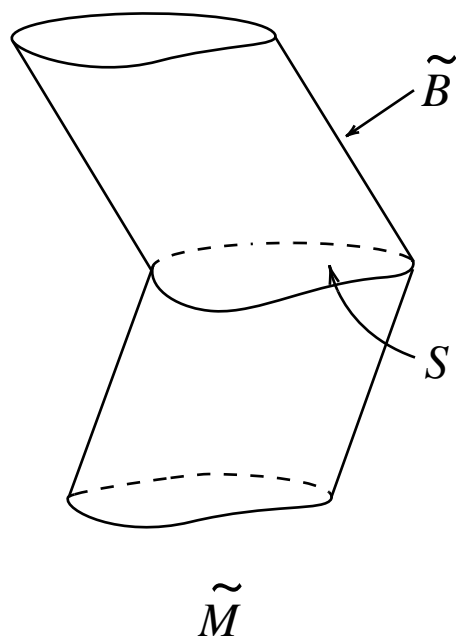
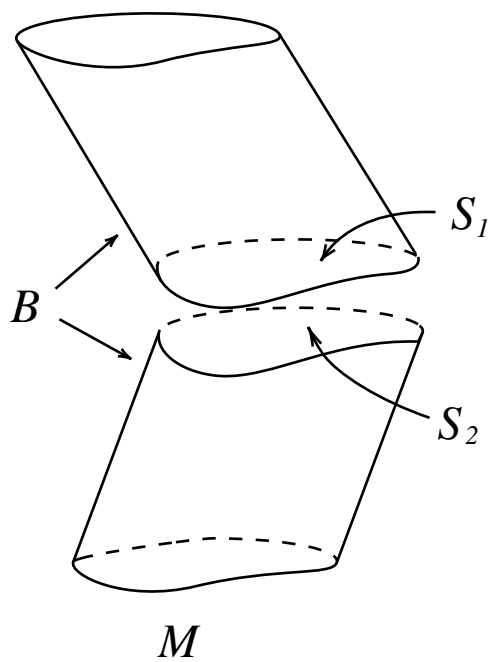
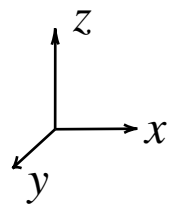

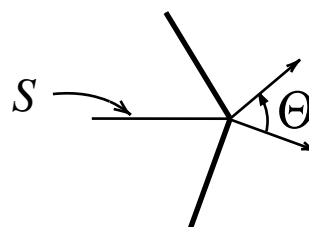
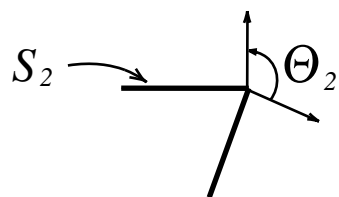
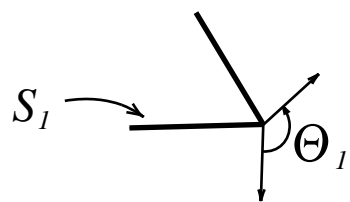
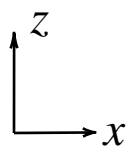

This figure "fig1-3.png" is available in "png" format from:

<http://arxiv.org/ps/gr-qc/9403018v2>

This figure "fig2-3.png" is available in "png" format from:

<http://arxiv.org/ps/gr-qc/9403018v2>

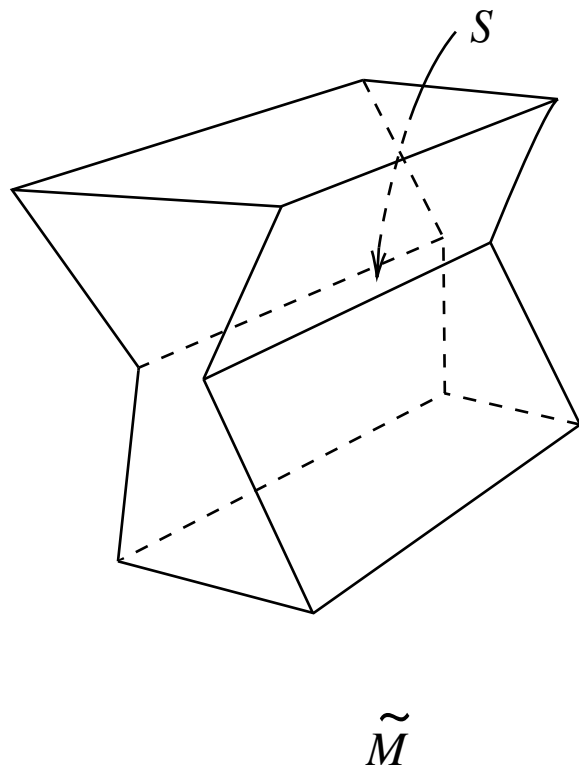
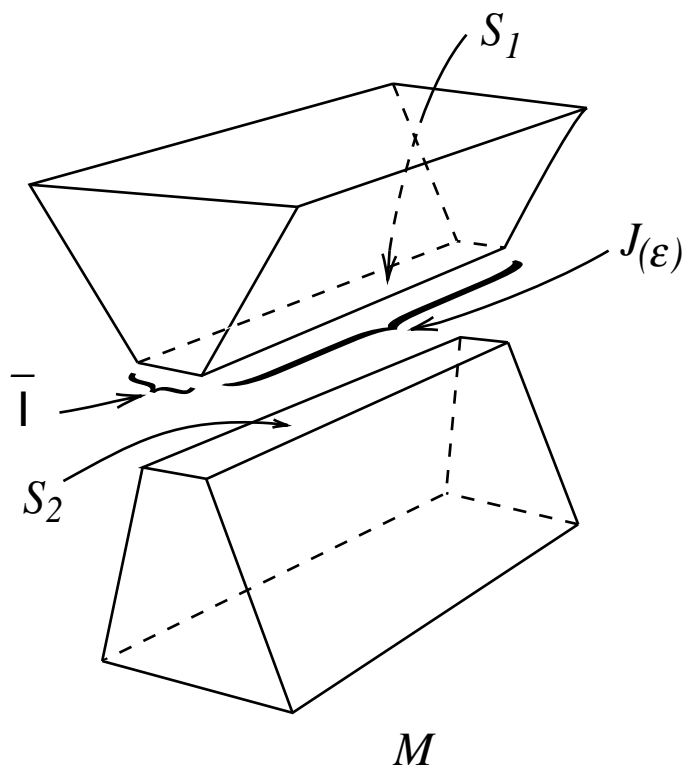

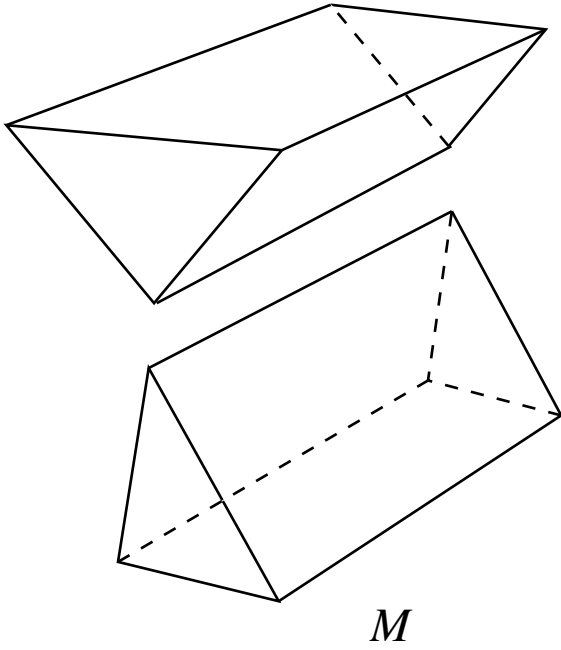

M

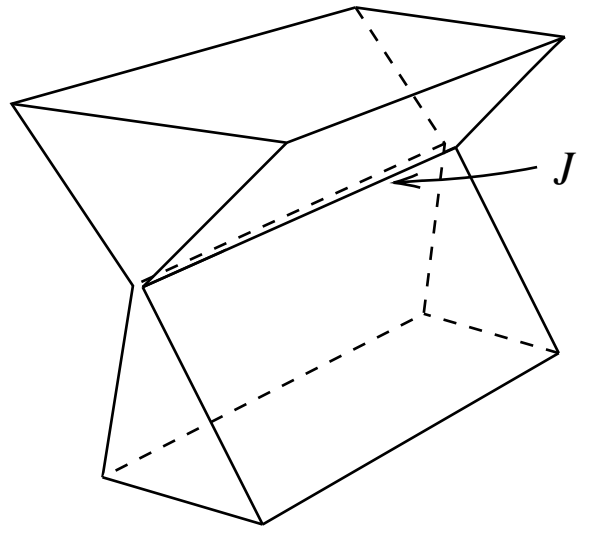













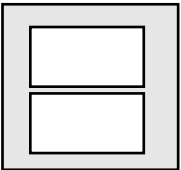
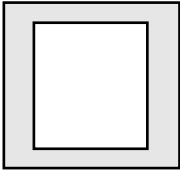

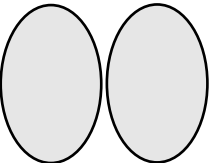
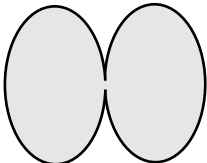
\tilde{M}

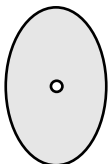
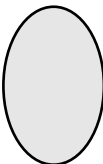
This figure "fig1-4.png" is available in "png" format from:

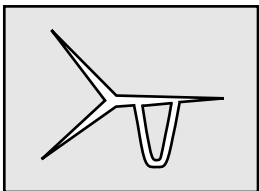
<http://arxiv.org/ps/gr-qc/9403018v2>

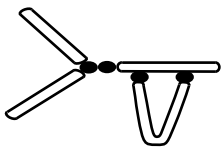
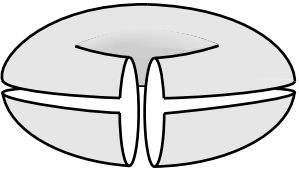
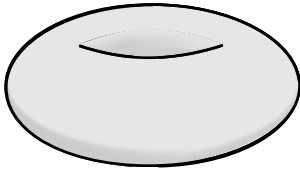
This figure "fig2-4.png" is available in "png" format from:

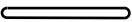
<http://arxiv.org/ps/gr-qc/9403018v2>

	=		-	
	=		+	
	=		+	
	=		-	
	=		+	
	=		+	
	=	- A/8 for each boundary 2--surface		
	=	A/4		

This figure "fig1-5.png" is available in "png" format from:

<http://arxiv.org/ps/gr-qc/9403018v2>

