

STATUS OF NEUTRINO FACTORY R&D WITHIN THE MUON COLLABORATION

RAJENDRAN RAJA

Fermilab

P.O.Box 500, Batavia, Illinois 60510, U.S.A

E-mail: raja@fnal.gov

ABSTRACT

We describe the current status of the research within the Muon Collaboration towards realizing a Neutrino Factory. We describe briefly the physics motivation behind the neutrino factory approach to studying neutrino oscillations and the longer term goal of building the Muon Collider. The benefits of a step by step staged approach of building a proton driver, collecting and cooling muons followed by the acceleration and storage of cooled muons are emphasized. Several usages of cooled muons open up at each new stage in such an approach and new physics opportunities are realized at the completion of each stage.

1. Introduction

The Neutrino Factory and Muon Collider Collaboration, also known as the Muon Collaboration is an international organization consisting of ≈ 130 physicists from 36 institutions whose mission is to design and build the Neutrino Factory. The collaboration was initially established to study ways to make the Muon Collider a reality, by collecting, cooling and accelerating intense beams of muons of both charges. When evidence mounted for the existence of neutrino oscillations in the late 1990's, the potential of a ring storing a high intensity beam of muons in producing a focused beam of neutrinos (and anti-neutrinos) in studying neutrino oscillations was realized^{1,2,3} and the collaboration shifted its efforts towards the study of Neutrino Factories. In order to produce the muons, one needs an intense proton source (known as the proton driver), a scheme to collect the pions produced by bombarding a mercury target with the protons, a scheme to cool the muons so that they can be accelerated and a scheme to accelerate the muons rapidly and store them in a storage ring with long straight sections where the muons decay to produce the neutrino beams that are directed at the neutrino detectors placed at a suitable distance from the source. Figure 1 is the schematic for such a machine.

In this report, we outline the physics potential of a Neutrino Factory and the Muon Collider and describe the R&D efforts being made within the Muon Collaboration towards realizing these goals. Detailed discussion of the topics covered here may be

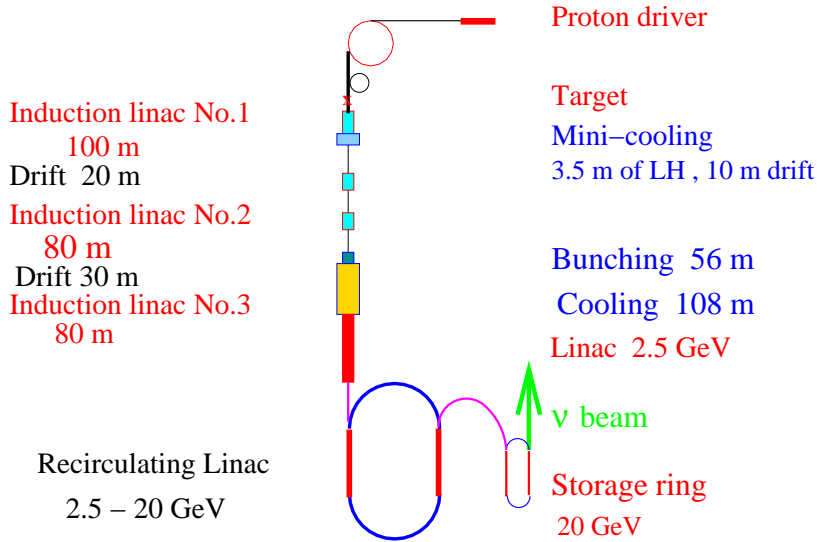

Figure 1: Schematic of the Neutrino Factory Study-II version.

found in the status reports published by the collaboration ^{4,5,6,7}).

2. The Physics Potential of the Neutrino Factory and the Muon Collider

The stored muons in a muon storage ring decay into electrons and neutrinos (e.g. $\mu^+ \rightarrow e^+ \nu_e \bar{\nu}_\mu$). The energy spectrum of the neutrinos is exactly calculable using the Standard Model. Since the electron mass is much smaller than the muon mass, the neutrinos carry off, on average, the same amount of energy as the electron. This is in stark contrast to the beta beams case ⁸), where the heavy ion decay products carry off most of the energy of the initial state heavy ion and the neutrinos are at much lower energy than the beam energy.

Figure 2 shows the error contours in the $\delta m_{32}^2 \sin^2 2\theta_{23}$ space for a 30 GeV Neutrino Factory with 2×10^{20} μ^- decays and a 10 kT detector ⁹). The precision achievable using a neutrino factory in measuring these parameters far exceeds the presently available precision using atmospheric neutrino detectors such as Super-K as well as those likely to be available using superbeams in the near future.

Neutrino factories permit long baseline experiments (> 2000 km) and this enables matter effects to be investigated with some precision. Figure 3 shows the energy spectra of wrong sign muons that appear ¹⁰) due to the oscillation of electron to muon

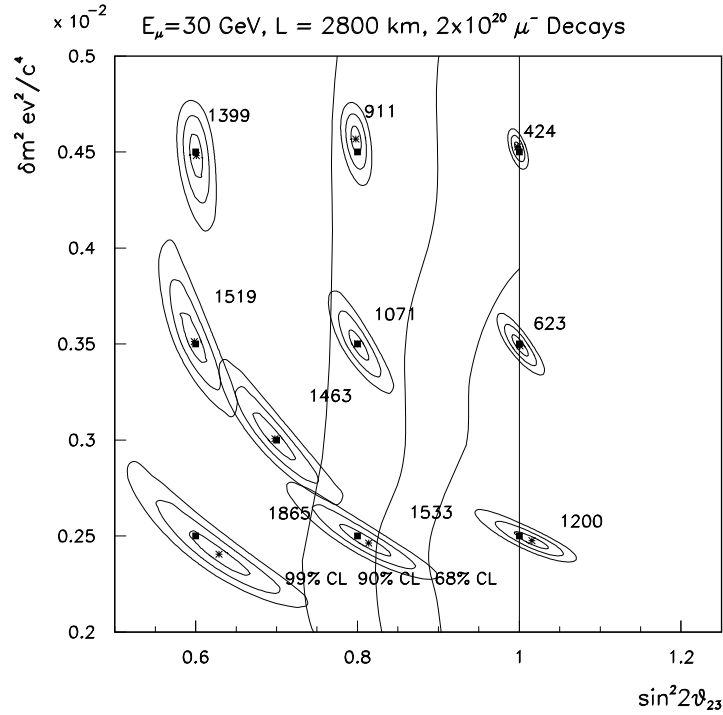

Figure 2: Fit to muon neutrino survival distribution for $E_\mu = 30$ GeV and $L = 2800$ km for 10 pairs of $\sin^2 2\theta$, δm^2 values. For each fit, the 1σ , 2σ and 3σ contours are shown. The generated points are indicated by the dark rectangles and the fitted values by stars. The SuperK 68%, 90%, and 99% confidence levels are superimposed. Each point is labelled by the predicted number of signal events for that point.

neutrinos in a detector with a baseline of 2800 km for a 20 GeV Neutrino Factory with both positive and negative muons. If $\delta m_{32}^2 > 0$, one gets an enhancement for the oscillation ($\nu_e \rightarrow \nu_\mu$) $\rightarrow \mu^-$ due to matter effects (Figure 3(c)) and the reverse is the case for the case $\delta m_{32}^2 < 0$, as shown in Figure 3(b). The results are for a 50 kiloton detector and 10^{20} muon decays. The value of $\sin^2 2\theta_{13} = 0.04$ is assumed for this simulation as well as the best LMA values available at the time of publication of the paper. Figure 4 shows the number of standard deviations¹⁰⁾ with which one can distinguish the sign of δm_{32}^2 for an entry level Neutrino Factory with 10^{19} muon decays as well as a Neutrino Factory with 10^{20} decays as a function of baseline. Even for an entry level Neutrino Factory, it would be possible to distinguish the sign of δm_{32}^2 at the 3σ level for baselines of the order of 2800 km.

Having determined the sign of δm_{32}^2 , the CP violation parameter δ can be determined. Figure 5 shows the predicted ratios of wrong-sign muon event rates when 20 GeV positive and negative muons are stored in a Neutrino Factory as a function of baseline. The shaded region indicates the change in the rates as the CP violating

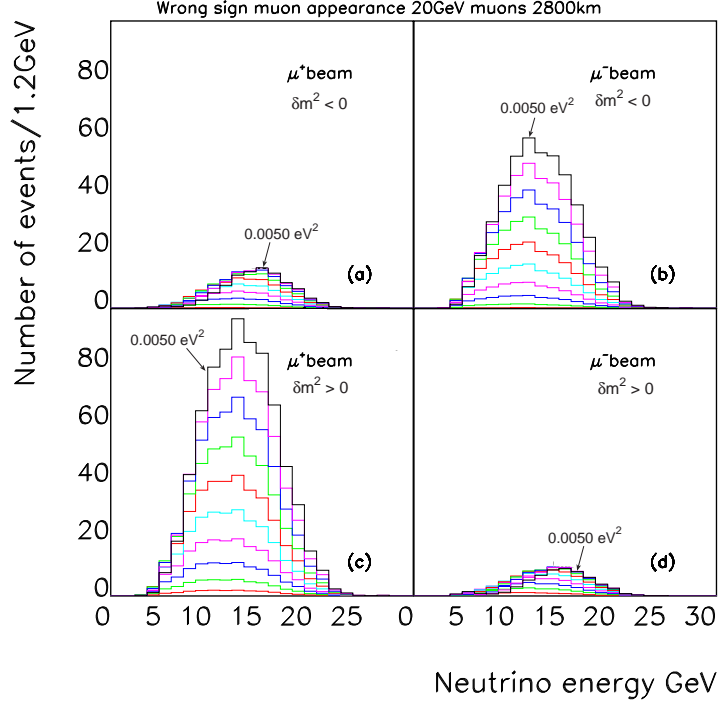

Figure 3: The wrong sign muon appearance rates for a 20 GeV muon storage ring at a baseline of 2800 km with 10^{20} decays and a 50 kiloton detector for (a) μ^+ stored and negative δm_{32}^2 , (b) μ^- stored and negative δm_{32}^2 , (c) μ^+ stored and positive δm_{32}^2 , (d) μ^- stored and positive δm_{32}^2 . The values of $|\delta m_{32}^2|$ range from 0.0005 to 0.0050 eV^2 in steps of 0.0005 eV^2 . Matter enhancements are evident in (b) and (c).

phase δ is varied from $-\pi/2$ to $\pi/2$ and the error bars indicate the statistical errors in the data. A value of $\sin^2 2\theta_{13}=0.004$ is assumed for this plot. It can be seen that the Neutrino Factory is capable of exploring the structure of neutrino mixing by measuring currently unknown parameters ($\sin^2 2\theta_{13}$ and δ) over ranges unmatched by other techniques and the known parameters ($\sin^2 2\theta_{23}, \delta m_{32}^2$) with much better precision than other methods.

It is also possible to do precision neutrino non-oscillation physics at the Neutrino Factory ¹²⁾. Parton densities with $x > 0.1$ can be measured with an order of magnitude more precision than currently available. Polarized parton densities become measurable and $\sin^2 \theta_W$ can be measured with an error of $\approx 2 \times 10^{-4}$. Hydrogen targets can be employed, bypassing nuclear effects and rare lepton flavor violating decays of muons can be tagged with the appearance of wrong sign electrons and muons or prompt taus.

The energy of a muon beam in a Neutrino Factory or a muon collider can be determined to an accuracy of a part per million using $g - 2$ precession ¹³⁾ and this can be put to good use in a Muon Collider with a center of mass energy equal to the

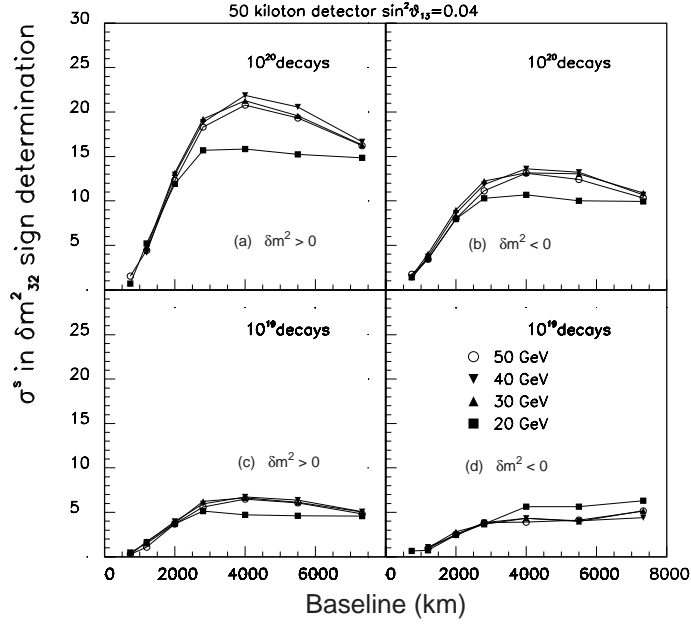

Figure 4: The statistical significance (number of standard deviations) with which the sign of δm_{32}^2 can be determined versus baseline length for various muon storage ring energies. The results are shown for a 50 kiloton detector, and (a) 10^{20} μ^+ and μ^- decays and positive values of δm_{32}^2 ; (b) 10^{20} μ^+ and μ^- decays and negative values of δm_{32}^2 ; (c) 10^{19} μ^+ and μ^- decays and positive values of δm_{32}^2 ; (d) 10^{19} μ^+ and μ^- decays and negative values of δm_{32}^2 .

Higgs boson mass, also known as a Higgs Factory. Higgs bosons can be produced in the s channel in a Muon Collider, since the cross section is $\approx 40,000$ times that present in an e^+e^- collider, by virtue of the mass of the muon being ≈ 200 times that of the electron. The accurate determination of the energy of a muon bunch in a Muon Collider permits the scanning of the Higgs boson peak and a determination of its width. In a Minimal Supersymmetric version of the Standard model which has two sets of degenerate heavy Higgs bosons (H and A), the Muon Collider can be used to tell them apart by means of an s channel scan. The Muon Collider is compact and fits on existing laboratory sites. If the problems related to cooling and acceleration can be solved, it represents a means to reach energies as high as 2-3 TeV in the center

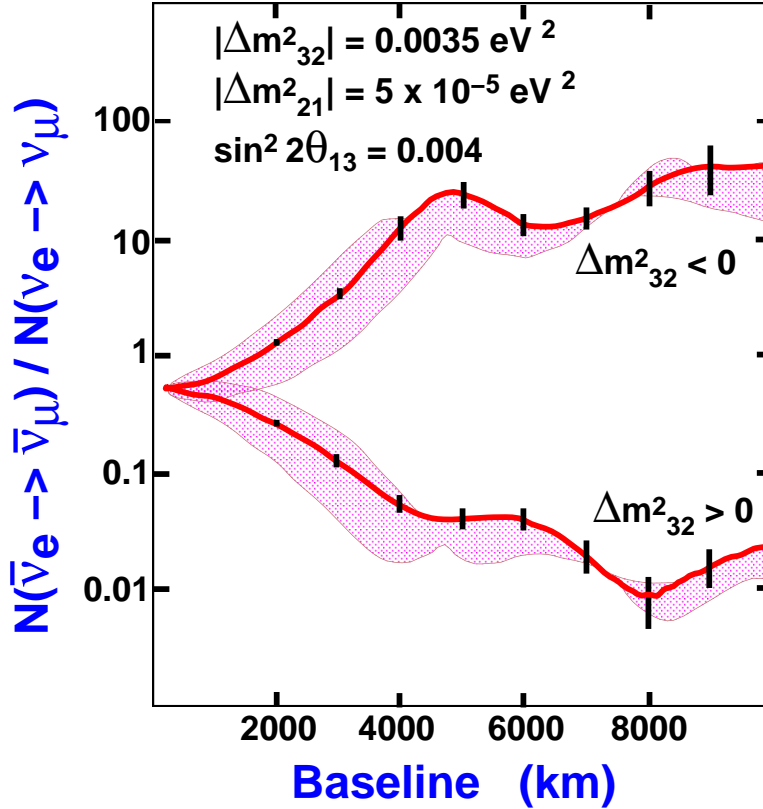

Figure 5: Predicted ratios of wrong-sign muon event rates when positive and negative muons are stored in a 20 GeV Neutrino Factory, shown as a function of baseline. A muon measurement threshold of 4 GeV is assumed. The lower and upper bands correspond, respectively, to negative and positive δm_{32}^2 . The widths of the bands show how the predictions vary as the CP violating phase δ is varied from $-\pi/2$ to $\pi/2$, with the thick lines showing the predictions for $\delta = 0$. The statistical error bars correspond to a high-performance Neutrino Factory yielding a data sample of 10^{21} decays with a 50 kiloton detector. The curves are based on calculations presented in ¹¹⁾.

of mass.

3. Proton Driver

We now describe the stages involved in realizing a Neutrino Factory and a Muon Collider. The first stage calls for an intense beam of protons and necessitates the building of proton driver. The total power of such a proton machine needs to be of the order of 4MW using current schemes of collecting and cooling muons. The building of a 1MW proton driver is expected to cost \$250M-330M and a 4MW driver is expected to cost \$330M-410M. Figure 6 shows the layout of such an object on the Fermilab site and Figure 7 shows a corresponding scheme on the Brookhaven site.

Such a proton driver has multiple uses. It can be used to produce conventional

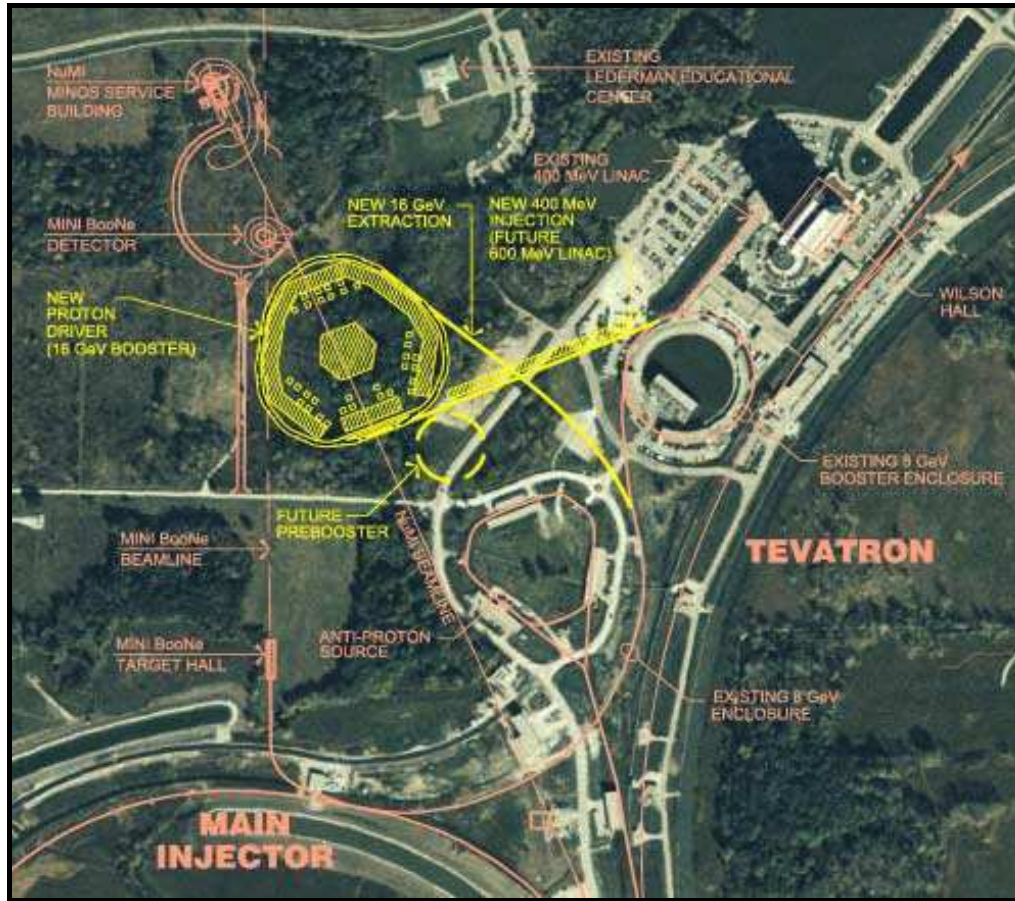

Figure 6: FNAL proton driver layout from Ref. 15).

neutrino beams of high intensity (known in the jargon as superbeams) to extend the measurement of the oscillation parameters beyond current limits. Superbeam sensitivity to oscillation parameters has been studied extensively compared to Neutrino Factories and is inferior to that achievable with Neutrino Factories¹⁴⁾. Various groups at CERN¹⁶⁾, Brookhaven⁷⁾ and Fermilab¹⁵⁾ are currently exploring several different designs for building such a machine.

4. Producing and collecting muons

The intense proton beam from the proton driver is focused on a target (currently liquid mercury, within the Muon Collaboration), which produces large numbers of pions. The pions are contained in a 20T solenoid inside which sits the target as shown in Figure 8. The high magnetic field is needed to confine the interaction products which are produced with large spreads in energy and angle. The pions from the interaction are at various transverse and longitudinal momenta. They need to

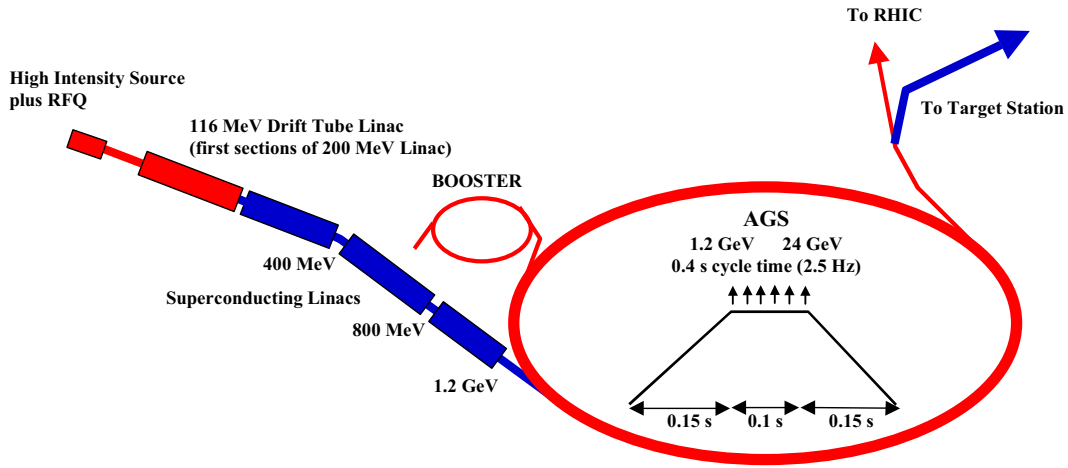

Figure 7: AGS proton driver layout.

be “phase rotated” and bunched. The term “phase rotation” is used to describe the process by which a beam of pions of varying energy is acted on by electric fields that vary with time and position along the line of flight of the pion to produce a beam that is more uniform in energy.

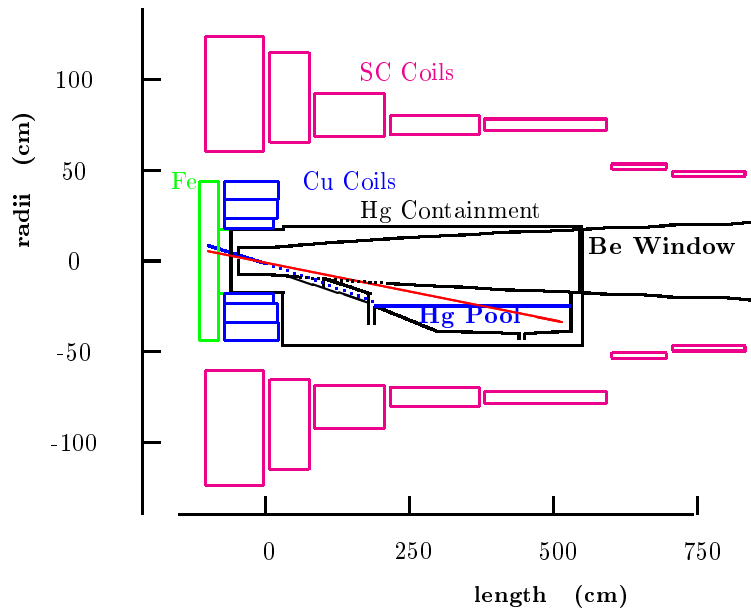

Figure 8: Target, capture solenoids and mercury containment.

There are several schemes that have been investigated to do phase rotation. Figure 9 illustrates the induction linac scheme used ⁷⁾ in study II. After phase rotation, the beam goes into an rf buncher which imposes an rf structure on the beam. The collection, phase rotation and bunching channels collectively act as a decay region

where pions decay into muons. These muons need to be cooled so that they can be accelerated and stored relatively easily. Due to the short lifetime of the muons ($\approx 2\mu s$), the conventional cooling techniques such as stochastic cooling or electron cooling are inapplicable. Ionization cooling, whereby the muons lose energy in low- Z absorbers (such as liquid hydrogen), and the lost longitudinal energy is compensated by rf acceleration, at present provided the only means to cool muons. The momentum of the muons at the end of the decay channel is ≈ 250 MeV/c and the rf frequency is 200 MHz. The transverse emittance of the beam at the end of the decay channel is 12mm-rad. For the neutrino factory, the cooling requirements are less stringent than for the muon collider, and it is only necessary to cool this emittance to ≈ 2.7 mm-rad.

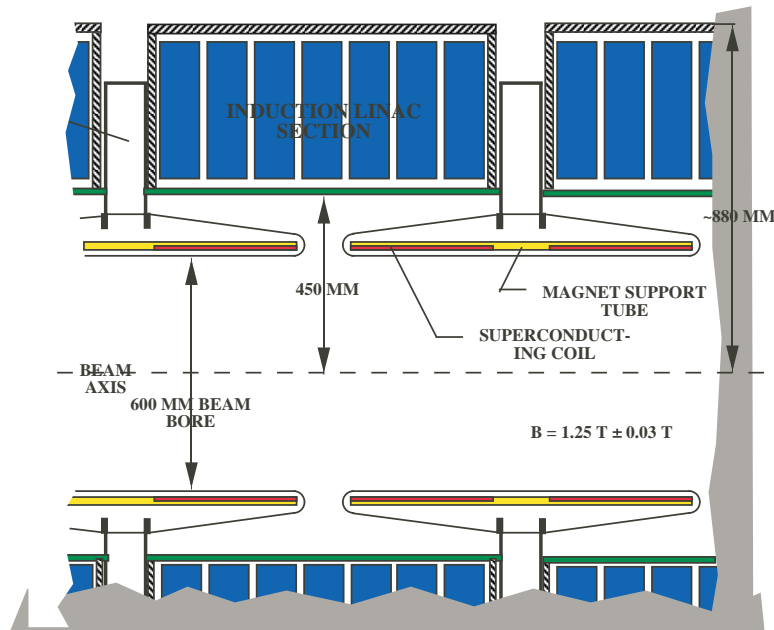
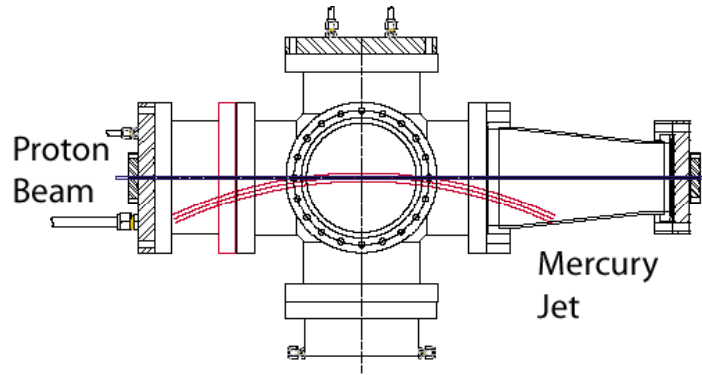

Figure 9: Cross section of the induction cell and transport solenoids.

Currently, the collaboration is engaged in building and testing a 15 Tesla version of the high field solenoid housing the mercury target. Tests have also been done with 1-cm diameter mercury jets exposed to beam ¹⁷⁾ of $2E12$ protons as seen in Figure 10. The dispersal of the jet due to the interaction with the beam was not found to be destructive.

5. Ionization Cooling

Solenoidal cells provide large acceptance to the beam at the end of the buncher. They focus the beam at the absorber. It is important that the divergence of the beam be as large as possible at the absorber so as to minimize the emittance growth due to multiple scattering which adds to the angular divergence of the beam in quadrature.



1-cm-diameter Hg jet in 2×10^{12} protons at $t = 0, 0.75, 2, 7, 18$ ms.



Figure 10: Targetry setup and photographs of beam hitting mercury jets at $t=0,0.75,2,7$ and 18 ms.

The absorber of choice currently is liquid hydrogen. This is to minimize the effects due to multiple scattering for a given energy loss. Each cell of the cooling lattice contains three solenoids. Figure 11 shows two cells of such a lattice and the placement of the liquid hydrogen absorber and the rf modules. The direction of the solenoids reverses in alternating cells to prevent the buildup of canonical angular momentum in the cooled beam. Each solenoid in this lattice design (known as SFOFO in the jargon) is 3-5 Tesla in strength and the rf frequency is 201MHz. The energy loss per absorber is 7-12 MeV and the rf voltage must be adjusted to compensate for this energy loss. Every cooling channel is characterized by a number called the “equilibrium emittance”, which is that emittance at which the cooling rate equals the rate at which the particles are heated by multiple scattering and straggling. The channel is “tapered” in that as the cooling proceeds, one increases the strength of cooling by making the solenoidal focusing larger and the equilibrium emittance smaller.

Figure 12 shows the transverse and longitudinal emittance of the beam as a function of distance down this cooling channel. We replace the lost energy in the longitudinal direction using the rf modules and the beam cools transversely. However, these cooling channels do not cool in the longitudinal direction, since energy fluctuations due to straggling cause heating in the longitudinal direction.

The figure of merit at the end of a cooling channel for a Neutrino Factory is the number of muons/proton that will fit into the acceptance of the accelerator. Figure 13

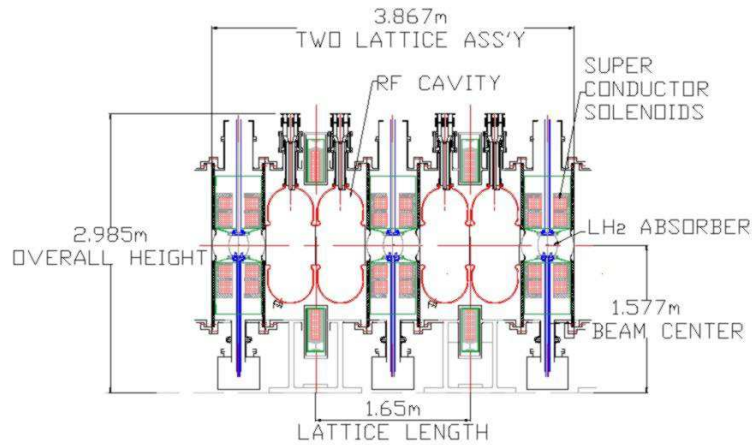

Figure 11: Two cells of the 1.65 m cooling lattice.

shows the number of muons/proton that will be admitted into accelerator acceptances of 9.75 mm and 15 mm as a function of length of the cooling section. These are rising functions of cooling section length indicating the efficacy of the cooling process.

The price tag of the collection, phase rotation and cooling section is estimated to be \$660M-840M. It is expected to produce a cold muon source of 4×10^{20} muons per year with an energy spread of 4.5%. There are a large number of “spin-off” uses for such a source of cold muons. One can use it to study rare decay modes of the muon, and after a modest acceleration to the “magic energy” of 3.1 GeV, measure the $g - 2$ of the muon to high precision as well as search for the electric dipole moment of the muon. Cold muons can also be used for muon radiography for medical as well as other applications. For a comprehensive review of the uses of cold muons see the status report ⁵⁾.

The collaboration is engaged in R&D efforts in fabricating liquid hydrogen absorbers ¹⁸⁾, fabricating and testing warm and superconducting rf cavities, and in mounting an international effort to demonstrate ionization cooling of muons, called MICE ¹⁹⁾. The warm rf work has been conducted for 805 MHz cavities and also for 201MHz cavities. When the warm rf is put in a magnetic field, damage to the cavity has been observed due to breakdown currents. Figure 14 shows the dark current measurements as a function of rf voltage as well as photomicrographs of the damage to the cavity. More work is being done to understand and control these currents. One of the avenues being explored is the use of high pressure gas such as hydrogen to contain these discharges. An rf workshop ²⁰⁾ was held at Argonne National Laboratory

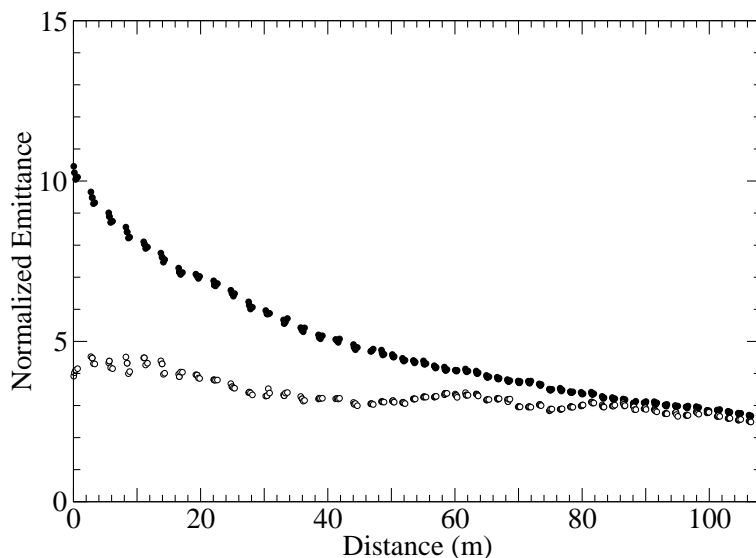

Figure 12: The transverse (filled circles, in mm) and longitudinal (open circles, in cm) emittances, as a function of the distance down the cooling channel.

during the fall of 2003 to address these issues.

In addition, the collaboration has managed to construct the Mucool Test Area at the end of the Fermilab Linac (See Figure 15) which will be used to test absorbers and rf modules by exposing them to high intensity linac beams (400 MeV H^-).

6. Acceleration and storage ring

We intend to accelerate the muons to ≈ 2.87 GeV using a preaccelerator linac and then on to 20 GeV using a recirculating linac (RLA) as shown in figure 16. The cost of this stage is estimated to be \$220-250M for the pre-accelerator stage and \$1250-1350M for the RLA. The acceleration stage is thus the most costly segment of the Neutrino Factory and efforts are being made to bring the cost down by examining other schemes such as rapid cycling synchrotrons ²¹⁾ and also Fixed Field Alternating Gradient (FFAG) machines ²²⁾ that have large momentum acceptance and may need less cooling.

Preliminary storage ring designs have been made with long straight sections that point towards detectors.

This completes the review of components used to build the Neutrino Factory. The amount of cooling needed for a Neutrino Factory is significantly less than that needed to operate a Muon Collider. In particular, a Muon Collider needs longitudinal as well as transverse cooling. At the end of the linear cooling section, the transverse and longitudinal emittances of the beams are 2.6 mm-rad and 30 mm-rad. For the Muon Collider operating as a Higgs Factory, one needs to reduce these to 0.14mm-rad and 9 mm-rad respectively. In addition, one needs to be able to measure the energy of

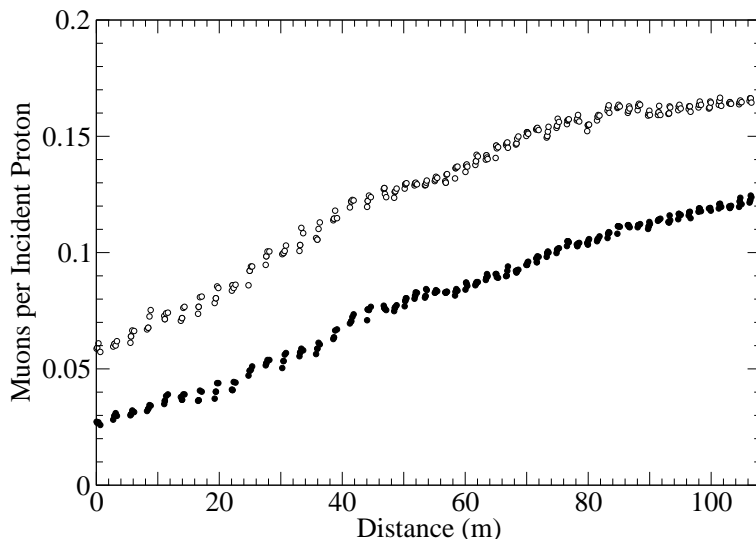

Figure 13: Muons per incident proton in the cooling channel that would fall within a normalized transverse acceptance of 15 mm (open circles) or 9.75 mm (filled circles).

each muon bunch to a part in 10^6 , so that one can scan the width of a narrow Higgs resonance. It has been demonstrated that using $g - 2$ spin precession, it is possible to measure the energy of the muon bunches to a precision comparable to this provided the bunches retain a modest amount of polarization (≈ 0.1)¹³.

In order to reduce the longitudinal emittance, the collaboration has come up with an innovative series of machines, called “ring coolers” which can be made to cool in all 6 dimensions simultaneously.

7. Ring Coolers

The first such ring cooler scheme to be proposed, known as the Tetra ring, is shown²³ in Figure 17. In each of the four sides of the ring are placed long solenoids whose fields reverse from side to side. The solenoidal field increases to 5.15T at its center, where a liquid hydrogen absorber is placed. The beam is bent in a circle by means of 8 special dipoles (with field index $\frac{-1}{2}$) which bend as well as focus the beam and cause dispersion in the middle of the short solenoids where the lithium hydride wedge absorbers are placed. The wedge absorbers cause a reduction in longitudinal emittance since the faster particles are made to traverse through thicker portions of the wedge.

Figure 18 shows the evolution of the transverse and longitudinal emittance in this ring cooler as a function of turn number. We were able to obtain 6D cooling in this ring simulation for the first time. It must be pointed out however that the fields used for the solenoids and dipoles were approximated by hard-edge approximation. Calculations are under way to show that the cooling persists when more realistic fields

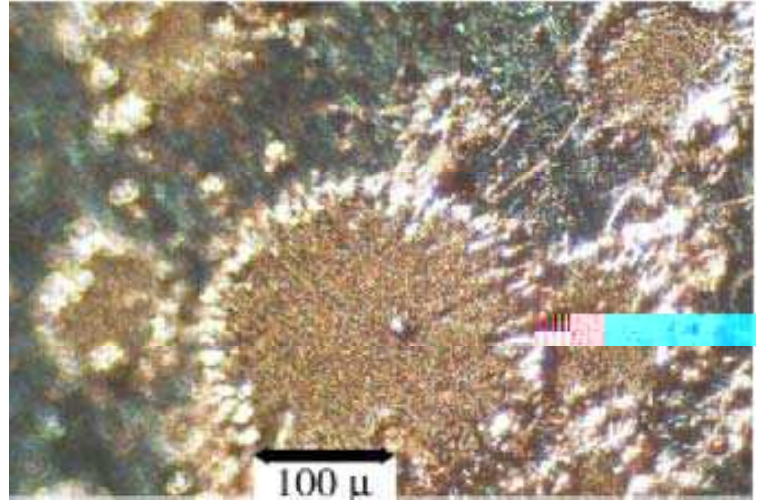
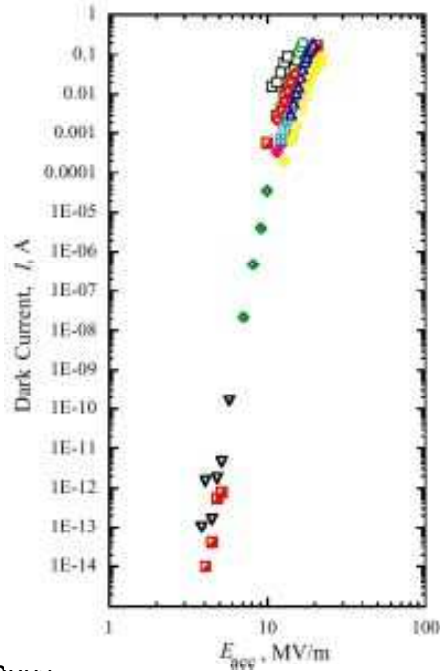

Figure 14: Dark current measurements in rf cavity in a magnetic field. Damage to the cavity can be seen.

are used.

We have also simulated a version of the ring cooler ²⁴⁾, where solenoids similar to those used in the linear channel are put in a circle with wedge absorbers in between. Figure 19 shows the layout of such a ring, known as the RFOFO ring, with a region marked out for injecting and extracting the beam. Figure 20 shows the 6-D cooling and transmission as a function of the circumference traversed in the ring. A measure of the efficacy of the cooling is made by use of the so-called “merit factor”, which is defined as the $(\frac{6D \text{ emittance in} \times \text{transmission}}{6D \text{ emittance out}})$ of the ring. The major difficulty with these rings is the problem of injection and extraction. In order to inject an uncooled beam, kickers need to be fabricated that are orders of magnitude more powerful than any in existence, since the kicker strength goes as the square of the transverse emittance of the beam. The problem of injection of the beam is further exacerbated by the need for long straight sections, that perturb the optics.

It was considerations of the problem of injection among others that led to the proposal ²⁵⁾ a third type of ring cooler, that uses dipoles to bend and focus the beam. Recently, promising results have emerged from simulations of such a cooler and discussions are underway to see if such a cooler could be built cheaply to demonstrate the concept of ring coolers.

The road to the Muon Collider will require a series of ring coolers, the last one



Figure 15: The newly completed Mucool Test Area at the end of the Fermilab Linac.

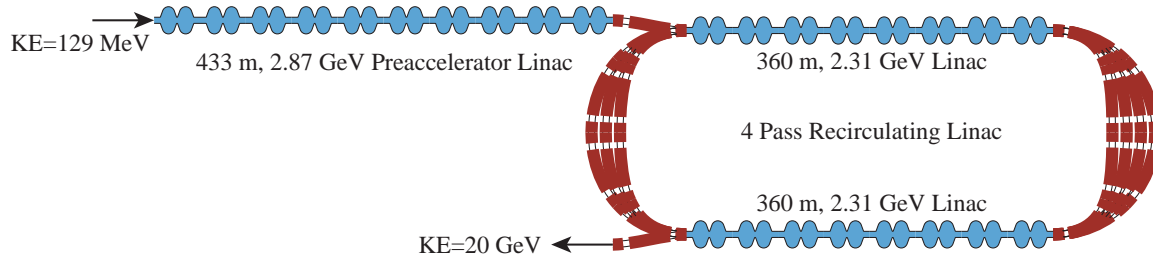

Figure 16: Accelerating system layout.

will probably use lithium lenses to achieve very low emittances ²⁶).

8. Conclusions

Neutrino oscillations represent an exciting area of particle physics beyond the standard model. The staged approach to Neutrino Factories and the Muon Collider outlined here represent a means to provide a diverse and rich “base” program of particle physics that will keep any laboratory wise enough to invest in it at the forefront of physics for years ahead.

9. Acknowledgements

The author wishes to thank the organizers of the NO-VE 2003 conference for putting together an excellent collection of talks and discussion.

10. References

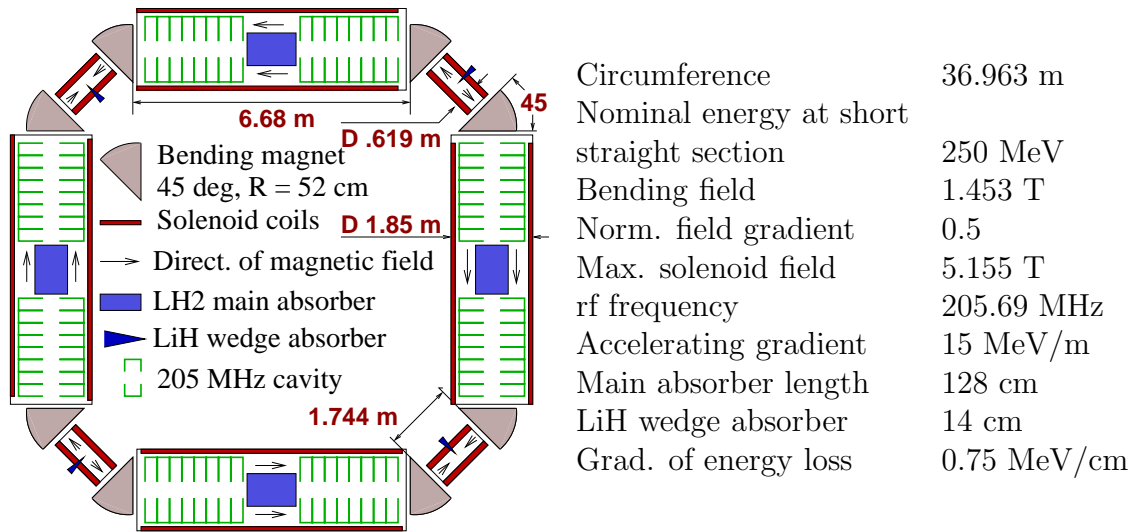

Figure 17: Layout and parameters of the solenoid based Tetra ring cooler

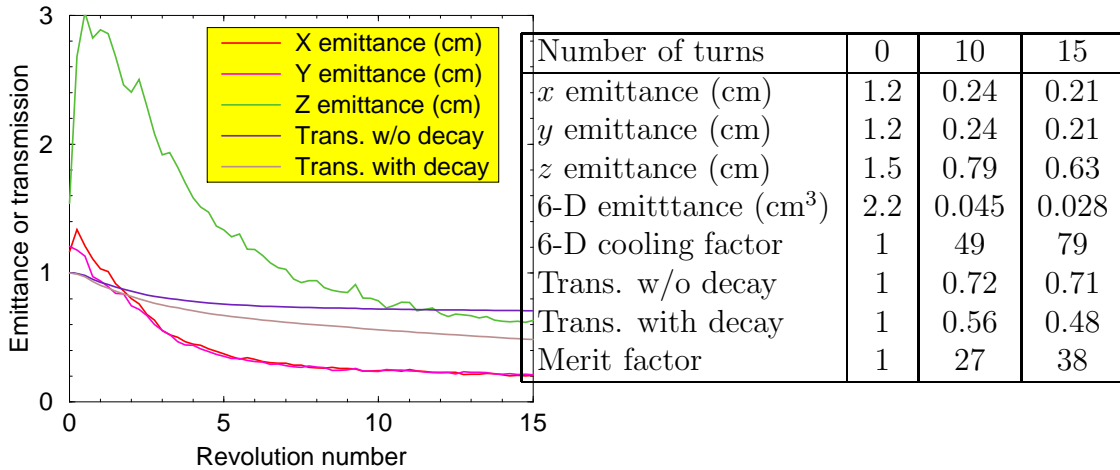

Figure 18: Evolution of the beam emittance/transmission at the TETRA ring cooler.

- 1) B. J. King, *The Physics Opportunities and Technical Challenges of a Muon Collider*, Jan 1994, submitted to Columbia University in partial fulfillment of the requirements of a Ph.D, physics/9907026, unpublished.
- 2) *Proceedings of the Fermilab Workshop on Physics at a Muon Collider and the Front End of a Muon Collider*, eds.-S. Geer, R. Raja (Nov. 1997), AIP Conf. Proc. **435**; S. Geer, *Physics Potential of Neutrino Beams from Muon Storage Rings*, AIP Conf. Proc. **435**, 384 (1998).
- 3) S. Geer, Phys. Rev. D **57**, 6989 (1998).

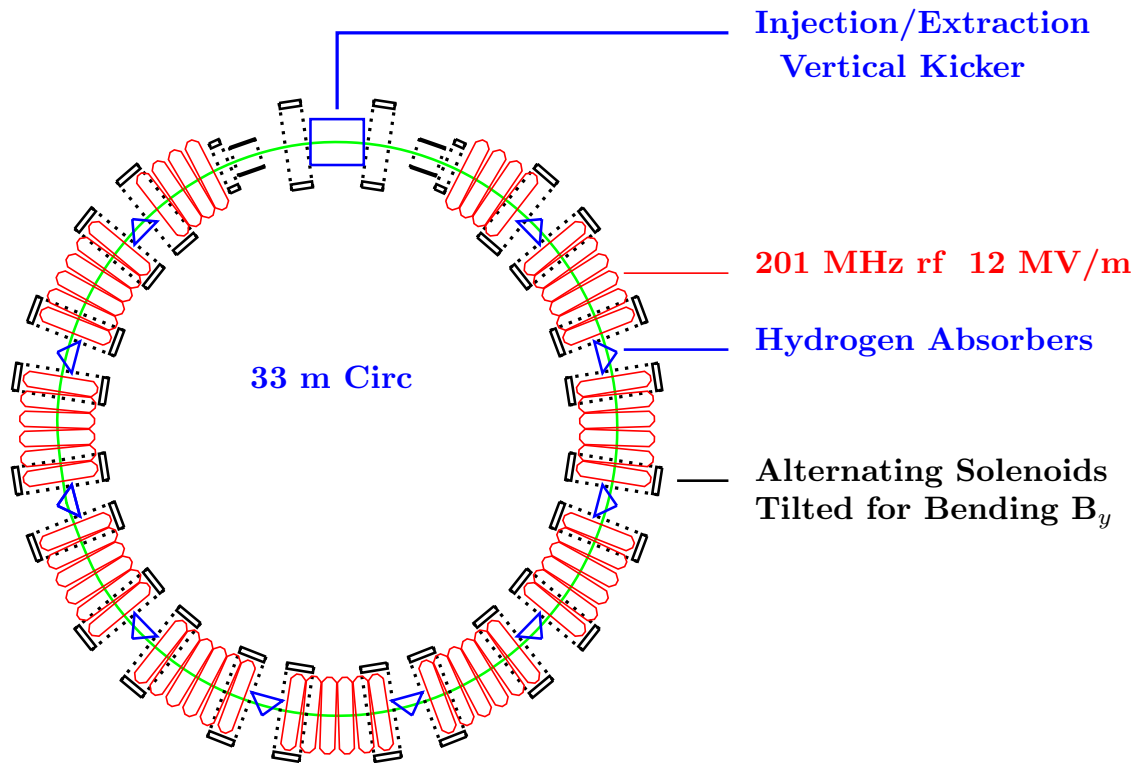

Figure 19: Layout of an RFOFO cooling ring.

- 4) Charles M. Ankenbrandt *et al.* (Muon Collider Collaboration), Phys. Rev. ST Accel. Beams **2**, 081001 (1999).
- 5) Mohammad M. Alsharo'a *et al.* (Muon Collider Collaboration), Phys. Rev. ST Accel. Beams **6**, 081001 (2003).
- 6) N. Holtkamp and D. Finley, eds., *A Feasibility Study of a Neutrino Source Based on a Muon Storage Ring*, Fermilab-Pub-00/108-E (2000), http://www.fnal.gov/projects/muon_collider/nu-factory/nu-factory.html
- 7) S. Ozaki, R. Palmer, M. S. Zisman, and J. Gallardo, Editors, *Feasibility Study-II of a Muon-Based Neutrino Source*, BNL-52623 (June 2001); <http://www.cap.bnl.gov/mumu/studyii/FS2-report.html>.
- 8) P. Zucchelli, Phys. Lett. **B532**, 166, (2002).
- 9) V. Barger, S. Geer, R. Raja, and K. Whisnant, Phys. Rev. D **62**, 013004 (2000).
- 10) V. Barger, S. Geer, R. Raja, and K. Whisnant, Phys. Lett. **B485**, 379 (2000)
- 11) V. Barger, S. Geer, R. Raja, and K. Whisnant, Phys. Rev. D **62**, 073002 (2000).
- 12) M. L. Mangano *et al.*, *Physics at the Front-End of a Neutrino Factory: A Quantitative Appraisal*, CERN-TH/2001-131, hep-ph/0105155.
- 13) R. Raja and A. Tollestrup, *Calibrating the Energy of a 50-GeV x 50-GeV*

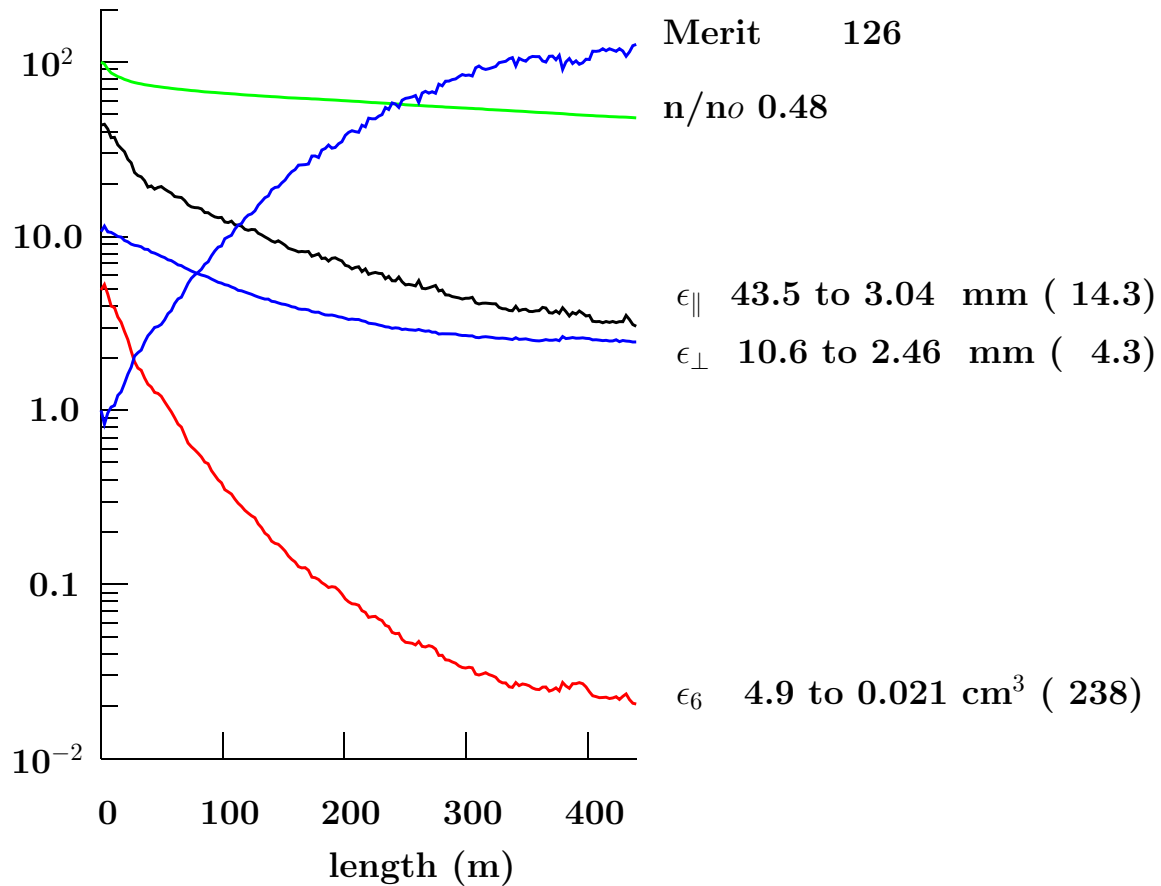

Figure 20: Transmission, normalized transverse emittance, normalized longitudinal emittance, normalized 6-dimensional emittance, and the merit factor, as a function of distance in the RFOFO ring.

- Muon Collider Using Spin Precession*, Phys. Rev. D **58**, 013005 (1998).
- 14) V. Barger, S. Geer, R. Raja, and K. Whisnant, Phys. Rev. D **63**, 113011 (2001).
 - 15) W. Chou, A. Ankenbrandt, and E. Malamud, *The Proton Driver Design Study*, FERMILAB-TM-2136 (December 2000); *Fermilab Proton Driver Physics Study Website* is at <http://projects.fnal.gov/protondriver/>.
 - 16) *Conceptual design of the SPL, a high-power superconducting H- linac at CERN*, B. Autin *et. al.* CERN-2000-012, Dec 2000.
 - 17) See talk by Kirk McDonald, <http://www.hep.princeton.edu/~mcdonald/mumu/target/targett>
 - 18) *Energy Absorber R&D*, D. M. Kaplan, *et. al.*, MUC-NOTE-0141, <http://www-mucool.fnal.gov/mcnotes/public/ps/muc0141/muc0141.ps.gz>
 - 19) See A. Blondel, these proceedings.
 - 20) *Workshop on High Gradient rf*, Oct 7-9, 2003, <http://www.mice.iit.edu/rfworkshop/>
 - 21) *A pulsed Muon Synchrotron for a Neutrino Fac-*

- tory, S. Berg *et. al.*, MUC-NOTE-0259,
<http://www-mucool.fnal.gov/mcnotes/public/pdf/muc0259/muc0259.pdf>
- 22) *Fixed Field Circular Accelerator Design*, C. Johnstone *et. al.*, Proc. of 1999 Particle Accelerator Conference, New York, New York, March 29, 1999, pp 3068.
- 23) V. Balbekov, S. Geer, N. Mokhov, R. Raja, and Z. Usubov, “Muon Ring Cooler for the MUCOOL Experiment”, Proc. 2001 Particle Accelerator Conference, Chicago (IEEE, New York, 2001) <http://accelconf.web.cern.ch/AccelConf/p01/>, p 3867.
- 24) *Muon Cooling in the RFOFO ring*, R. Fernow, *et. al.*, MUC-NOTE-0273, <http://www-mucool.fnal.gov/mcnotes/public/pdf/muc0273/muc0273.pdf>
- 25) *Muon Cooling Rings for the Neutrino Factory and the $\mu^+\mu^-$ Collider*, Y.Fukui, *et. al.*, MUC-NOTE-0262, <http://www-mucool.fnal.gov/mcnotes/public/pdf/muc0262/muc0262.pdf>;
See H. Kirk, <http://www.cap.bnl.gov/mumu/conf/MC-040127/kirk-MC.pdf>
- 26) See Y. Fukui, <http://www.cap.bnl.gov/mumu/conf/MC-040127/fukui-MC.pdf>