

A Water Tank Čerenkov Detector for Very High Energy Astroparticles

P. Bauleo, A. Etchegoyen¹, J.O. Fernández Niello¹, A.M.J. Ferrero, A. Filevich¹, C.K. Guérard², F. Hasenbalg, M.A. Mostafá, D. Ravnani, and J. Rodríguez Martino.

*Departamento de Física, Comisión Nacional de Energía Atómica,
Avenida del Libertador 8250, (1429) Buenos Aires, Argentina*

Abstract:

Extensive airshower detection is an important issue in current astrophysics endeavours. Surface arrays detectors are a common practice since they are easy to handle and have a 100% duty cycle. In this work we present an experimental study of the parameters relevant to the design of a water Čerenkov detector for high energy airshowers. This detector is conceived as part of the surface array of the Pierre Auger Project, which is expected to be sensitive to ultra high energy cosmic rays. In this paper we focus our attention in the geometry of the tank and its inner liner material, discussing pulse shapes and charge collections.

¹ Fellow of the Consejo Nacional de Investigaciones Científicas y Técnicas, Argentina

² Permanent address: Department of Physics, University of South Carolina, SC 29208, USA

1 Introduction

Čerenkov light occurs when a charged particle passes through a transparent dielectric material with a velocity greater than the velocity of light in that material, thus producing a cone of electromagnetic radiation whose emission angle is related to the velocity of the particle. Particle detectors based on this effect are used in the examination of fast particles emitted from the atmosphere due to the passage of a high energy cosmic ray primary, giving rise to an extensive airshower. Such airshower might produce in turn Čerenkov light when traversing an appropriate medium. A further use is in particle physics mainly concerning with particle velocity or particle mass identification in experiments involving the scattering of light relativistic particles.

The detection of cosmic rays, which are known to reach the earth from all directions, has occupied scientists since their discovery at the beginning of this century. Of particular interest are the very high-energy cosmic rays[1] (in the range of 10^{15} to 10^{20} eV)[2]. Apart from present experiments, there are some projects, like the Pierre Auger Project[3] which focuses its interest in the very upper limit of this range of energies, having in mind the identification of the primaries and sources. The project aims at building two observatories, one in each hemisphere, over an area of 3 000 km² each, with atmospheric fluorescence and surface detectors.

A commonly used surface detector for such particles is a water tank[4], where the Čerenkov light produced by the impinging shower particles is registered by an array of photomultiplier tubes. The water tanks are simple, easy to maintain, require little electronics, and have a large sensitivity to showers at large zenith angles.

The purpose of such a tank is to measure the signal left by particles and separate (at least statistically), the muons from the electromagnetic contents of the shower based on the fact that the amount of Čerenkov light produced by a muon is different in average from that produced by either an electron or gamma ray, due to their difference in average kinetic energy (see [3, page 111], and bremsstrahlung. The tanks should produce similar signals for equivalent incoming particles, irrespective of their entrance angle and position on the lid, therefore giving as a constraint the need for a highly diffusing inner liner material for the tank.

This work presents the design, construction and operation of a water Čerenkov tank, the first built to scale 1:1, as a design model for the Pierre Auger Project. There are other prototypes of this sort currently in operation elsewhere[5,6]. In section 2 we describe the main features of the design which ends up in a versatile instrument. In section 3, the results from the different experiments

carried out in order to characterize the detector are presented. A discussion on the performance of the detector is given in section 4.

2 Mechanical Design and Experimental Setup

A schematic diagram of the detector is shown in Fig. 1. It is a cylindrical water tank 1.85 m tall and 10 m² surface area. The material of the wall, floor and lid is polished, non-magnetic 304 stainless steel with a thickness of 0.68 mm. All weldings were made in continuous electric fused seams, with no addition of solder material. The temperature was carefully controlled during welding to avoid modification of the chemical properties of the steel, for instance, resistance to rusting which would impair the water absorption length. Indeed, no signs of corrosion are observed either inside or outside the tank after 18 months of operation. The tank has a simple flat lid which can be easily removed and reinstalled by a single operator with the help of a small hand-driven hydraulic crane. After some trials, a good darkening condition was achieved by a double layer of black cloth ribbon installed around the border of the lid. The inner band is glued to the lid, the outer one is kept in place by means of two elastic cords. A conical plastic cover was installed over the tank to prevent rainwater accumulation on the lid, which may fall into the tank when opening. Panel feedthrough connectors were installed on the tank wall, about 10 cm over maximum water level in order to feed the HV to the photomultiplier tubes (PMT) and receive the detector signals.

The light emitted as Čerenkov radiation is detected by photomultiplier tubes: on reaching the photocathode, a Čerenkov photon might produce the ejection of an electron, thus called photoelectron. The maximum possible water depth is 1.6 m, which allows to completely enclose 8" Hamamatsu 1408 PMT's inside the tank. A flexible system composed of two fixed and two rotary aluminum holder bars permits positioning the tubes at different angles and at any radii, and also to independently vary their height. These features enable to use the instrument to check the results of simulations, for instance assuming different geometrical configurations for the detector. Three PMT's have been mounted vertically in the tank, with their photocathodes immersed in the water surface, looking down. Their operating voltages were 1260 V for PMT's 1 and 3, and 1300 V for PMT 2. This geometry was chosen because simulations (see [3, page 155]) indicate that positioning the PMT's at the bottom, looking up, would produce a highly anisotropic collection of light: particles entering the tank towards a PMT would generate Čerenkov photons, and those generated close to exiting the tank concentrate towards the tube. Although the number of photons per unit track is essentially constant, those produced on entrance will be spread over a large area on reaching the bottom, whereas those at the particle exit would reach the bottom close to the particle direction.

The water tank has been placed on a platform that allows positioning of plastic-scintillator counters under the tank, at any radius. Also counters were placed on the tank, so as to trigger events with coincidence signals between upper and lower counters and thus the muon trajectories are defined. Counter sizes are $23 \times 40 \text{ cm}^2$ (top counters), and $15 \times 15 \text{ cm}^2$ (bottom counters).

The inner surface of the tank was degreased, washed with water and mild detergent and rinsed abundantly with the same water quality to be used as detector material, obtained from a reverse osmosis water treatment plant. Water resistivity at the outlet of the plant was $250 \text{ k}\Omega \text{ cm}$ and after the filling hose it was reduced to about $200 \text{ k}\Omega \text{ cm}$. The purpose of using reverse osmosis water instead of resin-interchanged deionized water was to explore the adequacy of this type of water for its use in Auger's Čerenkov detectors in which preservation of the water transparency is required for a very long time. Obviously, the former type of treatment implies economic advantages over the latter.

A recirculation system, consisting of a 0.75 HP plastic body centrifugal pump and a $10 \mu\text{m}$ Micronite filter, was installed by the detector, connected by 3/4" black plastic hoses to diametrically opposite points in the tank wall, 10 cm above the bottom. The recirculation system is operated, in average, only one day per week and very little amount of material is usually retained in the filter. No additives of any type were added to the water.

An inner tank diffusive liner was placed in order to improve light collection uniformity for different incident muons. For such a purpose we installed a 0.1 mm thick Tyvek[7] material on both inner walls and tank floor. Details of tests of this liner will be shown in section 3.2. The Tyvek was supported by 3 aluminum rings pressing against the tank wall. At the tank bottom it was stretched over a circular aluminum structure which hangs from six nylon strings. In this way, by changing the vertical position of this Tyvek floor it is easy to simulate any desired effective water depth in the tank. Finally, a removable Tyvek disk with holes in the desired PMT's positions, was installed at the tank top by simply floating it on the water surface.

Pulses coming out from the PMT's anodes were carried to the acquisition room (15 m away from the tank), using RG213 low attenuation cables. We currently use a CAMAC charge-sensitive ADC (LeCroy 2249A), having a sensitivity of 0.25 pC/channel to record the output of each PMT. We have also acquired PMT wavefronts on a digital oscilloscope (Tektronix THS 720) of 500 MSPS.

3 Measurements and Experimental Results

The current detector measures Čerenkov photons with wave lengths ranging from 300 to 600 nm, due to the PMT quantum efficiency bandwidth. Photons might undergo three kinds of interactions in the tank, mainly with the electrons of the medium[8]: i) elastic Rayleigh scattering, ii) absorption, or iii) medium boundary interactions. Elastic scattering, although not negligible, is less important than absorption. For instance, at $\lambda = 350$ nm the absorption length is 21 m while the scattering length is 97 m for the clearest waters [9]. Moreover, after being scattered the light would still be present in the tank, whereas it disappears after absorption.

3.1 PMT's Calibration

In order to characterize and optimize the response of this Čerenkov detector a series of measurements has been performed. Since our key interest is to study both pulse shape and number of photoelectrons, a calibration of the phototubes was required. This calibration is done measuring the single photoelectron spectrum of the PMT's, that is, the spectrum of the charge collection at the PMT anode by events in which a single photoelectron was emitted by the cathode.

Therefore, to ensure single-electron detection, the photocathodes were covered with aluminium foils with a ≈ 1 cm² hole since it was experimentally observed that under this condition 90 % of the events showed no signal output from the phototubes. The remaining 10 % of the events are accompanied by one or more photoelectrons, being of course the probability of a single photoelectron the largest one. This was experimentally checked during the course of this calibration.

The mean anode charges from a single photoelectron for each of the three PMT's were 3.2, 2.5 and 2.2 pC, with an estimated error of 1 channel (0.25 pC). With these values, the number of photoelectrons in an actual experiment with the PMT's fully uncovered (ie. without aluminium foils) is just the ratio of the collected charge to the latter numbers. An example of the response of the PMT's in a real experiment is shown in Fig. 2 where the mean values of the collected charge were 145, 64, and 97 pC. These charges correspond to a mean number of photoelectrons of 45, 26, and 44.

A thorough check of the present calibration would be to reproduce the shape of the fully uncovered-PMT spectra by means of the obtained single photoelectron spectra and of simulated Čerenkov photons. For this purpose we developed the following method of combining experimental and simulated re-

sults. We simulated the Čerenkov photons produced by the passage of vertical central muons which fully traverse the tank. The Čerenkov photons were created by Montecarlo calculations with the computer code GEANT [10]. Since both the water absorption length and angular distribution of the reflected light from the tank surface are not experimentally known, these photons were not tracked through the tank. It seems more appropriate to assume that the number of photoelectrons emitted at the PMT's follows a Poisson distribution for any given number of Čerenkov photons produced, with its mean value given by the experiment.

From the generated Čerenkov photons distribution, we randomly choose a number of photons, and then, from the Poisson distribution we again randomly obtain the number of photoelectrons. Finally, using the experimental data of the anode charge produced by this given number of photoelectrons, a theoretical histogram of simulated charge distribution was generated (see solid line in Fig. 2). In short, this is a three step process: i) a given number of generated photons is chosen at random from the GEANT spectrum, ii) a Poisson distribution is assumed centered at the experimental value of produced photoelectrons multiplied by the ratio of the number of photons chosen in i) and the mean value of the GEANT distribution, and then a given number of generated photoelectrons is randomly chosen from this distribution, iii) each of these photoelectrons undergo a random sampling of the single photoelectron spectra. It is worth mentioning that the number of simulated muons is the same as the number of experimentally detected events, thus no free parameters enter in this calculation. The mean value of this calculation is expected to coincide with data due to the way the Poisson distributions were produced and as such there is an overall normalization. Still, it is emphasized the good shape agreement to the data which justifies the three processes assumed.

A second method to evaluate the number of photoelectrons has also been used. It is based on the fact that the charge spectrum width is related to the number of photoelectrons in the PMT. This stems from the three random processes mentioned above since the observed width can be estimated by adding in quadrature the width of these three distributions[11], which after some algebra yields:

$$\left(\frac{\sigma}{mean}\right)_{exp}^2 = \frac{1.5}{\langle PE \rangle} + 0.093^2$$

where $\langle PE \rangle$ is the mean number of photoelectrons.

This method has the quite important advantage over the previous one that is independent of the experimental setup like PMT gain, although its uncertainties (20%) are larger than in the more conventional approach (10%). Both

methods predict consistent results. It is also noted that this consistency even applies for the PMT which has the reduced number of photoelectrons.

3.2 Characterization Studies

Several studies were carried out in order to characterize the detector: a comparison between stainless steel and Tyvek liner, an optimization of the position of the PMT's at the detector top and of the tank depth, and a comparison between black and Tyvek tops.

One key detector design issue is whether there is a need for a liner material, covering the inner part of the tank. Therefore, we performed two sets of relative measurements using a blue-LED light source, whose emission was limited by an opaque shade to a 45° cone: firstly with the bare polished stainless steel surfaces and secondly with the Tyvek liner. The LED was pointing downwards, placed at the water surface, 1.5 m above the bottom of the tank. The results are shown in Fig. 3, where the collected light intensity is plotted as a function of the radial PMT's position. The peak appearing in the stainless steel data is interpreted as a geometrical effect of the specular reflection of the light, which concentrates there due to the cylindrical shape of the wall. This effect is similar to the caustic curve observed in optics and can easily be accounted for by simulations as shown in ref. [12]. As can be seen in the figure the use of the Tyvek liner dramatically uniformizes light collection. Curves a) and b) have different normalization since the aim of this experiment was to study solely the uniformity of light. Nevertheless, the parameter of interest for the normalization is the percent reflectance which ranges from 38 to 54 % and from 70 to 90 % for stainless steel and Tyvek, respectively for the bandwidth 300-600 nm[13].

In this work we are also interested in the optimization of the radial position of the PMT's on the upper lid and the tank depth. Regarding the former, the main purpose was to find a PMT arrangement such that the Čerenkov light collection would be as independent as possible of the particles entrance position. The obvious symmetry of the tank prescribes that the three PMT's should be 120° apart. We selected 7 vertical muon entrance positions by making use of the scintillator counters (see Fig. 4): one at the central point, three at $r = 80$ cm and three at $r = 160$ cm, at 0° , 30° , and 60° , from a PMT. The PMT's were setup at radii 80, 120, and 160 cm, therefore, allowing the collection of data for 21 experimental setups. The effective tank depth was 1.20 m. The results of these measurements are summarized in Table I. Regarding the position of the PMT's two issues are to be taken into account: the total charge collection and its uniformity, ie. the mean value and its dispersion. It can be seen that the greater charge collection is obtained with the PMT's at

80 cm, and that the charge collection uniformity does not significantly vary within the experimental errors for any fixed PMT radial position.

Apart from optimizing the PMT's position on the horizontal plane, this versatile prototype permits to vary the effective depth of the water by raising the Tyvek floor. There is a compromise between tank depth and track length. Indeed deeper tanks would augment the number of Čerenkov photons for vertical traversing particles but on the other side would increase the average track length (ie. more absorption) for reaching a PMT. Therefore the optimum depth has to be experimentally found. Different measurements have been performed with water depths, ranging from 30 to 150 cm, with muons vertically entering through the tank centre (see Fig. 5). It is apparent from the figure that there is a continuous rise in the number of photoelectrons as a function of the water depth. A comparison should also include electromagnetic particles which are mostly stopped in the tank in actual experimental conditions. This can not readily be done with an experimental setup consisting in a single prototype since no trigger would be available. Some simulations were performed[14] for vertical particles and, as expected, electrons (and gamma's after conversion) in average produce smaller signals with tank depth due to absorption and to the fact they cannot benefit with a longer track because of their lower mean kinetic energy and bremsstrahlung. As such, there is a tendency to separate better muons from electromagnetic particles.

We also performed a signal study with either a Tyvek or a black top. An illustration of pulse shapes, averaged over 200 events, is presented in Fig. 6, for a single PMT. In full line a typical mean pulse is shown: it has a very short rise time (≈ 10 ns) and a longer decay time. Such a rise short time would probably arise from Čerenkov photons reflecting from the floor or hitting the wall one extra time before reaching the PMT. The decay time corresponds to light traversing the tank several times. For example, since the light speed in water is 22.5 cm/ns, a photon arriving 200 ns later would have had a total track inside the tank of 45 m. Drawn in dotted line is the mean pulse corresponding to a black top condition, ie replacing the Tyvek floating top by a black polyethylene foil. As expected, the pulse amplitude is essentially the same since it should have no contribution from light bouncing off the top. However, the decay time, and therefore the charge collection, is greatly diminished. The decay times, extracted from an exponential fit to the tail of the spectra (also shown in the figure), are 11 and 39 ns, whereas mean charges are 49 and 112 pC for black and Tyvek tops, respectively (note that the estimate of the ratio of photoelectrons from these two numbers, 2.29, is in agreement within errors to the ratio obtained from the width of the distributions, 2.26, as obtained from the formulae of section 3.1). There appears to be a compromise between shorter decay times and larger charge collection but the reduction in charge for energetic muons is of lesser significance since the amplitude of the pulse does not change and therefore no signals are lost merged in the background.

The charge collected, normalized by the mean values, are quite similar as appreciated in Fig.7. The peaks are essentially the same, just being the black top one slightly wider, due to the reduced number of photoelectrons collected.

4 Conclusions

We have undertaken an experimental study of different design parameters of a typical water Čerenkov tank, as those to be used as surface detectors of the Pierre Auger Project.

The most important design consideration of this model detector is its flexibility to adapt to a variety of experiments, since it has a lid that permits to install new equipment and to easily change the arrangement of the PMT's in the tank and the effective detector depth.

Airshower Čerenkov detectors should have little light absorption and have similar responses for different entrance positions of particles to the tank. In this work we have experimentally shown that the Tyvek liner material much better complies with the uniformity requirement than stainless steel, at least for blue-LED light. Further to this, it was shown for vertical muons that the Tyvek response guarantees uniformity, and therefore different placements of the PMT's on the detector top would yield similar performances. This is not necessarily the case for the dependence of charge collection on PMT's radial position. We have also shown that deeper tank depth will produce larger electronic signals for energetic muons. It is always better to have bigger tanks not only for the above-mentioned reason but also for the larger solid angle coverage of the sky (a larger tank, however, would increase costs and manufacturing difficulties).

It is worth mentioning, that our conclusion on a more preferable deeper tank stems from the large total absorption length relative to the tank depth due to the water purity (20-30 m of average absorption coefficient in our tank) and for the large value of the Tyvek reflection coefficient.

Another consideration is related to pulse shapes, ie decay time and charge collection. The black top experiment gave a dramatic difference in these two items: decay lengths of 11 and 39 ns and charge collections of 49 and 112 pC for black and Tyvek tops, respectively. But, since the experimental pulse amplitudes do not vary, no extra black-top collected pulses are lost in the background.

We are grateful to Dr. C. Hojvat for his contributions with the CAMAC electronics. We also thank A. Boschan and J.I. Franqueiro for their collaboration during part of the measurements and J. Vidallé and J. Fernández Vásquez for

their help.

References

- [1] D.J. Bird *et al.*, Phys. Rev. Lett. **71** (1993) 3401; N. Hayashida *et al.*, Phys. Rev. Lett. **73** (1994) 3491.
- [2] M. Aglietta *et al.* (EAS-TOP Collaboration), Nucl. Instr. and Meth. **A336** (1993) 310.
- [3] The Pierre Auger Project. Design Report, November 1996.
- [4] M.A. Lawrence, R.J.O. Reid, and A.A. Watson. J. Phys. **G17** (1991) 733.
- [5] N. Sakaki and M. Nagano, Proc. Int. Symp. on Extremely High Energy Cosmic Rays: Astrophysics and Future Observatories, Tokyo, (Sep. 1996), ed. M. Nagano, ICRR, pp. 402–406.
- [6] D. Ravnigani and C. Hojvat, Auger Technical Note, GAP–96–033, FNAL (1996).
- [7] Spunbonded Olefin Film, Du Pont, Wilmington, Delaware, USA.
- [8] Review of Particle Properties, Phys. Rev. **D54** (1996) 1.
- [9] R.C. Smith and K.S. Baker. Applied Optics 20 (1981) 177.
- [10] CERN Program Library, GEANT - Detector Description and Simulation Tool, October 1994.
- [11] C. Pryke, private communication; C. Pryke and T. Kutter, Auger Technical Note, GAP–96–041, FNAL (1996); D. Ravnigani *et al.*, Auger Technical Note, GAP–97–024, FNAL (1997).
- [12] A. Etchegoyen *et al.*, presented by A. Filevich. Proc. Int. Symp. on Extremely High Energy Cosmic Rays: Astrophysics and Future Observatories, Tokyo, (Sep. 1996), ed. M. Nagano, ICRR, pp. 296–309; also in Auger Technical Note, GAP–96–040, FNAL (1996).
- [13] *Directional Reflectance Measurements on Two Special Sample Materials*. SOC-R950-001-0195. Surface Optics Corporation, P.O.Box 261602, San Diego, California, USA, (1995).
- [14] P. Bauleo *et al.*, Auger Technical Note, GAP–96–029, FNAL (1996).

Information: Auger Technical Notes are available through anonymous ftp at <ftp://fnst38.fnal.gov/Auger> .

Tables

Table I: Ratio of mean charge collected over the three PMT's to the respective value for vertical central muons with PMT's placed at 120 cm.

Entering Position	PMT's position		
	80 cm	120 cm	160 cm
R = 0 cm $\theta = 0^\circ$	1.31	0.92	0.63
R = 80 cm $\theta = 0^\circ$	1.27	0.95	0.72
R = 80 cm $\theta = 30^\circ$	1.06	0.95	0.79
R = 80 cm $\theta = 60^\circ$	1.35	1.05	
R = 160 cm $\theta = 0^\circ$	1.05	0.99	0.71
R = 160 cm $\theta = 30^\circ$	1.20	1.02	0.60
R = 160 cm $\theta = 60^\circ$	1.05	0.86	0.69
Mean Value	1.2	0.96	0.69
Dispersion	0.1	0.06	0.06

Note that the normalization experiment was done with a different set of measurements yielding a ratio of 0.92 rather than 1.0.

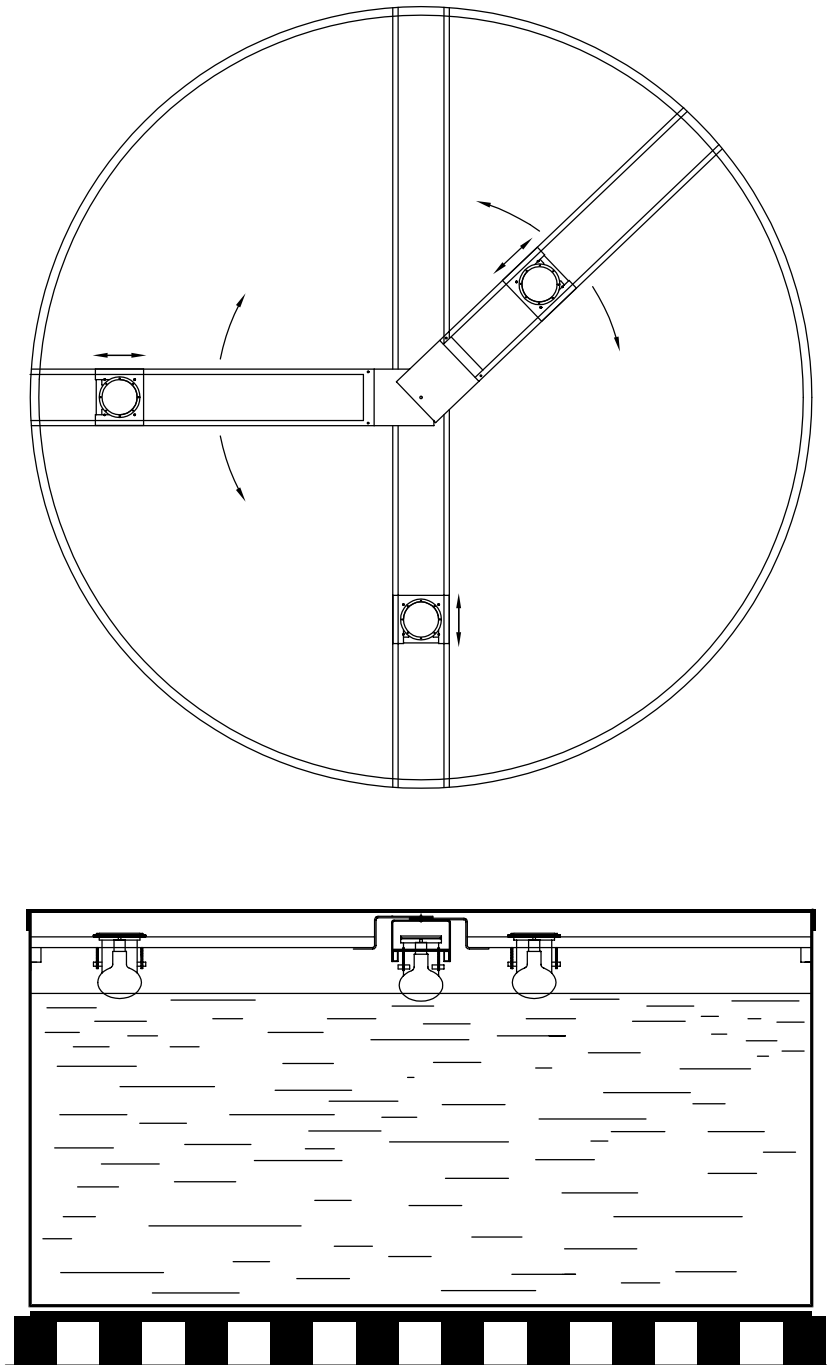

Fig. 1. a) Top view of the PMT's holders. The arrows indicate possible movements of the two rotatable arms and radial displacements of the PMT's, which can therefore be placed in any desirable geometrical arrangement; b) Side view of the tank. Actual dimensions are $10 \text{ m}^2 \times 1.85$ and the maximum attainable water depth is 1.6 m.

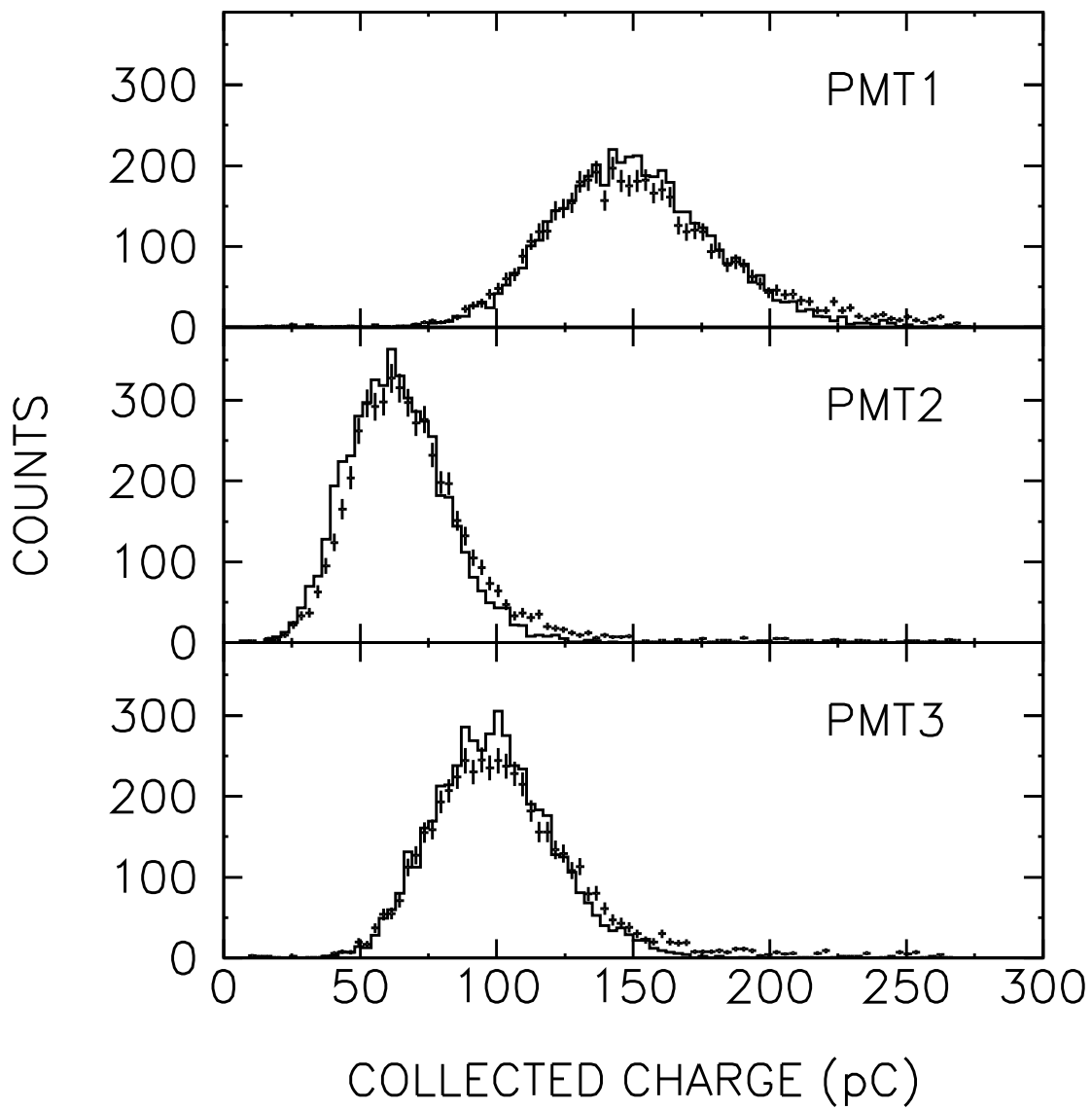

Fig. 2. Mean charge collected for central muons for each PMT. The dotted line corresponds to a simulated peak using the obtained single photoelectron charge collection.

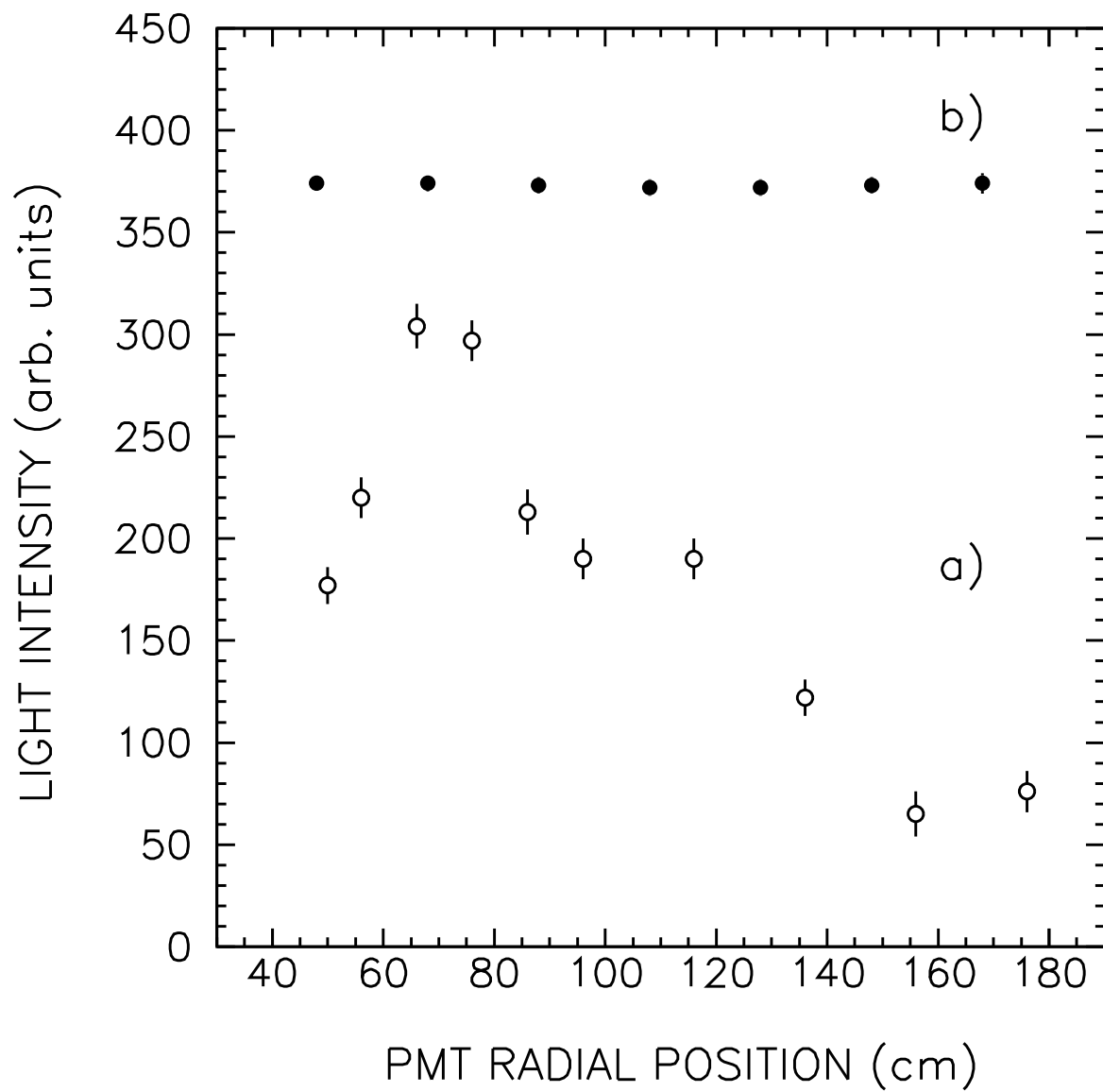

Fig. 3. Charge collected in a PMT due to a LED-light source vs. radial PMT position; a) with stainless steel walls, b) with Tyvek liner. The arbitrary units are different for plots a) and b) since the experimental normalizations are different.

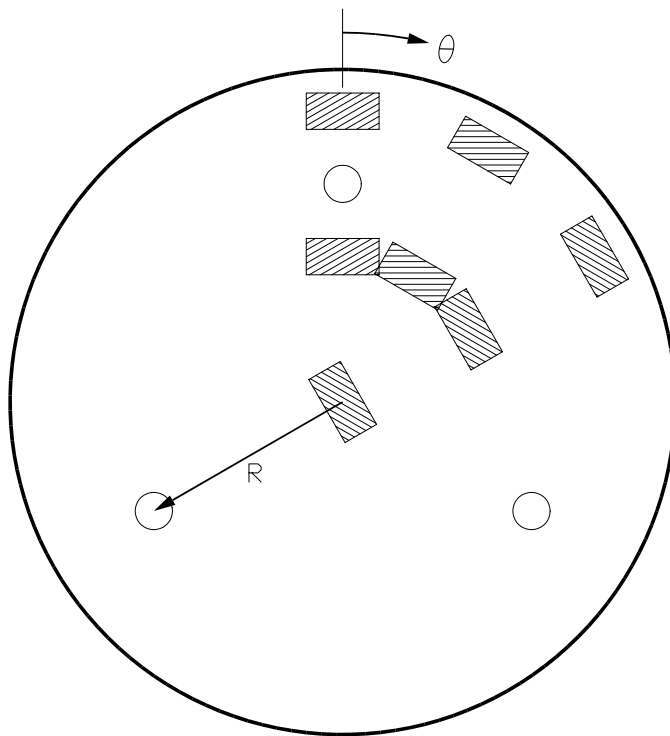

Fig. 4. Setup for charge-collection amount and uniformity measurements for vertical muons. In dashed rectangles are shown the 7 counter positions, both upper and lower, and in open circles one of the PMT locations. The drawing is to scale with PMT's and upper counters.

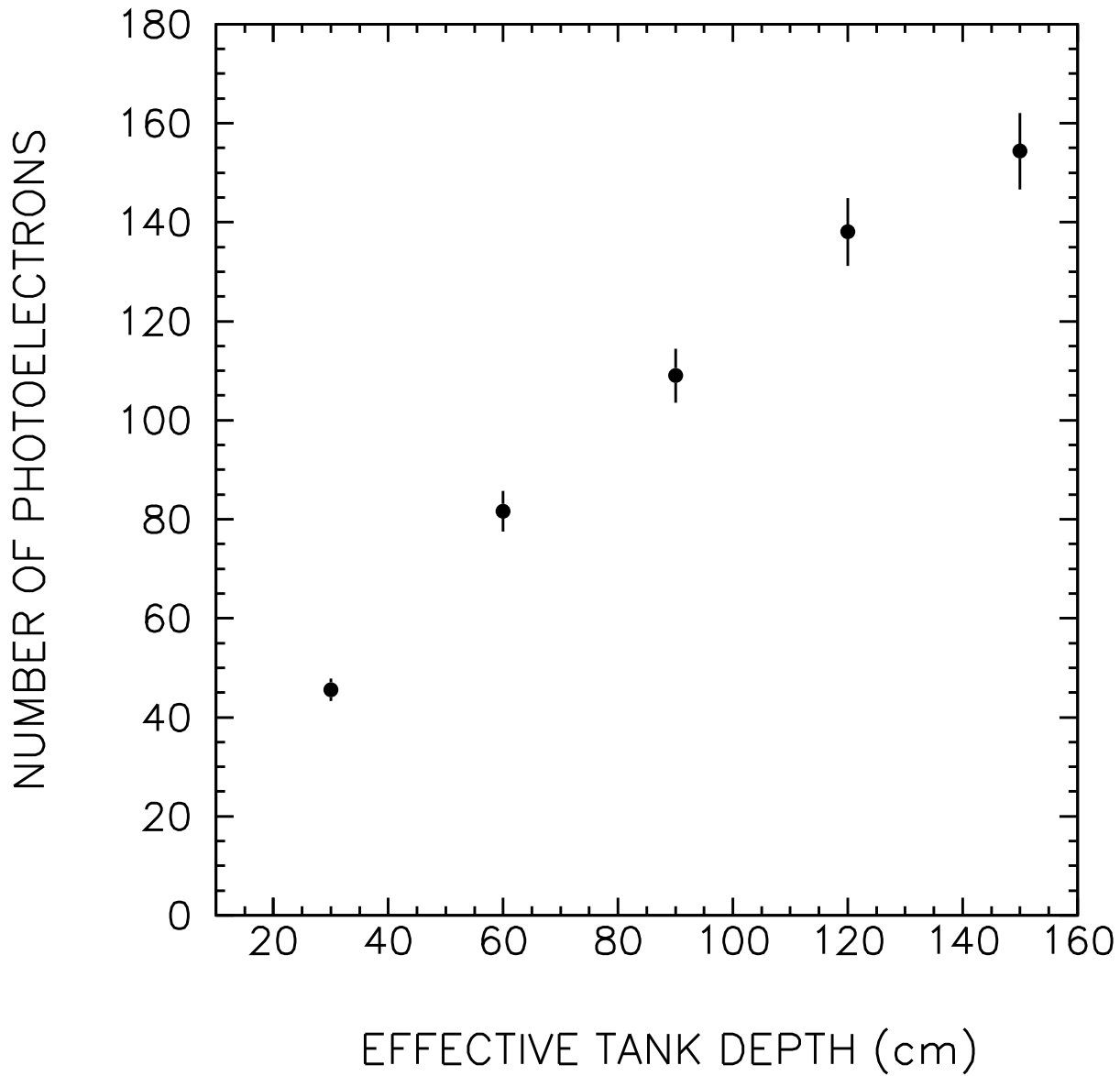

Fig. 5. Number of photoelectrons as a function of the effective tank depth. The photoelectrons correspond to the sum over the three PMT's, which were located at $R = 120$ cm.

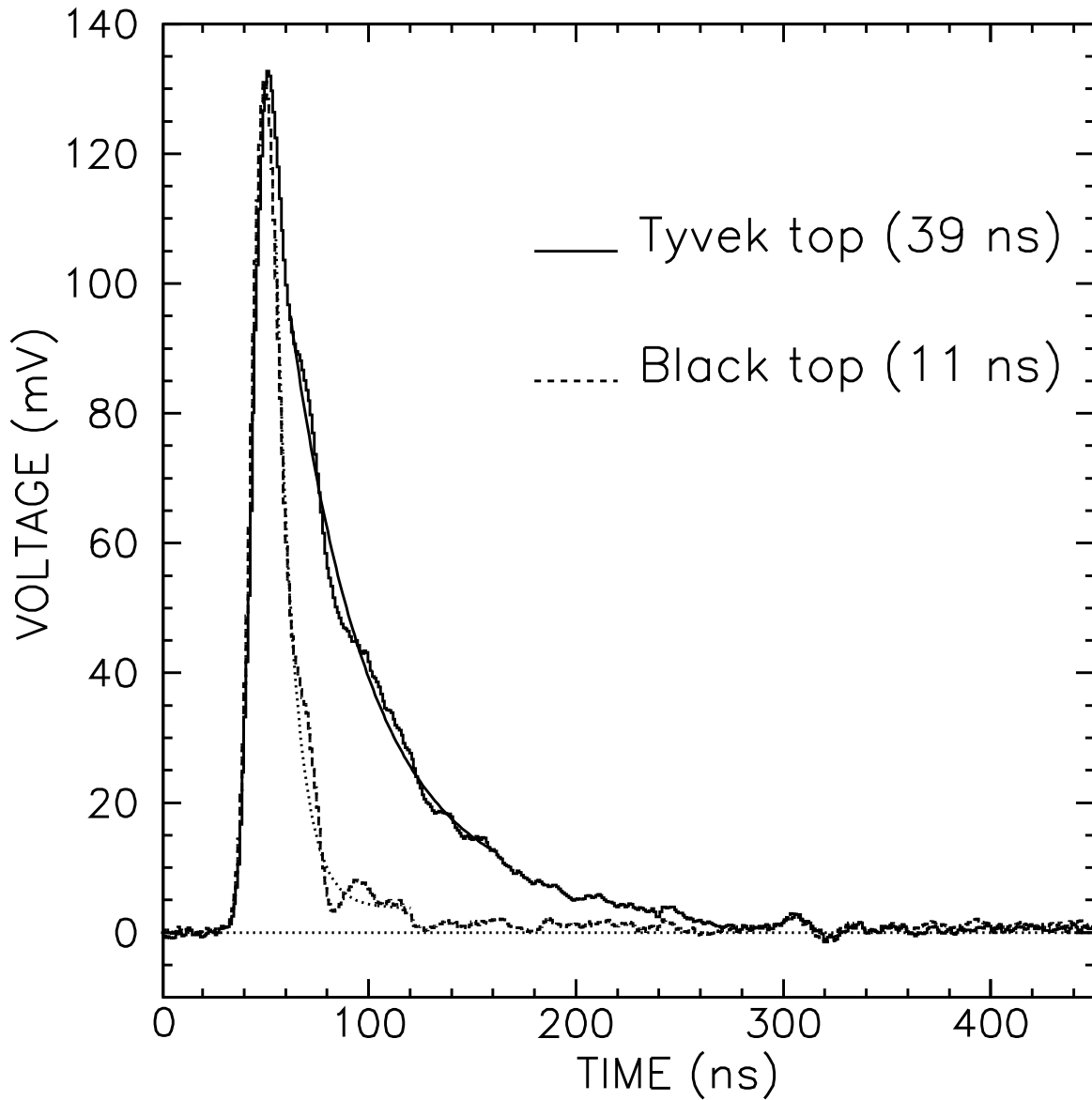

Fig. 6. Average pulse shapes for a single PMT. The full line histogram corresponds to a fully covered inner tank with Tyvek liner whereas the dotted line histogram to a black liner top. Also shown are exponential fits to the decay times.

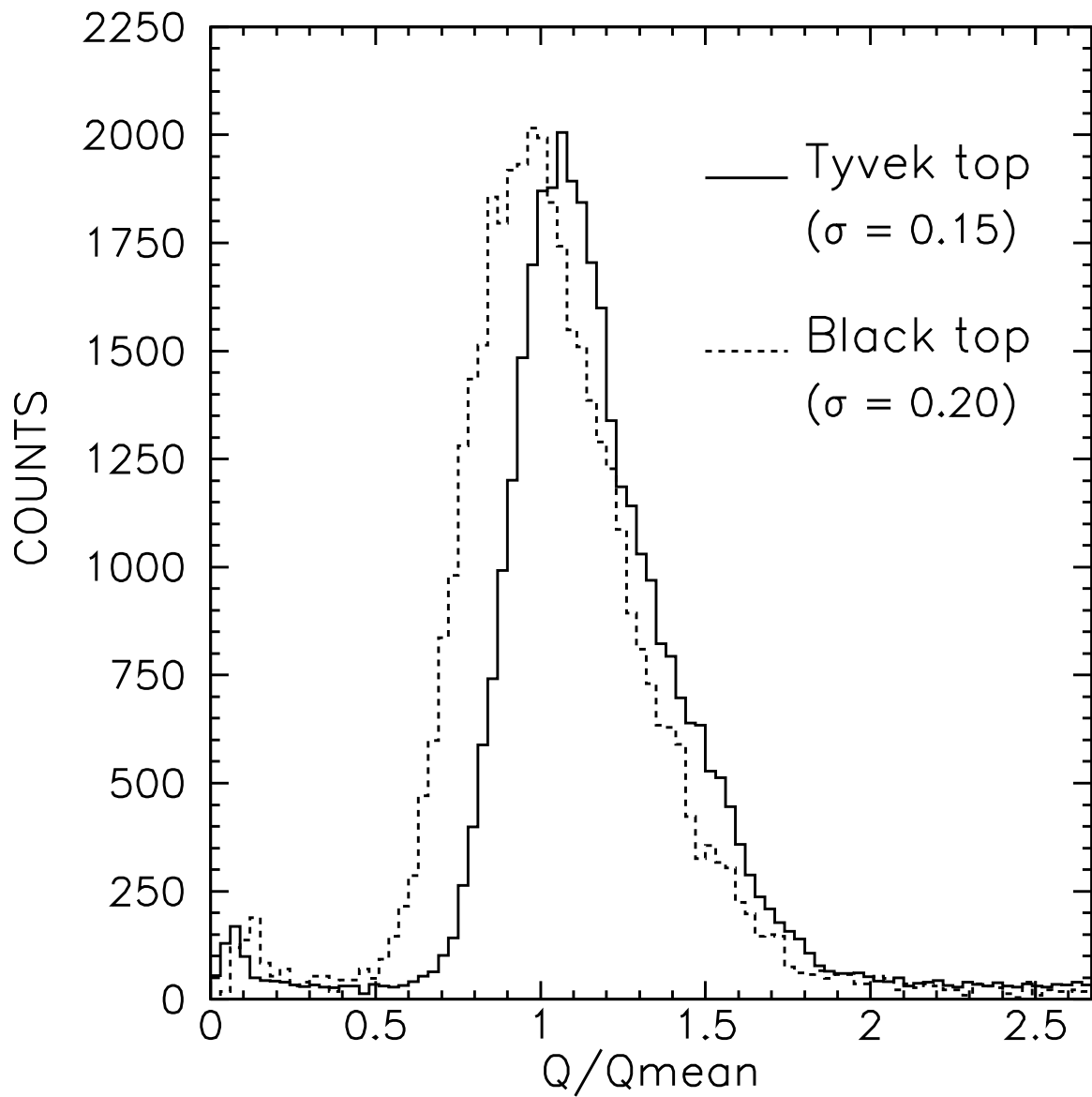

Fig. 7. Total charge collected for a single PMT, normalized to its mean value. Full and dotted line histograms correspond to Tyvek and black tops, respectively. The sigma values were obtained from a gaussian fit precluding the right-hand-side non-gaussian tail.