

Perspectives of Double Beta and Dark Matter Search as Windows to New Physics

H.V. Klapdor-Kleingrothaus

† Max-Planck-Institut für Kernphysik
P.O.Box 10 39 80, D-69029 Heidelberg, Germany

Abstract. Nuclear double beta decay provides an extraordinarily broad potential to search for beyond Standard Model physics, probing already now the TeV scale, on which new physics should manifest itself. These possibilities are reviewed here. First, the results of present generation experiments are presented. The most sensitive one of them – the Heidelberg-Moscow experiment in the Gran Sasso – probes the electron mass now in the sub eV region and has reached recently a limit of ~ 0.1 eV. This limit has striking influence on presently discussed neutrino mass scenarios. Basing to a large extent on the theoretical work of the Heidelberg Double Beta Group in the last two years, results are obtained also for SUSY models (R-parity breaking, sneutrino mass), leptoquarks (leptoquark-Higgs coupling), compositeness, right-handed W boson mass, test of special relativity and equivalence principle in the neutrino sector and others. These results are comfortably competitive to corresponding results from high-energy accelerators like TEVATRON, HERA, etc. One of the enriched ^{76}Ge detectors also yields the most stringent limits for cold dark matter (WIMPs) to date by using raw data. Second, future perspectives of $\beta\beta$ research are discussed. A new Heidelberg experimental proposal (GENIUS) will allow to increase the sensitivity for Majorana neutrino masses from the present level of at best 0.1 eV down to 0.01 or even 0.001 eV. Its physical potential would be a breakthrough into the multi-TeV range for many beyond standard models. Its sensitivity for neutrino oscillation parameters would be larger than of all present terrestrial neutrino oscillation experiments and of those planned for the future. It could probe directly the large angle, and for almost

degenerate neutrino mass scenarios even the small angle solution of the solar neutrino problem. It would further, already in a first step using only 100 kg of natural Ge detectors, cover almost the full MSSM parameter space for prediction of neutralinos as cold dark matter, making the experiment competitive to LHC in the search for supersymmetry. Finally GENIUS could be used as the first real time detector of solar pp neutrinos.

1. Introduction – Motivation for the search for double beta decay – and a future perspective: GENIUS

Double beta decay yields – besides proton decay – the most promising possibilities to probe beyond standard model physics beyond accelerator energy scales.

The potential of double beta decay includes information on the neutrino and sneutrino mass, SUSY models, compositeness, leptoquarks, right-handed W bosons, Lorentz invariance and the equivalence principle in the neutrino sector, and others [Kla99a]. The recent results of the Heidelberg–Moscow experiment, which will be reported here (see also [Kla98a, Kla98b]), have demonstrated that $0\nu\beta\beta$ decay probes already now the TeV scale on which new physics should manifest itself according to present theoretical expectations.

To increase by a major step the present sensitivity for double beta decay and dark matter search, we describe here a new project proposed recently [Kla98a, Kla98b] which would operate one ton of ‘naked’ enriched **GER**manium detectors in liquid **NI**trogen as shielding in an **U**nderground **S**etup (GENIUS). GENIUS would definitely be a breakthrough into the multi-TeV range for many beyond standard models currently discussed in the literature, and the sensitivity would be comparable or even superior to LHC for various quantities such as right-handed W -bosons, R -parity violation, leptoquark or compositeness searches.

Another issue of GENIUS is the search for Dark Matter in the universe. The full MSSM parameter space for predictions of neutralinos as cold dark matter could be covered already in a first step of the full experiment using only 100 kg of ^{76}Ge or even natural Ge, making the experiment competitive to LHC in the search for supersymmetry.

Finally GENIUS could be used as the first real time detector of solar pp neutrinos.

2. Double beta decay and particle physics

We present a brief introductory outline of the potential of $\beta\beta$ decay for some representative examples. The potential of double beta decay for probing neutrino oscillation parameters will be addressed in section 4.2.

Double beta decay can occur in several decay modes

$${}^A_Z X \rightarrow {}^A_{Z+2} X + 2e^- + 2\bar{\nu}_e \quad (1)$$

$${}^A_Z X \rightarrow {}^A_{Z+2} X + 2e^- \quad (2)$$

$${}^A_Z X \rightarrow {}^A_{Z+2} X + 2e^- + \phi \quad (3)$$

$${}^A_Z X \rightarrow {}^A_{Z+2} X + 2e^- + 2\phi \quad (4)$$

the last three of them violating lepton number conservation by $\Delta L = 2$. For the neutrinoless mode (2) we expect a sharp line at $E = Q_{\beta\beta}$, for the two-neutrino mode and the various Majoron-accompanied modes classified by their spectral index, continuous spectra. Important for particle physics are the decay modes (2)–(4).

The neutrinoless mode (2) needs not be necessarily connected with the exchange of a virtual neutrino or sneutrino. *Any* process violating lepton number can in principle lead to a process with the same signature as usual $0\nu\beta\beta$ decay. It may be triggered by exchange of neutralinos, gluinos, squarks, sleptons, leptoquarks,... (see below and [Kla98b, Päs97, Päs99]). This gives rise to the broad potential of double beta decay for testing or yielding restrictions on quantities of beyond standard model physics, realized and investigated to a large extent by the Heidelberg Double Beta Group in the last two years. There is, however, a generic relation between the amplitude of $0\nu\beta\beta$ decay and the $(B - L)$ violating Majorana mass of the neutrino. It has been recognized about 15 years ago [Sch81] that if any of these two quantities vanishes, the other one vanishes, too, and vice versa, if one of them is non-zero, the other one also differs from zero. This Schechter-Valle-theorem is valid for any gauge model with spontaneously broken symmetry at the weak scale, independent of the mechanism of $0\nu\beta\beta$ decay. A generalisation of this theorem to supersymmetry has been given recently [Hir97a, Hir98b]. This Hirsch-Klapdor-Kleingrothaus-Kovalenko-theorem claims for the neutrino Majorana mass, the $B - L$ violating mass of the sneutrino and neutrinoless double beta decay amplitude: If one of them is non-zero, also the others are non-zero and vice versa, independent of the mechanisms of $0\nu\beta\beta$ decay and (s-)neutrino mass generation. This theorem connects double beta research with new processes potentially observable at future colliders like NLC (next linear collider) [Hir97a, Hir98a].

2.1. Mass of the (electron) neutrino

Neutrino physics has entered an era of new actuality in connection with several possible indications of physics beyond the standard model (SM) of particle physics: A lack of solar (${}^7\text{Be}$) neutrinos, an atmospheric ν_μ deficit and mixed dark matter models could all be explained simultaneously by non-vanishing neutrino masses. Recent GUT models, for example an extended $\text{SO}(10)$ scenario with S_4 horizontal symmetry could explain these observations by requiring degenerate neutrino masses of the order of 1 eV [Lee94, Moh94, Pet94, Ioa94, Fri95, Moh95] [Pet96, Val96]. For an overview see [Smi96, Moh97a].

This brings double beta decay experiments into some key position, since with some second generation $\beta\beta$ experiments like the HEIDELBERG–MOSCOW experiment the predictions of or assumptions in such scenarios can now be tested (see section 3.2). If the above scenario of neutrino mass textures is ruled out by tightening the double beta limit on m_{ν_e} , then a way to understand *all* neutrino results may require an additional sterile neutrino [Cal93, Pel93, Moh97a]. Then the solar neutrino puzzle could be explained by the $\nu_e - \nu_S$ oscillation, and atmospheric neutrino data by $\nu_\mu - \nu_\tau$ oscillations, and the $\nu_{\mu,\tau}$ would constitute the hot dark matter (HDM) of the universe. The request for a light sterile neutrino would naturally lead to the concept of a shadow world [Ber95]. The expectation for the effective neutrino mass (see below) to be seen in double beta decay would be $\langle m_{\nu_e} \rangle \simeq 0.002\text{eV}$ [Moh97b]. Thus it could be checked by the new Genius project (see section 4.2.2).

Neutrinoless double beta decay can be triggered by exchange of a light or heavy left-handed Majorana neutrino. For exchange of a heavy *right*-handed neutrino see section 2.3. The propagators in the first and second case show a different m_ν dependence: Fermion propagator $\sim \frac{m}{q^2 - m^2} \Rightarrow$

$$a) \quad m \ll q \rightarrow \sim m \quad \text{'light' neutrino} \quad (5)$$

$$b) \quad m \gg q \rightarrow \sim \frac{1}{m} \quad \text{'heavy' neutrino} \quad (6)$$

The half-life for $0\nu\beta\beta$ decay induced by exchange of a light neutrino is given by [Mut88]

$$\begin{aligned} [T_{1/2}^{0\nu}(0_i^+ \rightarrow 0_f^+)]^{-1} &= C_{mm} \frac{\langle m_\nu \rangle^2}{m_e^2} + C_{\eta\eta} \langle \eta \rangle^2 + C_{\lambda\lambda} \langle \lambda \rangle^2 + C_{m\eta} \frac{m_\nu}{m_e} \\ &+ C_{m\lambda} \langle \lambda \rangle \frac{\langle m_\nu \rangle}{m_e} + C_{\eta\lambda} \langle \eta \rangle \langle \lambda \rangle \end{aligned} \quad (7)$$

or, when neglecting the effect of right-handed weak currents, by

$$[T_{1/2}^{0\nu}(0_i^+ \rightarrow 0_f^+)]^{-1} = C_{mm} \frac{\langle m_\nu \rangle^2}{m_e^2} = (M_{GT}^{0\nu} - M_F^{0\nu})^2 G_1 \frac{\langle m_\nu \rangle^2}{m_e^2} \quad (8)$$

where G_1 denotes the phase space integral, $\langle m_\nu \rangle$ denotes an effective neutrino mass

$$\langle m_\nu \rangle = \sum_i m_i U_{ei}^2, \quad (9)$$

respecting the possibility of the electron neutrino to be a mixed state (mass matrix not diagonal in the flavor space)

$$|\nu_e\rangle = \sum_i U_{ei} |\nu_i\rangle \quad (10)$$

The effective mass $\langle m_\nu \rangle$ could be smaller than m_i for all i for appropriate CP phases of the mixing coefficients U_{ei} [Wol81]. In general not too pathological GUT models yield $m_{\nu_e} = \langle m_{\nu_e} \rangle$ (see [Lan88]).

η, λ describe an admixture of right-handed weak currents, and $M^{0\nu} \equiv M_{GT}^{0\nu} - M_F^{0\nu}$ denote nuclear matrix elements.

Nuclear matrix elements:

A detailed discussion of $\beta\beta$ matrix elements for neutrino induced transitions including the substantial (well-understood) differences in the precision with which 2ν and $0\nu\beta\beta$ rates can be calculated, can be found in [Gro90, Mut88, Mut89] [Sta90, Kla98a, Kla98b].

2.2. Supersymmetry

Supersymmetry (SUSY) is considered as prime candidate for a theory beyond the standard model, which could overcome some of the most puzzling questions of today's particle physics (see, e.g. [Hab93, Moh92, Kan97]). Generally one can add the following R-parity violating terms to the usual superpotential [Hal84].

$$W_{R_P} = \lambda_{ijk} L_i L_j \bar{E}_k + \lambda'_{ijk} L_i Q_j \bar{D}_k + \lambda'' \bar{U}_i \bar{D}_j \bar{D}_k, \quad (11)$$

where indices i, j, k denote generations. L, Q denote lepton and quark doublet superfields and $\bar{E}, \bar{U}, \bar{D}$ lepton and up, down quark singlet superfields. Terms proportional to λ, λ' violate lepton number, those proportional to λ'' violate baryon number. From proton decay limits it is clear that both types of terms cannot be present at the same time in the superpotential. On the other hand, once the λ'' terms being assumed to be zero, λ and λ' terms are not limited. $0\nu\beta\beta$ decay can occur within the R_p MSSM through Feynman graphs such as those of Fig. 1. In lowest order there are altogether six different graphs of this kind. [Hir95a, Hir95b, Hir96c]. Thus $0\nu\beta\beta$ decay can be used to restrict R-parity violating SUSY models

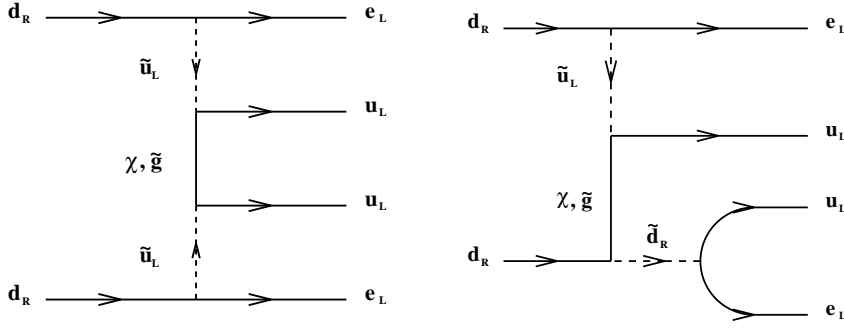

Fig. 1 Examples of Feynman graphs for $0\nu\beta\beta$ decay within R -parity violating supersymmetric models (from [Hir95a]).

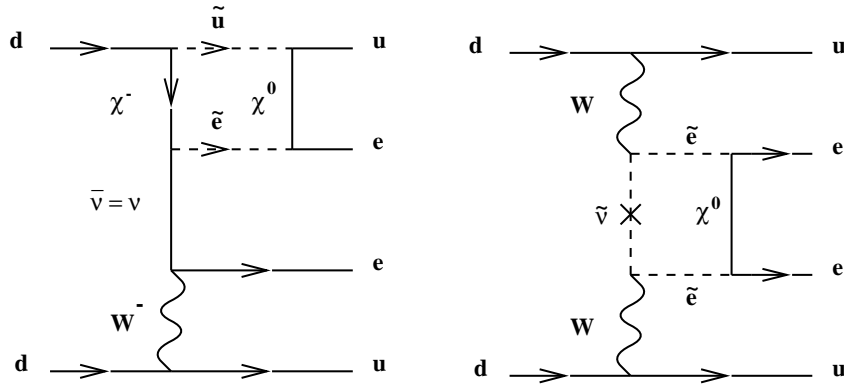

Fig. 2 Examples of R_P conserving SUSY contributions to $0\nu\beta\beta$ decay (from [Hir97a]).

[Hir95a, Hir96d, Moh91, Hir95b, Moh86a]. From these graphs one derives [Hir95a] under some assumptions

$$[T_{1/2}^{0\nu}(0^+ \rightarrow 0^+)]^{-1} \sim G_{01} \left(\frac{\lambda_{111}^{\prime 2}}{m_{\tilde{q},\tilde{e}}^4 m_{\tilde{g}\chi}} \right) M^2 \quad (12)$$

where G_{01} is a phase space factor, $m_{\tilde{q}\tilde{e}\tilde{g}\chi}$ are the masses of supersymmetric particles involved: squarks, selectrons, gluinos, or neutralinos. λ'_{111} is the strength of an R -parity breaking interaction (eq. 11), and M is a nuclear matrix element. For the matrix elements and their calculation see [Hir96d].

It is also worthwhile to notice that $0\nu\beta\beta$ decay is not only sensitive to λ'_{111} . Taking into account the fact that the SUSY partners of the left and right-handed quark states can mix with each other, one can derive limits

on different combinations of λ' [Hir96a, Moh96b, Bab95]. The dominant diagram of this type is the one where the exchanged scalar particles are the $\tilde{b} - \tilde{b}^C$ pair. Under some assumptions (e.g. the MSSM mass parameters to be approximately equal to the “effective” SUSY breaking scale Λ_{SUSY}), one obtains [Hir96a]

$$\lambda'_{11i} \cdot \lambda'_{1i1} \leq \epsilon'_i \left(\frac{\Lambda_{SUSY}}{100 GeV} \right)^3 \quad (13)$$

and

$$\Delta_n \lambda'_{311} \lambda_{n13} \leq \epsilon \left(\frac{\Lambda_{SUSY}}{100 GeV} \right)^3 \quad (14)$$

For an overview on our knowledge on λ'_{ijk} from other sources we refer to [Kol97] and [Bha97].

Also R-parity *conserving* softly broken supersymmetry can give contributions to $0\nu\beta\beta$ decay, via the $B - L$ -violating sneutrino mass term, the latter being a generic ingredient of any weak-scale SUSY model with a Majorana neutrino mass [Hir97a, Hir98a]. These contributions are realized at the level of box diagrams [Hir98a] (fig. 2). The $0\nu\beta\beta$ half-life for contributions from sneutrino exchange is found to be [Hir98a]

$$[T_{1/2}^{0\nu\beta\beta}]^{-1} = G_{01} \frac{4m_p^2}{G_F^4} \left| \frac{\eta^{SUSY}}{m_{SUSY}^5} M^{SUSY} \right|, \quad (15)$$

where the phase factor G_{01} is tabulated in [Doi85], η^{SUSY} is the effective lepton number violating parameter, which contains the $(B - L)$ violating sneutrino mass \tilde{m}_M and M^{SUSY} is the nuclear matrix element [Hir96e].

2.3. Left-Right symmetric theories – Heavy neutrinos and right-handed W Boson

Heavy *right-handed* neutrinos appear quite naturally in left-right symmetric GUT models. Since in such models the symmetry breaking scale for the right-handed sector is not fixed by the theory, the mass of the right-handed W_R boson and the mixing angle between the mass eigenstates W_1, W_2 are free parameters. $0\nu\beta\beta$ decay taking into account contributions from both, left- and right-handed neutrinos have been studied theoretically by [Hir96e, Doi93]. The former gives a more general expression for the decay rate than introduced earlier by [Moh86b].

The amplitude will be proportional to [Hir96e]

$$\left(\frac{m_{W_L}}{m_{W_R}} \right)^4 \left(\frac{1}{m_N} + \frac{m_N}{m_{\Delta_R^{--}}^2} \right) \quad (16)$$

Eq. 16 and the experimental lower limit of $0\nu\beta\beta$ decay leads to a constraint limit within the 3-dimensional parameter space $(m_{W_R} - m_N - m_{\Delta_R^{--}})$.

2.4. Compositeness

Although so far there are no experimental signals of a substructure of quarks and leptons, there are speculations that at some higher energy ranges beyond 1 TeV or so there might exist an energy scale Λ_C at which a substructure of quarks and leptons (preons) might become visible [Pan96, Moh92, Sou92, Pan99].

A possible low energy manifestation of compositeness could be neutrinoless double beta decay, mediated by a composite heavy Majorana neutrino, which then should be a Majorana particle.

Recent theoretical work shows (see [Pan96, Tak96, Pan97a, Tak97, Pan99]) that the mass bounds for such an excited neutrino which can be derived from double beta decay are at least of the same order of magnitude as those coming from the direct search of excited states in high energy accelerators (see also section 3).

2.5. Majorons

The existence of new bosons, so-called Majorons, can play a significant role in new physics beyond the standard model, in the history of the early universe, in the evolution of stellar objects, in supernovae astrophysics and the solar neutrino problem [Geo81, Fri88, Kla92]. In many theories of physics beyond the standard model neutrinoless double beta decay can occur with the emission of Majorons

$$2n \rightarrow 2p + 2e^- + \phi \quad (17)$$

$$2n \rightarrow 2p + 2e^- + 2\phi. \quad (18)$$

To avoid an unnatural fine-tuning in recent years several new Majoron models were proposed [Bur93, Bam95b, Car93], where the term Majoron denotes in a more general sense light or massless bosons with couplings to neutrinos.

The main novel features of these “New Majorons” are that they can carry leptonic charge, that they need not be Goldstone bosons and that emission of two Majorons can occur. The latter can be scalar-mediated or fermion-mediated. For details we refer to [Päs96, Bur96].

The half-lives are according to [Moh88, Doi85] in some approximation given by

$$[T_{1/2}]^{-1} = |\langle g_\alpha \rangle|^2 \cdot |M_\alpha|^2 \cdot G_{BB_\alpha} \quad (19)$$

for $\beta\beta\phi$ -decays, or

$$[T_{1/2}]^{-1} = |\langle g_\alpha \rangle|^4 \cdot |M_\alpha|^2 \cdot G_{BB_\alpha} \quad (20)$$

for $\beta\beta\phi\phi$ -decays. The index α indicates that effective neutrino–Majoron coupling constants g , matrix elements M and phase spaces G differ for different models.

Nuclear matrix elements:

There are five different nuclear matrix elements. Of these M_F and M_{GT} are the same which occur in $0\nu\beta\beta$ decay. The other ones and the corresponding phase spaces have been calculated for the first time by [Päs96, Hir96c]. The calculations of the matrix elements show that the new models predict, as consequence of the small matrix elements very large half-lives and that unlikely large coupling constants would be needed to produce observable decay rates (see [Päs96, Hir96c]).

2.6. Sterile neutrinos

Introduction of sterile neutrinos has been claimed to solve simultaneously the conflict between dark matter neutrinos, LSND and supernova nucleosynthesis [Pel95] and light sterile neutrinos are part of popular neutrino mass textures for understanding the various hints for neutrino oscillations (see section 2.1) and [Moh96a, Moh97a, Moh97b]. Neutrinoless double beta decay can also investigate several effects of *heavy* sterile neutrinos [Bam95a].

If we assume having a light neutrino with a mass $\ll 1$ eV, mixing with a much heavier ($m \geq 1$ GeV) sterile neutrino can yield under certain conditions a detectable signal in current $\beta\beta$ experiments.

2.7. Leptoquarks

Interest on leptoquarks (LQ) has been renewed during the last few years since ongoing collider experiments have good prospects for searching these particles [Buc87]. LQs are vector or scalar particles carrying both lepton and baryon numbers and, therefore, have a well distinguished experimental signature. Direct searches of LQs in deep inelastic ep-scattering at HERA [H196] placed lower limits on their mass $M_{LQ} \geq 225 - 275$ GeV, depending on the LQ type and couplings.

To consider LQ phenomenology in a model-independent fashion one usually follows some general principles in constructing the Lagrangian of the LQ interactions with the standard model fields. In order to obey the stringent constraints from (c1) helicity-suppressed $\pi \rightarrow e\nu$ decay, from (c2) FCNC processes and from (c3) proton stability, the following assumptions are commonly adopted: (a1) LQ couplings are chiral, (a2) LQ couplings are generation diagonal, and (a3) there are no diquark couplings.

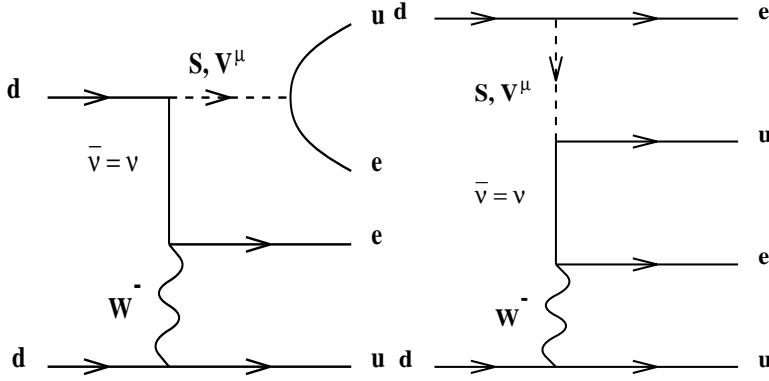

Fig. 3 Examples of Feynman graphs for $0\nu\beta\beta$ decay within LQ models. S and V^μ stand symbolically for scalar and vector LQs, respectively (from [Hir96a]).

Recently, however, it has been pointed out [Hir96b] that possible LQ-Higgs interactions spoil assumption (a1): Even if one assumes LQs to be chiral at some high energy scale, LQ-Higgs interactions introduce after electro-weak symmetry breaking mixing between LQ states with different chirality. Since there is no fundamental reason to forbid such LQ-Higgs interactions, it seems difficult to get rid of the unwanted non-chiral interactions in LQ models.

In such LQ models there appear contributions to $0\nu\beta\beta$ decay via the Feynman graphs of Fig. 3. Here, S and V^μ stand symbolically for scalar and vector LQs, respectively. The half-life for $0\nu\beta\beta$ decay arising from leptoquark exchange is given by [Hir96b]

$$T_{1/2}^{0\nu} = |M_{GT}|^2 \frac{2}{G_F^2} [\tilde{C}_1 a^2 + C_4 b_R^2 + 2C_5 b_L^2]. \quad (21)$$

$$\text{with } a = \frac{\epsilon_S}{M_S^2} + \frac{\epsilon_V}{M_V^2}, \quad b_{L,R} = \frac{\alpha_S^{(L,R)}}{M_S^2} + \frac{\alpha_V^{(L,R)}}{M_V^2}, \quad \tilde{C}_1 = C_1 \left(\frac{\mathcal{M}_1^{(\nu)}}{M_{GT} - \alpha_2 M_F} \right)^2.$$

For the definition of the C_n see [Doi85] and for the calculation of the matrix element $\mathcal{M}_1^{(\nu)}$ see [Hir96b]. This allows to deduce information on leptoquark masses and leptoquark-Higgs couplings (see section 3.2).

2.8. Special Relativity and Equivalence Principle

Special relativity and the equivalence principle can be considered as the most basic foundations of the theory of gravity. Many experiments already have tested these principles to a very high level of accuracy [Hug60] for ordinary matter - generally for quarks and leptons of the first generation.

These precision tests of local Lorentz invariance – violation of the equivalence principle should produce a similar effect [Wil92] – probe for any dependence of the (non-gravitational) laws of physics on a laboratory’s position, orientation or velocity relative to some preferred frame of reference, such as the frame in which the cosmic microwave background is isotropic.

A typical feature of the violation of local Lorentz invariance (VLI) is that different species of matter have a characteristic maximum attainable speed. This can be tested in various sectors of the standard model through vacuum Cerenkov radiation [Gas89b], photon decay [Col97], neutrino oscillations [Gla97, Gas89a, Hal91, Hal96, But93] and K -physics [Ham98, Goo61]. These arguments can be extended to derive new constraints from neutrinoless double beta decay [Kla98f].

The equivalence principle implies that spacetime is described by unique operational geometry and hence universality of the gravitational coupling for all species of matter. In the recent years there have been attempts to constrain a possible amount of violation of the equivalence principle (VEP) in the neutrino sector from neutrino oscillation experiments [Gas89a, Hal91, Hal96, But93]. However, these bounds do not apply when the gravitational and the weak eigenstates have small mixing. In a recent paper [Kla98f] a generalized formalism of the neutrino sector has been given to test the VEP and it has been shown that neutrinoless double beta decay also constrains the VEP. VEP implies different neutrino species to suffer from different gravitational potentials while propagating through the nucleus and hence the effect of different eigenvalues doesn’t cancel for the same effective momentum. The main result is that neutrinoless double beta decay can constrain the amount of VEP even when the mixing angle is zero, *i.e.*, when only the weak equivalence principle is violated, for which there does not exist any bound at present.

3. Double Beta Decay Experiments: Present Status and Results

3.1. Present Experimental Status

Fig. 4 shows an overview over measured $0\nu\beta\beta$ half-life limits and deduced mass limits. The largest sensitivity for $0\nu\beta\beta$ decay is obtained at present by active source experiments (source=detector), in particular ^{76}Ge [Kla98a, Kla98b].

Only a few of the present most sensitive experiments may probe the neutrino mass in the next years into the sub-eV region, the Heidelberg–Moscow experiment being the by far most advanced and most sensitive one, see Fig. 4b. No one of them will pass, however, below ~ 0.1 eV (see section 4.1). A detailed discussion of the various experimental possibilities can be

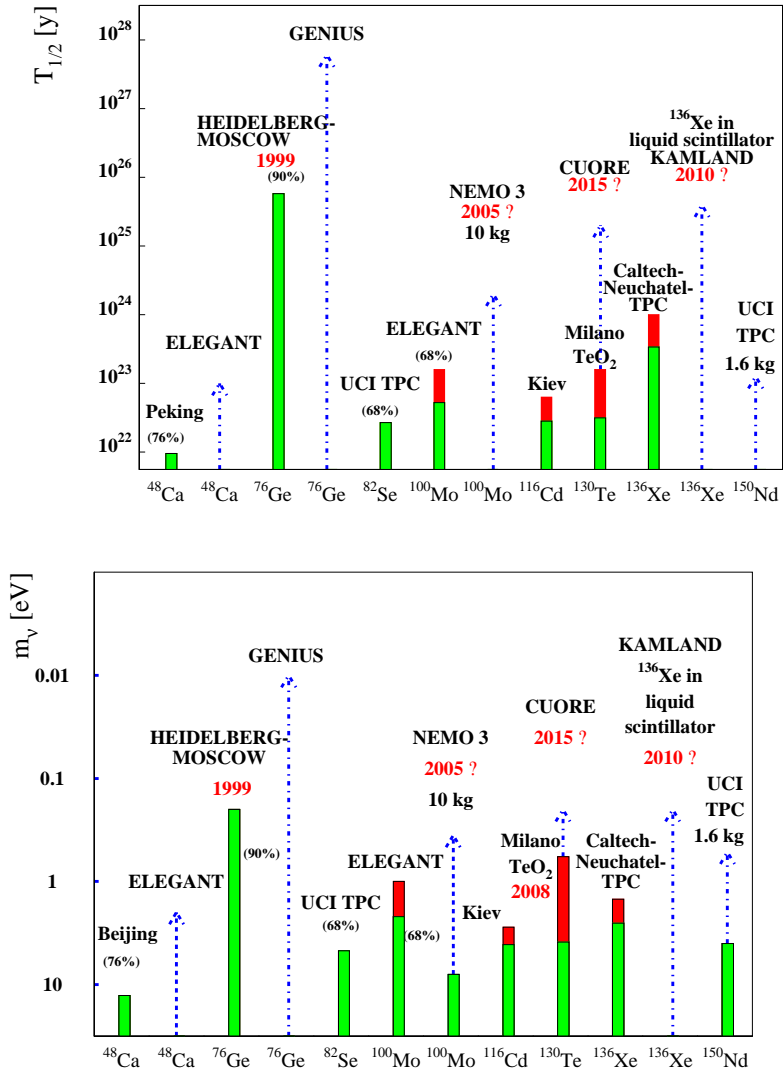

Fig. 4 Present situation, 1999, and expectation for the near future and beyond, of the most promising $\beta\beta$ -experiments concerning accessible half life (a) and neutrino mass limits (b). The light-shaded parts of the bars correspond to the present status, the dark parts of the bars to expectations for running experiments, dashed lines to experiments under construction and dash-dotted lines to proposed experiments.

found in [Kla95, Kla96a, Kla96b, Kla99a]. A useful listing of existing data from the various $\beta\beta$ emitters is given in [Tre95].

3.2. Present limits on beyond standard model parameters

The sharpest limits from $0\nu\beta\beta$ decay are presently coming from the Heidelberg–Moscow experiment [Kla87, Kla98b, Kla99a, Bau99a]. They will be given in the following. With five enriched (86% of ^{76}Ge) detectors of a total mass of 11.5 kg taking data in the Gran Sasso underground laboratory, and with a background of at present 0.06 counts/kg year keV, the experiment has reached its final setup and is now exploring the sub-eV range for the mass of the electron neutrino. Fig. 5 shows the spectrum taken in a measuring time of 24 kgy with pulse shape analysis..

Half-life of neutrinoless double beta decay

The deduced half-life limit for $0\nu\beta\beta$ decay is using the method proposed by [PDG98]

$$T_{1/2}^{0\nu} > 5.7 \cdot 10^{25} y \quad (90\%C.L.) \quad (22)$$

$$> 2.5 \cdot 10^{26} y \quad (68\%C.L.). \quad (23)$$

Neutrino mass

Light neutrinos: The deduced upper limit of an (effective) electron neutrino Majorana mass is, with the matrix element from [Sta90]

$$\langle m_\nu \rangle < 0.20 eV \quad (90\%C.L.) \quad (24)$$

$$< 0.10 eV \quad (68\%C.L.) \quad (25)$$

This is the sharpest limit for a Majorana mass of the electron neutrino so far. With these values the Heidelberg–Moscow experiment starts to take striking influence on presently discussed neutrino mass scenarios, which arose in connection with the recent Superkamiokande results on solar and atmospheric neutrinos. We mention a few examples:

The new $0\nu\beta\beta$ result excludes already now simultaneous 3ν solutions for hot dark matter, the atmospheric neutrino problem and the small mixing angle MSW solution [Adh98]. This means that Majorana neutrinos are ruled out, if the small mixing angle solution of the solar neutrino problem is borne out – if we insist on neutrinos as hot dark matter candidates. According to [Min97] degenerate neutrino mass schemes for hot dark matter, solar and atmospheric anomalies and CHOOZ are already now excluded (with 68 % C.L.) for the small *and* large mixing angle MSW solutions (without

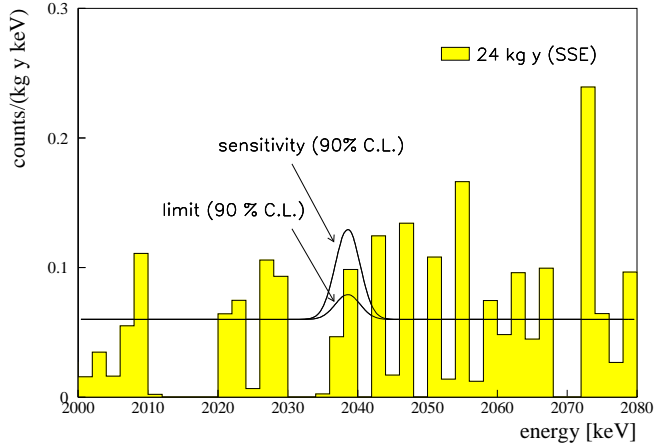

Fig. 5 Integral spectrum in the region of interest after subtraction of the first 200 days of measurement of each detector, leaving 24 kg y of measuring time with pulse shape analysis. The two solid curves correspond to the signal excluded with 90% C.L. and to the sensitivity defined by [Fel98] of the experiment (90% C.L.). They correspond to $T_{1/2}^{0\nu} > 5.7 \cdot 10^{25}$ y and $T_{1/2}^{0\nu} > 1.6 \cdot 10^{25}$ y, respectively. (from [Bau99a])

unnatural finetuning). If starting from recent dark matter models [Pri98] including in addition to cold and hot dark matter also a cosmological constant $\Lambda \neq 0$, these conclusions remain also valid, except for the large angle solution which would not yet be excluded by $0\nu\beta\beta$ decay (see [Kla99b]).

According to [Bar98] simultaneous 3ν solutions of solar and atmospheric neutrinos, and LSND and CHOOZ (no hot dark matter!) predict $\langle m_\nu \rangle \simeq 1.5\text{eV}$ for the degenerate case ($m_i \simeq 1\text{eV}$) and $\langle m \rangle \simeq 0.14\text{eV}$ for the hierarchical case. This means *both* cases are practically excluded already by the present Heidelberg–Moscow result. A model producing the neutrino masses based on a heavy scalar triplet instead of the seesaw mechanism derives from the solar small angle MSW allowed range of mixing, and accomodating the atmospheric neutrino problem, $\langle m_\nu \rangle = 0.17\text{--}0.31$ eV [Ma99]. Also this model is already excluded with 68 % C.L., including an uncertainty of a factor of 2 in the nuclear matrix elements. Looking into 4-neutrino scenarios, according to [Giu99] there are only two schemes with four neutrino mixing that can accomodate the results of *all* neutrino oscillation experiments (including LSND). In the first of the schemes, where $m_1 < m_2 \ll m_3 < m_4$, with solar (atmospheric) neutrinos oscillating between m_3 and m_4 (m_1 and m_2), and $\Delta m_{LSND}^2 = \Delta m_{41}^2$, the HEIDELBERG–MOSCOW $0\nu\beta\beta$ bound excludes [Giu99] the small mix-

ing angle MSW solution of the solar neutrino problem, for both $\nu_e \rightarrow \nu_\tau$, and $\nu_e \rightarrow \nu_s$ transitions. Including recent astrophysical data yielding $N_\nu^{BBN} \leq 3.2$ (95 % C.L.) [Bur99], the oscillations of solar neutrinos occur mainly in the $\nu_e \rightarrow \nu_s$ channel, and *only* the small angle solutions is allowed by the fit of the solar neutrino data [Bah98, Fuk99]. This means that $0\nu\beta\beta$ excludes the whole first scheme.

In the second scheme $m_1 < m_2 \ll m_3 < m_4$, with solar (atmospheric) neutrinos oscillating between m_1 and m_2 (m_3 and m_4), the present neutrino oscillation experiments indicate an effective Majorana mass of $7 \cdot 10^{-4} eV \leq |\langle m \rangle| \leq 2 \cdot 10^{-2} eV$. This could eventually be measured by GENIUS (see below). For a similar recent analysis see [Bil99]. For further detailed analyses of neutrino mass textures in the light of present and future neutrino experiments including double beta decay we refer to [Kla99b].

Superheavy neutrinos: For a superheavy *left*-handed neutrino we deduce [HM95, Bel96, Bel98] exploiting the mass dependence of the matrix element (for the latter see [Mut89]) a lower limit (see also Fig. 11)

$$\langle m_H \rangle \geq 100 TeV. \quad (26)$$

Right-handed W boson

For the right-handed W boson we obtain a lower limit of

$$m_{WR} \geq 1.6 TeV \quad (27)$$

(see [Hir96e, Kla98e]).

SUSY parameters – R-parity breaking and sneutrino mass

The constraints on the parameters of the minimal supersymmetric standard model with explicit R-parity violation deduced [Hir95a, Hir96d, Hir96a] from the $0\nu\beta\beta$ half-life limit are more stringent than those from other low-energy processes and from the largest high energy accelerators. The limits are

$$\lambda'_{111} \leq 3.9 \cdot 10^{-4} \left(\frac{m_{\tilde{q}}}{100 GeV} \right)^2 \left(\frac{m_{\tilde{g}}}{100 GeV} \right)^{\frac{1}{2}} \quad (28)$$

with $m_{\tilde{q}}$ and $m_{\tilde{g}}$ denoting squark and gluino masses, respectively, and with the assumption $m_{\tilde{d}_R} \simeq m_{\tilde{u}_L}$. This result is important for the discussion of new physics in the connection with the high- Q^2 events seen at HERA. It excludes the possibility of squarks of first generation (of R-parity violating SUSY) being produced in the high- Q^2 events [Cho97, Alt97, Hir97b].

We find further [Hir96a]

$$\lambda'_{113} \lambda'_{131} \leq 1.1 \cdot 10^{-7} \quad (29)$$

$$\lambda'_{112}\lambda'_{121} \leq 3.2 \cdot 10^{-6}. \quad (30)$$

For the $(B - L)$ violating sneutrino mass \tilde{m}_M the following limits are obtained [Hir98b]

$$\tilde{m}_M \leq 2 \left(\frac{m_{SUSY}}{100 GeV} \right)^{\frac{3}{2}} GeV, \quad \chi \simeq \tilde{B} \quad (31)$$

$$\tilde{m}_M \leq 11 \left(\frac{m_{SUSY}}{100 GeV} \right)^{\frac{7}{2}} GeV, \quad \chi \simeq \tilde{H} \quad (32)$$

for the limiting cases that the lightest neutralino is a pure Bino \tilde{B} , as suggested by the SUSY solution of the dark matter problem [Jun96], or a pure Higgsino. Actual values for \tilde{m}_M for other choices of the neutralino composition should lie in between these two values.

Another way to deduce a limit on the ‘Majorana’ sneutrino mass \tilde{m}_M is to start from the experimental neutrino mass limit, since the sneutrino contributes to the Majorana neutrino mass m_M^ν at the 1-loop level proportional to \tilde{m}_M^2 . This yields under some assumptions [Hir98b]

$$\tilde{m}_{M(i)} \leq (60 - 125) \left(\frac{m_{\nu(i)}^{exp}}{1 eV} \right)^{1/2} MeV \quad (33)$$

Starting from the mass limit determined for the electron neutrino by $0\nu\beta\beta$ decay this leads to

$$\tilde{m}_{M(e)} \leq 22 MeV \quad (34)$$

This result is somewhat dependent on neutralino masses and mixings. A non-vanishing ‘Majorana’ sneutrino mass would result in new processes at future colliders, like sneutrino–antisneutrino oscillations. Reactions at the Next Linear Collider (NLC) like the SUSY analog to inverse neutrinoless double beta decay $e^-e^- \rightarrow \chi^-\chi^-$ (where χ^- denote charginos) or single sneutrino production, e.g. by $e^-\gamma \rightarrow \tilde{\nu}_e\chi^-$ could give information on the Majorana sneutrino mass, also. This is discussed by [Hir97a, Hir98b, Hir98a]. A conclusion is that future accelerators can give information on second and third generation sneutrino Majorana masses, but for first generation sneutrinos cannot compete with $0\nu\beta\beta$ -decay.

Compositeness

Evaluation of the $0\nu\beta\beta$ half-life limit assuming exchange of excited Majorana neutrinos ν^* yields for the mass of the excited neutrino a lower bound of [Pan97a, Tak97].

$$m_N \geq 3.4 m_W \quad (35)$$

for a coupling of order $O(1)$ and $\Lambda_c \simeq m_N$. Here, m_W is the W-boson mass.

Leptoquarks

Assuming that either scalar or vector leptoquarks contribute to $0\nu\beta\beta$ decay, the following constraints on the effective LQ parameters (see section 2.7) can be derived [Hir96b]:

$$\epsilon_I \leq 2.8 \times 10^{-9} \left(\frac{M_I}{100\text{GeV}} \right)^2, \quad (36)$$

$$\alpha_I^{(L)} \leq 3.5 \times 10^{-10} \left(\frac{M_I}{100\text{GeV}} \right)^2, \quad (37)$$

$$\alpha_I^{(R)} \leq 7.9 \times 10^{-8} \left(\frac{M_I}{100\text{GeV}} \right)^2. \quad (38)$$

Since the LQ mass matrices appearing in $0\nu\beta\beta$ decay are (4×4) matrices [Hir96b], it is difficult to solve their diagonalization in full generality algebraically. However, if one assumes that only one LQ-Higgs coupling is present at a time, the (mathematical) problem is simplified greatly and one can deduce from, for example, eq. 40 that either the LQ-Higgs coupling must be smaller than $\sim 10^{-(4-5)}$ or there can not be any LQ with e.g. couplings of electromagnetic strength with masses below $\sim 250\text{GeV}$. These bounds from $\beta\beta$ decay are of interest in connection with recently discussed evidence for new physics from HERA [Hew97, Bab97a, Kal97, Cho97]. Assuming that actually leptoquarks have been produced at HERA, double beta decay (the Heidelberg–Moscow experiment) would allow to fix the leptoquark–Higgs coupling to a few 10^{-6} [Hir97b]. It may be noted, that after the first consideration of leptoquark–Higgs coupling in [Hir96b] recently Babu et al. [Bab97b] noted that taking into account leptoquark–Higgs coupling reduces the leptoquark mass lower bound deduced by TEVATRON – making it more consistent with the value of 200 GeV required by HERA.

Special Relativity and Equivalence Principle

Violation of Lorentz invariance (VLI): The bound obtained from the Heidelberg–Moscow experiment is

$$\delta v < 4 \times 10^{-16} \quad \text{for} \quad \theta_v = \theta_m = 0 \quad (39)$$

where $\delta v = v_1 - v_2$ is the measure of VLI in the neutrino sector. θ_v and θ_m denote the velocity mixing angle and the weak mixing angle, respectively. In Fig. 6 (from [Kla98f]) the bound implied by double beta decay is presented for the entire range of $\sin^2(2\theta_v)$, and compared with bounds obtained from neutrino oscillation experiments (see [Hal96]).

Violation of equivalence principle (VEP): Assuming only violation of the weak equivalence principle, there does not exist any bound on the

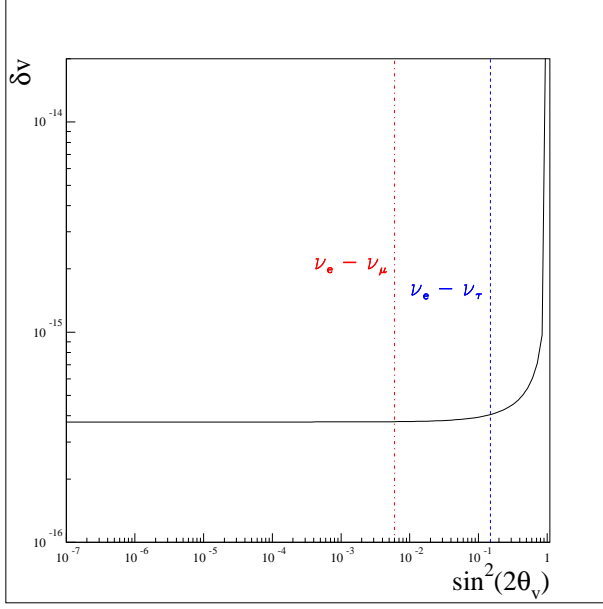

Fig. 6 Double beta decay bound (solid line) on violation of Lorentz invariance in the neutrino sector, excluding the region to the upper left. Shown is a double logarithmic plot in the δv - $\sin^2(2\theta)$ parameter space. The bound becomes most stringent for the small mixing region, which has not been constrained from any other experiments. For comparison the bounds obtained from neutrino oscillation experiments (from [Hal96]) in the $\nu_e - \nu_\tau$ (dashed lines) and in the $\nu_e - \nu_\mu$ (dashed-dotted lines) channel, excluding the region to the right, are shown (from [Kla98f]).

amount of VEP. It is this region of the parameter space which is most restrictively bounded by neutrinoless double beta decay. In a linearized theory the gravitational part of the Lagrangian to first order in a weak gravitational field $g_{\mu\nu} = \eta_{\mu\nu} + h_{\mu\nu}$ ($h_{\mu\nu} = 2\frac{\phi}{c^2} \text{diag}(1, 1, 1, 1)$) can be written as $\mathcal{L} = -\frac{1}{2}(1 + g_i)h_{\mu\nu}T^{\mu\nu}$, where $T^{\mu\nu}$ is the stress-energy in the gravitational eigenbasis. In the presence of VEP the g_i may differ. We obtain [Kla98f] the following bound from the Heidelberg–Moscow experiment, for $\theta_v = \theta_m = 0$:

$$\begin{aligned} \phi\delta g &< 4 \times 10^{-16} \quad (\text{for } \bar{m} < 13\text{eV}) \\ \phi\delta g &< 2 \times 10^{-18} \quad (\text{for } \bar{m} < 0.08\text{eV}). \end{aligned} \quad (40)$$

Here $\bar{g} = \frac{g_1 + g_2}{2}$ can be considered as the standard gravitational coupling, for which the equivalence principle applies. $\delta g = g_1 - g_2$. The bound on

the VEP thus, unlike the one for VLI, will depend on the choice for the Newtonian potential ϕ .

Half-life of $2\nu\beta\beta$ decay

The Heidelberg–Moscow experiment produced for the first time a high statistics $2\nu\beta\beta$ spectrum ($\gg 20000$ counts, to be compared with the 40 counts on which the first detector observation of $2\nu\beta\beta$ decay by [Ell87] (for the decay of ^{82}Se) had to rely). The deduced half-life is [HM97]

$$T_{1/2}^{2\nu} = (1.77_{-0.01}^{+0.01}(\text{stat.})_{-0.11}^{+0.13}(\text{syst.})) \cdot 10^{21}y \quad (41)$$

This result brings $\beta\beta$ research for the first time into the region of ‘normal’ nuclear spectroscopy and allows for the first time statistically reliable investigation of Majoron–accompanied decay modes.

Majoron–accompanied decay

From simultaneous fits of the 2ν spectrum and one selected Majoron mode, experimental limits for the half-lives of the decay modes of the newly introduced Majoron models [Bur96] are given for the first time [Päs96, HM96].

The small matrix elements and phase spaces for these modes [Päs96, Hir96c] already determined that these modes by far cannot be seen in experiments of the present sensitivity if we assume typical values for the neutrino–Majoron coupling constants around $\langle g \rangle = 10^{-4}$.

4. Double Beta Experiments: Future Perspectives – the GENIUS Project

4.1. The known experiments and proposals

Figs. 4a,b show in addition to the present status the future perspectives of the main existing $\beta\beta$ decay experiments and includes some ideas for the future which have been published. The best presently existing limits besides the HEIDELBERG-MOSCOW experiment (filled bars in Fig. 4), have been obtained with the isotopes: ^{48}Ca [You95], ^{82}Se [Ell92], ^{100}Mo [Als89], ^{116}Cd [Dan95], ^{130}Te [Ale94], ^{136}Xe [Vui93] and ^{150}Nd [Moe94]. These and other double beta decay setups presently under construction or partly in operation such as NEMO [NEM94, Bar97], the Gotthard ^{136}Xe TPC experiment [Joer94], the ^{130}Te cryogenic experiment [Ale94], a new ELEGANT ^{48}Ca experiment using 30 g of ^{48}Ca [Kum96], a hypothetical experiment with an improved UCI TPC [Moe94] assumed to use 1.6 kg of ^{136}Xe , etc., will not reach or exceed the ^{76}Ge limits. The goal 0.3 eV aimed at for the year 2004 by the NEMO experiment (see [Piq96, Bar97]

and Fig. 4) may even be very optimistic if claims about the effect of proton-neutron pairing on the $0\nu\beta\beta$ nuclear matrix elements by [Pan96b] will turn out to be true, and also if the energy resolution will not be improved considerably (see Fig. 1 in [Tre95]). Therefore, the conclusion given by [Bed97c] concerning the future SUSY potential of NEMO has no serious basis. As pointed out by Raghavan [Rag94], even use of an amount of about 200 kg of enriched ^{136}Xe or 2 tons of natural Xe added to the scintillator of the KAMIOKANDE detector or similar amounts added to BOREXINO (both primarily devoted to solar neutrino investigation) would hardly lead to a sensitivity larger than the present ^{76}Ge experiment. This idea is going to be realized at present by the KAMLAND experiment [Suz97].

It is obvious from Fig. 4 that *none* of the present experimental approaches, or plans or even vague ideas has a chance to surpass the border of 0.1 eV for the neutrino mass to lower values (see also [Nor97]). At present there is only one way visible to reach the domain of lower neutrino masses, suggested by [Kla98a] and meanwhile investigated in some detail concerning its experimental realization and physics potential in [Kla97c, Hel97, Kla98b, Kla98c].

4.2. *Genius – A Future Large Scale Double Beta and Dark Matter Experiment*

The idea of GENIUS is to use a large amount of ‘naked’ enriched **GER**manium detectors in liquid **NI**trogen as shielding in an **U**nderground **S**etup. Use of 1 (in an extended version 10) tons of enriched ^{76}Ge will increase the source strength largely, removing all material from the vicinity of the detectors and shielding by liquid nitrogen will lead to a drastic background reduction compared to the present level. That Ge detectors can be operated in liquid nitrogen has been demonstrated recently in the Heidelberg low level laboratory [Hel97, Bau98].

4.2.1. Realization and Sensitivity of GENIUS A simplified model of GENIUS is shown in Fig. 7 consisting of about 300 enriched ^{76}Ge detectors with a total of one ton mass in the center of a 12 m high liquid nitrogen tank with 12 m diameter. The results of Monte Carlo simulations, using the CERN GEANT code, of the background [Hel97, Bau98], starting from purity levels of the nitrogen being in general an order of magnitude less stringent than those already achieved in the CTF for the BOREXINO experiment, yield for the count rate in the region of interest for neutrinoless double beta decay is 0.04 counts/(keV y t). Below 100 keV the background count rate is about 10 counts/(keV y t). Two neutrino double beta decay would dominate the spectrum with $4 \cdot 10^6$ events per year (for details see [Kla98b, Kla98c, Bau98]).

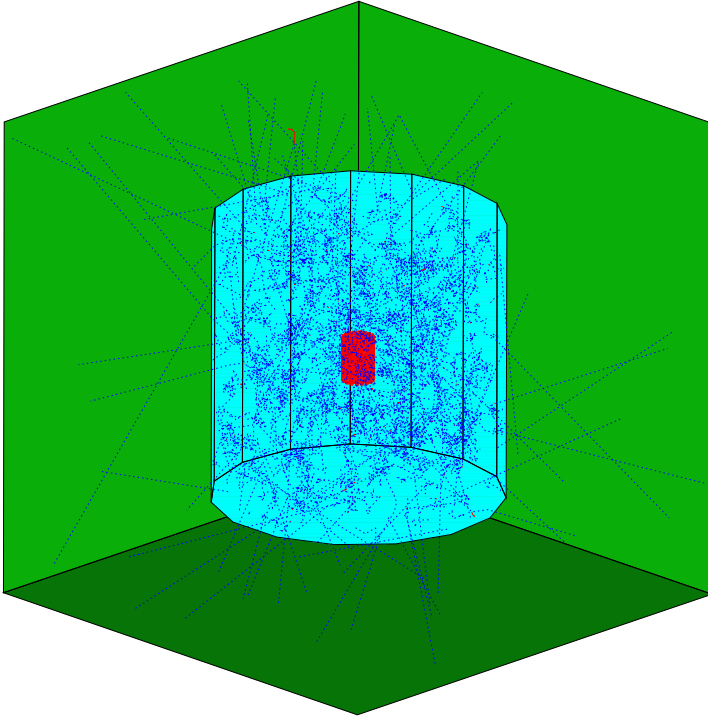

Fig. 7 *Simplified model of the GENIUS experiment: 288 enriched ^{76}Ge detectors with a total of one ton mass in the center of a 12 m high liquid nitrogen tank with 12 m diameter; GEANT Monte Carlo simulation of 1000 2.6 MeV photons randomly distributed in the nitrogen is also shown.*

Starting from these numbers, a lower half-life limit of

$$T_{1/2}^{0\nu} \geq 5.8 \cdot 10^{27} \quad (68\%C.L.) \quad (42)$$

can be reached within one year of measurement (following the highly conservative procedure for analysis recommended by [PDG94], which has been used also in the derivation of the results given in section 3.2, but is not used in the analysis of several other $\beta\beta$ experiments). This corresponds – with the matrix elements of [Sta90] – to an upper limit on the neutrino mass of

$$\langle m_\nu \rangle \leq 0.02eV \quad (68\%C.L.) \quad (43)$$

The final sensitivity of the experiment can be defined by the limit, which would be obtained after 10 years of measurement assuming zero

background. For the one ton experiment this would be:

$$T_{1/2}^{0\nu} \geq 6.4 \cdot 10^{28} y \quad (\text{with } 68\% \text{ C.L.}) \quad (44)$$

and

$$\langle m_\nu \rangle \leq 0.006 eV \quad (\text{with } 68\% \text{ C.L.}) \quad (45)$$

The ultimate experiment could test the $0\nu\beta\beta$ half life of ^{76}Ge up to a limit of $5.7 \cdot 10^{29} y$ and the neutrino mass down to $2 \cdot 10^{-3} eV$ using 10 tons of enriched Germanium and a measuring time of 10 years.

4.2.2. The Physics Potential of GENIUS

Neutrino mass textures and neutrino oscillations: GENIUS will allow a large step in sensitivity for probing the neutrino mass. It will allow to probe the neutrino mass down to $10^{-(2-3)} eV$, and thus surpass the existing neutrino mass experiments by a factor of 50-500. GENIUS will test the structure of the neutrino mass matrix and thereby also neutrino oscillation parameters ¹ superior in sensitivity to the best proposed dedicated terrestrial neutrino oscillation experiments. Even in the first stage GENIUS will confirm or rule out degenerate or inverted neutrino mass scenarios, discussed in the literature as possible solutions of current hints to finite neutrino masses (see [Kla99b, Giu99, Cza99, Vis99]). If the $10^{-3} eV$ level is reached, GENIUS will allow to test the large angle and for degenerate models even the small angle MSW solution of the solar neutrino problem. It will also allow to test the hypothesis of a shadow world underlying introduction of a sterile neutrino mentioned in section 2.1. The figures 8-10 show some examples of this potential (for more details see [Kla97c, Kla98a, Kla98b, Kla98c, Kla99a]). Fig. 8 compares the potential of GENIUS with the sensitivity of CHORUS/NOMAD and with the

¹ The double beta observable, the effective neutrino mass (eq. 10), can be expressed in terms of the usual neutrino oscillation parameters, once an assumption on the ratio of m_1/m_2 is made. E.g., in the simplest two-generation case

$$\langle m_\nu \rangle = |c_{12}^2 m_1 + s_{12}^2 m_2 e^{2i\beta}|, \quad (46)$$

assuming CP conservation, i.e. $e^{2i\beta} = \eta = \pm 1$, and $c_{12}^2 m_1 \ll \eta s_{12}^2 m_2$,

$$\Delta_{m_{12}}^2 \simeq m_2^2 = \frac{4\langle m_\nu \rangle^2}{1 - \sqrt{1 - \sin^2 2\theta}} \quad (47)$$

A little bit more general, keeping corrections of the order (m_1/m_2) one obtains

$$m_2 = \frac{\langle m_\nu \rangle}{|(\frac{m_1}{m_2}) + \frac{1}{2}(1 - \sqrt{1 - \sin^2 2\theta})(\pm 1 - (\frac{m_1}{m_2}))|}. \quad (48)$$

For the general case see [Kla97c].

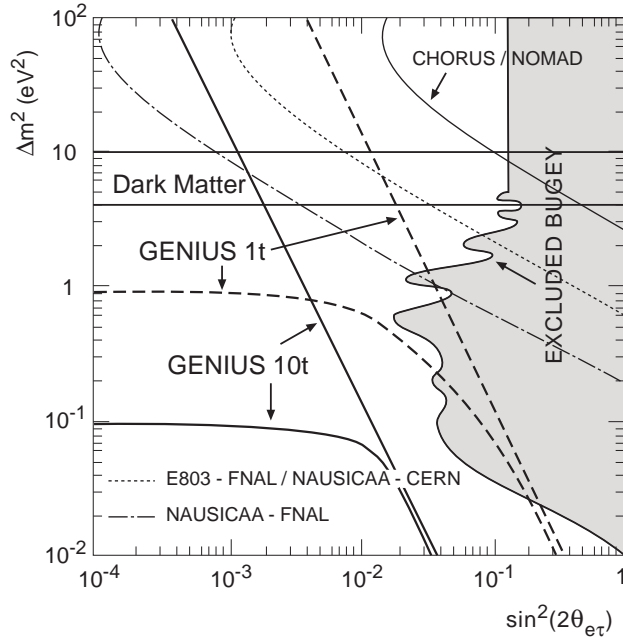

Fig. 8 Current limits and future experimental sensitivity on $\nu_e - \nu_\tau$ oscillations. The shaded area is currently excluded from reactor experiments. The thin line is the estimated sensitivity of the CHORUS/NOMAD experiments. The dotted and dash-dotted thin lines are sensitivity limits of proposed accelerator experiments, NAUSICAA and E803-FNAL [Gon95]. The thick lines show the sensitivity of GENIUS (broken line: 1 t, full line: 10 t), for two examples of mass ratios. The straight lines are for the strongly hierarchical case ($R=0$), while the lines bending to the left assume $R=0.01$. (from [Kla97c])

proposed future experiments NAUSICAA-CERN and NAUSICAA-FNAL, looking for $\nu_e \leftrightarrow \nu_\tau$ oscillations, for different assumptions on m_1/m_2 .

Already in the worst case for double beta decay of $m_1/m_2 = 0$ GENIUS 1 ton is more sensitive than the running CERN experiments. For quasi-degenerate models, for example $R = 0.01$ already, GENIUS 1 ton would be more sensitive than the planned future accelerator neutrino experiments.

Fig. 9 shows the potential of GENIUS for checking the LSND indication for neutrino oscillations (original figure from [Ath96]). Under the assumption $m_1/m_2 \geq 0.02$ and $\eta = 1$, GENIUS 1 ton will be sufficient to find $0\nu\beta\beta$ decay if the LSND result is to be explained in terms of $\nu_e \leftrightarrow \nu_\mu$ oscillations. This might be of particular interest also since the upgraded

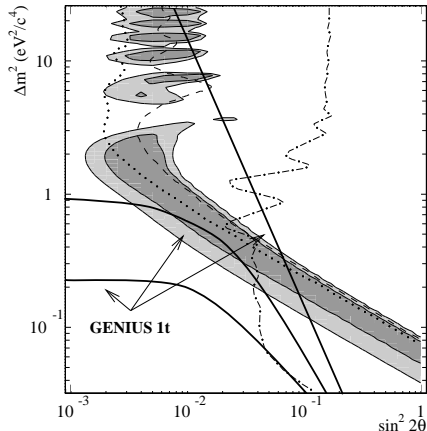

Fig. 9 *LSND compared to the sensitivity of GENIUS 1t for $\eta^{CP} = +1$ and three ratios R_{12} , from top to bottom $R_{12} = 0, 0.01, 0.02$ (from [Kla97c])*

KARMEN will not completely cover [Dre97] the full allowed LSND range. Fig. 10 shows a summary of currently known constraints on neutrino oscillation parameters (original taken from [Hat94]), but including the $0\nu\beta\beta$ decay sensitivities of GENIUS 1 ton and GENIUS 10 tons, for different assumptions on m_1/m_2 (for $\eta^{CP} = +1$, for $\eta^{CP} = -1$ see [Kla97c]). It is seen that already GENIUS 1 ton tests all degenerate or quasi-degenerate ($m_1/m_2 \geq \sim 0.01$) neutrino mass models in any range where neutrinos are interesting for cosmology, and also the atmospheric neutrino problem, if it is due to $\nu_e \leftrightarrow \nu_\mu$ oscillations. GENIUS in its 10 ton version would directly test the large angle solution of the solar neutrino problem and in case of almost degenerate neutrino masses, also the small angle solution.

For further recent discussions of the potential of GENIUS for probing neutrino mass textures we refer, e.g., to [Kla99b, Giu99, Cza99, Vis99, Bil99].

GENIUS and super-heavy left-handed neutrinos: Fig. 11 (from [Bel98]) compares the sensitivity of GENIUS for heavy left-handed neutrinos (as function of U_{ei}^2 , for which the present LEP limit is $U_{ei}^2 \leq 5 \cdot 10^{-3}$ [Nar95]) with the discovery limit for $e^-e^- \rightarrow W^-W^-$ at Next Linear Colliders. The observable in $0\nu\beta\beta$ decay is

$$\langle m_\nu^{-1} \rangle_H = \sum_i'' U_{ei}^2 \frac{1}{M_i}. \quad (49)$$

Also shown are the present limits from the Heidelberg–Moscow experiment (denoted by $0\nu\beta\beta$) assuming different matrix elements. It is obvious that $0\nu\beta\beta$ is more sensitive than any reasonable future Linear Collider.

GENIUS and left-right symmetry: If GENIUS is able to reach down to $\langle m_\nu \rangle \leq 0.01$ eV, it would at the same time be sensitive to right-handed W -boson masses up to $m_{W_R} \geq 8$ TeV (for a heavy right-handed neutrino mass of 1 TeV) or $m_{W_R} \geq 5.3$ TeV (at $\langle m_N \rangle = m_{W_R}$) [Kla97c]. Such a limit would be comparable to the one expected for LHC, see for example [Riz96], which quotes a final sensitivity of something like 5 – 6 TeV. Note, however that in order to obtain such a limit the experiments at LHC need to accumulate about $100fb^{-1}$ of statistics. A 10 ton version of GENIUS could even reach a sensitivity of $m_{W_R} \geq 18$ TeV (for a heavy right-handed neutrino mass of 1 TeV) or $m_{W_R} \geq 10.1$ TeV (at $\langle m_N \rangle = m_{W_R}$).

This means that already GENIUS 1 ton could be sufficient to definitely test recent supersymmetric left-right symmetric models having the nice features of solving the strong CP problem without the need for an axion and having automatic R-parity conservation [Kuc95, Moh96a].

GENIUS and R_p -violating SUSY: The improvement on the R-parity breaking Yukawa coupling λ'_{111} (see section 2.2) is shown in Fig. 12. The full line to the right is the expected sensitivity of the LHC – in the limit of large statistics. The three dashed-dotted lines denote (from top to bottom) the current constraint from the Heidelberg–Moscow experiment and the sensitivity of GENIUS 1 ton and GENIUS 10 tons, all for the conservative case of a gluino mass of 1 TeV. If squarks would be heavier than 1 TeV, LHC could not compete with GENIUS. However, for typical squark masses below 1 TeV, LHC could probe smaller couplings. However, one should keep in mind, that LHC can probe squark masses up to 1 TeV only with several years of data taking.

GENIUS and R_p -conserving SUSY: Since the limits on a ‘Majorana-like’ sneutrino mass \tilde{m}_M scale with $(T_{1/2})^{1/4}$, GENIUS 1 ton (or 10 tons) would test ‘Majorana’ sneutrino masses lower by factors of about 7(20), compared with present constraints [Hir97a, Hir98b, Hir97b].

GENIUS and Leptoquarks: Limits on the lepton-number violating parameters defined in sections 2.7, 3.2 improve as $\sqrt{T_{1/2}}$. This means that for leptoquarks in the range of 200 GeV LQ–Higgs couplings down to (a few) 10^{-8} could be explored. In other words, if leptoquarks interact with the standard model Higgs boson with a coupling of the order $\mathcal{O}(1)$, either $0\nu\beta\beta$ must be found, or LQs must be heavier than (several) 10 TeV.

mass ratios $R = 0, 0.01$ and 0.1 (from top to bottom). For GENIUS 10 ton also the contour line for $R = 0.5$ is shown. The region beyond the lines would be excluded. While already the 1 ton GENIUS would be sufficient to constrain degenerate and quasi-degenerate neutrino mass models, and also would solve the atmospheric neutrino problem if it is due to $\nu_e \leftrightarrow \nu_\mu$ oscillations, the 10 ton version of GENIUS could cover a significant new part of the parameter space, including the large angle MSW solution to the solar neutrino problem, even in the worst case of $R = 0$. For $R \geq 0.5$ it would even probe the small angle MSW solution (see [Kla98g, Kla98e]).

GENIUS and composite neutrinos GENIUS in the 1(10) ton version would improve the limit on the excited Majorana neutrino mass deduced from the Heidelberg–Moscow experiment (eq. 32) to

$$m_N \geq 1.1(2.3) \text{ TeV} \quad (50)$$

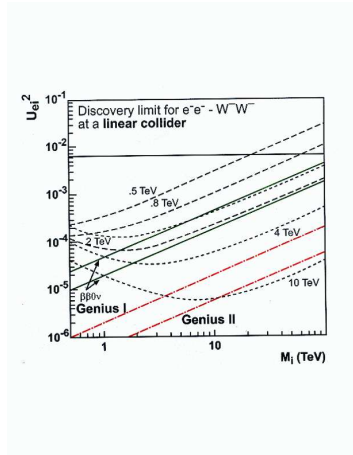

Fig. 11 Discovery limit for $e^-e^- \rightarrow W^-W^-$ at a linear collider as function of the mass M_i of a heavy left-handed neutrino, and of U_{ei}^2 for \sqrt{s} between 500 GeV and 10 TeV. In all cases the parameter space above the line corresponds to observable events. Also shown are the limits set by the Heidelberg–Moscow $0\nu\beta\beta$ experiment as well as the prospective limits from GENIUS. The areas above the $0\nu\beta\beta$ contour lines are excluded. The horizontal line denotes the limit on neutrino mixing, U_{ei}^2 , from LEP. Here the parameter space above the line is excluded. (from [Bel98]).

A recent detailed study [Pan99] shows that while the HEIDELBERG–MOSCOW experiment already exceeds the sensitivity of LEP II in probing compositeness, GENIUS will reach the sensitivity of LHC. With the $0\nu\beta\beta$

half life against decay by exchange of a composite Majorana neutrino given by [Pan99]

$$T_{1/2}^{-1} = \left(\frac{f}{\Lambda_c}\right)^4 \frac{m_A^8}{M_N^2} |\mathcal{M}_{FI}|^2 \frac{G_{01}}{m_e^2} \quad (51)$$

where M_N is the composite neutrino Majorana mass, and f denotes the coupling with the electron, figure 13 shows the situations of GENIUS and LHC.

4.2.3. GENIUS, special relativity and equivalence principle in the neutrino sector

The already now strongest limits given by the Heidelberg–Moscow experiment discussed in section 3.2 would be improved by 1–2 orders of magnitude. It should be stressed again, that while neutrino oscillation bounds constrain the region of large mixing of the weak and gravitational eigenstates, these bounds from double beta decay apply even in the case of no mixing and thus probe a totally unconstrained region in the parameter space.

4.2.4. GENIUS and dark matter

Neutrinos as hot dark matter

If neutrinos have masses in the range of a few eV, they would be good candidates for the hot dark matter in the universe. From the dark matter argument itself it does not follow which neutrino has to be in this mass range. Clearly, if a neutrino with sizeable mixing angle to the electron neutrino in this mass range exists, one expects GENIUS to find $0\nu\beta\beta$ decay.

However, if the ν_τ is in the eV range, the ν_e and ν_μ being lighter by at least factors of hundreds and the $\nu_\tau - \nu_e$ mixing angle small at the same time GENIUS with 1 ton would not find double beta decay. In the case of quasidegenerate models or degenerate models, on the other hand, $0\nu\beta\beta$ decay should be found by GENIUS, unless the CP–phases between the different mass eigenstates take on some special combinations and have a relative minus sign, see the discussion in [Kla98c].

Cold Dark Matter

Weakly interacting massive particles (WIMPs) are candidates for the cold dark matter in the universe. The favorite WIMP candidate is the lightest supersymmetric particle, presumably the neutralino. The expected detection rates for neutralinos of typically less than one event per day and kg of detector mass [Bed94, Bed97a, Bed97b, Jun96], however, make direct searches for WIMP scattering experimentally a formidable task.

Fig. 14 shows a comparison of existing constraints and future sensitivities of cold dark matter experiments, together with the theoretical expectations for neutralino scattering rates [Bed97b]. Obviously, GENIUS could easily cover the range of positive evidence for dark matter recently

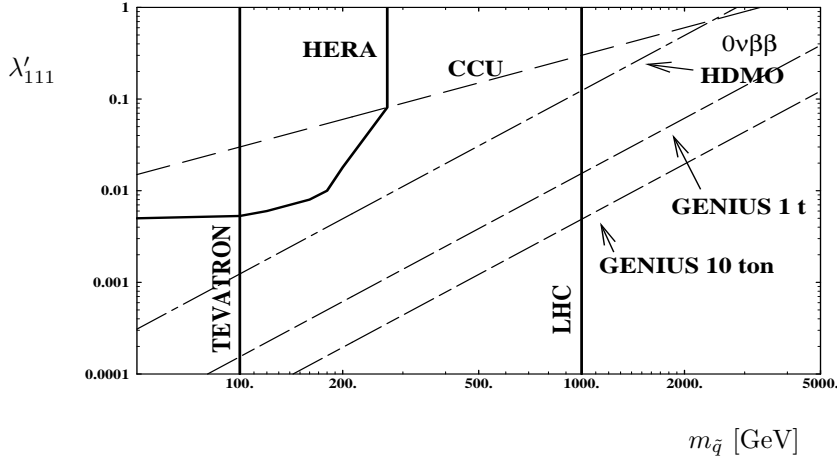

Fig. 12 Comparison of sensitivities of existing and future experiments on R_p SUSY models in the plane $\lambda'_{111} - m_{\bar{q}}$. Note the double logarithmic scale! Shown are the areas currently excluded by the experiments at the TEVATRON, the limit from charged-current universality, denoted by CCU, and the limit from absence of $0\nu\beta\beta$ decay from the Heidelberg-Moscow collaboration ($0\nu\beta\beta$ HDMO). In addition, the estimated sensitivity of HERA and the LHC is compared to the one expected for GENIUS in the 1 ton and the 10 ton version.

claimed by DAMA [Ber97b, Bot97]. It would also be by far more sensitive than all other dark matter experiments at present under construction or proposed, like the cryogenic experiment CDMS. Furthermore, obviously GENIUS will be the only experiment, which could seriously test the MSSM predictions over the whole SUSY parameter space. In this way, GENIUS could compete even with LHC in the search for SUSY, see for example the discussion in [Bae97]. It is important to note, that GENIUS could reach the sensitivity shown in Fig. 14 with only 100 kg of *natural* Ge detectors in a measuring time of three years [Kla98d].

Finding the neutralino with GENIUS would imply typical limits on R-parity violating couplings of the order of $10^{-(16-20)}$ for any of the λ_{ijk} , λ'_{ijk} or λ''_{ijk} in the superpotential (eq. 11).

4.2.5 GENIUS and solar neutrinos

The potential of GENIUS to measure the spectrum of low energy solar neutrinos in real time has been studied by [Bau99b]. The detection reaction

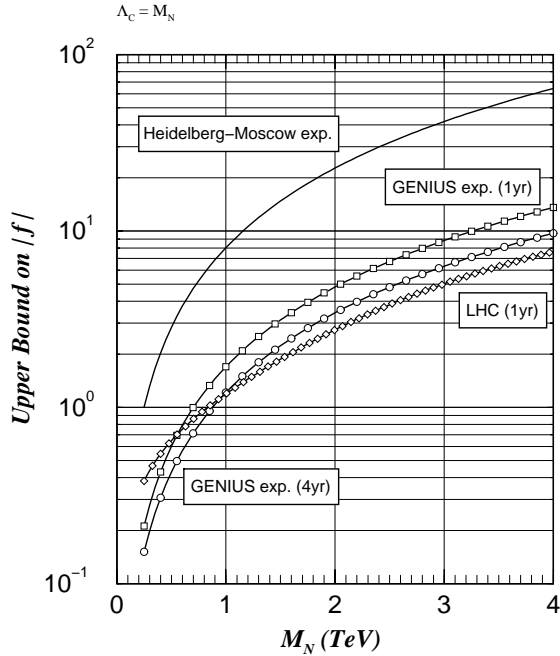

Fig. 13 Sensitivity of LHC and GENIUS to compositeness parameters (assuming $\Lambda_C = M_N$). Regions above the curves are excluded. The LHC bound is weaker than the GENIUS bound for $M_N < 550(1000)$ GeV. (from [Pan99])

is elastic neutrino electron scattering, $\nu + e \rightarrow \nu + e$. The energy threshold is a few keV, the expected number of events for a target of one ton of (natural or enriched) Germanium is 3.6 events/day in the standard solar model. Achieving a background low enough to measure the low energy solar neutrino spectrum should be possible.

5. Conclusion

Double beta decay has a broad potential for providing important information on modern particle physics beyond present and future high energy accelerator energies which will be competitive for the next decade and more. This includes SUSY models, compositeness, left-right symmetric models, leptoquarks, the neutrino and sneutrino mass and tests of Lorentz invariance and equivalence principle in the neutrino sector. Results have been

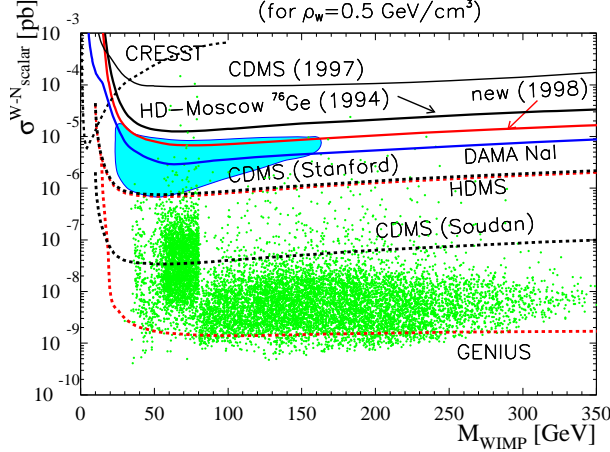

Fig. 14 WIMP–nucleon cross section limits in pb for scalar interactions as function of the WIMP–mass in GeV. Regions beyond solid lines are excluded by experiment [HM94, HM98, Ber97a, Ake97]. Further shown are expected sensitivities of experiments under construction (dashed lines for HDMS [Bau97, Kla97d], CDMS [Ake97], CRESST and for GENIUS). These limits are compared to theoretical expectations (scatter plot) for WIMP–neutralino cross sections calculated in the MSSM framework with non–universal scalar mass unification [Bed97b]. The 90 % allowed region claimed by [Ber97b] (light filled area), which is further restricted by indirect dark matter searches [Bot97] (dark filled area), could already be easily tested with a 100 kg version of the GENIUS experiment.

deduced from the HEIDELBERG–MOSCOW experiment for these topics and have been presented. For the neutrino mass double beta decay now is particularly pushed into a key position by the recent possible indications of beyond standard model physics from the side of solar and atmospheric neutrinos, dark matter COBE results and others. Neutrino mass scenarios which could explain these observations, can be checked already now by double beta decay. The HEIDELBERG–MOSCOW experiment has reached a leading position among present $\beta\beta$ experiments and as the first of them yields results in the sub–eV range – with striking consequences on presently discussed neutrino mass textures.

A future double beta experiment (GENIUS) with highly increased sensitivity based on use of 1 ton or more of enriched ‘naked’ ^{76}Ge detectors in liquid nitrogen would be a breakthrough into the multi–TeV range for many beyond standard models. The sensitivity for the neutrino mass would reach down to 0.01 or even 0.001 eV. The experiment would be competitive to LHC with respect to the mass of a right–handed W boson, in search for

R-parity violation and others, and would improve the leptoquark and compositeness searches by considerable factors. It would probe the Majorana electron sneutrino mass more sensitive than NLC (Next Linear Collider). It would yield constraints on neutrino oscillation parameters far beyond all present terrestrial $\nu_e - \nu_x$ neutrino oscillation experiments and could test directly the large and, for degenerate models, even the small angle solution of the solar neutrino problem. GENIUS would cover the full SUSY parameter space for prediction of neutralinos as cold dark matter and compete in this way with LHC in the search for supersymmetry. Even if SUSY would be first observed by LHC, it would still be fascinating to verify the existence and properties of neutralino dark matter, which could be achieved by GENIUS. GENIUS could also serve as a first real time detector for solar pp-neutrinos. Concluding, GENIUS has the ability to provide a major tool for future particle- and astrophysics.

Finally it may be stressed that the technology of producing and using enriched high purity germanium detectors, which have been produced for the first time for the Heidelberg-Moscow experiment, has found meanwhile applications also in pre-GENIUS dark matter search [HM94, Fal94, Kla97d, Bau97] and in high-resolution γ -ray astrophysics, using balloons and satellites [Kla91, Kla94, Bar93] [Bar94, Boc94, Kla97b, Kla98h].

References

- [Adh98] R. Adhikari, G. Rajasekaran, hep-ph/9812361v3, Dec1998
- [Ake97] D.S. Akerib et al. (CDMS collab.), preprint astro-ph/9712343
- [Ale94] A. Alessandrello et al., Phys. Lett **B 335** (1994) 519
- [Als89] M. Alston-Garnjost et al., Phys. Rev Lett. **71** (1993) 831
- [Alt97] G. Altarelli, J. Ellis, G.F. Giudice, S. Lola, M.L. Mangano, preprint hep-ph/9703276
- [Ath96] C. Athanassopoulos *et al.*, LSND collab., Phys. Rev. **C 54** (1996) 2685, Phys. Rev. Lett. **77** (1996) 3082
- [Bab95] K.S. Babu, R.N. Mohapatra, Phys. Rev. Lett. **75** (1995) 2276
- [Bab97a] K.S. Babu et al., preprint hep-ph/9703299 (March 1997)
- [Bab97b] K.S. Babu *et al.*, preprint hep-ph/9705414v2 (1997)
- [Bae97] H. Baer, M. Bhrlík, hep-ph/9706509
- [Bah98] J.N. Bahcall, P.I. Krastev, A.Yu. Smirnov, Phys. Rev. **D 58** (1998) 096016
- [Bam95a] P. Bamert, C.P. Burgess, R.N. Mohapatra, Nucl. Phys. **B 438** (1995) 3
- [Bam95b] P. Bamert, C.P. Burgess, R.N. Mohapatra, Nucl. Phys. **B 449** (1995) 25

- [Bar93] S.D. Barthelmy *et al.*, AIP Conf. Proc. 280 (1993) 1166
- [Bar94] S. D. Barthelmy *et al.*, Astrophys. J. **427** (1994) 519
- [Bar97] A.S. Barabash, Proc. NEUTRINO 96, Helsinki, June 1996, World Scientific, Singapore (1997), p. 374
- [Bar98] G. Barenboim, F. Scheck, hep-ph/9808327
- [Bau97] L. Baudis, J. Hellmig, H.V. Klapdor-Kleingrothaus, A. Müller, F. Petry, Y. Ramachers, H. Strecker, Nucl. Inst. Meth. **A 385** (1997) 265
- [Bau98] L. Baudis, G. Heusser, B. Majorovits, Y. Ramachers, H. Strecker, H.V. Klapdor-Kleingrothaus, hep-ex/9811040 and Nucl. Instr. Meth. **A 426** (1999) 425
- [Bau99a] L. Baudis *et al.* (Heidelberg-Moscow collab.), hep-ex/9902014 and Phys. Rev. **D**, in press (1999)
- [Bau99b] L. Baudis, H.V. Klapdor-Kleingrothaus, Eur. Phys. J. A, in press and hep-ex/9906044
- [Bed94] V. Bednyakov, H.V. Klapdor-Kleingrothaus, S.G. Kovalenko, Phys. Lett. **B 329** (1994) 5 and Phys. Rev. **D 50** (1994) 7128
- [Bed97a] V. Bednyakov, H.V. Klapdor-Kleingrothaus, S.G. Kovalenko, Phys. Rev. **D 55** (1997) 503
- [Bed97b] V. Bednyakov, H.V. Klapdor-Kleingrothaus, S.G. Kovalenko, Y. Ramachers, Z. Phys. **A 357** (1997) 339
- [Bed97c] V. Bednyakov, V.B. Brudanin, S.G. Kovalenko, Ts. D. Vylov, Mod. Phys. Lett **A 12** (1997) 233
- [Bed98] V. Bednyakov, A. Faessler, S. Kovalenko, hep-ph/9808224v2
- [Bel96] G. Belanger, F. Boudjema, D.London, H. Nadeau, Phys. Rev. **D 53** (1996) 6292
- [Bel98] G. Belanger, Proc. Int. Conf. on Lepton and Baryon Number Violation in Part. Phys. and Cosmology, Trento, Italy, april 20-25, 1998, editors: H.V. Klapdor-Kleingrothaus and I. Krivoshina (IoP, Bristol, 1999)
- [Ber95] Z. Berezhiani, R.N. Mohapatra, Phys. Rev. **D 52** (1995) 6607
- [Ber97a] R. Bernabei *et al.*, Phys. Lett. **B 389** (1997) 757
- [Ber97b] R. Bernabei *et al.*, ROM2F/97/33; P. Belli at TAUP, Gran Sasso, Sept. 7 (1997)
- [Bha97] G. Bhattacharyya, in [Kla98]
- [Bil99] S.M. Bilenky *et al.*, hep-ph/9907234
- [Boc94] J. Bockholt, H.V. Klapdor-Kleingrothaus, Nucl. Phys. **B** (Proc. Suppl.) 35 (1994) 403
- [Bot97] A. Bottino *et al.*, hep-ph/9709292
- [Buc87] W. Buchmüller, R. Rückl and D. Wyler, Phys.Lett. B191 (1987) 442.
- [Bur93] C.P. Burgess, J.M. Cline, Phys. Lett. **B 298** (1993) 141; Phys. Rev. **D 49** (1994) 5925

- [Bur96] C.P.Burgess, in [Kla96a]
- [Bur99] S. Burles, K.M. Nollet, J.N. Truram, M.S. Turner, astro-ph/9901157
- [But93] M. N. Butler *et al.*, Phys. Rev. **D47**, 2615 (1993); A. Halprin and C. N. Leung, Phys. Rev. Lett. **67**, 1833 (1991); J. Pantaleone, A. Halprin, and C. N. Leung, Phys. Rev. **D47**, R4199 (1993); K. Iida, H. Minakata and O. Yasuda, Mod. Phys. Lett. **A8** (1993) 1037.
- [Cal93] D.O. Caldwell, R.N. Mohapatra, Phys. Rev. **D 48** (1993) 3259
- [Car93] C.D. Carone, Phys. Lett. **B 308** (1993) 85
- [Cho97] D. Choudhury, S. Raychaudhuri, preprint hep-ph/9702392
- [Cli97] D. Cline, in: Proceedings of the *International Workshop Dark Matter in Astro- and Particle Physics* (DARK96), Eds. H.V. Klapdor-Kleingrothaus, Y. Ramachers, World Scientific 1997, p. 479
- [Col97] S. Coleman and S.L. Glashow, Phys. Lett. **B 405**, 249 (1997).
- [Cza99] M. Czakon, J. Gluza, M. Zralek, hep-ph/9906381
- [Dan95] F. A. Danevich et al., Phys. Lett. **B 344** (1995) 72
- [Doi85] M. Doi, T. Kotani, E.Takasugi, Progr. Theor. Phys. Suppl. **83** (1985) 1
- [Doi93] M. Doi, T. Kotani, Progr. Theor. Phys. **89** (1993) 139
- [Dre97] G. Drexlin, Proc. Internat. School on Neutrino Physics, Erice, Italy, Sept. 1997, to be publ. in Plenum Press
- [Ell87] S.R. Elliot, A.A. Hahn, M.K. Moe, Phys. Rev. Lett. **59** (1987) 1649
- [Ell92] S. R. Elliott et al., Phys. Rev. **C 46** (1992) 1535
- [Fal94] T. Falk, A. Olive, M. Srednicki, Phys. Lett. **B339** (1994) 248
- [Fel98] G. J. Feldman and R. D. Cousins, Phys. Rev. **D57** (1998) 3873
- [Fri88] J.Friemann, H.Haber, K.Freese, Phys. Lett. **B 200** (1988) 115; J. Bahcall, S. Petcov, S. Toshev and J.W.F. Valle, Phys.Lett. **B 181** (1986) 369; Z. Berezhiani and M. Vysotsky, Phys. Lett. **B 199** (1988) 281.
- [Fri95] H. Fritzsch and Zhi-zhong Xing, preprint hep-ph/9509389, Phys. Lett. **B 372** (1996) 265
- [Fuk99] Y. Fukuda *et al.*, Phys. Rev. Lett. **82** (1999) 1810
- [Gas89a] M. Gasperini, Phys. Rev. **D38**, 2635 (1988); *ibid.* **D39**, 3606 (1989).
- [Gas89b] M. Gasperini, Phys. Rev. Lett. **62**, 1945 (1989).
- [Geo81] H.M. Georgi, S.L.Glashow and S. Nussinov, Nuc. Phys. **B 193** (1981) 297
- [Giu99] C. Giunti, hep-ph/9906275 (June 1999)
- [Gla97] S.L. Glashow, A. Halprin, P.I. Krastev, C.N. Leung, and J. Panteleone, Phys. Rev. **D 56**, 2433 (1997).
- [Gon95] M. Gonzalez-Garcia, hep-ph/9510419

- [Goo61] M.L. Good, Phys. Rev. **121**, 311 (1961); O. Nachtmann, Acta Physica Austriaca, Supp. VI *Particle Physics* ed. P. Urban, (1969) p. 485; S.H. Aronson, G.J. Bock, H-Y Cheng and E. Fishbach, **48**, 1306 (1982); Phys. Rev. **D28**, 495 (1983); I.R. Kenyon, Phys. Lett. **B237**, 274 (1990); R.J. Hughes, Phys. Rev. **D46**, R2283 (1992);
- [Gro90] K. Grotz, H.V. Klapdor, 'The Weak Interaction in Nuclear, Particle and Astrophysics' (Adam Hilger: Bristol, Philadelphia) 1990
- [H196] H1 Collab., S. Aid et al., Phys. Lett. B 369 (1996) 173
- [Hab93] H. E. Haber, in Proc. on Recent Advances in the Superworld, Houston, April 14-16 (1993), hep-ph/9308209
- [Hal84] L. Hall, M. Suzuki, Nuclear Physics **B 231** (1984) 419
- [Hal91] A. Halprin and C.N. Leung, Phys. Rev. Lett. **67**, 1833 (1991); Nucl. Phys. **B28A** (Proc. Supp.), 139 (1992); J. N. Bahcall, P. I. Krastev, and C. N. Leung, Phys. Rev. **D 52**, 1770 (1995); R.B. Mann and U. Sarkar, Phys. Rev. Lett **76** (1996) 865;
- [Hal96] A. Halprin, C.N. Leung, J. Pantalone, Phys.Rev. **D 53** (1996) 5365
- [Ham98] T. Hambye, R.B. Mann and U. Sarkar, Phys. Lett. **B 421**, 105 (1998); Phys. Rev. **D 58**, 025003 (1998).
- [Hat94] N. Hata, P. Langacker, Phys. Rev. **D 50** (1994) 632
- [Hel97] J. Hellmig, H.V. Klapdor-Kleingrothaus, Z. Phys. **A 359** (1997) 351
- [Hew97] J.L. Hewett, T.G. Rizzo, preprint hep-ph/9703337v3 (May1997)
- [Hir95a] M. Hirsch, H.V. Klapdor-Kleingrothaus, S.G. Kovalenko, Phys. Rev. Lett. 75 (1995) 17
- [Hir95b] M. Hirsch, H.V. Klapdor-Kleingrothaus, S. Kovalenko, Phys. Lett. **B 352** (1995) 1
- [Hir96a] M. Hirsch, H.V. Klapdor-Kleingrothaus, S.G. Kovalenko, Phys. Lett. **B 372** (1996) 181, Erratum: Phys. Lett. **B381** (1996) 488
- [Hir96b] M. Hirsch, H.V. Klapdor-Kleingrothaus, S.G. Kovalenko, Phys. Lett. **B 378** (1996) 17 and Phys. Rev. **D 54** (1996) R4207
- [Hir96c] M. Hirsch, H. V. Klapdor-Kleingrothaus, S. G. Kovalenko, H. Paes, Phys. Lett. **B 372** (1996) 8
- [Hir96d] M. Hirsch, H.V. Klapdor-Kleingrothaus, S. Kovalenko, Phys. Rev. **D 53** (1996) 1329
- [Hir96e] M. Hirsch, H.V. Klapdor-Kleingrothaus, in [Kla96a]; M. Hirsch, H.V. Klapdor-Kleingrothaus, O. Panella, Phys. Lett. **B 374** (1996) 7
- [Hir97a] M. Hirsch, H.V. Klapdor-Kleingrothaus, S.G. Kovalenko, Phys. Lett. **B 398** (1997) 311 and **403** (1997) 291
- [Hir97b] M. Hirsch, H.V. Klapdor-Kleingrothaus, S. Kovalenko, in [Kla98]
- [Hir97c] M. Hirsch, H.V. Klapdor-Kleingrothaus, Proc. Int. Workshop on Dark Matter in Astro- and Particle Physics (DARK96), Heidelberg, Sept. 1996, Eds. H.V. Klapdor-Kleingrothaus and Y. Ramachers (World Scientific, Singapore) 1997, p. 640

- [Hir98a] M. Hirsch, H.V. Klapdor–Kleingrothaus, St. Kolb, S.G. Kovalenko, Phys. Rev. **D 57** (1998) 2020
- [Hir98b] M. Hirsch, H.V. Klapdor–Kleingrothaus, S.G. Kovalenko, Phys. Rev. **D 57** (1998) 1947
- [HM94] HEIDELBERG–MOSCOW collab., Phys. Lett. **B 336** (1994) 141
- [HM95] HEIDELBERG–MOSCOW collab., Phys. Lett. **B 356** (1995) 450
- [HM96] HEIDELBERG–MOSCOW collab., Phys. Rev. **D 54** (1996) 3641,
- [HM97] HEIDELBERG–MOSCOW collab., Phys. Rev. **D 55** (1997) 54 and Phys. Lett. **B 407** (1997) 219
- [HM98] HEIDELBERG–MOSCOW collab., Phys. Rev. **D 59** (1998) 022001-1
- [Hug60] V.W. Hughes, H.G. Robinson, and V. Beltran-Lopez, Phys. Rev. Lett. **4**, 342 (1960); R.W.P. Drever, Philos. Mag. **6**, 683 (1961); D. Newman, G.W. Ford, A. Rich and E. Sweetman, Phys. Rev. Lett. **40**, 1355 (1978); A. Brillat and J.L. Hall, Phys. Rev. Lett. **42**, 549 (1979); J.D. Prestage, J.J. Bollinger, W.M. Itano, and D.J. Wineland, Phys. Rev. Lett. **54**, 2387 (1985); S.K. Lamoureaux, J.P. Jacobs, B.R. Heckel, R.J. Raab, and E.N. Fortson, Phys. Rev. Lett. **57**, 3125 (1986).
- [Ioa94] A. Ioanissyan, J.W.F. Valle, Phys. Lett **B 322** (1994) 93
- [Joer94] V. Jörgens et al., Nucl. Phys. (Proc. Suppl.) **B 35** (1994) 378
- [Jun96] G. Jungmann, M. Kamionkowski, K. Griest, Phys. Rep. 267 (1996) 195
- [Kal97] J. Kalinowski et al., preprint hep-ph/9703288v2 (March 1997)
- [Kan97] G. Kane, in [Kla98]
- [Kla87] H.V. Klapdor–Kleingrothaus, MPI–H 1987, proposal
- [Kla91] H.V. Klapdor–Kleingrothaus, Proc. Int. Symposium on γ -Ray Astrophysics, Paris 1990, AIP Conf. Proc. 232 (1991) 464
- [Kla92] H.V. Klapdor–Kleingrothaus, K. Zuber, Phys. Bl. **48** (1992) 1017
- [Kla94] H.V. Klapdor–Kleingrothaus, Progr. Part. Nucl. Phys. **32** (1994)261
- [Kla95] H. V. Klapdor–Kleingrothaus, A. Staudt, Non–Accelerator Particle Physics, IOP Publ., Bristol, Philadelphia, 1995; and Teilchenphysik ohne Beschleuniger, Teubner Verlag, Stuttgart, 1995
- [Kla96a] H.V. Klapdor–Kleingrothaus and S. Stoica (Eds.), Proc. *Int. Workshop on Double Beta Decay and Related Topics*, Trento, 24.4.–5.5.95, World Scientific Singapore
- [Kla96b] H.V. Klapdor–Kleingrothaus, in Proc. *Int. Workshop on Double Beta Decay and Related Topics*, Trento, 24.4.–5.5.95, World Scientific Singapore 1996, Ed.: H.V. Klapdor–Kleingrothaus and S. Stoica
- [Kla97a] H.V. Klapdor–Kleingrothaus, Invited talk at NEUTRINO 96, Helsinki, June 1996, World Scientific Singapore 1997, p. 317
- [Kla97b] H.V. Klapdor–Kleingrothaus, M.I. Kudravnsev, V.G. Stolpovski, S.I. Svertilov, V.F. Melnikov, I. Krivosheina, J. Moscow. Phys. Soc. 7 (1997) 41

- [Kla97c] H.V. Klapdor–Kleingrothaus, M. Hirsch, Z. Phys. **A 359** (1997) 361
- [Kla97d] H.V. Klapdor–Kleingrothaus, Y. Ramachers, in: Proc. Int. Workshop on Dark Matter in Astro– and Particle Physics (DARK96) Sept. 1996, Eds. H.V. Klapdor–Kleingrothaus and Y. Ramachers, Heidelberg, (World Scientific Singapore) 1997, p. 459
- [Kla98] H.V. Klapdor–Kleingrothaus and H. Paes (Eds.), Beyond the Desert – Accelerator- and Non–Accelerator Approaches, IOP, Bristol, 1998
- [Kla98a] H.V. Klapdor–Kleingrothaus, in [Kla98]
- [Kla98b] H.V. Klapdor–Kleingrothaus, Int. J. Mod. Phys. **A 13** (1998) 3953–3992
- [Kla98c] H.V. Klapdor–Kleingrothaus, J. Hellmig, M. Hirsch, J. Phys. **G 24** (1998) 483–516
- [Kla98d] H.V. Klapdor–Kleingrothaus, Y. Ramachers, Eur. Phys. J. **A 3** (1998) 85
- [Kla98e] H.V. Klapdor–Kleingrothaus, H. Päs; in: Proc. of the 6th Symp. on Particles, Strings and Cosmology (PASCOS’98), Boston/USA, 1998
- [Kla98f] H.V. Klapdor–Kleingrothaus, H. Päs, U. Sarkar, Eur. Phys. J. **A 5** (1999) 3, and hep-ph/9809396
- [Kla98g] H.V. Klapdor–Kleingrothaus, Proc. NEUTRINO’98 (Takayama, Japan, June 1998) World Scientific, Singapore (1999)
- [Kla98h] H.V. Klapdor–Kleingrothaus et al., Adv. Space Res. **21** (1998) 347
- [Kla99a] H.V. Klapdor–Kleingrothaus, Proc. LEPTON and BARYON NUMBER VIOLATION in Particle Physics, Astrophysics and Cosmology, Trento, Italy, 20–25 April 1998, eds. H.V. Klapdor–Kleingrothaus and I.V. Krivosheina, IOP, (1999) 251
- [Kla99b] H.V. Klapdor–Kleingrothaus, H. Päs, A.Yu. Smirnov, to be publ.
- [Kol97] S. Kolb, M. Hirsch, H.V. Klapdor–Kleingrothaus, Phys. Rev. **D 56** (1997) 4161
- [Kuc95] R. Kuchimanchi, R.N. Mohapatra, Phys. Rev. Lett. **75** (1995) 3939
- [Kum96] K. Kume (ELEGANT collaboration), in [Kla96a]
- [Kuz90] V. Kuzmin, V. Rubakov, M. Shaposhnikov, Phys. Lett. **B 185** (1985) 36; M. Fukugita, T. Yanagida, Phys. Rev. **D 42** (1990) 1285; G. Gelmini, T. Yanagida, Phys. Lett. **B 294** (1992) 53; B. Campbell *et al.*, Phys. Lett. **B 256** (91) 457
- [Lan88] P. Langacker, in ‘Neutrinos’ (Springer: Heidelberg, New York), 1988, ed. H.V. Klapdor, p. 71
- [Lee94] D.G. Lee, R.N. Mohapatra, Phys. Lett. **B 329** (1994) 463
- [Ma99] E. Ma, hep-ph/9902392
- [Min97] H. Minakata, O. Yasuda, hep-ph/9712291
- [Moe91] M. K. Moe, Phys. Rev. **C 44** (1991) R931

- [Moe94] M. K. Moe, *Prog. Part. Nucl. Phys.* **32** (1994) 247; *Nucl. Phys. (Proc. Suppl.)* **B 38** (1995) 36
- [Moh86a] R.N. Mohapatra, *Phys. Rev. D* **34** (1986) 3457
- [Moh86b] R.N. Mohapatra, *Phys. Rev. D* **34** (1986) 909
- [Moh88] R.N. Mohapatra and E. Takasugi, *Phys. Lett.* **B 211** (1988) 192
- [Moh91] R.N. Mohapatra, P.B. Pal, 'Massive Neutrinos in Physics and Astrophysics' (World Scientific, Singapore) 1991
- [Moh92] R.N. Mohapatra, *Unification and Supersymmetry* (Springer: Heidelberg, New York) 1986 and 1992
- [Moh94] R.N. Mohapatra, *Progr. Part. Nucl. Phys.* **32** (1994) 187
- [Moh95] R.N. Mohapatra, S. Nussinov, *Phys. Lett.* **B 346** (1995) 75
- [Moh96a] R.N. Mohapatra, A. Rasin, *Phys. Rev. Lett.* **76** (1996) 3490 and *Phys. Rev. D* **54** (1996) 5835
- [Moh96b] R.N. Mohapatra, in [Kla96a]
- [Moh97a] R. N. Mohapatra, *Proc. Neutrino 96*, Helsinki, 1996, World Scientific Singapore, 1997, p. 290
- [Moh97b] R.N. Mohapatra, *Proc. Int. School on Neutrinos*, Erice, Italy, Sept. 1997, *Progr. Part. Nuc. Phys.* **40** (1998)
- [Mut88] K. Muto, H.V. Klapdor, in 'Neutrinos (Springer: Heidelberg, New York) 1988, ed. H.V. Klapdor, p. 183
- [Mut89] K. Muto, E. Bender, H.V. Klapdor, *Z. Phys.* **A 334** (1989) 177,187;
- [NEM94] NEMO Collaboration, *Nucl. Phys. (Proc. Suppl.)* **B 35** (1994) 369
- [Nar95] E. Nardi *et al.*, *Phys. Lett.* **B 344**(1995) 225
- [Nor97] D. Normile, *Science* 276 (1997) 1795
- [PDG94] Particle Data Group, *Phys. Rev. D* **50** (1994)
- [Päs96] H. Paes *et al.*, in [Kla96a];
- [Päs97] H. Paes, M. Hirsch, H.V. Klapdor–Kleingrothaus, S.G. Kovalenko, in [Kla98]
- [Päs99] H. Päs, M. Hirsch, H.V. Klapdor–Kleingrothaus, S.G. Kovalenko, *Phys. Lett.* **B 453** (1999) 194
- [Pan96] O. Panella, in [Kla96a]
- [Pan97a] O. Panella, in [Kla98]
- [Pan96b] G. Pantis, F. Simkovic, J.D. Vergados, A. Faessler, *Phys. Rev. C* **53** (1996) 695
- [Pan99] O. Panella *et al.*, hep-ph/9903253v2
- [PDG98] Particle Data Group, *Eur. Phys. J.* **C 3** (1998) 1
- [Pel93] J. Peltoniemi, J. Valle, *Nucl. Phys.* **B 406** (1993) 409
- [Pel95] J.T. Peltoniemi, preprint hep-ph/9506228

- [Pet94] S.T. Petcov, A.Yu. Smirnov, Phys. Lett. **B 322** (1994) 109
- [Pet96] S. Petcov, in [Kla96a]
- [Piq96] F. Piquemal *et al.*, in [Kla96a]
- [Pri98] J.R. Primack, M.A.K. Gross, astro-ph/9810204
- [Rag94] R. S. Raghavan, Phys. Rev. Lett. **72** (1994) 1411
- [Riz96] T.G. Rizzo, hep-ph/9612440
- [Sch81] J. Schechter, J.W.F. Valle, Phys. Rev. **D 25** (1982) 2951
- [Smi96] A. Yu. Smirnov, Proc. Int. Conf. on High Energy Physics, Warsaw 1996, hep-ph/9611465v2 (Dec 1996)
- [Sou92] I.A. D'Souza. C.S. Kalman, Preons, Models of Leptons , Quarks and Gauge bosons as Composite Objects (World Scientific, Singapore) 1992
- [Sta90] A. Staudt, K.Muto, H.V. Klapdor-Kleingrothaus, Europhys. Lett. **13** (1990) 31
- [Suz97] A. Suzuki, priv. comm. 1997, and KAMLAND proposal, (in Japanese)
- [Tak96] E.Takasugi, in [Kla96a]
- [Tak97] E. Takasugi, in [Kla98]
- [Tre95] V.I. Tretyak, Yu. Zdesenko, At. Data Nucl. Data Tables **61** (1995) 43
- [Val96] J.W.F. Valle, in [Kla96a]
- [Vis99] F. Vissani, hep-ph/9906525
- [Vui93] J.-C. Vuilleumier et al., Phys. Rev. **D 48** (1993) 1009
- [Wil92] C. M. Will, *Theory and Experiment in Gravitational Physics*, 2nd edition (Cambridge University Press, Cambridge, 1992).
- [Wol81] L. Wolfenstein, Phys. Lett **107 B** (1981) 77
- [You95] Ke You et al., Phys. Lett. **B 265** (1995) 53