

ANL-HEP-PR-00-011
November 26, 2024

THE PAST AND FUTURE OF S-MATRIX THEORY *

Alan. R. White[†]

High Energy Physics Division
Argonne National Laboratory
9700 South Cass, Il 60439, USA.

Contribution to “Scattering”, edited by E. R. Pike and P. Sabatier,
to be published by Academic Press.

*Work supported by the U.S. Department of Energy, Division of High Energy Physics,
Contracts W-31-109-ENG-38 and DEFG05-86-ER-40272

[†]arw@hep.anl.gov

CONTENTS

1. **Introduction.**
2. **The Early Years.**
 - 2.1 Living Without Field Theory.
 - 2.2 Initial Postulates.
 - 2.3 Further Postulates.
 - 2.4 QCD and a Final Postulate.
 - 2.5 Analyticity in Field Theory.
3. **Axiomatic S-Matrix Theory.**
 - 3.1 Unitarity, Bubble Diagrams and Landau Diagrams.
 - 3.2 The Landau Equations and the “+ α ” Condition.
 - 3.3 Macrocausality and Essential Support.
 - 3.4 The Structure Theorem.
 - 3.5 Local Discontinuity Formulae.
 - 3.6 Good and Bad Functions and the Steinmann Relations.
 - 3.7 Global Discontinuity Formulae.
 - 3.8 CPT, Hermitian Analyticity, etc.
 - 3.9 Holonomy.
4. **Asymptotic S-Matrix Theory.**
 - 4.1 The Elastic Scattering Asymptotic Dispersion Relation.
 - 4.2 Multiparticle Kinematics and Analyticity Domains.
 - 4.3 Multiparticle Asymptotic Dispersion Relations.
 - 4.4 Classification of Multiple Discontinuities.

5. **Multi-Regge Theory.**

- 5.1 Partial-Wave Expansions.
- 5.2 Froissart-Gribov Continuations.
- 5.3 Sommerfeld-Watson Representations.
- 5.4 Reggeon Unitarity.

6. **Reggeon Field Theory.**

- 6.1 Pomeron Phase-Space and the Effective Lagrangian.
- 6.2 The Critical Pomeron.
- 6.3 The Super-Critical Pomeron.

7. **QCD and the Critical Pomeron.**

- 7.1 Reggeon Diagrams in QCD.
- 7.2 Color Superconductivity and the Super-Critical Pomeron.
- 7.3 Quark Saturation and an Infra-Red Fixed Point.
- 7.4 Uniqueness of the S-Matrix ?

1 Introduction.

S-Matrix Theory was initially developed as a means to go beyond the weak-coupling perturbation expansions of field theory and at the same time avoid infinite renormalization effects. Landau was the first to emphasize that the singular or “imaginary” parts of perturbative diagrams involve only on mass-shell intermediate states and so are free of renormalization problems (Landau, 1959). He also argued that the analyticity properties needed to reconstruct a full amplitude from the imaginary part, via a dispersion relation, would be a consequence of the underlying local causality of the interaction. The arguments of Landau, and many others, raised the hope that if analyticity properties were exploited a strong interaction S-Matrix could be self-consistently calculated diagrammatically without encountering divergences, even when this interaction could not be described by field theory. (In fact the absence of a Mandelstam representation (Mandelstam, 1958,1961) for multiparticle amplitudes prevents an iterative perturbation expansion using discontinuities plus dispersion relations - a problem that is currently circumvented only in the regge limit.) At the time it was believed that local quantum field theory could not produce an interaction for which multiple short-distance interactions did not become uncontrollably strong[‡] (Landau 1955; Landau and Pomeranchuk 1955). The short-distance decrease of the coupling (asymptotic freedom) in non-abelian gauge theories such as QCD (Gross and Wilczek, 1973,1974; Politzer, 1974) was not known, of course. In a sense, the attempts to develop S-Matrix Theory as an independent formalism based on analyticity anticipated that the strong interaction would eventually be understood as a local interaction. QCD was formulated over twenty-five years ago and is now established[§] as the (underlying) field theory of the strong interaction. Paradoxically, perhaps, the locality of the interaction is described in terms of gauge-dependent fields whose relation to the asymptotic states of the theory is so complicated that it is not yet understood. Consequently, determining the QCD S-Matrix is a highly non-trivial problem that is currently a long way from being solved and in which, because the necessary analyticity properties should be present, S-Matrix Theory may yet have a role.

In its formal foundation during the early sixties, S-Matrix Theory was the name given to a broad set of principles and assumptions involving analyticity properties that were postulated to be sufficient to dynamically determine the strong interaction S-Matrix (Chew, 1962; Stapp, 1962; Gunson, 1965; Eden et al., 1964). These principles were mostly extracted from quantum field theory but were supposed to be able to stand alone. In fact, since in isolation they appeared rather abstract and mathematical there was, from the outset, considerable argument as to whether these principles constituted a complete physical “theory” in any conventional sense.

[‡]We use “uncontrollable” as a non-technical description of the technical property that the perturbation expansion in powers of the coupling constant is so wildly divergent that there is no summation procedure that allows it to be used to define the theory.

[§]The detailed formulation of the Standard Model, including both Quantum Chromodynamics (QCD) and the Electroweak Interaction, is described in later chapters.

“... the possibility of analytically continuing a function into a certain region is a very mathematical notion, and to adopt it as a fundamental postulate rather than a derived theorem appears to us to be rather artificial.” (Mandelstam, 1961)

“... when you find that the particles that are there in S-Matrix Theory ... satisfy all these conditions, all you are doing is showing that the S-Matrix is consistent with the world the way it is, ... you have not necessarily explained that they are there.” (Low, 1966)

Nevertheless, the early (pre-QCD) period during which S-Matrix Theory was in its ascendancy is a colorful, philosophical, and even prophetic, part of the past that we will briefly review to provide historical perspective. As a self-contained dynamical framework, S-Matrix Theory probably reached its peak with the formulation of dual resonance models, which then evolved into the string theories that are the basis for much of particle theory today. However, we will not attempt to bring such theories under the umbrella of what we call S-Matrix Theory.

Out of the initial formative period there also grew a smaller, but more mathematical, school of “Axiomatic S-Matrix Theory” (Iagolnitzer, 1976a,1978,1981,1993; Stapp, 1976a) that had less commitment to dynamical applications but rather concentrated on establishing analyticity properties directly from S-Matrix principles that were clearly formulated independently of field theory. Eventually a classical correspondence principle for the S-Matrix, called macrocausality, was shown to lead directly to, and in fact to be equivalent to, local analyticity properties. A number of important results were obtained using macrocausality as a basic starting point that will surely carry over into whatever the future holds for the subject. Although there have not been any recent developments, we will outline the basic results with emphasis on those that we anticipate will have a major role in the most immediate future.

While there is little current activity in formal four-dimensional S-Matrix Theory, in two space-time dimensions there is a very active “Exact S-Matrices” field of research. This field is particularly interesting because, in theories that defy exact solution in the field theory sense, the abstract S-Matrix principles have led to the discovery of complete formulae for S-Matrices. Nevertheless, these results do not have any direct relation to the four-dimensional formalism with which this review is primarily concerned. Therefore, because of length limitations, we will not discuss these results in detail but rather refer the interested reader to a number of good reviews that already exist in the literature (Dorey, 1998; Mussardo, 1992; Zamolodchikov and Zamolodchikov, 1979).

A central theme which dominates the latter part of the article is that the asymptotic multi-regge region is where (at present) the general properties of the S-Matrix appear to be the most powerful. In this kinematic regime S-Matrix amplitudes have a simple analytic structure that closely reflects the primitive analyticity domains of local field theory (Epstein et al., 1976, Cahill and Stapp, 1975). The physical region discontinuity structure needed to write multiple dispersion relations is established within S-Matrix Theory (Stapp,

1976a,1976b) and the relationship to the causality properties of field theory Green's functions is understood. As a consequence multiparticle complex angular momentum theory, as proposed and developed primarily by Gribov and collaborators (Gribov, 1962,1969; Gribov et al., 1965), can be put on a firm foundation (White, 1976,1991). Most importantly, the regge limit S-Matrix is controlled by unitarity equations formulated directly in the angular momentum plane (Gribov et al., 1976; White, 1976, 1991). By design, these equations are satisfied by Reggeon Field Theory (Gribov, 1967,1968; Abarbanel et al., 1974). The "Critical Pomeron", formulated using Reggeon Field Theory, provides the only known non-trivial unitary high-energy S-Matrix (Migdal et al., 1974; Abarbanel and Bronzan, 1974).

In considering future applications, we note first that since the S-Matrix is surely the most important if not (in a broad sense) the only physical quantity that needs to be calculated in a theory, any formalism which helps in this purpose can be expected to retain some general usefulness. There have been, and will continue to be, direct applications to spontaneously-broken non-abelian gauge theories, particularly in the regge region. Theories of this kind are of interest both for the electroweak sector of the Standard Model and for providing an infra-red regulated version of QCD. When the gauge symmetry is broken completely by fundamental representation scalars the theory can be formulated gauge-invariantly (Banks and Rabinovici, 1979; 't Hooft, 1980). There are no infra-red problems, all particles are massive, and both the global analyticity properties of abstract field theory and pure S-Matrix results apply to any finite order of the perturbative expansion. The most elaborate perturbative regge region calculations have been done in such theories using, essentially, S-Matrix techniques (Fadin et al., 1977; Fadin and Lipatov, 1996; Bartels, 1993) and this will surely continue into the future. Indeed, regge behavior is as definitive an S-Matrix property of a perturbative massive non-abelian gauge theory (Grisaru and Schnitzer, 1979) as is the much more widely appreciated off-shell property of asymptotic freedom. The non-perturbative formulation of such theories has the serious problem that the self-interactions of the scalar fields involved are not asymptotically free and so are uncontrollable in the ultra-violet region.

The current interest of most theorists is in going beyond the Standard Model. Given the wide array of supersymmetric and grand unified field theories, string theories, and most recently M-theory, that make up the playbook for a particle theorist looking for interesting phenomena outside the Standard Model, any immediate relevance for an abstract technical formalism that applies only to a (four-dimensional) S-Matrix seems unlikely. If a better understanding of QCD is needed before the correct extension of the Standard Model can be found then a role for S-Matrix Theory in the search might be argued for.

In general we anticipate that the main future applications for S-Matrix Theory will be to QCD, even though some sociological resistance may be encountered. Recent reviews of the discovery and development of QCD have tended to portray the preceding S-Matrix era (and by implication any succeeding S-Matrix formalism) as fruitless and outmoded following the advent of QCD (Gross, 1999; 't Hooft, 1999). In some small part, this is probably a

reaction to the unconcealed desire of some of the early, most passionate, S-Matrix advocates to proclaim the uselessness (if not the death) of local field theory.

“... let me say at once that I believe the conventional association of fields with strongly interacting particles to be empty. ... no aspect of strong interactions has been clarified by the field concept.” (Chew, 1962)

We should note that not all S-Matrix theorists adopted this last point of view, even in the early days.

“Some physicists have suggested retaining only the S-Matrix in our theory and discarding the remainder of the field theoretic framework One cannot then carry through the proofs of dispersion relations and analyticity properties, since the concepts on which they are based, ... are essentially field theoretic ... it is not at all evident to us that all physics is contained in the S-Matrix.” (Mandelstam, 1961)

Nevertheless, upon its discovery, QCD was seen as the triumphant return of strong interaction field theory that should clearly vanquish all opponents and all alternative formalisms (see for example De Rujala et al., 1975). As we have already noted, the crucial property of asymptotic freedom confounded the belief that a consistent short-distance field theory interaction could not be found. Even so, from the viewpoint of previously existing axiomatic formulations, where it was always envisaged that there would be some direct relationship between the fields and the asymptotic states, QCD is a very radical and unconventional field theory. The gauge-dependence of the fields is a deep property that is intricately involved in making the short-distance part of the interaction finite but that has to be absent in all physical quantities. All the problems of the theory are at large distances. The S-Matrix of particles corresponding to the fields does not exist, even in perturbation theory, because of infra-red divergences. Conversely the physical particle states correspond to complicated field configurations that may be only indirectly related to local operators.

Although it remains unproven, the uncontrollable infra-red behavior of the QCD perturbation expansion is widely believed to be resolved by the confinement of color charge, implying that the underlying fields are definitively unobservable. Almost invariably, though, the analyses and arguments for confinement are made in the context of the euclidean path integral on which modern (non-perturbative) field theory is based. Given the bad infra-red properties of perturbation theory, obtaining an appropriate Minkowski space of physical states and a unitary S-Matrix is an additional intricate demand[¶] that surely is unlikely to be satisfied for each and every non-abelian gauge theory, as current wisdom would appear to imply.

“We now know that there are an infinite number of consistent S-Matrices that satisfy all the sacred principles. One can take any non-abelian gauge theory, with any gauge group, and many sets of fermions ... ” (Gross, 1999)

[¶]It is only rarely acknowledged (see, for example, Weinberg, 1996) that the non-perturbative euclidean formulation of a field theory contains no inbuilt guarantee of unitarity in Minkowski space.

There is currently a wide body of knowledge on the non-perturbative properties of field theories, most notably exploiting the lattice formulation or, in the case of supersymmetric theories, duality properties relating large and small momentum regions. In general, however, any possible particle S-Matrix remains far away from the domain of applicability of known non-perturbative results. Certainly, no S-Matrix has been directly calculated, or even shown to exist outside of the perturbation expansion, for any four-dimensional theory. Indeed the four-dimensional (infinite volume) euclidean path integral also has yet to be proven to exist. At this point we would like to refer to a comment of Feynman that was made nearly forty years ago but remains every bit as true today (particularly if the roles of field theory and S-Matrix theory are interchanged, as we have taken the liberty of doing).

“During all this time, no complete solution either of the field equations or of the S-Matrix has really been produced. You sit there and say: why isn’t everybody doing field theory; another guy says: why isn’t anybody doing S-Matrix theory? The real problem is: WHY IS NOBODY SOLVING ANYTHING?”

One of the reasons why you don’t solve the problems is that you don’t work hard enough. One of the reasons it is and has always been difficult to work hard on these problems is that nature keeps telling us it has the quality of being much more elaborate than we thought.” (Feynman, 1961)

It could yet be that the pathological properties of QCD as a field theory will require that special S-Matrix based techniques be developed to directly construct the physical hadron S-Matrix. In this case, the more balanced view of those who remained agnostic in the heat of the ideological battle between field theory and S-Matrix theory may yet be seen as having long-term truth. The following comment was made in the midst of the discovery of QCD.

“The quarks inside a hadron seem to be very light, and almost free. Yet they are not produced, even in very high energy reactions. This is an unresolved mystery. Nevertheless, if we imagine that a resolution can be found, we may then have a meeting of field theory and nuclear democracy: all observable states will be bound states of quarks, and thus none will be elementary; the dynamics of the quark fields will determine the hadron spectrum, and the fields will make up the currents which carry the weak and electromagnetic interactions. S-Matrix theory will describe the particles from the outside, and field theory from the inside. There need be no contradiction.” (Low, 1974)

In fact, without the parton model, which is partially an embodiment of this last sentiment, very little of the hadron S-Matrix would be calculable with present knowledge. Unfortunately, the parton model has a solid basis only in the very limited kinematic regimes where leading twist perturbation theory can be consistently formulated.

Given the extensive regge region results referred to above, an obvious question for the immediate future is whether S-Matrix Theory can be used to obtain the regge limit of the QCD S-Matrix. A-priori this problem is, of course, much simpler than determining the full S-Matrix. It is also close to, although just beyond, the reach of perturbation theory.

As part of the argument for the futility of the S-Matrix era it has been said that the regge region was unduly emphasized and that today it is merely “an interesting, unsolved and complicated problem for QCD” (Gross, 1999). In fact this is the kinematic regime where the well-understood formalism of short-distance perturbative QCD comes closest to a direct confrontation with unitarity and the infra-red spectrum.

Using the language of reggeon diagrams, the regge region unitarity equations can be used to organize and predict to all-orders results obtained from direct perturbative calculations within QCD (Fadin et al., 1977; Bronzan and Sugar, 1978; White, 1993). It may then be possible to use a Reggeon Field Theory phase-transition formalism (White, 1991), with the U(1) anomaly providing a crucial ingredient (White, 1999), to connect the reggeon diagrams of QCD to the Critical Pomeron. Such manipulations could surely be described as “state of the art perturbation theory” (the general title of this Section) in the sense that S-Matrix Theory would be used to ultimately define the all-orders meaning of the QCD perturbation series.

Because of its unique proximity to the perturbative domain, the high-energy multi-regge region is probably the only kinematic regime where it might be possible to construct the physical S-Matrix (almost) directly from the perturbation expansion involving elementary fields. However, since all the basic properties of the physical spectrum, including confinement and chiral symmetry breaking, must be present in the regge region, an understanding of the asymptotic S-Matrix could be a very important step towards obtaining the full S-Matrix. Indeed, that a consistent unitary result be obtained is likely to be a strong constraint on the formulation of QCD which may even restrict the quark content of the theory. Building on this, at the end of this article, we very briefly discuss the extent to which the abstract properties that must be satisfied are so powerful that the strong interaction S-Matrix and, perhaps, even the full S-Matrix containing the electroweak interaction, might be determined by these properties.

2 The Early Years.

2.1 Living Without Field Theory.

S-Matrix Theory was born during a period when particle physicists were intensely scrutinising and reformulating all principles and concepts. The renormalizability of Quantum Electrodynamics had been established but the procedure left many dissatisfied. Moreover, it was suspected that the weak-coupling expansion did not define the theory at large coupling and that, more generally, in any local field theory the growth of the interaction at short distances produces “nullification” (or triviality, in current language) in that a finite result is obtained only with a zero bare coupling (Landau and Pomeranchuk, 1955). There was a collective sentiment that field theory either could not be used at all to describe the strong

interaction or that it would have to be formulated in an abstract, non-perturbative, even non-lagrangian, framework to be applicable. Simultaneously, dispersion relations were increasingly successful phenomenologically in relating strong interaction scattering processes (Goldberger, 1961) and it became clear that the parameters of a field theory could as well be introduced via dispersive calculations as in low-order diagrammatic calculations (Mandelstam, 1958). In addition the use of dispersion relations for S-Matrix amplitudes did not involve the off-shell momentum regions of (low-order) Feynman diagrams that produced the infinities needing infinite renormalization.

To compare with experiment the S-matrix is all that is needed (Landau, 1959). The question was, of course, what determines the S-Matrix and how is a general framework to calculate it to be implemented? The central idea was that the strong interaction S-Matrix is unique and self-consistent. Therefore if enough general properties are specified it will be uniquely determined (Chew, 1962). The initial properties chosen are all satisfied (formally) in the perturbation expansion of a local field theory (of massive particles).

2.2 Initial Postulates

If all the particles are massive then it can be self-consistently assumed that the interactions are short-range and that the set of all free particle states forms a complete set. The S-Matrix is the sum total of scattering amplitudes for any initial configuration of free particles, of any kind, to scatter into any final configuration of free particles. The following were the first postulates made.

[1] **Lorentz Invariance.** This is straightforward.

[2] **Maximal Analyticity.** The origin of global analyticity in the causality of local field theory is described in sub-section 2.5 below. Maximal analyticity, as a postulated principle, says that S-Matrix amplitudes are analytic functions that have only the minimal singularity structure consistent with postulates [3] and [4].

[3] **Crossing.** Within the complex mass-shell, the momentum of an incoming particle can be continued (or crossed) to that of an outgoing particle. This postulate asserts that (provided the crossed scattering process is physically possible) the corresponding amplitude is obtained by the same continuation. Thus, one analytic S-Matrix amplitude describes many different physical regions.

[4] **Unitarity.** Obviously, unitarity must be satisfied in all physical regions. Maximal analyticity thus implies that each amplitude has only the Landau singularities (described in the next Section) associated with physical thresholds in each of the physical regions in which it describes the scattering. In formulating the unitarity equations cluster decomposition, as described in the next Section, is assumed to hold, although this property actually follows from the macrocausality principle adopted in Axiomatic S-Matrix Theory.

2.3 Further Postulates

Historically, the postulates of subsection 2.2 were first implemented via dispersion relation calculations (Goldberger, 1961; Chew and Mandelstam, 1960). For four-particle scattering amplitudes Mandelstam's double dispersion relation provided a formalism that was consistent with, and at least as powerful as, one-loop Feynman diagram perturbation theory (Mandelstam, 1958,1961). Nevertheless, additional postulates were necessary to make practical progress.

[5] **The Bootstrap.** This asserted that one could self-consistently insert particle and resonance states in one channel and discover, via crossing and unitarity, particles and resonances in another channel.

[6] **Maximal Analyticity of the Second Kind - Nuclear Democracy.** This asserts that all particles lie on regge trajectories. This not only eliminated the need for subtractions (as additional parameters) in dispersion relations but also implemented the philosophical concept that no particles are to be regarded as elementary. All particles are bound states of each other and essentially the same as resonances.

With these last two postulates included quite elaborate consistency calculations were performed (Chew et al., 1962). The approach floundered, in part, because the more complicated analyticity properties of higher multiparticle amplitudes do not allow any analogue of the Mandelstam representation. As we noted in the Introduction, the absence of such a representation is fundamental because it prevents an iterative perturbation expansion using discontinuities plus dispersion relations.

Both [5] and [6] were prophetic in defining essential properties for present day theories. It can be shown that in a spontaneously-broken gauge theory all vector bosons and fermions lie on Regge trajectories if, and only if, the gauge symmetry is non-abelian (Grisaru and Schnitzer, 1979). The self-coupling of gauge fields is the essential interaction that is needed, just as it is for asymptotic freedom. Therefore [6] anticipated the existence of non-abelian gauge theories. It is also interesting that reggeization of an elementary particle is the only known mechanism within field theory for generating an isolated Regge pole trajectory as both hadron and pomeron trajectories apparently are. Bound state Regge poles are typically generated with accumulations points of trajectories. Thus, the reggeization of quarks and gluons in QCD could play an important role in determining the pomeron and hadron spectrum.

The bootstrap postulate was eventually given stronger dynamical substance via the concept of duality. The contribution of resonances (at low and medium energy) should approximate (or be dual to) the contribution of regge poles associated with the resonances in crossed channels (Dolen et al., 1968). This led first to the idea of a narrow resonance approximation in which hadrons would lie on linear regge trajectories (Mandelstam, 1967) and then to the formulation of dual resonance models, which were soon reformulated as

string theories (for a review see Mandelstam, 1976). Therefore [5] anticipated dual resonance models and, ultimately, the existence of string theories.

The approximate linear regge trajectories observed experimentally were thus understood to imply that hadrons are extended objects which in massive, high angular momentum, configurations are string-like. While this is understood qualitatively in QCD as due to the color flux tubes produced by the confinement of color, there is no established string approximation to the hadron S-Matrix. It remains the greatest irony of present-day particle theory that string theories are now thought to primarily describe physics at the Planck scale of the gravitational interaction. There is, as yet, no experimental evidence at all for this association. It is based entirely on arguments of theoretical consistency. In sharp contrast, there is overwhelming experimental evidence that the hadron S-Matrix has string-like properties and yet we have only a very qualitative picture as to how this relates to QCD and confinement. It remains plausible, therefore, that the hadron (i.e. the QCD) S-Matrix will someday be directly calculated via some form of string theory.

2.4 QCD and a Final Postulate

It is fair to say that, apart from the approximate validity of chiral symmetries, properties of the hadron S-Matrix played very little role in the discovery of QCD (although the existence of a qualitative string picture certainly contributed to its acceptance). More important were the external currents that are required by the existence of electroweak interactions - even if the hadron S-Matrix could be self-consistently bootstrapped. As Feynman (1967) showed the algebra of currents (and their amplitudes) proposed by Gell-Mann is exactly what has to be added to the S-Matrix (Gell-Mann 1962, see Fritzsche and Gell-Mann, 1973 for a full review). The spectrum of hadrons suggested the currents should contain fractionally-charged quark fields. While Gell-Mann's attempts to formulate the strong interaction in terms of currents were ultimately unsuccessful he, and many others, argued that the desired currents would be obtained from a strong interaction vector "gluon" theory (Fritzsche and Gell-Mann, 1973). Finally, it was realized that (confined) SU(3) color would simultaneously explain the existence of baryons, the magnitude of the e^+e^- total cross-section, and the $\pi^0 \rightarrow 2\gamma$ decay (Bardeen et al., 1973). In parallel (almost) the experimental discovery of scaling in deep-inelastic electron-proton scattering at SLAC required the existence of a parton model that, with the theoretical discovery of asymptotic freedom, QCD was able to provide (Gross and Wilczek, 1973,1974; Politzer, 1974).

Historically, therefore, it was properties of the additional electroweak interactions that actually led to the discovery of the field theory needed to describe the "inside of hadrons". The jet physics that could, perhaps, have led to the discovery of asymptotic freedom and short-distance scaling in purely hadronic interactions was developed only later. If self-consistency properties of the strong interaction S-Matrix determine its uniqueness, as

the founders of S-Matrix theory believed, it was not evident in the formulation of QCD.

There is one more additional postulate that was often included. We discuss it last because it may be crucially related to asymptotic freedom.

[7] Maximal Strength of the Interaction - the Total Cross-Section does not Fall Asymptotically. If a vector interaction appears perturbatively at high energies and large momentum transfers then (barring subtleties of limits) the cross-section from such processes, and therefore the total cross-section, will not decrease asymptotically. Thus the maximal strength postulate may be the S-Matrix equivalent of assuming that an asymptotically-free non-abelian gauge theory underlies the strong interaction. At the end of this article we will suggest that QCD indeed may be determined by this property of the hadron S-Matrix but, as the Feynman quote in the Introduction suggested, for this we have to work much harder !

2.5 Analyticity in Field Theory

While global analyticity may be a counter-intuitive property to assume in the abstract, it is well-known to be a natural consequence of causality in a local field theory of massive particles formulated via canonical quantization in Minkowski space. In a theory of this kind it is either assumed that the fields satisfying local commutation relations also create the particles or, equivalently, that fields defined via the particle states satisfy local commutation relations (Lehmann et al., 1957). (For gauge theories, this formalism applies directly only when the gauge symmetry is spontaneously-broken and then only within perturbation theory.) To illustrate how analyticity properties are derived and, in particular, because it will be interesting to relate the asymptotic analytic structure discussed in Section 4 back to the basic analyticity domains of field theory, we briefly describe the relevant formalism in this subsection.

If $\phi(x)$ is a space-time field operator which creates (or destroys) the particles of the theory from (or into) the vacuum, (micro)causality implies that such fields commute at space-like separations, i.e.

$$[\phi(x), \phi(y)] = 0 \quad (x - y)^2 < 0 \quad (2.1)$$

By using reduction formulae (that “amputate” external propagators), the momentum-space S-Matrix amplitudes of the theory can be obtained from “Generalized Retarded Functions” (GRFs) that are the Fourier transforms of “retarded” Greens functions (Epstein et al., 1976). The simplest example of a GRF (which gives only a propagator rather than an S-Matrix element) is

$$G(p) = \int d^4x e^{ip \cdot x} \langle 0 | \theta(x_0) \phi(x) \phi(0) | 0 \rangle, \quad (2.2)$$

(where $\theta(y) = 1, y > 0$; $\theta(y) = 0, y < 0$). Provided that the retarded Greens functions are well-defined distributions—that is they are polynomially bounded—then their Fourier

transforms have extensive analyticity domains because of the convergence provided by the Fourier exponential factors of the form $\exp[ip \cdot x]$. For example $G(p)$ is manifestly analytic in the “forward-tube”

$$(\text{Im } p)^2 > 0 \quad \text{Im } p_0 > 0. \quad (2.3)$$

This is referred to as the “primitive” analyticity domain of $G(p)$ since it follows directly from microcausality without any further analytic completion.

A complete set of GRFs can be defined from all field products in the theory (Epstein et al., 1976). Each GRF is analytic in a particular tube or “cone” which is a generalization of (2.3). For an N -point function a general tube is defined by

$$\left(\sum_{\Delta} \text{Im } p_i \right)^2 > 0 \quad \sum_{\Delta} \text{Im } p_{i0} \geq 0 \quad \forall \Delta, \quad (2.4)$$

where Δ is any channel, that is any subset of the external momenta $p_1 \dots p_N$, and (2.4) must be satisfied with either the $>$ or the $<$ sign operative in the second term for all Δ . By use of the “Edge of the Wedge” theorem it is straightforward to extend analyticity within the tubes to “partial tubes” in which any of the p_i are real and spacelike (Epstein, 1965). If all of the p_i are real and spacelike then all the N -point GRF’s coincide and can be identified as analytic continuations of one analytic (off-shell) N -point amplitude. Again the combination of all tubes and partial tubes is referred to as the “primitive” analyticity domain of the N -point amplitude.

As preparation for the development in later Sections, we also discuss here the relationship between the primitive domains of analyticity and the kinematic variables that describe regge behavior. Consider the amputated four-point function that gives the on-shell S-Matrix and suppose that $p_i^2 = -m^2 < 0$, $i = 1, \dots, 4$. Lorentz invariance allows us to go to a frame where the most general real momentum configuration is

$$p_1 = (0, m \sin \zeta, 0, m \cos \zeta), \quad p_3 = (0, -m \sin \zeta, 0, m \cos \zeta), \quad (2.5)$$

$$p_2 = (m \sin \zeta \sinh \beta, m \sin \zeta \cosh \beta, 0, -m \cos \zeta) \quad (2.6)$$

$$p_4 = (-m \sin \zeta \sinh \beta, -m \sin \zeta \cosh \beta, 0, -m \cos \zeta) \quad (2.7)$$

If we allow $z = \cosh \beta$ to be complex so that

$$2 \text{Im } z = \text{Im } \cosh \beta = \text{Im} \left[\rho e^{i\delta} + \frac{1}{\rho} e^{-i\delta} \right] = \left[\rho - \frac{1}{\rho} \right] \sin \delta \quad (2.8)$$

$$2 \text{Im } \sinh \beta = \text{Im} \left[\rho e^{i\delta} + \frac{-1}{\rho} e^{-i\delta} \right] = \left[\rho + \frac{1}{\rho} \right] \sin \delta \quad (2.9)$$

then p_1 and p_3 remain real and spacelike while

$$\text{Im } p_2 = -\text{Im } p_4 = \frac{m \sin \zeta}{2} \sin \delta \left(\left[\rho + \frac{1}{\rho} \right], \left[\rho - \frac{1}{\rho} \right], 0, 0 \right). \quad (2.10)$$

$$\Rightarrow (\text{Im } p_2)^2 = (\text{Im } p_4)^2 > 0 \quad \text{Im } p_{20} = -\text{Im } p_{40} \sim \text{Im } z. \quad (2.11)$$

That is the cut z -plane is contained in the analyticity domain given by the GRF (partial) tubes. Also, since

$$\text{Im } s = \text{Im } (p_1 + p_2)^2 = -2m^2 \sin^2 \zeta \text{Im } z \quad (2.12)$$

the cut z -plane corresponds to the cut s -plane. If we analytically continue to $p_i^2 > 0$, $\forall i$ then $\theta = i\beta$ can be identified with the center of mass scattering angle for p_1 and p_3 . For higher amplitudes multi-regge theory introduces generalizations of z which will similarly describe the (partial-)tube analyticity domains for spacelike masses.

Since each GRF also gives an S -Matrix element as a boundary-value from within it's tube, it is natural that the global analyticity properties of the off-shell N -point amplitudes should to extend to the S -Matrix. Indeed if off-shell N -point amplitudes also share the analyticity property of finite-order perturbation theory, then there are no singularities in the external mass variables that would block the continuation on mass-shell. To prove this within the framework of Axiomatic Field Theory (without appealing to perturbation theory) is a difficult analytic completion problem which has only been carried through in detail for the four-point, and to a lesser extent, the five-point function. The resulting single-variable dispersion relation was one of the triumphs of the non-perturbative abstract formulation of field theory (Epstein, 1965).

The asymptotic analyticity properties used in Section 4 are obtained by combining the field theory results described above with complimentary results from the S -Matrix Theory of Section 3. The field theory cut-plane analyticity in z discussed above is illustrated in Fig. 2.1(a).

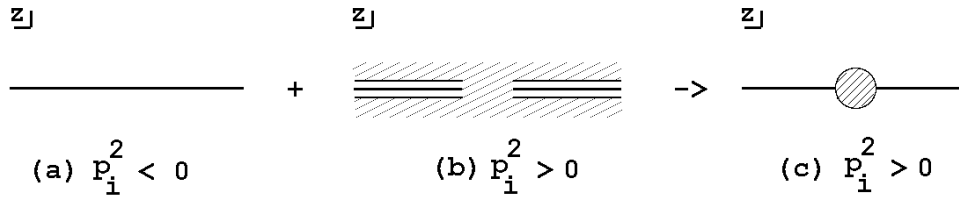

Fig. 2.1 Analyticity Domains in the z -plane (a) in Field Theory (b) in S -Matrix Theory (c) Combining Both Formalisms.

In S -Matrix Theory, it is shown that when $p_i^2 > 0$ there is a neighborhood of analyticity for the real z -axis of the kind illustrated in Fig. 2.1(b). Complex Landau singularities are necessarily attached back to the normal threshold branch cuts along the real axes. During the continuation from $p_i^2 < 0$ to $p_i^2 > 0$, such singularities can only emerge by some finite amount from the central part of the real axis. Hence there must be a domain of analyticity as illustrated in Fig. 2.1(c) which is the cut-plane minus some finite central circle where “anomalous threshold” Landau singularities are (possibly) located. This argument

generalizes to multiparticle amplitudes when analyticity domains are discussed in terms of generalized z variables.

3 Axiomatic S-Matrix Theory.

In its purest form S-Matrix Theory is devoted to establishing those analyticity properties of the S-Matrix that can be based on physical principles clearly formulated separately from field theory. Results from this program will be the subject of this Section. The initial hope was that such properties would be fed back into the dynamical program. However, it soon became apparent that the subject was sufficiently complicated that if the process of extracting and generalising results from Feynman diagrams was to be abandoned, as a matter of principle, only rather limited results could be obtained with any degree of rigor and generality.

3.1 Unitarity, Bubble Diagrams and Landau Diagrams

The “diagrammatic” framework of S-Matrix theory is provided by the unitarity equations. A heuristic way to develop a diagrammatic expansion that, superficially at least, is connected to the Feynman diagram expansion is as follows. First write the S-Matrix as $S = 1 + R^+$ and its Hermitian conjugate as $S^+ = 1 - R^-$. The unitarity equation $SS^+ = 1$ can be written formally as

$$R^+ = R^- [1 - R^-]^{-1} = \sum (R^-)^n \tag{3.1}$$

For simplicity we assume there is only one kind of physical particle, a scalar with mass m . If we make the cluster decomposition $S(p_1, \dots, p_m; p_{m+1}, \dots, p_n) =$

$$\begin{aligned} \text{Box}^+ &= \text{Box}^+ + \sum \text{Bubble}^+ + \dots + \sum \text{Bubble}^+ + \sum \text{Bubble}^+ \\ &+ \dots + \sum \text{Bubble}^+ + \sum \text{Bubble}^+ + \dots + \text{Bubble}^+ \end{aligned} \tag{3.2}$$

where a bubble represents a connected amplitude, together with a momentum conservation δ -function, then (3.1) gives, in bubble diagram notation,

$$\begin{aligned} \text{Bubble}^+ &= \text{Bubble}^- + \text{Bubble}^- + \sum \text{Bubble}^- + \sum \text{Bubble}^- \\ &+ \dots + \text{Bubble}^- + \dots + \sum \text{Bubble}^- + \dots \end{aligned} \tag{3.3}$$

where the phase-space integration is a sum over all particle numbers N of intermediate lines, together with an integration over the on-shell momenta involved.

$$\text{Hatched Box} = \sum_{i=1}^N \int \prod_{i=1}^N \frac{d^4 p_i}{(2\pi)^3} \delta^+(p_i^2 - m^2) \Theta \quad (3.4)$$

where Θ is the inverse of the symmetry number of the state.

Only “– bubbles” appear in the expansion (3.3). A general bubble diagram consists of signed bubbles connected by lines (directed from left to right). Each bubble diagram represents an integral of the product of the functions corresponding to the bubbles within the diagram. The integration is over the on mass-shell momenta of each of the internal lines. Each bubble diagram function contains, therefore, an overall momentum conservation δ -function. At any finite energy each of the infinite series of bubble diagrams in (3.3) can be rearranged into a finite series involving both – and + bubbles by using the unitarity equation for sub-sets of diagrams. The usual form of the unitarity equation is then obtained, e.g below the four-particle threshold

$$\text{+ bubble} - \text{– bubble} = \text{+ bubble} \text{– bubble} + \text{+ bubble} \text{– bubble} + \Sigma \text{+ bubble} \text{– bubble} + \Sigma \text{+ bubble} \text{– bubble} \quad (3.5)$$

The advantage of the series (3.3) is that it displays the necessary singularities of an amplitude explicitly. As the energy increases a new series of terms appears in the expansion whenever the threshold for a new scattering process is crossed. Scattering processes are described by a Landau diagram, examples of which are given in Fig. 3.1.

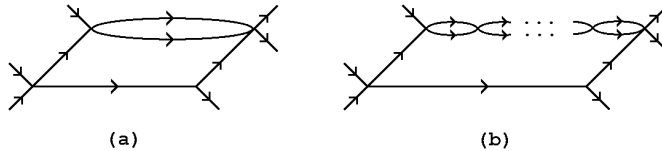

Fig. 3.1 Landau Diagrams with (a) No Iterated States (b) Iterated States.

A Landau Diagram is composed of lines and vertices. Each line is directed from left to right and carries a four momentum p_i with $p_i^2 = m^2$. There is momentum conservation at each of the vertices. A Landau diagram “fits into” a bubble diagram if and only if the diagram can be constructed by fitting into each bubble either a point vertex or a connected (sub) Landau diagram. The Landau diagrams that represent threshold processes in (3.3) are obtained by replacing all the – bubbles by point vertices.

3.2 The Landau Equations, the “+ α ” Condition, and Unitarity.

If a Landau diagram, such as that of Fig. 3.1(a), describes a space-time scattering process then for each internal loop L_k of the diagram the internal momenta p_i (directed around the loop) must satisfy the condition

$$\sum_{i \in L_k} \alpha_i p_i = 0 \quad (3.6)$$

$\alpha_i \geq 0$ is required for the scattering to be physical. The Landau equations for a given Landau diagram are the set of conditions (3.6) for all internal loops of the diagram. The set of external momenta that satisfy the complete set of equations provide the Landau singularity (surface) corresponding to the diagram (Landau, 1959). The set of all physical region (+ α) Landau diagram thresholds is the minimal set of singularities that an analytic scattering amplitude must have.

For a higher-order scattering process to be possible, all the sub-scattering processes must obviously be above threshold. This leads to a hierarchical property for + α Landau surfaces whereby surfaces of increasing complexity emerge from those of less complexity. In particular, if a complex Landau surface exists, it must be connected back (in general via lower-order surfaces) to the real normal thresholds. Hence if a neighborhood of analyticity close to the physical region is proven to exist as in Fig. 2(b), then the surfaces can only emerge from the low-energy ends of the normal thresholds, as allowed for in Fig. 2(c).

Note that if the external momenta are such that the scattering process of Fig. 3.1(a) is possible, then clearly any process with an iterated interaction of the form of Fig. 3.1(b) is also possible. The Landau equations for the iterated loops simply imply that the two momenta involved are parallel and no additional constraint is placed on the external momenta. Hence all diagrams of this form will have the same threshold and will give the same Landau surface. The nature of the singularity at the threshold will nevertheless be different for each diagram. To obtain the complete discontinuity around the surface it is necessary to include together all iterated scattering processes.

The Landau singularities were originally discovered in Feynman diagrams (Landau, 1959). The purpose of S-Matrix Theory is, however, to derive the analytic structure of amplitudes and, in particular, discontinuity formulae directly from unitarity. Unfortunately there are two simplifications of Feynman integrals that are not necessarily present in the bubble diagram integrals appearing in unitarity equations. Because of the $+i\epsilon$ prescription for propagators, Feynman integrals can be analytically continued around a Landau singularity. Also, because the vertices are point interactions, singularities are generated only by propagators. As a consequence Feynman diagram integrals are clearly singular only on the Landau surfaces obtained from + α Landau equations. In S-matrix Theory there is, a-priori, no $i\epsilon$ prescription. In addition, $-$ bubbles have the complex conjugate singularity structure of the $+$ bubbles. Consequently, when the singularities of bubble diagram amplitudes within

a bubble diagram are allowed for, singularities are generated on “mixed- α ” solutions of the Landau equations in which negative α 's are assigned to those lines of the Landau diagram that are produced within a $-$ bubble. Mixed- α solutions of iterated interaction diagrams, such as that of Fig. 3.1(a), are particularly troublesome.

It is thought to be self-consistent to assume both the absence of physical region mixed- α singularities and the $+i\epsilon$ prescription. In some of the early formulations of S-Matrix Theory, the $+i\epsilon$ prescription for analytic continuation was adopted as an additional postulate. At the same time there were several attempts to develop an S-Matrix concept of causality (for a complete set of references see Chandler and Stapp, 1969). These efforts culminated in the formulation of an S-Matrix classical correspondence principle called *macrocausality* that has as a consequence local analyticity properties that include both the $+i\epsilon$ prescription and the absence of mixed- α Landau singularities.

3.3 Macrocausality and Essential Support

The macrocausality principle says that all interactions between particles fall-off exponentially under space-time dilations unless the interaction can be transmitted by the exchange of stable particles. It leads to, or alternatively is equivalent to, the existence of (infinitesimal) domains of analyticity for S -Matrix elements in the immediate neighborhood of physical regions (Iagolnitzer and Stapp, 1969). Macrocausality can therefore replace the microcausality of local field theory as a basis for local (but not global) analyticity properties. While it is thought to be consistent with the microcausality property of field theory, a direct relationship has not been established. It is believed that unitarity of the S -Matrix has to be combined with microcausality to derive macrocausality. This is effectively the purpose of the “non-linear program” of field theory in which “asymptotic completeness” is added as an additional axiom to allow the mixing of unitarity properties with the existence of off-shell analyticity domains (Bros and Lassalle, 1976; Iagolnitzer, 1993).

While the essential concept of macrocausality is straightforward, an exact definition is more elusive and so we will not give one here. To formulate a precise principle requires the introduction of concepts that are a-priori outside of momentum space S-Matrix Theory (Iagolnitzer and Stapp, 1969; Iagolnitzer, 1976a,1978,1981). Firstly the discussion of a particle's position in space-time requires the introduction of appropriately localized wave-functions and there is room for variation in this. Secondly, the characterization of the exponential decrease of the probability for scattering in non-causal configurations allows some variation. As a consequence differing, but essentially equivalent, proofs of the $+i\epsilon$ prescription and the presence of only $+\alpha$ Landau singularities can be given (Iagolnitzer and Stapp, 1969; Iagolnitzer, 1976a,1978,1981).

In general, when S-Matrix Theory is developed from macrocausality, the notion of the essential support of a generalized fourier transform plays a central role (Iagolnitzer,

1976b,1978,1981). The generalized transform of a “momentum space” function $f(p)$, where $p = (p_1, p_2, \dots, p_n)$ is defined as

$$F(x, p; \gamma) = \int e^{-ip' \cdot x - \gamma|x||p' - p|^2} dp' \quad (3.7)$$

The essential support of f at p is the set of “singular” directions along which $F(x, p; \gamma)$ does not decay exponentially in x -space. Some continuity properties are also required. The essential support of f can also be viewed as the cone with apex at the origin in x -space formed by the singular directions. A relationship between local analyticity properties in momentum space and essential support properties in co-ordinate space holds that parallels the relationship between global momentum space analyticity and conventional support properties in co-ordinate space (Iagolnitzer, 1976b,1978,1981).

3.4 The Structure Theorem

The basic result needed for obtaining discontinuity formulae from unitarity is provided by the Structure Theorem. The essence of this theorem is that if all the singularities of the sub-bubble functions contained in a bubble diagram have only Landau singularities in the physical region, then so also does the full diagram function. Moreover, the Landau singularities of the full diagram are just those whose Landau diagram fits into the the full bubble diagram. The theorem is most easily proved using essential support theory (Iagolnitzer, 1976a,1978,1981). It then states (loosely) that the essential support of a bubble diagram function can be computed from the essential supports of the sub-bubbles.

There are exceptions to the structure theorem for special momentum configurations which, in principle, weaken the generality of the discontinuity formulae in the next two sub-sections. These exceptions allow very singular contributions from mixed- α Landau singularities, particularly those arising from iterated interactions such as appear in Fig. 3.1(b). As a result, the cancelation of mixed- α singularities within the unitarity equation, which is required by macrocausality for physical amplitudes, is not proven. If the following discontinuity formulae are first derived assuming general mixed- α cancelations, it is possible to show, a-posteriori, that the needed cancelations do take place. However, another solution in which such cancelations are absent can not be ruled out - even though there is no evidence, diagrammatic or otherwise, for it. At present such (purely mathematical) road blocks to uniqueness have to be presented as qualifications for the results of the following sub-sections.

In the framework of essential support theory the assumption of mixed- α cancelation becomes a stronger and clearer “separation of singularities” assumption (Iagolnitzer, 1976a,1978,1981). This assumption also leads to adaptations of the discontinuity formulae in situations where usual discontinuity formulae can not be formulated. In general the proofs of discontinuity formulae using essential support theory are much more satisfactory than the

elementary manipulations of bubble diagram expansions that we use below which, however, give the results in a direct and intuitive manner.

3.5 Local Discontinuity Formulae

We first discuss the local discontinuity around a general $+\alpha$ Landau surface that appears as a threshold in the bubble diagram expansion (3.3). The structure theorem implies that the discontinuity is given directly by the new terms that appear. To obtain a compact discontinuity formula we rearrange each of the infinite series due to iterated interactions using unitarity equations.

As an example(Stapp, 1976a) which illustrates the general case, we consider the Landau diagram of Fig. 3.2(a). The new terms in the expansion (3.3) are all the diagrams having the general form shown in Fig. 3.2(b). After using unitarity equations we obtain the discontinuity as the bubble diagram illustrated in Fig. 3.3. The letters a , b and c label sets of particles, which could obviously be different to those we have shown. The corresponding thin lines cut sets of internal lines that correspond to these sets of particles.

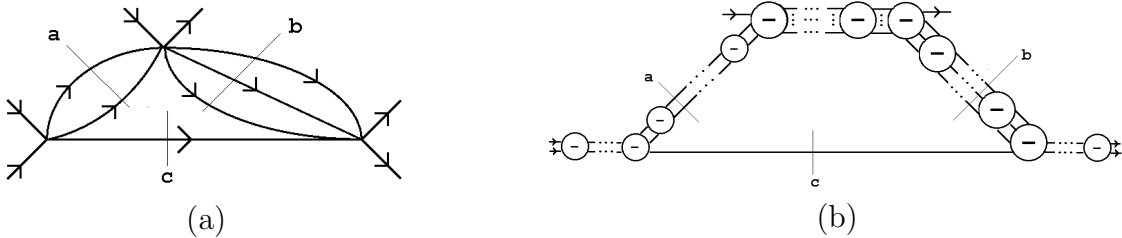

Fig. 3.2 (a) A Landau Diagram (b) The Threshold Bubble Diagrams.

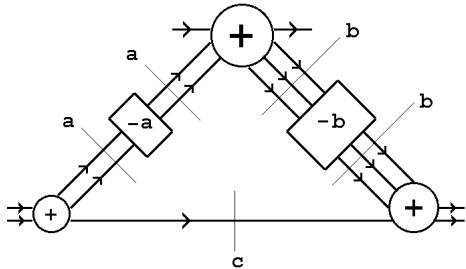

Fig. 3.3 The Discontinuity for Fig. 3.2.

The $-a$ and $-b$ boxes represent the functions S_a^{-1} and S_b^{-1} defined by

$$S_i S_i^{-1} = I_i, \quad i = a, b \tag{3.8}$$

where S_i and I_i are restrictions of the S-Matrix S and the unit operator I to the space corresponding to the set of particles i .

3.6 Good and Bad Functions and the Steinmann Relations

In addition to local discontinuities of the kind discussed in the last subsection, we can also discuss the total discontinuity in a particular invariant and similarly multiple discontinuities with respect to several invariants. A-priori, the amplitude below all cuts in an invariant can be defined by simply removing all bubble diagrams in the expansion (3.3) that have an intermediate state in that invariant. In the same way amplitudes above the cuts in any set of invariants and below in any further set can (naively at least) be defined. In addition to this algebraic procedure there is another equally valid procedure. The bubble expansion (3.3) written with $+$ bubbles instead of $-$ bubbles holds also for S^+ , which should correspond to the amplitude evaluated below all invariant cuts. Starting from this last expansion amplitudes above specific invariant cuts should be obtained by removing terms from the expansion. The functions obtained by these two procedures may not coincide.

An additional complication arises from the lack of independence of invariant variables. A particular problem is that it is possible to divide the invariants into two sets such that there is no mass-shell point that lies simultaneously in the upper half-plane of one set and in the lower half-plane of the other set. For example, if three invariants s_a , s_b and s_c satisfy $s_a + s_b = s_c + Cm^2$, where C is a real constant, then it is not possible to have $\text{Im}s_a, \text{Im}s_b > 0$ and $\text{Im}s_c < 0$. Such a combination of imaginary parts is referred to as an “inaccessible boundary”. In principle, an (artificial) infinitesimal parameter can be added to the amplitude such that the cuts separate as in Fig. 3.4.

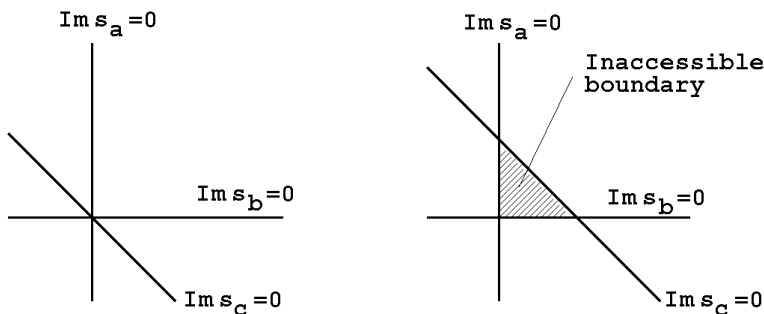

Fig. 3.4 Separating Cuts to Expose an Inaccessible Boundary.

We can then define the amplitude in any way we choose in the inaccessible boundary and, as in the next Section, write a multivariable dispersion relation, before returning the infinitesimal parameter to zero.

With this last manipulation, amplitudes above and below all combinations of cuts can

be defined by the two algebraic procedures described. For some amplitudes, called “good functions”, the two possibilities coincide. The good functions are thus uniquely determined and, in fact, share the good analyticity properties of the physical sheet amplitude. (It is anticipated that they are related, by some path of analytic continuation, to this amplitude.) Amongst the good functions are all the amplitudes obtained from the most general set of field theory “Generalized Retarded Functions” discussed in Section 2 (Cahill and Stapp, 1975). The four-point amplitude below the normal thresholds cut is both a good function and a GRF. Therefore, its good analyticity properties immediately translate into the analyticity domain illustrated in Fig. 2.1(b). A similar domain holds for a cut in a multiparticle amplitude whenever the amplitudes on both sides of the cut are good functions.

The “bad functions” are those for which the two algebraic definitions do not coincide. As an example, for a $3 - 3$ amplitude the bad functions are from boundary-values (or the conjugates) in the combination of invariant cuts of the kind illustrated in Fig. 3.5

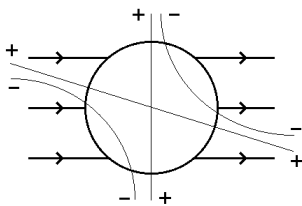

Fig. 3.5 Bad Boundary-Values

- the thin lines indicate the invariant channels and the \pm signs indicate the boundary-values. Not only are the bad functions not uniquely defined. Either definition gives very bad analyticity properties. There are complex cuts extruding from the real region and no path linking the amplitude on either side. There is, however, a unique definition that is not equal to either algebraic definition. The bad functions can be defined so that the Steinmann relations are satisfied (Stapp, 1976a; Cahill and Stapp, 1975; Coster and Stapp, 1975). This does not lead to better analytic properties but leads to important properties for the asymptotic dispersion relations of the next Section, as we discuss further below.

The original Steinmann relations are satisfied by the GRFs of field theory and are direct consequences of microcausality. In the S-Matrix context the Steinmann relations are said to be satisfied if there are no double discontinuities in overlapping channels. If the bad functions are defined by simply omitting (from either bubble diagram expansion) those diagrams that contain the Landau diagrams giving the undesired double discontinuities, the Steinmann relations are satisfied. The resulting functions still have bad analytic properties and are certainly not related to physical sheet amplitudes by any path of analytic continuation, but the simple discontinuity formulae of the next subsection are obtained. A central point for the next Section is that the bad boundary values become inaccessible in multi-regge limits and so the Steinmann relations can be legitimately imposed in writing asymptotic dispersion relations. The validity of multi-regge theory is deeply tied to the Steinmann relations and

their validity in turn reflects the direct relationship between multi-regge region analyticity and the primitive domains of field theory.

3.7 Global Discontinuity Formulae

With the Steinmann relation definition of bad functions multiple discontinuity formulae are as would be obtained if all higher-order Landau singularities were absent and there were only normal threshold branch cuts. To give some simple examples we first introduce the additional diagrammatic notation of Fig. 3.6.

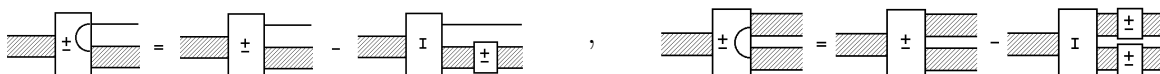

Fig. 3.6 Diagrammatic Notation

Using this notation, together with the corresponding notation involving initial state particles, the various triple discontinuities of a six-point amplitude can be represented as in Fig. 3.7. The channels in which the discontinuities are taken are those in which the hatched lines appear. These formulae are anticipated to generalize to the (N-3)-fold multiple discontinuities needed for the asymptotic dispersion relations of the N-point amplitude discussed in the next Section.

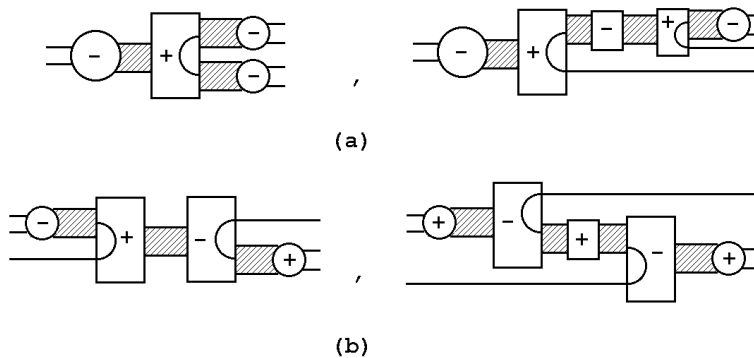

Fig. 3.7 Triple Discontinuities for (a) 2-4 Scattering (b) 3-3 Scattering.

3.8 CPT, Hermitian Analyticity, etc.

We have not discussed at all the technique of using pole factorization to embed a low-order amplitude in a higher amplitude and thus use analyticity properties of the higher amplitude to deduce properties of the low-order amplitude. Early results obtained this way were the CPT Theorem and hermitian analyticity (Stapp, 1962; Olive, 1964). Paths of analytic continuation relating good functions can also be discussed this way.

3.9 Holonomy

This is a very interesting mathematical subject that we will not attempt to review (Iagolnitzer, 1978,1981,1993). It began with the suggestion (demonstrated in some cases) that the discontinuity formulae satisfied by S -Matrix elements could be regarded as infinite order “pseudo-differential” equations. It then appeared that the maximal analyticity assumption of S -Matrix Theory might be embodied in Sato’s conjecture that the S -Matrix is a holonomic microfunction—that is it is a solution of a maximally over-determined system of pseudo-differential equations (Sato, 1975). Presently this conjecture seems to have been disproven, at least in it’s simplest form (Iagolnitzer, 1993).

4 Asymptotic S-Matrix Theory.

4.1 The Elastic Scattering Asymptotic Dispersion Relation.

Given the analyticity domain illustrated in Fig. 2.1(c), Cauchy’s theorem implies that an elastic scattering amplitude $A(s, t)$ satisfies the single-variable dispersion relation

$$A(s, t) = \frac{1}{2\pi i} \int_{I_R} \frac{ds' \Delta(s', t)}{(s' - s)} + \frac{1}{2\pi i} \int_{I_L} \frac{ds' \Delta(s', t)}{(s' - s)} + \frac{1}{2\pi i} \int_{\substack{|s'|=R \\ |s'|=s_0}} ds' \frac{A(s', t)}{(s' - s)}, \quad (4.1)$$

where I_R and I_L are the right and left cuts respectively. If we are interested only in the leading Regge behavior the third term can be ignored, provided the first two terms are evaluated appropriately. Suppose that

$$A(s, t) \Big|_{|s| \rightarrow \infty} \sim \beta_+(t) s^{\alpha(t)} + \beta_-(t) (-s)^{\alpha(t)}, \quad (4.2)$$

(There could also be additional $\ln s$ dependence.) For $\text{Re } \alpha(t) < -1$ we can use

$$\frac{1}{2\pi i} \int_{|s'|=R} \frac{ds' A(s', t)}{(s' - s)} \Big|_{R \rightarrow \infty} \sim R^{\alpha(t)} \rightarrow 0 \quad \text{Re } \alpha(t) < -1. \quad (4.3)$$

If we take $R \rightarrow \infty$ and then analytically continue to $\text{Re } \alpha(t) > -1$, since

$$\frac{1}{2\pi i} \int_{|s'|=s_0} ds' \frac{A(s', t)}{(s' - s)} \Big|_{|s| \rightarrow \infty} \sim O\left(\frac{1}{s}\right), \quad (4.4)$$

we can write

$$A(s, t) = \frac{1}{2\pi i} \left(\int_{I_R=(s_0, \infty)} + \int_{I_L=(-\infty, -s_0)} \right) \frac{ds' \Delta(s', t)}{(s' - s)} + A_0, \quad (4.5)$$

where the I_R and I_L integrals are defined by analytic continuation and A_0 gives sub-dominant asymptotic behavior. (4.5) is the simplest example of an “asymptotic dispersion relation”. It differs from the exact dispersion relation only in that details that are irrelevant in the regge limit are omitted.

4.2 Multiparticle Kinematics and Analyticity Domains.

There is no simple generalization of (4.1) to multiparticle amplitudes, in part because of the increased complexity of the singularity structure due to the large number of invariants. However, there is a generalization of (4.5) (Stapp, 1976b; Stapp and White, 1982; White, 1991).

The first step is the introduction of angular variables for an N-point amplitude.

Each of the many possibilities corresponds to a distinct tree diagram with three-point vertices - a “Toller Diagram”. As illustrated in Fig. 4.1 for the 6-point amplitude, internal momenta are introduced by imposing momentum conservation. At each vertex, three Lorentz frames are defined in which each of the entering Q_i take a standard form. Writing $t_i = Q_i^2$ we then have

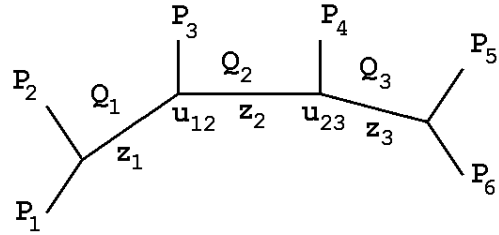

Fig. 4.1 A Toller Diagram

$$M_N(P_1, \dots, P_N) \equiv M_N(t_1, \dots, t_{N-3}, g_1, \dots, g_{N-3}) \quad (4.6)$$

where each g_i is an element of the little group of Q_i . If $t_i > 0$ the little group is $SO(3)$ while for $t_i < 0$ it is $SO(2, 1)$. Taking $t_i > 0, \forall i$, and using the parametrization

$$g_i = u_z(\mu_i)u_x(\theta_i)u_z(\nu_i), \quad 0 \leq \theta_i \leq \pi, \quad 0 \leq \mu_i, \nu_i \leq 2\pi \quad (4.7)$$

M_N becomes a function of (N-3) t_i variables, (N-3) z_j variables, where $z_i = \cos \theta_i$, and (N-4) u_{jk} variables, where $u_{ij} = e^{i(\nu_j - \mu_i)}$.

Multi-regge Limits are defined as

$$z_1, \dots, z_{N-3} \longrightarrow \infty, \quad \forall t_i, u_{ij} \text{ fixed.} \quad (4.8)$$

These limits are physical when $t_i < 0, \forall i$. Helicity-pole limits in which some $z_i \rightarrow \infty$ and some $u_{jk} \rightarrow \infty$ (or 0) involve fewer large invariants. For any invariant $S_{mn\dots r} = (p_m + p_n + \dots + p_r)^2$ the multi-regge limit gives the asymptotic result

$$S_{mn\dots r} \underset{z_j \rightarrow \infty \forall_j}{\sim} f(\underline{t}, \underline{\omega}) z_{j_1} z_{j_2} \dots z_{j_s} \quad (4.9)$$

where j_1, j_2, \dots, j_s denotes the *longest* path through the Toller diagram linking any two of the external momenta contained in $S_{mn\dots r}$.

The angular variables can similarly be introduced when the external p_i and the internal Q_j are all spacelike. The analysis of (2.5)–(2.11) then extends naturally to an N -point amplitude, as a function of the z_j -variables. From (2.8)–(2.11), applying a complex boost to a real spacelike momentum vector takes this vector into a tube of the form (2.3). More generally, if the imaginary part of the momentum vector already satisfies (2.3), and in addition the real part is a spacelike vector, then both properties are preserved by a complex boost. As a result the application of successive “complex z_j ” transformations, with the $\cosh \omega_{jk}$ and t_j kept real, takes all the momenta involved into a tube of the form (2.4). Since

$$\cosh \left[\beta_j + \beta_{j+1} + \dots + \beta_{j+r} \right] \sim_{z_j, z_{j+1}, z_{j+2}, \dots \rightarrow \infty} \cosh \beta_j \cosh \beta_{j+1} \dots \cosh \beta_{j+r} = z_j z_{j+1} \dots z_{j+r} \quad (4.10)$$

analyticity in the tubes (2.4) transfers asymptotically into analyticity in the “ z_j -cones” bounded by the cuts

$$\text{Im} \left(\prod_{\Delta} z_j \right) = 0 \quad \forall \Delta, \quad (4.11)$$

where now Δ is any subset of $j = 1, \dots, N-3$ associated with *adjacent* lines in the Toller diagram. This is the anticipated generalization of the off-shell cut-plane analyticity illustrated in Fig. 2.1(a).

Consider next the on mass-shell analyticity properties given in the previous Section. From (4.9) all normal threshold cuts

$$\text{Im} S_{mn\dots r} = 0 \quad \forall mn\dots r, \quad (4.12)$$

lie asymptotically within the cuts (4.11). Also it can be shown that the assignment of imaginary parts giving a bad boundary-value is incompatible with (4.9). A generalization of the situation depicted in Fig. 4.2 takes place.

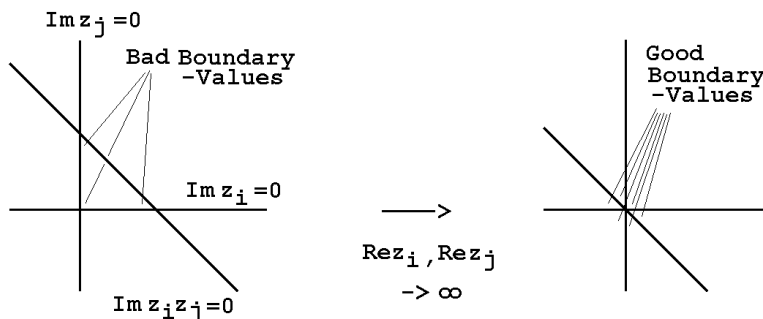

Fig. 4.2 Asymptotic Cut Structure

The bad boundary-values disappear asymptotically and only good functions appear on either side of the asymptotic cuts (4.11). Consequently analyticity in the neighborhood of the cuts (4.11) parallels that of Fig. 2.1(b) and we conclude that a generalization of Fig. 2.1(c) also holds.

In the next Section we will disperse in the N-3 z_j variables. To apply the Bargman-Weil Theorem, the cuts (4.11) must only intersect N-3 at a time. If the bad functions are chosen to satisfy the Steinmann relations, greater than (N-3)-fold multiple discontinuities are zero and the theorem can be applied. That the bad boundary-values become inaccessible asymptotically is, therefore, an essential pre-requisite.

4.3 Multiparticle Asymptotic Dispersion Relations.

Consider a function $f(\underline{z}) = f(z_1, \dots, z_n)$ analytic in \mathbf{C}^n minus a set of cuts c_m

$$c_m = \left\{ \underline{z} \in \mathbf{C}^n; \quad \text{Im } s_m(\underline{z}) = 0 \right\}. \quad (4.13)$$

If I^λ is the intersection of n such cuts and $\Delta^\lambda(\underline{z})$ is the multiple discontinuity

$$\Delta^\lambda(\underline{z}) = \sum (-1)^{n'} f \left(\underline{z} (\text{Re } s_{\lambda_1} \pm i0, \dots, \text{Re } s_{\lambda_n} \pm i0) \right), \quad \lambda \equiv (\lambda + 1, \dots, \lambda_n) \quad (4.14)$$

(the sum is over all combinations of \pm signs and n' is the number of minus signs), the Bargman Weil Theorem says that we can write

$$f(\underline{z}) = \sum_{\lambda} f^\lambda(\underline{z}) + f^0(\underline{z}), \quad (4.15)$$

where the sum is over all sets of n cuts λ . f^0 includes possible contributions from intersections of less than n cuts together with the “sphere” at infinity and

$$f^\lambda(\underline{z}) = \frac{1}{(2\pi i)^n} \int_{\underline{z}' \in I^\lambda} dz'_1 \dots dz'_n \Delta^\lambda(\underline{z}') \times \det \left(\underline{q}^{\lambda_1}, \underline{q}^{\lambda_2}, \dots, \underline{q}^{\lambda_n} \right). \quad (4.16)$$

The generalized dispersion denominators $\underline{q}^{\lambda_m}$ must satisfy

$$\underline{q}^{\lambda_m}(z, z') \cdot (z' - z) = 1. \quad (4.17)$$

If we change variables to the s_{λ_m} and write (4.16) in the form

$$f^\lambda \left(\underline{z}(s_\lambda) \right) = \frac{1}{(2\pi i)^n} \int_{\underline{z}' \in I^\lambda} ds'_{\lambda_1} \dots ds'_{\lambda_n} \left(\frac{\partial \underline{z}}{\partial s_\lambda} \right)_{\underline{z}=\underline{z}'} \Delta^\lambda(s'_\lambda) \frac{D^\lambda(\underline{z}, \underline{z}'(s'_\lambda))}{(s'_{\lambda_1} - s_{\lambda_1}(\underline{z})) \dots (s'_{\lambda_n} - s_{\lambda_n}(\underline{z}))} \quad (4.18)$$

(4.17) is satisfied if $D^\lambda(\underline{z}, \underline{z}')$ is the determinant of functions $p_{m\ell}^\lambda$ satisfying

$$s_{\lambda_m}(\underline{z}) - s_{\lambda_m}(\underline{z}') = \sum_\ell p_{\ell m}^\lambda(\underline{z}, \underline{z}') (z_\ell - z'_\ell). \quad (4.19)$$

If the s_{λ_m} are simple polynomials of the z_j we can write

$$D^\lambda(\underline{z}, \underline{z}') = D^\lambda(\underline{z}, \underline{z}) + \left[s_{\lambda_1}(\underline{z}) - s_{\lambda_1}(\underline{z}') \right] E_1^\lambda(\underline{z}, \underline{z}') + \dots + \left[s_{\lambda_n}(\underline{z}) - s_{\lambda_n}(\underline{z}') \right] E_n^\lambda(\underline{z}, \underline{z}'), \quad (4.20)$$

where the $E_m^\lambda(\underline{z}, \underline{z}')$ are also polynomials. Substituting (4.20) into (4.18) the first term gives the simple expression

$$f^\lambda \left(\underline{z}(s_\lambda) \right) = \frac{1}{(2\pi i)^n} \int_{I^\lambda} ds'_{\lambda_1} \dots ds'_{\lambda_n} \frac{\Delta^\lambda(s'_\lambda)}{\left(s'_{\lambda_1} - s_{\lambda_m}(\underline{z}) \right) \dots \left(s'_{\lambda_n} - s_{\lambda_n}(\underline{z}) \right)}, \quad (4.21)$$

while the remaining terms in (4.20) cancel at least one denominator in (4.18) and so can be included in the f^0 term appearing in (4.15).

The multi-Regge behavior which generalizes (4.2) is that

$$f(\underline{z}) \equiv M(\underline{t}, \underline{z}, \underline{u}) \underset{z_1, \dots, z_{N-3} \rightarrow \infty}{\sim} \prod_{j=1}^{N-3} (z_j)^{\alpha_j(t_j)} \quad (4.22)$$

(where again there may also be $\ln z_j$ factors). Since this represents a function with $n \equiv (N-3)$ cuts it can only originate from the $f^\lambda(\underline{z})$ terms in (4.15). Also non-leading functions of the z_j appearing in the $s_{\lambda_m}(\underline{z})$ can be dropped and their effects absorbed in f^0 . Consequently we can write an asymptotic dispersion relation

$$M_N = \sum_C M_N^C + M^0 \quad (4.23)$$

where the \sum_C is over all sets of (N-3) Regge limit asymptotic cuts and the asymptotic form (4.9) expressing all invariants as polynomials in the z_j justifies writing each of the M_N^C in the form

$$M_N^C = \frac{1}{(2\pi i)^{N-3}} \int \frac{ds'_1 \dots ds'_{N-3} \Delta^C(\dots t_i, \dots u_{jk}, \dots s'_i)}{(s'_1 - s_1)(s'_2 - s_2) \dots (s'_{N-3} - s_{N-3})} \quad (4.24)$$

Therefore to write a full asymptotic dispersion relation we need only to enumerate the complete set of multiple discontinuities (4.14). A complete discussion of the asymptotic dispersion relation corresponding to the Toller diagram of Fig. 4.1 has been given (Stapp and White, 1982).

4.4 Classification of Multiple Discontinuities

Given that the Steinmann relations are satisfied, multiple discontinuities can be counted and classified using “hexagraphs” (White, 1976,1991). The hexagraphs^{||} associated with a Toller diagram are obtained by redrawing the diagram in all possible ways (in a plane) with the internal lines drawn as horizontal lines and the internal vertices drawn separately, with relative angles of 120° , and joined to the horizontal lines. A hexagraph associated with the Toller diagram of Fig. 4.1 is shown in Fig. 4.3 (a). (The j and n labels are explained below.)

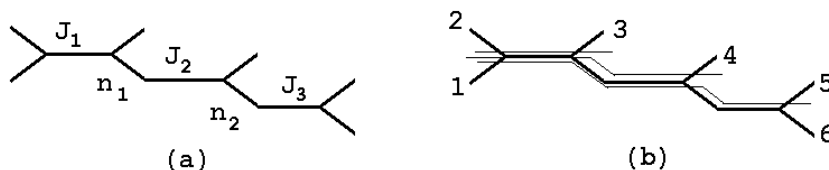

Fig. 4.3 (a) A Hexagraph from Fig. 4.1, (b) Allowable Cuts.

The multiple discontinuities associated with a particular hexagraph all appear in the same s -channel physical region - obtained by regarding the scattering particles as entering from the bottom and exiting at the top. Each graph is also associated with a particular t -channel - obtained by regarding the scattering particles as entering from the left and exiting to the right.

An “allowable discontinuity” of a hexagraph is a cut drawn through internal lines that connects the particles involved in the discontinuity channel, and enters and exits only between non-horizontal lines. A set of allowable discontinuities of the hexagraph of Fig. 4.3(a) is shown in Fig. 4.3(b). For an N-point amplitude, a hexagraph represents all sets of (N-3) asymptotically independent cuts that are allowable discontinuities and satisfy the Steinmann relations. Each multiple discontinuity appears in only one hexagraph.

^{||}There must be a close relationship between hexagraph amplitudes and the field theory GRFs, but so far this has not been studied.

5 Multi-Regge Theory.

The break-up of an N -point amplitude into hexagraph amplitudes allows multi-regge theory to be developed as a generalization of elementary regge theory. In this Section we briefly describe the central elements. (For a full development see White, 1976,1991,1998,1999).

5.1 Partial-Wave Expansions

For a function $f(g)$ defined on $SO(3)$ we can write

$$f(g) = \sum_{J=0}^{\infty} \sum_{|n|,|n'|<J} D_{nn'}^J(g) a_{Jnn'}, \quad (5.1)$$

where the $D_{nn'}^J(g)$ are representation functions. In a t -channel where all the little groups are $SO(3)$, (4.6) gives the generalized partial-wave expansion

$$M_N(\underline{t}, g_1, \dots, g_{N-3}) = \sum_{J_1=0}^{\infty} \sum_{|n_1|,|n'_1|<J_1} \dots \sum_{J_{N-3}=0}^{\infty} \sum_{|n_{N-3}|,|n'_{N-3}|<J_{N-3}} D_{n_1 n'_1}^{J_1}(g_1) \dots D_{n_{N-3} n'_{N-3}}^{J_{N-3}}(g_{N-3}) a_{J_1, n_1, n'_1, \dots, J_{N-3}, n_{N-3}, n'_{N-3}}(\underline{t}). \quad (5.2)$$

Because M_N depends only on particular combinations of the azimuthal angles, the helicity labels in (5.2) are also constrained. For a particular hexagraph the j variables can be associated with the horizontal lines, while independent n and n' variables are associated with sloping lines, as in Fig. 4.3(a).

5.2 Froissart-Gribov Continuations.

Since a hexagraph amplitude M^H has simultaneous cuts in only $N-3$ large invariants, a Sommerfeld-Watson representation that reproduces this cut structure is obtained by transforming only $N-3$ of the angular-momentum and helicity sums in (5.2). Correspondingly, Froissart-Gribov continuations can be made only in the complex planes of the relevant indices. The hexagraph groups together those sets of cuts for which continuations in the same helicity and angular momentum variables can be made. The essential feature is that the helicity labels, which are attached to sloping lines of the hexagraph, are always coupled to (that is differ only by an integer from) the angular momentum associated with the corresponding horizontal line. For example, in Fig. 4.3(a) n_1 would be coupled to j_2 and n_2 would be coupled to j_3 . Signature is introduced by combining together all hexagraphs that are related by twists about horizontal lines and so have the same t -channel.

5.3 Sommerfeld-Watson Representations

The form of the Sommerfeld-Watson representation for a set of hexagrapths with the same t -channel is directly related to the rules for Froisart-Gribov continuations. For example, the representation of the hexagraph of Fig. 4.3(a) has the form

$$A_H = \frac{1}{8} \int_{C_{n_2}} \frac{dn_2 u_2^{n_2}}{\sin \pi n_2} \int_{C_{n_1}} \frac{dn_1 u_1^{n_1}}{\sin \pi(n_1 - n_2)} \int_{C_{J_1}} \frac{dJ_1 d_{0,n_1}^{J_1}(z_1)}{\sin \pi(J_1 - n_1)} \quad (5.3)$$

$$\times \sum_{\substack{J_2 - n_1 = N_1 = 0 \\ J_3 - n_2 = N_2 = 0}}^{\infty} d_{n_1, n_2}^{J_2}(z_2) d_{n_2, 0}^{J_3}(z_3) a_{N_2 N_3}(J_1, n_1, n_2, t) + \dots,$$

Such representations give the asymptotic behaviour in both multi-Regge and helicity-pole limits. In the multi-regge limit the contribution of regge poles at $j_1 = \alpha_1(t_1)$, $j_1 = \alpha_1(t_1)$, and $j_1 = \alpha_1(t_1)$ in (5.3) gives

$$A_H \underset{\substack{z_1 \rightarrow \infty \\ z_2 \rightarrow \infty \\ z_3 \rightarrow \infty}}{\sim} \frac{z_1^{\alpha_1} z_2^{\alpha_2} z_3^{\alpha_3}}{\sin \pi \alpha_3 \sin \pi(\alpha_2 - \alpha_3) \sin \pi(\alpha_1 - \alpha_2)} \sum_{N_1 = N_2 = 0}^{\infty} \left[\beta_{N_1 N_2}^{\alpha_1 \alpha_2 \alpha_3} u_1^{\alpha_2 - N_1} u_2^{\alpha_3 - N_2} \right. \\ \left. + \beta_{N_1 N_2}^{\alpha_1 - \alpha_2 \alpha_3} u_1^{-\alpha_2 - N_1} u_2^{\alpha_3 - N_2} + \beta_{N_1 N_2}^{\alpha_1 \alpha_2 - \alpha_3} u_1^{\alpha_2 - N_1} u_2^{-\alpha_3 - N_2} + \beta_{N_1 N_2}^{\alpha_1 - \alpha_2 - \alpha_3} u_1^{-\alpha_2 - N_1} u_2^{-\alpha_3 - N_2} \right]. \quad (5.4)$$

In a helicity-pole limit, only the leading term appears.

5.4 t -channel Unitarity in the J -plane

The discontinuity across the n -particle threshold in any t -channel is shown in Fig. 5.1.

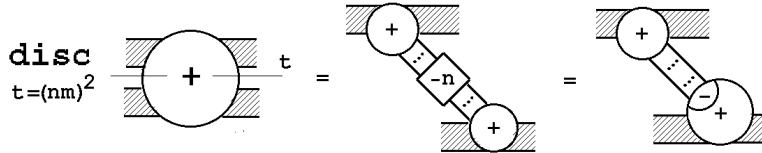

Fig. 5.1 The n -particle Discontinuity.

The n -particle phase-space can be written in terms of group variables as

$$I_n(t) = i \int d\rho(t, t_1, \dots) \int dg_L \prod_j dg_j \quad (5.5)$$

This integration is diagonalized by the partial-wave projection (5.2). It can also be shown that for regge behavior there is a form of “hexagraph diagonalization” (White, 1991). For

a hexagraph amplitude A^H the corresponding part of the unitarity integral can then be continued in the complex j -plane in the form

$$a_{\dots J \dots}^{H+} - a_{\dots J \dots}^{H-} = i \int d\rho \sum_{\tilde{N}} \int \frac{dn_1 dn_2}{\sin \pi(J - n_1 - n_2)} \int \frac{dn_3 dn_4}{\sin \pi(n_1 - n_3 - n_4)} \cdots a_{\dots J \tilde{N} \tilde{n}}^{H_L+} a_{J \tilde{N} \tilde{n} \dots}^{H_R-} \quad (5.6)$$

where H_L and H_R are hexagraphs whose “product” gives the hexagraph H (White, 1991,1998).

5.5 Reggeon Unitarity

If the amplitude a^{H_L} in (5.6) contains regge poles at $n_i = \alpha_i$ then multi-reggeon thresholds (regge cuts) are generated by the phase-space $\int d\rho$ together with the “nonsense poles” at $J = n_1 + n_2 - 1, n_1 = n_3 + n_4 - 1, \dots$. Corresponding angular momentum plane discontinuity formula can be derived from (5.6) (in conjunction with sub-channel discontinuity formulae). In general, from analagous unitarity equations, it can be shown that in any J -plane of any partial-wave amplitude, the threshold discontinuity due to M Regge poles with trajectories $\alpha = (\alpha_1, \alpha_2, \dots, \alpha_M)$ is given by the reggeon unitarity equation

$$\text{disc}_{J=\alpha_M(t)} a_{\dots J \dots}^H = \xi_M \int d\hat{\rho} a_{\dots J \tilde{\alpha}}^{H_L+} a_{J \tilde{\alpha} \dots}^{H_R-} \frac{\delta \left(J - 1 - \sum_{k=1}^M (\alpha_k - 1) \right)}{\sin \frac{\pi}{2}(\alpha_1 - \tau'_1) \dots \sin \frac{\pi}{2}(\alpha_M - \tau'_M)} \quad (5.7)$$

where ξ_M is a complicated signature factor and $a_{\dots J \tilde{\alpha}}^{H_L+}$ and $a_{J \tilde{\alpha} \dots}^{H_R-}$ are regge pole residues. If $\alpha_i = \alpha(t_i) \forall i$, then the trajectory of the M -reggeon cut is

$$J = \alpha_M(t) = M \alpha(t/M^2) - M + 1 \quad (5.8)$$

Writing $t_i = k_i^2$ and using

$$\int dt_1 dt_2 \lambda^{-1/2}(t, t_1, t_2) = 2 \int d^2 k_1 d^2 k_2 \delta^2(k - k_1 - k_2) \quad (5.9)$$

the phase-space integration $\int d\hat{\rho}$ in (5.7) can be written in terms of two dimensional “ k_{\perp} ” integrations, anticipating the reggeon diagram results of the direct s -channel QCD calculations that will be discussed in Section 7.

The reggeon unitarity equations were first derived in the mid-sixties (Gribov et al., 1965). However, there were many uncertainties in the derivation before the development of asymptotic dispersion relations as a fundamental basis for multi-regge theory. The generality of reggeon unitarity makes it extremely powerful, particularly when applied to the problem of constructing the regge region QCD S-Matrix, as we discuss briefly in Section 7. First we discuss the abstract solution of these equations using Reggeon Field Theory (RFT).

6 Reggeon Field Theory.

RFT has been derived and formulated from many different starting points since Gribov's seminal work (Gribov, 1967,1968; for an early review of RFT see Abarbanel, Bronzan et al., 1975). From an S-Matrix viewpoint RFT simply provides a solution of the reggeon unitarity equations. Consider an isolated even-signature pomeron regge pole with trajectory $j = \alpha(t)$ and the associated multi-pomeron cuts. When $\alpha(0) = 1$ (corresponding to the "maximum strength" postulate [7] of Section 2) then also $\alpha_M(0) = 1$. Therefore, all the multipomeron singularities accumulate at one point and a simultaneous solution of all the discontinuity formulae must be found. Remarkably, a renormalization group formalism can be applied and a fixed-point solution found (Migdal et al., 1974; Abarbanel and Bronzan, 1974).

6.1 Pomeron Phase-Space and the Effective Lagrangian.

For the pomeron the signature factor $\xi_M \sim (-1)^{M-1}$, while the other signature factors in (5.7) can be neglected. The δ -function in (5.7) becomes "energy conservation" for the RFT energy $E = 1 - J$ and a general solution is obtained by writing a (non-relativistic) graphical expansion involving pomeron propagators and vertices. If $\bar{\phi}(\underline{x}, y)$ and $\phi(\underline{x}, y)$ are respectively Pomeron creation and destruction operators (\underline{x} and y are conjugate to k_\perp and E) the corresponding effective lagrangian is

$$\begin{aligned} \mathcal{L}(\bar{\phi}, \phi) = & \frac{1}{2} i \bar{\phi} \overleftrightarrow{\partial}_y \phi - \alpha'_0 \nabla \bar{\phi} \cdot \nabla \phi - \Delta_0 \bar{\phi} \phi + \alpha''_0 \nabla^2 \bar{\phi} \cdot \nabla^2 \phi \cdots - \frac{i}{2} [r_0 \bar{\phi}^2 \phi + r_0 \bar{\phi} \phi^2 \\ & + r_{01} \bar{\phi} \phi \nabla^2 \phi + \cdots] + \frac{1}{6} [\lambda_0 \bar{\phi}^3 \phi + \lambda_0 \bar{\phi} \phi^3 + \cdots] + \cdots. \end{aligned} \quad (6.1)$$

6.2 The Critical Pomeron

If $|E|, |\underline{k}^2| < \mu$ initially, integrating out regions of E and \underline{k} so that $\mu \rightarrow \mu/\zeta$ gives a renormalization group transformation which rescales each parameter g in the lagrangian (6.1) by $g \rightarrow \zeta^{\nu_g} g + g'$, where ν_g is the canonical dimension of g . Bare parameters with $\nu_g < 0$ are "irrelevant" and can be dropped. Since

$$\nu_{\Delta_0} = 1, \quad \nu_{r_0} = \frac{1}{2}, \quad \nu_{\alpha'_0} = 0 \quad (6.2)$$

these parameters are kept. Expanding in powers of $\epsilon = 4 - D$, where D is the number of transverse dimensions, a fixed-point is found at

$$r^2 = \frac{4\pi^2}{3}\epsilon, \quad \Delta = 1 - \alpha(0) = 0 \quad (6.3)$$

Provided this fixed-point persists to $\epsilon = 2$, an interacting pomeron theory satisfying (5.7) exists that has the “universality” property familiar from critical phenomena. Consequently the asymptotic behavior can be calculated without knowledge of the initial bare parameters.

At leading-order in ϵ the elastic differential cross-section has the scaling behavior

$$\frac{d\sigma}{dt} \sim (\ln s)^{\epsilon/6} F^2 \left(-\frac{\alpha'_0 t [\ln s]^{1+\epsilon/24}}{K} \right) \quad (6.4)$$

where (Abarbanel, Bartels et al., 1975)

$$F(x) = x^{(-\epsilon/12)/(1+\epsilon/24)} \Gamma(1 + \epsilon/12) \int_{-i\infty}^{+i\infty} \frac{dw e^{-wx^{1/(1+\epsilon/24)}} [1 + \bar{\eta}/2]^{-\epsilon/12}}{(-w)^{1+\epsilon/12} [1 + \bar{\eta}(1 + \epsilon/24)] [1 + \bar{\eta}/2]}, \quad (6.5)$$

with

$$\bar{\eta}(1 + \bar{\eta}/2)^{\epsilon/24} = (-w)^{-1-\epsilon/24}, \quad K = \left[\frac{(8\pi)^2 \epsilon (\alpha'_0)^{4-\epsilon/2}}{6r_0^2} \right]^{1/12}. \quad (6.6)$$

Setting $t = 0$ in (6.4) leads to the well-known Critical Pomeron result for the total cross-section. A scaling law similar to (6.4), but even more elaborate, can also be derived for the triple-regge region of the one-particle inclusive cross-section (Abarbanel, Bartels et al., 1975, other Critical Pomeron scaling properties are reviewed in Moshe, 1978).

In a sense the Critical Pomeron is the summit of abstract S-Matrix Theory. It satisfies all known unitarity constraints on a theory of rising cross-sections and it is unique in this respect. It has been formulated without reference to any underlying theory and provides a uniquely attractive possibility for the high-energy behavior of an S-Matrix satisfying the maximum strength postulate.

6.3 The Super-Critical Pomeron

The nature of the “supercritical phase” that appears when the pomeron intercept is pushed beyond the critical point was much debated in the mid-seventies. An “expanding disc” solution that, unfortunately, does not satisfy reggeon unitarity was proposed by several authors (see, for example, Amati et al., 1975). The effective lagrangian close to the critical

point is given by (6.1) with only α'_0 , Δ_0 and $r_0 \neq 0$. A supercritical theory that has $\Delta_0 < 0$ and does satisfy reggeon unitarity can be defined by using the stationary point at

$$\phi = \bar{\phi} = 2i\Delta_0/3r_0 \quad (6.7)$$

to introduce a ‘‘pomeron condensate’’ (White, 1991). The condensate generates new classes of RFT diagrams whose physical interpretation is subtle. Reggeon unitarity determines that the k_\perp poles produced by zero energy two-pomeron propagators are to be interpreted as due to particle poles lying on an odd-signature trajectory degenerate with that of the pomeron. The odd-signature reggeon couples pairwise to the pomeron. A general characterization of the supercritical phase introduced this way is, therefore, that the divergences in rapidity produced by $\Delta_0 < 0$ are converted to vector particle divergences in k_\perp . The divergences are then associated with the ‘‘deconfinement of a vector particle’’ on the pomeron trajectory.

An obviously important question is whether the super-critical phase can be realized in QCD? The appearance of a reggeized vector particle (a ‘‘gluon’’) strongly suggests the spontaneous breaking of a gauge symmetry that would correspond to a color superconducting phase of QCD.

7 QCD and the Critical Pomeron

7.1 Reggeon Diagrams in QCD.

Leading-log Regge limit calculations of elastic and multi-regge production amplitudes in (spontaneously-broken) gauge theories show that both gluons and quarks lie on Regge trajectories (Fadin et al., 1977; Cheng and Lo, 1976,1977; Fadin and Sherman, 1978). Non-leading log calculations are described by reggeon diagrams involving reggeized gluons and quarks, just as required by reggeon unitarity. Gluon reggeon diagrams involve a reggeon propagator for each multi-reggeon state and also gluon particle poles e.g.

$$\text{two-reggeon state} \leftrightarrow \int \frac{d^2k_1}{(k_1^2 + M^2)} \frac{d^2k_2}{(k_2^2 + M^2)} \frac{\delta^2(k'_1 + k'_2 - k_1 - k_2)}{J - 1 + \Delta(k_1^2, M^2) + \Delta(k_2^2, M^2)} \quad (7.1)$$

To leading order in the gauge coupling g^2 this gives (5.7) with the particle poles producing the additional signature factors associated with an odd-signature reggeon. Bronzan and Sugar showed that the two-two reggeon interaction

$$\Gamma_{22}(\underline{k}_1, \underline{k}_2, \underline{k}'_1, \underline{k}'_2, M^2) = g^2 \frac{(\underline{k}_1^2 + M^2)(\underline{k}_2'^2 + M^2) + (\underline{k}_2^2 + M^2)(\underline{k}_1'^2 + M^2)}{(\underline{k}_1 - \underline{k}'_1)^2 + M^2} + \dots \quad (7.2)$$

could be extracted from sixth-order calculations and used to predict the independently calculated eighth and tenth orders (Bronzan and Sugar, 1978). The form of the interaction

(7.2) can also be deduced directly from t -channel unitarity (White, 1994). The well-known BFKL equation is obtained by summing to all orders the interaction (7.2) for the state (7.1) and taking the limit $M^2 \rightarrow 0$ (Fadin et al., 1977; Balitsky and Lipatov, 1978).

When the symmetry breaking (producing the mass M) is due to color triplet scalars the theory can be formulated gauge-invariantly (Banks and Rabinovici, 1979; 't Hooft, 1980) and, as discussed earlier, all of the analyticity properties of field theory and S-Matrix Theory that have been used in deriving reggeon unitarity apply perturbatively. Therefore, to all orders, the regge limit should be described by gluon, and quark, reggeon diagrams.

When the gluon mass $M \rightarrow 0$ there are infra-red divergences (due to the particle poles) in the reggeon states, in the interactions, and in the trajectory function. These divergences combine to exponentiate to zero all reggeon diagrams that do not carry zero color in the t -channel. In color-zero channels the divergences cancel. This is not confinement, however, because color-zero multi-gluon singularities are still present.

7.2 Color Superconductivity and the Supercritical Pomeron

Gluon reggeon diagrams differ from RFT pomeron diagrams only because of the gluon particle poles. The presence of these poles has several consequences. In particular, it allows all gluon reggeon interactions to have the same scaling dimension under the renormalization group transformation discussed in the previous Section. Hence finding a fixed point for reggeized gluon interactions would be very difficult, if not impossible. To apply the renormalization group a (confinement) mechanism has to be found whereby the particle poles disappear. A partial mechanism could be provided by the reverse of the RFT phase-transition to the supercritical pomeron. As described above, in this transition, “gluon poles” appear from within pomeron diagrams. Before this possibility can be considered, however, it is first necessary to identify the supercritical RFT phase within gauge theory reggeon diagrams.

The defining features of the supercritical phase, i.e. a regge pole pomeron with a reggeized massive vector partner and a “pomeron condensate”, could be realized in a color superconducting phase of QCD in which $SU(3)$ color is broken to $SU(2)$. The symmetry-breaking vector mass would then be identified with the RFT order parameter and the Critical Pomeron would appear at the critical point where color superconductivity disappears and full $SU(3)$ symmetry is restored. For this identification to be made there should also be a reggeon condensate with the quantum numbers of the winding-number current, associated (presumably) with spectral flow of the Dirac sea. Recent results show that quark loops do indeed produce anomalous reggeon interactions that could produce this condensate via infra-red divergences (White, 1999). The hope is that, within the reggeon diagrams that describe the fully superconducting phase of QCD (in which the gauge symmetry is completely broken), partial restoration of the gauge symmetry produces infra-red divergences involving

the anomaly that lead to the appearance of the supercritical RFT phase. Restoration of the full $SU(3)$ gauge symmetry would then give the Critical Pomeron.

7.3 Quark Saturation and an Infra-Red Fixed Point

In general, a gauge-invariant cut-off must be present if a gauge symmetry is to be restored smoothly. In the regge limit a k_{\perp} cut-off can be used. However, it then becomes an additional relevant parameter for the RFT phase transition. For Critical Pomeron behavior to be present after the cut-off is removed and the short-distance part of the theory is included, it must be that a smooth parameter variation can introduce the massive vector of the supercritical phase. This can be done via the Higgs mechanism only if the Higgs self-coupling is also asymptotically-free. This is the case only when QCD is “flavor-saturated”, i.e. the maximum number of flavors allowed by asymptotic freedom is present. When all quarks are massless flavor saturation also produces an infra-red fixed-point for the gauge coupling - a property that is closely related to the presence of an RFT fixed-point (White, 1993).

Flavor saturation is produced by sixteen conventional quark flavors but this is physically unrealistic. A second possibility is six conventional quark flavors plus two flavors of color sextet quarks. This may very well be physically realistic. If a doublet of color sextet quarks exists, with conventional electroweak quantum numbers, the sextet pions produced by the breaking of the sextet chiral symmetry can provide the electroweak “Higgs sector”. That is QCD chiral symmetry breaking in the sextet sector will simultaneously break the electroweak gauge symmetry. This gives the attractive possibility that the electroweak scale is actually a QCD chiral scale, rather than a new scale produced by new physics beyond the Standard Model.

The sextet doublet may even be necessary for the self-consistency of QCD. In addition to the sextet pions that produce the longitudinal components of the massive W^{\pm} and Z^0 , the sextet doublet also produces an axion that can prevent CP violation within QCD. Apart from it’s being unobserved experimentally, “Strong CP violation” is undesirable from the present perspective because it would destroy the crucial even signature property of the pomeron that allows a fixed-point solution of reggeon unitarity.

7.4 Uniqueness of the S-Matrix ?

From the discussion of the last subsection it appears that QCD with a fixed quark content may uniquely produce the Critical Pomeron. It may also be possible to argue that the graphs of the supercritical phase, when studied in detail, uniquely correspond to color superconducting QCD with the gauge group fixed to be $SU(3)$. If the Critical Pomeron is the only high-energy solution of unitarity that can match with asymptotic freedom then perhaps there is a uniqueness property for the strong-interaction S-Matrix close to that conjectured by the

early S-Matrix enthusiasts. The only difference would be that the mass scales involved are not determined, only the underlying massless theory.

But, why should Critical Pomeron asymptotic behavior be unique? Why, in particular, should the pomeron be only a single regge pole plus multipomeron cuts? That regge poles and the regge cuts built out of them are the only angular momentum plane singularities is almost certainly required for the solution of t -channel unitarity. A single regge pole pomeron uniquely has the factorization properties needed to be associated with a universal wee-parton distribution in hadrons. This universality property allows properties of a non-trivial vacuum to be carried by wee-partons. This, in turn, allows the most powerful form of the parton model and the maximal applicability of short-distance perturbation theory. Such properties may well be essential to produce a completely finite (and unitary) S-Matrix.

So it is indeed conceivable that the underlying massless field theory giving all the desired properties of the strong-interaction S-Matrix interaction is unique. The mass scales involved are presumably determined by the unification with the electroweak interaction. Could the full S-Matrix including the electroweak interaction be unique? To produce full asymptotic freedom at short-distances there should be an underlying non-abelian gauge group (this will also reggeize the photon - a necessary ingredient for the definition of an S-Matrix). The gauge symmetry should be partially-broken since any gauge symmetry larger than SU(3) produces a more complicated structure of pomeron regge poles. To produce the saturation of QCD needed to obtain the Critical Pomeron, the underlying gauge group has to be close to saturation. If this gauge symmetry is left-handed (which, of course, may not be necessary) then anomaly cancelation implies that the possibilities are indeed extremely limited (Kang and White, 1987). It is, therefore, not unreasonable to conjecture that a full set of consistency constraints including, presumably, some not yet formulated, do lead to a unique S-Matrix.

If the uniqueness of the S-Matrix determines the underlying gauge theory, before the existence of gravity is considered, this would be strongly counter to today's prevailing philosophy. Even though uniqueness is indeed envisaged after the inclusion of gravity.

References

- Abarbanel H D I and Bronzan J B (1974) *Phys. Rev.* **D9**, 2397.
- Abarbanel H D I, Bartels J, Bronzan J B and Sidhu D (1975) *Phys. Rev* **D12**, 2798.
- Abarbanel H D I, Bronzan J B, Sugar R L and White A R (1975) *Phys. Repts.* **21C**, 119.
- Amati D, Ciafaloni M, LeBellac M and Marchesini G (1975) *Nucl. Phys.* **B115**, 107.
- Balitsky Ya Ya and Lipatov L N (1978) *Sov. J. Nucl. Phys.* **28**, 822.
- Banks T and Rabinovici E (1979) *Nucl. Phys.* **B160**, 349.
- Bardeen W A, Fritzsche H and Gell-Mann M (1973) Light-Cone Current Algebra, π_0 Decay and e^+e^- Annihilation. In Gatto R (ed) *Scale and Conformal Symmetry in Hadron Physics*. Wiley & Sons.
- Bartels J (1993) *Z. Phys.* **C60**, 471.
- Bronzan J B and Sugar R L (1978) *Phys. Rev.* **D17**, 585.
- Bros J and Lassalle M (1976) An Approach to the Non-Linear Program of General Quantum Field Theory. In Balian R and Iagolnitzer D (eds) *Structural Analysis of Collision Amplitudes*, pp 427-503. North Holland.
- Cahill K E and Stapp H P (1975) *Ann. Phys.* **90**, 438.
- Chandler C and Stapp H P (1969) *J. Math. Phys.* **10**, 826.
- Cheng H and Lo C Y (1976) *Phys. Rev.* **D13**, 1131.
- Cheng H and Lo C Y (1977) *Phys. Rev.* **D15**, 2959 (1977).
- Chew G F (1962) *S-Matrix Theory of Strong Interactions*. Benjamin.
- Chew G F and Mandelstam S (1960) *Phys. Rev.* **119**, 467.
- Chew G F, Frautschi S C and Mandelstam S (1962) *Phys. Rev.* **126**, 1202.
- Coster J and Stapp H P (1975) *J. Math. Phys.* **16**, 1288.
- De Rujala A, Georgi H and Glashow S (1975) *Phys. Rev.* **D12**, 147.
- Coriano C and White A R (1996) *Nucl. Phys.* **B468**, 175.
- Dolen R, Horn D and Schmid C (1968) *Phys. Rev.* **166**, 1768.
- Dorey P (1998) *Lectures on Exact S-Matrices*. hep-th/9810026.
- Eden R J, Landshoff P V, Olive D I and Polkinghorne J C (1966) *The Analytic S-Matrix*. Cambridge University.
- Epstein H (1965) Axiomatic Field Theory. In *Proc. Brandeis Summer Institute*. Gordon and Breach.
- Epstein H, Glaser V and Stora R (1976) General Properties of the n-Point Functions in Local Quantum Field Theory. In Balian R and Iagolnitzer D (eds) *Structural Analysis of Collision*

- Amplitudes*, pp 5-93. North Holland.
- Fadin V S and Lipatov L N (1996) *Nucl. Phys.* **B477**, 767.
- Fadin V S and Sherman V E (1978) *Sov. Phys. JETP* **45**, 861.
- Fadin V S, Kuraev A E and Lipatov L N (1977) *Sov. Phys. JETP* **45**, 199.
- Feynman R P (1961) Comment. In Stoops R (ed) *The Quantum Theory of Fields, the 12th Solvay Conference*, p177. Interscience.
- Feynman R P (1967) Field Theory as a Guide to Strong Interactions. In Hagen C R, Guralnik G and Mathur V A (eds) *Proc. 1967 International Conference on Particles and Fields*, pp 111-127. Interscience.
- Fritzsche H and Gell-Mann M (1972) Current Algebra, Quarks and What Else? *Proc. XVI International Conference on High-Energy Physics*, Vol. 2 pp 135-165. NAL.
- Gell-Mann M (1962) *Phys. Rev.* **125**, 1067.
- Goldberger M L (1961) Theory and Applications of Single Variable Dispersion Relations. In Stoops R (ed.) *The Quantum Theory of Fields, the 12th Solvay Conference*, p177. Interscience.
- Gribov V N (1962) Partial Waves with Complex Angular Momenta and their Moving Singularities. In *Proc. 1962 International Conference on High Energy Physics*. CERN.
- Gribov V N (1967) Cuts in the Angular Momentum Plane and High Energy Asymptotic Behavior. In Hagen C R, Guralnik G and Mathur V A (eds) *Proc. 1967 International Conference on Particles and Fields*, pp 621-631. Interscience.
- Gribov V N (1968) *Soviet Phys. JETP* **26**, 414.
- Gribov V N (1969) Lectures on the Theory of Complex Angular Momenta. Leningrad Physical-Technical Institute - to be published.
- Gribov V N, Pomeranchuk I Ya and Ter-Martirosyan K A (1965) *Phys. Rev.* **139B**, 184.
- Grisaru M T and Schnitzer H J (1979) *Phys. Rev.* **D20**, 784.
- Gross D J (1999) *Nucl. Phys. Proc. Suppl.* **74**, 426.
- Gross D J and Wilczek F (1973) *Phys. Rev.* **D8**, 3633.
- Gross D J and Wilczek F (1974) *Phys. Rev.* **D9**, 980.
- Gunson J (1965) *J. Math. Phys.* **6**, 827, 845, 852.
- Iagolnitzer D (1976a) Physical-Region Properties of Multiparticle Collision Amplitudes. In Balian R and Iagolnitzer D (eds) *Structural Analysis of Collision Amplitudes*, pp 161-190. North Holland.
- Iagolnitzer D (1976b) Analytic Structure of Distributions and Essential Support Theory. In Balian R and Iagolnitzer D (eds) *Structural Analysis of Collision Amplitudes*, pp 295-358. North Holland.
- Iagolnitzer D (1978) *The S-Matrix*. North Holland.

- Iagolnitzer D (1981) Analyticity Properties of the S-Matrix: Historical Survey and Recent Results in S-Matrix Theory and Axiomatic Field Theory. In Mitter H and Pittner L (eds) *New Developments in Mathematical Physics*, pp 235-328. Springer-Verlag.
- Iagolnitzer D (1993) *Scattering in Quantum Field Theories*. Princeton University.
- Iagolnitzer D and Stapp H P (1969) *Com. Math. Phys.* **14**, 15.
- Landau L D (1955) On the Quantum Theory of Fields. In Pauli W (ed) *Neils Bohr and the Development of Physics*, pp 52-69 . Pergamon.
- Landau L D (1959) *Nucl. Phys.* **13**, 181.
- Landau L D (1960) Fundamental Problems. In Fierz M and Weisskopf V F (eds) *Theoretical Physics in the Twentieth Century - A Memorial Volume to Wolfgang Pauli*, pp 245-248 . Interscience.
- Landau L D and Pomeranchuk I Ya (1955) *Dokl. Akad. Nauk. SSSR* **102**, 489.
- Lehmann H, Symanzik K and Zimmermann W (1957) *Nuovo Cim.* **6**, 319.
- Low F (1966) Comment. In *Proc. XIIIth International Conference on High Energy Physics*, p 249. University of California.
- Low F (1974) Fifty Years of Quantum Field Theory. In Zichichi A (ed) *Lepton and Hadron Structure*, p 938. Academic Press.
- Mandelstam S (1958) *Phys. Rev.* **112**, 1344.
- Mandelstam S (1961) Two-Dimensional Representations of Scattering Amplitudes and their Applications. In Stoops R (ed.) *The Quantum Theory of Fields, the 12th Solvay Conference*. Interscience.
- Mandelstam S (1967) Dynamics Based on Indefinitely Rising Regge Trajectories. In Hagen C R, Guralnik G and Mathur V A (eds) *Proc. 1967 International Conference on Particles and Fields*, pp 604-615. Interscience.
- Mandelstam S (1976) Dual Resonance Models. In Balian R and Iagolnitzer D (eds) *Structural Analysis of Collision Amplitudes*, pp 593-637. North Holland.
- Migdal A A, Polyakov A M and Ter-Martirosyan K A (1974) *Zh. Eksp. Teor. Fiz.* **67**, 84.
- Moshe M (1978) *Phys. Repts.* **37C**, 255.
- Mussardo G (1992) *Phys. Repts.* **218**, 215.
- Olive D (1964) *Phys. Rev.* **135B**, 745.
- Politzer H D (1974) *Phys. Repts.* **14**, 129.
- Sato M (1975) Recent Developments in Hyperfunction Theory and it's Application to Physics. In *Lecture Notes in Physics* **39**. Springer-Verlag.
- Stapp H P (1962) *Phys. Rev.* **125**, 2139.
- Stapp H P (1976a) Discontinuity Formulas for Multiparticle Amplitudes. In Balian R and Iagolnitzer D (eds) *Structural Analysis of Collision Amplitudes*, pp 191-274. North Holland.

- Stapp H P (1976b) Many-particle Dispersion Relations. In Balian R and Iagolnitzer D (eds) *Structural Analysis of Collision Amplitudes*, pp 191-274. North Holland.
- Stapp H P and White A R (1982) *Phys. Rev.* **D26**, 2145. (1982).
- 't Hooft G (1980) Confinement and Topology in Non-Abelian Gauge Theories. In Urban P (ed) *Field Theory and Strong Interactions*, pp 531-586, Springer-Verlag.
- 't Hooft G (1999) *Nucl. Phys. Proc. Suppl.* **74**, 413.
- Weinberg S (1996) *The Quantum Theory of Fields, Vol I*. Cambridge University.
- White A R (1976) The Analytic Foundations of Regge Theory. In R. Balian R and Iagolnitzer D (eds) *Structural Analysis of Collision Amplitudes*, pp 427-503. North Holland.
- White A R (1991) *Int. J. Mod. Phys.* **A11**, 1859.
- White A R (1993) *Int. J. Mod. Phys.* **A8**, 4755.
- White A R (1994) *Phys. Lett.* **B334**, 87.
- White A R (1998) *Phys. Rev.* **D58**, 074008.
- White A R (1999) The Triangle Anomaly in Triple Regge Limits. hep-ph/9910458.
- Zamolodchikov A B and Zamolodchikov Al B (1979) *Ann. Phys.* **120**, 253.