

Bound state equation in the Wilson loop approach with minimal surfaces

F. Jugeau¹ and H. Sazdjian²

*Groupe de Physique Théorique, Institut de Physique Nucléaire³,
Université Paris XI,
F-91406 Orsay Cedex, France*

Abstract

The large-distance dynamics in quarkonium systems is investigated, in the large N_c limit, through the saturation of Wilson loop averages by minimal surfaces. Using a representation for the quark propagator in the presence of the external gluon field based on the use of path-ordered phase factors, a covariant three-dimensional bound state equation of the Breit–Salpeter type is derived, in which the interaction potentials are provided by the energy-momentum vector of the straight segment joining the quark to the antiquark and carrying a constant linear energy density, equal to the string tension. The interaction potentials are confining and reduce to the linear vector potential in the static case and receive, for moving quarks, contributions from the moments of inertia of the straight segment. The self-energy parts of the quark propagators induce spontaneous breakdown of chiral symmetry with a mechanism identical to that of the exchange of one Coulomb-gluon. In the nonrelativistic limit, long range spin-spin potentials are absent; the moments of inertia of the straight segment provide negative contributions to the spin-orbit potentials going in the opposite direction to those of the pure timelike vector potential. In the ultrarelativistic limit, the mass spectrum displays linear Regge trajectories with slopes in agreement with their classical relationship with the string tension.

PACS numbers: 03.65.Pm, 11.10.St, 12.38.Aw, 12.38.Lg, 12.39.Ki.

Keywords: QCD, Confinement, Wilson loop, Minimal surfaces, Bound states, Quarkonium.

¹And Université de Cergy-Pontoise. E-mail: jugeau@ipno.in2p3.fr

²E-mail: sazdjian@ipno.in2p3.fr

³Unité Mixte de Recherche 8608.

1 Introduction

The Wilson loop [1] appears as one of the most efficient tools for probing the large-distance properties of QCD. It provides a natural criterion for confinement through the area law and also participates as a basic ingredient in the formulation of lattice gauge theories [1, 2]. Equations concerning path-ordered phase factors were first obtained by Mandelstam [3] and analyzed in the QCD case by Nambu [4]. Loop equations were obtained by Polyakov [5] and Makeenko and Migdal [6, 7]. (For reviews, see Refs. [8] and [9].) The loop equations actually represent an infinite chain of coupled equations relating vacuum expectation values of loop operators having as supports different numbers of closed contours emerging from contours with self-intersections. These equations must in addition be supplemented with constraint equations [10, 11], the so-called Mandelstam constraints, which are sensitive to the gauge group structure of the theory. Due to their complexity, the loop equations have not yet allowed a systematic resolution of QCD in terms of loop variables. In the two-dimensional case however, explicit expressions of the Wilson loop averages for various types of contour have been obtained for $U(N_c)$ gauge theories [12]. Renormalization properties of the Wilson loop averages were studied in the framework of perturbation theory in Refs. [13, 14], where it was shown that the latter are multiplicatively renormalizable.

Considerable simplification is obtained in the large- N_c limit [15], corresponding to the planar diagram approximation of the theory. In that case, apart from the disappearance of many nonleading terms, it is the factorization property of the Wilson loop average for two disjoint contours that becomes mostly relevant. Makeenko and Migdal studied the resulting equations in the above limit pointing out their equivalence with a chain of Schwinger–Dyson type equations [6, 7]. They showed that for large contours asymptotic solutions exist corresponding to the minimal surfaces bounded by the loops.

Concerning physical applications, Eichten and Feinberg, using the area law for the Wilson loop, could obtain the general expression of spin-dependent forces for quark-antiquark systems to order $1/c^2$ in terms of color electric and magnetic field correlators [16]. This problem was also investigated by Gromes [17]. Later on, Prospero, Brambilla *et al.* completed these results by also obtaining the velocity-dependent forces [18, 19, 20, 21]. On the other hand, a wide program of investigations was undertaken by Dosch, Simonov *et al.* in the framework of the “stochastic vacuum model” [22].

In recent years, the Wilson loop gained renewal of interest in connection with duality properties of different field theories in different dimensions manifested through the AdS/CFT correspondence [23].

The purpose of the present paper is to investigate the properties of the Wilson loop concerning the bound state problem in QCD in the large-distance regime when the latter

is probed by minimal surfaces. Among possible nonperturbative solutions of the loop equations at large distances, minimal surfaces appear as the most natural ones [6, 7]; they produce in a simple way the area law needed for confinement and satisfy the factorization property, valid at large N_c . A complete solution of the loop equations should necessarily include short-distance effects for which minimal surfaces do not seem sufficient alone to provide the appropriate behavior. Therefore, for that regime perturbation theory results should appropriately be incorporated in the Wilson loop solution; this aspect of the problem will not, however, be analyzed in the present paper. Other nonperturbative properties of the theory, related to its possible string-like behavior, might also arise from contributions of fluctuations of surfaces around the minimal surface bounded by the loop [24, 25, 26].

The main ingredient in our approach is a representation of the quark propagator in the presence of an external gluon field as a series of terms involving free propagators, path-ordered phase factors along straight lines and their derivatives. That representation generalizes to the relativistic case the one used in the nonrelativistic limit [16]. The gauge invariant quark-antiquark Green function is then represented by a series of terms involving Wilson loops having as contours skew polygons with an increasing number of sides. Each Wilson loop average is then replaced by the contribution of the corresponding minimal surface bounded by the loop. Contrary to the usual two-particle Green functions, the gauge invariant Green function does not manifestly satisfy a genuine integral equation which might, as in the Bethe–Salpeter equation case [27], result in a bound state integral equation. In the present case, the Green function satisfies with the Dirac operators two independent and compatible equations. Selecting in the large time limit the total momentum of a bound state [28] and taking in the center-of-mass frame the equal-time limit for the two particles allow, with certain mathematical assumptions, the grouping of terms into a form that leads to a three-dimensional Breit–Salpeter type wave equation [29, 30], where the potentials are represented by the components of the energy-momentum vector of the straight segment joining the quark to the antiquark and carrying a constant linear energy density, equal to the string tension; they involve, apart from the usual confining linear potential, contributions coming from the moments of inertia of the above segment, which plays the role of the color flux tube of the quarkonium system.

The self-energy parts of the quark propagators, extracted from the interaction terms, allow the analysis of the chiral symmetry properties of the system. The situation here is very similar to that resulting from the exchange of one Coulomb-gluon and the latter has been studied in the literature. The Schwinger–Dyson equation satisfied by the self-energy part has a non-trivial solution leading to a spontaneous breakdown of chiral symmetry.

From the nonrelativistic limit of the wave equation one determines the hamiltonian

of the system to order $1/c^2$. Spin-spin potentials are absent from the hamiltonian. The contributions of the color flux tube result in new terms for the orbital angular momentum and for the spin-orbit potentials. In particular, the momentum of the flux tube contributes with a negative sign to the spin-orbit potential, in opposite direction to the contributions of the pure timelike vector potential, and may account for the phenomenological observations made for fine splitting.

At high energies, the mass spectrum displays linear Regge trajectories, the slopes of which tend to satisfy the classical relationship with the string tension.

The paper is organized as follows. In Sec. 2, we review the equations satisfied by the Wilson loop averages and outline the particular status of minimal surfaces within the set of possible solutions. In Sec. 3, we display some basic properties of minimal surfaces. In Sec. 4, the representation of the quark propagator in the presence of an external gluon field is constructed. Section 5 is devoted to the construction of the representation of the gauge invariant two-particle Green function in terms of a series of Wilson loops having as boundaries skew polygons. The bound state equation is derived in Sec. 6. Section 7 is devoted to the extraction from the interaction terms of the self-energy parts needed for the quark propagators. Chiral symmetry breaking is studied in Sec. 8. In Sec. 9, the main qualitative properties of the bound state spectrum are displayed. Summary and concluding remarks follow in Sec. 10. In appendix A, the main properties of minimal surfaces are presented. Appendix B is devoted to the determination of the normalization condition of the wave function. Appendix C gives details about the Breit approximation used for the resolution of the bound state spectrum.

2 Loop equations

The starting point is the gauge covariant path-ordered phase factor along a line C_{yx} joining point x to point y [§]:

$$U(C_{yx}, y, x) \equiv U(y, x) = Pe^{-ig \int_x^y dz^\mu A_\mu(z)}, \quad (2.1)$$

where $A_\mu = \sum_a A_\mu^a t^a$, A_μ^a ($a = 1, \dots, N_c^2 - 1$) being the gluon fields and t^a the generators of the gauge group $SU(N_c)$ in the fundamental representation, with the normalization $\text{tr} t^a t^b = \frac{1}{2} \delta^{ab}$. A more detailed definition of U is given by the series expansion in the coupling constant g ; all equations involving U can be obtained from the latter. Parametrizing the line C with a parameter σ , $C = \{x(\sigma)\}$, $0 \leq \sigma \leq 1$, such that $x(0) = x$ and $x(1) = y$, a variation of C induces the following variation of U [$U(x(\sigma), x(\sigma')) \equiv U(\sigma, \sigma')$,

[§]Formulas of this section are written in Minkowski space.

$A(x(\sigma)) \equiv A(\sigma)$]:

$$\begin{aligned} \delta U(1, 0) &= -ig\delta x^\alpha(1)A_\alpha(1)U(1, 0) + igU(1, 0)A_\alpha(0)\delta x^\alpha(0) \\ &\quad + ig \int_0^1 d\sigma U(1, \sigma)x'^\beta(\sigma)F_{\beta\alpha}(\sigma)\delta x^\alpha(\sigma)U(\sigma, 0), \end{aligned} \quad (2.2)$$

where $x' = \frac{\partial x}{\partial \sigma}$ and F is the field strength, $F_{\mu\nu} = \partial_\mu A_\nu - \partial_\nu A_\mu + ig[A_\mu, A_\nu]$. The functional derivative of U with respect to $x(\sigma)$ ($0 < \sigma < 1$) is then [5]:

$$\frac{\delta U(1, 0)}{\delta x^\alpha(\sigma)} = igU(1, \sigma)x'^\beta(\sigma)F_{\beta\alpha}(\sigma)U(\sigma, 0). \quad (2.3)$$

Defining the ordinary derivations with the prescriptions [5]

$$\frac{\partial}{\partial x^\mu(\sigma)} = \lim_{\varepsilon \rightarrow 0} \int_{\sigma-\varepsilon}^{\sigma+\varepsilon} d\sigma' \frac{\delta}{\delta x^\mu(\sigma')}, \quad (2.4)$$

$$\frac{\partial}{\partial x'^\mu(\sigma)} = \lim_{\varepsilon \rightarrow 0} \int_{\sigma-\varepsilon}^{\sigma+\varepsilon} d\sigma' (\sigma' - \sigma) \frac{\delta}{\delta x^\mu(\sigma')}, \quad (2.5)$$

one obtains:

$$\frac{\partial}{\partial x'^\beta(\sigma)} \frac{\delta U(1, 0)}{\delta x^\alpha(\sigma)} = igU(1, \sigma)F_{\beta\alpha}(\sigma)U(\sigma, 0). \quad (2.6)$$

A derivation with respect to $x^\mu(\sigma)$ then yields:

$$\frac{\partial}{\partial x^\mu(\sigma)} \frac{\partial}{\partial x'^\beta(\sigma)} \frac{\delta U(1, 0)}{\delta x^\alpha(\sigma)} = igU(1, \sigma)(\nabla_\mu F_{\beta\alpha}(\sigma))U(\sigma, 0), \quad (2.7)$$

where ∇ is the covariant derivative, $(\nabla F) = (\partial F) + ig[A, F]$.

The Wilson loop, denoted $\Phi(C)$, is defined as the trace in color space of the path-ordered phase factor (2.1) along a closed contour C :

$$\Phi(C) = \frac{1}{N_c} \text{tr} P e^{-ig \oint_C dx^\mu A_\mu(x)}, \quad (2.8)$$

where the factor $1/N_c$ has been put for normalization. It is a gauge invariant quantity. Its vacuum expectation value is denoted $W(C)$:

$$W(C) = \langle \Phi(C) \rangle_A, \quad W(C_1, C_2) = \langle \Phi(C_1)\Phi(C_2) \rangle_A, \quad (2.9)$$

the averaging being defined in the path integral formalism. More generally, one meets insertions of local operators $O(x)$ into the Wilson loop. Their vacuum expectation values are:

$$\langle O(x) \rangle_W \equiv \left\langle \frac{1}{N_c} \text{tr} P \left(e^{-ig \oint_C dz^\mu A_\mu(z)} O(x) \right) \right\rangle_A \Big|_{x \in C}. \quad (2.10)$$

The Wilson loop and its average also satisfy equations analogous to Eqs. (2.3), (2.6) and (2.7). Considering in Eq. (2.7) three different indices and taking their cyclic permutations one obtains in the right-hand side the Bianchi identity. For the Wilson loop average the equation takes the form

$$\varepsilon^{\nu\mu\beta\alpha} \frac{\partial}{\partial x^\mu} \frac{\partial}{\partial x'^\beta} \frac{\delta W(C)}{\delta x^\alpha} = 0. \quad (2.11)$$

Contraction of the indices μ and β in Eq. (2.7) leads in the right-hand side to the equation of motion of the gluon field. In the large N_c limit the quark current can be neglected and the corresponding term becomes equivalent to the functional derivative $-\delta/\delta A^\alpha$ which acts now on the Wilson loop. [Gauge-fixing and ghost terms mutually cancel each other in gauge invariant quantities [13, 14] and hence can be ignored.] One finds:

$$\frac{\partial}{\partial x^\beta} \frac{\partial}{\partial x'_\beta} \frac{\delta W(C)}{\delta x^\alpha} = i \frac{g^2 N_c}{2} \oint_C dy^\alpha \delta^4(y-x) \left[W(C_{yx}, C_{xy}) - \frac{1}{N_c^2} W(C) \right]. \quad (2.12)$$

Because of the delta function, the points y that contribute to the integral are those that lie in the vicinity of the point x . Two cases may emerge. First, the contour C may have self-intersection points and point x may be one of them. In that case, there is a point y which coincides with x in space but is not the same one on the contour. The contours C_{yx} and C_{xy} are the complementary contours separated by the intersection point and contribute as independent closed contours to the Wilson loop. Second, there is always the contribution of the points y which are close to x in space and on the contour. In that case, one of the contours C_{yx} or C_{xy} shrinks to zero and the other one becomes identical to C . In the large N_c limit, the Wilson loop average of the the two contours C_{yx} and C_{xy} factorizes into two loop averages and Eq. (2.12) becomes:

$$\frac{\partial}{\partial x^\beta} \frac{\partial}{\partial x'_\beta} \frac{\delta W(C)}{\delta x^\alpha} = i \frac{g^2 N_c}{2} \oint_C dy^\alpha \delta^4(y-x) W(C_{yx}) W(C_{xy}). \quad (2.13)$$

[The product $g^2 N_c$ is maintained fixed and finite in the above limit [15].]

Equations (2.11) and (2.13) can be considered as basic equations of QCD in the large N_c limit in loop space. The factorized structure of the right-hand side of Eq. (2.13) puts severe restrictions on the class of its possible solutions. Potential solutions of that equation with contours without self-intersections may not be solutions for contours with self-intersections. On the other hand, many physical applications related to meson spectroscopy do not require consideration of contours with self-intersections (in the static limit). Due to the huge complexity of the treatment of the problem with general types of contour, it seems reasonable, in view of physical applications, to limit, at a first stage, the investigations to contours not having self-intersections. We shall adopt this limitation in

the present paper, indicating at the end of this section the way of incorporating contours with self-intersections. Equation (2.13) then becomes:

$$\frac{\partial}{\partial x^\beta} \frac{\partial}{\partial x'_\beta} \frac{\delta W(C)}{\delta x_\alpha} = i \frac{g^2 N_c}{2} \oint_C dy^\alpha \delta^4(y-x) W(C). \quad (2.14)$$

The points y that contribute to the integral are those that lie in the vicinity of the point x in space and on the contour.

A first class of solution to Eqs. (2.11) and (2.13) is provided by perturbation theory [13, 14]. In the right-hand side of Eq. (2.13), $g^2 N_c$ represents the unrenormalized coupling constant and the resolution of the equation is accompanied by the renormalization of the theory and of the Wilson loop itself. However, perturbation theory becomes unstable at large distances and the search for nonperturbative solutions becomes necessary. Among these, minimal surfaces appear, for several reasons, as natural candidates. First, they easily reproduce the area law related to confinement [1]; second, they satisfy, with certain restrictions, the factorization law in the large N_c limit; third, they are connected to the classical action of string theory, which in turn is expected to have an implicit relationship with QCD [4, 24, 25, 26]. In the following, we concentrate on the contributions of surfaces to Eqs. (2.11) and (2.14).

Let S be a surface of a given type, that is satisfying a given equation, and having as contour the closed loop C . Let A be its area. Then a representation of the Wilson loop average can be given by the following expression:

$$W(C) = e^{-i\sigma A(S, C)}, \quad (2.15)$$

where σ is a constant, which will be identified with the string tension. Let us consider Eq. (2.11). It represents the action of some local deformation of the contour at point x . However, any local deformation on the contour also induces an internal deformation of the surface itself, because the latter is constrained by its defining equation and by the boundary condition. It turns out that the Bianchi identity operator, present in Eq. (2.11), is represented in the internal part of the surface (and on its contour) by the defining operator of minimal surfaces (surfaces having minimal area). Therefore, Eq. (2.11) implies that among surfaces of a given type, only minimal surfaces can be solutions of it. [The details of this assertion will be presented in the Sec. 3.] This result considerably reduces the class of surface type solutions to the loop equations. In order to incorporate other types of surface in representation (2.15) there remains the possibility of considering contributions of an infinite sum of all possible surfaces, which might, through mutual cancellations, satisfy Eq. (2.11). This latter possibility was considered in Ref. [7]. Such a sum can also be considered as representing fluctuations of surfaces around the minimal

surface and corresponding to string-like contributions [24, 25, 26]. Henceforth, we restrict ourselves to the study of contributions to Eq. (2.15) coming from minimal surfaces.

To study Eq. (2.14), one must introduce a short-distance regulator a since the right-hand side displays a singular behavior. Using for $W(C)$ representation (2.15) with a minimal surface one finds that Eq. (2.14) is satisfied provided one has the identification

$$\sigma = \frac{C g^2 N_c}{a^2 \frac{2}{2}}, \quad (2.16)$$

where C is a numerical constant. Notice that the use of an arbitrary trial functional for $W(C)$ would produce in general for the right-hand side of Eq. (2.14) a multiplicative functional depending on the whole contour C , rather than a local factor depending only on x and on its vicinity. If the unrenormalized coupling constant $g^2 N_c$ vanished as $O(a^2)$ with vanishing a , then minimal surfaces would define a theory by their own with a finite dimensional coupling constant σ . However, we know from the short-distance behavior of QCD, given by the perturbative solution, that the unrenormalized coupling constant vanishes only logarithmically. Therefore condition (2.16) cannot be satisfied in general. One must then interpret the minimal surface contribution to the Wilson loop average as a part of a general solution in which it represents its large-distance behavior, while the other part includes the perturbation theory contribution representing its short-distance behavior. A matching condition between the two parts at intermediate distances should then fix the value of the string tension σ in terms of the parameter Λ of QCD. We shall not study this aspect of the problem in the present paper, but rather shall assume that such a matching condition exists and is fulfilled and shall henceforth consider the properties of the large-distance behavior of the theory as deduced from the minimal surface contribution to the Wilson loop average.

Finally, let us comment on the factorization property of minimal surfaces. The minimal surface of two disconnected closed contours lying sufficiently far from each other is the sum of the minimal surfaces of each contour. This ensures the factorization property of the Wilson loop average valid at large N_c . However, when the two contours are close to each other new global solutions may arise that do not lead to factorization. Thus, for instance, if the two contours are similar to each other and lie closely one above the other, forming the two bases of a cylinder, then the global (or absolute) minimal surface corresponding to the two contours is the area of the lateral surface of the cylinder rather than the sum of the areas of its two bases, a result that manifestly does not lead to factorization. In such cases and even for single contours having complicated forms, the minimal surface solution should be chosen locally (therefore not necessarily the absolute one) with global properties being in agreement with factorization or with other physical requirements.

Extension of that prescription to the case of contours with self-intersections allows minimal surfaces to also satisfy the factorization property of the right-hand side of Eq.

(2.13). However, when such contours lie on overlapping surfaces additional contributions might be necessary to consider, since internal contours then belong to two adjacent surfaces. This is in particular the case in two-dimensional QCD [12].

In the next section, we shall study properties of minimal surfaces, showing some of the results mentioned above and deriving results needed for later investigations.

3 Loop equations and minimal surfaces

Let C be a closed contour and S a surface bounded by it. We shall generally consider as prototypes of contour those having four distinct sides, with junction points designated by x_1, x'_1, x'_2, x_2 (see Fig. 1).

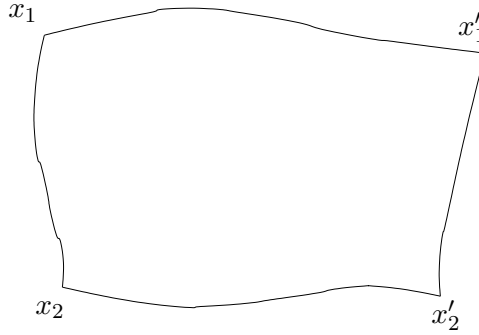

Figure 1: Prototype of a closed contour with four distinct sides.

The surface bounded by this contour will be parametrized with two parameters, σ and τ , and a point belonging to it will be represented as $x(\sigma, \tau)$ or $y(\sigma, \tau)$. We adopt for the partial derivatives the usual notations

$$x' = \frac{\partial x}{\partial \sigma}, \quad \dot{x} = \frac{\partial x}{\partial \tau}. \quad (3.1)$$

In general, the four sides of the contour will be parametrized as follows: $\{x_1x'_1\}$ with $\sigma = 0$, $\{x'_1x'_2\}$ with $\tau = 1$, $\{x'_2x_2\}$ with $\sigma = 1$ and $\{x_2x_1\}$ with $\tau = 0$. The area of the surface is[¶]:

$$A(C, S) = \int_0^1 d\sigma \int_0^1 d\tau (x'^2 \dot{x}^2 - (x' \cdot \dot{x})^2)^{1/2}. \quad (3.2)$$

To avoid the occurrence of possible divergences when dealing with functional derivatives of the area, it is necessary to introduce a short-distance regulator in the expression

[¶]Formulas related to surfaces will in general be written in euclidean space.

of the area. We adopt for the latter the following expression, already suggested in a more general form in Ref. [7]:

$$\begin{aligned}
A &= \frac{1}{2} \int d\sigma^{\mu\nu}(x) \int d\sigma^{\mu\nu}(y) F(x-y), \\
d\sigma^{\mu\nu}(x) &= d\sigma d\tau (x'^{\mu} \dot{x}^{\nu} - x'^{\nu} \dot{x}^{\mu}), \\
F &= \frac{a^2}{\pi} \frac{1}{\left((x-y)^2 + a^2\right)^2},
\end{aligned} \tag{3.3}$$

where a is the (positive) regulator and goes to zero at the end of calculations. In the limit $a \rightarrow 0$, F is actually equal to a two-dimensional δ -function:

$$\lim_{a \rightarrow 0} F = \left(x'^2 \dot{x}^2 - (x' \cdot \dot{x})^2\right)^{-1/2} \delta(\sigma - \sigma') \delta(\tau - \tau'). \tag{3.4}$$

This implies that it is only points x and y lying close to each other that contribute to the integral and therefore a limited number of terms of the expansion of y about x have to be considered in general. For example, one finds the following limits:

$$\frac{a^2}{\pi} \int d\sigma' d\tau' \frac{1}{\left((y(\sigma', \tau') - x(\sigma, \tau))^2 + a^2\right)^2} = \begin{cases} \left(x'^2 \dot{x}^2 - (x' \cdot \dot{x})^2\right)^{-1/2}, & \text{for } x \text{ inside } S, \\ \frac{1}{2} \left(x'^2 \dot{x}^2 - (x' \cdot \dot{x})^2\right)^{-1/2}, & \text{for } x \text{ on } C. \end{cases} \tag{3.5}$$

We are interested in variations of the area of the surface S when local variations are introduced on its contour C . S being a surface of a given type, that is satisfying a defining equation, any deformation of the contour introduces corresponding deformations inside the surface. Let us for definiteness consider deformations on the line $\tau = 0$. The general deformation of the area is:

$$\begin{aligned}
\delta A &= \int d\sigma \delta x^{\alpha}(\sigma, 0) (\delta_{\mu\alpha} x'^{\nu}(\sigma, 0) - \delta_{\nu\alpha} x'^{\mu}(\sigma, 0)) \int d\sigma^{\mu\nu}(y) F(y(\sigma', \tau') - x(\sigma, 0)) \\
&\quad + \int d\sigma^{\mu\nu}(y) \delta y^{\lambda}(\sigma', \tau') \sum_{P(\lambda, \mu, \nu)} \frac{\partial}{\partial y^{\lambda}} \int d\sigma^{\mu\nu}(z) F(z - y),
\end{aligned} \tag{3.6}$$

where $P(\lambda, \mu, \nu)$ indicates a cyclic permutation of the indices λ, μ, ν inside the sum. The functional derivative of A with respect to $x(\sigma, 0)$ is then:

$$\begin{aligned}
\frac{\delta A}{\delta x^{\alpha}(\sigma, 0)} &= (\delta_{\mu\alpha} x'^{\nu}(\sigma, 0) - \delta_{\nu\alpha} x'^{\mu}(\sigma, 0)) \int d\sigma^{\mu\nu}(y) F(y(\sigma', \tau') - x(\sigma, 0)) \\
&\quad + \int d\sigma^{\mu\nu}(y) \frac{\delta y^{\lambda}(\sigma', \tau')}{\delta x^{\alpha}(\sigma, 0)} \sum_{P(\lambda, \mu, \nu)} \frac{\partial}{\partial y^{\lambda}} \int d\sigma^{\mu\nu}(z) F(z - y).
\end{aligned} \tag{3.7}$$

The quantity $\delta y^{\lambda}(\sigma', \tau') / \delta x^{\alpha}(\sigma, 0)$ depends on the type of surface that is considered.

Applying on both sides of Eq. (3.7) the operators $\partial/\partial x'^\beta(\sigma, 0)$ and $\partial/\partial x^\gamma(\sigma, 0)$ in successive order, one obtains:

$$\begin{aligned} \frac{\partial}{\partial x^\gamma(\sigma, 0)} \frac{\partial}{\partial x'^\beta(\sigma, 0)} \frac{\delta A}{\delta x^\alpha(\sigma, 0)} &= 2 \frac{\partial}{\partial x^\gamma(\sigma, 0)} \int d\sigma^{\alpha\beta}(y) F(y(\sigma', \tau') - x(\sigma, 0)) \\ &+ \int d\sigma^{\mu\nu}(y) \left(\frac{\partial}{\partial x^\gamma(\sigma, 0)} \frac{\partial}{\partial x'^\beta(\sigma, 0)} \frac{\delta y^\lambda(\sigma', \tau')}{\delta x^\alpha(\sigma, 0)} \right) \sum_{P(\lambda, \mu, \nu)} \frac{\partial}{\partial y^\lambda} \int d\sigma^{\mu\nu}(z) F(z - y). \end{aligned} \quad (3.8)$$

In order to satisfy the Bianchi identity (2.11) with representation (2.15), the sum of the cyclic permutation of the left-hand side of Eq. (3.8) should vanish:

$$\sum_{P(\gamma, \beta, \alpha)} \frac{\partial}{\partial x^\gamma(\sigma, 0)} \frac{\partial}{\partial x'^\beta(\sigma, 0)} \frac{\delta A}{\delta x^\alpha(\sigma, 0)} = 0. \quad (3.9)$$

This involves through the right-hand side of Eq. (3.8) the sum $\sum_{P(\gamma, \beta, \alpha)} \frac{\partial}{\partial x^\gamma} \frac{\partial}{\partial x'^\beta} \frac{\delta y^\lambda}{\delta x^\alpha}$. For arbitrary contours, that quantity does not identically vanish. Therefore, the only solution to Eq. (3.9) is the constraint

$$\sum_{P(\lambda, \mu, \nu)} \frac{\partial}{\partial x^\lambda} \int d\sigma^{\mu\nu}(y) F(y - x) = 0, \quad x \text{ inside } S \text{ or on } C, \quad (3.10)$$

which is the defining equation of minimal surfaces.

In order to check Eq. (2.14), we limit ourselves to the case of minimal surfaces. In that case, the second term of the right-hand side of Eq. (3.8) is null and the first term gives after contraction of the indices γ and β :

$$\frac{\partial}{\partial x^\beta} \frac{\partial}{\partial x'^\beta} \frac{\delta A}{\delta x^\alpha} = \frac{1}{a} \frac{x'^\alpha}{(x'^2)^{1/2}} + O(a). \quad (3.11)$$

On the other hand, regularizing the delta function of Eq. (2.14) according to the prescription

$$\delta^4(x) \rightarrow -\frac{1}{4\pi^2} \partial^2 \frac{1}{x^2 + a^2}, \quad (3.12)$$

one obtains, with the proper-time parametrization ($x'^2 = \text{constant}$):

$$\int dy^\alpha \delta^4(y - x) = \frac{1}{4\pi a} \left(\frac{3}{a^2} \frac{x'^\alpha}{(x'^2)^{1/2}} + \frac{x'''\alpha}{(x'^2)^{3/2}} + \frac{x'^\alpha x''^2}{(x'^2)^{5/2}} \right) + O(a). \quad (3.13)$$

Use of representation (2.15) and comparison of both sides of Eq. (2.14) (in its euclidean version) gives for finite σ the identification (2.16) with $C = 3/(4\pi)$, which necessitates a quadratically vanishing $g^2 N_c$ with a when short-distance interactions are ignored.

Coming back to the first-order variation of the area [Eq. (3.7)] it becomes in the case of a minimal surface:

$$\begin{aligned} \frac{\delta A}{\delta x^\alpha(\sigma, 0)} &= (\delta_{\mu\alpha} x'^\nu(\sigma, 0) - \delta_{\nu\alpha} x'^\mu(\sigma, 0)) \int d\sigma^{\mu\nu}(y) F(y(\sigma', \tau') - x(\sigma, 0)), \\ &= -\frac{(x'^2 \dot{x}^\alpha - x' \cdot \dot{x} x'^\alpha)}{\sqrt{x'^2 \dot{x}^2 - (x' \cdot \dot{x})^2}}, \end{aligned} \quad (3.14)$$

the second equation resulting in the limit $a = 0$; it manifestly satisfies the orthogonality condition

$$x'^\alpha(\sigma, 0) \frac{\delta A}{\delta x^\alpha(\sigma, 0)} = 0, \quad (3.15)$$

in agreement with Eq. (2.3).

Some properties of minimal surfaces are presented in appendix A. One main property that we shall use in the present paper concerns the commutativity property of two successive functional derivatives of the minimal area on its contour C ,

$$\left(\frac{\delta}{\delta x^\beta(\sigma')} \frac{\delta}{\delta x^\alpha(\sigma)} - \frac{\delta}{\delta x^\alpha(\sigma)} \frac{\delta}{\delta x^\beta(\sigma')} \right) A(C) = 0, \quad (3.16)$$

a feature that is reminiscent of a similar property of the Wilson loop average:

$$\left(\frac{\delta}{\delta x^\beta(\sigma')} \frac{\delta}{\delta x^\alpha(\sigma)} - \frac{\delta}{\delta x^\alpha(\sigma)} \frac{\delta}{\delta x^\beta(\sigma')} \right) W(C) = 0. \quad (3.17)$$

4 The quark propagator in the external gluon field

In dealing with the quarkonium bound state problem within the Wilson loop approach, one needs, in the path integral formalism, a representation of the quark propagator in the presence of an arbitrary external gluon field, satisfying the equation

$$(i\gamma \cdot \partial_{(x)} - m - g\gamma \cdot A(x)) S(x, x') = i\delta^4(x - x'). \quad (4.1)$$

The usual perturbative representation $S(x, x') = i(i\gamma \cdot \partial - m - g\gamma \cdot A)^{-1} \delta^4(x - x')$ is not very convenient here since at each order of the perturbative expansion in the coupling constant the gauge covariance of the propagator is lost and the construction of the Wilson loop including contributions of fermion propagators becomes tricky. A representation that is well suited to exhibit the Wilson loop structure of the gauge invariant two-particle Green functions is the Feynman–Schwinger representation [32], which represents the quark propagator as a quantum mechanical path integral. This representation has however the main drawback that it dissolves the Dirac operator into the path integral and makes it difficult to obtain from it an equation that easily displays the properties of fermions. In

the present work we shall consider a representation that is based on an explicit use of the free Dirac propagator accompanied by a path-ordered phase factor. It will have the advantage of manifestly preserving the main properties of fermions.

The building block of the representation is the gauge covariant composite object, denoted $\tilde{S}(x, x')$, made of a free fermion propagator $S_0(x - x')$ (without color group content) multiplied by the path-ordered phase factor $U(x, x')$ [Eq. (2.1)] taken along the straight segment xx' :

$$\left[\tilde{S}(x, x')\right]_b^a \equiv S_0(x - x')\left[U(x, x')\right]_b^a. \quad (4.2)$$

The advantage of the straight segment over other types of line is that in the limit $x' \rightarrow x$ U tends to unity in an unambiguous way. \tilde{S} satisfies the following equation with respect to x :

$$\left(i\gamma \cdot \partial_{(x)} - m - g\gamma \cdot A(x)\right)\tilde{S}(x, x') = i\delta^4(x - x') + i\gamma^\alpha \int_0^1 d\lambda \lambda \left(\frac{\delta U(x, x')}{\delta x^\alpha(\lambda)}\right) S_0(x - x'), \quad (4.3)$$

where the segment xx' has been parametrized with the parameter λ as $x(\lambda) = \lambda x + (1 - \lambda)x'$. In the above equation, the point x' is held fixed; furthermore, the operator $\delta/\delta x^\alpha(\lambda)$ does not act on the explicit boundary point x of the segment (corresponding to $\lambda = 1$, cf. Eqs. (2.2)-(2.3)), this contribution having already been cancelled by the gluon field term A . A similar equation also holds with respect to x' , with x held fixed, with the Dirac and color group matrices acting from the right.

The quantity $-i(i\gamma \cdot \partial_{(x)} - m - g\gamma \cdot A(x))\delta^4(x - x')$ is the inverse of the quark propagator S in the presence of the external gluon field A . Reversing Eq. (4.3) with respect to S^{-1} , one obtains an equation for S in terms of \tilde{S} :

$$S(x, x') = \tilde{S}(x, x') - \int d^4x'' S(x, x'')\gamma^\alpha \int_0^1 d\lambda \lambda \frac{\delta}{\delta x^\alpha(\lambda)} \tilde{S}(x'', x'), \quad (4.4)$$

where the operator $\delta/\delta x^\alpha(\lambda)$ acts on the factor U of \tilde{S} , along the internal part of the segment $x''x'$, with x' held fixed. Using the equation with x' , or making in Eq. (4.4) an integration by parts, one obtains another equivalent equation:

$$S(x, x') = \tilde{S}(x, x') + \int d^4x'' \int_0^1 d\lambda (1 - \lambda) \tilde{S}(x, x'') \overleftarrow{\frac{\delta}{\delta x^\alpha(\lambda)}} \gamma^\alpha S(x'', x'). \quad (4.5)$$

Equations (4.4) or (4.5) allow us to obtain the propagator S as an iteration series with respect to \tilde{S} , which contains the free fermion propagator, by maintaining at each order of the iteration its gauge covariance property. For instance, the expansion of Eq. (4.4) takes the form:

$$\begin{aligned} S(x, x') &= \tilde{S}(x, x') - \int d^4y_1 \tilde{S}(x, y_1) \gamma^{\alpha_1} \int_0^1 d\lambda_1 \lambda_1 \frac{\delta}{\delta x^{\alpha_1}(\lambda_1)} \tilde{S}(y_1, x') \\ &+ \int d^4y_1 d^4y_2 \int_0^1 d\lambda_1 \lambda_1 d\lambda_2 \lambda_2 \tilde{S}(x, y_1) \gamma^{\alpha_1} \left(\frac{\delta}{\delta x^{\alpha_1}(\lambda_1)} \tilde{S}(y_1, y_2)\right) \gamma^{\alpha_2} \left(\frac{\delta}{\delta x^{\alpha_2}(\lambda_2)} \tilde{S}(y_2, x')\right) \\ &+ \dots, \end{aligned} \quad (4.6)$$

the operator $\delta/\delta x(\lambda_i)$ acting on the inner part of the segment $y_i y_{i+1}$ of the phase factor $U(y_i, y_{i+1})$. A verification of Eq. (4.1) can be done through the above iteration series. The operator $\partial/\partial x$ acts on three terms. First, acting on the free fermion propagator contained in $\tilde{S}(x, x'')$, it gives, with the Dirac operator, a $\delta^4(x - x'')$ type term which then removes the integration over x'' . Second, it acts on the boundary point x of $U(x, x'')$ and cancels the gluon field term A . Third, it acts on the inner part of the segment $x x''$ of U . This term is then cancelled by the δ^4 -term coming from the next-order term of the iteration series under the action of the Dirac operator on the corresponding free propagator, and so forth. Equations (4.4) and (4.5) are generalizations of the representation used for heavy quarks starting from the static case [16].

The action of the operator $\delta/\delta x^\alpha(\lambda)$ on U can be expressed in terms of an insertion of the field strength F [Eq. (2.3)]. One can check with the first few terms of the series, using integrations by parts, that one can recover, in perturbation theory with respect to the coupling constant g , the conventional perturbative expansion of S in terms of g and A .

5 The two-particle gauge invariant Green function

The next step is to consider the quark-antiquark gauge invariant Green function, for quarks q_1 and q_2 with different flavors and with masses m_1 and m_2 :

$$G(x_1, x_2; x'_1, x'_2) \equiv \langle \bar{\psi}_2(x_2) U(x_2, x_1) \psi_1(x_1) \bar{\psi}_1(x'_1) U(x'_1, x'_2) \psi_2(x'_2) \rangle_{A, q_1, q_2}, \quad (5.1)$$

the averaging being defined in the path-integral formalism. Here, $U(x_2, x_1)$ is the phase factor (2.1) along the straight segment $x_2 x_1$ (and similarly for $U(x'_1, x'_2)$). According to the conclusion reached in the final part of appendix A, the dynamics of the system concerning its energy spectrum not containing string-like excitations can be probed by considering between the quark and the antiquark equal-time straight segments (in a given reference frame, e.g., the rest frame of the bound state); deviations of lines $C_{x_2 x_1}$ from the equal-time straight segment contribute only to the wave functional of the bound state and not to its energy. However, for covariance reasons, we first consider general straight segments $x_2 x_1$ (not necessarily equal-time) and it is at a later stage that the equal-time limit will be taken.

Integrating in the large N_c limit with respect to the quark fields, one obtains:

$$G(x_1, x_2; x'_1, x'_2) = -\langle \text{tr}_c U(x_2, x_1) S_1(x_1, x'_1) U(x'_1, x'_2) S_2(x'_2, x_2) \rangle_A, \quad (5.2)$$

where S_1 and S_2 are the two quark propagators in the presence of the external gluon field and tr_c designates the trace with respect to the color group.

The Green function G satisfies the following equation with respect to the Dirac operator of particle 1 acting on x_1 :

$$(i\gamma \cdot \partial_{(x_1)} - m_1)G(x_1, x_2; x'_1, x'_2) = -i\langle \text{tr}_c U(x_2, x_1) \delta^4(x_1 - x'_1) U(x'_1, x'_2) S_2(x'_2, x_2) \rangle_A - i\gamma^\alpha \langle \text{tr}_c \int_0^1 d\sigma (1 - \sigma) \frac{\delta U(x_2, x_1)}{\delta x^\alpha(\sigma)} S_1(x_1, x'_1) U(x'_1, x'_2) S_2(x'_2, x_2) \rangle_A, \quad (5.3)$$

where the segment $x_2 x_1$ has been parametrized with the parameter σ as $x(\sigma) = (1 - \sigma)x_1 + \sigma x_2$; furthermore, the operator $\delta/\delta x^\alpha$ does not act on the explicit boundary point x_1 of the segment (cf. Eqs. (2.2)-(2.3)), this contribution having already been cancelled by the contribution of the gluon field A coming from the quark propagator S_1 . A similar equation also holds with the Dirac operator of particle 2:

$$G(x_1, x_2; x'_1, x'_2)(-i\gamma \cdot \overleftarrow{\partial}_{(x_2)} - m_2) = -i\langle \text{tr}_c U(x_2, x_1) S_1(x_1, x'_1) U(x'_1, x'_2) \delta^4(x'_2 - x_2) \rangle_A + i\langle \text{tr}_c \int_0^1 d\sigma \sigma \frac{\delta U(x_2, x_1)}{\delta x^\beta(\sigma)} S_1(x_1, x'_1) U(x'_1, x'_2) S_2(x'_2, x_2) \rangle_A \gamma^\beta. \quad (5.4)$$

Using for S_1 and S_2 representations (4.4) and (4.5), respectively, one obtains for G an expansion in a series of terms involving an increasing number of straight segments between x_1 and x'_1 on the one hand and between x_2 and x'_2 on the other. With each segment is associated a path-ordered phase factor U ; the union of all such factors, together with $U(x_2, x_1)$ and $U(x'_1, x'_2)$, forms a Wilson loop along a skew polygon. We can then represent G in the following form:

$$G = \sum_{i,j=1}^{\infty} G_{i,j}, \quad (5.5)$$

where $G_{i,j}$ represents the contribution of the term of the series having $(i - 1)$ points of integration between x_1 and x'_1 (i segments) and $(j - 1)$ points of integration between x_2 and x'_2 (j segments). We designate by $C_{i,j}$ the contour associated with the term $G_{i,j}$. A typical configuration for the contour of $G_{4,3}$ is represented in Fig. 2.

Using for the averages of the Wilson loops appearing in the above series the representation with minimal surfaces, and designating by $A_{i,j}$ the minimal area associated with the contour $C_{i,j}$, one obtains for the latter the following representation:

$$G_{i,j} = (-1)^i N_c \int d^4 y_1 \cdots d^4 y_{i-1} d^4 z_1 \cdots d^4 z_{j-1} S_{10}(x_1 - y_1) \gamma^{\alpha_1} S_{10}(y_1 - y_2) \cdots \times \gamma^{\alpha_{i-1}} S_{10}(y_{i-1} - x'_1) S_{20}(x'_2 - z_{j-1}) \gamma^{\beta_{j-1}} S_{20}(z_{j-1} - z_{j-2}) \cdots \gamma^{\beta_1} S_{20}(z_1 - x_2) \times \int_0^1 d\tau_1 \cdots d\tau_{i-1} \int_0^1 d\tau'_1 \cdots d\tau'_{j-1} (1 - \tau_1) \cdots (1 - \tau_{i-1}) (1 - \tau'_1) \cdots (1 - \tau'_{j-1}) \frac{\delta}{\delta x^{\alpha_1}(\tau_1)} \cdots \frac{\delta}{\delta x^{\alpha_{i-1}}(\tau_{i-1})} \frac{\delta}{\delta x^{\beta_1}(\tau'_1)} \cdots \frac{\delta}{\delta x^{\beta_{j-1}}(\tau'_{j-1})} e^{-i\sigma A_{i,j}}. \quad (5.6)$$

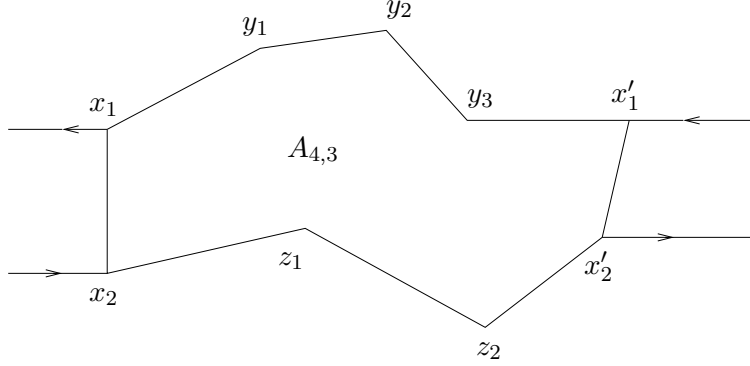

Figure 2: The contour associated with the term $G_{4,3}$.

Here, the operators $\delta/\delta x(\tau_k)$ and $\delta/\delta x(\tau'_\ell)$ act on the surface $A_{i,j}$ through their action on the segments $y_k y_{k+1}$ and $z_\ell z_{\ell+1}$ of the contour, respectively. (The parametrization of the segments of the line $x_1 x'_1$ is the opposite of that of Sec. 4: τ now increases along the direction $x_1 x'_1$ to be in accordance with that adopted for the surfaces; cf. comment after Eq. (3.1).) S_{10} and S_{20} are the free quark propagators with masses m_1 and m_2 , respectively.

Using in Eqs. (5.3)-(5.4) representations (4.4)-(4.5) for the quark propagators, one obtains:

$$(i\gamma \cdot \partial_{(x_1)} - m_1)G(x_1, x_2; x'_1, x'_2) = -i\delta^4(x_1 - x'_1) \sum_{j=1}^{\infty} G_{0,j} + i\gamma^\alpha \sum_{i,j=1}^{\infty} \int_0^1 d\sigma (1-\sigma) \frac{\delta}{\delta x^\alpha(\sigma)} G_{i,j} \Big|_{x(\sigma) \in x_1 x_2}, \quad (5.7)$$

$$G(x_1, x_2; x'_1, x'_2) (-i\overleftarrow{\gamma} \cdot \partial_{(x_2)} - m_2) = +i\delta^4(x_2 - x'_2) \sum_{i=1}^{\infty} G_{i,0} - i \sum_{i,j=1}^{\infty} \int_0^1 d\sigma \sigma \frac{\delta}{\delta x^\beta(\sigma)} G_{i,j} \gamma^\beta \Big|_{x(\sigma) \in x_1 x_2}, \quad (5.8)$$

where $G_{0,j}$ and $G_{i,0}$ are particular cases of representation (5.6) in which the particle 1 or 2 propagators have been shrunk to a delta-function. These equations can also be obtained by making the Dirac operators act on Eq. (5.5) and using in the right-hand side representation (5.6).

The two equations (5.3) and (5.4) are independent, since the two Dirac operators concern independent particle variables. They are also compatible; this is evident from the very fact that G exists and is given by formula (5.2). However, an independent check can also be done by making the Dirac operator of particle 2 act on Eq. (5.3) and the Dirac operator of particle 1 act on Eq. (5.4), using in the right-hand sides the properties

of the propagators and of the phase factors U and subtracting from each other the two resulting equations. The result is zero, due mainly to the facts that the final expressions involve functional derivatives $\delta/\delta x(\sigma)$ and $\delta/\delta x(\sigma')$ of the phase factor $U(x_2, x_1)$ and these commute. A similar verification can also be done with Eqs. (5.7)-(5.8), where now the representation of the Wilson loop averages by minimal surfaces has been used. One has to use in the right-hand sides properties of the terms $G_{i,j}$ and cancellations between contributions of successive $G_{i,j}$ s along the quark and antiquark lines. One ends up with expressions involving functional derivatives $\delta/\delta x(\sigma)$ and $\delta/\delta x(\sigma')$ of minimal surfaces along the segment x_1x_2 . The compatibility of the two equations is then due to the fact that two successive functional derivatives of a minimal area localized on its contour commute [Eq. (3.16) and appendix A].

Eqs. (5.7)-(5.8) are not closed integro-differential equations for G , for once the action of the functional derivatives $\delta/\delta x$ on the various minimal surfaces has been evaluated one does not obtain back G on the right-hand sides. This feature makes difficult the search for a bound state equation in compact form. In this respect, if G has a bound state pole in momentum space, then the right-hand sides of Eqs. (5.7)-(5.8) should also have the same pole; this is possible only if the actions of the functional derivatives $\delta/\delta x$ on the partial ingredients $G_{i,j}$ of G yield among other terms common factors that allow coherent summations of the $G_{i,j}$ s to produce again a pole term; otherwise, each $G_{i,j}$, containing a finite number of free quark propagators, cannot produce alone such a pole. In x -space, the selection of a bound state is made by taking a large time separation between the pairs of points (x_1, x_2) on the one hand and (x'_1, x'_2) on the other [28].

The independence of the two equations (5.7)-(5.8) means also that they might allow the elimination of the relative time variable of the two particles prior to any resolution of an eigenvalue equation and the reduction of the internal dynamics to a three-dimensional space, a feature which was outlined at the beginning of this section according to the results obtained at the end of appendix A. However, such a reduction does not seem easily manageable on the general forms of Eqs. (5.7)-(5.8). Furthermore, arbitrary approximations made in the right-hand sides of those equations may destroy their compatibility property. This is why in the following we shall directly study the equal-time limit of the system by considering the “sum” of the two equations and then, at a later stage, shall indicate how to determine its relative time evolution law by considering the “difference” of the two equations.

6 Bound state equation

In the large N_c limit, the mesonic sector of QCD is composed of one-particle states, which are bound states of a quark-antiquark pair and of gluons [15, 33]. Taking in the Green function (5.1) a large time separation between the pairs of points (x_1, x_2) and (x'_1, x'_2) and using the completeness relation one finds:

$$G(x_1, x_2; x'_1, x'_2) = \sum_n \Phi_n(x_1, x_2) \bar{\Phi}_n(x'_2, x'_1), \quad (6.1)$$

where Φ_n is the wave functional of the bound state labelled with the collective quantum numbers n :

$$\begin{aligned} i\Phi_{n, \alpha_1, \alpha_2}(x_1, x_2) &= \langle 0 | \bar{\psi}_{2, \alpha_2}(x_2) U(x_2, x_1) \psi_{1, \alpha_1}(x_1) | n \rangle, \\ -i\bar{\Phi}_{n, \alpha'_2, \alpha'_1}(x'_2, x'_1) &= \langle n | \bar{\psi}_{1, \alpha'_1}(x'_1) U(x'_1, x'_2) \psi_{2, \alpha'_2}(x'_2) | 0 \rangle. \end{aligned} \quad (6.2)$$

Since the lines $C_{x_2 x_1}$ and $C_{x'_1 x'_2}$ are rigid straight segments completely determined by their end points, one can consider the wave functionals as functions of the end point coordinates. Introducing total and relative coordinates and momenta,

$$\begin{aligned} X &= \frac{1}{2}(x_1 + x_2), \quad x = x_2 - x_1, \quad P = p_1 + p_2, \quad p = \frac{1}{2}(p_2 - p_1), \\ p_{a, \mu} &= i \frac{\partial}{\partial x_a^\mu}, \quad a = 1, 2, \end{aligned} \quad (6.3)$$

and considering a bound state with total momentum P , one has:

$$\Phi(x_1, x_2) = e^{-iP \cdot X} \phi(P, x). \quad (6.4)$$

In the large separation time limit, the right-hand side of Eq. (6.1) displays a series of oscillating functions in the separation time variable. By appropriate projections and integrations one can select in this series the bound state that will survive in the large time limit [28]. It should be emphasized that in the above limit only terms that factorize in G into expressions depending on the line $x_1 x_2$ and expressions depending on the line $x'_1 x'_2$ could survive to the selection operation of the bound state. Terms that still contain expressions joining line $x'_1 x'_2$ to line $x_1 x_2$ would not contribute to the previous operation and could be discarded.

It is convenient to consider the total momentum P of the selected bound state as a reference timelike vector and define transverse and longitudinal parts of vectors with respect to it:

$$\begin{aligned} q_\mu^T &= q_\mu - \frac{q \cdot P}{P^2} P_\mu, \quad q_\mu^L = (q \cdot \hat{P}) \hat{P}_\mu, \quad \hat{P}_\mu = \frac{P_\mu}{\sqrt{P^2}}, \quad q_L = q \cdot \hat{P}, \\ P_L &= \sqrt{P^2}, \quad q_L \Big|_{\text{c.m.}} = q_0, \quad q^{T^2} \Big|_{\text{c.m.}} = -\mathbf{q}^2, \quad \sqrt{-x^{T^2}} \Big|_{\text{c.m.}} = r. \end{aligned} \quad (6.5)$$

These decompositions are manifestly covariant. To further simplify the notation we adopt for the Dirac matrices the following convention: they will be written on the left of the spinor functions with labels 1 or 2 indicating on which particle indices they act, the particle 2 matrices (the antiquark at x_2) acting actually from the right; thus:

$$\begin{aligned}\gamma_{1\mu}G &\equiv (\gamma_\mu)_{\alpha_1\beta_1}G_{\beta_1\alpha_2,\alpha'_2\alpha'_1}, & \gamma_{2\mu}G &\equiv G_{\alpha_1\beta_2,\alpha'_2\alpha'_1}(\gamma_\mu)_{\beta_2\alpha_2}, \\ \gamma_{2\mu}\gamma_{2\nu}G &\equiv G_{\alpha_1\beta_2,\alpha'_2\alpha'_1}(\gamma_\nu\gamma_\mu)_{\beta_2\alpha_2}, & \gamma_{2\mu}\gamma_{25}G &\equiv G_{\alpha_1\beta_2,\alpha'_2\alpha'_1}(\gamma_5\gamma_\mu)_{\beta_2\alpha_2}.\end{aligned}\quad (6.6)$$

Similar definitions also hold when G is replaced by Φ . Notice that products of γ_2 matrices act from the right in the reverse order.

We next introduce the free Dirac hamiltonians of the two particles:

$$h_{10} = m_1\gamma_{1L} - \gamma_{1L}\gamma_1^T \cdot p_1^T, \quad h_{20} = -m_2\gamma_{2L} - \gamma_{2L}\gamma_2^T \cdot p_2^T. \quad (6.7)$$

Going back to Eqs. (5.7)-(5.8), multiplying the first by γ_{1L} , the second by $-\gamma_{2L}$, adding and subtracting the two equations one finds:

$$\begin{aligned}[(p_{1L} + p_{2L}) - (h_{10} + h_{20})]G &= -i\delta^4(x_1 - x'_1)\gamma_{1L}\sum_{j=1}^{\infty}G_{0,j} - i\delta^4(x_2 - x'_2)\gamma_{2L}\sum_{i=1}^{\infty}G_{i,0} \\ &+ i\left[\gamma_{1L}\gamma_1^\alpha \int_0^1 d\sigma(1 - \sigma)\frac{\delta}{\delta x^\alpha(\sigma)} + \gamma_{2L}\gamma_2^\beta \int_0^1 d\sigma\sigma\frac{\delta}{\delta x^\beta(\sigma)}\right]\sum_{i,j=1}^{\infty}G_{i,j}\Big|_{x(\sigma)\in x_1x_2},\end{aligned}\quad (6.8)$$

$$\begin{aligned}[(p_{1L} - p_{2L}) - (h_{10} - h_{20})]G &= -i\delta^4(x_1 - x'_1)\gamma_{1L}\sum_{j=1}^{\infty}G_{0,j} + i\delta^4(x_2 - x'_2)\gamma_{2L}\sum_{i=1}^{\infty}G_{i,0} \\ &+ i\left[\gamma_{1L}\gamma_1^\alpha \int_0^1 d\sigma(1 - \sigma)\frac{\delta}{\delta x^\alpha(\sigma)} - \gamma_{2L}\gamma_2^\beta \int_0^1 d\sigma\sigma\frac{\delta}{\delta x^\beta(\sigma)}\right]\sum_{i,j=1}^{\infty}G_{i,j}\Big|_{x(\sigma)\in x_1x_2}.\end{aligned}\quad (6.9)$$

Equation (6.9) mainly determines the relative time evolution of the Green function, while Eq. (6.8) mainly determines the dynamical properties of the two-particle system. Since that equation does not involve the relative energy operator $(p_{2L} - p_{1L})$ in its left-hand side, one is entitled to take in it the equal-time limit $x_L = 0$; the equation becomes in that case three-dimensional with respect to the transverse relative coordinates x^T . After determining, within a given approximation, the dynamical properties of the system from Eq. (6.8) in the limit $x_L = 0$, one can go back to Eq. (6.9) and determine, within the same approximation, its relative time evolution law. We shall henceforth follow this method of approach.

In the large separation time limit between the pairs of points (x_1, x_2) and (x'_1, x'_2) the delta-functions that are present in the right hand-sides of Eqs. (6.8)-(6.9) do not contribute and can be ignored. In order to extract from the right-hand side of Eq. (6.8) a bound state wave function Φ , it is necessary that the actions of the functional derivatives $\delta/\delta x(\sigma)$ on the various parts $G_{i,j}$ yield among other terms common factors that factorize

the Green function G again. The functional derivative $\delta/\delta x(\sigma)$ acts on a given $G_{i,j}$ [Eq. (5.6)] through the exponential factor containing the minimal area term and yields a term proportional to $\delta A_{i,j}/\delta x(\sigma)$. This term may itself be acted on by the other functional derivatives existing in the definition of $G_{i,j}$. One thus ends up with two types of term. The first contains the first-order derivative $\delta A_{i,j}/\delta x(\sigma)$, which factorizes the other derivatives on the left, and the second contains terms involving higher-order derivatives of $A_{i,j}$, one of the derivatives acting along the straight segment x_1x_2 . The dominant part in the large-distance limit comes from the first type of term; higher-order derivatives of the minimal area tend to weaken the large-distance behavior (cf. appendix A for the second-order derivative). In the following we shall mainly concentrate on the contribution of the first type of term; terms containing second-order derivatives will be considered in Sec. 7, in connection with the self-energy parts of the quark propagators.

The term that is retained with $G_{i,j}$ is an integral over σ of a function proportional to $\delta A_{i,j}/\delta x(\sigma)$. According to Eq. (3.14), the latter depends only on the local properties of the surface at the point $x(\sigma, 0)$ lying on the straight segment x_1x_2 , namely upon the derivatives $x'(\sigma, 0)$ and $\dot{x}(\sigma, 0)$. Because the line $C_{x_2x_1}$ is a straight segment, one has $x'(\sigma, 0) = x$, independent of the form of the surface. In the equal-time limit ($x_L = 0$) the previous relation becomes $x'(\sigma, 0) = x^T$. The derivative $\dot{x}(\sigma, 0)$ depends, however, on the form of the minimal surface in the vicinity of the straight segment. Using methods of analysis similar to those used at the end of appendix A one can show that in the large separation time limit $\dot{x}(\sigma, 0)$ tends to a linear function of sigma. In that case, one can parametrize it as $\dot{x}(\sigma, 0) = (1 - \sigma)\dot{x}_1 + \sigma\dot{x}_2$, where \dot{x}_1 and \dot{x}_2 are the slopes at the points x_1 and x_2 , respectively, $\dot{x}_1 = \dot{x}(0, 0)$, $\dot{x}_2 = \dot{x}(1, 0)$. The latter make still reference to the other end points of the corresponding segments; for the case of the simplest contour $C_{1,1}$, these are x'_1 and x'_2 . In order to remove any explicit reference to the points of the remote past an operator representation of the slopes, depending only on points x_1 and x_2 becomes necessary.

To find such a representation, we consider the simplest contour $C_{1,1}$ corresponding to $G_{1,1}$. Here, one has $\dot{x}_1 = (x'_1 - x_1)$, $\dot{x}_2 = (x'_2 - x_2)$, $\dot{x}_{aL} < 0$ with our parametrization and because of the facts that $x_{aL} \rightarrow +\infty$ and $x'_{aL} \rightarrow -\infty$ ($a = 1, 2$). Considering in general the cases x_L and x'_L finite in the above limits, one can set, modulo negligible terms, $x_{1L} = x_{2L}$. (This is exact in the equal-time cases $x_L = 0$ and $x'_L = 0$.) Furthermore, a close examination of the integrals of the term $\delta A_{1,1}/\delta x(\sigma)$ shows that the \dot{x}_a terms ($a = 1, 2$) appear after integration in the forms $\dot{x}_a^\alpha/|\dot{x}_{aL}|$ and through their orthogonal components to x_1x_2 . An operator representation of the latter can be found by making the quark momentum operators $p_{a\mu}$ act on the term $G_{1,1}$. They generally yield three different contributions. The first comes from their action on the corresponding free quark

propagator, the second from the segment x_1x_2 and the third from the segment $(x'_a - x_a)$. Since the terms $\dot{x}_a^\alpha/|\dot{x}_{aL}|$ already appear in expressions that are proportional to the string tension σ , one can use for the latter terms, as a first approximation, free theory expressions; in this case, it is sufficient to retain the contributions coming from the free quark propagators. The latter, in the large time limit yield with massive quarks the following dominant behavior:

$$p_{a\mu}S_{a0}(x_a - x'_a) \simeq m_a \frac{(x_a - x'_a)_\mu}{\sqrt{(x_a - x'_a)^2}} S_{a0}(x_a - x'_a), \quad (x_a - x'_a)_L \rightarrow +\infty, \quad a = 1, 2, \quad (6.10)$$

from which one deduces:

$$-\frac{\dot{x}_{a\mu}}{|\dot{x}_{aL}|} \longleftrightarrow \frac{p_{a\mu}}{|p_{aL}|}, \quad a = 1, 2, \quad (6.11)$$

where the operators p_{aL} are the free theory expressions of the individual energies:

$$p_{aL} = h_{a0}, \quad |p_{aL}| = \sqrt{m_a^2 - p_a^{T2}} \equiv E_a(p_a^T), \quad a = 1, 2, \quad (6.12)$$

h_{a0} being defined in Eqs. (6.7).

This approximation will retain all terms of order up to $O(1/c^2)$ in the nonrelativistic limit; terms that have been neglected, if they are nonzero, have contributions in the nonrelativistic limit starting at order $O(1/c^4)$.

We next generalize the above evaluation to the higher-order contours $C_{i,j}$ appearing in $G_{i,j}$. Here, we make the assumption that in the large separation time limit between the pairs of points (x_1, x_2) and (x'_1, x'_2) the derivatives $\delta A_{i,j}/\delta x(\sigma)$ can be expanded around the driving term $\delta A_{1,1}/\delta x(\sigma)$ of the lowest order surface. Neglecting the higher-order terms of these expansions, one ends up with the common operators $\delta A_{1,1}/\delta x(\sigma)$ to all factors $G_{i,j}$, involving the segment x_1x_2 and the momentum operators $p_{a\mu}$, $a = 1, 2$. Those terms can then be factorized in front of G and interpreted as potentials.

The bound state equation obtained from Eq. (6.8) in the equal-time limit $x_L = 0$ is then:

$$\left[P_L - (h_{10} + h_{20}) - \gamma_{1L}\gamma_1^\mu A_{1\mu} - \gamma_{2L}\gamma_2^\mu A_{2\mu} \right] \psi(P_L, x^T) = 0, \quad (6.13)$$

where ψ is the wave function ϕ in the equal-time limit,

$$\psi(P_L, x^T) \equiv \phi(P_L, x_L = 0, x^T), \quad (6.14)$$

and the potentials are defined through the equations (in Minkowski space)

$$A_{1\mu} = \sigma \int_0^1 d\sigma' (1 - \sigma') \frac{\delta A_{1,1}}{\delta x^\mu(\sigma')}, \quad A_{2\mu} = \sigma \int_0^1 d\sigma' \sigma' \frac{\delta A_{1,1}}{\delta x^\mu(\sigma')}. \quad (6.15)$$

They can be calculated either by using the minkowskian version of Eq. (3.14) and then conditions (6.11)-(6.12), or by first writing Eqs. (6.8) and (6.13) in euclidean space, using

Eq. (3.14) and then passing to Minkowski space. (In euclidean space the right-hand sides of Eqs. (6.15) contain an additional $(-i)$ factor.) Since $\delta A_{1,1}/\delta x(\sigma')$ is orthogonal to x [Eq. (3.15)], the resulting vectors will satisfy this property. We define transverse vectors with respect to x with a superscript “ t ”:

$$q_\mu^t = q_\mu - x_\mu \frac{1}{x^2} x \cdot q. \quad (6.16)$$

However, x itself is orthogonal to the total momentum P in the equal-time limit ($x_L = 0$) and reduces to x^T . The part of the three-dimensional relative momentum p^T that is also orthogonal to x^T will be denoted p^{Tt} :

$$p_\mu^{Tt} = p_\mu^T - x_\mu^T \frac{1}{x^{T2}} x^T \cdot p^T. \quad (6.17)$$

This vector enters in the definition of the relative orbital angular momentum. Defining the corresponding Pauli-Lubanski vector W_L (L referring here to the orbital angular momentum) as

$$W_{L\mu} = \epsilon_{\mu\nu\alpha\beta} P^\nu x^\alpha p^\beta, \quad \epsilon_{0123} = +1, \quad (6.18)$$

one has the relations

$$W_L^2 = -P^2 \left(x^{T2} p^{T2} - x^{T\alpha} x^{T\beta} p_\alpha^T p_\beta^T - 2i x^T \cdot p^T \right) = -P^2 x^{T2} p^{Tt2}, \quad -\frac{W_L^2}{P^2} \Big|_{\text{c.m.}} = \mathbf{L}^2. \quad (6.19)$$

The expression of $A_{1\mu}$ is:

$$\begin{aligned} A_{1\mu} = & -\sigma \sqrt{-x^{T2}} \frac{E_1 E_2}{E_1 + E_2} \left\{ \left[g_{\mu L} (\epsilon(p_{2L}) - \epsilon(p_{1L})) \frac{E_1 E_2}{(E_1 + E_2)^2} \left(\frac{x^{T2} P^2}{2W_L^2} E_1 E_2 - 1 \right) \right. \right. \\ & \left. \left. - g_{\mu L} \epsilon(p_{1L}) \frac{E_1}{E_1 + E_2} + \frac{x^{T2} P^2}{2W_L^2} \frac{E_1 E_2}{E_1 + E_2} p_\mu^{Tt} \right] \right. \\ & \times \sqrt{\frac{-x^{T2} P^2}{-W_L^2}} \left(\arcsin \left(\frac{1}{E_2} \sqrt{\frac{-W_L^2}{-x^{T2} P^2}} \right) + \arcsin \left(\frac{1}{E_1} \sqrt{\frac{-W_L^2}{-x^{T2} P^2}} \right) \right) \\ & - \left[g_{\mu L} \epsilon(p_{1L}) + g_{\mu L} \frac{(E_2 - E_1)}{(E_2 + E_1)} (\epsilon(p_{2L}) - \epsilon(p_{1L})) - \frac{1}{E_2} p_\mu^{Tt} \right] \\ & \times \left(\frac{E_1 E_2}{E_1 + E_2} \right) \left(\frac{-x^{T2} P^2}{-W_L^2} \right) \left(\sqrt{1 - \frac{-W_L^2}{-x^{T2} P^2 E_2^2}} - \sqrt{1 - \frac{-W_L^2}{-x^{T2} P^2 E_1^2}} \right) \\ & - \frac{1}{2} \left[g_{\mu L} (\epsilon(p_{2L}) - \epsilon(p_{1L})) \frac{E_1 E_2}{E_1 + E_2} + p_\mu^{Tt} \right] \left(\frac{-x^{T2} P^2}{-W_L^2} \right) \\ & \times \left(\frac{E_1}{E_1 + E_2} \sqrt{1 - \frac{-W_L^2}{-x^{T2} P^2 E_2^2}} + \frac{E_2}{E_1 + E_2} \sqrt{1 - \frac{-W_L^2}{-x^{T2} P^2 E_1^2}} \right) \left. \right\}. \quad (6.20) \end{aligned}$$

Here, $\epsilon(p_{1L})$ and $\epsilon(p_{2L})$ are the energy sign operators of the free quark and the antiquark, respectively:

$$\epsilon(p_{aL}) = \frac{h_{a0}}{E_a}, \quad a = 1, 2, \quad (6.21)$$

h_{a0} and E_a being defined in Eqs. (6.7) and (6.12). The expression of $A_{2\mu}$ is obtained from that of $A_{1\mu}$ by an interchange in the latter of the indices 1 and 2 and a change of sign of p^{Tt} . In particular, the longitudinal parts of the potentials A_1 and A_2 add up in Eq. (6.13). One has for their sum the expression:

$$\begin{aligned}
A_{1L} + A_{2L} = & \sigma \sqrt{-x^{T2}} \frac{E_1 E_2}{E_1 + E_2} \left\{ \left(\frac{E_1}{E_1 + E_2} \epsilon(p_{1L}) + \frac{E_2}{E_1 + E_2} \epsilon(p_{2L}) \right) \right. \\
& \times \sqrt{\frac{-x^{T2} P^2}{-W_L^2}} \left(\arcsin \left(\frac{1}{E_2} \sqrt{\frac{-W_L^2}{-x^{T2} P^2}} \right) + \arcsin \left(\frac{1}{E_1} \sqrt{\frac{-W_L^2}{-x^{T2} P^2}} \right) \right) \\
& \left. + (\epsilon(p_{1L}) - \epsilon(p_{2L})) \left(\frac{E_1 E_2}{E_1 + E_2} \right) \left(\frac{-x^{T2} P^2}{-W_L^2} \right) \left(\sqrt{1 - \frac{-W_L^2}{-x^{T2} P^2 E_2^2}} - \sqrt{1 - \frac{-W_L^2}{-x^{T2} P^2 E_1^2}} \right) \right\}.
\end{aligned} \tag{6.22}$$

For sectors of quantum numbers where $W_L^2 = 0$, the expressions of the potentials become:

$$A_{1L} + A_{2L} = \frac{1}{2} (\epsilon(p_{1L}) + \epsilon(p_{2L})) \sigma \sqrt{-x^{T2}}, \tag{6.23}$$

$$\begin{aligned}
A_{1\mu}^{Tt} = & -\frac{1}{E_1 E_2} \left(\frac{1}{3} (E_1 + E_2) - \frac{1}{2} E_1 \right) p_\mu^{Tt} \sigma \sqrt{-x^{T2}}, \\
A_{2\mu}^{Tt} = & +\frac{1}{E_1 E_2} \left(\frac{1}{3} (E_1 + E_2) - \frac{1}{2} E_2 \right) p_\mu^{Tt} \sigma \sqrt{-x^{T2}}.
\end{aligned} \tag{6.24}$$

All expressions of the potentials have been written as classical functions of their arguments, without taking into account ordering problems. These necessitate a detailed study which will not be done here. We simply outline some general features that may be useful for the resolution of the wave equation. (i) Many ordering problems that concern linear momentum operators do not affect the energy eigenvalues and rather concern the definition of the kernel of the scalar product of the wave functions; one can pass from one definition to the other by appropriate changes of function. (ii) The square-root and arcsin functions which involve the variables x^{T2} and $1/E_a^2$ ($a = 1, 2$) could be treated in first approximation by replacing in E_a the radial momentum operator squared by its mean value in the bound state, or, if the resolution is done in momentum space by replacing x^{T2} by its mean value. (iii) A close study of the chiral properties of the wave equation suggests us to further adopt the following rules: the doubly transverse momentum operator p_μ^{Tt} , maintaining its definition of Eq. (6.17), and the energy sign operators $\epsilon(p_{aL})$ ($a = 1, 2$) should be placed on the utmost left.

Equation (6.13), together with expressions (6.20), is very similar to an equation proposed by Olsson *et al.* on the basis of a model where quarks are attached at the ends of a straight string or a color flux tube [34, 35]; the difference mainly concerns the energy sign operators; in Ref. [34] the equation which was proposed is the Salpeter equation

[30], in which generally the potential is proportional to a global energy projector; here, the energy sign operators, though they could be expressed through energy projectors, do not match exactly the projector of the Salpeter equation; the doubly transverse parts of the vector potentials do even not have energy sign operators. Apart from this slight difference, however, the physical significance of Eq. (6.13) is the same as that of Ref. [34]. The vector potentials $A_{a\mu}$ ($a = 1, 2$) can be interpreted as representing contributions of the energy-momentum vector of the straight color flux tube with variable length r ; its energy is represented by the sum $A_{1L} + A_{2L}$ [Eq. (6.22)], while its angular momentum contributes through the doubly transverse components A_a^{Tt} .

The norm of the wave function ψ can be obtained (after a few approximations) from Eq. (6.8). The details are presented in appendix B. The result is:

$$\int d^3x^T \text{tr} \psi^\dagger \frac{1}{2} \left(\frac{h_1}{E_1} + \frac{h_2}{E_2} \right) \psi = 2P_L N_c, \quad (6.25)$$

where h_a and E_a , $a = 1, 2$, are the free Dirac hamiltonian and energy of each particle, including now the self-energy contributions [cf. Sec. 7 and Eqs. (7.9)-(7.11)].

Finally, let us mention that Eq. (6.9) can be used to determine the relative time evolution of the wave function Φ [Eq. (6.2)]. Using in the right-hand side of Eq. (6.9) the same types of approximation as in Eq. (6.8), taking the large separation time limit between the pairs of points (x_1, x_2) and (x'_1, x'_2) and passing to the bound state wave function, one can integrate Eq. (6.9) for the latter obtaining the relative time dependence in the form of an ordered exponential function involving the various operators and potentials appearing in the equation, the initial condition being given by the function $\psi(P_L, x^T)$ [Eq. (6.14)]. We shall not need, however, that expression in the present work.

7 Quark self-energy

In general, there are functional relations between kernels of two-particle Green functions and self-energies of the constituent particles [36]. In conventional Green function equations (defined without phase factors), one easily factorizes the self-energy contributions and incorporates them into the external propagator contributions. Furthermore, self-energy parts can themselves be evaluated by means of Schwinger–Dyson equations. In the case of gauge invariant Green functions, however, the factorization of self-energy contributions becomes a hard task, since the path-ordered phase factors and the resulting Wilson loops maintain all interacting pieces into global entities. The presence of self-energies is, however, necessary for a consistent study of the properties of the system under given symmetries, transcribed usually into Ward–Takahashi identities. In the present case, the symmetry that is of interest is chiral symmetry. Also, when the dynam-

ical equations of confining interactions are expressed in momentum space, the presence of self-energy contributions becomes necessary to remove the infrared divergences from observable quantities [37].

When the interaction kernel of the bound state equation is represented by the mediation of an effective propagator, one expects to obtain the self-energy contribution by contracting the lines of the outgoing particles (assumed to be of the same type) through a single particle propagator and forming a loop with the kernel. In the present case, the interaction part of the bound state equation (6.13) can be visualized by multiplying it back by the factor $\gamma_{1L}\gamma_{2L}$. It has three different tensor parts: the first corresponds to vertices with the matrices $\gamma_{1L}\gamma_{2L}$; the second and third to vertices with matrices $\gamma_1^{Tt}\cdot p_1^{Tt}\gamma_{2L}$ and $\gamma_{1L}\gamma_2^{Tt}\cdot p_2^{Tt}$, respectively. When these terms are incorporated in a two-point loop and integrated in momentum space, the non-invariant pieces under spatial rotations disappear and what remains is simply the part of the interaction with the $\gamma_{1L}\gamma_{2L}$ matrices, inside which also the angular momentum operator has disappeared (cf. Eq. (6.23)). This corresponds to the situation where the interaction kernel is generated by the mediation of a Coulomb-gluon propagator, proportional in x -space to $\delta(x_L)\sqrt{-x^T{}^2}$.

The above result also coincides in form with that obtained in two-dimensional QCD. Here, in the large N_c limit, one has two different but equivalent ways of obtaining the bound state equation: either by working with the Schwinger–Dyson approach in the axial gauge, or by working with the Wilson loops with minimal surfaces [12]. (It is even easier to work in the light cone gauge [37], but the latter is less useful for our purpose here.) The Bethe–Salpeter equation with the one-gluon exchange kernel and the corresponding self-energies becomes an exact bound state equation and because of the instantaneity of the propagator, it yields the Salpeter equation [30]. The procedure developed in the present paper is also applicable to two-dimensional QCD. It is sufficient to remove from the results that were obtained the rotational motion part. In this case, the interaction potential reduces to the expression of Eq. (6.23) which is nothing but Salpeter’s kernel. What misses however in the bound state equation is the corresponding self-energy contributions. We shall now show that Eq. (6.8), which is at the origin of the bound state equation, also yields the quark self-energies.

Since the formal expressions of the self-energies are the same in both two and four dimensions in x -space, we shall directly work in two dimensions, by freezing the transverse variables with respect to x and considering the simplified case of a plane. A self-energy contribution for particle 1 will be recognized as depending only on the variables of that particle, not making reference to the variables of particle 2, except for the directions of the total momentum P of the bound state, which is chosen as the reference timelike direction, and of the relative coordinate $(x_2 - x_1)$. The simplest contribution to the self-energy of

particle 1 comes from the term $G_{2,1}$ in Eq. (6.8), a typical contour of which is shown in Fig. 3.a.

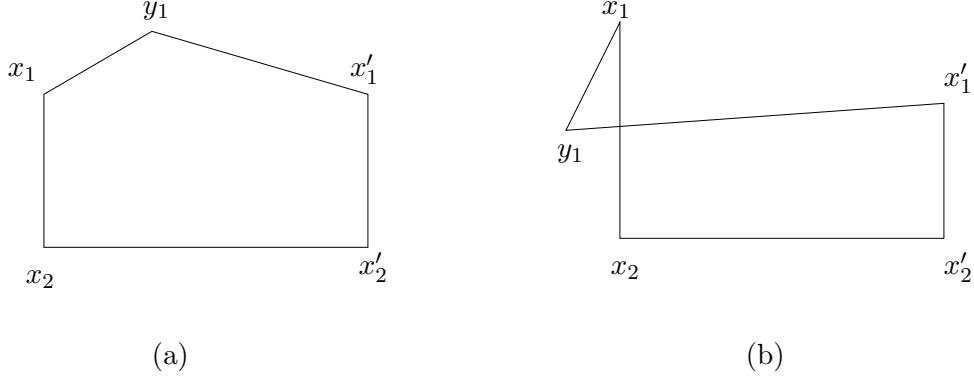

Figure 3: (a) A typical contour $C_{2,1}$ associated with the term $G_{2,1}$ of the two-particle propagator. (b) A configuration where the segments x_1x_2 and $y_1x'_1$ intersect.

The term that is relevant here is that in which the operator $\delta/\delta x(\sigma)$ (multiplying the γ_1 matrices) acts on the term $\delta A_{2,1}/\delta x(\tau)$ of $G_{2,1}$ [Eq. (5.6)]. One thus obtains the second-order functional derivative $\delta^2 A_{2,1}/\delta x^\mu(\sigma)\delta x^\alpha(\tau)$, where τ parametrizes the segment $y_1x'_1$ and σ the segment x_1x_2 . The expression of the second-order functional derivative of the minimal area has been given in Eq. (A.1), where now $x(\sigma', 0)$ and $x(\sigma, 0)$ have to be replaced by $x(\sigma)$ and $x(\tau)$, respectively. Since $x(\sigma)$ and $x(\tau)$ belong to different segments, the terms proportional to the explicit delta-functions can be dropped; furthermore, since the orthogonal variables to the surface have been frozen, also the last term of that equation can be ignored; it is only the second term of the right-hand side of the equation that may contribute:

$$\frac{\delta}{\delta x^\mu(\sigma)} \frac{\delta A_{2,1}}{\delta x^\alpha(\tau)} = F(x(\sigma) - x(\tau)) \times \left(\delta_{\lambda\alpha}(x_2 - x_1)^\nu - \delta_{\nu\alpha}(x_2 - x_1)^\lambda \right) \left(\delta_{\lambda\mu}(x'_1 - y_1)^\nu - \delta_{\nu\mu}(x'_1 - y_1)^\lambda \right), \quad (7.1)$$

where $x(\tau)$ and $x(\sigma)$ are parametrized as $x(\tau) = y_1 + \tau(x'_1 - y_1)$ and $x(\sigma) = x_1 + \sigma(x_2 - x_1)$. In the limit when the regulator a vanishes, the function F , Eq. (3.3), tends to a *two-dimensional* delta-function [Eq. (3.4)]; therefore, the above second-order derivative is nonvanishing only when the two segments are intersecting (Fig. 3.b); we then have to integrate with respect to σ and τ with the weight factors $(1-\sigma)$ and $(1-\tau)$ [Eqs. (5.6) and (6.8)]. The calculation can be done by replacing F by a two-dimensional delta-function involving σ and τ and the arguments of which can be obtained by first writing the explicit expression of $(x(\sigma) - x(\tau))^2$ with two-dimensional components x^0 and x^3 (in the bound

state rest frame) for instance:

$$\begin{aligned}
F(x(\sigma) - x(\tau)) &= \delta(x^0(\sigma) - x^0(\tau))\delta(x^3(\sigma) - x^3(\tau)) \\
&= \delta(z^0 + \sigma x^0 - \tau y^0)\delta(z^3 + \sigma x^3 - \tau y^3) \\
&= -\frac{1}{2x^3y^3}\delta(z^0 + \sigma x^0 - \tau y^0)\frac{\partial}{\partial\sigma}\frac{\partial}{\partial\tau}|z^3 + \sigma x^3 - \tau y^3|, \quad (7.2)
\end{aligned}$$

where we have defined $x = x_2 - x_1$, $z = x_1 - y_1$, $y = x'_1 - y_1$. Actually not the full expression of the above integral is needed, but rather that part which depends only on the points x_1 and y_1 , which correspond to the integration endpoints $\sigma = 0$ and $\tau = 0$. Integrating that expression by parts and retaining only the latter endpoints, one obtains:

$$\int_0^1 d\sigma d\tau (1 - \sigma)(1 - \tau)F(x(\sigma) - x(\tau)) = -\frac{1}{2x^3y^3}\delta(z^0)|z^3| + \dots, \quad (7.3)$$

where the dots stand for the remaining terms that do not contribute to the self-energy. The contribution of the integral of the second-order derivative of the area, Eq. (7.1), is then:

$$\begin{aligned}
\int_0^1 d\sigma d\tau (1 - \sigma)(1 - \tau)\frac{\delta}{\delta x^\mu(\sigma)}\frac{\delta A_{2,1}}{\delta x^\alpha(\tau)} &= -\delta_{\mu 0}\delta_{\alpha 0}\delta(z^0)|z^3| \\
&= -\delta_{\mu L}\delta_{\alpha L}\delta((x_{1L} - y_{1L})\sqrt{-(x_1^T - y_1^T)^2}), \quad (7.4)
\end{aligned}$$

where we have dropped additive terms not depending only on z and have done the tensor calculation in two dimensions and restored at the end the covariant expression.

The presence of the delta-function along the temporal direction means that the segments x_1x_2 and y_1x_1 are parallel, or more generally lie in an orthogonal plane to the time direction (Fig. 4).

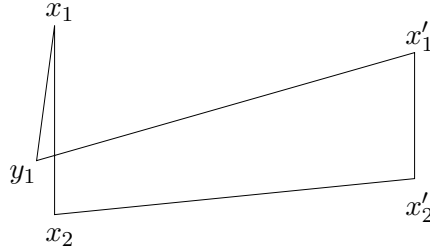

Figure 4: Configuration of the contour $C_{2,1}$ corresponding to the self-energy contribution.

In the limit $(x_{1L} - x'_{1L}) \rightarrow \infty$, the areas $A_{2,1}(x'_2x_2x_1y_1x'_1x'_2)$ and $A_{1,1}(x'_2x_2y_1x'_1x'_2)$ become almost equal and one may replace in $G_{2,1}$ the former by the latter. The expression (7.4), combined with the multiplicative free quark propagator $S_{10}(x_1y_1)$, then factorizes

$G_{1,1}$ and plays the role of a self-energy correction. In order to complete the derivation, one must repeat the same calculations with the higher-order terms $G_{i,j}$ ($i \geq 3, j \geq 1$), where in the second-order derivatives of the type of (7.1), the functional derivative $\delta/\delta x(\tau)$ corresponds to $\delta/\delta x(\tau_1)$ and acts on the second segment $y_1 y_2$ of the corresponding contour (Fig. 2). One thus finds the first-order self-energy correction (in the string tension σ) that factorizes the bound state wave function in Eq. (6.13); it corresponds to the effective exchange of a Coulomb-gluon, with propagator proportional in momentum space to $\delta_{\mu L} \delta_{\alpha L} 1/((-q^T)^2)^2$.

The higher-order self-energy corrections are obtained by extending the above procedure to terms that contain higher numbers of second-order derivatives of the areas $A_{i,j}$. The next correction is provided by the terms $G_{i,j}$ with $i \geq 4$ and containing two second-order derivatives of the area. Let us consider for definiteness the term $G_{4,1}$ corresponding to the contour $C_{4,1}$ (Fig. 5.a).

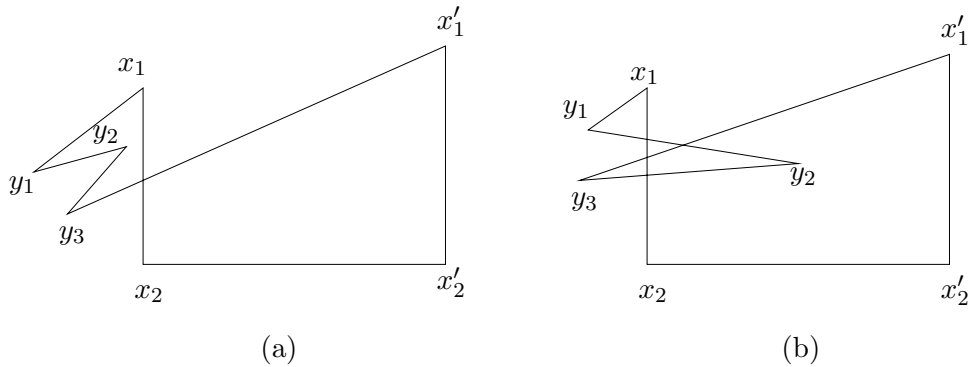

Figure 5: (a) A configuration of the contour $C_{4,1}$ corresponding to the second-order self-energy correction. (b) A configuration corresponding to overlapping integrals.

The self-energy contribution comes from the term containing the product $\frac{\delta^2 A_{4,1}}{\delta x(\sigma) \delta x(\tau_3)}$ $\frac{\delta^2 A_{4,1}}{\delta x(\tau_1) \delta x(\tau_2)}$, where $\delta/\delta x(\tau_1)$ acts on the segment $y_1 y_2$, $\delta/\delta x(\tau_2)$ on $y_2 y_3$ and $\delta/\delta x(\tau_3)$ on $y_3 x'_1$. The resulting delta-functions imply intersection of the segments $x_1 x_2$ and $y_3 x'_1$ and parallelism of the adjacent segments $y_1 y_2$ and $y_2 y_3$. The two delta-functions can be integrated as before in an independent way. The result is proportional to the product $\delta((x_{1L} - y_{3L}) \sqrt{-(x_1^T - y_3^T)^2}) \delta((y_{1L} - y_{2L}) \sqrt{-(y_1^T - y_2^T)^2})$. Notice that in the case of overlapping integrals, corresponding to the situation where two derivatives act on the segments $x_1 x_2$ and $y_2 y_3$ on the one hand and on the segments $y_1 y_2$ and $y_3 x'_1$ on the other, the delta-functions would imply intersections of the segments of each of the above pairs (Fig. 5.b); integrating the delta-function of the second pair as before yields the delta-function $\delta(y_{2L} - y_{3L})$, the implementation of which prevents the segments $x_1 x_2$ and $y_2 y_3$

from intersecting and the corresponding integral vanishes. Also notice that in the two-dimensional limit that we are considering here (freezing of orthogonal deformations of the areas) higher-order derivatives of the areas vanish, for they would involve derivatives of the function F outside its support.

The generalization to higher orders is now straightforward. Any high-order contribution will contain in the term $G_{i,j}$ a product of second-order derivatives of the area $A_{i,j}$, in which one of them is $\frac{\delta^2 A_{i,j}}{\delta x(\sigma)\delta x(\tau_k)}$ ($k \leq i-1$), where $\delta/\delta x(\tau_k)$ acts on the segment $y_k y_{k+1}$; the others are nonoverlapping (disjoint or nested) and act on segments lying between x_1 and y_{k+1} , being thus nested within $x_1 y_{k+1}$. The remaining part of the calculation repeats the steps used for the first-order correction.

One thus generates the whole series of self-energy corrections that can be summed into the Schwinger–Dyson integral equation, corresponding to a Coulomb instantaneous kernel $-\sigma\delta_{\mu L}\delta_{\nu L}\delta(x_L - y_L)\sqrt{-(x^T - y^T)^2}$.

Defining the momentum space Fourier transform of the function $\sqrt{-x^{T2}}$ through analytic continuation of the power parameter [38], one finds:

$$\int d^3x^T e^{ip^T \cdot x^T} \sqrt{-x^{T2}} = -\frac{8\pi}{(-p^{T2})^2}. \quad (7.5)$$

Denoting by $S(p_L, p^T, m)$ the quark propagator in momentum space with free mass m tied to the bound state of momentum P and defining the self-energy contribution through the equation

$$iS^{-1}(p_L, p^T, m) = \gamma \cdot p - m - \Sigma(p^T, m), \quad (7.6)$$

one has the Schwinger–Dyson equation:

$$\Sigma(p^T, m) = 8\pi\sigma\gamma_L \int \frac{d^4k}{(2\pi)^4} S(k_L, k^T, m) \frac{1}{(-p^T - k^T)^2} \gamma_L. \quad (7.7)$$

Because of the instantaneity of the kernel, the self-energy Σ actually depends only on the three-dimensional transverse momentum p^T . The tensor decomposition of Σ can be written in the form

$$\Sigma(p^T, m) = \gamma^T \cdot p^T A(-p^{T2}, m) + B(-p^{T2}, m). \quad (7.8)$$

The self-energies of the quark and of the antiquark have now to be incorporated in the Dirac energy operators in Eq. (6.13) and in the definitions of the energy sign operators (6.21). Defining

$$\begin{aligned} h_1(p_1^T, m_1) &= h_{10} + \gamma_{1L}\Sigma(p_1^T, m_1) = \gamma_{1L}(m_1 - \gamma_1^T \cdot p_1^T + \Sigma(p_1^T, m_1)) \\ &= \gamma_{1L}\left((m_1 + B_1) - \gamma_1^T \cdot p_1^T(1 - A_1)\right), \\ h_2(p_2^T, m_2) &= h_{20} - \gamma_{2L}\Sigma(-p_2^T, m_2) = -\gamma_{2L}(m_2 + \gamma_2^T \cdot p_2^T + \Sigma(-p_2^T, m_2)) \end{aligned}$$

$$= -\gamma_{2L}((m_2 + B_2) + \gamma_2^T \cdot p_2^T (1 - A_2)), \quad (7.9)$$

$$E_1(-p_1^{T2}, m_1) = \sqrt{h_1^2} = \sqrt{(m_1 + B_1)^2 - p_1^{T2}(1 - A_1)^2},$$

$$E_2(-p_2^{T2}, m_2) = \sqrt{h_2^2} = \sqrt{(m_2 + B_2)^2 - p_2^{T2}(1 - A_2)^2}, \quad (7.10)$$

$$\epsilon(p_{aL}) = \frac{h_a}{E_a}, \quad a = 1, 2, \quad (7.11)$$

equation (6.13) becomes

$$\left[P_L - (h_1 + h_2) - \gamma_{1L} \gamma_1^\mu A_{1\mu} - \gamma_{2L} \gamma_2^\mu A_{2\mu} \right] \psi(P_L, x^T) = 0, \quad (7.12)$$

where the potentials A are given by expressions (6.20) in which E_a and ϵ_a ($a = 1, 2$) are replaced by expressions (7.10) and (7.11), respectively; furthermore, the self-energy functions should also be incorporated in the appearances of the doubly transverse momentum p^{Tt} and the orbital angular momentum W_L . Since we have replaced p_1^{Tt} and p_2^{Tt} in favor of p^{Tt} , the corresponding substitutions may not seem straightforward. However, the difficulty is circumvented easily. Each energy factor E_a ($a = 1, 2$) that appears explicitly in the potentials is reminiscent of a term of the type p_a^{Tt}/E_a ; p_a^{Tt} undergoes the substitution $p_a^{Tt} \rightarrow (1 - A_a)p_a^{Tt}$, where A_a ($a = 1, 2$) is the self-energy function, Eqs. (7.9). It is then sufficient to replace each E_a in the potentials by $E_a/(1 - A_a)$, without modifying the momentum and orbital angular momentum operators.

The quark propagator is not a gauge invariant quantity and therefore could not lead to observable effects. This feature manifests itself through the self-energy equation (7.7), which, due to the infrared singularity of the integrand, provides an infrared divergent self-energy. On the other hand, physical observables should be free of infrared singularities. The treatment of infrared singularities in momentum space depends on the method of regularization that is adopted. Dimensional regularization, which has the advantage of preserving symmetry properties, and which we adopt throughout this work, gives zero for the abovementioned singularities, but has the disadvantage of hiding the distinction between unobservable and observable quantities. This is why it is necessary to check at every stage of calculations whether physical quantities are indeed free of infrared singularities by also using an explicit infrared cutoff method.

In the present approach, we have to check that the wave equation (7.12), which describes the physical properties of the bound states, is free of infrared singularities. To do this, we have to isolate the singularities coming from the self-energies. The properties of the latter will be studied in Sec. 8; here, we mention the most relevant ones for our purpose. Designating by V the linear confining potential, Eq. (8.3), it is found that the singularities of the self-energy parts are contained in the energy factors E_a [Eqs. (7.10)], while the ratios $(1 - A_a)/(m_a + B_a)$, $a = 1, 2$, are free of singularities; from the integral equations satisfied by E_a , Eq. (8.10), it is seen that their singularity is represented by

the three-dimensional integral in momentum space of $-V/2$. [Section 8 deals with the equal-mass case and mainly with the massless limit; however, the infrared singularity properties are not affected by the values of the quark masses and could be abstracted from the equations of that section.] Therefore, the combinations $(E_a + V/2)$ are free of infrared singularities. Coming back to the potentials $A_{a\mu}$ [Eqs. (6.20)] their large-distance behavior in x -space can be studied by expanding the various functions contained in their expressions in terms of $(1 - A_a)^2 \mathbf{L}^2 / (E_a^2 \mathbf{x}^2)$, $a = 1, 2$ (in the c.m. frame). Factorizing the function σr , the expansions are of the type $\sigma r(1 + O((1 - A_a)^2 \mathbf{L}^2 / (E_a^2 \mathbf{x}^2)))$; therefore the higher-order terms are nondominant at large distances and could not lead to infrared singularities. For the present study it is sufficient to keep the leading terms, which are represented by the expressions (6.23)-(6.24).

Considering first the contribution of $(A_{1L} + A_{2L})$ and replacing the energy sign operators by their expressions (7.11), we immediately find that the energy factors and the potential appear with the combinations $(E_a + V/2)$, which ensure the infrared finiteness of the result. Next, we consider the contributions of the spacelike potentials $A_{a\mu}^{Tt}$ [Eqs. (6.24), where each E_a should be replaced by $E_a/(1 - A_a)$]. The doubly transverse momentum operator p^{Tt} is equal in the c.m. frame to $\mathbf{p}^t = -\frac{1}{x^2} \mathbf{x} \times \mathbf{L}$. The effective potential that matters is proportional to $\sigma r \mathbf{p}^t = -\frac{\sigma}{r} \mathbf{x} \times \mathbf{L}$. The orbital angular momentum operator \mathbf{L} acts on spherical harmonics and does not modify the infrared properties of wave functions. The term \mathbf{x}/r has as Fourier transform a function proportional to \mathbf{p}/p^4 , which does not lead to infrared singularities, after the angular integrations in convolution integrals are done. Therefore, the wave equation (7.12) is free of infrared singularities. Explicit cases of the above cancellations can also be found in the equations presented in Sec. 8.

8 Chiral symmetry breaking

The presence of the self-energy contributions in the bound state equation (7.12) allows us to study the possibility of the spontaneous breakdown of chiral symmetry. This is intimately related to the existence of nonperturbative solutions to the Schwinger–Dyson equation in the chiral limit when the quark mass m tends to zero [39, 36].

Using decomposition (7.8) and considering the bound state rest frame, the integral in Eq. (7.7) can first be integrated with respect to the energy variable k_0 giving rise to two coupled equations:

$$B(p) = -\frac{1}{2} \int \frac{d^3k}{(2\pi)^3} V(\mathbf{p} - \mathbf{k}) \frac{(m + B(k))}{(k^2(1 - A(k))^2 + (m + B(k))^2)^{1/2}}, \quad (8.1)$$

$$\mathbf{p}A(k) = +\frac{1}{2} \int \frac{d^3k}{(2\pi)^3} V(\mathbf{p} - \mathbf{k}) \frac{\mathbf{k}(1 - A(k))}{(k^2(1 - A(k))^2 + (m + B(k))^2)^{1/2}}, \quad (8.2)$$

where we have defined the potential V as

$$V(\mathbf{p}) = -8\pi\sigma \frac{1}{p^4}, \quad p = |\mathbf{p}|, \quad V(\mathbf{x}) = \sigma r, \quad r = |\mathbf{x}|. \quad (8.3)$$

In the chiral limit $m = 0$ they become:

$$B(p) = -\frac{1}{2} \int \frac{d^3k}{(2\pi)^3} V(\mathbf{p} - \mathbf{k}) \frac{B(k)}{(k^2(1 - A(k))^2 + B(k)^2)^{1/2}}, \quad (8.4)$$

$$\mathbf{p}A(p) = +\frac{1}{2} \int \frac{d^3k}{(2\pi)^3} V(\mathbf{p} - \mathbf{k}) \frac{\mathbf{k}(1 - A(k))}{(k^2(1 - A(k))^2 + B(k)^2)^{1/2}}. \quad (8.5)$$

These equations were extensively studied in the literature; they result from the assumption that confinement is due to the exchange of Coulomb-gluons [40, 41, 42, 43, 44]. Using variational methods, it has been shown that the perturbative vacuum state is unstable under quark-antiquark pair creation. The existence of a new stable vacuum state is ensured by the existence of a nontrivial solution to Eqs. (8.4)-(8.5). We summarize below the main results that have been obtained and outline some salient features related to physical aspects of the problem.

Equations (8.4)-(8.5) are solved by decomposing the functions B and $p(1 - A)$ along polar combinations, by introducing an angle and a modulus:

$$B(p) = E(p) \sin \varphi(p), \quad p(1 - A(p)) = E(p) \cos \varphi(p). \quad (8.6)$$

Equations (8.4)-(8.5) can be rewritten in the form:

$$E(p) \sin \varphi(p) = -\frac{1}{2} \int \frac{d^3k}{(2\pi)^3} V(\mathbf{p} - \mathbf{k}) \sin \varphi(k), \quad (8.7)$$

$$E(p) \cos \varphi(p) = p - \frac{1}{2} \int \frac{d^3k}{(2\pi)^3} V(\mathbf{p} - \mathbf{k}) \hat{\mathbf{p}} \cdot \hat{\mathbf{k}} \cos \varphi(k), \quad \hat{\mathbf{p}} = \frac{\mathbf{p}}{p}, \quad \hat{\mathbf{k}} = \frac{\mathbf{k}}{k}. \quad (8.8)$$

The latter equations in turn can be recombined to decouple the function φ from E :

$$p \sin \varphi(p) = -\frac{1}{2} \int \frac{d^3k}{(2\pi)^3} V(\mathbf{p} - \mathbf{k}) \left[\sin \varphi(k) \cos \varphi(p) - \hat{\mathbf{p}} \cdot \hat{\mathbf{k}} \cos \varphi(k) \sin \varphi(p) \right], \quad (8.9)$$

$$E(p) = p \cos \varphi(p) - \frac{1}{2} \int \frac{d^3k}{(2\pi)^3} V(\mathbf{p} - \mathbf{k}) \left[\sin \varphi(k) \sin \varphi(p) + \hat{\mathbf{p}} \cdot \hat{\mathbf{k}} \cos \varphi(k) \cos \varphi(p) \right]. \quad (8.10)$$

From Eq. (8.9) one deduces that the function φ is an infrared finite quantity. From Eq. (8.10), after expanding in the integrand \mathbf{k} -dependent terms around \mathbf{p} , one deduces that E is infrared singular and its singularity is represented by the integral $-\frac{1}{2} \int d^3k V(k)/(2\pi)^3$, a property mentioned and utilized at the end of Sec. 7 for the checking of the infrared

finiteness of the wave equation (7.12). (We use, however, dimensional regularization for analytic calculations throughout this work.)

The function $\sin \varphi(p)$ will be identified later with the Goldstone boson wave function. Therefore, it should be a normalizable and presumably nodeless function. An analysis of the above equations shows that the function φ behaves at infinity as p^{-5} and tends at the origin to $\pi/2$. The solution that is found is indeed a monotonically decreasing function with the above properties. On the other hand, due to the infrared singularity of the potential V , the energy function E vanishes at some finite value p_0 of p and becomes negative for $p < p_0$; it tends to a finite negative value at the origin and behaves as p at infinity. The functions B and $p(1 - A)$ vanish simultaneously at p_0 ; they are negative for $p < p_0$, with the limiting values $B(0) = E(0)$ and $\lim_{p=0} p(1 - A) = 0$; asymptotically, B behaves as p^{-4} and A as p^{-2} .

An order parameter for chiral symmetry breaking is the quark condensate $\langle \bar{\psi}\psi \rangle$. For a given type of quark, say u , it can be defined as minus the trace (in color and Dirac spinor spaces) of the quark propagator at the origin in x -space:

$$\langle \bar{u}u \rangle = -\text{tr}_{\text{c,sp}} S(x) \Big|_{x=0} = -N_c \int \frac{d^4 p}{(2\pi)^4} \text{tr}_{\text{sp}} S(p). \quad (8.11)$$

Using definition (7.6) and decomposition (7.8), one finds:

$$\langle \bar{u}u \rangle = -2N_c \int \frac{d^3 p}{(2\pi)^3} \sin \varphi(p). \quad (8.12)$$

From Eq. (8.7) one also sees that the quark condensate enters in the asymptotic behavior of the mass term of the quark propagator in the chiral limit:

$$p \sin \varphi(p) \underset{p \rightarrow \infty}{\simeq} - \frac{2\pi\sigma \langle \bar{u}u \rangle}{N_c p^4}. \quad (8.13)$$

This relation is the analog of that obtained in perturbation theory from operator product expansion and the renormalization group analysis [45].

We next turn to the bound state equation (7.12). A consistent study of the chiral limit should be done starting from the situation where the quark masses are different from zero and then taking the limits $m_1 = m_2 = 0$. In the present case, we directly consider the equal mass case $m_1 = m_2 = m$, corresponding to the light quark sectors u and d without isospin breaking.

In general, the resolution of Eq. (7.12) proceeds by first decomposing the wave function ψ along a basis of 2×2 matrices spanned by the matrices γ_L and γ_5 . In the following, we consider the rest frame of the bound state ($\mathbf{P} = \mathbf{0}$). One has the decomposition

$$\psi = \psi_1 + \gamma_0 \psi_2 + \gamma_5 \psi_3 + \gamma_0 \gamma_5 \psi_4, \quad (8.14)$$

where the functions ψ_a , $a = 1, \dots, 4$ are themselves 2×2 matrices on which act the spin Pauli matrices $\boldsymbol{\sigma}$. The quantum numbers of the state are usually defined with respect to the components that survive in the nonrelativistic limit; these are ψ_3 and ψ_4 , which have the same quantum numbers. For the present problem, we are considering the sector characterized by the following quantum numbers: total spin $s = 0$, orbital angular momentum $\ell = 0$, total angular momentum $j = 0$. We adopt the rule of writing the energy sign operators present in the potentials [Eqs. (6.20) and (7.10)-(7.11)] as well as the factors $((1 - A)/E)\mathbf{p}^t$ on the utmost left. The doubly transverse momentum operator \mathbf{p}^t [Eq. (6.17)] annihilates S -states; it commutes with \mathbf{x}^2 and with all scalar operators that act on S -states in x -space. In the equal-mass case, the transverse potentials \mathbf{A}_1^t and \mathbf{A}_2^t are opposite to each other; defining

$$\mathbf{A}_2^t = \frac{(1 - A)}{E}\mathbf{p}^t\tilde{A} = -\mathbf{A}_1^t, \quad (8.15)$$

using definition (8.3), introducing the spin operators \mathbf{s}_1 and \mathbf{s}_2 of particles 1 and 2, and removing indices 1 and 2 from various factors which are equal, we obtain the following four equations:

$$P_0\psi_1 + 2(1 - A)(\mathbf{s}_1 - \mathbf{s}_2) \cdot \mathbf{p} \left(1 + \frac{1}{2E}V\right)\psi_3 = 0, \quad (8.16)$$

$$P_0\psi_2 = 0, \quad (8.17)$$

$$P_0\psi_3 - 2(m + B)\left(1 + \frac{1}{2E}V\right)\psi_4 + 2(1 - A)(\mathbf{s}_1 - \mathbf{s}_2) \cdot \mathbf{p} \left(1 + \frac{1}{2E}V\right)\psi_1 - 2\frac{(1 - A)}{E}(\mathbf{s}_1 - \mathbf{s}_2) \cdot \mathbf{p}^t\tilde{A}\psi_1 = 0, \quad (8.18)$$

$$P_0\psi_4 - 2(m + B)\left(1 + \frac{1}{2E}V\right)\psi_3 = 0. \quad (8.19)$$

We have neglected in Eq. (8.18) the internal \mathbf{L}^2 dependent parts, present in the potentials $(A_{1L} + A_{2L})$ and \mathbf{A}^t acting on ψ_1 , which is a P -state, and used the limits (6.23)-(6.24); these neglected parts do not seem to play a crucial role in the following calculations; with the decomposition (8.15), $\tilde{A} = \sigma r/6$.

From Eqs (8.16) and (8.19) one deduces the relation:

$$(m + B)\psi_1 + (1 - A)(\mathbf{s}_1 - \mathbf{s}_2) \cdot \mathbf{p}\psi_4 = 0. \quad (8.20)$$

This equation, which is valid in general for $m \neq 0$ and $P_0 \neq 0$, should also be satisfied in the limit $m \rightarrow 0$ and for $P_0 \rightarrow 0$, if the Goldstone boson properties are expected to vary smoothly under explicit chiral symmetry breaking. Then, the ground state solution of the above equations in the limit $m = 0$ with zero energy is:

$$\psi_1 = \psi_2 = \psi_4 = 0, \quad \psi_3 \neq 0, \quad (8.21)$$

with ψ_3 satisfying the equation

$$E(p)\psi_3(p) = -\frac{1}{2} \int \frac{d^3k}{(2\pi)^3} V(\mathbf{p} - \mathbf{k})\psi_3(k). \quad (8.22)$$

This equation is similar in form to Eq. (8.7), indicating that ψ_3 is proportional to the self-energy function $\sin \varphi$:

$$\psi_3(p) = C \sin \varphi(p), \quad (8.23)$$

with C a constant.

In order to calculate the pion decay constant F_π , one must again consider the case where $m \neq 0$. The pion decay constant is defined as:

$$\langle 0 | \bar{d}(0) \gamma_\mu \gamma_5 u(0) | \pi^+(P) \rangle = i\sqrt{2} F_\pi P_\mu. \quad (8.24)$$

This is related to the component ψ_4 :

$$\int \frac{d^3k}{(2\pi)^3} \psi_4(k) = \frac{\sqrt{2}}{4} F_\pi P_0. \quad (8.25)$$

The normalization condition (6.25) yields, after elimination of ψ_1 through Eq. (8.20) and replacement of ψ_3 by its expression (8.23):

$$8C \int \frac{d^3k}{(2\pi)^3} \psi_4(k) = 2P_0 N_c. \quad (8.26)$$

Using Eq. (8.25), one finds:

$$CF_\pi = \frac{N_c}{\sqrt{2}}. \quad (8.27)$$

This result is actually a consequence of the Ward-Takahashi identity relative to the Green function $\langle T \bar{u}(x) \gamma_\mu \gamma_5 d(x) i \bar{d}(0) \gamma_5 u(0) \rangle$, which implies (in the chiral limit) the equation $\sqrt{2} F_\pi \langle 0 | i \bar{d}(0) \gamma_5 u(0) | \pi^+ \rangle = 2 \langle \bar{u} u \rangle$; this is equivalent to the relation

$$\int \frac{d^3k}{(2\pi)^3} \psi_3(k) = -\frac{\langle \bar{u} u \rangle}{2\sqrt{2} F_\pi}. \quad (8.28)$$

Using Eq. (8.12), one obtains Eq. (8.27).

The normalization condition (8.26) can also be analyzed by using Eq. (8.19). Integrating that equation with respect to \mathbf{p} and expanding in the second term all quantities with respect to m to first-order in m and then using the integral equations satisfied by the first-order self-energy functions, one ends up with the relation

$$\int \frac{d^3k}{(2\pi)^3} \psi_4 = \frac{2m}{P_0} \int \frac{d^3k}{(2\pi)^3} \psi_3, \quad (8.29)$$

which is equivalent to the well-known relation of Gell-Mann, Oakes and Renner [46]: $m_\pi^2 F_\pi^2 = -2m \langle \bar{u}u \rangle$.

In order to be able to calculate F_π , one needs to know the function ψ_4 . This information comes from Eq. (8.18). Eliminating ψ_1 through Eq. (8.20) and noticing that ψ_4 itself is proportional to P_0 , one can take in all factors multiplying ψ_4 the chiral limit. Defining

$$\psi_4 \equiv P_0 \tilde{\psi}_4 \equiv P_0 \frac{1}{2} g \psi_3, \quad (8.30)$$

the function $g(p)$ then satisfies the integral equation

$$\begin{aligned} E(p)g(p) &= \sin \varphi(p) \\ &- \frac{1}{2} \int \frac{d^3 k}{(2\pi)^3} V(\mathbf{p} - \mathbf{k}) \left[\sin \varphi(k) \sin \varphi(p) + \hat{\mathbf{p}} \cdot \hat{\mathbf{k}} \cos \varphi(k) \cos \varphi(p) \right] g(k) \\ &+ \frac{1}{3p} \cos \varphi(p) \int \frac{d^3 k}{(2\pi)^3} V(\mathbf{p} - \mathbf{k}) (\mathbf{p} - \mathbf{k}) \cdot \hat{\mathbf{k}} \cos \varphi(k) g(k). \end{aligned} \quad (8.31)$$

Except for the last term, which comes from the contribution of the rotational motion of the flux tube, this equation is the same as a corresponding one derived in Refs. [40, 42]. The infrared singular part of E cancels the singular part of the first integral and the function g appears as infrared finite. This is also seen more explicitly by using Eqs. (8.9)-(8.10); after a few algebraic manipulations one can cast Eq. (8.31) into the form [42]

$$\begin{aligned} pg(p) \cos \varphi(p) &= \sin \varphi(p) \\ &+ \frac{1}{2} \int \frac{d^3 k}{(2\pi)^3} V(\mathbf{p} - \mathbf{k}) \left[\sin \varphi(k) \sin \varphi(p) + \hat{\mathbf{p}} \cdot \hat{\mathbf{k}} \cos \varphi(k) \cos \varphi(p) \right] (g(p) - g(k)) \\ &+ \frac{1}{3p} \cos \varphi(p) \int \frac{d^3 k}{(2\pi)^3} V(\mathbf{p} - \mathbf{k}) (\mathbf{p} - \mathbf{k}) \cdot \hat{\mathbf{k}} \cos \varphi(k) g(k). \end{aligned} \quad (8.32)$$

which is free of infrared singularities. The function g has the same asymptotic behavior as $\sin \varphi$ and turns out to be nodeless. Integrating this equation with respect to \mathbf{p} yields the relation

$$\begin{aligned} \int \frac{d^3 k}{(2\pi)^3} k g(k) \cos \varphi(k) &= \int \frac{d^3 k}{(2\pi)^3} \sin \varphi(k) \\ &+ \int \frac{d^3 p}{(2\pi)^3} \frac{1}{3p} \cos \varphi(p) \int \frac{d^3 k}{(2\pi)^3} V(\mathbf{p} - \mathbf{k}) (\mathbf{p} - \mathbf{k}) \cdot \hat{\mathbf{k}} \cos \varphi(k) g(k), \end{aligned} \quad (8.33)$$

which can be considered as a consistency check for various approximations and numerical calculations. The resolution of Eqs. (8.31) or (8.32) provides the function g and hence ψ_4 .

A rough evaluation of the orders of magnitude of the quark condensate and of the pion decay constant can be done using analytic approximations. Taking into account the

properties of the function φ at infinity and near the origin and its nodeless character, the following approximations can be used inside the integrals:

$$\sin \varphi(k) \simeq \frac{1}{(1 + k^2/(b\sigma))^{5/2}}, \quad \cos \varphi(k) \simeq \frac{k}{\sqrt{b\sigma}} \left\{ \frac{1}{(1 + k^2/(b\sigma))^{1/2}} + \frac{\sqrt{5} - 1}{(1 + k^2/(b\sigma))^{5/2}} \right\}, \quad (8.34)$$

where b is a constant to be determined. For the numerical applications we use $\sigma = 0.18 \text{ GeV}^2$, $\sqrt{\sigma} = 424 \text{ MeV}$. With these approximations, the integrals in Eqs. (8.7)-(8.8) can be evaluated analytically (with dimensional regularization) yielding hypergeometric functions. The parameter b is then determined by the requirement that the left-hand sides have the same zero. We find $b = 0.31$. The evaluation of the integral in Eq. (8.12) (with approximation (8.34) and $N_c = 3$) gives $\langle \bar{u}u \rangle = -(115 \text{ MeV})^3$, in agreement with the results found in Refs. [42, 44], $\langle \bar{u}u \rangle \simeq -(100 \text{ MeV})^3$.

Since the function g has similar asymptotic properties as $\sin \varphi$, we approximate it as:

$$g(p) \simeq \frac{\gamma}{\sqrt{b\sigma}} \sin \varphi(p), \quad (8.35)$$

where γ is a constant; it is determined from Eq. (8.33). At a first stage we neglect the last integral; we find $\gamma = 0.52$. Equations (8.26), (8.27) and (8.30) then give $F_\pi = 16 \text{ MeV}$, with the same order of magnitude as the results found in Refs. [42, 44], $F_\pi \simeq 11 \text{ MeV}$. Consideration of the last integral in Eq. (8.33) increases the value of γ by an amount of 16% and brings F_π to 18 MeV; it does not therefore change its order of magnitude. The experimental value of F_π is nearly 93 MeV. The quark condensate $\langle \bar{u}u \rangle$ is not a directly measurable quantity; QCD sum rules [47] give the prediction $\langle \bar{u}u \rangle \simeq -(225 \text{ MeV})^3$ at the scale of 1 GeV.

In Ref. [41], numerical calculations have been done with the harmonic oscillator potential, which makes it difficult to compare predictions. In Refs. [40, 43], rather large values of F_π and $\langle \bar{u}u \rangle$ are presented, but these are obtained by fitting parameters in order to fix the value of the constituent quark mass at 300 MeV, corresponding to big values of the string tension (or of its equivalents).

The relative smallness (about one order of magnitude) of the theoretical predictions for $\langle \bar{u}u \rangle$ and F_π found here and in Refs. [42, 44] seems to indicate that short-distance forces should have sizable contributions in these quantities; this is corroborated by the facts that, first, they act in momentum space with a potential having the same sign as the confining one, and second, they induce much slower asymptotic behavior to the function φ . A definite conclusion about the quantitative aspects of chiral symmetry breaking could be reached only when both kinds of forces, long-range and short-range, are considered.

9 Properties of the bound state spectrum

We turn in this section to a study of the main qualitative properties of the bound state spectrum that emerge from the wave equation, leaving to a separate work a more quantitative study of it, in particular when short-distance effects are incorporated.

9.1 One-particle limit

We begin with the case when one of the particles becomes infinitely massive; this is achieved by taking one of the masses, m_2 , say, to infinity. Defining $P_0 = m_2 + p_{10}$, $\mathbf{x} = \mathbf{x}_1 - \mathbf{x}_2$, $\mathbf{p} = (\mathbf{p}_1 - \mathbf{p}_2)/2 = \mathbf{p}_1$, the wave equation (7.12) reduces to a Dirac type equation for the quark in the presence of a vector static potential:

$$\left[p_{10} - h_1 - A_0 + \gamma_{10} \boldsymbol{\gamma} \cdot \mathbf{A} \right] \psi = 0, \quad (9.1)$$

where the potentials, in the classical limit, are:

$$A_0 = \sigma r \left\{ \sqrt{\frac{E_1^2 \mathbf{x}^2}{\mathbf{L}^2}} \arcsin \sqrt{\frac{\mathbf{L}^2}{E_1^2 \mathbf{x}^2}} - (1 - \epsilon(p_{10})) \frac{E_1^2 \mathbf{x}^2}{\mathbf{L}^2} \left(1 - \sqrt{1 - \frac{\mathbf{L}^2}{E_1^2 \mathbf{x}^2}} \right) \right\}, \quad (9.2)$$

$$\mathbf{A} = \frac{\sigma r}{2} \left(\frac{\mathbf{p}^t}{E_1} \right) \frac{E_1^2 \mathbf{x}^2}{\mathbf{L}^2} \left\{ \sqrt{\frac{E_1^2 \mathbf{x}^2}{\mathbf{L}^2}} \arcsin \sqrt{\frac{\mathbf{L}^2}{E_1^2 \mathbf{x}^2}} - \sqrt{1 - \frac{\mathbf{L}^2}{E_1^2 \mathbf{x}^2}} \right\}. \quad (9.3)$$

[$r = |\mathbf{x}|$, \mathbf{p}^t is defined in Eq. (6.17), \mathbf{L} is the orbital angular momentum operator, h_1 , E_1 and $\epsilon(p_{10})$ are defined in Eqs. (7.9)-(7.11).] They represent the energy-momentum of a straight segment of length r with linear energy density σ turning around the point x_2 (the position of the heavy antiquark).

Taking further the limit of a heavy quark, the potentials become to order $1/c^2$:

$$A_0 = \sigma r \left(1 + \frac{\mathbf{L}^2}{6m_1^2 \mathbf{x}^2} \right), \quad \mathbf{A} = \frac{\sigma r}{3} \frac{\mathbf{p}^t}{m_1}. \quad (9.4)$$

9.2 Nonrelativistic limit

Next, we consider the case of two heavy quarks. The potential $A_{1\mu}$ [Eq. (6.20)] becomes (in the c.m. frame) to order $1/c^2$:

$$A_{10} = \sigma r \left[\frac{1}{2} + \frac{1}{6} \left(\frac{m_1}{m_1 + m_2} \right) \left(\frac{1}{m_1^2} + \frac{1}{m_2^2} - \frac{1}{m_1 m_2} \right) \frac{\mathbf{L}^2}{\mathbf{x}^2} + \frac{1}{8} \left(\frac{m_1 m_2}{m_1 + m_2} \right)^2 \left(\frac{1}{m_1^4} - \frac{1}{m_2^4} \right) \frac{\mathbf{L}^2}{\mathbf{x}^2} \right], \quad (9.5)$$

$$\mathbf{A}_1 = -\frac{\sigma r}{2} \mathbf{P}^t \left(\frac{2}{3m_1} - \frac{1}{3m_2} \right), \quad (9.6)$$

the definitions of x and p being the same as in Eqs. (6.3). A_2 is obtained from A_1 by exchange of indices 1 and 2 and replacement of \mathbf{p} by $-\mathbf{p}$. The self-energy Σ [Eqs. (7.8), (8.1)-(8.2)] behaves for large m as:

$$\Sigma(\mathbf{p}, m) = -\frac{2\sigma}{\pi m} + O(1/m^2). \quad (9.7)$$

After having subtracted the masses and made a few changes of function to reach an explicitly hermitian form, the nonrelativistic hamiltonian, to order $1/c^2$ takes the following form (in the c.m. frame):

$$\begin{aligned} H = & \frac{\mathbf{p}^2}{2\mu} + \sigma r - \frac{2\hbar\sigma}{\pi} \left(\frac{1}{m_1} + \frac{1}{m_2} \right) - \frac{1}{8} \left(\frac{1}{m_1^3} + \frac{1}{m_2^3} \right) (\mathbf{p}^2)^2 + \frac{\hbar^2}{4} \left(\frac{1}{m_1^2} + \frac{1}{m_2^2} \right) \frac{\sigma}{r} \\ & - \frac{\sigma}{6r} \left(\frac{1}{m_1^2} + \frac{1}{m_2^2} - \frac{1}{m_1 m_2} \right) (\mathbf{L}^2 + 2\hbar^2) + \frac{\sigma}{2r} \left(\frac{\mathbf{L} \cdot \mathbf{s}_1}{m_1^2} + \frac{\mathbf{L} \cdot \mathbf{s}_2}{m_2^2} \right) \\ & - \frac{2\sigma}{3r} \left(\frac{1}{m_1^2} - \frac{1}{2m_1 m_2} \right) \mathbf{L} \cdot \mathbf{s}_1 - \frac{2\sigma}{3r} \left(\frac{1}{m_2^2} - \frac{1}{2m_1 m_2} \right) \mathbf{L} \cdot \mathbf{s}_2. \end{aligned} \quad (9.8)$$

[$\mu = m_1 m_2 / (m_1 + m_2)$, \mathbf{s}_1 and \mathbf{s}_2 are the spin operators of the quark and of the antiquark.] Several remarks can be made at this stage. First, the hamiltonian is independent of spin-spin interactions; this is already evident from the wave equation (7.12) where no direct interactions involving the spacelike γ -matrices of both quarks exist. The absence of long-range spin-spin interactions is compatible with experimental data. Second, we notice the presence of purely orbital angular momentum dependent pieces (proportional to \mathbf{L}^2), the origin of which is related to the contribution to the rotational motion of the system of the moment of inertia of the flux tube, represented by the straight segment joining the quark to the antiquark. The corresponding centrifugal energy produces a global plus sign in front of those terms; the minus sign results from the additional contributions of the momentum of the flux tube, which also couples, through the spacelike potentials \mathbf{A}_1 and \mathbf{A}_2 to the quarks [Eq. (9.6)]. Those terms were also obtained in Refs. [18] and [34, 35]. Third, we have two kinds of spin-orbit term. The first, appearing after the term in \mathbf{L}^2 , comes from the contribution of a conventional timelike vector interaction represented by the potential σr , which is the dominant part of the combination $A_{10} + A_{20}$ [Eq. (9.5)]. The second type of contribution, provided by the last two terms of Eq. (9.8), comes from the contributions of the direct interactions of the momentum of the flux tube with the quarks, represented by the spacelike potentials \mathbf{A}_1 and \mathbf{A}_2 [Eq. (9.6)]. The latter terms induce negative signs to the spin-orbit couplings, in opposite direction to the former one, a feature which is also observed on phenomenological grounds for the large-distance effects in fine splitting.

Adopting the notations of Ref. [16] for the potentials corresponding to spin-orbit (V_1 and V_2) and to spin-spin interactions (V_3 and V_4), we have:

$$V_1 = -\frac{2}{3}\sigma r, \quad V_2 = +\frac{1}{3}\sigma r, \quad V_3 = 0, \quad V_4 = 0. \quad (9.9)$$

Designating by V the nonrelativistic confining potential [Eq. (8.3)], the potentials V , V_1 and V_2 satisfy the Gromes relation [17]

$$V + V_1 - V_2 = 0, \quad (9.10)$$

which is a consequence of Lorentz covariance.

The expressions of potentials V_1 and V_2 do not satisfy, however, Buchmüller's conjecture about the spin-orbit terms [48], according to which confinement is due to a pure color electric field in the *co-moving frame* of the two quarks, thus reducing the spin-orbit potential to a Thomas precession term and entailing $V_1 = -\sigma r$ and $V_2 = 0$. Leaving aside the question of a phenomenological determination of these potentials, we notice that lattice calculations [49, 50], which favor the negative sign of V_1 , do not, however, clearly distinguish between the two possibilities above, due to the existing uncertainties. In order to clarify the structure of the spin-orbit potentials, it is necessary to investigate the contributions of higher-order terms not taken into account in the potentials (6.20) (of the type of those considered for the extraction of the self-energy terms). Another independent check consists in calculating the field correlators appearing in the nonrelativistic expansion of Ref. [16].

Reviews about bound state problems of quarks can be found in Refs. [51] and [52].

9.3 Regge trajectories

Finally, we consider the high energy behavior of the mass spectrum for ultrarelativistic systems. It has been known for a long time that the linear confining potential of the static case produces in the ultrarelativistic limit of massless quarks, through the Salpeter equation, linear Regge trajectories. The inclusion of a flux tube, represented by a straight string, modifies the relationship of the angular momentum with the total mass of the system and increases the slope α' of the Regge trajectories by an amount of 15-20%, enforcing the classical relation $\alpha' = (2\pi\sigma)^{-1}$ with the string tension σ [53, 35].

We have checked these properties on Eq. (7.12), by solving it in an approximate way that preserves its main qualitative features. The approximation that we use is the Breit approximation [29], which consists in transforming the wave equation into a local equation in x -space. The main lines of the approximation are presented in appendix C. The resulting Regge trajectories for the π and ρ families are presented in Fig. 6, where for comparison we have also presented the trajectories of the linear confining potential corresponding to the situation where $A_{10} + A_{20} = \sigma r$ and $\mathbf{A}_1 = \mathbf{A}_2 = \mathbf{0}$ in Eq. (7.12). One verifies, first, the linearity of the trajectories and, second, the increase of the slopes when the flux tube is present. Similar trajectories and behaviors are also obtained with the a_0 and a_1 families.

There are uncertainties of a few percent in our results coming from the way of calculating the mean values of operators present in the flux tube functions, depending on whether one evaluates them on the full function ψ or only on the basic component ψ_3 [Eq. (8.14)] and whether one uses for the latter a free norm or the norm relative to the Pauli–Schrödinger equation that it satisfies.

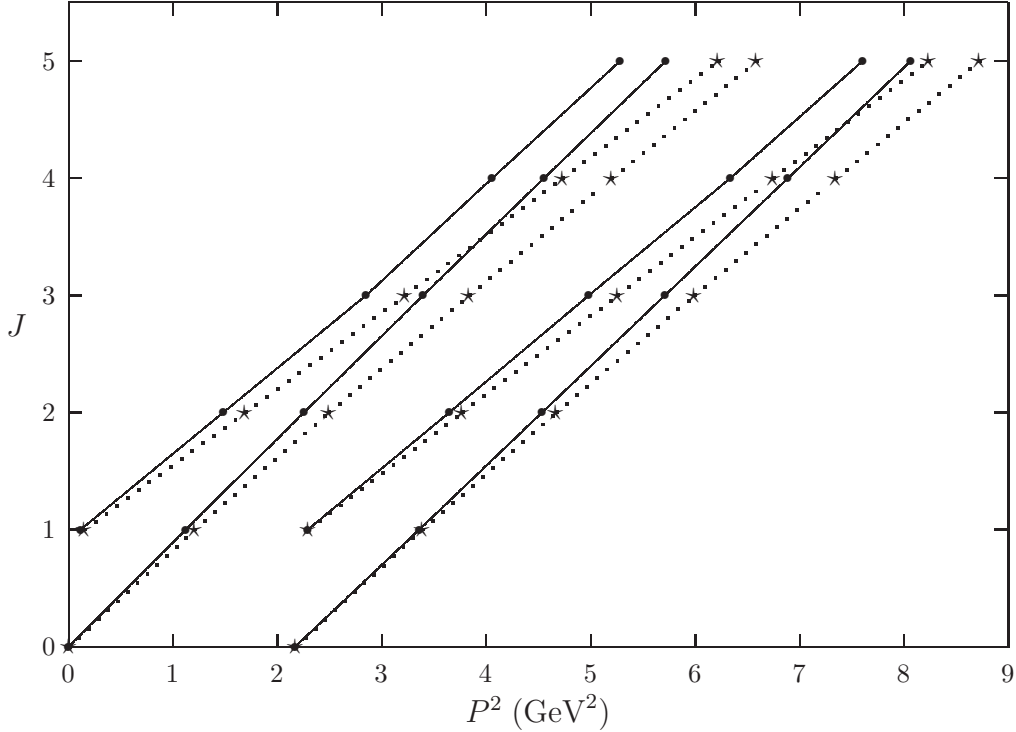

Figure 6: Regge trajectories of the π and ρ families and their first daughter trajectories. Full lines correspond to the flux tube potential, dotted lines to the linear potential. Inputs: $m_1 = m_2 = 0$, $\sigma = 0.18 \text{ GeV}^2$.

On phenomenological grounds, one actually determines the value of the string tension σ from the experimental Regge trajectories using the string theory relation $\alpha' = (2\pi\sigma)^{-1}$. From the slope of the π -family trajectory one obtains $\sigma = 0.22 \text{ GeV}^2$, while from the ρ -family trajectory one obtains $\sigma = 0.18 \text{ GeV}^2$ [52]. A precise comparison of our results with those data necessitates a more elaborate resolution of the wave equation and presumably the inclusion of the short-distance potentials.

10 Summary and concluding remarks

We have investigated, in the large N_c limit, the large-distance dynamics of QCD within the quarkonium system through the saturation of Wilson loop averages by minimal surfaces. The dynamics is described by a wave equation of the Breit–Salpeter type, in which the interaction potentials are provided by the energy-momentum vector of the straight segment joining the quark to the antiquark and carrying a constant linear energy density, equal to the string tension; the latter represents the effective contribution of the color flux tube of the quarkonium system. In the static case, confinement is realized by the usual linear potential, while in the general case of moving quarks additional contributions come from the moments of inertia of the straight segment .

Taking into account the self-energy parts of the quark propagators, it was shown that chiral symmetry is spontaneously broken with a mechanism identical to that of the exchange of one Coulomb-gluon.

In the nonrelativistic limit, long range spin-spin potentials are absent, while the moments of inertia of the flux tube bring contributions to the orbital angular momentum and spin-orbit potentials with negative signs, in opposite direction, for the latter case, to the spin-orbit term of the pure timelike vector potential.

In the ultrarelativistic limit, the mass spectrum displays linear Regge trajectories, the slopes of which tend to satisfy the classical relation with the string tension obtained in straight string theories.

The potentials that have been isolated in the present work do not represent the complete interaction kernel of the wave equation, but only the large-distance dominant contributions to it. The determination of the higher-order terms necessitates further study. Also, mathematical assumptions made for neglecting certain terms or approximating others in the large separation time limit need to be analyzed in more detail.

The formalism that has been developed here, centering the Wilson loop representation on minimal surfaces, ignores the contributions of short-distance effects provided by perturbation theory. A complete resolution of QCD requires the presence of both large- and short-distance effects. A corresponding resolution of the loop equations is far from being trivial, although approximate solutions might still provide a practical framework for a quantitative investigation of the spectroscopic properties of the theory.

Acknowledgements

We thank J. Stern for stimulating discussions. The numerical calculation of the mass spectrum used a program based on the inverse iterative method provided to us by J.-L. Ballot to whom we are grateful. This work was supported in part by the European Community network EURIDICE under Contract No. HPRN-CT-2002-00311.

A Properties of minimal surfaces

An important quantity in loop dynamics is the second-order functional derivative of the area at two different points on the contour. For definiteness we consider the two points on the line $\tau = 0$ (line $x_1 x_2$ of the contour C of Fig. 1). For a minimal surface, the variations of the contour maintain at all stages the minimality property of the area; therefore the second term of the right-hand side of Eq. (3.7) and all its variations are null and can be ignored. The second-order functional derivative of the area is then:

$$\begin{aligned}
\frac{\delta}{\delta x^\beta(\sigma', 0)} \frac{\delta A}{\delta x^\alpha(\sigma, 0)} &= (\delta_{\mu\alpha} \delta_{\nu\beta} - \delta_{\mu\beta} \delta_{\nu\alpha}) \frac{\partial}{\partial \sigma} \delta(\sigma - \sigma') \int d\sigma^{\mu\nu}(y) F(y - x(\sigma, 0)) \\
&+ (\delta_{\mu\alpha} x'^{\nu}(\sigma, 0) - \delta_{\nu\alpha} x'^{\mu}(\sigma, 0)) (\delta_{\mu\beta} x'^{\nu}(\sigma', 0) - \delta_{\nu\beta} x'^{\mu}(\sigma', 0)) F(x(\sigma, 0) - x(\sigma', 0)) \\
&+ (\delta_{\mu\alpha} x'^{\nu}(\sigma, 0) - \delta_{\nu\alpha} x'^{\mu}(\sigma, 0)) \delta(\sigma - \sigma') \frac{\partial}{\partial x^\beta(\sigma, 0)} \int d\sigma^{\mu\nu}(y) F(y - x(\sigma, 0)) \\
&- (\delta_{\mu\alpha} x'^{\nu}(\sigma, 0) - \delta_{\nu\alpha} x'^{\mu}(\sigma, 0)) \int d\sigma'' d\tau'' \frac{\delta y^\lambda(\sigma'', \tau'')}{\delta x^\beta(\sigma', 0)} \\
&\times \left[(y'^\gamma \dot{y}^\nu - y'^\nu \dot{y}^\gamma) \delta_{\mu\lambda} + (y'^\mu \dot{y}^\gamma - y'^\gamma \dot{y}^\mu) \delta_{\nu\lambda} + (y'^\nu \dot{y}^\mu - y'^\mu \dot{y}^\nu) \delta_{\gamma\lambda} \right] \frac{\partial}{\partial y^\gamma} F(y - x(\sigma, 0)).
\end{aligned} \tag{A.1}$$

The evaluation of the the last integral can be done by expanding $\delta y^\lambda / \delta x^\beta(\sigma', 0)$ about the point $x(\sigma, 0)$ that appears in F :

$$\frac{\delta y^\lambda(\sigma'', \tau'')}{\delta x^\beta(\sigma', 0)} = \frac{\delta y^\lambda(\sigma, 0)}{\delta x^\beta(\sigma', 0)} + (\sigma'' - \sigma) \frac{\partial}{\partial \sigma} \frac{\delta y^\lambda(\sigma, 0)}{\delta x^\beta(\sigma', 0)} + \tau'' \frac{\partial}{\partial \tau} \frac{\delta y^\lambda(\sigma, \tau)}{\delta x^\beta(\sigma', 0)} \Big|_{\tau=0} + \dots, \tag{A.2}$$

where the dots stand for terms that do not contribute in the limit $a = 0$. One notices that the first term in the right-hand side of Eq. (A.2) is a derivative that lies on the contour and hence is equal to $\delta_{\mu\nu} \delta(\sigma - \sigma')$:

$$\frac{\delta y^\lambda(\sigma, 0)}{\delta x^\beta(\sigma', 0)} \equiv \frac{\delta x^\lambda(\sigma, 0)}{\delta x^\beta(\sigma', 0)} = \delta_{\beta\lambda} \delta(\sigma - \sigma'). \tag{A.3}$$

It is also convenient, to complete the calculations, to stick to the following diagonal constant metric:

$$x' \cdot \dot{x} = 0, \quad x'^2 = \text{const.}, \quad \dot{x}^2 = \text{const.}, \quad \lambda \equiv \sqrt{\frac{x'^2}{\dot{x}^2}}. \tag{A.4}$$

The result is:

$$\begin{aligned}
\frac{\delta}{\delta x^\beta(\sigma', 0)} \frac{\delta A}{\delta x^\alpha(\sigma, 0)} &= 2 \frac{\partial}{\partial \sigma} \delta(\sigma - \sigma') \int d\sigma^{\alpha\beta}(y) F(y - x(\sigma, 0)) \\
&+ 2 (\delta_{\alpha\beta} x'(\sigma, 0) \cdot x'(\sigma', 0) - x'^\beta(\sigma, 0) x'^\alpha(\sigma', 0)) F(x(\sigma, 0) - x(\sigma', 0))
\end{aligned}$$

$$\begin{aligned}
& -\delta(\sigma - \sigma') \frac{1}{a} \sqrt{x'^2} \left(\delta_{\alpha\beta} - \frac{x'^\alpha x'^\beta}{x'^2} \right) \\
& - \sqrt{\frac{x'^2}{\dot{x}^2}} \frac{\partial}{\partial \tau} \frac{\delta y^\lambda(\sigma, \tau)}{\delta x^\beta(\sigma', 0)} \Big|_{\tau=0} \left(\delta_{\lambda\alpha} - \frac{x'^\lambda(\sigma, 0) x'^\alpha(\sigma, 0)}{x'^2(\sigma, 0)} - \frac{\dot{x}^\lambda(\sigma, 0) \dot{x}^\alpha(\sigma, 0)}{\dot{x}^2(\sigma, 0)} \right). \quad (\text{A.5})
\end{aligned}$$

The two points $x(\sigma, 0)$ and $x(\sigma', 0)$ lying on the boundary, the function $F(x(\sigma, 0) - x(\sigma', 0))$ is equivalent, in the limit $a = 0$, to $\frac{1}{2a\sqrt{x'^2}}\delta(\sigma - \sigma')$ and thus cancels the singular term of the third line. (We assume here that the line under consideration does not have self-intersections neither displays backtracking.) There remains to evaluate the quantity $\frac{\partial}{\partial \tau} \frac{\delta y^\lambda(\sigma, \tau)}{\delta x^\beta(\sigma', 0)} \Big|_{\tau=0}$. This in turn requires a more detailed knowledge of the derivative $\frac{\delta y^\lambda(\sigma, \tau)}{\delta x^\beta(\sigma', 0)}$. That quantity does not have a compact expression for general contours. Studies of its main properties can be found in Refs. [31] and [26]. In the formulation that we present below, we follow partly the covariant approach adopted in Ref. [26] and put emphasis on the aspects that will be needed in the present work.

Let us first point out the fact that a variation δx on the contour that lies in the tangent plane to the minimal surface does not modify the internal part of the minimal surface but only adds to it a new small piece on its boundary within the tangent plane; the variation thus amounts to a simple extension of the boundary on the same surface. In that case δy should lie in the tangent plane to the minimal surface at y , being a linear combination of y' and \dot{y} and corresponding to a reparametrization of the surface. In this respect, it can be checked that if δy^λ contains terms proportional to y'^λ or to \dot{y}^λ then the contributions of these in Eq. (A.1) are identically zero. Therefore, the nontrivial contributions to Eq. (A.1) come only from the transverse variations of δy with respect to the surface, which are themselves due to transverse variations δx on the contour with respect to that surface. We shall therefore concentrate on these kinds of variation.

To proceed further and to exhibit some general features, we shall use for a while covariant notations. The parameters of the surface will be denoted ξ^a , $a = 1, 2$, and the metric g_{ab} :

$$g_{ab} = \frac{\partial x^\mu}{\partial \xi^a} \frac{\partial x^\mu}{\partial \xi^b}, \quad a, b = 1, 2. \quad (\text{A.6})$$

The entries of the inverse of g are denoted g^{ab} and raising and lowering of indices are done with these tensors. The determinant of g is denoted $|g|$. We shall not meet below singular quantities and therefore, as long as not needed, we shall not use regulated expressions. The area is then $A = \int d^2\xi |g|^{1/2}$ and the equation of the minimal surface is:

$$|g|^{-1/2} \partial_a \left(|g|^{1/2} g^{ab} \partial_b y^\mu(\xi) \right) = 0. \quad (\text{A.7})$$

The determinant $|g|$ remains constant on the minimal surface.

Next, we introduce variations δy on the minimal surface, including the boundaries. The equation of the new minimal surface is obtained by replacing in Eq. (A.7) y by $y + \delta y$.

The linearized equation in δy is:

$$\Delta_{\mu\nu}\delta y^\nu \equiv |g|^{-1/2}\partial_a \left(|g|^{1/2}M_{\mu\nu}^{ab}\partial_b\delta y^\nu(\xi) \right) = 0, \quad (\text{A.8})$$

where one has defined

$$M_{\mu\nu}^{ab} = \delta_{\mu\nu}g^{ab} + \partial^a y_\mu \partial^b y_\nu - \partial^a y_\nu \partial^b y_\mu - g^{ab}\partial_c y_\nu \partial^c y_\mu. \quad (\text{A.9})$$

The operator $\Delta_{\mu\nu}$ is transverse: it annihilates any tangential variation $\delta y^\nu = \omega^c \partial_c y^\nu$:

$$\Delta_{\mu\nu}\omega^c \partial_c y^\nu = 0. \quad (\text{A.10})$$

One next introduces the Green function of the operator $\Delta_{\mu\nu}$ subject to the boundary condition that it vanishes along the contour C :

$$\begin{aligned} \Delta_{\mu\nu}(\xi)G_{\nu\rho}(\xi, \eta) &= |g|^{-1/2}(\delta_{\mu\rho} - Q_{\mu\rho}(\xi))\delta^2(\xi - \eta), \\ G_{\nu\rho}(\xi, \eta)\Big|_{\xi \in C} &= G_{\nu\rho}(\xi, \eta)\Big|_{\eta \in C} = 0, \end{aligned} \quad (\text{A.11})$$

where $Q_{\mu\rho}(\xi)$ is the projector on the tangent plane of the initial minimal surface at $y(\xi)$:

$$Q_{\mu\rho}(\xi) = \partial_a y_\mu(\xi)g^{ab}\partial_b y_\rho(\xi). \quad (\text{A.12})$$

Using then the Green identity, the symmetry property $M_{\mu\nu}^{ab} = M_{\nu\mu}^{ba}$, the Stokes theorem and the transversality of δy , one obtains for the transverse variations δy the following successive expressions:

$$\begin{aligned} \delta y_\mu(\eta) &= \int d^2\xi |g|^{1/2} \left[\delta y_\rho(\xi)\Delta_{\rho\nu}(\xi)G_{\nu\mu}(\xi, \eta) - (\Delta_{\rho\nu}(\xi)\delta y_\nu(\xi))G_{\rho\mu}(\xi, \eta) \right] \\ &= \int d^2\xi \partial_a \left[\delta y_\rho(\xi)|g|^{1/2}M_{\rho\nu}^{ab}(\xi)\partial_b G_{\nu\rho}(\xi, \eta) - |g|^{1/2}M_{\rho\nu}^{ab}(\xi)\partial_b \delta y_\nu(\xi)G_{\rho\mu}(\xi, \eta) \right] \\ &= - \oint_C d\xi^c \epsilon_{ca} |g|^{1/2} g^{ab} \delta y_\nu(\xi) \partial_b G_{\nu\mu}(\xi, \eta) \\ &= \oint_C d\lambda n^a(\lambda) \delta y_\nu(\xi(\lambda)) \partial_a G_{\nu\mu}(\xi(\lambda), \eta), \end{aligned} \quad (\text{A.13})$$

where the contour C has been parametrized with the parameter λ and where n is an orthogonal vector to the contour in the tangent plane to the minimal surface,

$$n^a(\lambda) = g^{ab}|g|^{1/2}\epsilon_{bc}\frac{d\xi^c(\lambda)}{d\lambda}. \quad (\text{A.14})$$

The functional derivative of $y_\mu(\eta)$ with respect to $x_\nu(\xi(\lambda'))$ then becomes:

$$\frac{\delta y_\mu(\eta)}{\delta x_\nu(\xi(\lambda'))} = n^a(\lambda')\partial_a G_{\nu\mu}(\xi, \eta)\Big|_{\xi=\xi(\lambda')}. \quad (\text{A.15})$$

Finally, the derivative of $\frac{\delta y_\mu}{\delta x_\nu}$ along n is:

$$n^b(\lambda)\partial_{(\eta)b}\frac{\delta y_\mu(\eta)}{\delta x_\nu(\xi(\lambda'))}\Big|_{\eta=\eta(\lambda)} = n^b(\lambda)n^a(\lambda')\partial_{(\eta)b}\partial_{(\xi)a}G_{\nu\mu}(\xi, \eta)\Big|_{\xi=\xi(\lambda'), \eta=\eta(\lambda)}. \quad (\text{A.16})$$

A consequence of Eq. (A.16) is the symmetry property of its right-hand side with respect to the variables ξ and η for $\lambda \neq \lambda'$, a feature that is not evident in the left-hand side. That property is intimately related to the symmetry property of the second-order variation of the minimal surface with respect to the order of operations. To exhibit this feature more explicitly we return to the (σ, τ) parametrization that we were using above. The derivation $n^a\partial_a$ is equivalent in the limit $\tau = 0$ to the derivation $-\sqrt{\frac{x'^2}{\dot{x}^2}}\frac{\partial}{\partial\tau}$. Equation (A.15) becomes, using the metric (A.4):

$$\frac{\delta y^\lambda(\sigma, \tau)}{\delta x^\beta(\sigma', 0)} = -\sqrt{\frac{x'^2}{\dot{x}^2}}\frac{\partial}{\partial\tau'}G_{\beta\lambda}(\sigma', \tau'; \sigma, \tau)\Big|_{\tau'=0}, \quad (\text{A.17})$$

which in turn yields for Eq. (A.5) the expression

$$\begin{aligned} \frac{\delta}{\delta x^\beta(\sigma', 0)}\frac{\delta A}{\delta x^\alpha(\sigma, 0)} &= 2\frac{\partial}{\partial\sigma}\delta(\sigma - \sigma')\int d\sigma^{\alpha\beta}(y)F(y - x(\sigma, 0)) \\ &+ \frac{x'^2}{\dot{x}^2}\frac{\partial}{\partial\tau}\frac{\partial}{\partial\tau'}G_{\beta\lambda}(\sigma', \tau'; \sigma, \tau)\Big|_{\tau'=0, \tau=0}\left(\delta_{\lambda\alpha} - \frac{x'^\lambda(\sigma, 0)x'^\alpha(\sigma, 0)}{x'^2} - \frac{\dot{x}^\lambda(\sigma, 0)\dot{x}^\alpha(\sigma, 0)}{\dot{x}^2}\right). \end{aligned} \quad (\text{A.18})$$

The symmetry property of the second-order derivative of the minimal area can now be discussed for the case $\sigma \neq \sigma'$. The Green function can be decomposed along symmetric Lorentz tensors each multiplied with a scalar function. Because of the boundary conditions (A.11) the two derivatives $\frac{\partial}{\partial\tau}$ and $\frac{\partial}{\partial\tau'}$ must simultaneously act on at least one of the scalar functions in order not to yield zero. In that case the product of the transverse projector present in the last term of Eq. (A.18) with the tensor factors of $G_{\beta\lambda}$ gives a symmetric result, which ensures the commutativity of the two functional derivatives when acting at two different points of the contour. That symmetry property is evident when the functional derivatives act on the Wilson loop average; then the two operators manifestly commute. This study will be completed below by also including the case of coinciding points.

Concrete calculations can be done when the Green function is specified more explicitly. To this aim, one can try to construct the Green function by means of an iterative procedure with respect to powers and derivatives of the curvature of the minimal surface:

$$G_{\beta\lambda}(\xi, \eta) = \sum_{i=0}^{\infty} G_{\beta\lambda}^{(i)}(\xi, \eta), \quad (\text{A.19})$$

where the index i is related to the power or the order of the derivative of the curvature. The lowest-order term of this iteration would correspond to the case of a plane with zero

curvature. The solution to that problem can be explicitly constructed. Using the metric (A.4), one can use the *ansatz*

$$\begin{aligned}
G_{\beta\lambda}^{(0)}(\sigma', \tau'; \sigma, \tau) = & \left\{ \delta_{\beta\lambda}(z'.y'.\dot{z}.\dot{y} - z'.\dot{y}\dot{z}.y') \right. \\
& - \dot{z}.\dot{y}(z'_\lambda y'_\beta - z'_\beta y'_\lambda) + z'.\dot{y}(\dot{z}_\lambda y'_\beta - \dot{z}_\beta y'_\lambda) \\
& \left. - z'.y'(\dot{z}_\lambda \dot{y}_\beta - \dot{z}_\beta \dot{y}_\lambda) + \dot{z}.y'(z'_\lambda \dot{y}_\beta - z'_\beta \dot{y}_\lambda) \right\} \frac{1}{y'^2 \dot{y}^2} h^{(0)}(\sigma', \tau'; \sigma, \tau),
\end{aligned} \tag{A.20}$$

where we have defined $z \equiv x(\sigma', \tau')$, $y \equiv x(\sigma, \tau)$ and kept in the decomposition of $G_{\beta\lambda}^{(0)}$ tangential components in order to satisfy at the end the boundary condition (A.3). The function $h^{(0)}$ is assumed to satisfy the inhomogeneous Laplace equation

$$\Delta_{(\xi)} h^{(0)}(\xi; \eta) = \Delta_{(\eta)} h^{(0)}(\xi; \eta) = \delta^2(\xi - \eta), \quad \xi = (\sigma', \tau'), \quad \eta = (\sigma, \tau), \tag{A.21}$$

$$\Delta_{(\eta)} = \frac{1}{\lambda} \frac{\partial^2}{\partial \sigma^2} + \lambda \frac{\partial^2}{\partial \tau^2}, \tag{A.22}$$

and the boundary conditions

$$h(\xi, \eta) \Big|_{\xi \in C} = h(\xi, \eta) \Big|_{\eta \in C} = 0. \tag{A.23}$$

The coordinates z and y represent points on the background minimal surface and with parametrization (A.4) satisfy the Laplace equations

$$\Delta_{(\xi)} z_\mu(\xi) = 0, \quad \Delta_{(\eta)} y_\mu(\eta) = 0. \tag{A.24}$$

Inserting $G_{\beta\lambda}^{(0)}$ in Eqs. (A.11) one can reconstruct $G_{\beta\lambda}^{(1)}$ by appropriately decomposing it along Lorentz tensors as in Eq. (A.20) and determining its Lorentz scalar parts through inhomogeneous Laplace equations involving as inhomogeneous terms $h^{(0)}$ and its first-order derivatives. It should be noticed that the inhomogeneous part of Eqs. (A.11) is already saturated by the function $G_{\beta\lambda}^{(0)}$ (the factor $|g|^{-1/2}$ being absorbed in the definition of the Laplace operator (A.22)) and therefore the higher-order functions do no longer have contributions to the delta-functions. The Lorentz tensor parts of the function $G_{\beta\lambda}^{(1)}$ contain at least one second-order derivative of y or z and therefore are of first-order in the curvature of the surface. The procedure can be continued to higher orders; the function $G_{\beta\lambda}^{(2)}$ will be quadratic in the second-order derivatives of y and z , or will contain third-order derivatives, and so forth. On technical grounds, it is advantageous to use also a tensor notation for the parameters of the surface and to simultaneously decompose the higher-order functions along tensors (defined essentially by the derivative operators) in parameter space. We shall not develop here the above procedure, for we shall not need in the present paper the explicit expressions of the functions $G_{\beta\lambda}^{(i)}$ ($i \geq 1$). In many instances, the sole

knowledge of the function $G_{\mu\nu}^{(0)}$ is sufficient to obtain or to check the main properties of the system under study. This is in particular the case where the background minimal surface from which deformations are calculated is itself a plane.

Let us now concentrate on the function $G_{\mu\nu}^{(0)}$. We consider a four-sided contour C as in Fig. 1 with the additional restriction that the four sides correspond to the lines of equations $\tau = 0$, $\sigma = 0$, $\tau = 1$, $\sigma = 1$. The explicit expression of the function $h^{(0)}$, satisfying the boundary conditions (A.23) is then:

$$h^{(0)}(\sigma', \tau'; \sigma, \tau) = -\frac{4}{\pi^2} \sum_{n,m=1}^{\infty} \frac{\sin(n\pi\sigma') \sin(n\pi\sigma) \sin(m\pi\tau') \sin(m\pi\tau)}{(m^2\lambda + n^2/\lambda)}. \quad (\text{A.25})$$

Calculating, in view of Eq. (A.17), the derivative of $h^{(0)}$ with respect to τ' at $\tau' = 0$, one obtains a series in m that can be summed into a hyperbolic function:

$$f^{(0)}(\sigma', 0; \sigma, \tau) \equiv -\lambda \left. \frac{\partial h^{(0)}}{\partial \tau'} \right|_{\tau'=0} = 2 \sum_{n=1}^{\infty} \frac{\sin(n\pi\sigma') \sin(n\pi\sigma) \sinh(n\pi(1-\tau)/\lambda)}{\sinh(n\pi/\lambda)}. \quad (\text{A.26})$$

One checks that $\frac{\delta y^\lambda}{\delta x^\beta}$ satisfies, with $G_{\beta\lambda}^{(0)}$ and through Eq. (A.17), the boundary condition (A.3).

We next evaluate the derivative of $\frac{\delta y^\lambda}{\delta x^\beta}$ with respect to τ at $\tau = 0$. The derivative acts on $f^{(0)}$ and on the Lorentz tensor part of $\frac{\delta y^\lambda}{\delta x^\beta}$. The latter action yields in Eq. (A.18) the finite part of $x'^\nu \frac{\partial}{\partial x^\beta} \int d\sigma^{\alpha\nu}(y) F(y - x(\sigma, 0))$ multiplied by $\delta(\sigma - \sigma')$ coming from the restriction of $f^{(0)}$ on the contour. One finds for the second-order functional derivative of the area the result:

$$\begin{aligned} \frac{\delta}{\delta x^\beta(\sigma', 0)} \frac{\delta A}{\delta x^\alpha(\sigma, 0)} &= 2 \frac{\partial}{\partial \sigma} \delta(\sigma - \sigma') \int d\sigma^{\alpha\beta}(u) F(u - y) \\ &+ 2\delta(\sigma - \sigma') y'^\nu \frac{\partial}{\partial y^\beta} \int d\sigma^{\alpha\nu}(u) F(u - y) \Big|_{\text{fp}} \\ &- \sqrt{\frac{y'^2}{\dot{y}^2}} \left\{ \delta_{\beta\alpha} (z' \cdot y' \dot{z} \cdot \dot{y} - z' \cdot \dot{y} \dot{z} \cdot y') \right. \\ &\left. - (\dot{z} \cdot \dot{y} z'_\alpha y'_\beta + z' \cdot y' \dot{z}_\alpha \dot{y}_\beta - z' \cdot \dot{y} \dot{z}_\alpha y'_\beta - \dot{z} \cdot y' z'_\alpha \dot{y}_\beta) \right\} \frac{1}{y'^2 \dot{y}^2} \left. \frac{\partial f^{(0)}(\sigma', 0; \sigma, \tau)}{\partial \tau} \right|_{\tau=0}, \end{aligned} \quad (\text{A.27})$$

where $y \equiv x(\sigma, 0)$, $z \equiv x(\sigma', 0)$ and the subscript ‘‘fp’’ means finite part. The last term of Eq. (A.27) is invariant under the change of the order of derivations, as can be seen from the tensor terms and with the use of the defining equations (A.25)-(A.26) of $f^{(0)}$, reflecting the general property emphasized after Eq. (A.18). The symmetry property of the contact terms will be established shortly.

The singular part of $\left. \frac{\partial f^{(0)}(\sigma', 0; \sigma, \tau)}{\partial \tau} \right|_{\tau=0}$ when $(\sigma - \sigma')$ approaches zero can be calculated from Eq. (A.26). It is:

$$\left. \frac{\partial f^{(0)}(\sigma', 0; \sigma, \tau)}{\partial \tau} \right|_{\tau=0} \underset{(\sigma - \sigma') \rightarrow 0}{=} \frac{1}{\pi} \sqrt{\frac{\dot{x}^2}{x'^2}} (\sigma - \sigma')^{-2} + O((\sigma - \sigma')^0). \quad (\text{A.28})$$

It yields for the contracted second-order derivative $\frac{\delta^2 A}{\delta x^\alpha(\sigma', 0) \delta x^\alpha(\sigma, 0)}$, in which the contact terms do not contribute, the behavior

$$\frac{\delta^2 A}{\delta x^\alpha(\sigma', 0) \delta x^\alpha(\sigma, 0)} \underset{(\sigma - \sigma') \rightarrow 0}{=} -\frac{2}{\pi} (\sigma - \sigma')^{-2} + O((\sigma - \sigma')^0). \quad (\text{A.29})$$

It is in agreement with the leading part of the short-distance behavior obtained in Ref. [26]. The contracted second-order derivative contains also a logarithmic singularity [26] which is obtained in the present approach by considering the contributions of the next two nonleading terms in the curvature, i.e., the functions $G_{\mu\nu}^{(i)}$, $i = 1, 2$ [Eq. (A.19)].

We now check the symmetry property between two successive functional derivatives. Let us first consider the problem in the Wilson loop case. The commutator of two functional derivatives on the contour is, using Eqs. (2.3) and (2.10):

$$\begin{aligned} & \left(\frac{\delta}{\delta x^\beta(\sigma')} \frac{\delta}{\delta x^\alpha(\sigma)} - \frac{\delta}{\delta x^\alpha(\sigma)} \frac{\delta}{\delta x^\beta(\sigma')} \right) W(C) = \\ & ig \frac{\partial}{\partial \sigma} \delta(\sigma - \sigma') \langle F_{\beta\alpha}(x(\sigma)) \rangle_W - ig \frac{\partial}{\partial \sigma'} \delta(\sigma - \sigma') \langle F_{\alpha\beta}(x(\sigma')) \rangle_W \\ & + ig \delta(\sigma - \sigma') x^{\nu}(\sigma) \langle (\nabla_\beta F_{\nu\alpha}(x(\sigma)) - \nabla_\alpha F_{\nu\beta}(x(\sigma))) \rangle_W. \end{aligned} \quad (\text{A.30})$$

Expanding in $F_{\alpha\beta}(x(\sigma'))$ σ' about σ and using in the last expression the Bianchi identity one finds:

$$\begin{aligned} & \left(\frac{\delta}{\delta x^\beta(\sigma')} \frac{\delta}{\delta x^\alpha(\sigma)} - \frac{\delta}{\delta x^\alpha(\sigma)} \frac{\delta}{\delta x^\beta(\sigma')} \right) W(C) \\ & = ig \left[\left(\frac{\partial}{\partial \sigma'} \delta(\sigma' - \sigma) \right) (\sigma' - \sigma) + \delta(\sigma' - \sigma) \right] \frac{\partial}{\partial \sigma} \langle F_{\beta\alpha}(x(\sigma)) \rangle_W \\ & = ig \frac{\partial}{\partial \sigma'} \left(\delta(\sigma' - \sigma) (\sigma' - \sigma) \right) \frac{\partial}{\partial \sigma} \langle F_{\beta\alpha}(x(\sigma)) \rangle_W \\ & = 0. \end{aligned} \quad (\text{A.31})$$

When the Wilson loop average is saturated by the minimal surface [Eq. (2.15)] the left-hand side of Eq. (A.30) becomes proportional to the commutator of the functional derivatives applied on the minimal area. Using Eq. (A.27), one obtains:

$$\begin{aligned} & \frac{1}{2} \left(\frac{\delta}{\delta x^\beta(\sigma', 0)} \frac{\delta}{\delta x^\alpha(\sigma, 0)} - \frac{\delta}{\delta x^\alpha(\sigma, 0)} \frac{\delta}{\delta x^\beta(\sigma', 0)} \right) A(C) = \\ & \frac{\partial}{\partial \sigma} \delta(\sigma' - \sigma) \int d\sigma^{\alpha\beta}(y) F(y - x(\sigma, 0)) - \frac{\partial}{\partial \sigma'} \delta(\sigma' - \sigma) \int d\sigma^{\beta\alpha}(y) F(y - x(\sigma', 0)) \end{aligned}$$

$$\begin{aligned}
& +\delta(\sigma - \sigma')x'^{\nu}(\sigma, 0) \left[\frac{\partial}{\partial x^{\beta}(\sigma, 0)} \int d\sigma^{\alpha\nu}(y)F(y - x(\sigma, 0)) \right. \\
& \left. - \frac{\partial}{\partial x^{\alpha}(\sigma, 0)} \int d\sigma^{\beta\nu}(y)F(y - x(\sigma, 0)) \right] \Big|_{\text{fp}}.
\end{aligned} \tag{A.32}$$

The right-hand side has the same structure as that of Eq. (A.30) and since the minimal surface satisfies the Bianchi identity (3.10) the same operations as above lead to the result

$$\left(\frac{\delta}{\delta x^{\beta}(\sigma', 0)} \frac{\delta}{\delta x^{\alpha}(\sigma, 0)} - \frac{\delta}{\delta x^{\alpha}(\sigma, 0)} \frac{\delta}{\delta x^{\beta}(\sigma', 0)} \right) A(C) = 0. \tag{A.33}$$

[Actually, it is the finite part of the quantity $\frac{\partial}{\partial x^{\beta}(\sigma, 0)} \int d\sigma^{\alpha\nu}(y)F(y - x(\sigma, 0))$ that is relevant for the nontrivial content of the Bianchi identity, the singular part satisfying the Bianchi identity as an identity, independent of the type of the surface.]

The diagonal constant metric (A.4) can also be used for the study of the forms of minimal surfaces in simple cases. In that metric the equation of the minimal surface is given by the Laplace equation (A.24). Choosing a plane as a reference surface, the orthogonal deformations of the surface with respect to the plane can be represented with functions of the type (A.26), while the parallel deformations should be constructed according to the orthonormality conditions (A.4). However, the sole knowledge of the orthogonal deformations is sufficient to have a rough idea of the form of the surface. We apply this study to one particular case of interest.

Let us consider the case where the contour C of Fig 1 has been restricted in the following way: the line $x_1x'_1x'_2x_2$ represents now the three sides of a rectangle (lying in a plane) while the line x_2x_1 , denoted C_{21} , is arbitrary but lying in an orthogonal plane to the rectangle and having in it the equation $u(\sigma, 0) = a(\sigma)$ (Fig. 7).

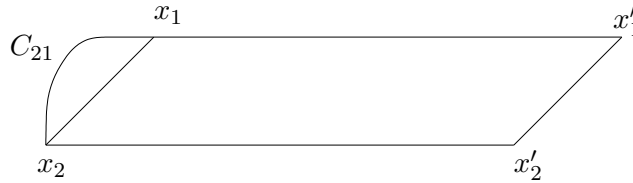

Figure 7: Contour C made of the three sides $x_1x'_1x'_2x_2$ of a rectangle and of the arbitrary line C_{21} lying in an orthogonal plane to the rectangle.

Designating by $u(\sigma, \tau)$ the orthogonal deformation of the minimal surface with respect to the plane, its expression can be obtained from Eq. (A.26) by using the Fourier decomposition of the function $a(\sigma)$: $a(\sigma) = \sum_{n=1}^{\infty} a_n \sin(n\pi\sigma)$. One obtains:

$$u(\sigma, \tau) = \sum_{n=1}^{\infty} a_n \frac{\sin(n\pi\sigma) \sinh(n\pi(1 - \tau)/\lambda)}{\sinh(n\pi/\lambda)}. \tag{A.34}$$

In general this minimal surface does not have a simple form; u is different from zero all over the rectangle, but is mainly peaked in the region $\tau \simeq 0$. Let us next take the limit $\dot{x}^2 \rightarrow \infty$, or $\lambda \rightarrow 0$. Then u goes to zero for any $\tau \neq 0$. Therefore, in that limit, the minimal surface shrinks to the surface made of the union of the rectangle $x_1 x'_1 x'_2 x_2 x_1$ and of the minimal surface bounded by the straight segment $x_2 x_1$ and the line C_{21} . Taking the time interval T proportional to $\sqrt{\dot{x}^2}$ in that limit, we see that T is now contained in the contribution of the rectangle only. Since the energy spectrum is provided by terms proportional to T , we conclude that the energy spectrum provided by the previous contour is the same as that of the rectangle. Therefore the shape of the contour C_{21} has no influence on the energy spectrum and contributes only to the wave functional of the corresponding bound state, made here of a static quark-antiquark pair. The meaning of this result is that minimal surfaces, irrespective of the shapes of their contours, cannot produce quantum string-like excitations in the bound state energy spectrum, since rectangles do not contain such excitations. This was an expected result, for the minimal surface is the classical action of the open string and quantum excitations of it should only be searched for in fluctuations of surfaces about the classical trajectory [24, 25, 26]; the present derivation, however, provides another insight into the same property.

B Normalization of the wave function

In order to derive the normalization condition satisfied by the wave function, we start from Eq. (6.8):

$$\begin{aligned}
& [P_L - (h_{10} + h_{20})]G \\
& -i \left[\gamma_{1L} \gamma_1^\alpha \int_0^1 d\sigma (1 - \sigma) \frac{\delta}{\delta x^\alpha(\sigma)} + \gamma_{2L} \gamma_2^\beta \int_0^1 d\sigma \sigma \frac{\delta}{\delta x^\beta(\sigma)} \right] G \Big|_{x(\sigma) \in x_1 x_2} \\
& = -i \delta^4(x_1 - x'_1) \gamma_{1L} \sum_{j=1}^{\infty} G_{0,j} - i \delta^4(x_2 - x'_2) \gamma_{2L} \sum_{i=1}^{\infty} G_{i,0}. \tag{B.1}
\end{aligned}$$

The series $\sum_i G_{i,0}$ and $\sum_j G_{0,j}$ that appear in the right-hand side are reminiscent of the series expansions of the quark and antiquark propagators in the presence of the gluon field (Secs. 4 and 5). They have the definitions:

$$\begin{aligned}
\sum_{i=1}^{\infty} G_{i,0} &= -\langle \text{tr}_c U(x_2, x_1) S_1(x_1, x'_1) U(x'_1, x_2) \rangle_A, \\
\sum_{j=1}^{\infty} G_{0,j} &= \langle \text{tr}_c U(x_2, x_1) U(x_1, x'_2) S_2(x'_2, x_2) \rangle_A. \tag{B.2}
\end{aligned}$$

They can be interpreted as generalized gauge invariant quark (antiquark) propagators in the presence of the antiquark (the quark) at position x_2 (x_1). The detailed study of the

structure of the series $\sum_i G_{i,0}$ and $\sum_j G_{0,j}$ by means of the general formula (5.6) shows that they involve surface terms formed by the propagator lines and the external particle position, which implies that they contain, in addition to self-energy terms, interaction terms with the external particles through the functional derivatives of these surfaces. However, simplifications occur when one considers the equal time limits $x_{2L} = x_{1L}$ and $x'_{2L} = x'_{1L}$. Because of the presence of the four-dimensional delta-functions, the corresponding surfaces lie now in planes orthogonal to the timelike surface lying to infinity and containing $x_1 x_2$ (or are integrated around such planes). Such types of surface are generally negligible in front of surfaces that lie to infinity. In that case the main contributions that arise in the above series are those coming from the segments representing the boundaries of those surfaces and producing self-energy corrections. Those are calculated in Sec. 7 [Eq. (7.6)] and are found to be independent of the longitudinal momentum. We therefore approximate the right-hand side quantities of Eq. (B.1) by the quark propagators with self-energies. We have in momentum space

$$\begin{aligned} \sum_{i=1}^{\infty} G_{i,0} &\simeq -N_c S(p_1, m_1) = -N_c \frac{i}{\gamma_{1L} p_{1L} - m_1 - \Sigma(p_1^T, m_1)}, \\ \sum_{j=1}^{\infty} G_{0,j} &\simeq N_c S(-p_2, m_2) = N_c \frac{i}{-\gamma_{2L} p_{2L} - m_2 - \Sigma(-p_2^T, m_2)}. \end{aligned} \quad (\text{B.3})$$

The equal-time limit amounts to integrating with respect to the relative energy variable in momentum space. Defining

$$\tilde{G}(P, p^T, p'^T) = \int \frac{dp_L}{(2\pi)} \frac{dp'_L}{(2\pi)} G(P, p, p') \quad (\text{B.4})$$

(after having removed common factors $(2\pi)^4 \delta^4(P - P')$), and integrating Eq. (B.1) in momentum space with respect to p_L and p'_L we find:

$$[P_L - h_1 - h_2 - iK] \tilde{G} = \frac{i}{2} N_c \left(\frac{h_1}{E_1} + \frac{h_2}{E_2} \right) \gamma_{1L} \gamma_{2L} (2\pi)^3 \delta^3(p^T - p'^T). \quad (\text{B.5})$$

In the left-hand side we have designated by iK the kernel that results from the functional derivatives and which will survive in the bound state limit; it is essentially represented by the vector potentials calculated in Sec. 6; furthermore, we have extracted from the above functional derivative contributions, as in Sec. 7, the self-energy parts and included them in the free Dirac hamiltonians h_1 and h_2 [Eqs. (7.9)-(7.11)]. Next, we multiply both sides by $\tilde{G} \gamma_{1L} \gamma_{2L} \frac{1}{2} (\frac{h_1}{E_1} + \frac{h_2}{E_2})$ and take the bound state limit, represented in \tilde{G} by a pole in $s \equiv P^2$:

$$\tilde{G} \underset{s \rightarrow s_0}{\simeq} -i \frac{\psi \bar{\psi}}{s - s_0}. \quad (\text{B.6})$$

Deriving both sides with respect to s and noticing that the left-hand side operator in Eq. (B.5) annihilates the bound state wave function [Eq. (7.12)], one obtains:

$$\begin{aligned} \psi \left[\int \frac{d^3 p^T}{(2\pi)^3} \text{tr} \psi^\dagger(P_L, p^T) \frac{1}{2} \left(\frac{h_1}{E_1} + \frac{h_2}{E_2} \right) \psi(P_L, p^T) \right] \bar{\psi} = \\ 2P_L N_c \psi \bar{\psi} \gamma_{1L} \gamma_{2L} \left[\frac{1}{2} \left(\frac{h_1}{E_1} + \frac{h_2}{E_2} \right) \right]^2 \gamma_{1L} \gamma_{2L}. \end{aligned} \quad (\text{B.7})$$

(The trace is over the Dirac spinor indices.) To simplify the right-hand side, we notice that in the absence of the rotational motion of the flux tube, the vector potentials reduce to their longitudinal components [Eq. (6.23)]. In that case, the wave function satisfies the equation

$$[\epsilon(p_{1L}) - \epsilon(p_{2L})] \psi = 0, \quad (\text{B.8})$$

similar to the Salpeter equation case [30], which implies that the right-hand side operator in Eq. (B.7), $\gamma_{1L} \gamma_{2L} \left[\frac{1}{2} \left(\frac{h_1}{E_1} + \frac{h_2}{E_2} \right) \right]^2 \gamma_{1L} \gamma_{2L}$, can be replaced by 1. Adopting this approximation, we obtain for the normalization condition:

$$\int \frac{d^3 p^T}{(2\pi)^3} \text{tr} \psi^\dagger \frac{1}{2} \left(\frac{h_1}{E_1} + \frac{h_2}{E_2} \right) \psi = 2P_L N_c. \quad (\text{B.9})$$

This formula is the same as that obtained from the Salpeter equation [30].

C The Breit approximation

The Breit approximation [29] consists in transforming the wave equation (7.12) into a local equation in x -space. This is achieved by first replacing the energy sign operators appearing in the potentials (6.20) by 1; in the nonrelativistic limit this approximation affects only terms of order $O(1/c^4)$ or higher. Second, the operators E_a , $a = 1, 2$, and $\mathbf{L}^2/\mathbf{x}^2$ that appear in the potentials are replaced by their mean values. Third, the self-energy terms are neglected. The wave equation takes then the form (6.13), where h_{a0} , $a = 1, 2$, are the free Dirac hamiltonians [Eqs. (6.7)] and potentials $A_{a\mu}$, $a = 1, 2$, have been submitted to the approximations described above. In order not to spoil the property of spontaneous chiral symmetry breakdown realized by the self-energy parts of the Dirac hamiltonians h_a ($a = 1, 2$) [Eqs. (7.9)] in the massless limit, we replace the total c.m. energy P_L by $\sqrt{P^2 + 4E_0^2}$, where E_0 is a constant the value of which is fixed by the requirement that the ground state be massless. Those approximations do not affect the high energy properties of the spectrum, since these are mostly determined by semi-classical properties (in particular the Regge behavior).

The resulting equation is now a Breit type local equation in \mathbf{x} that can be solved with standard methods. In this form, however, a difficulty arises coming from the fact that

vectorlike local potentials of the confining type at the classical level do not seem to confine at the quantum level due to instabilities that appear at large distances [54]. The difficulty, however, is only apparent. The study of the Pauli–Schrödinger equation that results from the Breit type wave equation shows that the Darwin terms of the equation contain a repulsive singularity at a finite distance, depending on the energy of the bound state, which confines the quarks inside a baglike system with an energy dependent radius and forbids any tunnelling between the inner domain of the bag and its outer domain. Therefore, confining normalizable solutions do exist; they are obtained with the boundary condition that the component ψ_3 of the wave function [Eq. (8.14)] vanishes at the boundary of the bag. That boundary condition, breaks, however, implicitly chiral symmetry, since it does not operate in a symmetric way between chiral partners. This is why, in spite of the facts that the whole interaction is vectorlike and self-energy parts have been neglected, the spectrum displays chiral asymmetry and a massless ground state appears if the constant E_0 is correctly adjusted.

The existence of that type of confining solutions with vectorlike potentials was already pointed out by Geffen and Suura [55]. In that work, the masslessness of the ground state is ensured by the presence of the short-distance Coulomb-like potential and the adjustment of the corresponding coupling constant.

References

- [1] K. G. Wilson, Phys. Rev. D 10 (1974) 2445.
- [2] J. B. Kogut, Rev. Mod. Phys. 55 (1983) 775.
- [3] S. Mandelstam, Phys. Rev. 175 (1968) 1580.
- [4] Y. Nambu, Phys. Lett. 80B (1979) 372.
- [5] A. M. Polyakov, Nucl. Phys. B164 (1979) 171.
- [6] Yu. M. Makeenko and A. A. Migdal, Phys. Lett. 88B (1979) 135; 97B (1980) 253.
- [7] Yu. M. Makeenko and A. A. Migdal, Nucl. Phys. B188 (1981) 269.
- [8] A. A. Migdal, Phys. Rep. 102 (1983) 199.
- [9] Yu. Makeenko, *Large N gauge theories*, hep-th/0001047.
- [10] S. Mandelstam, Phys. Rev. D 19 (1979) 2391.
- [11] R. Giles, Phys. Rev. D 24 (1981) 2160.

- [12] V. A. Kazakov and I. K. Kostov, Nucl. Phys. B176 (1980) 199; V. A. Kazakov, Nucl. Phys. B179 (1981) 283.
- [13] V. S. Dotsenko and S. N. Vergeles, Nucl. Phys. B169 (1980) 527.
- [14] R. A. Brandt, F. Neri and Masa-aki Sato, Phys. Rev. D 24 (1981) 879; R. A. Brandt, A. Gocksch, M.-A. Sato and F. Neri, Phys. Rev. D 26 (1982) 3611.
- [15] G. 't Hooft, Nucl. Phys. B72 (1974) 461.
- [16] E. Eichten and F. Feinberg, Phys. Rev. D 23 (1981) 2724.
- [17] D. Gromes, Z. Phys. C 22 (1984) 265; 26 (1984) 401.
- [18] A. Barchielli, E. Montaldi and G. M. Prosperi, Nucl. Phys. B296 (1988) 625; B303 (1988) 752 (E); A. Barchielli, N. Brambilla and G. M. Prosperi, Nuovo Cimento 103 A (1990) 59.
- [19] N. Brambilla, P. Consoli and G. M. Prosperi, Phys. Rev. D 50 (1994) 5878; N. Brambilla, E. Montaldi and G. M. Prosperi, Phys. Rev. D 54 (1996) 3506.
- [20] N. Brambilla and A. Vairo, *Quark confinement and the hadron spectrum*, hep-ph/9904330.
- [21] M. Baldicchi and G. M. Prosperi, Phys. Lett. B 436 (1998) 145; Phys. Rev. D 62 (2000) 114024; D 66 (2002) 074008.
- [22] H. G. Dosch, Phys. Lett. B 190 (1987) 177; Yu. A. Simonov, Nucl. Phys. B307 (1988) 512; H. G. Dosch and Yu. A. Simonov, Phys. Lett. B 205 (1988) 339; A. Di Giacomo, H. G. Dosch, V. I. Shevchenko and Yu. A. Simonov, Phys. Rep. 372 (2002) 319.
- [23] J. Maldacena, Adv. Theor. Math. Phys. 2 (1997) 231; Phys. Rev. Lett. 80 (1998) 4859; E. Witten, Adv. Theor. Math. Phys. 2 (1998) 505; N. Drukker, D. G. Gross and H. Ooguri, Phys. Rev. D 60 (1999) 125006; A. M. Polyakov and V. S. Rychkov, Nucl. Phys. B581 (2000) 116; B594 (2001) 272.
- [24] T. Egushi, Phys. Rev. Lett. 44 (1980) 126.
- [25] M. Lüscher, Phys. Lett. 90B (1980) 277.
- [26] M. Lüscher, K. Symanzik and P. Weisz, Nucl. Phys. B173 (1980) 365.
- [27] E. E. Salpeter and H. A. Bethe, Phys. Rev. 84 (1951) 1232.
- [28] M. Gell-Mann and F. Low, Phys. Rev. 84 (1951) 350.

- [29] G. Breit, Phys. Rev. 34 (1929) 553; 36 (1930) 383; 39 (1932) 616.
- [30] E. E. Salpeter, Phys. Rev. 87 (1952) 328.
- [31] R. Courant, *Dirichlet's principle, conformal mapping, and minimal surfaces*, reprint (Springer-Verlag, New York, 1977).
- [32] R. P. Feynman, Phys. Rev. 80 (1950) 440; 84 (1951) 108; J. Schwinger, Phys. Rev. 82 (1951) 664; T. E. Nieuwenhuis, *The Feynman-Schwinger representation of field theory applied to two-body bound states*, Ph. D. thesis, Utrecht University (1995), unpublished; Yu. A. Simonov and J. R. Tjon, Ann. Phys. (N.Y.) 300 (2002) 54.
- [33] G. Veneziano, Nucl. Phys. B117 (1976) 519; E. Witten, Nucl. Phys. B160 (1979) 57.
- [34] M. G. Olsson and K. Williams, Phys. Rev. D 48 (1993) 417.
- [35] D. LaCourse and M. G. Olsson, Phys. Rev. D 39 (1989) 2751; C. Olson, M. G. Olsson and K. Williams, Phys. Rev. D 45 (1992) 4307; C. Olson and M. G. Olsson, Phys. Rev. D 49 (1994) 4675.
- [36] M. Baker, K. Johnson and B. W. Lee, Phys. Rev. 133 (1964) B209.
- [37] G. 't Hooft, Nucl. Phys. B75 (1974) 461.
- [38] I. M. Gel'fand and G. E. Shilov, *Generalized functions*, Vol. I (Academic Press, New York, 1964).
- [39] Y. Nambu and G. Jona-Lasinio, Phys. Rev. 122 (1961) 345; 124 (1961) 246.
- [40] J. Finger, J. E. Mandula and J. Weyers, Phys. Lett. 96B (1980) 367; J. Finger and J. E. Mandula, Nucl. Phys. B199 (1982) 168; J. Govaerts, J. E. Mandula and J. Weyers, Nucl. Phys. B237 (1984) 59.
- [41] A. Amer, A. Le Yaouanc, L. Oliver, O. Pène and J.-C. Reynal, Phys. Rev. Lett. 50 (1983) 87; A. Le Yaouanc, L. Oliver, O. Pène and J.-C. Reynal, Phys. Rev. D 29 (1984) 1233; A. Le Yaouanc, L. Oliver, S. Ono, O. Pène and J.-C. Reynal, Phys. Rev. D 31 (31) 87.
- [42] S. L. Adler and A. C. Davis, Nucl. Phys. B244 (1984) 469.
- [43] R. Alkofer and P. A. Amundsen, Nucl. Phys. B306 (1988) 305.
- [44] J.-F. Lagaë, Phys. Rev. D 45 (1992) 305; 317.
- [45] H. D. Politzer, Nucl. Phys. B117 (1976) 397.

- [46] M. Gell-Mann, R. J. Oakes and B. Renner, *Phys. Rev.* 175 (1968) 2195.
- [47] S. Narison, *QCD spectral sum rules* (World Scientific, Singapore, 1989), and references therein.
- [48] W. Buchmüller, *Phys. Lett.* 112B (1982) 479.
- [49] A. Huntley and C. Michael, *Nucl. Phys.* B286 (1987) 211.
- [50] G. S. Bali, K Schilling and A. Wachter, *Phys. Rev. D* 56 (1997) 2566.
- [51] W. Lucha, F. F. Schöberl and D. Gromes, *Phys. Rep.* 200 (1991) 127.
- [52] G. S. Bali, *Phys. Rep.* 343 (2001) 1.
- [53] M. Ida, *Prog. Theor. Phys.* 59 (1978) 1661.
- [54] M. E. Rose and R. R. Newton, *Phys. Rev.* 82 (1951) 470; B. Ram, *Am. J. Phys.* 50 (1982) 549; A. Z. Capri and R. Ferrari, *Can. J. Phys.* 63 (1985) 1029; H. Galić, *Am. J. Phys.* 56 (1988) 312.
- [55] D. A. Geffen and H. Suura, *Phys. Rev. D* 16 (1977) 3305; H. Suura, *Phys. Rev. D* 17 (1978) 469.