

Neutrino Masses in Astrophysics and Cosmology

Georg G. Raffelt

Max-Planck-Institut für Physik, Föhringer Ring 6, 80805 München, Germany

(August 28, 2021)

Astrophysical and cosmological arguments and observations give us the most restrictive constraints on neutrino masses, electromagnetic couplings, and other properties. Conversely, massive neutrinos would contribute to the cosmic dark-matter density and would play an important role for the formation of structure in the universe. Neutrino oscillations may well solve the solar neutrino problem, and can have a significant impact on supernova physics.

I. INTRODUCTION

Within the standard model of elementary particle physics, neutrinos play a special role in that they are the only fermions that appear with only two degrees of freedom per family, which are massless, and which interact only by the weak force apart from gravitation. If neutrinos had masses or anomalous electromagnetic interactions, or if right-handed (sterile) neutrinos existed, this would constitute the long-sought “physics beyond the standard model.” Hence the enthusiasm with which experimentalists search for neutrino oscillations, neutrinoless double-beta decay, a signature for a neutrino mass in the tritium beta decay spectrum, or for neutrino electromagnetic dipole or transition moments.

Over the years, many speculations about hypothetical neutrino properties and their consequences in astrophysics and cosmology have come and gone. I shall not pursue the more exotic of those conjectures such as strong neutrino-neutrino interactions by majoron and other couplings, small neutrino electric charges, the existence of low-mass right-handed partners to the established sequential flavors, and so forth. Any of them can be significantly constrained by astrophysical and cosmological methods [1], but currently there does not seem to be a realistic way to positively establish physics beyond the standard model on such grounds. Therefore, I will focus on the more conservative modifications of the standard-model neutrino sector, namely on neutrino masses and mixings. Surely, the discovery of a nonvanishing mass is the holy grail of neutrino physics, and one that actually may be established to exist in the near future.

Arguably the most important astrophysical information about neutrino properties is the cosmological mass limit of about 40 eV which, in the case of ν_τ , improves the direct experimental limit by about six orders of magnitude. If neutrinos decay, this limit can be circumvented. However, the only standard-model decay that would be fast enough is $\nu_\tau \rightarrow e^+e^-\nu_e$ if $m_{\nu_\tau} \gtrsim 2m_e$. This mode can be constrained by the absence of γ rays from the supernova (SN) 1987A and other arguments to be far too

slow than needed to evade the cosmological mass limit. Therefore, its violation requires fast invisible neutrino decays, i.e. rather exotic physics beyond the standard model. These issues are explored in Sec. II.

Currently favored models for the formation of structure in the universe exclude neutrinos as a dark-matter candidate. Still, neutrinos with a mass of a few eV could play an important positive role in mixed hot plus cold dark matter scenarios. The chances for a signature of such scenarios in future cosmic microwave background maps has been assessed (Sec. III).

Big-bang nucleosynthesis (BBN) has long been used to constrain the number of light neutrino species [2], which however is now well established to be 3 from precision measurements of the Z^0 decay width. More recently, the BBN argument has been revived to constrain a ν_τ mass in the MeV range [3]. However, the assumption of a neutrino mass in excess of the cosmological limit of about 40 eV is somewhat forced because it requires exotic neutrino interactions beyond the standard model.

The existence of three massless or nearly massless two-component neutrino flavors is compatible with standard BBN, even though there is some current debate about the interpretation of certain observations which imply somewhat incompatible or inconsistent primordial light element abundances [4]. However, what is at stake is not so much any serious implication for neutrino physics, but rather the precise value of the baryon content η of the universe. In any event, BBN is not sensitive to those nonstandard neutrino properties which are most likely to be found in nature, i.e. small masses and mixings. Therefore, I do not want to embark here on any further discussion of BBN.

A positive identification of neutrino masses most likely will come from the discovery of neutrino oscillations. Current indications for this phenomenon include the solar neutrino problem, the atmospheric neutrino anomaly, and the LSND excess counts of $\bar{\nu}_e$'s. As these issues are discussed by other speakers at this School, I will give only the briefest of summaries at the beginning of Sec. IV. For the most part, that section will be dedicated to the impact of neutrino oscillations on SN physics.

II. MASS LIMITS

A. Cosmological Mass Limit

The most important cosmological contribution to neutrino physics is the mass limit which arises from the requirement that the universe is not “overclosed” by neutrinos [2]. In the framework of the big-bang scenario of the early universe one expects about as many cosmic “black-body neutrinos” as there are microwave photons. In detail, the cosmic energy density in massive neutrinos is found to be $\rho_\nu = \frac{3}{11} n_\gamma \sum m_\nu$ with n_γ the present-day density in microwave background photons. The sum extends over the masses of all sequential neutrino flavors. In units of the critical density this is

$$\Omega_\nu h^2 = \sum \frac{m_\nu}{93 \text{ eV}}, \quad (1)$$

where h is the present-day Hubble expansion parameter in units of $100 \text{ km s}^{-1} \text{ Mpc}^{-1}$. The observed age of the universe together with the measured expansion rate yields $\Omega h^2 \lesssim 0.4$ so that for any of the known families

$$m_\nu \lesssim 40 \text{ eV}. \quad (2)$$

If one of the neutrinos had a mass near this bound it would be the main component of the long-sought dark matter of the universe.

The importance of this result is illustrated in Fig. 1 which shows the mass spectrum of the quarks and charged leptons, and the direct experimental neutrino mass limits. Except for ν_e , the cosmological limit is far below the experimental ones which implies that neutrino

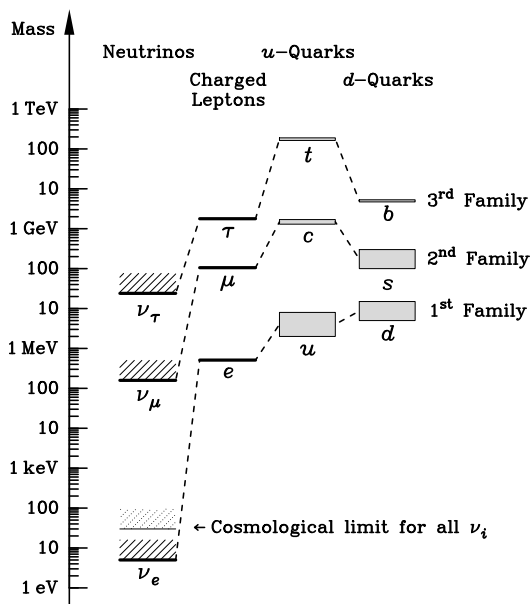

FIG. 1. Mass spectrum of elementary fermions. For neutrinos, the direct experimental mass limits as well as the cosmological limit are shown.

masses (except for ν_e) cannot be detected by direct experimental methods. It also implies that if neutrinos have masses at all, they are very much smaller than those of the other fundamental fermions. Therefore, neutrinos play a very special role, even if they were to carry nonvanishing masses after all, a hypothesis which is entertained by a majority of all particle physicists.

B. Decaying Neutrinos

The cosmological mass limit is based on the assumption that neutrinos are stable which most likely they are not if they have masses. Sufficiently early decays into nearly massless daughter particles would allow the energy stored in the massive neutrinos to be redshifted enough so that the universe would not be “overclosed” after all. In Fig. 2 the range of neutrino masses and lifetimes that remains forbidden is shown by the shaded area marked “Mass Density.” A detailed construction of this plot is found in Ref. [5].

A “decaying neutrino cosmology” actually has some attractive features for the formation of structure in the cosmic matter distribution. In Sec. III B below I will discuss that the standard cold dark matter cosmology has the problem of producing too much power in the density-fluctuation spectrum on small scales, and that a mixed hot plus cold dark-matter scenario is one way of fixing this problem. Another way is with decaying neutrinos because the universe would become matter dominated when the massive neutrino becomes nonrelativistic, would return to radiation domination when it decays, and

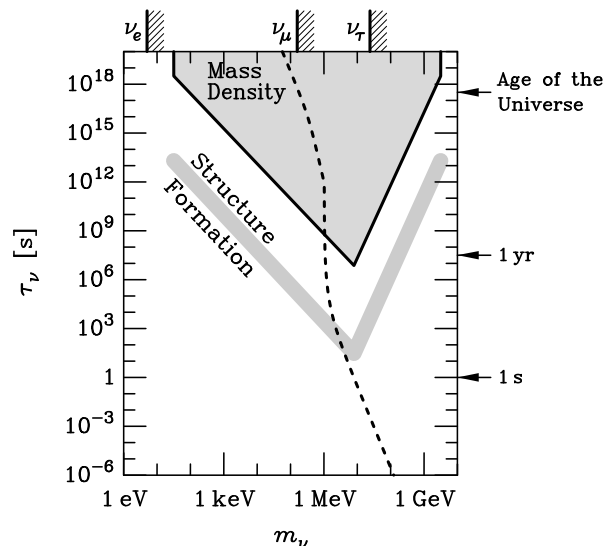

FIG. 2. Cosmological bounds on neutrino masses and lifetimes. The experimental mass limits are shown above the main panel. The dashed line is the lifetime for $\nu_\tau \rightarrow \nu_e \gamma$ and $\nu_\tau \rightarrow \nu_e e^+ e^-$ under the assumption of maximum ν_e - ν_τ -mixing.

would become matter dominated again at a later time. As structure grows by gravitational instability only in phases of matter domination, one has two more parameters at hand (the neutrino mass and lifetime) to tune the final density fluctuation spectrum. For neutrino parameters in the shaded band marked “Structure Formation” in Fig. 2 this mechanism could at least partially solve the problems of the cold dark matter cosmology [6].

The snag with this sort of scenario is that within the particle-physics standard model even massive neutrinos cannot decay fast enough. Even mixed, massive neutrinos cannot decay at tree-level by processes of the sort $\nu_\tau \rightarrow \nu_e \bar{\nu}_e \nu_e$ because of the absence of flavor-violating neutral currents. Therefore, only radiative decays of the sort $\nu_\tau \rightarrow \nu_e \gamma$ are possible. Because they proceed through a one-loop amplitude, and because of their so-called GIM suppression, their rate is exceedingly slow. Even if the radiative mode were enhanced by some unknown mechanism, radiative decays can be excluded in a large range of masses and lifetimes because the final-state photons would appear as contributions to the cosmic photon backgrounds [2]. Therefore, decaying-neutrino cosmologies as well as a circumvention of the cosmological mass bound require “fast invisible decays,” i.e. fast decays with final-state neutrinos or with new exotic particles such as majorons. Put another way, if neutrinos were found to violate the cosmological mass bound of 40 eV, this would be a signature for physics “far beyond” the standard model. It would require novel ingredients other than neutrino masses and mixings.

There is one exception to this reasoning if ν_τ had a mass exceeding $2m_e$ because then the decay $\nu_\tau \rightarrow \nu_e e^+ e^-$ is kinematically possible. Assuming maximum mixing between ν_τ and ν_e , the lifetime of ν_τ as a function of its mass is plotted in Fig. 2 as a dashed line. (For $m_{\nu_\tau} < 2m_e$ the rate is dominated by $\nu_\tau \rightarrow \nu_e \gamma$.) Evidently, even without exotic extensions of the standard model, a heavy ν_τ could escape the cosmological mass limit.

This loophole can be plugged by a combination of laboratory and astrophysical arguments. First, there are numerous laboratory limits on the ν_τ - ν_e mixing angle. In Fig. 3 I show exclusion areas under the assumption that $\nu_\tau \rightarrow \nu_e e^+ e^-$ is the only available decay channel which is open due to ν_τ - ν_e mixing. The hatched area marked “Cosmic Energy Density” is the corresponding exclusion area taken from Fig. 2.

It is thought that in a SN collapse the gravitational binding energy of the newborn neutron star is emitted almost entirely in the form of neutrinos, and that this energy of about 3×10^{53} ergs is roughly equipartitioned between the (anti)neutrinos of all flavors. Even if m_{ν_τ} were as large as allowed by laboratory experiments (about 24 MeV) the ν_τ emission process would not be significantly suppressed by threshold effects. Therefore, supernovae are powerful ν_τ sources. The positrons from the subsequent $\nu_\tau \rightarrow \nu_e e^+ e^-$ decay would be trapped in the galactic magnetic field and would have a lifetime against annihilation of about 10^5 yr. Therefore, the

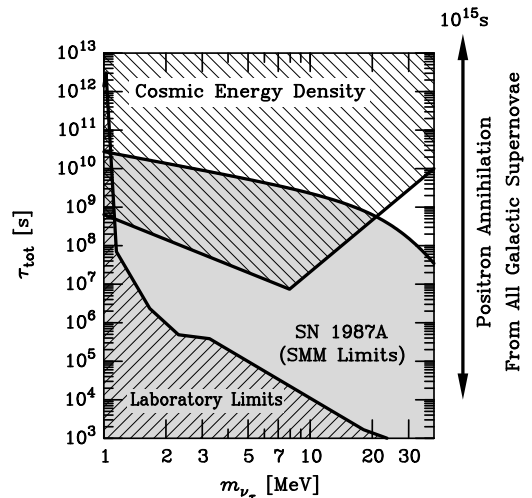

FIG. 3. Exclusion areas for the ν_τ mass and lifetime if $\nu_\tau \rightarrow \nu_e e^+ e^-$ is the only available decay channel. The “Cosmic Energy Density” region is taken from Fig. 2.

galactic positron flux integrated over all supernovae over such a period would far exceed the observed value unless the ν_τ 's either decay very fast (very close to the SN), or else they live so long that they escape from the galaxy before decaying. The excluded range of lifetimes according to Ref. [7] is indicated in Fig. 3 by a vertical arrow.

A particularly important exclusion range arises from SN 1987A which is the first and only supernova from which neutrinos were observed. The gamma-ray spectrometer (GRS) on the solar maximum mission (SMM) satellite which was operational at the time did not observe any excess photon counts in coincidence with the neutrino signal, allowing one to derive restrictive limits on neutrino radiative decays [1]. For the present discussion it is most interesting that the absence of observed γ -rays also allows one to restrict the inner bremsstrahlung process $\nu_\tau \rightarrow \nu_e e^+ e^- \gamma$ and thus the $\nu_\tau \rightarrow \nu_e e^+ e^-$ channel [8]; the excluded parameter range is shaded in Fig. 3.

Interestingly, this SN 1987A exclusion range can be extended by new γ -ray observations. The time-of-flight delay of MeV-mass neutrinos from SN 1987A is so large that one could still observe γ -rays today; one does not depend on the SMM observations which were coincident with the neutrino signal. The COMPTEL γ -ray telescope has been used for that purpose with two dedicated viewing periods in 1991 with a total observation time of 6.82×10^5 sec [9]. Thus far, only an analysis for the $\nu_\tau \rightarrow \nu_e \gamma$ channel has been presented. However, for MeV-mass ν_τ 's one would expect a dramatic improvement of the limits on the $\nu_\tau \rightarrow \nu_e e^+ e^- \gamma$ channel as well; such an analysis is in progress [10].

In summary, if one extends the particle-physics standard model only with neutrino masses and mixings, the cosmological mass bound remains firm as there is no vi-

able neutrino decay channel which is both fast enough and “invisible.” Conversely, if neutrino masses in excess of about 40 eV were to show up in experiments, this would indicate novel neutrino interactions far outside of what is expected by the standard model. In this case decaying neutrinos could also play a useful role for the formation of structure in the universe.

C. Supernova Mass Limits

For the sake of completeness, two mass limits deserve mention which were derived from the SN 1987A neutrino signal. First, the absence of a discernible time-of-flight dispersion of the observed $\bar{\nu}_e$ burst gave rise to $m_{\nu_e} \lesssim 20$ eV [11]. This limit is now obsolete in view of the improved experiments concerning the tritium β decay endpoint spectrum. Even though these results seem to be plagued with unidentified systematic errors, a ν_e mass as large as 20 eV does not seem to be viable.

Second, if neutrinos had Dirac masses, helicity-flipping collisions in the dense inner core of a SN would produce right-handed states. Because these sterile neutrinos are not trapped they carry away the energy directly which otherwise escapes by a diffusion process to the neutrino sphere from where it is radiated by standard left-handed neutrinos. Therefore, the energy available for standard neutrino cooling would be diminished, leading to a shortening of the SN 1987A $\bar{\nu}_e$ burst. Because the burst duration roughly agrees with theoretical expectations, this scenario can be constrained, leading to $m_\nu \lesssim 30$ keV on a possible Dirac mass for the ν_μ and ν_τ [1]. Of course, such a large mass would violate the cosmological limit and thus is only of interest if there are fast invisible decays beyond the standard model. Typically, even “invisible” decay channels would involve (left-handed) final-state neutrinos which could become visible in the detectors which registered the SN 1987A signal. Because the sterile neutrinos which escape directly from the SN core would have higher energies than those emitted from the neutrino sphere, these events would stick out from the observed SN 1987A signal. This allows one to derive additional limits on certain decay channels of Dirac-mass ν_μ ’s and ν_τ ’s [12].

Of course, much improved mass limits could be derived if one were to observe a future galactic supernova. In a detector like the proposed Supernova Burst Observatory (SNBO) one could observe ν_μ ’s and ν_τ ’s by a coherently enhanced neutral-current nuclear dissociation reaction of the type $\nu + (Z, N) \rightarrow (Z, N - 1) + n + \nu$. In principle, one could be sensitive to time-of-flight signal dispersion effects corresponding to neutrino masses of a few 10 eV for ν_μ or ν_τ , especially if the SNBO neutral-current signal were analysed in conjunction with the charged-current $\bar{\nu}_e p \rightarrow n e^+$ signal expected for the Superkamiokande detector [13].

III. NEUTRINOS AS DARK MATTER

A. Galactic Phase Space

Cosmology implies a mass limit of about 40 eV on all sequential neutrinos. If this limit were saturated by one of the neutrinos, say the ν_τ , it would constitute the dark matter of the universe. Is this possible and plausible? The current standard answer is “no” because neutrinos as dark matter candidates fare poorly on two main grounds.

The first is a well-known problem with neutrinos filling the dark-matter haloes of galaxies. By definition, galactic dark-matter neutrinos would be gravitationally bound to the galaxy so that their velocity would be bound from above by the galactic escape velocity v_{esc} , yielding an upper limit on their momentum of $p_{\text{max}} = m_\nu v_{\text{esc}}$. Because of the Pauli exclusion principle the maximum number density of neutrinos is given when they are completely degenerate with a Fermi momentum p_{max} , i.e. it is $n_{\text{max}} = p_{\text{max}}^3/3\pi^2$. Therefore, the maximum local mass density in dark-matter neutrinos is $m_\nu n_{\text{max}} = m_\nu^4 v_{\text{esc}}^3/3\pi^2$. As this value must exceed a typical galactic dark matter density, one obtains a *lower* limit on the necessary neutrino mass. A refinement of this simple derivation is known as the Gunn-Tremaine limit [14]. For typical spiral galaxies it is in the range of a few 10 eV.

Therefore, dark-matter neutrino masses are squeezed between the upper limit from the overall cosmic mass density, and the lower limit from the galactic phase-space argument. They are squeezed, but perhaps not entirely squeezed out. Neutrinos could not constitute the dark matter of dwarf galaxies where a mass of a few 100 eV is required by the Gunn-Tremaine argument. However, perhaps the dark matter in dwarf galaxies is of a different physical nature. At any rate, the galactic phase-space argument surely disturbs any simple-minded fantasy about neutrinos being the dark matter on all scales.

B. Structure Formation

The main argument against neutrino dark matter arises from current scenarios of how structure forms in the cosmic matter distribution. One pictures a primordial power spectrum of low-amplitude density fluctuations which are later amplified by the action of gravity. The expected final distribution of galaxies then depends on both the nature of the dark matter and the original fluctuation spectrum. The result of this sort of reasoning are often displayed in a plot like Fig. 4 where the Fourier transform of the matter distribution is shown as a function of wave-number or length scale. The data are derived from the analysis of observed galaxy distributions.

Inflationary models of the early universe predict a roughly scale-invariant primordial fluctuation spectrum (Harrison-Zeldovich-spectrum). At the time of matter-radiation decoupling its amplitude is normalized by the

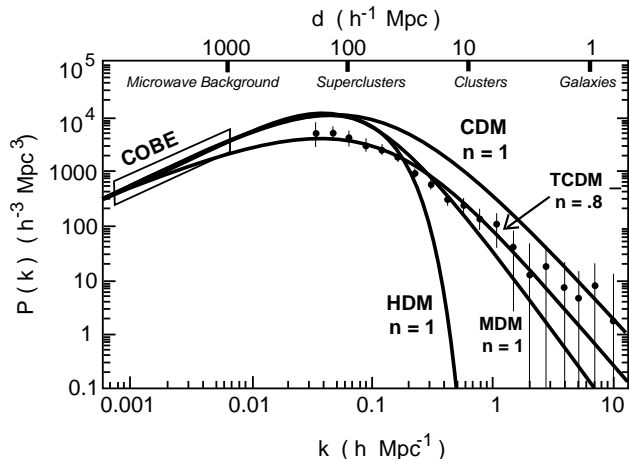

FIG. 4. Comparison of matter-density power spectra for cold dark matter (CDM), tilted cold dark matter (TCDM), hot dark matter (HDM), and mixed hot plus cold dark matter (MDM) for large-scale structure formation [15]. All theoretical curves are normalized to COBE and include only linear approximation; nonlinear corrections become important on scales smaller than about 10 Mpc.

COBE observations of angular temperature variations in the cosmic microwave background. From Fig. 4 it is evident that a standard cold dark matter (CDM) scenario if normalized to COBE predicts more power in the small-scale galaxy distribution than is actually observed.

Neutrinos, on the other hand, represent so-called hot dark matter because they stay relativistic almost until the epoch of radiation decoupling. This implies that their relativistic free streaming erases the primordial fluctuation spectrum on small scales, suppressing the formation of small-scale structure (Fig. 4).

Of course, neutrinos as dark matter may still be viable if the original seeds for structure formation are not provided by inflation-induced initial density fluctuations, but rather by something like cosmic strings or textures [16]. Such scenarios involving topological defects do not seem to be excluded, but they are certainly disfavored by current main-stream cosmological thinking, and have not been quantitatively worked out in comparable detail as the CDM-type cosmologies.

The problem of a standard CDM cosmology depicted in Fig. 4 can be patched up in a variety of ways. One is to tinker with the primordial spectrum of density fluctuation which may have been almost, but not quite, of the Harrison-Zeldovich form. One example of such a “tilted cold dark matter” (TCDM) result is shown in Fig. 4.

Another patch-up is to invoke a mixed hot plus cold dark matter (MDM) cosmology (Fig. 4) where the hot component erases enough of the initial power spectrum on small scales to compensate for the overproduction of small-scale power of pure CDM. In an $\Omega = 1$ universe, the best fit is obtained with a total mass in neutrinos corresponding to $\sum m_\nu = 5 \text{ eV}$ with an equipartition of

the masses among the flavors [17]. Primack has argued that a MDM cosmology not only fixes the problems with the power spectrum, but also avoids an overdensity of the dark matter in central galactic haloes [18].

C. Cosmic Microwave Background

Granted that something like a CDM cosmology describes our universe, how will we ever know if indeed it contains a small component of neutrino dark matter? One new source of information will come in the form of the precision sky maps of the temperature variations of the cosmic microwave background that will be obtained by the MAP and the Planck Surveyor (formerly COBRAS/SAMBA) satellites. Such sky maps are usually interpreted in terms of their multipole expansion. The expected power as a function of the multipole order l is shown in Fig. 5 for a pure cold dark matter cosmology as a solid line according to Ref. [19]. The modified power spectra for three versions of a mixed hot plus cold dark matter cosmology are also shown.

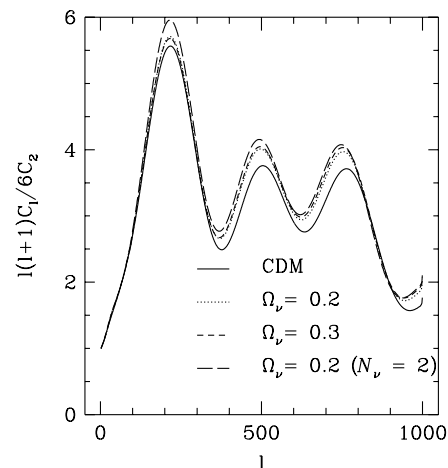

FIG. 5. Power spectrum of the temperature sky map for the cosmic microwave background in a cold dark matter cosmology, and three variants of mixed dark matter [19].

The first current ambition of cosmic microwave experiments is to identify the first of the “Doppler peaks” in the power spectrum. With the high angular resolution planned for the Planck Surveyor, however, one will be able, in principle, to distinguish between the CDM and the MDM curves shown in Fig. 5. However, there are other unknown cosmological parameters such as the overall mass density, the Hubble constant, the cosmological constant, and so forth, which all affect the expected power spectrum. All of these parameters will have to be determined by fitting the power spectrum obtained from future measurements. Therefore, it remains to be seen if a small neutrino component of the overall dark matter density can be identified by cosmic microwave data.

IV. NEUTRINO OSCILLATIONS

A. Evidence So Far

While neutrino masses would play a very important role in cosmology, it appears unlikely that cosmological arguments or observations alone will be able to prove or disprove this hypothesis anytime soon. Therefore, the only realistic and systematic path to search for neutrino masses is to search for neutrino oscillations as explained by other speakers at this school. Unsurprisingly, a vast amount of experimental effort is dedicated to this end. While large regions of neutrino mass differences and mixing angles have been excluded (Fig. 6) there is yet no uncontested positive signature for oscillations. However, there exist a number of experimental “anomalies” that could well point to oscillations.

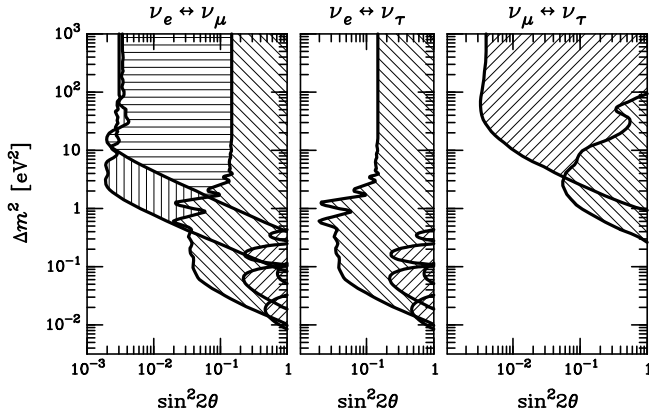

FIG. 6. Limits on neutrino masses and mixing angles from laboratory experiments. For detailed references see Refs. [1,20].

The most recent example is a pure laboratory experiment at Los Alamos where neutrinos are produced in a proton beam dump. The secondary positive pions decay according to $\pi^+ \rightarrow \mu^+ + \nu_\mu$ and the muons according to $\mu^+ \rightarrow e^+ + \bar{\nu}_\mu + \nu_e$. In the Liquid Scintillator Neutrino Detector (LSND) about 30 meters downstream, a significant number of excess $\bar{\nu}_e$ counts was obtained [21] which cannot be due to the primary source which does not produce $\bar{\nu}_e$'s. These excess counts can be interpreted as the appearance of oscillated $\bar{\nu}_\mu$'s (Fig. 7). If this interpretation were correct, the ν_e - ν_μ mass difference could be of order 1 eV or more, pointing to cosmologically significant neutrino masses. At the present time one has to wait and see if more LSND data and other experiments such as KARMEN will confirm this rather tentative finding.

Another indication for oscillations arises from the atmospheric neutrino anomaly. The production process by high-energy cosmic-ray protons is very similar to the LSND experiment, except that the higher-energy protons produce both positively and negatively charged pions and kaons in roughly equal proportions so that one expects about equally many neutrinos as antineutrinos,

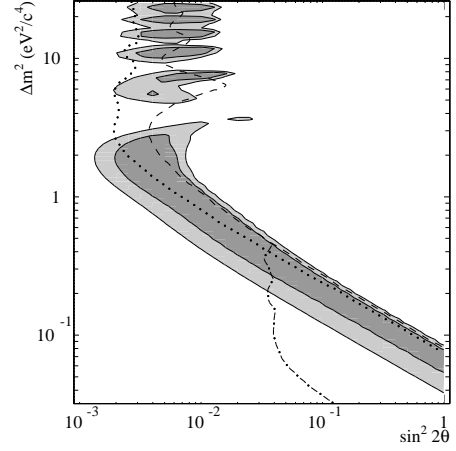

FIG. 7. The LSND favored mixing parameters [21]. The shaded areas are the 90% or 99% likelihood regions. Also shown are 90% C.L. limits from KARMEN (dashed curve), BNL-E776 (dotted curve), and the Bugey reactor experiment (dot-dashed curve).

and a $\nu_\mu : \nu_e$ flavor ratio of about 2 : 1. However, the Kamiokande detector has observed a flavor ratio more like 1 : 1 [22]. Further, Kamiokande has seen an angular dependence of the flavor ratio as expected for oscillations due to the different path lengths through the Earth from the atmosphere to the detector [23]. In principle, these observations can be explained by either ν_μ - ν_e oscillations, or by ν_μ - ν_τ ones (Fig. 8). Either way, nearly maximum mixing is required with a mass difference of about 10^{-1} eV. However, for ν_μ - ν_e oscillations the favored range of parameters is excluded entirely by the

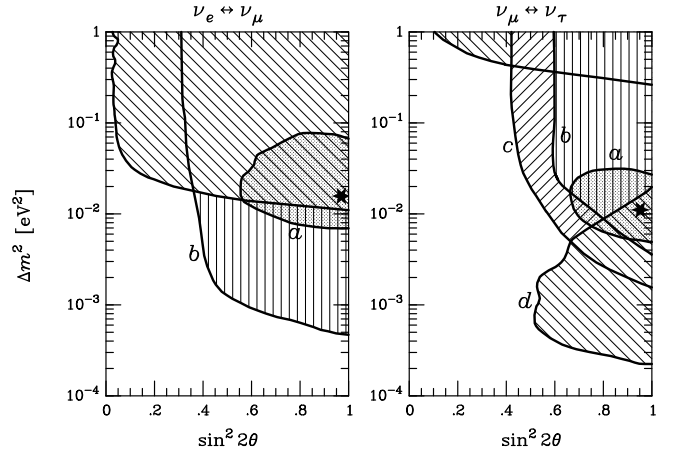

FIG. 8. Limits on neutrino masses and mixing angles from atmospheric neutrinos. (a) The shaded area is the range of masses and mixing angles required to explain the ν_e/ν_μ anomaly at Kamiokande [23]; the star marks the best-fit values. The hatched areas are excluded by: (b) ν_e/ν_μ ratio at Fréjus [24]. (c) Absolute rate and (d) stopping fraction of upward going muons at IMB [25]. Also shown are the parameter regions excluded by laboratory experiments.

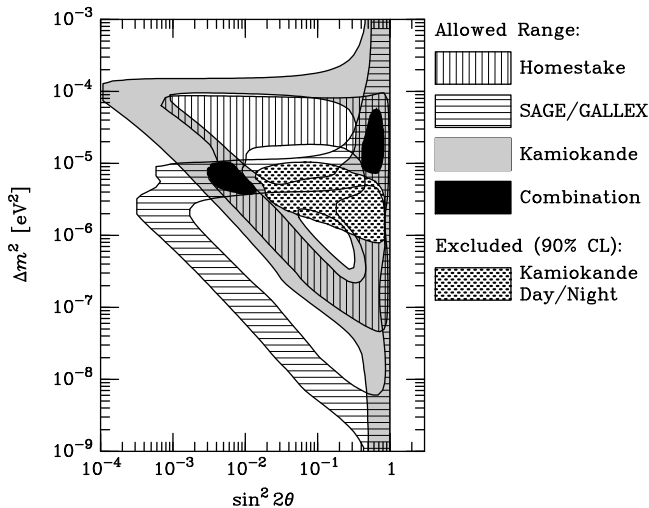

FIG. 9. MSW solutions to the solar neutrino problem according to Ref. [26] if the flux deficit relative to the Bahcall and Pinsonneault (1995) solar model is interpreted in terms of neutrino oscillations.

nonobservation of a flavor anomaly in Fréjus [24], while the ν_μ - ν_τ case is only partially excluded. Further inconsistencies seem to exist with certain IMB measurements of the stopping fraction of upward-going muons [25]. One may hope that the new Superkamiokande detector will soon clarify this confusing situation.

Probably the most convincing tentative evidence for neutrino oscillations arises from the solar neutrino problem which has been amply covered by other speakers at this school. If the measured flux deficits are interpreted in terms of matter-induced oscillations (MSW-effect) one obtains the favored mixing parameters for ν_e - ν_μ or ν_e - ν_τ oscillations as indicated in Fig. 9. A consistent interpretation in terms of “long-wavelength” vacuum oscillations is also possible; the favored mixing parameters obtained from a typical analysis are shown in Fig. 10. If any of these solutions will indeed bear out from future solar neutrino experiments remains to be seen. Certainly, at the present time there is no plausible alternate explanation on the market.

These indications for neutrino oscillations require three different mass differences which are not compatible with each other. Therefore, not all of these results can indeed indicate neutrino oscillations unless one appeals to the existence of neutrino degrees of freedom beyond the known sequential flavors, i.e. to the existence of sterile neutrinos. It remains to be seen which (if any) of these results will withstand closer scrutiny by better data.

Meanwhile it remains of interest to look for other scenarios where neutrino oscillations could be important. Neutrinos dominate the dynamics of the early universe and so it is natural to wonder if oscillations could have significant effects there. However, because all flavors are in thermal equilibrium with each other, the usual flavor oscillations would not change anything. Oscillations into

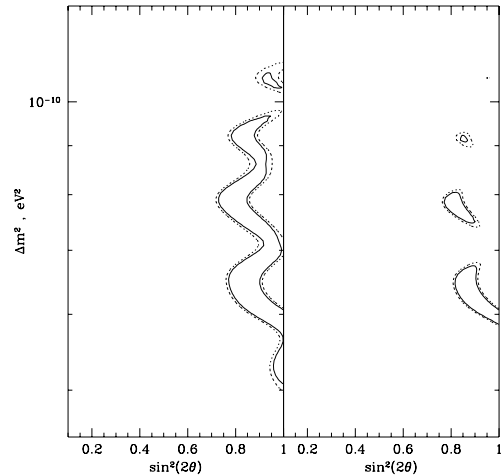

FIG. 10. Vacuum solutions to the solar neutrino problem at 90 and 95% C.L. according to Ref. [27] for ν_e - ν_μ or ν_e - ν_τ oscillations. The two panels represent somewhat different versions of the statistical analysis.

sterile neutrinos would be a nontrivial effect, but since there is little theoretical or experimental motivation to speculate about the existence of low-mass right-handed neutrinos, I will not discuss neutrino oscillations in the early universe any further.

B. Supernova Physics

Concentrating on flavor oscillations between sequential neutrinos, supernovae are natural environments to scrutinize for nontrivial consequences. A type II supernova occurs when a massive star ($M \gtrsim 8 M_\odot$) has reached the end of its life. At this point it consists of a degenerate iron core, surrounded by several shells of different nuclear burning phases. Because iron is the most tightly bound nucleus, it cannot gain further energy by nuclear fusion so that no further burning phase can be ignited at the center. As the iron core grows in mass because nuclear burning at its surface produces more “ashes,” it eventually reaches its Chandrasekhar limit of about $1.4 M_\odot$, i.e. the maximum mass that can be supported by electron degeneracy pressure. The subsequent core collapse is halted only when nuclear densities are reached where the equation of state stiffens. At this point a shock wave forms at the edge of the inner core, i.e. at the edge of that part of the iron core which collapses subsonically and thus is in good hydrodynamic “communication” with itself. This shock wave advances outward, and eventually expels the mantle and envelope of the collapsed object, an event which is observed as the optical supernova explosion. Essentially, the gravitational implosion of the core is transformed into an explosion of the outer parts of the star by the “shock and bounce” mechanism.

Virtually all of the binding energy of the newly formed

compact star (about 3×10^{53} ergs) is radiated away by neutrinos. However, because the collapsed core is so hot and dense that even neutrinos are trapped, this process takes several seconds which corresponds to a neutrino diffusion time scale from the center of the core to the “neutrino sphere” at its surface from where these particles can escape freely. It is thought that the released energy is roughly equipartitioned between all (anti)neutrino flavors, and that it is emitted with roughly thermal spectra.

In spite of the approximate flavor equipartition of the emitted energy, neutrino oscillations can have important consequences for supernova physics because the spectra are different between the different flavors. Various studies find that the average expected neutrino energy from a SN is [28]

$$\langle E_\nu \rangle = \begin{cases} 10\text{--}12 \text{ MeV} & \text{for } \nu_e, \\ 14\text{--}17 \text{ MeV} & \text{for } \bar{\nu}_e, \\ 24\text{--}27 \text{ MeV} & \text{for } \nu_{\mu,\tau} \text{ and } \bar{\nu}_{\mu,\tau}, \end{cases} \quad (3)$$

i.e. typically $\langle E_{\nu_e} \rangle \approx \frac{2}{3} \langle E_{\bar{\nu}_e} \rangle$ and $\langle E_\nu \rangle \approx \frac{5}{3} \langle E_{\bar{\nu}_e} \rangle$ for the other flavors. The different mean energies are explained by the different main reactions which trap neutrinos, namely $\nu_e n \rightarrow pe^-$, $\bar{\nu}_e p \rightarrow ne^+$, and $\nu N \rightarrow N\nu$ with $N = n$ or p . Because the charged-current reactions have larger cross sections than the neutral-current ones, and because there are more neutrons than protons, the ν_e 's have the hardest time to escape and thus emerge from the farthest out and thus coldest layers. Still, the radii of the layers from which the different flavors escape are not too different so that the relatively large variation of the spectral temperatures between the flavors and the equipartition of the emitted energy appears to contradict the Stefan-Boltzmann law. An explanation for this apparent paradox is given in Ref. [29].

It is conceivable that (resonant) oscillations occur outside of the neutrino sphere so that the spectra between two flavors can be swapped. Two possible consequences of such a spectral exchange have been discussed in the literature.

The first has to do with the explosion mechanism for type II supernovae which does not work quite as simple as described above. Because the shock wave forms at the edge of the subsonic inner core, not at the edge of the iron core, it moves through a layer of iron before reaching the stellar mantle. By dissociating iron it loses energy and stalls after a few 100 ms in typical calculations. The deposition of energy by neutrinos which emerge from the inner core is thought to revive the shock wave so that it resumes its outward motion and eventually explodes the outer star. However, this “delayed explosion mechanism” still does not seem to work in typical calculations because the transfer of energy from the neutrinos to the shock wave is not efficient enough. Recently the importance of convection both within the neutron star and between the neutron star and the shock wave has been recognized to play some role at helping to transfer more energy to the

shock wave, but even then successful explosions are not guaranteed.

If neutrinos follow a “normal” mass hierarchy so that ν_e is dominated by the highest mass eigenstate, one can have MSW-type resonant oscillations between, say, ν_e and ν_τ . If this occurs between the neutrino sphere and the stalling shock wave, the ν_e 's reaching the shock wave are really oscillated ν_τ 's and thus have the higher spectral energies characteristic for that flavor. The total energy flux in both flavors is about the same, but the absorption cross sections are larger for larger energies so that more energy is transferred to the shock wave [30]. Because the MSW transition must occur rather close to the neutrino sphere where the matter densities are large, neutrino mass differences in the cosmologically interesting regime are required for this effect to operate. In Fig. 11 the approximate range of masses and mixing angles is shown where neutrino oscillations would help to explode supernovae.

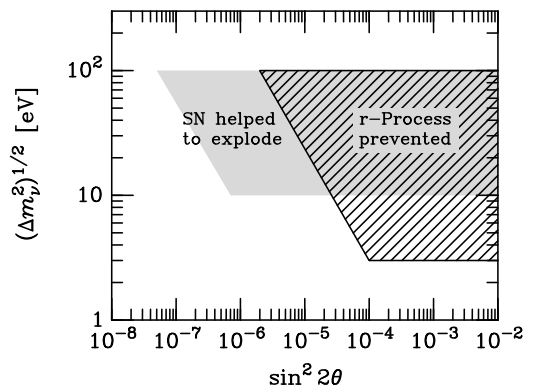

FIG. 11. Mixing parameters between ν_e and ν_μ or ν_τ where a spectral swap by resonant oscillations would be efficient enough to help explode supernovae (schematically after Ref. [30]), and where it would prevent r-process nucleosynthesis (schematically after Ref. [31]).

A second consequence of oscillations is their possible impact on nucleosynthesis. It has long been thought that the isotopes with $A \gtrsim 70$ are formed by neutron capture which thus requires a neutron-rich environment. It is now thought that an ideal site for the r-process is the high-entropy “hot bubble” in a SN between the young neutron star and the advancing shock wave a few seconds after collapse. The neutrino-driven wind in this dilute environment is shifted to a neutron-rich phase by β processes and because of the energy hierarchy $\langle E_{\nu_e} \rangle < \langle E_{\bar{\nu}_e} \rangle$. However, if oscillations would cause a spectral swap between, say, ν_e and ν_τ then this energy hierarchy would be inverted and the wind would be shifted to a proton-rich phase, preventing the occurrence of r-process nucleosynthesis [31]. Because this argument applies to a later phase than the explosion argument above, the neutron star has thermally settled so that the matter gradients at its surface are much steeper than before. This makes it harder to meet the adiabaticity condition for the MSW effect,

reducing the range of mixing angles where this effect operates (Fig. 11).

At the present time it is not certain if r-process nucleosynthesis indeed occurs in supernovae so that the hatched area in Fig. 11 cannot be taken as a serious exclusion plot for neutrino mixing parameters. Still, it is fascinating that cosmologically interesting neutrino masses would have a nontrivial impact on SN physics. At any rate, there is a significant range of small mixing angles where supernovae could be helped to explode by oscillations, and r-process nucleosynthesis could still proceed unscathed.

C. SN 1987A Signal Interpretation

Neutrinos from a collapsing star were observed for the first and only time from SN 1987A which occurred in the Large Magellanic Cloud on 23 February 1987. Naturally, the observed signature would be different if oscillations had occurred between the source and the detectors. Two observable effects have been discussed in the literature.

The first relates to the so-called neutronization ν_e burst which precedes the main cooling phase. It is produced when the shock wave breaks through the surface of the iron core, allowing the sudden release of ν_e 's from the reactions $e^-p \rightarrow n\nu_e$ from a layer encompassing perhaps a few $0.1 M_\odot$ of matter. Most of the core is deleptonized and thus neutronized only during the relatively slow subsequent cooling phase. In the water Cherenkov detectors IMB and Kamiokande which registered the SN 1987A signal, the $\nu_e e \rightarrow e\nu_e$ scattering reaction would have produced forward-peaked electrons as a signature for this burst, although one would have expected only a fraction of an event. As the first event in Kamiokande does point in the forward direction, it has often been interpreted as being due to the neutronization burst.

If resonant oscillations in the SN mantle and envelope had occurred, the deleptonization ν_e 's would have arrived as ν_μ 's or ν_τ 's instead which have a much smaller scattering cross section on electrons, thus reducing the observable signal. In Fig. 12 the shaded triangle shows the mixing parameters for which the oscillation probability would have exceeded 50%, assuming a normal neutrino mass hierarchy. For orientation, the MSW triangle for solar neutrinos in the Kamiokande detector and the MSW solution to the solar neutrino problem are also shown. Evidently, the small-angle MSW solution would not be in conflict with the interpretation that the first SN 1987A Kamiokande event was indeed ν_e scattering. Of course, this single event does not allow one to reach the opposite conclusion that the large-angle MSW solution was ruled out.

Most or probably all of the 19 events at Kamiokande and IMB must have been due to the $\bar{\nu}_e p \rightarrow n e^+$ reaction. Assuming again a normal neutrino mass hierarchy, resonant oscillations could not have swapped the $\bar{\nu}_e$ spectra

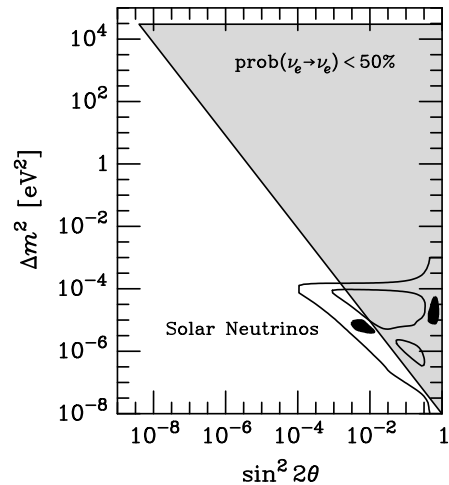

FIG. 12. Mixing parameters between ν_e and ν_μ or ν_τ where the prompt SN neutronization burst of ν_e 's would have resonantly oscillated into another flavor (after Ref. [32]). A normal mass hierarchy is assumed where ν_e is dominated by the lightest mass eigenstate. For orientation, the Kamiokande solar MSW triangle and the MSW solutions to the solar neutrino problem are also shown.

with some other flavor; they could have affected only the ν_e spectrum. Therefore, the observed events represent the initial $\bar{\nu}_e$ spectrum at the source unless the mixing angle is large, allowing for significant non-resonant oscillation effects. Large mixing angles in the neutrino sector are motivated by the large-angle MSW and the vacuum solution to the solar neutrino problem as well as by the oscillation interpretation of the atmospheric neutrino anomaly.

One way of interpreting the observed SN 1987A events is to use the data to derive best-fit values for the total binding energy E_b and the spectral temperature of the observed $\bar{\nu}_e$'s which is defined by $T_{\bar{\nu}_e} = \frac{1}{3}\langle E_{\bar{\nu}_e} \rangle$. Assuming certain mixing parameters and certain relative spectral temperatures $\tau \equiv T_{\bar{\nu}_\mu}/T_{\bar{\nu}_e}$ between the flavors the results from such an analysis are shown in Figs. 13 and 14 according to Ref. [33]. In the case $\tau = 1$ oscillations have no effect so that this is identical to the standard no-oscillation scenario. Apparently the measured signal characteristics are nearly incompatible with the theoretical predictions which are indicated by the hatched rectangle in Figs. 13 and 14. This effect is due to the surprisingly low energies of the events in the Kamiokande detector.

According to Eq. (3) a typical value for the relative spectral temperature is $\tau = 1.7$. According to Fig. 13 this would be inconsistent with the vacuum solution to the solar neutrino problem because the expected event energies in the detector would have been even larger than in the standard case, contrary to the relatively low energies that were actually observed. Put another way, if the vacuum solution to the solar neutrino problem is borne out by future experiments, there is a serious conflict between the

SN 1987A observations and theoretical predictions.

For the large-angle MSW solution the conflict is less severe (Fig. 14). For such mixing parameters the flavor evolution is adiabatic in the supernova envelope so that propagation eigenstates emerge from the surface which do not oscillate between the SN and us. However, on the path through the Earth to the detectors, matter-induced “regeneration effects” partly undo the spectral mixture that emerged from the supernova, i.e. partly restore the original source spectra, reducing the overall impact of neutrino oscillations.

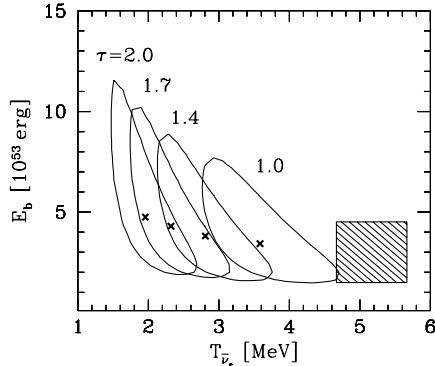

FIG. 13. 95% confidence contours for the neutron star binding energy and temperature of the primary $\bar{\nu}_e$ spectrum for the marked values of $\tau = T_{\bar{\nu}_\mu}/T_{\bar{\nu}_e}$ [33]. For the neutrino mixing parameters typical values for the solar vacuum oscillation solution were chosen ($\Delta m^2 = 10^{-10} \text{ eV}^2$, $\sin^2 2\Theta = 1$). In the case $\tau = 1$ oscillations do not change the spectra so that this contour corresponds to the absence of oscillations. The hatched area represents the range of theoretical predictions.

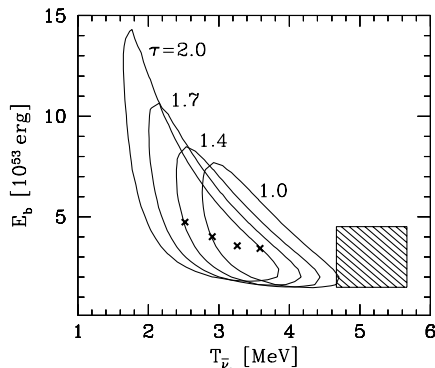

FIG. 14. Same as Fig. 13 for neutrino mixing parameters which are typical for the solar large-angle MSW solution ($\Delta m^2 = 10^{-5} \text{ eV}^2$, $\sin^2 2\Theta = 0.8$).

In summary, the comparison of the SN 1987A neutrino observations with theoretical predictions disfavor the large-angle solutions to the solar neutrino problem, even though the data are too sparse to reach this conclusion “beyond reasonable doubt.”

V. DISCUSSION AND SUMMARY

The minimal picture of neutrinos as espoused by the particle-physics standard model is still compatible with all established experimental, astrophysical, and cosmological evidence. Of course, even such minimal neutrinos would play a dominant role for the dynamics of the early universe, of supernova explosions, and for the energy loss of evolved stars. In the absence of any compelling theoretical reason for neutrinos to be truly massless it is commonplace to assume that they do carry small masses and that the flavors mix. Cosmology provides by far the most restrictive limit of about 40 eV on the mass of all sequential flavors. This limit cannot be circumvented by decays unless neutrinos interact by new forces which allow for “fast invisible” (i.e. nonradiative) decays. Therefore, the assumption of neutrino masses in excess of about 40 eV is tantamount to the assumption of a significant extension of the standard model in the neutrino sector, an extension for which there is no compelling theoretical motivation. If neutrinos have masses at all, I think it is a safe bet to assume that their masses obey the cosmological limit.

Neutrinos are unfashionable dark matter candidates because of the well-known problems of a hot dark matter cosmology if one assumes that structure forms by gravitational instability from something like a Harrison-Zeldovich spectrum of initial density perturbations. For the time being, the standard cold dark matter picture works impressively well even though it appears to overproduce structure on small scales. This problem can be patched up by a number of different modifications, one of them being a hot plus cold dark matter scenario with a neutrino component corresponding to $m_{\nu_e} + m_{\nu_\mu} + m_{\nu_\tau} \approx 5 \text{ eV}$. However, it looks unlikely that this sort of scenario can be unambiguously identified by cosmological methods alone. Even the most ambitious future cosmic microwave sky maps probably will not be able to identify this model unambiguously in view of the remaining uncertainty in other cosmological parameters.

Depending on the exact mixing parameters, neutrino oscillations can have very severe consequences for supernova physics and the signal interpretation of SN 1987A or a future galactic supernova. Especially for neutrino masses in the cosmologically interesting regime, oscillations may affect the explosion mechanism and r-process nucleosynthesis in the hot bubble between the neutron star and the advancing shock wave. However, the current understanding of SN physics is too uncertain and the SN 1987A data are too sparse to tell if neutrino oscillations are either required or excluded. Still, it remains fascinating that a neutrino mass as small as a few eV has any significant consequences outside of cosmology.

In summary, even though massive neutrinos may play an important role in cosmology and supernova physics, realistically we will know if this is indeed the case only by more direct measurements. With the possible exception of neutrinoless double β decay experiments, the only

fair chance to positively identify neutrino masses is by oscillation experiments. In principle, oscillations can explain the atmospheric neutrino anomaly, the LSND $\bar{\nu}_e$ excess counts, and especially the solar neutrino problem. However, a simultaneous explanation of all three phenomena by oscillations is barely possible and somewhat implausible. It is my personal opinion that the current round of solar neutrino experiments holds the most realistic promise of producing uncontested evidence for neutrino physics beyond the narrow confines of the standard model.

-
- [1] G. G. Raffelt, *Stars as Laboratories for Fundamental Physics* (University of Chicago Press, Chicago, 1996).
- [2] E. W. Kolb and M. S. Turner, *The Early Universe* (Addison-Wesley, Reading, Mass.).
- [3] G. M. Fuller and R. A. Malaney, *Phys. Rev. D* 43 (1991) 3136. E. W. Kolb et al., *Phys. Rev. Lett.* 67 (1991) 533. K. Enqvist and H. Uibo, *Phys. Lett. B* 301 (1993) 376. A. D. Dolgov and I. Z. Rothstein, *Phys. Rev. Lett.* 71 (1993) 476. M. Kawasaki et al., *Nucl. Phys. B* 419 (1994) 105. A. D. Dolgov, K. Kainulainen, and I. Z. Rothstein, *Phys. Rev. D* 51 (1995) 4129. B. D. Fields, K. Kainulainen, and K. A. Olive, *Astropart. Phys.* 6 (1997) 169. S. Hannestad and J. Madsen, *Phys. Rev. Lett.* 76 (1996) 2848; *Phys. Rev. D* 54 (1996) 7894. A. D. Dolgov, S. Pastor, and J. W. F. Valle, *Phys. Lett. B* 383 (1996) 193.
- [4] A few references concerning the current BBN debate are: N. Hata et al., *Phys. Rev. Lett.* 75 (1995) 3977. B. D. Fields and K. A. Olive, *Phys. Lett. B* 368 (1996) 103. P. J. Kernan and S. Sarkar, *Phys. Rev. D* 54 (1996) 3681. J. C. Copi, K. A. Olive and D. N. Schramm, Report Fermilab-Pub-96-158-A, submitted to *Astrophys. J. Lett.* (1996). M. Rugers and C. J. Hogan, *Astron. J.* 111 (1996) 2135; *Astrophys. J. Lett.* 459 (1996) L1. S. Burles and D. Tytler, E-Print astro-ph/9603070. D. Tytler, X.-M. Fan and S. Burles, *Nature* 381 (1996) 207.
- [5] D. A. Dicus, E. W. Kolb and V. L. Teplitz, *Phys. Rev. Lett.* 39 (1977) 169.
- [6] G. Steigman and M. S. Turner, *Nucl. Phys. B* 253 (1985) 253. J. Bardeen, J. Bond, and G. Efstathiou, *Astrophys. J.* 321 (1987) 28. L. M. Krauss, *Phys. Lett. B* 263 (1991) 441. J. R. Bond and G. Efstathiou, *Phys. Lett. B* 265 (1991) 245. S. Dodelson, G. Gyuk, and M. S. Turner, *Phys. Rev. Lett.* 72 (1994) 3754. M. White, G. Gelmini, and J. Silk, *Phys. Rev. D* 51 (1995) 2669.
- [7] A. Dar, J. Goodman, and S. Nussinov, *Phys. Rev. Lett.* 58 (1987) 2146. For an update see Ref. [1].
- [8] A. Dar and S. Dado, *Phys. Rev. Lett.* 59 (1987) 2368. For an update see Ref. [1].
- [9] R. S. Miller, Doctoral Thesis (University of New Hampshire, 1995). R. S. Miller, J. M. Ryan and R. C. Svoboda, Contributed Paper to Neutrino 96 (unpublished).
- [10] R. S. Miller, work in progress (1996).
- [11] T. J. Loredo and D. Q. Lamb, in: *Fourteenth Texas Symposium on Relativistic Astrophysics*, edited by E. J. Fenyves, *Ann. N.Y. Acad. Sci.* 571 (1989) 601. P. J. Kernan and L. M. Krauss, *Nucl. Phys. B* 437 (1995) 243.
- [12] S. Dodelson, J. A. Frieman and M. S. Turner, *Phys. Rev. Lett.* 68 (1992) 2572.
- [13] L. M. Krauss et al., *Nucl. Phys. B* 380 (1992) 507. D. Cline et al., *Phys. Rev. D* 50 (1994) 720.
- [14] J. E. Gunn and S. Tremaine, *Phys. Rev. Lett.* 42 (1979) 407.
- [15] P. J. Steinhardt, E-print astro-ph/9502024.
- [16] R. Brandenberger, "Modern Cosmology and Structure Formation," Lectures given at Theoretical Advanced Study Institute in Elementary Particle Physics (TASI 94): CP Violation and the limits of the Standard Model, Boulder, CO, 29 May - 24 June 1994. Proceedings edited by John F. Donoghue (World Scientific, Singapore, 1995).
- [17] J. R. Primack et al., *Phys. Rev. Lett.* 74 (1995) 2160. D. Pogosyan and A. A. Starobinsky, *Astrophys. J.* 447 (1995) 465. D. H. Lyth et al., *Mon. Not. R. Astron. Soc.* 281 (1996) 531.
- [18] J. R. Primack, E-Print hep-ph/9610321, to appear in the Proceedings of the XVII International Conference on Neutrino Physics and Astrophysics, Helsinki, Finland, 13-19 June 1996, edited by K. Enqvist, K. Huitu and J. Maalampi (World Scientific, Singapore, 1997).
- [19] S. Dodelson, E. Gates and A. Stebbins, *Astrophys. J.* 467 (1996) 10.
- [20] Particle Data Group, *Phys. Rev. D* 50 (1994) 1173.
- [21] C. Athanassopoulos et al., *Phys. Rev. Lett.* 77 (1996) 3082; *Phys. Rev. C* 54 (1996) 2685.
- [22] K. S. Hirata et al., *Phys. Lett. B* 280 (1992) 146.
- [23] Y. Fukuda et al., *Phys. Lett. B* 335 (1994) 237.
- [24] Fréjus Collaboration, *Phys. Lett. B* 245 (1990) 305 and *Z. Phys. C* 66 (1995) 417. K. Daum, Report WUB 94-9, Contributed paper to Neutrino 94 (unpublished).
- [25] R. Becker-Szendy et al., *Phys. Rev. Lett.* 69 (1992) 1010.
- [26] N. Hata and W. Haxton, *Phys. Lett. B* 353 (1995) 422.
- [27] P. I. Krastev and S. T. Petcov, *Phys. Rev. Lett.* 72 (1994) 1960.
- [28] H.-T. Janka, in: Proc. Vulcano Workshop 1992 "Frontier Objects in Astrophysics and Particle Physics," edited by F. Giovanelli and G. Mannocchi, Conf. Proc. Vol. 40 (1993) (Soc. Ital. Fis.).
- [29] H.-T. Janka, *Astropart. Phys.* 3 (1995) 377.
- [30] G. M. Fuller et al., *Astrophys. J.* 389 (1992) 517.
- [31] Y.-Z. Qian et al., *Phys. Rev. Lett.* 71 (1993) 1965. Y.-Z. Qian and G. M. Fuller, *Phys. Rev. D* 51 (1995) 1479.
- [32] D. Nötzold, *Phys. Lett. B* 196 (1987) 315.
- [33] B. Jegerlehner, F. Neubig and G. Raffelt, *Phys. Rev. D* 54 (1996) 1194.