

QCD Inequalities

Shmuel Nussinov* and Melissa A. Lampert†
School of Physics and Astronomy
Raymond and Beverly Sackler Faculty of Exact Sciences
Tel Aviv University
69978 Tel Aviv, Israel
(September 17, 2018)

We review the subject of QCD inequalities, using both a Hamiltonian variational approach, and a rigorous Euclidean path integral approach.

PACS number(s): 12.35.Eq,12.70.+q

Contents

1	Introduction	3
2	Derivation of flavor mass relations in a simple potential model	5
3	Baryon-meson mass inequalities in the gluon exchange model	9
4	Baryon-baryon mass inequalities	12
5	Relating masses in different flavor sectors	13
6	Baryon-meson inequalities in a non-perturbative approach	15
7	Comparison of the inequalities with hadronic masses	18
8	QCD inequalities for correlation functions of quark bilinears	23
9	QCD inequalities and the non-breaking of global vectorial symmetries	27
10	Baryon-meson mass inequalities from correlation functions	30
11	Mass inequalities and $S_\chi SB$ in QCD and vectorial theories	32
12	Inequalities between masses of pseudoscalar mesons	37
13	The absence of spontaneous parity violation in QCD	41
14	QCD inequalities and the large N_c limit	42
15	QCD inequalities for glueballs	43
16	QCD inequalities in the exotic sector	45
17	QCD inequalities for finite temperature and finite chemical potential	47
18	QCD inequalities for $\bar{Q}Q$ potentials, quark masses, and weak transitions	49
19	QCD inequalities beyond the two-point functions	51

*electronic mail:nussinov@ccsg.tau.ac.il

†electronic mail:melissa@albert.tau.ac.il

20	Summary and suggested future developments	53
	20.1 A conjecture on the N_f dependence of the QCD inequalities	55
	20.2 Conjectured inequalities related to the “ferromagnetic” nature of the QCD action	56
	20.3 Inequalities for quantities other than hadronic masses	57
	APPENDIXES	58
A	Lieb’s counterexample to Eq. (4.1)	58
B	Discussion of Lieb’s results for three-body Hamiltonians	59
C	Proof of Eq. (5.2)	61
D	Enumeration and specification of the baryon-meson inequalities	63
E	Application to quadronium	65
F	QCD inequalities for exotic novel hadron states	66
G	QCD inequalities between EM corrections to nuclear scattering	70
H	QCD-like inequalities in atomic, chemical, and biological contexts	72
	1 Mass relations between compounds of different isotopes	72
	2 Conjectured inequalities for chemical bindings	72
	3 Mass inequalities in nuclear physics	73
	4 A biological analog for inequalities between correlators	73

1. INTRODUCTION

The crucial steps in the evolution of any scientific discipline are the identification of the underlying degrees of freedom and the dynamics governing them. For the theory of strongly interacting particles these degrees of freedom are the quarks and gluons, and the elegant quantum chromodynamics (QCD) Lagrangian

$$\mathcal{L}_{\text{QCD}} = \sum_{i=1}^{N_f} \bar{\psi}_i (\not{D} + m_i) \psi_i + \text{tr}(F_{\mu\nu}^a \lambda_a)^2 \quad (1.1)$$

prescribes the dynamics.

Here we would like to review how one can deduce directly from \mathcal{L}_{QCD} , and from its Hamiltonian counterpart (with possible additional assumptions), various inequalities between hadronic masses and/or other hadronic matrix elements (observables).

The euclidean correlation functions of color singlet (gauge invariant) local operators $O_{a_i}(x)$ are given by the functional path integral [1,2]

$$\begin{aligned} W_{a_1 \dots a_n}(x_1 \dots x_n) &= \langle 0 | O_{a_1}(x_1) \dots O_{a_n}(x_n) | 0 \rangle \\ &= \int d[A_\mu] \int d[\psi] \int d[\bar{\psi}] O_{a_1}(x_1) \dots O_{a_n}(x_n) e^{-\int d^4x \mathcal{L}(x)}, \end{aligned} \quad (1.2)$$

with $\int d[A_\mu] \int d[\psi] \int d[\bar{\psi}]$ indicating the functional integral over the ordinary gauge field and fermionic (Grassman) degrees of freedom. By analytically continuing the corresponding momentum space correlations $W_{a_1 \dots a_n}(p_1 \dots p_n)$ all hadronic scattering amplitudes can be determined.

The simplest two-point functions are particularly useful. The spectral representation for such functions

$$W_a(x, y) = \langle 0 | J_a(x) J_a^\dagger(y) | 0 \rangle = \int d(\mu^2) \sigma_a(\mu^2) e^{-\mu|x-y|} \quad (1.3)$$

yields information on the hadronic states in the channel with J_a quantum numbers, *i.e.* the energy-momentum eigenstates $|n\rangle$ with non-vanishing $\langle 0 | J_a | n \rangle$ matrix elements. Thus a lowest state of mass $m_a^{(0)}$ implies an asymptotic behavior which, up to powers of $|x-y|$, is

$$\langle 0 | J_a(x) J_a^\dagger(y) | 0 \rangle \xrightarrow{\text{lim}_{|x-y| \rightarrow \infty}} e^{-m_a^{(0)}|x-y|}. \quad (1.4)$$

The hadronic spectrum can also be directly obtained via the Schrödinger equation

$$H_{\text{QCD}} \Psi = m \Psi, \quad (1.5)$$

with Ψ a wave functional describing the degrees of freedom of the valence quarks and any number of additional $q\bar{q}$ pairs and/or gluons. The complexity of the physical states in Eq. (1.5) or the richness of field configurations in the functional integral equation (1.2) impede quantitative computations of hadronic matrix elements and the hadronic spectrum, a goal pursued over more than two decades, utilizing in particular lattice calculations [3-5].

The QCD inequalities are derived by comparing expressions for different correlation functions (or the energies of different hadronic systems) *without* requiring explicit evaluation. We only need to assume that an appropriate regularization scheme and gauge fixing have been devised to make the path integral (or the Schrödinger problem) well defined.

A key ingredient in deriving relations between correlation functions is the positivity of the functional path integration measure $d\mu(A)$ obtained after integrating out the fermionic degrees of freedom. The bilinear $\sum_{i=1}^{N_f} \bar{\psi}_i (\not{D} + m_i) \psi_i$ part of \mathcal{L}_{QCD} then yields the determinantal factor

$$\text{Det} = \prod_{i=1}^{N_f} \text{Det}(\not{D} + m_i), \quad (1.6)$$

which for any vectorial (non-chiral) theory can be shown to be positive for any $A_\mu(x)$ (see Sec. 8) [6-10].

If the integrand in the path integral expression for one correlation function is greater than the integrand in another correlation function for all $A_\mu(x)$, then the positivity of the path integration measure guarantees that this feature persists for the integrated values. A rigorous inequality between the two correlation functions for all possible (euclidean) locations of the external currents will then follow.

For the particular case of two-point functions an inequality of the form

$$\langle 0|J_a(x)J_a^\dagger(y)|0\rangle \geq \langle 0|J_b(x)J_b^\dagger(y)|0\rangle \quad (1.7)$$

implies, via Eq. (1.4), the reversed inequality for the lowest mass physical states with the quantum numbers of $J_a(x), J_b(x)$:

$$m_a^{(0)} \leq m_b^{(0)}. \quad (1.8)$$

Most of the inequalities (1.7) involve the pseudoscalar currents ($J_a = \bar{\psi}_i \gamma_5 \psi_j$) and the corresponding mass inequalities (1.8) the pion (*i.e.* the lowest pseudoscalar states in the $\bar{u}\gamma_5 d, \bar{u}\gamma_5 u - \bar{d}\gamma_5 d, \bar{d}\gamma_5 u$ channels) [6]:

$$m^{(0)}(\text{any meson}) \geq m_\pi, \quad (1.9a)$$

$$m^{(0)}(\text{any baryon}) \geq m_\pi, \quad (1.9b)$$

$$m_{\pi^+} \geq m_{\pi^0}. \quad (1.9c)$$

The efforts to obtain inequalities in the Hamiltonian approach follow a similar general pattern. Rather than attempting to solve the QCD Schrödinger equation (1.5) for a particular channel, relations are sought between baryonic and/or mesonic sectors of different flavors $B_{ijk}, M_{i\bar{j}}$, and different spins.

Flavor enters the Lagrangian (1.1) only via the bilinear, local mass term. Comparison of masses (or other features) of mesons or baryons differing just by flavor may be easier than *ab initio* computations. The additive form of the mass term implies a relationship between the Hamiltonians obtained by restricting the full H_{QCD} to different flavor sectors. Using a variational principle for the ground state masses and *assuming flavor symmetric* ground state wave functions, these relations imply the inequalities

$$m_{ij}^{(0)} \geq \frac{1}{2} \left(m_{i\bar{i}}^{(0)} + m_{j\bar{j}}^{(0)} \right), \quad (1.10)$$

with $m_{ij}^{(0)}$ the ground state mass in the mesonic sector $M_{ij}^{(J^{PC})}$.

Physical color singlet states can be achieved in a variety of ways: the *mesonic* – $\bar{\psi}_i^a \psi_{ja}$; *baryonic* – $\epsilon_{abc} \psi_i^a \psi_j^b \psi_k^c$; *exotic* – $\epsilon_{de}^c \epsilon_{abc} \psi_i^a \psi_j^b \psi_k^d \psi_l^e$ (or *hybrid* – $\bar{\psi}_a \psi_b G_r \lambda^{r(ab)}$) configurations; or *glueballs* – $G^r G_r, f_{rst}$ (or d_{rst}) $G^r G^s G^t$ [Here $G_r = G_{\mu\nu}$ represents the chromo-electromagnetic antisymmetric field tensor. We use abc (rst) for triplet (octet) color indices; $\lambda^{r(ab)}$ are the Gell-Mann matrices; and $ijkl$ refer to flavors. We reserve $\alpha\beta\gamma$ for spinor indices, and $\lambda_{\mu\kappa}$ for vector Lorentz indices.] These configurations (mesonic, baryonic, *etc.*) differ dynamically by having different “color networks”. However, the different (non-glueball or hybrid) sectors contain quarks and/or antiquarks which are sources or sinks of chromoelectric flux of the same universal strength. This suggests that the QCD Hamiltonians in the different sectors may be related and mass relations of the type [11]

$$m_{\text{baryon}} \geq \frac{3}{2} m_{\text{meson}} \quad (1.11)$$

can be obtained.

The rigorous inequalities (1.9a) and (1.9b) derived via the euclidean path integral formulation amount to the well-known fact that the pion is the lightest hadron. These inequalities have, however, profound implications for the phase structure of QCD. Equation (1.9a) implies no spontaneous breaking of vectorial global (isospin) symmetries in QCD. Equation (1.9b), along with the 't Hooft anomaly matching condition, proves that the axial global flavor symmetry must be spontaneously broken.

It is important to note that the basic feature of positivity of the determinant factor (1.6) and the functional path integral measure $d\mu(A)$ is common to all gauge, QCD-like vectorial theories with Dirac fermions. This has far-reaching implications for composite models for quarks and leptons. A basic puzzle facing such models is the smallness of the masses of the composite quarks and leptons: $m_e \simeq m_u \simeq m_d \simeq \text{MeV}$ in comparison with $\Lambda_p \geq \text{TeV}$, the compositeness (“preonic”) scale. A natural mechanism for protecting (almost) massless composite fermions is an unbroken chiral symmetry. 't Hooft [12] and others [13], using the anomaly matching constraint, formulated some *necessary* conditions for such a realization of an underlying global chiral symmetry in the spectrum of the theory. Together with the mass inequalities, these conditions rule out all vectorial composite models for which fermion-boson mass inequalities like Eq. (1.9b) [or (1.11)] can be proven.

In this work we will mention, at one stage or another, most of the papers written on QCD inequalities, or on the related subject of inequalities in potential models. Particular attention will be paid to the seminal works of Weingarten [6], Vafa and Witten [7–9], and Witten [10] – all utilizing the euclidean path integral approach. Weingarten proved the inequalities (1.9a) and (1.9b) and pointed out the relevance of (1.9b) to spontaneous chiral symmetry breaking ($S\chi SB$) in QCD. Vafa and Witten directly used the measure positivity to prove that parity and global vectorial symmetries like isospin do not break spontaneously [7,8]. Finally Witten [10] proved (1.9c) and the interflavor relation (1.10) which holds rigorously for the case of pseudoscalars, with no need for the flavor symmetry assumption.

To date, QCD inequalities have been mentioned in approximately 600 papers. Most authors were concerned with symmetry breaking patterns, the motivation for the Vafa-Witten paper [7], which is cited most often. Here we equally emphasize the other facet of the inequalities, which constitute useful, testable, constraints on observed (and yet to be discovered) hadrons. This is why we elaborate on the baryon-meson mass inequalities and related inequalities for the exotic sector despite the fact that we have not been able to prove them via the rigorous euclidean path integral approach; and on the inequalities between mesons of different flavors, which cannot be justified without the additional specific assumption of flavor symmetric mesonic wave function(al)s.

In general we will follow a didactic rather than a chronological approach. We start in Sec. 2 by deriving Eq. (1.10) using a simple potential model [14] and the flavor symmetry assumption. This is followed up in Sec. 3 by a potential model derivation of the baryon-meson mass inequalities (1.11) [11,15,16], and a discussion of baryon-baryon mass inequalities in Sec. 4. In Secs. 5 and 6 and App. C we show that these relations may be valid far beyond the simple potential model [11,17]. The elegant analysis of E. Lieb [18] of the potential model approach is also reproduced in some detail in App. B. Section 7 concludes the first part of this review which utilizes the Hamiltonian variational approach by verifying that the inequalities indeed hold in the approximately forty cases where they can be tested, and by presenting lower bounds to the masses of new, yet to be discovered, mesonic and baryonic states.

The middle part of the review focuses on the rigorous euclidean path integral approach. We start in Sec. 8 by proving the positivity of the measure and the ensuing inequalities (1.9), stating that the pseudoscalar pion is the lightest meson. We illustrate the power of these inequalities in Sec. 9 where $m_{u\bar{d}}^{(0^+)} \geq m_{u\bar{d}}^{(0^-)}$ is used as a shortcut to motivate the Vafa-Witten theorem on non-breaking of isospin (which is then presented in some detail). We proceed in Sec. 10 with Weingarten’s proof of the pion-nucleon mass inequality [Eq. (1.9b)] and in Sec. 11 indicate how it can be utilized to prove $S\chi SB$ and discuss its implication for composite models of quarks and leptons. Section 12 presents Witten’s proofs of Eq. (1.9c) and of the flavor mass inequality for pseudoscalars. We present also an alternate derivation of Eq. (1.9c) [19]. The beautiful Vafa-Witten argument [8] for non-spontaneous breaking of parity in QCD is presented in Sec. 13. Section 14 is concerned with the inequalities in the large N_c limit of QCD [20]. Section 15 is devoted to the glueball sector [21], and Sec. 16 discusses inequalities in the continuum meson-meson sector and for exotic states; in particular we also discuss extensions to two-point functions involving local quark combinations of a quartic degree [22,23]. In Sec. 17 we discuss extensions to finite temperature, finite chemical potential, and external electromagnetic fields. In Sec. 18 we discuss the constraints implied by QCD for the chiral Lagrangian approach, and also discuss the utilization of QCD inequalities to constrain the $\bar{Q}Q$ potential $V(R)$ in heavy quarkonium states, quark mass ratios, and weak matrix elements. Finally Sec. 19 discusses extensions beyond two-point functions.

Towards the end of the review we adopt a more heuristic approach, applying QCD inequality-like relations to four and five particle states in App. F and to electromagnetic effects on scattering lengths in App. G. We discuss some applications of the inequalities in atomic, chemical, and biological contexts in App. H. Also in Sec. 14, we use the large N (planar) limit to extend the interflavor meson mass inequalities which were rigorously proven only for the pseudoscalar channel [10] to other cases. Sections 14, 15, 16, and also Apps. C, D, F, G, and H constitute mostly new, unpublished material. Section 20 includes a short summary. We also present two new conjectures concerning the possible utilization of the ferromagnetic character of the QCD euclidean Lagrangian, and a possible monotonic behavior of mass ratios with the number of quark flavors N_f , as well as inequalities for quantities other than hadronic masses.

2. DERIVATION OF FLAVOR MASS RELATIONS IN A SIMPLE POTENTIAL MODEL

We first discuss the inequalities in a simple potential “toy model” [14,17,18,24–26], which contains some features of the full-fledged QCD problem. Specifically the interactions – represented here by the potentials – are flavor independent, and all flavor dependence is manifested only via the masses in the kinetic term.

Let us consider a two-body system described by the Hamiltonian

$$H_{12} = T_1 + T_2 + V_{12} . \tag{2.1}$$

For a nonrelativistic Schrödinger equation, the kinetic terms are

$$T_1 = \frac{\vec{p}_1^2}{2m_1}, \quad T_2 = \frac{\vec{p}_2^2}{2m_2} \quad (2.2)$$

with $m_{1,2}$ the masses of particles 1 and 2. We assume that the potential V depends only on the relative coordinate $\vec{r} = \vec{r}_1 - \vec{r}_2$ (translational invariance), and we also take $V = V(|\vec{r}|) = V(r)$ only to ensure rotational invariance.

We can separate the motion of the center of mass:

$$\begin{aligned} \psi &= e^{i\vec{P}\cdot\vec{R}}\psi_{12}(\vec{r}) \\ \vec{R} &= \frac{m_1\vec{r}_1 + m_2\vec{r}_2}{m_1 + m_2} \\ \vec{r} &= \vec{r}_1 - \vec{r}_2, \end{aligned}$$

and write H_{12} as

$$H_{12} = \frac{\vec{P}^2}{2M} + \frac{\vec{p}^2}{2\mu} + V_{12}(r) \equiv \frac{\vec{P}^2}{2M} + h_{12}, \quad (2.3)$$

with $\vec{P} = \vec{p}_1 + \vec{p}_2$, $\vec{p} = \vec{p}_1 - \vec{p}_2$, $M = m_1 + m_2$, and $\mu = \frac{m_1 m_2}{m_1 + m_2}$. For the subsequent discussion we will specialize to $\vec{P} = 0$, *i.e.* to the center of mass system (CMS).

We will be interested in the bound states of h_{12} satisfying

$$\begin{aligned} h_{12}\psi_{12} &= \epsilon_{12}\psi_{12} \\ h_{12} &= \frac{\vec{p}^2}{2\mu} + V_{12}(r) = \frac{\vec{p}^2}{2m_1} + \frac{\vec{p}^2}{2m_2} + V_{12}(r) \equiv \frac{\vec{p}^2}{2m_1} + \frac{\vec{p}^2}{2m_2} + V(r), \end{aligned} \quad (2.4)$$

with $\psi_{12} = \psi_{12}(\vec{r})$ a normalized ($\int d^3r \psi_{12}^2(\vec{r}) = 1$) state. (We assume that such bound states exist.)

We can next consider two additional systems with identical potentials $V_{11}(r) = V_{22}(r) = V(r)$, but made of two particles with the same mass m_1 (or m_2)

$$\begin{aligned} h_{11} &= \vec{p}^2 \left(\frac{1}{2m_1} + \frac{1}{2m_1} \right) + V(r) \\ h_{22} &= \vec{p}^2 \left(\frac{1}{2m_2} + \frac{1}{2m_2} \right) + V(r). \end{aligned} \quad (2.5)$$

To mimic the QCD problem, with quark-antiquark bound states, we still take the particles as non-identical so as to avoid issues of statistics.

Let $\epsilon_{12}^{(0)}, \epsilon_{11}^{(0)}, \epsilon_{22}^{(0)}$ be the ground state energies for the three Hamiltonians

$$h_{ij}\psi_{ij}^{(0)}(\vec{r}) = \epsilon_{ij}^{(0)}\psi_{ij}^{(0)}(\vec{r}). \quad (2.6)$$

We wish to derive the relation

$$\epsilon_{12}^{(0)} \geq \frac{1}{2} \left(\epsilon_{11}^{(0)} + \epsilon_{22}^{(0)} \right). \quad (2.7)$$

Equations (2.4) and (2.5) imply the operator identity

$$h_{12} = \frac{1}{2} (h_{11} + h_{22}). \quad (2.8)$$

Let us take the diagonal matrix element of both sides of this equation with $\psi_{12}^{(0)}$, the ground-state wave function of h_{12} . We then have

$$\langle \psi_{12}^{(0)} | h_{12} | \psi_{12}^{(0)} \rangle = \epsilon_{12}^{(0)} = \frac{1}{2} \left(\langle \psi_{12}^{(0)} | h_{11} | \psi_{12}^{(0)} \rangle + \langle \psi_{12}^{(0)} | h_{22} | \psi_{12}^{(0)} \rangle \right). \quad (2.9)$$

By the variational principle [27] each of the expectation values on the right-hand side exceeds $\epsilon_{11}^{(0)}$ (or $\epsilon_{22}^{(0)}$) respectively, which are minima of $\langle \psi | h_{11} | \psi \rangle$ and $\langle \psi | h_{22} | \psi \rangle$ with $\psi = \psi_{11}^{(0)}$ and $\psi = \psi_{22}^{(0)}$. Thus Eq. (2.7) is obtained.

The previous discussion has been carried out in the CMS frame, $\vec{P}_{\text{total}} = 0$. In this frame, upon adding the rest masses $m_1 + m_2$ to $\epsilon_{12}^{(0)}$, *etc.*, the inequality (2.7) translates into an inequality for the total masses of the bound states:

$$m_{12}^{(0)} \geq \frac{1}{2} \left(m_{11}^{(0)} + m_{22}^{(0)} \right). \quad (2.10)$$

Also in this frame total angular momenta are the spins of the composites.

Let us now make the following observations which will also be very useful for the discussion of Sec. 5:

1. The addition of the two Hamiltonians h_{11} and h_{22} and their comparison with h_{12} may appear to present some formal difficulties. In nonrelativistic physics we have a super-selection rule for different masses. Hence strictly speaking h_{11} , h_{22} , and h_{12} operate in different Hilbert spaces consisting of states with the (1,1), (2,2), and (1,2) pairs of particles respectively. However, the crucial observation is that these are *identical* spaces. All the Hamiltonians h_{11} , h_{22} , h_{12} (or any other h_{ij}) which are written in terms of \vec{r} and \vec{p} can, therefore, be made to operate on the common generic Hilbert space of wave functions $\psi(\vec{r})$. The mass dependence is explicit in h_{ij} . It happens to be additive and therefore Eq. (2.8) is a meaningful and useful operator identity.

2. The above generic space can be block diagonalized by using the symmetries of the Hamiltonians h_{ij} . Thus for the case of central potentials, we consider separately subspaces with given total angular momentum l and solve

$$h_{ij}\psi_{ij}^{(l)} = \epsilon_{ij}^{(l)}\psi_{ij}^{(l)}. \quad (2.11)$$

The projection operator P_l used in $P_l h_{ij} (P_l)^\dagger \equiv h_{ij}^{(l)}$ can be expressed in terms of \vec{r} and \vec{p} only, and is independent of the masses. Thus P_l simultaneously projects into the l subspace every term in Eq. (2.8):

$$h_{12}^{(l)} = \frac{1}{2} \left(h_{11}^{(l)} + h_{22}^{(l)} \right). \quad (2.12)$$

Using the same arguments as above, we can deduce that

$$\epsilon_{12}^{l(0)} \geq \frac{1}{2} \left(\epsilon_{11}^{l(0)} + \epsilon_{22}^{l(0)} \right) \quad (2.13)$$

holds for the ground states in each l -wave separately.

3. To the extent that heavy quarkonium systems can be treated via a nonrelativistic Schrödinger equation approximation, with negligible spin effects, the above derivation would indeed directly suggest mass relations such as $m_{c\bar{c}}^{(0)} \geq \frac{1}{2} \left(m_{c\bar{c}}^{(0)} + m_{b\bar{b}}^{(0)} \right)$.

4. The inequalities (2.7) and (2.13) are obtained by taking just one particular matrix element of the operator relation (2.8). Evidently the latter contains far more information. In particular one may wonder if the inequalities hold for excited states in each given l channel (*i.e.* for radial excitations).

The simple generalization, *e.g.* $\epsilon_{12}^{(1)} \geq \frac{1}{2} \left(\epsilon_{11}^{(1)} + \epsilon_{22}^{(1)} \right)$ for the first radially excited state is, in general, incorrect.

The point is that $\psi_{11}^{(1)}$, $\psi_{22}^{(1)}$ and $\psi_{12}^{(1)}$ should minimize the expectation values $\langle \psi | H_{11} | \psi \rangle$, $\langle \psi | H_{22} | \psi \rangle$ and $\langle \psi | H_{12} | \psi \rangle$ respectively, subject to *different* constraints: $\psi_{11}^{(1)}$ should be orthogonal to $\psi_{11}^{(0)}$ *etc.* and the three ground state wave functions are in general different. However, such constraints can be avoided if we consider the two-dimensional space v_2 spanned by the first *and* second excited states. The variational principal (for h_{ij}) tells us that $\langle \psi^{(0)} | h_{ij} | \psi^{(0)} \rangle + \langle \psi^{(1)} | h_{ij} | \psi^{(1)} \rangle = \epsilon_{ij}^{(0)} + \epsilon_{ij}^{(1)}$ is the minimal value that $\text{tr}_{v_2} h_{ij}$ can achieve when we consider all possible two-dimensional subspaces $\epsilon_{ij}^{(0)} + \epsilon_{ij}^{(1)} = \min_{v_2} \text{tr} h_{ij}$. More generally we have for the sum of the ground state and the first $n-1$ excited states: $\epsilon_{ij}^{(0)} + \epsilon_{ij}^{(1)} + \dots + \epsilon_{ij}^{(n-1)} = \min_{v_n} \text{tr} h_{ij}$, where the trace is now to be minimized over all n -dimensional subspaces v_n . Considering then the operator relation $h_{12} = \frac{1}{2} (h_{11} + h_{22})$ and taking the trace of both sides in the space $v_n^{1,2}$ which minimizes $\text{tr}_{v_n} h_{12}$, we conclude that

$$\begin{aligned} \epsilon_{12}^{(0)} + \epsilon_{12}^{(1)} + \dots + \epsilon_{12}^{(n-1)} &\geq \frac{1}{2} \left[(\epsilon_{11}^{(0)} + \epsilon_{11}^{(1)} + \dots + \epsilon_{11}^{(n-1)}) \right. \\ &\quad \left. + (\epsilon_{22}^{(0)} + \epsilon_{22}^{(1)} + \dots + \epsilon_{22}^{(n-1)}) \right], \end{aligned} \quad (2.14)$$

with the summation extending up to any one of the radially excited states.

5. It is amusing to see how the inequalities work in familiar cases. For the Coulomb potential the ground state bindings are

$$\begin{aligned} B_{ij}^{(0)} &= \frac{1}{2}\mu_{ij}\alpha^2 = \frac{1}{2}\left(\frac{m_i m_j}{m_i + m_j}\right)\alpha^2 \\ B_{ii}^{(0)} &= \frac{1}{2}\left(\frac{m_i}{2}\right)\alpha^2 \\ B_{jj}^{(0)} &= \frac{1}{2}\left(\frac{m_j}{2}\right)\alpha^2. \end{aligned} \tag{2.15}$$

Obviously, $B_{ij}^{(0)} \leq \frac{1}{2}(B_{ii}^{(0)} + B_{jj}^{(0)})$ so that the masses of the corresponding states satisfy the desired inequality

$$m_{ij}^{(0)} = m_i + m_j - B_{ij}^{(0)} > \frac{1}{2}(m_{ii}^{(0)} + m_{jj}^{(0)}) . \tag{2.16}$$

Next, consider the harmonic oscillator potential, $\frac{1}{2}Kr^2$, as a prototype of a confining potential. The ground state energies, measured with respect to the minimum of the potential well, are

$$\epsilon_{ij}^{(0)} = \frac{\hbar}{2}\omega_{ij}^{(0)} = \frac{\hbar}{2}\sqrt{\frac{K}{\mu_{ij}}} = \frac{\hbar}{2}\sqrt{K\left(\frac{1}{m_i} + \frac{1}{m_j}\right)} .$$

We therefore have $(\epsilon_{ij}^{(0)})^2 = \frac{1}{2}[(\epsilon_{ii}^{(0)})^2 + (\epsilon_{jj}^{(0)})^2]$ which implies by simple algebra that

$$\epsilon_{ij}^{(0)} \geq \frac{1}{2}(\epsilon_{ii}^{(0)} + \epsilon_{jj}^{(0)}) , \tag{2.17}$$

and upon adding the rest masses:

$$m_{ij}^{(0)} \geq \frac{1}{2}(m_{ii}^{(0)} + m_{jj}^{(0)}) . \tag{2.18}$$

We note in passing that the energies for these two systems happen to have quantization rules of the form $\epsilon^{(n)} = f(n)\epsilon^{(0)}$, where $f(n)$ is independent of μ , the reduced mass.¹ Specifically, $f(n) = -\frac{1}{(n+1)^2}$ and $(2n+1)$ for the two cases. Hence all the above inequalities happen to hold separately for each of the excited states $\epsilon_{ij}^{(n)}$, $\epsilon_{ii}^{(n)}$, and $\epsilon_{jj}^{(n)}$.

6. While the above discussion was in the framework of a nonrelativistic Schrödinger equation, the result (2.17) holds in a far more general context. The particular form of the kinetic energy $T_i = \frac{\vec{p}^2}{2m_i}$ did not play any role in deriving the operator relation (2.8). Hence T_i could have an arbitrary p dependence. In particular, we can take $T_i = \sqrt{\vec{p}^2 + m_i^2}$, the expression appropriate for relativistic motion.

The key ingredient was that the potentials V_{12}, V_{11} , and V_{22} are all the *same*, *i.e.* that we have “flavor independent interactions”. However, besides the requirement of translational (and preferably also rotational) invariance, the “potential” is not restricted. Thus, V need not depend on \vec{r} alone, but could have arbitrary dependence on \vec{r} and \vec{p} . The only aspect we have to preserve is that $h_{ij} = T_i + T_j + V_{ij}$ so that $h_{ij} = \frac{1}{2}(h_{ii} + h_{jj})$.

Nonrelativistic quark models have potentials with some explicit flavor (quark mass) dependence, *e.g.* in the “hyperfine interaction” [28]:

$$V_{ij}^{\text{HF}} = \frac{(\lambda_i \cdot \lambda_j)}{m_i m_j} (\sigma_i \cdot \sigma_j) \delta^3(\vec{r}) . \tag{2.19}$$

In Sec. 5 we show that in the full-fledged theory we still have an operator relation

$$H_{i\bar{j}} + H_{k\bar{l}} = H_{i\bar{l}} + H_{k\bar{j}} , \tag{2.20}$$

¹This feature stems from the fact that these potentials have a power law behavior, r^α , in which case $\epsilon^{(n)} = f(n)$ is clearly manifest in the semiclassical WKB limit.

with H_{ij} being the QCD Hamiltonian restricted to a particular flavor sector. With $i = k, j = l$ the last relation reduces to

$$H_{i\bar{j}} + H_{j\bar{i}} = H_{i\bar{i}} + H_{j\bar{j}}, \quad (2.21)$$

which is very reminiscent of Eq. (2.8) and, to the extent that the wave functions $\psi_{i\bar{j}}$ are *symmetric* in flavor, again leads to the same conclusion.

One may also avoid the mass dependent $\vec{s}_1 \cdot \vec{s}_2$ or $\vec{s} \cdot \vec{L}$ interactions by considering the ‘‘centers of mass’’ of the various multiplets, *e.g.* $(3m_\rho + m_\pi)/4$, representing the mass values prior to hyperfine splittings and applying the inequalities to these combinations [15,16].

We note that the hyperfine interaction is strongly attractive for the spin singlet pseudoscalar meson case. Since furthermore $m_1^{-2} + m_2^{-2} \geq 2(m_1 m_2)^{-1}$, this extra binding enhances the inequality (2.7) derived for the spin independent part of the interaction. Indeed, the only case for which relation (2.7) was proved by utilizing the rigorous euclidean correlation function approach, is that of the pseudoscalar mesons [10].

3. BARYON-MESON MASS INEQUALITIES IN THE GLUON EXCHANGE MODEL

The simple ‘‘quark counting rules’’ relating meson and baryon total cross-sections [29,30] and masses [31] were early indications for the relevance of the quark model [32,33]. If the mass of a ground state hadron is just the sum of the masses of its quark constituents, then

$$2m_{ijk}^{(0)} = m_{i\bar{j}}^{(0)} + m_{j\bar{k}}^{(0)} + m_{k\bar{i}}^{(0)}, \quad (3.1)$$

with $m_{ijk}^{(0)}$ the mass of the ground state baryon consisting of quarks q_i, q_j, q_k ; and $m_{i\bar{j}}^{(0)}$ the mass of the lowest lying $q_i \bar{q}_j$ meson. The following discussion motivates a related QCD inequality [11,15,18,34]

$$2m_{ijk}^{(0)} \geq m_{i\bar{j}}^{(0)} + m_{j\bar{k}}^{(0)} + m_{k\bar{i}}^{(0)}. \quad (3.2)$$

The particular variant $m_N \geq m_\pi$ was derived by Weingarten [6] from the correlation function inequalities, and will be discussed in Sec. 10.

If qq ($q\bar{q}$) interactions are generated via one gluon exchange, then the color structure is $V_{12} \propto \vec{\lambda}_1 \cdot \vec{\lambda}_2$, with $\vec{\lambda}$ a vector consisting of the $N^2 - 1$ Gell-Mann matrices of the fundamental SU(N) representation. In a meson the quarks $q_1 \bar{q}_2$ couple to a singlet and, using $\langle \dots \rangle$ to indicate expectation values,

$$0 = \langle (\vec{\lambda}_1 + \vec{\lambda}_2)^2 \rangle_{\text{meson}} = 2\vec{\lambda}^2 + 2\langle \vec{\lambda}_1 \cdot \vec{\lambda}_2 \rangle_{\text{meson}}, \quad (3.3)$$

so that

$$\langle \vec{\lambda}_1 \cdot \vec{\lambda}_2 \rangle_M = -\vec{\lambda}^2. \quad (3.4)$$

Here $\vec{\lambda}^2 = \sum_{n=0}^{N^2-1} (\lambda_n)^2$, is a fixed diagonal $N \times N$ matrix proportional to the unit matrix. The SU(N) baryon is constructed as the color singlet, completely antisymmetric combination of N quarks

$$\epsilon_{a_1 \dots a_N} q^{a_1 \dots a_N}. \quad (3.5)$$

Thus

$$0 = \left\langle \left(\sum_i^N \lambda_i \right)^2 \right\rangle_B = N\vec{\lambda}^2 + \sum_{i \neq j}^N \langle \lambda_i \lambda_j \rangle_B = N\vec{\lambda}^2 + N(N-1) \langle \lambda_1 \cdot \lambda_2 \rangle_B, \quad (3.6)$$

where we used the fact that all the $N(N-1)$ expectation values $\langle \lambda_i \cdot \lambda_j \rangle_B$ are equal. Thus using Eq. (3.4) we find that

$$\langle \lambda_1 \cdot \lambda_2 \rangle_B = -\frac{1}{(N-1)} \vec{\lambda}^2 = \frac{1}{(N-1)} \langle \lambda_1 \cdot \lambda_2 \rangle_M. \quad (3.7)$$

This implies that the strength of the one gluon exchange interaction in the meson $q_i \bar{q}_j$ is, for QCD (*i.e.* $N = 3$), precisely twice the corresponding gluon exchange interaction for a $q_i q_j$ pair in a baryon.

Since $\langle \lambda_1 \cdot \lambda_2 \rangle_B = \frac{1}{2} \langle \lambda_1 \cdot \lambda_2 \rangle_M$ is just an overall relation of the color factors, we have the corresponding ratio of the pairwise interactions in the meson and in the baryon:

$$V_{i\bar{j}}(\cdots)_M = 2V_{ij}(\cdots)_B, \quad (3.8)$$

as long as the $q_i \bar{q}_j$ are in the same angular momentum, spin, radial state, *etc.* as the $q_i q_j$ in the baryon (or in the appropriate mixture of states).

For $N = 3$ and a general two-body interaction, we write the Hamiltonian describing the baryon as:

$$H_B = H_{ijk} = T_i + T_j + T_k + V_{ij}^B + V_{jk}^B + V_{ki}^B, \quad (3.9)$$

with T_i the kinetic, single-particle operators.

The $q_i q_j q_k$ baryonic system can be partitioned into $(2 + 1)$ subsystems in three different ways: $((ij), k), (i, (jk)), (j, (ki))$. Let us consider the three mesonic $q\bar{q}$ systems corresponding to these partitionings: $M_{i\bar{j}}, M_{j\bar{k}}, M_{k\bar{i}}$, composed of $(q_i \bar{q}_j), (q_j \bar{q}_k), (q_k \bar{q}_i)$. The Hamiltonians describing these mesons are

$$\begin{aligned} H_{i\bar{j}} &= T_i + T_j + V_{i\bar{j}}^M \\ H_{j\bar{k}} &= T_j + T_k + V_{j\bar{k}}^M \\ H_{k\bar{i}} &= T_k + T_i + V_{k\bar{i}}^M. \end{aligned} \quad (3.10)$$

From $V_{i\bar{j}}^M = 2V_{ij}^B$ *etc.* it is easy to verify the key relation

$$2H_{ijk} = H_{i\bar{j}} + H_{j\bar{k}} + H_{k\bar{i}} \quad (3.11)$$

between the Hamiltonian describing the baryon B_{ijk} and the three mesonic Hamiltonians corresponding to its diquark subsystems. Let us next take the expectation value of the last operator relation in the normalized ground state $\psi_{ijk}^{(0)}$ of the baryon at rest [to simplify the notation we suppress Lorentz (J^{PC}) quantum numbers]. The left hand side yields

$$2\langle \psi_{ijk}^{(0)} | H_{ijk} | \psi_{ijk}^{(0)} \rangle = 2m_{ijk}^{(0)}, \quad (3.12)$$

with $m_{ijk}^{(0)}$ the mass of the ground state baryon. The right hand side is

$$\langle \psi_{ijk}^{(0)} | H_{i\bar{j}} | \psi_{ijk}^{(0)} \rangle + \langle \psi_{ijk}^{(0)} | H_{j\bar{k}} | \psi_{ijk}^{(0)} \rangle + \langle \psi_{ijk}^{(0)} | H_{k\bar{i}} | \psi_{ijk}^{(0)} \rangle. \quad (3.13)$$

The matrix elements of the two-body operators in the three-body wave function, *e.g.* $\langle \psi_{ijk}^{(0)} | H_{i\bar{j}} | \psi_{ijk}^{(0)} \rangle$, are evaluated by considering $H_{i\bar{j}}$ as a three-body operator which is just the identity for quark k . Thus we view ψ_{ijk} , for fixed coordinates of the quark q_k , as a two-body $(q_i q_j)$ wave function $\tilde{\psi}_{(ij)}^{(k)}$, and compute $\langle \tilde{\psi}_{(ij)}^{(k)} | H_{i\bar{j}} | \tilde{\psi}_{(ij)}^{(k)} \rangle$. Finally, this is integrated over all values of the coordinates of q_k .

The key observation is that $\tilde{\psi}_{(ij)}^{(k)}$, the two-body wave function prescribed by $\psi_{ijk}^{(0)}$, is, in general, different from $\psi_{(ij)}^{(0)}$, the ground state wave function of the meson $q_i q_j$. By the variational principle the latter wave function minimizes the expectation value of $H_{i\bar{j}}$, the mesonic Hamiltonian:

$$\min_{\tilde{\psi}_{i\bar{j}}} \langle \tilde{\psi}_{i\bar{j}} | H_{i\bar{j}} | \tilde{\psi}_{i\bar{j}} \rangle = \langle \psi_{i\bar{j}}^{(0)} | H_{i\bar{j}} | \psi_{i\bar{j}}^{(0)} \rangle = m_{i\bar{j}}^{(0)}, \quad (3.14)$$

where $m_{i\bar{j}}^{(0)}$, the energy of the state at rest, is the mass of the ground state $q_i q_j$ meson. Hence we have

$$\langle \tilde{\psi}_{i\bar{j}}^{(k)} | H_{i\bar{j}} | \tilde{\psi}_{i\bar{j}}^{(k)} \rangle \geq m_{i\bar{j}}^{(0)} \quad (3.15a)$$

and likewise

$$\langle \tilde{\psi}_{j\bar{k}}^{(i)} | H_{j\bar{k}} | \tilde{\psi}_{j\bar{k}}^{(i)} \rangle \geq m_{j\bar{k}}^{(0)} \quad (3.15b)$$

$$\langle \tilde{\psi}_{k\bar{i}}^{(j)} | H_{k\bar{i}} | \tilde{\psi}_{k\bar{i}}^{(j)} \rangle \geq m_{k\bar{i}}^{(0)}. \quad (3.15c)$$

Since each of these inequalities persists after the normalized integration over the coordinates of the third quark [*e.g.* q_k for Eq. (3.15a)], we have,

$$\langle \psi_{ijk}^{(0)} | H_{i\bar{j}} | \psi_{ijk}^{(0)} \rangle \geq m_{i\bar{j}}^{(0)}, \text{ etc.} \quad (3.16)$$

Equating (3.12) and (3.13), the matrix elements of the left hand side and right hand side of the original operator relation, we arrive at the desired inequality (3.2) [11,15]. The following remarks elaborate on these inequalities and the conditions for their applicability.

1. We have not displayed the J^P quantum numbers of the baryonic ψ_{ijk} or the mesonic $\psi_{i\bar{j}}$ states. As indicated by the above construction of “trial” mesonic functions from the baryon wave function, $\psi_{i\bar{j}}$ must be in the J^P state (or in general, in a mixture of J^P states) prescribed by the original baryonic wave function $\psi_{ijk}^{(0)}$.

Consider first the Δ^{++} baryon. In the approximation where $L \neq 0$ components in the ground state wave function are ignored, the state with $J_z(\Delta^{++}) = 3/2$ consists of three up quarks with parallel spins: $u \uparrow u \uparrow u \uparrow$, with the arrow indicating spin direction. Each of the $\psi_{i\bar{j}}^{(0)}$ will be, in this case, $u \uparrow \bar{u} \uparrow$, in a spin triplet state ρ or ω . The inequality reads

$$m_{\Delta^{++}} \geq \frac{3}{2} m_\rho \text{ (or } m_\omega) \quad (ijk = u \uparrow u \uparrow u \uparrow). \quad (3.17)$$

Likewise,

$$m_{\Omega^-} \geq \frac{3}{2} m_\phi \quad (ijk = s \uparrow s \uparrow s \uparrow) \quad (3.18a)$$

$$2m_{\Xi^0} \geq 2m_{K^*} + m_\phi \quad (ijk = s \uparrow s \uparrow u \uparrow) \quad (3.18b)$$

$$2m_{\Sigma^+} \geq 2m_{K^*} + m_\rho \quad (ijk = u \uparrow u \uparrow s \uparrow). \quad (3.18c)$$

The situation is different for the $J = 1/2$ (*i.e.* $S = 1/2$ in this $L = 0$ approximation) baryons such as the nucleon (see App. D). In this case the diquark systems are, on average, with equal probability in the $S = 0$ and $S = 1/2$ states, as can be readily verified from $\langle (s_1 + s_2 + s_3)^2 \rangle = \langle s_N^2 \rangle = 3/4$. [Strictly speaking, the uu diquark is pure triplet and the ud diquarks are in a triplet (singlet) state with probabilities $1/4$ ($3/4$), respectively.]

To see the effect of having a mixed rather than a pure trial mesonic state, we revert back to Eq. (3.15a). Instead of a single matrix element of $H_{i\bar{j}}$ in a specific $\tilde{\psi}_{i\bar{j}}^{(k)}$ state, we have, in general, a weighted sum of matrix elements corresponding to the mixture of two-body states generated from the three-body baryonic wave function:

$$\langle \psi_{ijk}^{(0)} | H_{i\bar{j}} | \psi_{ijk}^{(0)} \rangle = \sum_n c_n^2 \langle \psi_{i\bar{j}(n)}^{(k)} | H_{i\bar{j}} | \psi_{i\bar{j}(n)}^{(k)} \rangle. \quad (3.19)$$

Here n labels the different (J^P) states and c_n^2 are the normalized weights ($\sum_n c_n^2 = 1$).

The variational argument can be applied separately for each of the (trial) $\psi_{(n)}$ states and to their matrix elements $\langle \tilde{\psi}_{(n)} | H_{i\bar{j}} | \tilde{\psi}_{(n)} \rangle$ to obtain

$$\langle \psi_{ijk}^{(0)} | H_{i\bar{j}} | \psi_{ijk}^{(0)} \rangle \geq \sum_n c_n^2 m_{i\bar{j}(n)}. \quad (3.20)$$

For the specific case of the nucleon the weights of the qq singlet (triplet) configuration are $c_{s(qq)=1}^2 = c_{s(qq)=1/2}^2 = 1/2$. The corresponding $q\bar{q}$ states are the $\rho(\omega)$ and the π , and the inequality (3.20) (plus similar ones for the matrix elements of $H_{j\bar{k}}$ and $H_{k\bar{i}}$) yields:

$$2m_N \geq \frac{3}{2} (m_\pi + m_\rho). \quad (3.21)$$

Likewise by considering the Λ hyperon we find

$$2m_\Lambda \geq \frac{1}{2} [m_\pi + m_\rho + 3m_K + m_{K^*}]. \quad (3.22)$$

2. A simplified version of the inequalities applied just to the spin-averaged (“center of mass”) multiplets was suggested by Richard [15]. Note that unlike for the case of the meson-meson mass relation in Sec. 2, the baryon-meson mass inequalities do apply even when we have mass dependent $q_i q_j$ (or $q_i q_{\bar{j}}$) interactions such as the hyperfine and/or spin orbit interactions generated by one gluon exchange. The point is that the same flavor (mass) combinations $(ij), (jk), (ki)$ appear in both the diquark subsystems and in the mesons $M_{i\bar{j}}, M_{j\bar{k}},$ and $M_{k\bar{i}}$. Hence unlike the case of the meson-meson relation there is no motivation to consider only the above simplified version.

3. The above discussion utilized the nonrelativistic quark model with a one gluon exchange potential. We show next (and in Sec. 6) that the inequalities are valid in a vastly larger domain [11].

First we note that any vertex or propagator insertions into the one gluon exchange diagram leave the $\lambda_1 \cdot \lambda_2$ color structure intact (see Fig. 1). Such insertions generate a running coupling constant $\alpha(q^2)$ or $\alpha(r)$. Even if the non-perturbative effect of the propagator insertions can generate a confining potential [35,36] $V \sim \sigma r$, this potential still has the $\lambda_1 \cdot \lambda_2$ color structure, and the derivation of the inequalities still applies.

4. The most general two-body interaction [due to any number of gluon and $q\bar{q}$ exchanges; see Fig. 2] in the qq or $q\bar{q}$ system, has, from the t -channel point of view, a $\bar{3} \otimes 3 = 8 \oplus 1$ color structure. The octet part corresponds to the $\lambda_1 \cdot \lambda_2$ structure; the singlet to $1 \cdot 1$. Thus we need not assume that the important interactions are due to one gluon exchange. Rather, we have to assume that the octet, $\lambda_1 \cdot \lambda_2$ part of the full two-body interaction is dominant. We note that in the large N_c limit we expect the $\lambda_1 \cdot \lambda_2$ part to dominate over the $1 \cdot 1$ part.

5. The trilinear gluon couplings are a potential obstacle to having the operator relation (3.11) in a general setting. These couplings could yield genuinely nonseparable interactions in the nucleon of the type shown in Fig. 3. However, it turns out that the trigluon diagram vanishes in the baryon state. The relevant color factor is

$$f^{rst} \lambda_r^{aa'} \lambda_s^{bb'} \lambda_t^{cc'} \epsilon_{abc} \epsilon_{a'b'c'} ,$$

with $rst = 1, \dots, 8$; $abc (a'b'c') = 1, \dots, 3$ the adjoint and fundamental color indices, respectively. This color factor vanishes since an exchange $r \rightarrow s, a \rightarrow b, a' \rightarrow b'$ changes the sign of the summand. This cancellation is not modified by any further dressing of this diagram with more gluon exchanges.

6. The above discussion did not require any specific form of the one-body kinetic terms T_i . We could have the nonrelativistic $T_i = m_i + \frac{p_i^2}{2m_i}$, a relativistic $T_i = \sqrt{p_i^2 + m_i^2}$ form, or, by considering the operator relation (3.11) as a matrix in spinor space, also a Dirac $T_i = \not{p}_i + m_i$ form.

7. Just as for the meson-meson relation, we could use the variational principle in the space of the lowest n states to obtain a relation between masses of radially excited baryons and mesons analogous to Eq. (2.14).

8. A diquark in a baryon cannot annihilate into gluons. This is not the case, however, for the $u\bar{u}$ or $d\bar{d}$ in a meson. These annihilations are avoided by choosing $I = 1$ [*i.e.* ρ rather than ω in Eq. (3.17)] combinations.

9. A simple intuitive feeling for the deviation from equality expected in the baryon-meson relation has been offered by Cohen and Lipkin [37] (in a paper which predated the QCD inequalities). The point is that the diquark systems in the baryon are not at rest but recoil against the third quark with a typical momentum \vec{p} of a few hundred MeV/ c . Thus the trial meson wave functions correspond to a meson moving with $\vec{p} \neq 0$. Consequently

$$\begin{aligned} 2m_{ijk} &\geq E_{i\bar{j}} + E_{j\bar{k}} + E_{k\bar{i}} \\ &\approx \sqrt{m_{ij}^2 + \vec{p}_k^2} + \sqrt{m_{jk}^2 + \vec{p}_i^2} + \sqrt{m_{ki}^2 + \vec{p}_j^2} \geq m_{ij} + m_{jk} + m_{ki} . \end{aligned}$$

A more comprehensive investigation of the pattern of deviations from equality as a function of the quark masses, and in particular for logarithmic interquark potentials was recently performed by Imbo [38].

10. The baryon-meson relation can be easily extended via Eq. (3.7) to any number of colors N :

$$m_{B_{i_1 \dots i_N}}^{(0)} \geq \frac{1}{N-1} \sum_{a \neq b} m_{i_a \bar{i}_b}^{(0)} . \quad (3.23)$$

4. BARYON-BARYON MASS INEQUALITIES

The meson-meson mass inequalities above (see Sec. 2) follow in potential models only if the various two-body quark-antiquark potentials are independent of the quark masses. Baryon-baryon mass inequalities motivated by

similar convexity arguments were suggested [17] originally to also hold when all two-body quark-quark interactions are flavor-independent. It turns out however, that inequalities of the form

$$E^{(0)}(m, m, m) + E^{(0)}(m, M, M) \leq 2E^{(0)}(m, m, M) \quad (4.1)$$

do not hold in general [18,25,39]. As will be clearly indicated in Sec. 5, the key requirement for proving either meson-meson or baryon-baryon mass inequalities is the flavor symmetry of the ground state wave function. In the two-body, pure potential case, the relevant, relative coordinate wave function $\psi^{(0)}(\vec{r}), \vec{r} = \vec{r}_1 - \vec{r}_2$ is guaranteed to have the $\vec{r}_1 \leftrightarrow \vec{r}_2$ “flavor” symmetry. This however is not the case for three-body potential systems

$$H = T_1(\vec{p}_1) + T_2(\vec{p}_2) + T_3(\vec{p}_3) + V_{12}(\vec{r}_1 - \vec{r}_2) + V_{23}(\vec{r}_2 - \vec{r}_3) + V_{31}(\vec{r}_3 - \vec{r}_1). \quad (4.2)$$

Indeed even for flavor-independent potentials $V_{12} = V_{23} = V_{31}$, and simple nonrelativistic kinetic terms $T_i = \vec{p}_i^2/2m_i$, the ground state wave function $\psi^{(0)}(\vec{r}_1, \vec{r}_2, \vec{r}_3)$ is *not* (flavor) symmetric under interchange of $1 \leftrightarrow 2$, *etc.* As various counter examples show [18,39] (particularly the simplest one due to Lieb [18] which we present in App. A), for certain, rather “extreme” potentials $V_{ij}(r) = V(r)$, the kinematic asymmetry due to the different quark masses ($m_1 = m_3 = M, m_2 = m$) is strongly enhanced so that Eq. (4.1) fails. This notwithstanding, the elegant work of Lieb [18] has shown that the conjectured equation (4.1) does hold for a wide class of two-body potentials $V(\vec{r}_i, \vec{r}_j)$ for which the operator

$$L_\beta(\vec{x}, \vec{y}) = e^{-\beta V(\vec{x}, \vec{y})} \quad (4.3)$$

is positive semidefinite. The latter is equivalent, for $V = V(\vec{x} - \vec{y})$ and $L_\beta = L_\beta(\vec{x} - \vec{y})$, to a positive semidefinite Fourier transform of L_β . A sufficient condition for this is that $V(\vec{r}_i, \vec{r}_j) = V(\vec{r}_i - \vec{r}_j) = V(r)$ satisfies

$$V'(r) \geq 0 \quad (\text{monotonically increasing}) \quad (4.4a)$$

$$V''(r) \leq 0 \quad (\text{convex}) \quad (4.4b)$$

and

$$V'''(r) \geq 0. \quad (4.4c)$$

Interestingly for the case of heavy quarks (where potentials can be derived via the Wilson loop construction), Eqs. (4.4a) and (4.4b) can indeed be proven, as we will show in Sec. 18. Indeed all potentials used in quark model phenomenology to date satisfy all of Eqs. (4.4) and hence (4.3).

We present in App. B Lieb’s proof of Eq. (4.1) for positive semidefinite $\exp[-\beta V_{ij}(\vec{x}, \vec{y})]$. We do this in some detail, even elaborating somewhat beyond the original concise paper, since the baryon-baryon inequalities are indeed born out by data. Also, Lieb’s line of argument invoking the full three-particle Green’s function serves as a “bridge” between the Hamiltonian, variational, largely potential model motivated, first part of our review; and the more formal Lagrangian correlator inequalities proved via the path integral representation which is the approach of the second part.

5. RELATING MASSES IN DIFFERENT FLAVOR SECTORS

In the following we investigate the interflavor mass relations (2.18) in a lattice Hamiltonian formulation of QCD.

The conservation of quark flavors allows us to break the QCD Hilbert space into flavor sectors. Each flavor sector (U, D, S, C, \dots) consists of a net number U of up (u) quarks (U is negative for \bar{u} excess), D of down (d) quarks *etc.* with $U + D + \dots = 0 \pmod{3}$. We will be interested in the following “low” sectors:

1. $M^{(0)}$: The flavor vacuum $U = D = \dots = 0$. It consists of states with an arbitrary number of gluons and $(q_l \bar{q}_l)$ pairs.
2. $M_{(i\bar{j})}$, $i \neq j$: The meson sector, with an excess of one quark flavor of type i and a different antiquark flavor \bar{j} together with any number of gluons and $(q_l \bar{q}_l)$ pairs.
3. $B_{(ijk)}$: The baryon sector with a net excess of three quarks, q_i, q_j , and q_k .
4. $M_{(i\bar{j}k\bar{l})}$ ($i \neq j, i \neq l, k \neq j, k \neq l$): The exotic meson sector with a net excess of two quark flavors and two (different) antiquark flavors.

We will also discuss in Sec. 16 and App. F other sectors such as the pentaquark and hybrid sectors.

We can now define $H_{i\bar{j}}$ to be the QCD Hamiltonian restricted to the sector $M_{i\bar{j}}$; H_{ijk} the Hamiltonian restricted to B_{ijk} etc. The meson spectrum will be given by

$$H_{i\bar{j}}|\Psi_{i\bar{j}}\rangle = m_{i\bar{j}}|\Psi_{i\bar{j}}\rangle, \quad (5.1)$$

with Ψ a wave functional belonging to the $M_{i\bar{j}}$ sector. Similar equations hold in other sectors.

We show in App. C that [17]

$$H_{i\bar{j}} + H_{k\bar{l}} = H_{i\bar{l}} + H_{k\bar{j}}. \quad (5.2)$$

Particle masses are given by the Schrödinger equation, *e.g.*

$$H_{ij}|\Psi_{ij}\rangle = (m_{ij} + \Delta_0)|\Psi_{ij}\rangle, \quad (5.3)$$

with Δ_0 an additive, common constant representing the vacuum energy, *i.e.* the lowest energy obtainable for functionals in $M^{(0)}$. To ensure that Δ_0 is finite we restrict ourselves to finite lattices so that $\Delta_0 = V\epsilon_{\text{vac}}^{(0)}$, with V the volume and $\epsilon_{\text{vac}}^{(0)}$ the vacuum energy density. In writing Eq. (5.3) we assumed that the systems have no net translational motion.² Additional symmetries (rotations, parity, and for certain states, charge conjugations) could be used to project any desired state of given J^{PC} quantum numbers. To simplify notation, the J^{PC} labels are omitted. The lattice formulation reduces the symmetry from the full rotation to the cubic subgroup. However, the operator relations most likely also hold in the continuum limit where the full rotation symmetry is regained.

The $|\Psi_{ij}\rangle$ are wave functionals:

$$|\Psi_{ij}\rangle = \sum_{\text{configurations}} A_{(\text{conf})}^{ij} |(\text{conf})\rangle. \quad (5.4)$$

Even for a finite lattice the (discrete) summation includes infinitely many configurations characterized by the locations and spinors of all quarks and/or antiquarks and by $E_{\vec{n}, \vec{n}+\vec{\hat{\eta}}}^2$ at all links where the latter are constrained by Gauss' law [Eq. (C4)] (recall that arbitrarily high $SU(3)_C$ representations are *a priori* allowed). The specific flavor (ij) dependence enters only into the probability amplitudes $A_{(\text{conf})}^{ij}$ for finding a given configuration in $|\Psi_{ij}\rangle$. The generic configurations used in App. C have been defined in such a way so as to make operator relations such as Eq. (5.2) manifestly true. $|\Psi_{ij}\rangle$ is normalized:

$$\langle \Psi_{ij} | \Psi_{ij} \rangle = \sum_{\text{configurations}} |A_{(\text{conf})}^{ij}|^2 = 1. \quad (5.5)$$

A key observation is that the variational principle applies to wave functional solutions of the Schrödinger equation (5.3) much in the same way as it does to wave functions. In particular, the ground state $|\Psi_{ij}^{(0)}\rangle$ in any specific channel (say a mesonic ij channel with given J^{PC}) is given by the requirement that:

$$\Delta_0 + m_{ij} = \langle \Psi_{ij}^{(0)} | H_{ij} | \Psi_{ij}^{(0)} \rangle = \min \langle \Psi | H_{ij} | \Psi \rangle, \quad (5.6)$$

with the minimum sought in the space of all (normalized) $|\Psi_{ij}\rangle$ functionals with the given quantum numbers:

$$|\Psi\rangle = \sum_{\text{conf}} A_{\text{conf}} |(\text{conf} (\text{mesonic}))\rangle. \quad (5.7)$$

We would like next to argue that we can set $i = l, j = k$ in Eq. (5.2) and still obtain a meaningful operator relation

$$H_{i\bar{j}} + H_{j\bar{i}} = H_{i\bar{i}} + H_{j\bar{j}}. \quad (5.8)$$

²To ensure $\vec{P} = 0$, *i.e.* translational invariance, we need to sum over all locations of the centroid of the wave functional. For finite lattices of size L , only $P \leq 1/L$ seems achievable, yet for periodic boundary conditions a discrete version of translational invariance persists.

In the light (ud) quark sector $|m_u - m_d| \ll \Lambda_{\text{QCD}}$, and since $\alpha_{\text{EM}} \ll \alpha_{\text{QCD}}$, isospin is a good flavor symmetry. The $I = 1$ $|u\bar{u} - d\bar{d} + \text{gluons} + \text{pairs}\rangle$ states do not then mix with the $I = 0, M^{(0)}$ sector, so these states should then be used in deriving the inequalities. For heavier states $s\bar{s}, c\bar{c}, b\bar{b}$ there is a strong ‘‘Zweig rule’’ [32,40,41] suppression of $s\bar{s}, c\bar{c}, b\bar{b}$ annihilation. Hence mesonic sectors $M_{i\bar{i}}$ distinct from $M^{(0)}$ can be defined for which the $i = l, j = k$ version of Eq. (5.2), namely Eq. (5.8), holds.

Unfortunately, we *cannot* use this relation to obtain mass inequalities without further assumptions. In general, $\Psi_{i\bar{j}}^{(0)}$, the ground state wave functional for (for example) a heavy quark q_i and a light antiquark \bar{q}_j , may be *different* from $\Psi_{j\bar{i}}^{(0)}$, even though $\Psi_{i\bar{j}}$ and $\Psi_{j\bar{i}}$ are related by charge conjugation.³ Indeed one of the inequalities, namely $2m_{K^*} \leq m_\phi + m_\rho$, is not manifest. Symmetry is automatically guaranteed in the simple potential model where $\Psi_{i\bar{j}}^{(0)}$ depends only on $\vec{r} = \vec{r}_i - \vec{r}_j$, the relative coordinate of $q_i\bar{q}_j$. It is also plausible in a large N_c limit where the important degrees of freedom are the gluonic ones. In the following we will assume $i \leftrightarrow j$ symmetry.

By taking the expectation value of the left hand side of Eq. (5.8) in $\Psi_{i\bar{j}}^{(0)}$, we have $\langle \Psi_{i\bar{j}}^{(0)} | H_{i\bar{j}} + H_{j\bar{i}} | \Psi_{i\bar{j}}^{(0)} \rangle = 2m_{i\bar{j}}^{(0)} + 2\Delta_0$, and the variational argument for deriving the inequalities proceeds exactly as in Sec. 2. After cancelling a common $2\Delta_0$ term representing vacuum energy we obtain

$$2m_{i\bar{j}}^{(0)} \geq m_{i\bar{i}}^{(0)} + m_{j\bar{j}}^{(0)}. \quad (5.9)$$

We also have the relations for the sum of the first n excited states in any $M^{ij}(J^{PC})$ channel [Eq. (2.18)].

For the baryonic sector we readily find a relation

$$H_{ijr} + H_{klr} = H_{ilr} + H_{jkr}. \quad (5.10)$$

Eq. (5.10) is analagous to relation (5.2) and is obtained by adding a common ‘‘spectator’’ quark $r \neq i, j, k, l$.

Assuming a flavor symmetric baryon ground state, we obtain from variants of Eq. (5.10) with some of the flavor indices set equal to each other, analog convexity relations for baryonic states

$$m_{iij}^{(0)} \geq \frac{1}{2} [m_{iii}^{(0)} + m_{ijj}^{(0)}] \quad (5.11a)$$

$$m_{ijk}^{(0)} \geq \frac{1}{6} [m_{iij}^{(0)} + m_{iik}^{(0)} + m_{jji}^{(0)} + m_{jjk}^{(0)} + m_{kki}^{(0)} + m_{kkj}^{(0)}]. \quad (5.11b)$$

It should be emphasized [42] that for the baryonic case we have two relative CMS coordinates, and flavor symmetry of the wave function is not guaranteed even in the framework of a potential model. Indeed, as discussed in Sec. 4 and App. A, for certain extreme type of potentials one can show that the inequalities such as Eq. (5.8) are violated – though as elaborated in App. B, they do hold [18] for the class of potentials which are of interest in QCD.

6. BARYON-MESON INEQUALITIES IN A NON-PERTURBATIVE APPROACH

Inequalities relating masses of baryons and mesons were motivated in Sec. 3 via a potential model. It was suggested there that such inequalities may persist beyond the (dressed) one gluon exchange approximation. In this section we will employ a nonperturbative framework which still allows the application of variational arguments and the derivation of the baryon-meson mass inequalities [20].

It has been argued that confinement in QCD is the electric analog of the Meissner effect in a superconductor. The nonperturbative QCD vacuum develops a condensate of color monopole pairs and/or of large loops of magnetic flux [43–45]. More recently, lattice and other approaches have made this much more concrete, particularly in the context of ‘‘center vortices’’ [46,47]. In this vacuum, the chromoelectric flux emitted from a quark and ending on an antiquark is localized along a thin tube [48] – the analog of the magnetic vortex in the ordinary superconductor. In the $N \rightarrow \infty$ limit the chromoelectric flux tube may become infinitely thin [49] and the original dual string model [50–52] for hadrons could emerge. Also in the strong coupling limit of Hamiltonian lattice QCD a single set of minimally excited links of total minimum length connects the quarks and antiquarks in a single hadron.

³This important point (missed in Ref. [17]) will be further elaborated in the Summary section.

A more general approximation for the meson wave functional is a sum over configurations of strings [or chains of lattice links, see Fig. 4(a)] connecting q and \bar{q} (indicated by the symbol \rightsquigarrow below), with a probability amplitude for each configuration:

$$|\psi_{M12}\rangle = \sum_{1\rightsquigarrow 2} A(\rightsquigarrow)|\rightsquigarrow\rangle. \quad (6.1)$$

The end points 1,2 can also vary. The kinetic (B^2 and $\bar{\psi}D\psi$) parts of the QCD Hamiltonian move the string and the fermions at the end points, respectively; while the “potential” E^2 term gives a diagonal contribution proportional to the length (number of links) of the string multiplied by the string tension (weighted by the values of the second Casimir operator for the representation residing on each link).

In the same approximation, the baryon’s wave functional is a sum over configurations where the three E vortex lines (symbolized for convenience by Y in the following equation, though the vortices need not be straight) emanate from quarks 1, 2, and 3, and join together at a common “junction point” x [see Fig. 4(b)]:

$$|\psi_{B123}\rangle = \sum_Y A(Y)|Y\rangle. \quad (6.2)$$

Just as in the case of the nonrelativistic potential model, we would like to extract trial wave functionals for the ground states of the mesons $q_1\bar{q}_2$, $q_2\bar{q}_3$, and $q_3\bar{q}_1$ from the ground state baryon wave functional. This is achieved in the following way (see Fig. 5). We consider quarks 1 and 2, together with the string connecting them in the baryon as a possible configuration in the wave functional of the meson M_{12} . To this end we need to color conjugate the quark \bar{q}_2 and reverse the chromoelectric flux in the section $x - 2$. A detailed analysis using a lattice formulation indicates this can be done for the case of minimal flux strings, without effecting the matrix elements of the Hamiltonian. Likewise quarks 2 and 3 with the string $2 - x - 3$ are viewed as a possible configuration for the meson M_{23} and similarly for M_{31} .

This suggests the operator relation

$$2H_{ijk} = H_{i\bar{j}} + H_{j\bar{k}} + H_{k\bar{i}}, \quad (6.3)$$

with ijk the flavors of $q_1q_2q_3$. Indeed by applying $H_{i\bar{j}}$, $H_{j\bar{k}}$ and $H_{k\bar{i}}$ to each of the above mesonic configurations we see that each part of the baryonic Hamiltonian H_{ijk} is encountered twice. Thus the kinetic term and mass term ($\mathcal{D}_1 + m_1$) associated with the motion of $q_1 (= q_i)$ occurs in both $H_{i\bar{j}}$ and $H_{k\bar{i}}$, and so does the kinetic and potential energy associated with the motion, and total length, of the string bit \rightsquigarrow connecting quark q_i with the junction point x . A similar argument can be applied to the $2 - x$ and $3 - x$ string bits.

Let us next take the expectation value of Eq. (6.3) in the ground state wave functional of the baryon at rest. As in Sec. 3, we obtain one one hand simply $2m_{ijk}^{(0)}$ and on the other hand the sum of the expectation values of $H_{i\bar{j}}$, $H_{j\bar{k}}$ and $H_{k\bar{i}}$ in the mesonic wave functionals extracted, in the manner described above, from the baryon’s ground state wave functional. In analogy to fixing the coordinates of the “third quark” (say q_k) in the potential model discussion of Sec. 3, we fix in each case the string bit ($x - q_k$ for $H_{i\bar{j}}$) which should be ignored in order to form a mesonic ($M_{i\bar{j}}$) trial wave functional. The expectation values of $H_{i\bar{j}}$ in these trial wave functionals

$$|\psi_{ijk}^t\rangle = \sum_Y A(Y)|Y\rangle \quad (6.4)$$

are then integrated with the weight implied by the original baryonic amplitude $A(Y)$ over the “ignored” section as well.

Note that because of the special character of the baryonic state, the configurations in the trial wave functional (6.4), used here for the three mesonic $q_i\bar{q}_j$, $q_j\bar{q}_k$, $q_k\bar{q}_i$ ground states, are in fact correlated. Specifically, the strings (or flux lines) associated with all three of these meson states are forced to have a common junction point x (which again is integrated over at the end).

This extra constraint only reinforces the general result of the variational principle, namely that

$$\langle\psi_{ijk}^{(0)}|H_{i\bar{j}}|\psi_{ijk}^{(0)}\rangle \geq m_{i\bar{j}}^{(0)} \quad (6.5a)$$

$$\langle\psi_{ijk}^{(0)}|H_{j\bar{k}}|\psi_{ijk}^{(0)}\rangle \geq m_{j\bar{k}}^{(0)} \quad (6.5b)$$

$$\langle\psi_{ijk}^{(0)}|H_{k\bar{i}}|\psi_{ijk}^{(0)}\rangle \geq m_{k\bar{i}}^{(0)}. \quad (6.5c)$$

Specifically these inequalities state that the mesonic trial wave functionals extracted from the subsystems of the baryon's ground state wave functional are not optimized so as to minimize the energy of the mesonic subsystems. Rather $\psi_{ijk}^{(0)}$ is constructed so as to minimize the expectation value of H_{ijk} and

$$\langle \psi_{ijk}^{(0)} | H_{ijk} | \psi_{ijk}^{(0)} \rangle = m_{ijk}^{(0)}. \quad (6.6)$$

Thus we have from Eq. (6.3) the required inequality

$$2m_{ijk}^{(0)} \geq m_{ij\bar{j}}^{(0)} + m_{j\bar{k}}^{(0)} + m_{k\bar{i}}^{(0)}. \quad (6.7)$$

It is amusing to see how this inequality is realized for the strong coupling limit. The flux then proceeds in straight lines in both the mesons and the baryons so as to minimize the total string length. This yields the potentials $V_{12} = \sigma|\vec{r}_1 - \vec{r}_2|$, $V_{23} = \sigma|\vec{r}_2 - \vec{r}_3|$, $V_{31} = \sigma|\vec{r}_3 - \vec{r}_1|$ for the meson and the genuine three-body interaction [53]

$$V_{123} = \min_x \sigma(|\vec{r}_1 - \vec{x}| + |\vec{r}_2 - \vec{x}| + |\vec{r}_3 - \vec{x}|)$$

(with the total length of the Y-shaped string configuration minimized over the choice of function point \vec{x}) for the baryon. The inequality reduces in this case simply to $2V_{123} \geq V_{12} + V_{23} + V_{31}$ which is just a sum of three triangular inequalities: $|\vec{r}_1 - \vec{x}| + |\vec{r}_2 - \vec{x}| \geq |\vec{r}_1 - \vec{r}_2|$ *etc.* (see Fig. 6). Since the potentials are linear for both systems, the virial theorem implies that the total energy is given by $2\langle V \rangle$, with $\langle V \rangle$ the expectation value of the potential energy, and $2E_{123} \geq E_{12} + E_{23} + E_{31}$.⁴

We have so far considered the approximation in which the quarks are connected by a single set of minimally excited links on the lattice or by a single Y-type configuration for the baryons. We still have many paths of different lengths. All of these configurations can be generated by repeated application of the kinetic (B^2) term in the Hamiltonian which generates a closed flux line around a plaquette and shifts the initial flux line as indicated in Fig. 7. The problem of finding the mesonic or baryonic ground state wave functionals, even in this approximation, is intractable, and at best we could hope for some numerical results. We would like to point out, however, that the baryon-meson inequalities can be proven in an even broader context when $q\bar{q}$ pair creation, bifurcation of flux lines, and excitation of links to higher $SU(3)_C$ representations are all allowed.

If we consider the procedure for extracting mesonic trial wave functionals from the baryonic wave functional, we can pinpoint the crucial ingredient for deriving Eq. (6.3). It is that the network of links in any configuration in the baryonic wave functional includes only one junction point x , where we can separate the network into three "patches" P_1, P_2 , and P_3 connected to the external quarks q_i, q_j , and q_k respectively (see Fig. 8). We consider $P_1\bar{P}_2$, where \bar{P}_2 is the patch with all flux flows reversed and $q_j \rightarrow \bar{q}_j$, as a configuration in the trial meson functional $|\psi_{Mij\bar{j}}\rangle$ with an amplitude $A(P_1, P_2, P_3)$, (P_3 fixed) inferred from the baryonic wave functional. Likewise P_2, \bar{P}_3 and P_3, \bar{P}_1 offer trial wave functionals for the $q_2\bar{q}_3(q_j\bar{q}_k)$ and $q_3\bar{q}_1(q_k\bar{q}_i)$ mesonic systems. We can easily verify that the operator relation $2H_{123} = H_{12} + H_{23} + H_{31}$ still holds for this class of baryonic and corresponding mesonic functionals. The kinetic and potential parts of the full QCD Hamiltonian operate on each patch P_1, P_2, P_3 separately and those contributions are counted twice in $H_{1\bar{2}} + H_{2\bar{3}} + H_{3\bar{1}}$.

The variational argument is applicable in the larger class of baryonic and mesonic trial wave functionals and it yields the required baryon-meson mass inequalities $2m_{ijk} \geq m_{ij\bar{j}} + m_{j\bar{k}} + m_{k\bar{i}}$.

The fact that the same inequality, Eq. (3.2), motivated by the color factor for the perturbative one-gluon exchange, can be rederived in a strong coupling, string-like limit (and some generalizations thereof), suggests that these inequalities may indeed be a true consequence of the full-fledged QCD theory. Indeed a particular relation involving the nucleon and pion masses has been rigorously proved by Weingarten [6], who utilized the correlation function techniques, and is reproduced in the second half of this report.⁵

Finally, we note that a construction of mesonic trial wave functionals from the baryon's ground state functional $\psi_{(i_1 \dots i_N)}$ can be carried out for $SU(N)$ with general N as well. The configuration contributing to $\psi_{(i_1 \dots i_N)}$ consists of N strings joined at a common junction point. It can be formally separated into $N(N-1)/2$ mesonic subsystems with

⁴The virial theorem (with massless quarks and linear potentials) was used in [54] to motivate the equipartition of the light cone momenta between quarks and gluons, and more recently in connection with the mass dependence of Bose-Einstein correlations in multi-particle final states [55].

⁵Despite many efforts [56,57] to extend the correlation function technique to more detailed, flavor-dependent baryon-meson and baryon-baryon inequalities, no fully convincing results have been obtained.

each part of the baryonic Hamiltonian counted $(N-1)$ times (since a segment or patch P_{i_a} connecting the quark q_{1_a} and the junction x appear in the $(N-1)$ $q_{i_a}\bar{q}_{i_b}$, $a = b$ systems), and we have:

$$(N-1)H_{i_1\dots i_N} = \sum_{i_a=i_b} H_{i_a i_b},$$

leading to the baryon-meson inequality (3.23) for general $SU(N)$.

The case of $N_c = 2$ is rather special. The lightest diquark baryon is in fact a 0^{++} mesonic state. The inequality $m_B \geq m_\pi$ is in this case most likely an equality:

$$m_{q\bar{q}}^{(0^+)} = m_{q\bar{q}}^{(0^-)}. \quad (6.8)$$

Indeed the gluon couplings inside the meson and “baryon” are the same here, so that to all orders in perturbation theory we expect the S-wave qq (or $q\bar{q}$) states to be degenerate. To obey the generalized Pauli principle, the S-wave spin and color singlet $q\bar{q}$ state ought to be a “flavor” antisymmetric ud combination which is to be compared with the $u\gamma_5\bar{d}$ pion. The pseudoreality of the $SU(2)$ group implies that in the nonperturbative string or flux tube picture, the flux emitted by one quark in the bosonic diquark can readily end on the other quark. There is no junction point in this case, the wave functionals and Hamiltonians for the 0^- $q\gamma_5\bar{q}$ and 0^+ qq systems are identical, and Eq. (6.8) follows.

7. COMPARISON OF THE INEQUALITIES WITH HADRONIC MASSES

We proceed next to list the various inequalities and compare them with available particle data [58].

First consider the meson-meson relations. As emphasized above, these inequalities do rely on an *additional* assumption of a flavor-symmetric wave function. In all testable cases (with one possible exception) these inequalities are satisfied. The inequalities could then be used as a rule of thumb to restrict the masses of as yet undiscovered new particles.

There are six relevant $m_{i\bar{j}}, m_i^0 \neq m_j^0$ flavor combinations: $u\bar{s}, u\bar{c}, s\bar{c}, s\bar{b}, u\bar{b}$, and $c\bar{b}$.⁶ Because of the small violation of I -spin symmetry (via radiative electromagnetic corrections and the effect of $|m_u - m_d| \simeq 4\text{-}5$ MeV) we have not separately considered members of an I -spin multiplet (obtained by $u \rightarrow d$ substitutions), but rather averaged over these states. Also in order to minimize the effects of the annihilation channels we consistently choose the $I = 1$ $u\bar{d}$ rather than the $I = 0$ $u\bar{u}$ states (*e.g.* ρ and not ω , a_2 and not f_0 *etc.*).

The comparison with measured masses is summarized in Table I, which indicates the specific particles and masses relevant for each inequality. In some cases all three masses in Eq. (2.18) are fairly well known or reliably estimated. In other cases lower bounds are predicted for certain $M_{ij}^{(0)JPC}$. All masses are listed in MeV.

For the pseudoscalars the inequalities have been derived by Witten [10] using the euclidean Green’s function method to be discussed at length in the second part of this review, and indeed hold with a fairly wide margin. The light pseudoscalar mesons π, K, η can also be viewed, to a good approximation, as pseudo-Goldstone bosons. Current algebra methods [59] then lead to $m_{ps_{ij}}^2 \propto (m_{q_i}^{(0)} + m_{q_j}^{(0)})$. Hence in this approximation $2m_{ps_{ij}}^2 = m_{ps_{ii}}^2 + m_{ps_{jj}}^2$ and $2m_{ps_{ij}} > m_{ps_{ii}} + m_{ps_{jj}}$ is guaranteed.⁷

For the $I = 0$ pseudoscalars the strong coupling to the gluonic M^0 channel (which in particular accounts for the massive η') [62,63] suggests strong mixing between the two $I = 0$ states that are made of light quarks, $\frac{1}{\sqrt{2}}(u\bar{u} + d\bar{d})$, and the $s\bar{s}$ state. Hence $|s\bar{s}\rangle = \alpha|\eta\rangle + \beta|\eta'\rangle$. The reasonable expectation [64] that the eigenstates η, η' are the $SU(3)$ flavor octet $\frac{1}{\sqrt{6}}(u\bar{u} + d\bar{d} - 2s\bar{s})$ and singlet $\frac{1}{\sqrt{3}}(u\bar{u} + d\bar{d} + s\bar{s})$ implies $\alpha = \sqrt{2}/3, \beta = \sqrt{1}/3$ and

$$m_{s\bar{s}}^{(0^-)} = (\alpha\langle\eta| + \beta\langle\eta'|) H (\alpha|\eta\rangle + \beta|\eta'\rangle) = \alpha^2 m_\eta + \beta^2 m_{\eta'} \dots$$

⁶Since the decay width of the top quark exceeds a few GeV, it decays before $t\bar{u}$, *etc.* states can form.

⁷The last argument is reminiscent of that made earlier for harmonic potentials. It was noticed [60] that the “dual” Lovelace-Shapiro-Veneziano formula [61] for $\pi - \pi$ scattering has a remarkable tendency to conform to soft pion theorems. Considering the harmonic string origin of “dual” amplitudes, these may perhaps be related features.

and yields $m_{s\bar{s}}^{(0^-)} \approx 706$ MeV. This indeed satisfies $m_{s\bar{s}}^{(0^-)} + m_{u\bar{d}}^{(0^-)} \leq 2m_{s\bar{d}}^{(0^-)}$ [*i.e.* $m_{s\bar{s}}^{(0^-)} + m_\pi \leq 2m_K$] with a large margin. In general $2m_K > m_\pi + m_{s\bar{s}}^{(0^-)}$ holds as long as $\beta^2/\alpha^2 < 1.5$, a constraint satisfied by all mixing schemes suggested for the 0^- mesons [65].

In the relation $2m_{u\bar{b}}^{(0^-)} \geq m_{u\bar{u}} + m_{b\bar{b}}$ we use the mass of the vectorial state, m_Υ , instead of the as yet unknown m_{η_b} . Following Weingarten we show in Sec. 8 that, when mixings with M^0 are neglected (which seems justified by asymptotic freedom in the case of heavy quarks), the lowest state in any $M_{i\bar{j}}$ sector is indeed pseudoscalar and $m_\Upsilon \geq m_{\eta_b}$, so that the original inequality is *a fortiori* satisfied.

The vector meson mass inequalities hold with smaller margins than the corresponding inequalities for the pseudoscalars. This reflects the hyperfine splittings (as indicated in the conclusion of Sec. 2), which tend to weaken (enhance) the inequality for the vector (pseudoscalar) mesons. We find it impressive that despite the very large spin splittings, *e.g.* $m_\rho - m_\pi \simeq 650\text{MeV} \simeq 5m_\pi$, the inequality may still marginally hold for the vector mesons. For the specific case of K^* , ρ , and ϕ , the inequality seems to fail, although only within $\mathcal{O}(1\%)$ of the widths of the states considered.

The inequalities for the tensor mesons can be tested in the sectors not involving the b quark. In the b quark sectors we can use the inequalities to predict lower bounds for the masses of the B_{tensor} particles. The D_{s2^+} is not known for certain to be a 2^{++} state, but this is the quark model prediction. The inequalities for the axial 1^{++} mesons all hold at the level of a few percent. Finally, the inequalities for scalars can be tested (and verified) only for the case of the $u\bar{c}$ and $u\bar{b}$ flavor combinations.⁸

The deviations from equality

$$\delta = \frac{\delta m}{m} = \frac{m_{ij} - (1/2)(m_{ii} + m_{jj})}{m_{ij}} \quad (7.1)$$

are often small [$\mathcal{O}(1\% - 2\%)$]. This may be traced to the variational principle. Since $\langle \psi | H_{ii} | \psi \rangle, \langle \psi | H_{jj} | \psi \rangle$ are extremized at $\psi = \psi_{ii}^{(0)}, \psi = \psi_{jj}^{(0)}$, respectively, the deviations $\Delta_i = \langle \psi_{ij}^{(0)} | H_{ii} | \psi_{ij}^{(0)} \rangle - \langle \psi_{ii}^{(0)} | H_{ii} | \psi_{ii}^{(0)} \rangle$ and $\Delta_j = \langle \psi_{ij}^{(0)} | H_{jj} | \psi_{ij}^{(0)} \rangle - \langle \psi_{jj}^{(0)} | H_{jj} | \psi_{jj}^{(0)} \rangle$ are quadratic in the wave function shifts, *e.g.*

$$\delta m \simeq (\delta\psi)^2 \approx (\psi_{ij}^{(0)} - \psi_{ii}^{(0)})^2. \quad (7.2)$$

The $\delta\psi$ in turn are expected, on the basis of first order perturbative estimates, to be

$$\delta\psi \simeq \frac{\delta H \psi^{(0)}}{\Delta m} \simeq \frac{(H_{ij} - H_{ii}) \psi^{(0)}}{\Delta m} = \frac{\delta H}{\Delta m} \psi^{(0)}, \quad (7.3)$$

with $\Delta m \simeq 1$ GeV the typical splitting $m_{ij}^{(0)} - m_{ij}^{(1)}$ between the ground and first excited states in the specific channel considered. δH is solely due to the quark mass differences. Taking $i = u, j = s$ we have for the simple model of Sec. 2:

$$\delta H \simeq \sqrt{m_s^2 + \langle p^2 \rangle} - \sqrt{m_u^2 + \langle p^2 \rangle}, \quad (7.4)$$

with $\langle p^2 \rangle$ the average (momentum)² in the wave functions. If we then use the bare quark masses $m_u^0 \simeq 0, m_s^0 \simeq 150$ MeV and $\langle p^2 \rangle \simeq (300\text{MeV})^2$ then $|\delta H| \simeq \frac{m_s^2}{2\sqrt{\langle p^2 \rangle}} \simeq 50$ MeV, and Eqs. (7.1) – (7.4) yield $\delta \simeq 1\%$.

For heavy-light quark combinations the difference in the kinetic parts of the Hamiltonian are larger. However, most of the masses are given in this case by the heavy quark mass itself, so that fractional deviations again remain small.

Approximate mass equalities $2m_{ii} = m_{ii} + m_{ij}$ or $2m_{ij}^2 = m_{ii}^2 + m_{jj}^2$ were suggested quite a while back on the basis of the SU(3) (Gell-Mann – Ne’eman) flavor symmetry [64]. The underlying assumption was that the flavor symmetry breaking part of the Hamiltonian behaves like H^8 , the neutral isoscalar member of an octet (a feature which is manifestly true for the QCD Hamiltonian), and that mass splittings can be obtained by using $\langle \phi^{(0)} | H^8 | \phi^{(0)} \rangle$ with $\phi^{(0)}$ the SU(3) symmetric wave functions. The present discussion suggests that these relations can be transformed into inequalities for the linear mass combinations.

When the particles in question are broad resonances, the mass inequalities need not apply. This is not just due to the technical difficulty of precisely defining, for example, m_ρ (different methods based on the $\pi\pi$ mass distributions

⁸A. Falk [66] tried using heavy quark symmetries to fix some of the unknown J^P . The QCD inequalities nicely complement this program.

or the Argand diagrams for phase shifts yield somewhat different values for the masses of resonances [58]). Strictly speaking, the inequality $2m_{u\bar{s}}^{(0)1^-} \geq m_{u\bar{u}}^{(0)1^-} + m_{s\bar{s}}^{(0)1^-}$ holds only for the *lowest* 1^- states in the $M_{u\bar{s}}, M_{u\bar{u}}, M_{s\bar{s}}$ sectors which are $K\pi, \pi\pi$, and (neglecting Zweig rule violations, *i.e.* mixing with the gluonic M^0 sector) $K\bar{K}$ P-wave states at threshold. The inequality would then appear to degenerate into the trivial statement on the kinematical threshold: $m_K + m_\pi \leq (1/2)(2m_\pi + 2m_K)$. As we will show in Sec. 16, the operator relation enables us to go beyond this and deduce relations for the phase shifts. To the extent that the threshold physics is completely dominated by narrow K^*, ρ , and ϕ resonances the mass inequality $2m_{K^*} \geq m_\rho + m_\phi$ can be regained from the phase shift inequalities.

In the large N_c limit, resonance widths and Zweig rule violations vanish like $1/N_c$ and $1/N_c^2$ respectively [67] and the distinction between the relation (5.2) and the approximate version (5.8) is lost. Also the flavor symmetry assumption may be on better footing as the gluonic degrees of freedom dominate.

We proceed next to the baryon-meson inequalities, with the results listed in Table II. The specific flavor-spin combinations appearing there are fixed in the manner explained in some detail in App. D.⁹ At the present the J^P of Λ_c^+ and Ξ_c are not established and the choice made here ($J^P = 1/2^+$, rather than $3/2^+$) is essential for the inequalities to be satisfied. In general the baryon-meson inequalities are satisfied with a higher margin than the meson-meson or baryon-baryon inequalities. This could be attributed to the weak basis for the interflavor inequalities whose derivation required, beyond the rigorous operator relations, also an assumption of predominantly flavor symmetric ground state wave functions (or functionals). Also the mesonic wave functions for the different flavors may indeed be very similar to each other [see Eqs. (7.1) – (7.4)], whereas the baryonic wave functions are intrinsically different from the mesonic ones. In the simple potential model picture the diquark subsystems are not at rest. Also the Y-configuration in the baryon's functionals are different from the \rightsquigarrow configurations in the corresponding mesonic functionals. The baryonic ground state wave functions are therefore a poorer approximation for the mesonic wave functions than the wave functions of mesons with different flavors.

Baryon-baryon inequalities are listed in Table III. From Eqs. (5.11) we have also an inequality version of the equal spacing for baryons in the decuplet (5.11a) and of the Gell-Mann – Okubo (GMO) mass formula for the baryon octet [64]. For the latter we use the inequality (5.11b): $m_{uds} \geq (1/6)(m_{\Sigma^+} + m_{\Sigma^-} + m_p + m_n + m_\Xi + m_{\Xi^0})$. Identifying uds with $(1/\sqrt{2})(\Lambda^0 + \Sigma^0)$, this becomes $3m_{\Lambda^0} + 3m_{\Sigma^0} \geq (m_{\Sigma^+} + m_{\Sigma^-} + m_p + m_n + m_\Xi + m_{\Xi^0})$, which in the limit where I -spin splittings are neglected becomes the GMO relation. While both the linearity in the decuplet and the GMO formula are very accurate it is gratifying that the small deviations are consistent with the inequalities. We should emphasize however that the flavor symmetry of the three quark baryonic ground state wave functions which underlies these inequalities is strictly an additional assumption. In spin independent quark-quark potentials $V(|\vec{r}|)$, the inequalities hold for the fairly large class of potentials discussed in App. B.

We have not listed most of the many mass relations involving radially excited states, Eq. (2.14). While we have several known radially excited states in the heavy quark $Q\bar{Q} = c\bar{c}, b\bar{b}$ systems (particularly in the 1^{--} channel), there are very few known radial excitations in the $Q\bar{q}$ or $q\bar{q}$ systems to allow useful comparisons. An exception is the case of radial excitations in the $D(c\bar{q})$ system, for which the continuous experimental effort at Fermilab [68] keeps providing a relatively elaborate charmed meson spectrum. We have therefore indicated the relevant charm radial excitations in Table IV.

TABLE I. Meson-meson Inequalities

u \bar{s} sector: $m_{u\bar{s}} \geq \frac{1}{2}(m_{u\bar{u}} + m_{s\bar{s}})$				
pseudoscalar	$m_K \geq \frac{1}{2}(m_\pi + \frac{2}{3}m_\eta + \frac{1}{3}m_{\eta'})$	495.009	\geq	411.08
vector	$m_{K^*} \geq \frac{1}{2}(m_\rho + m_\phi)$	893.14	\geq	894.7
tensor	$m_{K_2^*} \geq \frac{1}{2}(m_{a_2} + m_{f_2})$	1427.7	\geq	1296.55
axial	$m_{K_1} \geq \frac{1}{2}(m_{a_1} + m_{f_1})$	1273	\geq	1256.0
scalar	$m_{K_0^*} \geq \frac{1}{2}(m_{a_0} + m_{f_0})$	1429	\geq	982
u \bar{c} sector: $m_{u\bar{c}} \geq \frac{1}{2}(m_{u\bar{u}} + m_{c\bar{c}})$				
pseudoscalar	$m_D \geq \frac{1}{2}(m_\pi + m_{\eta_c})$	1867.7	\geq	1558.9

⁹The specification of the combinations of spins and flavors of the mesons appearing in these inequalities has used the notation and level assignments of the nonrelativistic quark model. This is, however, mainly done for convenience and does *not* detract from the degree of rigor of the derivation. Thus let us consider the comparison between the polarized Δ^{++} and ρ masses. Assume that the Δ^{++} ground state has important $L \neq 0$ components. Then we could have a uu $S = 1$ diquark with $L = 2$, or $S = 0$ with $L = 1, \dots$, and we would then simply need to construct, from the Δ^{++} wave functional, the corresponding trial wave functional for the lowest $J = 1$ $u\bar{d}$ state. The latter is still the ρ – no matter what orbital or other components it may have.

vector	$m_{D^*} \geq \frac{1}{2}(m_\rho + m_{J/\psi})$	2008.9	\geq	1933.4
tensor	$m_{D_2^*} \geq \frac{1}{2}(m_{a_2} + m_{\chi_{c2}})$	2458.9	\geq	2437.1
axial	$m_{D_1^0} \geq \frac{1}{2}(m_{a_1} + m_{\chi_{c1}})$	2422.2	\geq	2370
scalar	$m_{D_{0+}} \geq \frac{1}{2}(m_{a_1} + m_{\chi_{c0}})$	$m_{D_{0+}^*}$	\geq	2200.4
ub sector: $m_{u\bar{b}} \geq \frac{1}{2}(m_{u\bar{u}} + m_{b\bar{b}})$				
pseudoscalar	$m_B \geq \frac{1}{2}(m_\pi + m_\Upsilon)$	5279.0	\geq	4799.2
vector	$m_{B^*} \geq \frac{1}{2}(m_\rho + m_\Upsilon)$	5324.9	\geq	5115.2
tensor	$m_{B_2^*} \geq \frac{1}{2}(m_{a_2} + m_{\chi_{b2}})$	5739	\geq	5615.65
axial	$m_{B_1^0} \geq \frac{1}{2}(m_{a_1} + m_{\chi_{b1}})$	$m_{B_1^0}$	\geq	5560.95
scalar	$m_{B_{0+}} \geq \frac{1}{2}(m_{a_0} + m_{\chi_{b0}})$	$m_{B_{0+}}$	\geq	5421.6
$s\bar{c}$ sector: $m_{s\bar{c}} \geq \frac{1}{2}(m_{s\bar{s}} + m_{c\bar{c}})$				
pseudoscalar	$m_{D_s} \geq \frac{1}{2}\left(\frac{2}{3}m_\eta + \frac{1}{3}m_{\eta'} + m_{\eta_c}\right)$	1968.5	\geq	1832.0
vector	$m_{D_s^*} \geq \frac{1}{2}(m_\phi + m_{J/\psi})$	2112.4	\geq	2058.15
tensor	$m_{D_{s2+}} \geq \frac{1}{2}(m_{f_2} + m_{\chi_{c2}})$	2573.5	\geq	2415.6
axial	$m_{D_{s1+}} \geq \frac{1}{2}(m_{f_1} + m_{\chi_{c1}})$	2535.35	\geq	2396.2
scalar	$m_{D_{0+}} \geq \frac{1}{2}(m_{f_0} + m_{\chi_{c0}})$	$m_{D_{0+}}$	\geq	1709
sb sector: $m_{s\bar{b}} \geq \frac{1}{2}(m_{s\bar{s}} + m_{b\bar{b}})$				
pseudoscalar	$m_{B_s^0} \geq \frac{1}{2}\left(\frac{2}{3}m_\eta + \frac{1}{3}m_{\eta'} + m_\Upsilon\right)$	5369.3	\geq	5072.2
vector	$m_{B_s^*} \geq \frac{1}{2}(m_\phi + m_\Upsilon)$	5416.3	\geq	5239.89
tensor	$m_{B_{2+}} \geq \frac{1}{2}(m_{f_2} + m_{\chi_{b2}})$	$m_{B_{2+}}$	\geq	5594.1
axial	$m_{B_{1+}} \geq \frac{1}{2}(m_{f_1} + m_{\chi_{b1}})$	$m_{B_{1+}}$	\geq	5586.9
scalar	$m_{B_{0+}} \geq \frac{1}{2}(m_{f_0} + m_{\chi_{b0}})$	$m_{B_{0+}}$	\geq	5421.9
cb sector: $m_{c\bar{b}} \geq \frac{1}{2}(m_{c\bar{c}} + m_{b\bar{b}})$				
pseudoscalar	$m_{B_c^\pm} \geq \frac{1}{2}(m_{\eta_c} + m_\Upsilon)$	6400	\geq	6219.6
vector	$m_{B_{c1-}} \geq \frac{1}{2}(m_{J/\psi} + m_\Upsilon)$	$m_{B_{c1-}}$	\geq	6278.6
tensor	$m_{B_{c2+}} \geq \frac{1}{2}(m_{\chi_{c2}} + m_{\chi_{b2}})$	$m_{B_{c2+}}$	\geq	6734.7
axial	$m_{B_{c1+}} \geq \frac{1}{2}(m_{\chi_{c1}} + m_{\chi_{b1}})$	$m_{B_{c1+}}$	\geq	6701.2
scalar	$m_{B_{c0+}} \geq \frac{1}{2}(m_{\chi_{c0}} + m_{\chi_{b0}})$	$m_{B_{c0+}}$	\geq	6638.6

TABLE II. Baryon-meson Inequalities

$J^P = 3/2^+$			
$m_\Delta (uuu) \geq (3/2)m_\rho$	1232.0	\geq	1155
$m_\Sigma (suu) \geq (1/2)(m_\rho + 2m_{K^*})$	1384.6	\geq	1278
$m_\Xi (ssu) \geq (1/2)(m_\phi + 2m_{K^*})$	1533.4	\geq	1402.85
$m_{\Omega^-} (sss) \geq (3/2)m_\phi$	1672.45	\geq	1529.12
$m_{\Sigma_c^{++}} (cuu) \geq (1/2)(m_\rho + 2m_{D^*})$	2519.4	\geq	2394
$m_{\Xi_c} (csu) \geq (1/2)(m_{K^*} + m_{D^*} + m_{D_s^*})$	m_{Ξ_c}	\geq	2507.2
$m_{\Omega_c^0} (css) \geq (1/2)(m_\phi + 2m_{D^*})$	$m_{\Omega_c^0}$	\geq	2518.6
$m_{\Xi_{cc}} (ccu) \geq (1/2)(m_{J/\psi} + 2m_{D^*})$	$m_{\Xi_{cc}}$	\geq	3557.3
$m_{\Omega_{cc}^+} (ccs) \geq (1/2)(m_{J/\psi} + 2m_{D_s^*})$	$m_{\Omega_{cc}^+}$	\geq	3660.8
$m_{\Omega_{ccc}^{++}} (ccc) \geq (3/2)(m_{J/\psi})$	$m_{\Omega_{ccc}^{++}}$	\geq	4645.32
$m_{\Sigma_b} (buu) \geq (1/2)(m_\rho + 2m_{B^*})$	m_{Σ_b}	\geq	5710
$m_{\Xi_b} (bsu) \geq (1/2)(m_{K^*} + m_{B^*} + m_{B_s^*})$	m_{Ξ_b}	\geq	5793.7
$m_{\Omega_b} (bss) \geq (1/2)(m_\phi + 2m_{B_s^*})$	m_{Ω_b}	\geq	5879.0
$m_{\Xi_{bb}} (bbu) \geq (1/2)(m_\Upsilon + 2m_{B^*})$	$m_{\Xi_{bb}}$	\geq	10055.1
$m_{\Omega_{bb}} (bbs) \geq (1/2)(m_\Upsilon + 2m_{B_s^*})$	$m_{\Omega_{bb}}$	\geq	10099.5
$m_{\Omega_{bbb}} (bbb) \geq (3/2)(m_\Upsilon)$	$m_{\Omega_{bbb}}$	\geq	14190.56
$J^P = 1/2^+$			
$m_N (uud) \geq (3/4)(m_\pi + m_\rho)$	938.919	\geq	681
$m_\Sigma (suu) \geq (1/4)(2m_\rho + 3m_K + m_{K^*})$	1193.15	\geq	980
$m_\Xi (uss) \geq (1/4)(2m_\phi + 3m_K + m_{K^*})$	1318.1	\geq	1104.25
$m_{\Sigma_c} (cuu) \geq (1/4)(2m_\rho + 3m_D + m_{D^*})$	2452.9	\geq	2288
$m_{\Omega_c} (ssc) \geq (1/4)(2m_\phi + 3m_{D_s} + m_{D_s^*})$	2704	\geq	2514.1
$m_{\Xi_c} (ccu) \geq (1/4)(2m_{J/\psi} + 3m_D + m_{D^*})$	m_{Ξ_c}	\geq	3451.5
$m_{\Omega_{cc}^+} (ccs) \geq (1/4)(2m_{J/\psi} + 3m_{D_s} + m_{D_s^*})$	$m_{\Omega_{cc}^+}$	\geq	3552.9
$m_{\Sigma_b} (buu) \geq (1/4)(2m_\rho + 3m_B + m_{B^*})$	m_{Σ_b}	\geq	5675.5
$m_\Lambda (uds) \geq (1/4)(2m_\pi + 3m_K + m_{K^*})$	1115.683	\geq	663.56
$m_{\Lambda_c^+} (udc) \geq (1/4)(2m_\pi + 3m_D + m_{D^*})$	2284.9	\geq	1973.0
$m_{\Lambda_b^0} (udb) \geq (1/4)(2m_\pi + 3m_B + m_{B^*})$	5624	\geq	5359.5
$m_{\Xi_c} (cus) \geq (1/4) [(m_K + m_{K^*}) + (m_{D_s} + m_D) + (m_{D_s^*} + m_{D^*})]$	2469.0	\geq	2336.4
$m_{\Xi_b} (bus) \geq (1/4) [(m_K + m_{K^*}) + (m_{B_s} + m_B) + (m_{B_s^*} + m_{B^*})]$	m_{Ξ_b}	\geq	5682.7
$m_{bc_s} (bcs) \geq (1/4) [(m_{D_s} + m_{D_s^*}) + (m_{B_s} + m_B) + (m_{B_s^*} + m_{B^*})]$	m_{bc_s}	\geq	6355.9

TABLE III. Baryon-baryon Inequalities

for the octet (Gell-Mann – Okubo)			
$3m_\Lambda + \frac{1}{3}(m_{\Sigma^-} + m_{\Sigma^+} + m_{\Sigma^0}) \geq m_p + m_n + m_{\Xi^-} + m_{\Xi^0}$	4731.6	\geq	4514.1
for the decuplet			
$m_\Sigma \geq (1/2)(m_\Delta + m_\Xi)$	1384.6	\geq	1382.7
$m_\Xi \geq (1/2)(m_\Omega + m_\Sigma)$	1533.4	\geq	1528.5

TABLE IV. Inequalities involving charm meson radial excitations

pseudoscalar	$m_D^{(0)} + m_D^{(1)} \geq \frac{1}{2} [m_{\eta_c}^{(0)} + m_{\eta_c}^{(1)} + m_\pi^{(0)} + m_\pi^{(1)}]$	$m_D^{(1)}$	\geq	2138.2 ¹⁰
vector	$m_{D^*}^{(0)} + m_{D^*}^{(1)} \geq \frac{1}{2} [m_{J/\psi}^{(0)} + m_{J/\psi}^{(1)} + m_\rho^{(0)} + m_\rho^{(1)}]$	4645.9	\geq	4508.95

¹⁰We can predict a lower bound on the mass of the as yet undiscovered $D^{(1)}$, since the other masses in the inequality are known.

8. QCD INEQUALITIES FOR CORRELATION FUNCTIONS OF QUARK BILINEARS

The set of all euclidean correlation functions, *i.e.* ordinary Green's functions continued to the euclidean domain, contains the complete information on any field theory [69]. In particular, two-point euclidean correlation functions are closely related to the spectrum of the theory, and indeed play a key role in most attempts to compute the spectrum of QCD. Following Weingarten [6], we will prove in this section inequalities for mesonic correlation functions. Let

$$F_a(x, y) = \langle 0 | J_a(x) J_a^\dagger(y) | 0 \rangle, \quad (8.1)$$

with $J_a(x)$ a general, local, gauge invariant (*i.e.* color singlet) operator with the index a indicating Lorentz and/or flavor indices, be such a two-point function. Note that in the euclidean case all $x - y$ intervals are spacelike. The usual time ordering stating that the creation operator $J_a^\dagger(x)$ should act prior to the annihilation $J_a(x)$ is redundant.

With an eye to the original Minkowski configuration, we will still assume that $x^0 - y^0 \geq 0$. In particular, we could use rotational (Lorentz) invariance to make $x^0 - y^0 = |x - y| = t$ by choosing $y = (0, \vec{0})$, $x = (t, \vec{0})$. Inserting a complete set of physical energy momentum eigenstates and using the (euclidean) time translation operator $e^{-Ht} J_a(0) e^{Ht} = J_a(t)$, we obtain a spectral function representation [70]

$$F_a(x - y) = \int_{\mu_0}^{\infty} d\mu^2 \sigma_a(\mu^2) e^{-\mu|x-y|} \quad (8.2)$$

for the correlation function. The spectral function is given by

$$\sigma_a(\mu^2) = \sum_n |\langle 0 | J_a | n \rangle|^2 \delta(p_n^2 - \mu^2), \quad (8.3)$$

with p_n the four momentum of the state n .

The asymptotic behavior of $F_a(x - y)$ (as $|x - y| \rightarrow \infty$) is controlled by the state of lowest mass contributing in Eq. (8.3):

$$F_a(x - y) \sim e^{-\mu_0|x-y|}, \quad (8.4)$$

where \sim means equality up to a residue factor γ_a and powers of $|x - y|^{-1}$. Here μ_0 could correspond to a physical two particle threshold. It could also be an isolated contribution $p^2(n_a) = [m_a^{(0)}]^2$ of a particle with the quantum numbers of the current J_a , *i.e.* a state for which $\langle n_a | J_a^\dagger | 0 \rangle \neq 0$. In this case,

$$F_a(x - y) \sim e^{-m_a^{(0)}|x-y|} \gamma_a. \quad (8.5)$$

We note that due to color confinement in QCD the finite energy physical spectrum consists of color singlet states and therefore it is sufficient to consider only correlation functions of color singlet operators.¹¹

Eq. (8.5) is used in QCD lattice Monte Carlo calculations of the spectrum [3,4]. An exponential form is fitted to the large (many lattice spacings) distance behavior of the appropriate correlation function. The latter is estimated by numerical sampling via the functional path integral expression for the correlation functions:

$$\langle 0 | J_a(x) J_a^\dagger(y) | 0 \rangle = \frac{\int d[A_\mu(x)] \int d[\psi(x)] \int d[\bar{\psi}(x)] J_a(x) J_a^\dagger(x) e^{-S(x)}}{\int d[A_\mu(x)] \int d[\psi(x)] \int d[\bar{\psi}(x)] e^{-S(x)}}, \quad (8.6)$$

with the action

$$S_{\text{QCD}} = \int d^4x \mathcal{L}_{\text{QCD}} = \int d^4x \left[\sum_i \bar{\psi}_i (\not{D}_A + m_i) \psi_i + \text{tr}(F_{\mu\nu}^a \lambda^a)^2 \right] \quad (8.7)$$

and $\not{D}_A = \gamma^\mu (\partial_\mu + i\lambda^a A_{a\mu})$. For the purpose of lattice calculations, and also for the derivation of the QCD inequalities, we should eliminate the Grassman variables $\psi(x)$ and $\bar{\psi}(x)$ (corresponding to the anti-commuting fields) in the functional integral. Since ψ_i and $\bar{\psi}_i$ appear only in the bilinear kinetic and mass term in the action, this integration

¹¹We will not address the interesting suggestion [71] that the inequalities mandate specific patterns of color symmetry breaking.

can be done in closed form [4]. In the partition function in the denominator of Eq. (8.6) this results simply in the additional factor $\prod_{i=1}^{N_f} \text{Det}(\mathcal{D}_A + m_i)$, which modifies the integration weight from

$$d\mu(A) = e^{-S_{YM}(A)} d[A_\mu(x)] \dots ,$$

where $S_{YM}(A) = \text{tr}(F_{\mu\nu}^a \lambda^a)^2$ is the pure Yang-Mills part of the QCD action, to

$$d\mu(A) = e^{-S_{YM}(A)} \prod \text{Det}(\mathcal{D}_A + m_i) d[A_\mu(x)] . \quad (8.8)$$

The same change occurs in the numerator if J_a are functions of gluonic ($F_{\mu\nu}$) degrees of freedom only.

The currents of interest – for the non-glueball part of the QCD spectrum – are, however, bilinears of quark fields, of the form $J_\Gamma^{i\bar{j}} = \bar{\psi}_i^a \Gamma \psi_{j\bar{a}}$. We use the scalar, pseudoscalar, vector, and pseudovector currents and bilinear expressions with extra D_μ derivatives:

$$\begin{aligned} J_s^{i\bar{j}} &= \bar{\psi}_i^a \psi_{j\bar{a}}, & J_{ps}^{i\bar{j}} &= \bar{\psi}_i^a \gamma_5 \psi_{j\bar{a}}, \\ J_v^{i\bar{j}} &= \bar{\psi}_i^a \gamma_\mu \psi_{j\bar{a}}, & J_{pv}^{i\bar{j}} &= \bar{\psi}_i^a \gamma_5 \gamma_\mu \psi_{j\bar{a}}, \\ J_T^{i\bar{j}} &= \bar{\psi}_i^a \not{D}_\nu \gamma_\mu \psi_{j\bar{a}}, \end{aligned} \quad (8.9)$$

in order to extract the spectrum of the $0^+, 0^-, 1^+, 1^-$, and 2^+ mesons made up of quark flavors q_i and \bar{q}_j .

In all of these cases we need to contract the extra $(\bar{\psi})\psi$ at (x) and $(\bar{\psi})\psi$ at (y) . One chain of consecutive contractions can involve both $\psi(x)$ and $\bar{\psi}(y)$. This gives a “connected” flavor structure with the quark q_i propagating from y to x and antiquarks \bar{q}_j from x to y [see Fig. 9(a)]; or, if $i = j$, we could also have the $q_i(x)\bar{q}_i(x)$ and $q_i(y)\bar{q}_i(y)$ in two separate contractions, yielding a (flavor) disconnected structure [see Fig. 9(b)]. The expression for the two-point correlation function then becomes

$$\int d\mu(A) \text{tr} \left[\Gamma S_A^i(x, y) \Gamma S_A^j(y, x) \right] \Big/ \int d\mu(A) \quad (8.10a)$$

for the flavor connected case, or

$$\int d\mu(A) \text{tr} \left[\Gamma S_A^i(x, x) \right] \text{tr} \left[\Gamma S_A^i(y, y) \right] \Big/ \int d\mu(A) \quad (8.10b)$$

for the flavor disconnected case.

In Eqs. (8.10) $S_A^i(x, y)$ is the full euclidean fermionic propagator (for flavor q_i) in the background field $A_\mu(x)$; Γ is the Dirac matrix in the expression for the current (8.9); and the trace refers to both spinor and color indices (which are suppressed).

The quark propagator solves the equation

$$(\mathcal{D}_A + m_i) S_A^i(x, y) = \delta(x - y)$$

and formally is given by

$$S_A^i(x, y) = \langle x | (\mathcal{D}_A + m_i)^{-1} | y \rangle \quad (8.11)$$

with $\mathcal{D} = \gamma_\mu D_\mu(A)$ involving the covariant derivatives $D_\mu(A) = \partial_\mu + i\lambda_a A_\mu^a$ in the given background field configuration $A_\mu(x)$. The euclidean \mathcal{D} is purely antihermitian and the γ_μ are all hermitian and satisfy $\{\gamma_\mu, \gamma_\nu\} = 2\delta_{\mu\nu}$.

It is well known that the singular behavior of $\text{tr}[\gamma_5 S_A(x, y)]$ when $x \rightarrow y$ [69,72,73], or, alternatively some subtleties in the fermionic integration [74], may induce an anomaly $\sim F\tilde{F}$ in the flavor disconnected parts for the pseudoscalar case. Thus for much of the following discussion we will take $i \neq j$ and avoid altogether the flavor disconnected contribution.

An important element for the derivation of the inequalities is the positivity of the determinantal factor $\prod \text{Det}(\mathcal{D}_A + m_i)$, and hence also of the integration measure $d\mu(A)$ in Eq. (8.8), for any given $A_\mu(x)$ configuration [6,7]. The euclidean QCD action $\mathcal{L}_E = E^2 + B^2$ is real so long as we do not have an $i\theta E \cdot B$ term, and hence $\exp[-S_{YM}(A)]$ is positive. To show the positivity of the determinant factor, let us consider the eigenmodes $\psi_A(\lambda_A)$ of the hermitian operator $i\mathcal{D}_A$ satisfying

$$i\mathcal{D}_A \psi_\lambda^A = \lambda(A) \psi_\lambda^A \quad (8.12)$$

with real eigenvalues $\lambda(A)$. The γ_5 anticommutation $\gamma_5 \gamma_\mu \gamma_5 = -\gamma_\mu$ implies the relation

$$\mathcal{D}_A = -\gamma_5 \mathcal{D}_A \gamma_5 . \quad (8.13)$$

This in turn forces all nonzero eigenvalues of \mathcal{D}_A to appear in complex conjugate pairs. Indeed from (8.12) and (8.13)

$$i \mathcal{D}_A (\gamma_5 \psi_\lambda) = \gamma_5^2 i \mathcal{D}_A \gamma_5 \psi_\lambda = -\gamma_5 (i \mathcal{D}_A) \psi_\lambda = -\lambda(A) \gamma_5 \psi_\lambda , \quad (8.14)$$

so that $\gamma_5 \psi_\lambda$ is the eigenfunction corresponding to the eigenvalues $-\lambda(A)$. Thus we have explicitly positive determinants

$$\text{Det}(\mathcal{D}_A + m_i) = \prod_\lambda [i\lambda(A) + m_i] [-i\lambda(A) + m_i] = \prod_\lambda [\lambda^2(A) + m_i^2] \quad (8.15)$$

and hence

$$d\mu(A) \geq 0 \quad (8.16)$$

for all $A_\mu(x)$.

It is important to notice that the above argument applies only for vectorial, non-chiral models with the quarks being Dirac fermions. If $\gamma_5 \psi_\lambda$ is not a distinct new spinor (as is the case for chiral fermions) then the positivity argument breaks down.

The measure positivity allows us to prove inequalities between correlation functions if we can show that the corresponding integrands in Eq. (8.10a) satisfy, for any $A_\mu(x)$, the same inequality. Thus, let us assume that by simple algebra one can prove

$$\text{tr} [\Gamma_a S^i(x, y) \Gamma_a S^j(y, x)] \geq \text{tr} [\Gamma_b S^i(x, y) \Gamma_b S^j(y, x)] . \quad (8.17)$$

The same inequality continues to hold after we integrate over the normalized, positive $d\mu(A)$, yielding

$$\langle 0 | J_a(x) J_a^\dagger(y) | 0 \rangle \geq \langle 0 | J_b(x) J_b^\dagger(y) | 0 \rangle \quad (8.18)$$

with

$$J_{a(b)}(x) = \bar{\psi}_i(x) \Gamma_{a(b)} \psi_i(x) . \quad (8.19)$$

We will next show that a relation like Eq. (8.17) holds with $\Gamma_a = \gamma_5$. To this end we use Eq. (8.11) defining the propagator $S_A(x, y)$. We then have

$$\begin{aligned} \gamma_5 S_A(x, y) \gamma_5 &= \langle x | \gamma_5 (\mathcal{D}_A + m)^{-1} \gamma_5 | y \rangle = \langle x | -(\mathcal{D}_A + m)^{-1} | y \rangle \\ &= \langle x | [(\mathcal{D}_A + m)^{-1}]^\dagger | y \rangle = S_A^\dagger(y, x) , \end{aligned} \quad (8.20)$$

where the last dagger refers to the conjugate matrix in color and spinor space.

It is instructive to see how the same result is obtained in various more explicit expressions for the propagator. Thus consider the contribution of any fermionic path on the lattice to the propagator $S_A^i(x, y)$ in the hopping parameter expansion [75]. It is [4]

$$\prod_{\vec{n}, \hat{\mu}} U(\vec{n}, \vec{n} + \hat{\mu})(a + b\gamma_\mu) , \quad (8.21)$$

where the product extends over any set of links connecting the initial point y to the final point x . Multiplying by γ_5 on the left and right and commuting the γ_5 factor through, we have $\prod_{\vec{n}, \vec{n} + \hat{\mu}} U(\vec{n}, \vec{n} + \hat{\mu})(a - b\gamma_\mu) = \prod_{\vec{n} + \hat{\mu}, \vec{n}} [U(\vec{n} + \hat{\mu}, \vec{n})(a - b\gamma_\mu)]^\dagger$ (the euclidean γ_μ are hermitian), which is the same as the contribution of the reversed path of links (connecting x to y) to $[S_A^i(y, x)]^\dagger$. Summing over all fermionic paths, we reconstruct $S_A^i(x, y)$ and $S_A^i(y, x)$ and Eq. (8.20) is satisfied.

The key observation now is that if

$$S_A^i(x, y) = S_A^j(x, y) \quad (8.22)$$

then Eq. (8.20) implies that the integrand in the pseudoscalar correlation function is a positive definite sum of squares:

$$\text{tr} \left[\gamma_5 S_A^i(x, y) \gamma_5 S_A^j(x, y) \right] = \text{tr} \left[(S_A^i)^\dagger(y, x) S_A^j(x, y) \right] = \sum_{\substack{a, a' \\ \tau, \tau'}} |(S_A^i)_{aa', \tau\tau'}|^2 \geq 0, \quad (8.23)$$

with the sum extending over color (a) and spinor (τ) indices.

The integrand for any correlation functions of the other, non-pseudoscalar currents in Eq. (8.9) involves again sums of bilinear products of the same matrix elements $(S_A^i)_{aa', \tau\tau'}$, but in general with alternating signs. Thus the integrand for the pseudoscalar correlation functions is larger than all the other integrands. This then yields the desired result:

$$\langle 0 | J_{ps}^{i\bar{j}}(x) (J_{ps}^{i\bar{j}})^\dagger(y) | 0 \rangle \geq \langle 0 | J_\Gamma^{i\bar{j}}(x) J_\Gamma^{i\bar{j}}(y) | 0 \rangle, \quad (8.24)$$

with J_Γ any non-pseudoscalar current.

The requirement $S_A^i(x, y) = S_A^j(x, y)$, with $i \neq j$, is made in order to avoid the flavor disconnected contribution (8.10b) which could invalidate the derivation. It can be satisfied in the I -spin limit – with $m_u - m_d \ll \Lambda_{\text{QCD}}$ and EM effects neglected – by taking $i = u, j = d$. Since $S_A^u(x, y)$ and $S_A^d(x, y)$ then satisfy identical equations, $S_A^u(x, y) = S_A^d(x, y)$ as required. The lowest mass particle in this $\psi_u \gamma_5 \psi_d$ channel is then the pion. The inequality (8.18) between the correlation functions implies, by going to the asymptotic $|x - y| \rightarrow \infty$ region and utilizing the asymptotic behavior (8.4), the reverse inequality between the lowest mass particles in the corresponding channels:

$$m_a^{(0)} \leq m_b^{(0)}. \quad (8.25)$$

Thus we obtain the result that the pion is the lightest meson in the $u\bar{d}$ channels

$$m_\pi \leq m_\rho(1^-) \quad (8.26a)$$

$$m_\pi \leq m_{a_1}(1^+), m_{a_2}(2^+) \quad (8.26b)$$

$$m_\pi \leq m_\chi(0^+) \quad (8.26c)$$

We note that these level orderings are indeed expected in any $q\bar{q}$ potential model [28] where the singlet S-wave state – *i.e.* the π meson – is the lowest lying state.

Could the various renormalizations which are required in order to render the correlation functions and the local products $\bar{\psi}^i(x) \Gamma \psi^j(x)$ finite invalidate the derivation? The regularization required in order to make the path integral $\int d[A_\mu(x)]$ well-defined will not in general interfere with the derivation of the inequalities. Thus we could use a lattice discretization with any spacing a and with any action – the minimal Wilson action or with terms in the adjoint or higher representation. The inequalities will continue to be satisfied at every step of the procedure of letting $a \rightarrow 0$ and V , the volume of the lattice, to infinity. Thus, to the extent that any sensible regularization exists, the inequalities will be satisfied.

Instead of the local (non-pseudoscalar) current $J^\Gamma(x) = \bar{q}(x) \Gamma q(x)$, we could use a non-local gauge invariant version [6]

$$\begin{aligned} J_c^\Gamma(x, x') &= \bar{q}_i(x) \Gamma \exp i \oint_x^{x'} A_\mu dx^\mu q_j(x') \\ &= \bar{q}_i(x) \Gamma U_c q_j(x') \end{aligned} \quad (8.27)$$

which creates an extended state – a quark at x , antiquark at x' , and a connecting flux string along a curve c . The path-ordered Wilson line factor U_c is a unitary matrix. The corresponding correlation function

$$\left\langle 0 \left| J^\Gamma(x, x') [J^\Gamma(y, y')]^\dagger \right| 0 \right\rangle = \int d[\mu(A)] \text{tr} [\Gamma U_c S_A(x, y) U_c^\dagger \Gamma S_A(y', x')] \quad (8.28)$$

can readily be shown, using a Schwartz inequality, to satisfy:

$$\left| \left\langle 0 \left| J^\Gamma(x, x') [J^\Gamma(y, y')]^\dagger \right| 0 \right\rangle \right| \leq \langle 0 | J_p(x) J_p^\dagger(y) | 0 \rangle \langle 0 | J_p(x') J_p^\dagger(y') | 0 \rangle, \quad (8.29)$$

from which it follows that the mass of any particle χ created by $J_c^\Gamma(x, x')$ still satisfies $m_\chi \geq m_\pi$.¹²

¹²The advantage of the more general construction using a nonlocal J_c^Γ is that χ states of any spin can be created.

The derivation of the inequalities still applies regardless of the choice of “gauge fixing” which limits the allowed $A_\mu(x)$ (or $U_{\vec{n},\vec{n}+\hat{\rho}}$ in the lattice version) which should be summed over, but does not affect the positivity of the measure. Also, the derivation is not sensitive to the issue of how we put the fermions on the lattice. We can use Kogut-Susskind fermions [76] [which would correspond to $a = 0, b = 1$ in Eq. (8.21)], Wilson fermions [77] ($a = 1, b = 1$), or any intermediate procedure.¹³

The inequalities are independent of the issue of quark and color confinement.¹⁴ In fact the inequalities also apply in non-confining vectorial theories like QED and in the short distance $|x - y| \rightarrow 0$ limit where perturbative QCD is adequate. They would amount to the statement that the pseudoscalar spin singlet “para-positronium” type state is the lightest (this happens in QED even with $i = j = \text{electron}$ since the effects of the $F\bar{F}$ anomaly are weak for $m_e \neq 0$). Likewise, the euclidean pseudoscalar correlation function dominates, as $x \rightarrow 0$ (or $q \rightarrow \infty$ in momentum space), all the other correlation functions in the zero and one gluon approximation respectively. These inequalities first derived by Weingarten are the simplest of the exact QCD inequalities and yet, as will be made clear in the next section, are extremely useful. The positivity of the contribution of each $A_\mu(x)$ (or $U_{\vec{n},\vec{n}+\hat{\rho}}$) configuration to the path integral defining the pseudoscalar propagator $\langle 0 | J_{ps}(x) J_{ps}^\dagger(y) | 0 \rangle$ is a novel feature specific to QCD-type theories. It is quite distinct from the positivity (by unitarity) of the contribution of each physical intermediate state $|\langle 0 | J_a | n \rangle|^2 \delta(p_n^2 - \mu^2)$ to the spectral function which holds for an arbitrary current J_a in any theory, vectorial or otherwise. We cannot in general appeal to *both* types of positivity at the *same time*, since, in order to have the correct physical states, we have to sum over all the background $A_\mu(x)$ configurations first. Otherwise, we do not respect even the translational invariance used in order to derive Eq. (8.3).

Anishetty and Wyler [80] and Hsu [81] noticed that the measure positivity and ensuing inequalities hold also for SU(2) chiral gauge theories with an even number of flavors (required in order to avoid global anomalies [82]). Indeed in this case, we can define

$$\psi^i = \psi^i + (\psi^{i+N_f/2})^C, \quad i = 1, \dots, N_f/2$$

to be $N_f/2$ vectorial, interacting Dirac fields.

9. QCD INEQUALITIES AND THE NON-BREAKING OF GLOBAL VECTORIAL SYMMETRIES

The symmetry structure of a field theory, *e.g.* whether it spontaneously breaks vectorial and/or axial global symmetries present in the original Lagrangian, is closely tied in with the zero mass sector. Thus spontaneous breaking of global symmetries implies, via the Goldstone theorem [83], the existence of massless, scalar Goldstone bosons. Likewise spontaneous breaking of axial global symmetries implies Nambu-Goldstone massless pseudoscalars [84]. Finally, an unbroken axial symmetry may require for its realization massless fermions in the physical spectrum (or a parity doubled spectrum). Evidently mass relations such as Eqs. (1.9) between baryons (fermions) and scalar and/or pseudoscalar masses could restrict some of these possibilities and dictate the patterns of global symmetry realization in QCD and other vectorial theories.

As a first illustration we will use the inequality (8.26c) – due to Weingarten – to motivate the Vafa-Witten theorem. The theorem states that in QCD (and in vectorial theories in general) global vectorial symmetries do not break down spontaneously. This will then be supplemented by some of the more rigorous discussion in the original Vafa-Witten paper.

To be specific let us first consider a nonabelian global vectorial symmetry such as the SU(2) isospin symmetry for QCD. This symmetry is generated by

¹³Since the derivation of the inequalities may formally apply to any dimension and any shape of lattice, it should also hold for the new domain wall fermions [78].

¹⁴In the limit of unbound massive quarks we could have additional relations between the correlation functions. To leading order, the asymptotic behavior of all correlation functions is now the same: $\exp[-(m_i + m_j)|x - y|]$. However, the P-wave intermediate states in the scalar or axial current correlation function cause a stronger (power) vanishing of $\sigma(\mu^2)$ at $\mu = m_i + m_j$; hence the pseudovector correlation functions have an inferior power behavior [79] when $|x - y| \rightarrow \infty$, as compared with the vectorial correlation functions. The inequalities $\langle J_V^{u\bar{d}}(x) J_V^{u\bar{d}}(y) \rangle \geq \langle J_A^{u\bar{d}}(x) J_A^{u\bar{d}}(y) \rangle$ and are true to all orders of perturbation theory and thus may be true even in the confining phase. In this case we expect additional mass ordering relations such as $m_\rho(1^-) \leq m_{a_1}$.

$$\begin{aligned}
I^+ &= \int d^3x \psi_u^\dagger(x) \psi_d(x) \\
I^- &= \int d^3x \psi_d^\dagger(x) \psi_u(x) \\
I^3 &= \frac{1}{2} \int d^3x \left[\psi_u^\dagger(x) \psi_u(x) - \psi_d^\dagger(x) \psi_d(x) \right].
\end{aligned} \tag{9.1}$$

In the limit of $m_u^{(0)} = m_d^{(0)}$ and no electromagnetic interactions it is an exact symmetry of H_{QCD} . If the symmetry breaks down spontaneously (either completely or to a $U(1)$ subgroup generated by I_3) we expect massless Goldstone scalars $0_{u\bar{d}}^+$ and $0_{u\bar{d}}^+$. The essence of the argument against spontaneous breaking is that such massless scalars can be ruled out if $m_u^{(0)} = m_d^{(0)} \neq 0$. Alternatively an exponential falloff as $|x - y| \rightarrow \infty$ of all correlation functions can be proven for $m_u^{(0)} = m_d^{(0)} > 0$. This conflicts with the power falloff expected due to the intermediate zero mass $0_{u\bar{d}}^+$ state contributing via Eq. (8.5) to the spectral representation of the scalar correlation function.

Let us present first the more heuristic argument which is analogous to the first argument of Vafa and Witten. The inequality (8.26c) $m_{u\bar{d}}^{(0+)} \geq m_{u\bar{d}}^{(0-)}$ states that the lowest scalar state in the $u\bar{d}$ channel must have a mass equal to or larger than the mass of the lowest $u\bar{d}$ pseudoscalar. If the I^+ symmetry is spontaneously broken, then $m_{u\bar{d}}^{(0+)} = 0$ and hence $m_{u\bar{d}}^{(0-)}$ must vanish as well. If the axial global symmetry is not spontaneously broken, such a vanishing could only be accidental and hence most implausible. We next make a more precise and specific argument why $m_{u\bar{d}}^{(0-)}$ should *not* vanish.

In the limit $m_u^{(0)} = m_d^{(0)} = 0$ the QCD Lagrangian possesses an extra global $SU(2)$ symmetry generated by the axial analogs of Eq. (9.1):

$$I_5^+ = \int d^3x \psi_u^\dagger(x) \gamma_5 \psi_d(x), \text{ etc.} \tag{9.2}$$

The spontaneous breaking of I_5^+ could then yield a massless pseudoscalar $u\bar{d}$ Nambu-Goldstone boson and $m_{u\bar{d}}^{(0+)} \geq m_{u\bar{d}}^{(0-)}$ would then be trivially satisfied as $0 \geq 0$. However, following Vafa and Witten we keep $m_u^{(0)} = m_d^{(0)} \neq 0$. No exact chiral symmetry then exists and $m_{u\bar{d}}^{(0-)}$ should not vanish. The Weingarten inequality implies $m_{u\bar{d}}^{(0+)} \geq m_{u\bar{d}}^{(0-)} > 0$, which as we argue next, negates the spontaneous breaking of I^+ symmetry.

As we approach the $m_u^{(0)} = m_d^{(0)} = 0$ limit, the lowest lying pseudoscalar particle becomes a pseudo-Goldstone particle whose (mass)² is given by [59,85]

$$m_\pi^2 f_\pi^2 = \left(m_u^{(0)} + m_d^{(0)} \right) \langle \bar{\psi} \psi \rangle \tag{9.3}$$

and m_π^2 vanishes linearly with the explicit chiral symmetry breaking $(m_u^{(0)} + m_d^{(0)})$ in the Lagrangian. Similar manipulations utilizing the analog of the soft pion theorem and current algebra yielding Eq. (9.3) suggest an analogous relation for the mass of the tentative $0_{u\bar{d}}^+$ Goldstone boson χ :

$$m_\chi^2 f_\chi^2 = \left(m_d^{(0)} - m_u^{(0)} \right) \left(\langle \bar{\psi}_u \psi_u \rangle - \langle \bar{\psi}_d \psi_d \rangle \right) \leq m_\pi^2 f_\pi^2. \tag{9.4}$$

If $f_\chi \neq 0$, *i.e.* the Goldstone 0^+ boson does not decouple, then Eqs. (9.3) and (9.4) are inconsistent with the QCD inequality $m_{u\bar{d}}^{(0+)} \geq m_{u\bar{d}}^{(0-)}$ so long as $m_u^{(0)} - m_d^{(0)} \ll m_u^{(0)} + m_d^{(0)}$, which we can maintain even as we approach $m_u^{(0)} = m_d^{(0)} = 0$.

The inequality (8.26c) was derived in Sec. 8 by using $S_A^u(x, y) = S_A^d(x, y)$. If, however, I -spin (*i.e.* $u \leftrightarrow d$) symmetry breaks spontaneously, this last equality could be violated as well! Is our argument then circular, and we proved I -spin symmetry only after assuming it at an intermediate stage?¹⁵ We do not think that this is the case. The rationale

¹⁵A similar argument was made recently [86] in a more forceful manner in connection with the second Vafa-Witten theorem, regarding the non-breaking of the discrete parity symmetry in QCD.

behind our argument was alluded to in Sec. 8 above. Spontaneous symmetry breaking is a collective long-range phenomenon manifest in the $V \rightarrow \infty$ limit.

The inequalities are proved first for finite lattices. The proof is valid for any volume V (and also for any UV momentum cutoff), no matter how large. We thus expect the inequalities to hold in the $V \rightarrow \infty$ limit.

Vafa and Witten present also a more sophisticated and compelling argument. They show that the propagator $S_\Delta^A(x, y)$ of a massive quark between two regions of size Δ and around x and y is bound for any $A_\mu(x)$ by

$$S_\Delta^A(x, y, m_0) \leq \frac{e^{-m_0|x-y|}e^{2m_0\Delta}}{m_0\Delta^4} \quad \left(m_u^{(0)} = m_d^{(0)} = m_0\right). \quad (9.5)$$

The square of this bound applies to $\text{tr} [\Gamma S_\Delta^A(x, y, m_0) \Gamma S_\Delta^A(y, x, m_0)]$. Using the weighted normalized averaging with $\int d\mu(A), d\mu(A) \geq 0$ in Eq. (8.10a), the same bound is also derived for the ‘‘smeared’’ correlation functions for any current:

$$\langle 0 | J_\Delta^a(x) [J_\Delta^a(y)]^\dagger | 0 \rangle \leq \frac{e^{-2m_0|x-y|}e^{4m_0^2\Delta}}{m_0^2\Delta^8}. \quad (9.6)$$

The finite smearing around x and y does not affect the asymptotic $|x - y| \gg \Delta$ behavior, which is still given by Eq. (8.5). Eq. (9.6) then implies that the lowest state in any mesonic channel $q_i \bar{q}_j$ has a mass satisfying

$$m_{ij}^{(0)} \geq 2m_0 \quad (\text{or } m_{ij}^{(0)} \geq m_i^{(0)} + m_j^{(0)} \text{ for } m_i^{(0)} \neq m_j^{(0)}). \quad (9.7)$$

Thus for non-vanishing bare quark masses there are no massless bosons (and by a simple extension also no massless fermions) in the physical spectrum. In particular for $m_i^{(0)} = m_j^{(0)} \neq 0$ we could have no scalar Goldstone bosons.

We now review the argument in detail. It is easy to show, first, that the propagator for a colored scalar in a background field A_μ is always maximized by the free propagator $\langle x | K_0^{-1} | y \rangle, K_0 = -\partial_\mu \partial^\mu + m_0^2$ [87]. The latter can be cast in the form of a path integral expression [88] with a positive definite integrand

$$\begin{aligned} D_0(x, y, m_0) &= \langle x | K_0^{-1} | y \rangle = \frac{1}{2} \int_0^\infty dT \langle x | e^{-(1/2)TK_0} | y \rangle \\ &= \frac{1}{2} \int_0^\infty dT \int_{x(0)=x}^{x(T)=y} dx_\mu(t) \exp \left\{ -\frac{1}{2} \left[\int_0^T \left(\frac{dX}{dt} \right)^2 dt + m^2 T \right] \right\}. \end{aligned} \quad (9.8)$$

The effect of any external gauge field is to introduce just the additional path-ordered ‘‘phase factor’’ for each path connecting $x(0) = x$ and $x(T) = y$:

$$P \left\{ \exp \left[i \int_{x(0)}^{x(T)} dx_\mu(t) A_\mu^a \lambda_a \right] \right\}. \quad (9.9)$$

This extra unitary matrix, when integrated over the positive measure in Eq. (9.8), decreases the functional integral $\int d\mu(A)$. Consequently $D_A(x, y, m_0) \leq D_0(x, y, m_0)$ (and in particular $D_A(x, y, m_0) \leq \exp[-m_0|x - y|]$).

The motion in Eq. (9.8) is formally that of a particle in four space dimensions and a proper time. Vafa and Witten utilize an analogous expression for the fermionic propagator

$$S_\Delta^A = \langle \alpha | (D + m)^{-1} | \beta \rangle = \int_0^\infty d\tau e^{-m\tau} \langle \alpha | e^{-i\tau(-iD)} | \beta \rangle, \quad (9.10)$$

where D is to be interpreted as the Dirac Hamiltonian in a (4+1) formulation, and α and β are smeared states of spatial extent Δ around x and y respectively. The norms $\langle \alpha | \alpha \rangle = \langle \beta | \beta \rangle = \Delta^{-4}$ (norm $f = \max f$ is required for the purpose of the subsequent discussion) are finite, and unitarity of $\exp[i\tau(iD)]$ implies

$$\langle \alpha | \exp[i\tau(iD)] | \beta \rangle \leq \Delta^{-4}. \quad (9.11)$$

The minimal distance between the supports of α and β is $R = |x - y| - 2\Delta$. Since the motion of the Dirac particle in 4+1 Minkowski space is causal, the minimal ‘‘time’’ required for propagation between α and β is $\tau_{\min} = R$. Using Eq. (9.11) and the lower limit $\tau_{\min} = R$ in Eq. (9.10) we obtain the desired bound (9.6) for the smeared propagator

$$S_\Delta^A \leq \left(\int_R^\infty d\tau e^{-m_0\tau} \right) \Delta^{-4} = \frac{e^{-m_0|x-y|}e^{2m_0\Delta}}{m_0\Delta^4}. \quad (9.12)$$

The smearing of the states α and β can be made gauge invariant by a refined procedure (analogous to that used by Schwinger [69]) without affecting the basic argument.

For the abelian case the current, *e.g.* $J_B^0 = \sum_i \bar{\psi}_i \gamma_\mu \psi_i$ carries no net baryon number. However, Vafa and Witten argue that if spontaneous baryon number violation is to occur we will have a vacuum expectation value of some baryon number carrying operator such as $T(x) = B_{ijk}(x) \simeq \psi^3(x)$. This, in turn, would imply that $\langle T_\Delta(x) T_\Delta(y) \rangle$ cannot have an exponential falloff. Such an exponential falloff is implied by Eq. (9.5) and $\langle T(x) T(y) \rangle \simeq \int d\mu(A) [S_A(x, y)]^6$.

The need for smearing the fermionic propagator arises from the existence of zero modes of the Dirac operator D_A [89] in any external B field $B_z(x, y)$, with $\int B_z(x, y) dx dy \geq \phi_0 \simeq (h/e)$. This lowest Landau level corresponds to the classical spiraling motion of particles along B with a Larmor radius $r \simeq B^{-1/2}$. If B is aligned with $(x-y)$ the particles originating in x do not diverge geometrically with a resultant $|x-y|^{-2}$ factor in the four-dimensional propagator. Rather, particles can be funneled from x to a spot of size $r^2 \simeq B^{-1}$ at y (see Fig.10) yielding an enhanced propagator $S_A \simeq B e^{-m_0|x-y|}$ (instead of $S_A \simeq e^{-m_0|x-y|}/|x-y|^2$). The explicit B dependence prevents the derivation of the $e^{-m_0|x-y|}$ bound directly for $S_A(x, y)$ and requires the spreading over a region of geometric size Δ^2 . Once $B \gg \Delta^{-2}$, further focusing of the motion to regions smaller than Δ^2 will not enhance the $\alpha \rightarrow \beta$ propagation and the uniform (B independent) bound Eq. (9.6) is obtained.

The same type of spiraling motion also occurs for a charged scalar particle in a magnetic field. However, in this case the motion has no corresponding zero modes. The contribution of the spiraling trajectories to the path integral expression for the bosonic propagator $D_A(x, y)$ will decay as $\sim e^{\Delta ET}$ at large proper times and is therefore unimportant, explaining the fact that $D_A(x, y)$ can be bound without utilizing the smearing procedure.

At first sight Eq. (9.7) seems somewhat surprising. In QED we have positronium states with nonzero binding and thus we might expect Eq. (9.7) to be violated in a weak coupling limit. However, recall that m_0 refers to the *bare* mass. If we have an electron and positron (or quark and antiquark), then besides the attractive interaction between e^+ and e^- there are the self-energies of e^+ and e^- . Due to the vector nature of the gauge interaction this self-interaction of a smeared (or otherwise regularized) charge distribution is repulsive. Since

$$\int d\vec{r} d\vec{r}' \rho_1(\vec{r}) K(\vec{r} - \vec{r}') \rho_2(\vec{r}') \leq \frac{1}{2} \left[\int \rho_1(\vec{r}) K(\vec{r} - \vec{r}') \rho_1(\vec{r}') + \int \rho_2(\vec{r}) K(\vec{r} - \vec{r}') \rho_2(\vec{r}') \right] \quad (9.13)$$

for any positive kernel K , the positive contribution exceeds the coulombic binding and Eq. (9.7) does hold. Scalar self-interactions can be attractive and hence this reasoning is specific to gauge theories [7]. Indeed for the scalar case $m_0 \rightarrow g\phi + m_0$, and by choosing $\phi \simeq -m_0/g$, we can generate propagators D^ϕ which do not have the characteristic $e^{-m_0|x-y|}$ behavior and the above proof of the Vafa-Witten theorem fails. For a γ_5 Yukawa coupling, $m_0 \rightarrow m_0 + ig\gamma_5$, and we even lose the positivity of the determinantal factor and of the measure.

10. BARYON-MESON MASS INEQUALITIES FROM CORRELATION FUNCTIONS

We next extend the discussion of Sec. 8 to baryonic correlation functions of currents trilinear in quark fields:

$$F_{ijk}^B = \langle 0 | B_{ijk}(x) B_{ijk}^\dagger(y) | 0 \rangle \quad (10.1a)$$

$$B_{ijk} = \psi_a^i(x) \psi_b^j(x) \psi_c^k(x) \Gamma_{abc}, \quad (10.1b)$$

with Γ_{abc} indicating some matrix in spinor space plus the ϵ_{abc} color factor. Eq. (8.5) implies that the asymptotic behavior of $F_{ijk}^B(x, y)$ is prescribed by the lowest-lying baryon in this channel (say the nucleon for $i = j = u, k = d$ and a coupling to overall spin 1/2):

$$F_{uud}^B(x, y) \approx e^{-m_N|x-y|}, \quad |x-y| \rightarrow \infty. \quad (10.2)$$

Also in analogy with Eq. (8.10a) we have a path integral representation of $F^B(x, y)$

$$F_{ijk}^B(x, y) = \int d\mu(A) S_A^i(x, y)_{aa'} S_A^j(x, y)_{bb'} S_A^k(x, y)_{cc'} \Gamma_{abc} \Gamma_{a'b'c'}. \quad (10.3)$$

The strategy for deriving the inequalities is to compare this trilinear expression with the positive definite quadratic expression for the correlation function of the pseudoscalar in the $m_i = m_j$ limit

$$F_{ij}^\pi(x, y) = \int d\mu(A) \sum_{aa'} |S_A^i(x, y)_{aa'}|^2. \quad (10.4)$$

If an inequality of the form

$$F_{ijk}^B(x, y) \leq [F_{ij}^\pi(x, y)]^{1/p} \quad (10.5)$$

can be derived, with $(1/p) > 1/2$, then Eqs. (10.2) and (8.5) imply the inequality

$$m_N > (1/p)m_\pi. \quad (10.6)$$

[If $(1/p) < 1/2$ the last relation still allows for $m_\pi \geq 2m_N$, in which case the two nucleon threshold is the lowest physical state in the $J_{u\bar{d}}^{(0^-)}$ channel and the inequality derived from Eq. (10.5) becomes the trivial $m_N \geq (2/p)m_N$.]

The baryonic correlation function in Eq. (10.5) is readily bound by

$$F_{ijk}^B(x, y) \leq \int d\mu(A) \left[\sum_{aa'} |S_A^i(x, y)_{aa'}|^2 \right]^{3/2}. \quad (10.7)$$

In order to bound the right hand side by $[F_{ij}^\pi(x, y)]^p$, Weingarten [6] appeals to the Hölder inequality [90]

$$\left| \int d\mu f g \right| \leq \left(\int d\mu |f|^p \right)^{1/p} \left(\int d\mu |g|^{p/(p-1)} \right)^{(p-1)/p}, \quad (10.8)$$

valid for $p > 1$, and chooses

$$f = \left(\sum_{aa'} |S_A^i(x, y)_{aa'}|^2 \right)^{\frac{n-3}{n-2}}$$

$$g = \left(\sum_{aa'} |S_A^i(x, y)_{aa'}|^2 \right)^{\frac{3}{2} - \frac{n-3}{n-2}} \quad (10.9)$$

so that $\int d\mu f g$ is the right hand side in Eq. (10.7). For $p = (n-2)/(n-3)$ the general Hölder inequality (10.8) implies

$$F_{ijk}^B \leq \left\{ \int d\mu(A) \sum_{aa'} |S_A^i(x, y)_{aa'}|^2 \right\}^{\frac{n-3}{n-2}} \left\{ \int d\mu(A) \left[\sum_{aa'} |S_A^i(x, y)_{aa'}|^2 \right]^{\frac{n}{2}} \right\}^{\frac{1}{n-2}}. \quad (10.10)$$

Note that the first term in curly brackets is simply $F_{ij}^\pi(x, y)$ which is then raised to a $1/p = (n-3)/(n-2)$ power. Let the number of light degenerate flavors be larger than n which we take to be even. The second term in the square brackets in Eq. (10.10), in which the integrand is raised to the $n/2$ power, then has a direct physical interpretation. It is the two-point correlation function of products of $n/2$ pseudoscalar currents with all flavors i, j_m different:

$$K(x, y) = \left\langle 0 \left| \left[J_{i_1 \bar{j}_1}^{ps}(x) J_{i_2 \bar{j}_2}^{ps}(x) \cdots J_{i_{n/2} \bar{j}_{n/2}}^{ps}(x) \right] \left[J_{i_1 \bar{j}_1}^{ps}(y) J_{i_2 \bar{j}_2}^{ps}(y) \cdots J_{i_{n/2} \bar{j}_{n/2}}^{ps}(y) \right]^\dagger \right| 0 \right\rangle. \quad (10.11)$$

There is no possibility of contracting a quark and an antiquark emanating from x (or from y), and we also have a unique pattern of contracting quark lines from x with those from y [see Fig. 11(a)] so as to form $n/2$ loops with separate color and spinor traces.

Each of these traces then yields a factor $\sum_{aa'} |S_A^i(x, y)_{aa'}|^2$ and altogether we have $(\sum_{aa'} |S_A^i(x, y)_{aa'}|^2)^{n/2}$ as required. If we now make the rather weak assumption that the lattice regularized correlation function $K(x, y)$ is finite, we deduce from Eq. (10.10), that, up to a numerical constant, Eq. (10.5) is indeed valid. Finally, we conclude from Eq. (10.6) that

$$m_N \geq \frac{n-3}{n-2} m_\pi, \quad (10.12)$$

with n the number of light degenerate quark flavors, which should be even. Thus we can obtain $m_N \geq (3/4)m_\pi$ if $n = N_f = 6$. This large number of light degenerate flavors required is associated with the particular derivation. Thus, if we assume only two light (u and d) flavors we can still construct Eq. (10.11) by taking all $i_1 \dots i_{n/2} = u$ and $\bar{j}_1 \dots \bar{j}_{n/2} = d$ and avoiding any flavor “disconnected” xx or yy contractions. We have, however, several contractions between x and y , yielding not only $\left\{ \text{tr} \left[S_A^\dagger(x, y) S_A(x, y) \right] \right\}^{n/2}$ but also terms like $\text{tr}(S_A^\dagger S_A S_A^\dagger S_A)$ [see Fig. 11].

We could improve the bound (10.12) if, instead of $K(x, y) \leq \text{constant}$, we appeal to the asymptotic behavior

$$K(x, y) \simeq e^{-m_{n/2}^{(0)}|x-y|}, \quad (10.13)$$

with $m_{n/2}^{(0)}$ the lowest mass state created by the action of $(J_{u\bar{d}}^{ps})^{n/2}$ on the vacuum. The bound derived from Eq. (10.10) would then read

$$m_N \geq \binom{n-3}{n-2} m_\pi + \left(\frac{1}{n-2} \right) m_{n/2}^{(0)}. \quad (10.14)$$

If there were no bound states in the exotic channel with $\pi_1^+ \dots \pi_{n/2}^+$ quantum numbers then the lowest state is at threshold and $m_{n/2}^{(0)} = (n/2)m_\pi$. In this case Eq. (10.14) becomes

$$m_N \geq (3/2) m_\pi, \quad (10.15)$$

the result suggested by the more heuristic discussion in Secs. 3 and 5. To our knowledge the nonexistence of exotic $\pi^+ \pi^+$ -type bound states has not been proved. This can be done in the large N_c limit (as will be discussed in Sec. 14), in which case

$$m_N \geq \frac{N_c}{2} m_\pi. \quad (10.16)$$

Weingarten [6] makes the simple observation that if $S_A(x, y)$ can be uniformly bound by an $A_\mu(x)$ independent constant,

$$S_A(x, y) \leq \text{constant}, \quad (10.17)$$

then from Eqs. (10.3) and (10.4) one can directly show that

$$F^B(x, y) \leq F^\pi(x, y), \quad (10.18)$$

implying

$$m_N \geq m_\pi. \quad (10.19)$$

We can utilize for Eq. (10.17) the Vafa-Witten bound on $S_A(x, y)$ [Eq. (9.5)]. The requisite smearing of the points x and y into two regions of size Δ around x and y respectively was shown not to effect the asymptotic $|x - y| \rightarrow \infty$ behavior and the ensuing mass relations.

Weingarten [6] has independently motivated the bound (10.16) by considerations of lattice QCD: $(\mathcal{D})_{\text{lattice}} + m_0 = m_0 + R + iI$ (with R, I being Hermitian, and R having a non-negative spectrum [91]). Thus for $m_0 > 0$, $\mathcal{D} + m_0$ has no non-vanishing eigenvalues which implies that $S_A(x, y) = \langle x | (\mathcal{D}_A + m_0)^{-1} | y \rangle$ is regular and bounded for all A_μ configurations. For $m_0 = 0$, \mathcal{D}_A does in general have zero modes which could be important for the issue of spontaneous breaking of chiral symmetry.

11. MASS INEQUALITIES AND S_χ SB IN QCD AND VECTORIAL THEORIES

The question of whether global axial symmetries are spontaneously broken in QCD (or in other field theories) is of utmost importance. In the $m_u^{(0)} = m_d^{(0)} = 0$ limit, QCD has the global axial $SU(2)$ symmetry generated by I_5^+, I_5^- , and I_5^3 . If we can show that this symmetry is spontaneously broken (*i.e.* S_χ SB occurs), then QCD is guaranteed to reproduce Goldstone pions and the successful rich phenomenology of soft pion theorems and current algebra [59] developed in the late sixties.

Conventionally, S χ SB is achieved via formation of a $q\bar{q}$ condensate in the QCD vacuum, $\langle\psi\bar{\psi}\rangle \neq 0$. $\langle\psi\bar{\psi}\rangle$ is the order parameter for a phase transition from an axial SU(2) symmetric phase at high temperature to the broken phase at low temperature [92]. $\langle\psi\bar{\psi}\rangle$ (at zero temperature) serves, along with $\langle F^2\rangle$, as one of the nonperturbative inputs in the QCD sum rules [93,94]. Many attempts have been made to prove $\langle\psi\bar{\psi}\rangle \neq 0$ in lattice QCD, to estimate its magnitude, and its finite temperature behavior. Evidently

$$\langle\psi\bar{\psi}\rangle = \int d\mu(A) \langle\psi\bar{\psi}\rangle_A, \quad (11.1)$$

and $\langle\psi\bar{\psi}\rangle_A$ was shown by Banks and Casher [95] to equal $\pi\rho(0)$, with $\rho(\lambda)$ the spectral (eigenvalue) density of the Dirac operator $i\mathcal{D}_A\psi_A^\lambda = \lambda\psi_A^\lambda$. These authors also argued that the same set of “fluxon” configurations of $A_\mu(x)$ are responsible for both confinement and the requisite dense set of zeroes of \mathcal{D}_A . This supports earlier, more heuristic arguments [96] suggesting that confinement, or binding, of a massless fermion in a vectorial theory necessarily leads to S χ SB.

The issue of S χ SB is also crucial for the case of composite models for quarks and leptons [97–99]. In such theories one assumes that the axial symmetry is *not* broken. The existence of practically massless fermions ($m_e, m_u, m_d \simeq$ a few MeV and even $m_b = 5$ GeV are very small when compared with the compositeness scale $\Lambda_p \geq$ TeV [99,100]) in the physical spectrum is then believed to be a manifestation of these axial symmetries. However, the baryon-meson mass inequalities such as $m_N \geq m_\pi$ provide an additional strong argument for S χ SB in QCD and similar vectorial theories.

Let us assume that the axial isospin symmetry (which holds in the limit $m_u^{(0)} = m_d^{(0)} = 0$) is not broken spontaneously, *i.e.* $I_5^a|0\rangle = 0$. This symmetry can then be realized linearly in the massive spectrum by having degenerate parity doublets. However, one can show via the ’t Hooft anomaly matching condition [12] that we must also have at least one $I = 1/2$ massless physical spin-1/2 fermion (the nucleon).

Anomaly constraints have been discussed extensively [12,13,101]. Following Ref. [101], we consider the vertex

$$\Gamma_{\mu\nu\lambda}(q_1q_2q_3) = \int d^4x_1 \int d^4x_2 e^{i(q_1x_1+q_2x_2)} \langle 0|T [J_\mu(x_1)J_\nu(x_2)J_\lambda(x_3)]|0\rangle \quad (11.2)$$

of three identical flavor currents, which, in terms of chiral right and left combinations are

$$J^\mu = \bar{\psi}_i^a \gamma^\mu [A_{+(ij)}(1 + \gamma_5) + A_{-(ij)}(1 - \gamma_5)] \psi_{aj}, \quad (11.3)$$

with A_\pm matrices in flavor space. We take $\text{tr}A_+ = \text{tr}A_- = 0$ to avoid the γ_5 anomaly involving SU(N_c) gluons

$$\partial_\mu J^\mu = \alpha_c(\text{tr}A_+ - \text{tr}A_-)\text{tr}F\bar{F} = 0. \quad (11.4)$$

It was shown [72,73,102] that $\Gamma_{\mu\nu\lambda}$ satisfies the anomalous Ward identity

$$q_3^\lambda \Gamma_{\mu\nu\lambda} = \frac{N_c}{\pi^2} \text{tr}(A_+^3 - A_-^3). \quad (11.5)$$

The right hand side is given by the lowest triangular graph involving the massless fundamental fermions of the theory.

Equation (11.5) is true to all orders [101,103] and most likely is a genuine nonperturbative result. Equation (11.5) implies that some invariant amplitudes in the decomposition of $\Gamma_{\mu\nu\lambda}$ have a pole at $(q_3)^2 = 0$ of prescribed residue, given by “the anomaly”, *i.e.* the right hand side of Eq. (11.5). Such a singularity can arise either by

- (a) having zero mass (pseudo-) scalar boson states with appropriate nonvanishing $\langle n^0 | J_\mu^+ | 0 \rangle$ matrix elements; or by
- (b) having a multiplet of massless spin 1/2 physical fermions (“nucleons”) such that in this basis

$$J^\mu = \bar{\psi}_N^i \gamma^\mu [B_{+(ij)}(1 + \gamma_5) + B_{-(ij)}(1 - \gamma_5)] \psi_N^j, \quad (11.6)$$

with a “matched anomaly”

$$\text{tr}(B_+^3 - B_-^3) = \text{tr}(A_+^3 - A_-^3). \quad (11.7)$$

Possibility (a) implies $Q|0\rangle \neq 0$ with Q the charge $\int d^3x J_0(x)$, *i.e.* a spontaneous breaking, which we assumed does not occur. This leaves us then with possibility (b), *i.e.* the need to have massless fermions satisfying Eq. (11.7). The last algebraic anomaly condition constrains the various composite models of quarks and leptons where the latter are the massless physical states N_i [12,99].

Let us now appeal to a new element, namely to the nucleon-pion (or fermion-boson) mass inequalities

$$m_N \geq m_\pi \quad (m_F \geq m_B). \quad (11.8)$$

Possibility (b) of massless fermions can then be ruled out. Eq. (11.8) implies that if the nucleons are massless so are the pions. However, unless the matrix element $\langle 0|J_\mu^5|\pi\rangle \simeq f_\pi q_\mu$ accidentally vanishes and the pion “decouples”, we then have spontaneous breaking of the axial symmetry which is precisely the possibility that we were trying to exclude.

It has been shown [104] that in the $N_c \rightarrow \infty$ limit, that anomaly matching via possibility (b) is ruled out. Amusingly in this limit we have, as indicated in Sec. 14 below, the inequality (10.16): $M_N \geq (N_c/2)m_\pi$. It excludes, for infinite N_c (and some very small non-vanishing $m_u^{(0)}$ and $m_d^{(0)}$ and consequently finite m_π) even finite baryon masses, so that alternative (b) cannot *a fortiori* be realized.

It is interesting to see how the inequality (11.8) is satisfied if we introduce a small explicit breaking of the axial symmetry via $m_u^{(0)} = m_d^{(0)} \neq 0$. In this case we have no strict arguments for the vanishing of either m_N and/or m_π .

From Eq. (9.3), we have $m_\pi \sim \sqrt{m^0}$. If the nucleon mass is generated exclusively via the explicit chiral symmetry breaking term $m^0 \bar{\psi}_q \psi_q$, then this term and $m_N \bar{\psi}_N \psi_N$ both have to flip sign under the discrete $\exp[i\pi Q_5]$ transformation. This suggests that $m_N \simeq am^0 < m_\pi \sim \sqrt{m^0}$ for small m^0 , violating the inequality $m_N \geq m_\pi$. This in turn rules out the possibility of explicit chiral symmetry breaking only and S χ SB is again indicated.

An alternate approach to proving S χ SB [105] would be to start from the Weingarten inequality (8.24) for the pseudoscalar and scalar two-point correlation functions:

$$J_{ps}^{ij} = \bar{\psi}_i \gamma_5 \psi_j, \quad J_s^{ij} = \bar{\psi}_i \psi_j; \quad i = u, j = d, \quad (11.9)$$

and show that the inequality is strict

$$\langle 0|J_{ps}^{ij}(x)J_{ps}^{ij}(y)|0\rangle > \langle 0|J_s^{ij}(x)J_s^{ij}(y)|0\rangle. \quad (11.10)$$

If chiral symmetry remains unbroken ($Q_5|0\rangle = 0$), we can show, by utilizing

$$e^{-i\pi Q_5} J_s^{ij} e^{i\pi Q_5} = J_{ps}^{ij}$$

that

$$\langle 0|J_{ps}^{ij}(x)J_{ps}^{ij}(y)|0\rangle = \langle 0|J_s^{ij}(x)J_s^{ij}(y)|0\rangle. \quad (11.11)$$

Thus, proving Eq. (11.10) would amount to proving S χ SB.

The fermionic propagator in a background field can in general be decomposed in terms of the Dirac γ matrices:

$$S_F(x, y; A) = S(x, y; A)I + \gamma_\mu v^\mu(x, y; A) + \sigma_{\mu\nu} t^{\mu\nu}(x, y; A) + \gamma_5 \gamma_\mu a^\mu(x, y; A) + \gamma_5 p(x, y; A). \quad (11.12)$$

Substituting this last expression into Eq. (8.10a) with $\Gamma = \gamma_5$ and $\Gamma = I$, and utilizing Eq. (8.20), we find that v^μ and a^μ contribute equally to $(J_{ps} J_{ps})$ and $(J_s J_s)$. However, $s, t^{\mu\nu}$, and p contribute $|s|^2 + |t^{\mu\nu}|^2 + |p|^2$ to the first correlation and $-|s|^2 - |t^{\mu\nu}|^2 - |p|^2$ to the second. Thus, if we can pinpoint any set of gauge field configurations for which

$$\int d\mu(A) (|s|^2 + |t^{\mu\nu}|^2 + |p|^2) > 0 \quad (11.13)$$

then those configurations could generate S χ SB by making the strict inequality hold. Note that the positivity of expression (11.13) and of $d\mu(A)$ insures that the effect of such configurations cannot be cancelled by some other configurations.

The topologically invariant relation

$$\int d^4x p(x, x; A) = \int d^4x \text{tr} [S(x, x; A)\gamma_5] = \frac{1}{m_0} \int d^4x F_{\mu\nu}(x)\tilde{F}_{\mu\nu}(x) \quad (11.14)$$

suggests that if we have an instanton [106] – anti-instanton [107] gas, the contribution of the region near any pseudoparticle is

$$\int d^4x p(x, x; A) \simeq \pm 1, \text{ and } \int d\mu(A) |p(x, x; A)|^2 > 0. \quad (11.15)$$

Indeed, it has been speculated by several authors [107,108] that instantons may be the source of $S\chi SB$. The detailed quark propagator structure in Eq. (11.12) was utilized in [109,110].

One may try showing directly the existence of a zero mass state in the QCD spectrum in the $m_u^{(0)} = m_d^{(0)} = 0$ limit. Thus, if the representation for the pseudoscalar propagator

$$\langle J_{ps}^{u\bar{d}}(x) J_{ps}^{u\bar{d}}(y) \rangle = \int d\mu(A) \text{tr} \left[S_A^\dagger(x, y) S_A(x, y) \right]$$

as a sum of positive definite contributions could be used to show a power falloff of the correlation function, then the existence of massless hadronic states with 0^- quantum numbers (massless pions or massless nucleons) would follow.

The above program attempts to achieve the opposite goal as compared with the original work of Vafa and Witten [7] described in Sec. 9, where upper bounds on the euclidean correlation function were found. It has not been realized in the form described above. Vafa and Witten have, however, succeeded by combining the measure positivity and various index theorems to prove a closely related result [9] which we will briefly describe next. They considered the k -point function

$$S(x_1, \dots, x_k) = \langle 0 | \bar{\psi}_1 \psi_2(x_1) \bar{\psi}_2 \psi_3(x_2) \dots \bar{\psi}_k \psi_1(x_k) | 0 \rangle. \quad (11.16)$$

With all fermionic flavors distinct, there is a unique, cyclic pattern of contractions. The k -point function then has the path integral representation

$$S(x_1, \dots, x_k) = \int d\mu(A) \text{tr} [S_A(x_1, x_2) \dots S_A(x_k, x_1)]. \quad (11.17)$$

Integrating over all x_i and using translational invariance defines

$$\begin{aligned} S(k) &= \int d^4x_1 \dots \int d^4x_{k-1} S(x_1, x_2, \dots, x_{k-1}, x_k = 0) \\ &= \frac{1}{V} \int d^4x_1 \dots \int d^4x_k S(x_1, x_2) \dots S(x_{k-1}, x_k). \end{aligned} \quad (11.18)$$

The idea is to prove that (after appropriate regularization)

$$S(k) \geq C_k S_0(k), \quad (11.19)$$

with

$$S_0(k) = 4d(R) \int \frac{d^4p}{(2\pi)^4} \left(\frac{1}{p^2} \right)^{(k/2)} \quad (11.20)$$

[here $d(R)$ is the dimension of the (color) representation of the fermions], the corresponding expression for the free massless fermions. This implies that for $k \geq 4$, $S(k)$ has, like $S_0(k)$, infrared divergences which in terms of the physical states can be understood only if we had zero mass hadronic states. $S(k)$ can be written, using Eqs. (11.17) and (11.18), as

$$S(k) = \int d\mu(A) S_A(k) \quad (11.21a)$$

$$S_A(k) = \frac{1}{V} \int d^4x_1 \dots \int d^4x_k \text{tr} [S_A(x_1, x_2) \dots S_A(x_k, x_1)] = \frac{1}{V} \text{tr} \left[\left(\frac{1}{D_A} \right)^k \right], \quad (11.21b)$$

where the last trace and operator multiplication refer not only to color and spinor space but x space as well. To prove Eq. (11.19), it is clearly sufficient to show, due to the measure positivity, that

$$S_A(k) \geq C_k S_0(k) \quad (11.22)$$

holds for each A_μ configuration separately. $S_A(k)$ can be expressed in terms of a Dirichlet sum over the eigenvalues of D_A :

$$iD_A\psi = \lambda\psi \quad (11.23)$$

$$S_A(k) = \frac{1}{V} \sum_{i=1}^{\infty} \lambda_i^{-k}, \quad (11.24)$$

with $\lambda_1, \lambda_2, \dots, \lambda_N$ the eigenvalues in ascending order. Vafa and Witten then prove that the lowest eigenvalue λ_1 scales with the size of the box considered as

$$\lambda_1 \leq \frac{C}{L} = CV^{-1/4}, \quad (11.25)$$

with C independent of the gauge field. This implies, for even k , that $S(k) \geq C^{-k} V^{\frac{k-4}{4}}$ and the required infrared divergence ensues when $k > 4$ (the limiting case of $k = 4$ can also be handled by a more refined discussion). We will not present here the proof of Eq. (11.25) which involves topological considerations and tracing out the flow of eigenvalues under gauge deformations and refer the reader to the original paper [9].

All the above discussion, while strongly suggesting $S\chi SB$ in QCD, fails to demonstrate that $\langle \bar{\psi}\psi \rangle$ is indeed non-zero. Recently Stern [111] suggested a novel pattern of $S\chi SB$ in QCD with the pseudoscalars still being the Nambu-Goldstone bosons associated with this spontaneous breaking, but where $\langle \bar{\psi}\psi \rangle = 0$. Indeed, as Kogan, Kovner, and Shifman [112] noted, there could be some residual ‘‘custodial’’ discrete Z_N axial symmetry which allows only higher $(\bar{\psi}\psi)^N$ order parameters to have non-vanishing VEVs. The new scheme is phenomenologically interesting. In particular, since now $m_\pi^2 = \mathcal{O}(m_q^2)$, larger values of $m_u^{(0)}$, $m_d^{(0)}$, and a more symmetric $m_u^{(0)}$, $m_d^{(0)}$, $m_s^{(0)}$ mass pattern would be implied.

However, as pointed out by Kogan, Kovner, and Shifman [112], the inequality

$$C_A(x) \equiv \langle 0 | J_{\mu,A}^\dagger(x) J_{\mu,A}(0) | 0 \rangle \leq \langle 0 | J_{ps}^\dagger(x) J_{ps}(0) | 0 \rangle \equiv C_{ps}(x), \quad (11.26)$$

can be judiciously utilized to rule out this pattern. Both correlators have their asymptotic behavior controlled by the lightest 0^- pion states, *i.e.* $C_A(x), C_{ps}(x) \simeq e^{-m_\pi|x|}$ for $x \rightarrow \infty$. However, the vacuum-to-pion axial matrix element has the conventional form

$$\langle 0 | J_\mu^a | \pi^b \rangle = i q_\mu F_\pi \delta^{ab},$$

with F_π scaling like Λ_{QCD} and not vanishing in the $m_q \rightarrow 0$ limit; whereas the vacuum-to-pion pseudoscalar matrix element behaves in this scheme as

$$\langle 0 | J_{ps}^a | \pi^b \rangle = \delta_{ab} \mathcal{O}(m_q).$$

If $M \simeq \mathcal{O}(\Lambda_{\text{QCD}})$ is the mass of the first massive (non-pion) state in the 0^- channel, then for $m_\pi^{-1} \gg x \gg M^{-1}$, we have [recalling that the pion intermediate state still dominates $C_{ps}(x)$]

$$C_{ps}(x) \simeq m_q e^{-m_\pi|x|} \simeq m_\pi^2 e^{-m_\pi|x|},$$

and

$$C_A(x) \simeq \frac{e^{-m_\pi|x|}}{x^2},$$

and the inequality (11.26) is violated.

The analog of Eq. (11.8) holds also for composite models based on an underlying vectorial gauge interaction [18]. This interaction should confine the massless hyperons at a scale $(\Lambda_p)^{-1}$, leaving us with the quarks, leptons, Higgs particles, and conceivably also W^\pm, Z^0 (and even the photon in some models!) as the low lying physical states.

Eq. (11.8) suggests that global axial symmetry, assumed to protect the (almost!) massless fermions from acquiring large masses $\sim \Lambda_p$, does spontaneously break down. The analog of (11.8) here is $m_F \geq m_H$ and the fact that we have no Higgs particles lighter than the lightest quarks and leptons is bothersome. (A scenario with only three Higgs states, which disappeared in the process of $SU(2) \times U(1)$ breaking, appears to conflict the existence of several

fermionic generations.) Finally, we note that the $m^{(1^-)} \geq m^{(0^-)}$ inequality suggests that any composite vector particle should be massive, and gauge symmetries, and in particular the exact $U(1)_{\text{EM}}$ (with $m_\gamma \leq 10^{-20}$ eV! [113]) should not arise “accidentally” due to the existence of almost zero mass vectorial bound states.

All the constraints stemming from mass inequalities do not apply to chiral preonic theories [114–116], and/or preonic theories with fermions and bosons with Yukawa couplings [118]. In this case the measure positivity $d\mu(A)$ is lost (inequalities cannot be proven in supersymmetric models). Also in chiral models the pseudoscalar current $\bar{\psi}\gamma_5\psi$ which was used extensively above vanishes identically. The mass inequalities, together with the study of the anomaly constraints, shifted the focus of research for composite models from the early work on vectorial models [18,117] to chiral and/or fermion-boson composite models [114,116,119,120] suggested earlier.¹⁶ Indeed it was observed [123] that in gauge and scalar (not pseudoscalar!) field theories, one can then prove the inequality

$$\langle 0|\phi^\dagger(x)\phi(x)\phi^\dagger(0)\phi(0)|0\rangle\langle 0|\bar{\psi}(x)\gamma_5\psi(x)\bar{\psi}(0)\gamma_5\psi(0)|0\rangle \geq |\langle 0|\phi^\dagger(x)\psi(x)\phi^\dagger(0)\psi(0)|0\rangle|^2, \quad (11.27)$$

by integrating over $\psi, \bar{\psi}$. Using the positivity of the $d[A_\mu]d[\phi]e^{-S[A_\mu,\phi]}$ integration and of the pseudoscalar correlator, the desired relation follows readily as a Schwartz-type inequality. However, we *cannot* now infer the mass inequality $m_F \geq (1/2)(m_\pi + m_\chi)$ between the lightest particles in the $\phi^\dagger\psi$, $\bar{\psi}\gamma_5\psi$, and $\phi^\dagger\phi$ channels, simply because the $\langle\phi^\dagger\phi(x)\phi^\dagger\phi(0)\rangle$ correlator always has the constant $(\langle 0|\phi^\dagger\phi|0\rangle)^2$ contribution due to the vacuum state, which cannot be avoided without spoiling the positivity. This negates the claim made by Nussinov in [19].

Hsu [81] suggested that QCD, and in particular the Vafa-Witten inequalities along with the measure positivity for $SU(2)$ chiral with an even number of flavors, can be used to exclude the possibility that such strongly interacting chiral theories underlie the standard EW model [124,125]. Since his analysis relies on Vafa-Witten upper bounds for *both* fermionic and scalar propagators, one needs to choose a regularization point where the $\lambda\phi^4$ coupling vanishes (otherwise the quadratic integral defining $S_\phi[A_\mu(x,0)]$ cannot be performed).

For a long period it was not clear, in view of difficulties encountered in putting the theory on the lattice [126], if consistent chiral gauge theories could be defined. However, the recent domain wall fermions [78] and overlap formalism [127] put the (lattice) regularization of fermionic theories with gauge interactions on a much more solid foundation. These developments also allowed for lattice calculations incorporating chiral symmetries in a more explicit manner [128,129]. Most likely proper regularization of chiral gauge theories [130] will also soon be feasible. Our preceding discussion then suggests that chiral composite models for quarks and leptons may revive.

We will not pursue here the possibility that this novel approach could “rigorize” the derivation of (some) of the QCD inequalities.

12. INEQUALITIES BETWEEN MASSES OF PSEUDOSCALAR MESONS

In this section we conclude the discussion of mass inequalities in the non-exotic qqq (baryonic) and $q\bar{q}$ (mesonic) channels, by proving that [10]:

$$m_{i\bar{j}}^{(0^-)} \geq \frac{1}{2} \left[m_{i\bar{i}}^{(0^-)} + m_{j\bar{j}}^{(0^-)} \right], \quad (12.1a)$$

with $m_{i\bar{j}}^{(0^-)}$ the mass of the lowest lying pseudoscalar meson in the $q_i\bar{q}_j$ channel; and [10,19]

$$m_{\pi^+} \geq m_{\pi^0}. \quad (12.1b)$$

The derivation of both inequalities relies on the positivity of the integrand in the functional integral expressing correlation functions of pseudoscalar currents. We have, however, to make the additional assumption (a) that the $q\bar{q}$ annihilation channels generating the flavor disconnected part [Eq. (8.10b)] make negligible contributions. For the derivation of Eq. (12.1b) we could assume instead (b) the validity of the soft pion expression [131] for $(m_{\pi^+}^2 - m_{\pi^0}^2)$ in terms of the (axial) vector spectral functions [10]. In order to derive Eq. (12.1a) we compare the three correlation functions

$$\langle 0|J_{i\bar{j}}^p(x) [J_{i\bar{j}}^p(y)]^\dagger |0\rangle = \int d\mu(A) \text{tr} \left\{ [S_A^i(x,y)]^\dagger S_A^j(x,y) \right\} \quad (12.2a)$$

¹⁶Aharony *et al.* [121] found that QCD-type inequalities were still useful in SUSY theories, though in the $m_{\text{Higgsino}} \rightarrow \infty$ limit (see App. F). Nishino [122] has shown, using the Vafa-Witten inequalities, that in SUSY theories parity is conserved.

$$\langle 0 | J_{i\bar{i}}^p(x) [J_{i\bar{i}}^p(y)]^\dagger | 0 \rangle = \int d\mu(A) \text{tr} \left\{ [S_A^i(x, y)]^\dagger S_A^i(x, y) \right\} \quad (12.2b)$$

$$\langle 0 | J_{j\bar{j}}^p(x) [J_{j\bar{j}}^p(y)]^\dagger | 0 \rangle = \int d\mu(A) \text{tr} \left\{ [S_A^j(x, y)]^\dagger S_A^j(x, y) \right\} \quad (12.2c)$$

where we have left out, following our assumption (a), the flavor disconnected contribution, *e.g.* $\int d\mu(A) \text{tr} [\gamma_5 S_A^i(x, x)] \text{tr} [\gamma_5 S_A^i(y, y)]$ in Eq. (12.2b). The expressions in Eqs. (12.2b) and (12.2c) have the form of perfect squares of vectors $S_{A\alpha a}^i$ (or $S_{A\alpha a}^j$) with $A_\mu(x)$ and α, a the spinor, color indices viewed as a joint index. Equation (12.2a) is the corresponding scalar product $S_{A\alpha a}^i \cdot S_{A\alpha a}^j$. The Schwartz inequality $(S^i)^2 (S^j)^2 \geq |S^i \cdot S^j|^2$ therefore implies that

$$\left| \langle 0 | J_{i\bar{j}}^p(x) [J_{i\bar{j}}^p(y)]^\dagger | 0 \rangle \right|^2 \leq \langle 0 | J_{i\bar{i}}^p(x) [J_{i\bar{i}}^p(y)]^\dagger | 0 \rangle \langle 0 | J_{j\bar{j}}^p(x) [J_{j\bar{j}}^p(y)]^\dagger | 0 \rangle \quad (12.3)$$

and Eq. (12.1a) immediately follows from the last inequality by using Eq. (8.5) and going to the $|x - y| \rightarrow \infty$ limit, where

$$\langle 0 | J_{i\bar{j}}^p(x) [J_{i\bar{j}}^p(y)]^\dagger | 0 \rangle \simeq e^{-m_{i\bar{j}}^{(0^-)} |x-y|}. \quad (12.4)$$

Eq. (12.3) is the lowest in a hierarchy of inequalities stating that all the principle minors of the matrix $M_{ij} = S^i \cdot S^j$ are positive. However, as can be readily verified by considering the 3×3 minors, no useful new mass inequalities follow.

We have noted in our earlier more heuristic discussion of the inequalities the need for making a ‘‘Zweig rule’’ assumption (a). It amounts to suppressing the annihilation of $q_i \bar{q}_i$ into gluons and allows us to consider the mesonic sector $m_{i\bar{i}} = q_i \bar{q}_i$ to be distinct from $m^{(0)}$, the flavor vacuum sector. This is valid particularly in the heavy flavor $Q\bar{Q}$ sector.

The inequalities are also automatically satisfied in a soft pion limit with $[m_{ij}^{(0^-)}]^2 \simeq (f_\pi)^{-2} \langle \bar{\psi}\psi \rangle [m_i^{(0)} + m_j^{(0)}]$ [85]. We recall that in the actual comparison with particle data in Sec. 7, the pseudoscalar inequalities were indeed satisfied with a larger margin than the other inequalities.

We next prove Eq. (12.1b) along similar lines [19]. We compare the propagators

$$\langle J_{\pi^+}^p(x) J_{\pi^-}^p(y) \rangle = \int d\mu(A) \text{tr} \left\{ [S_A^u(x, y)]^\dagger S_A^d(x, y) \right\} \quad (12.5a)$$

and

$$\langle J_{\pi^0}^p(x) J_{\pi^0}^p(y) \rangle = \frac{1}{2} \int d\mu(A) \text{tr} \left\{ [S_A^u(x, y)]^\dagger S_A^u(x, y) + [S_A^d(x, y)]^\dagger S_A^d(x, y) \right\}, \quad (12.5b)$$

with

$$J_{\pi^+}^p = \bar{\psi}_u \gamma_5 \psi_d \quad (12.6a)$$

$$J_{\pi^0}^p = \frac{1}{\sqrt{2}} (\bar{\psi}_u \gamma_5 \psi_u - \bar{\psi}_d \gamma_5 \psi_d), \quad (12.6b)$$

i.e. the pseudoscalar currents with the quantum numbers of the π^+ , π^0 mesons respectively. We can take into account electromagnetic effects, which are the source of the $\pi^+ - \pi^0$ mass difference¹⁷, by considering the gauge group to be $SU(3)_C \times U(1)_{EM}$. The path integral measure then becomes

¹⁷It was realized early on that the Cottingham formula expressing the EM contributions to the mass differences, converges to the correct $\pi^+ - \pi^0$ mass difference [132,133], and fails for the $K^+ - K^0$ and $n - p$ difference – for which $m_d^{(0)} - m_u^{(0)}$ makes the dominant contribution.

$$d\mu(A) = d[A_\mu^C] d[A_\mu^{\text{EM}}] e^{-S_{\text{YM}}(A_\mu^C)} e^{-S_{\text{EM}}(A_\mu^{\text{EM}})} \prod_{j=1}^{N_f} \text{Det} [\mathcal{D}_{(A_C, A_{\text{EM}})} + m_j] , \quad (12.7)$$

and the propagator in the joint external fields is

$$S_A^j(x, y) = \langle x | [\mathcal{D}_{(A_C, A_{\text{EM}})} + m_j]^{-1} | y \rangle . \quad (12.8)$$

Since the EM interaction is vectorial, the arguments leading to the measure positivity, $d\mu(A) \geq 0$, and the positive definite form of the integrand for the pseudoscalar correlation functions remains intact. Comparing Eqs. (12.5a) and (12.5b) we can then show, from $a^2 + b^2 \geq 2a \cdot b$, that

$$\langle J_{\pi^0}^p(x) J_{\pi^0}^p(y) \rangle \geq \langle J_{\pi^+}^p(x) J_{\pi^-}^p(y) \rangle , \quad (12.9)$$

from which $m_{\pi^+} \geq m_{\pi^0}$ readily follows.

The starting point for the original derivation of $m_{\pi^+} \geq m_{\pi^0}$ by Witten [10] is the soft pion – current algebra relation [131]

$$m_{\pi^+}^2 - m_{\pi^0}^2 = \frac{e^2}{f_\pi^2} \int \frac{d^4 k}{k^2} [\langle V_\mu^3(k) V_\mu^3(-k) \rangle - \langle A_\mu^3(k) A_\mu^3(-k) \rangle] , \quad (12.10)$$

expressing the $\pi^+ - \pi^0$ mass difference as an integral over the momentum space vector and axial vector (isovector) correlation functions. The latter are Fourier transforms of the euclidean space correlation functions which can be expressed via Eq. (8.10a), so that we have

$$\begin{aligned} & \langle V_\mu^3(k) V_\mu^3(-k) \rangle - \langle A_\mu^3(k) A_\mu^3(-k) \rangle \\ &= \frac{2}{V} \int d^4 x e^{ikx} \int d^4 y e^{-iky} \\ & \times \int d\mu(A) \text{tr} [\gamma_\mu S_A(x, y) \gamma_\mu S_A(y, x) - \gamma_\mu \gamma_5 S_A(x, y) \gamma_\mu \gamma_5 S_A(y, x)] \\ &= \frac{2}{V} \int d^4 x e^{ikx} \int d^4 y e^{-iky} \\ & \times \int d\mu(A) \text{tr} [\gamma_\mu S_A(x, y) \gamma_\mu - \gamma_\mu \gamma_5 S_A(x, y) \gamma_\mu \gamma_5] S_A(y, x) . \end{aligned} \quad (12.11)$$

To this lowest, α_{EM} order, there are no flavor disconnected contributions to the isovector correlation function. The factor of 2 comes from $V_\mu = \bar{\psi} \gamma_\mu T^3 \psi$ with $\text{tr} [(T^3)^2] = 2$.

We note that in the present case – unlike in all previous inequalities – the actual sign of the expression in (12.11) is of crucial importance. A minus sign coming from the fermion loop has been cancelled by the fact that the euclidean currents are $V_\mu = i\bar{\psi} \gamma_\mu \psi$ (and $A_\mu \simeq i\bar{\psi} \gamma_\mu \gamma_5 \psi$) and the i^2 supplies the extra minus sign. $[\gamma_\mu^M \rightarrow i\gamma_\mu^E]$ is essential since the euclidean γ_μ are hermitian and satisfy $\{\gamma_\mu^E, \gamma_\nu^E\} = \delta_{\mu\nu}$, whereas $\{\gamma_\mu^M, \gamma_\nu^M\} = g_{\mu\nu}$.

The difference $[\gamma_\mu S_A(x, y) \gamma_\mu - \gamma_\mu \gamma_5 S_A(x, y) \gamma_\mu \gamma_5]$ occurring in Eq. (12.11) is simply $\gamma_\mu E_A(x, y) \gamma_\mu$, with $E_A(x, y) = \langle x | m_0 (-D_A^2 + m_0^2)^{-1} | y \rangle$, the γ_5 even part of $S_A(x, y) = \langle x | (D_A + m_0)^{-1} | y \rangle = E_A(x, y) + O_A(x, y)$. The odd $O_A(x, y)$ behaves like a product of an odd number of γ matrices. Thus $\text{tr}(\gamma_\mu E_A \gamma_\mu O_A) = 0$, and Eq. (12.11) can be rewritten as

$$\begin{aligned} \langle V_\mu^3(k) V_\mu^3(-k) \rangle - \langle A_\mu^3(k) A_\mu^3(-k) \rangle &= \frac{2}{V} \int d^4 x e^{ikx} \int d^4 y e^{-iky} \\ & \times \int d\mu(A) \text{tr} [\gamma_\mu E_A(x, y) \gamma_\mu E_A(y, x)] . \end{aligned} \quad (12.12)$$

Viewing $M_\mu \equiv e^{ikx} \gamma_\mu = e^{ikx} (\gamma_\mu)_{\alpha\alpha'}$ as a matrix in spinor ($\alpha\alpha'$) and coordinate space jointly, we can rewrite this last expression as

$$\langle V_\mu^3(k) V_\mu^3(-k) \rangle - \langle A_\mu^3(k) A_\mu^3(-k) \rangle = \frac{2}{V} \int d\mu(A) \text{tr} [M_\mu E_A M_\mu^* E_A] , \quad (12.13)$$

where the last trace and matrix multiplications refer also to the coordinates x, y as indices.

The operator E_A is positive definite, as can be seen by going to the basis defined by $iD_A|\lambda_A\rangle = \lambda_A|\lambda_A\rangle$. In this basis

$$\text{tr} [M_\mu E_A M_\mu^* E_A] = \sum_{\lambda_A, \lambda_{A'}} |(M_\mu)_{\lambda_A \lambda_{A'}}|^2 \frac{m_0^2}{(\lambda_A^2 + m_0^2)(\lambda_{A'}^2 + m_0^2)}$$

is manifestly positive. The measure positivity then implies that $\int d\mu(A) \text{tr} [M_\mu E_A M_\mu^* E_A]$ is also positive (non-negative). We finally arrive at

$$\langle V_\mu^3(k) V_\mu^3(-k) \rangle - \langle A_\mu^3(k) A_\mu^3(-k) \rangle \geq 0, \quad (12.14)$$

and $m_{\pi^+} \geq m_{\pi^0}$ follows from Eq. (12.10).

It is amusing to note that the Eq. (12.14) complements the asymptotic chiral symmetry [134] $\langle V_\mu^3(k) V_\mu^3(-k) \rangle \simeq \langle A_\mu^3(k) A_\mu^3(-k) \rangle$, as $k \rightarrow \infty$. Such an asymptotic equality is indeed required for the d^4k integration in Eq. (12.10) to converge. It motivated the spectral function sum rules of Weinberg [135] some time ago. Using unsubtracted dispersion relations for $\langle V_\mu^3(k) V_\mu^3(-k) \rangle$ and $\langle A_\mu^3(k) A_\mu^3(-k) \rangle$, the inequalities (12.14) imply

$$\int d\mu^2 \sigma_V(\mu^2)(\mu^2 + k^2)^{-1} \geq \int d\mu^2 \sigma_A(\mu^2)(\mu^2 + k^2)^{-1}, \quad (12.15)$$

with $\sigma_V(\sigma_A)$ the vector (axial vector) spectral functions.

The configuration space analog of the inequality

$$\langle A_\mu(x) A_\mu(0) \rangle \leq \langle V_\mu(x) V_\mu(0) \rangle \quad (12.16)$$

has been discussed at length [136] but no convincing proof exists at present. One difficulty is that the one pion contribution to the “longitudinal” part of the axial correlator $C_A(x) \simeq e^{-m_\pi|x|}$ dominates at large distances and an appropriate transverse projection of $\langle A_\mu A_\nu \rangle$ is required. (This is not the case in momentum space since the large pion pole contribution at small k is suppressed by $k^\mu k^\nu$ “derivative coupling” factors.)

Efforts to prove such an inequality are motivated not only by the experimental fact that the lightest hadrons in the $1^-, 1^+$ sectors satisfy $m_{a_1} > m_\rho$. Precision tests of the weak interactions indicate that the “ S parameter” [137,138]

$$S \equiv \frac{d}{dk^2} [F_V(k^2) - F_A(k^2)] |_{k^2=0}, \quad (12.17)$$

with F_V, F_A the covariant (transverse) parts of $\langle A_\mu(k) A_\mu(-k) \rangle$ and $\langle V_\mu(k) V_\mu(-k) \rangle$, is negative. The second moment of the conjectured inequality (12.16) will imply that $S > 0$ in all vectorial theories such as the original technicolor models [139,140], thereby ruling those out as viable mechanisms for dynamical breaking of the EW symmetry of the Standard Model.

The previous derivation of $m_{\pi^+} \geq m_{\pi^0}$, based on Eq. (12.9), did not utilize the soft pion limit (tantamount to letting $m_u^{(0)} + m_d^{(0)} \rightarrow 0$), but only the weaker assumption of isospin $|m_u^{(0)} - m_d^{(0)}| \rightarrow 0$. [In particular isospin was utilized to argue that there are no disconnected purely gluonic intermediate state contributions to $\langle 0 | J^{P(\pi^0)}(y) | n \rangle$.]

At first sight the previous derivation appears to lead to a stronger result. This however is not the case [141]. The point is that there are intermediate states with one photon which make

$$\langle 0 | (\bar{\psi}_u \gamma_5 \psi_u - \bar{\psi}_d \gamma_5 \psi_d) | \text{multigluon state} + \gamma \rangle \neq 0, \quad (12.18)$$

and which contribute to the same order $\mathcal{O}(\alpha_{\text{EM}})$. (Because of charge conjugation parity and color neutrality, the lowest perturbative state of this type consists of at least three gluons and a photon.) This contribution could be neglected if we appeal to the analog of the Zweig rule hypothesis (a) used above. Alternatively, we could go to the soft π^0 limit in which case all the couplings of the Goldstone particle to the photon and any neutral hadronic system [the “multigluon state” in Eq. (12.18)] must vanish.

Since the EM interaction conserves $J_{\mu A}^3$, soft pion theorems imply that the EM contributions to a massless neutral Goldstone particle vanish to all orders. Thus, if $m_{\pi^0}(\alpha = 0) = 0$ then also $m_{\pi^0}(\alpha \neq 0) = 0$. The result $m_{\pi^+}^2 \geq m_{\pi^0}^2$, and its analog in other vectorial gauge theories, is therefore of great importance. Otherwise $m_{\pi^+}^2 \leq m_{\pi^0}^2 = 0$ and the π^+ becomes tachyonic. A condensate of charged pions could then form, leading potentially to spontaneous violations of EM charge conservation. Similar results like $m_{\pi^+}^{(T)} \geq m_{\pi^0}^{(T)}$ could help fix the pattern of symmetry breaking or “vacuum alignment” [142,143] in other vectorial theories such as technicolor [144,145].

The inequality $m_{\pi^+} \geq m_{\pi^0}$ is one aspect of the general property mentioned in Sec. 9 [see in particular Eq. (9.7)] that vectorial interactions make positive contributions to the masses of physical particles. We can motivate this result (see Sec. 9) by considering the EM self-interactions and mutual interactions between arbitrary charge distributions (representing *e.g.* the extended constituent quarks and including effects of $q\bar{q}$ pairs as well). This leads to the conjecture that the EM contributions to hadronic masses are always positive.

In order to extract genuine EM contributions to hadron masses we need to form $\Delta I = 2$ mass combinations such as

$$\begin{aligned}\delta_2[\Sigma] &= m_{\Sigma^+} + m_{\Sigma^-} - 2m_{\Sigma^0} \\ \delta_2[\rho] &= 2(m_{\rho^+} - m_{\rho^0}),\end{aligned}\tag{12.19}$$

in which the effects of $(m_u^{(0)} - m_d^{(0)}) \neq 0$ have been cancelled to first order. (Next order QCD effects are smaller than the observed splitting.) In terms of a naive quark model the Σ isotriplets are xuu , xud , and xdd states with $x = s, c, b, \dots$, some heavy quark. The EM contribution to $\delta_2(\Sigma)$ comes from mutual $q_i, q_j, i \neq j$ interactions and we find

$$\delta_2 \simeq \alpha |Q_u - Q_d|^2 \int \rho_n(\vec{r}) \rho_n(\vec{r}') / |\vec{r} - \vec{r}'| \geq 0,\tag{12.20}$$

with ρ_n referring to the density of the light u or d quark, which in the I -spin symmetric limit are equal. Our conjecture is then that this positivity is not an artifact of the simple model but would persist in the full-fledged theory. Experimentally [58], we find

$$\delta_2[\Sigma(1190)] = 1.5 \pm 0.18 \text{ MeV}\tag{12.21a}$$

$$\delta_2[\Sigma(1380)] = 2.6 \pm 2.1 \text{ MeV}\tag{12.21b}$$

$$\delta_2[\Sigma_c(2455)] = 2.0 \pm 1.6 \text{ MeV}\tag{12.21c}$$

$$\delta_2[\rho] = -0.2 \pm 1.8 \text{ MeV}.\tag{12.21d}$$

The positivity of $\delta_2[\Sigma(1190)]$ and $\delta_2[\Sigma(1380)]$ are statistically very significant (in view of the fairly small width). Estimating $m_{\rho^+} - m_{\rho^0}$ is difficult because of the large widths $\Gamma_\rho \simeq 150 \text{ MeV}$.¹⁸ We also note that the positivity of the $\Delta I = 2$ energy shift should apply not only to the ground state, but also to any excited states.

13. THE ABSENCE OF SPONTANEOUS PARITY VIOLATION IN QCD

A beautiful result also proved by Vafa and Witten [8] via the QCD inequalities technique is that there is no spontaneous breaking of parity symmetry in vectorial theories. Such a breaking should manifest via a nonzero vacuum expectation value of some parity odd operator A . The simplest candidates for such operators are the local quantities constructed from the gauge fields only

$$A = \tilde{F}F = \epsilon^{\mu\nu\lambda\sigma} F_{\mu\nu} F_{\lambda\sigma}, \epsilon^{\mu\nu\alpha\beta} D_\sigma F_{\mu\nu} D^\sigma F_{\alpha\beta}, \dots\tag{13.1}$$

Alternatively we could use quantities involving fermions such as $A = \bar{\psi}\gamma_5\psi$, with $\gamma_5 = \epsilon^{\mu\nu\lambda\sigma}\gamma_\mu\gamma_\nu\gamma_\lambda\gamma_\sigma$. The distinguishing feature of any parity odd operator is that it includes an odd number of $\epsilon^{\mu\nu\lambda\sigma}$ tensors. While the γ^μ matrices, fields A^μ , and metric $g_{\mu\nu}$ are hermitian and real in the euclidean continuation, $\epsilon^{\mu\nu\lambda\sigma}$, which transforms like $dx^1 dx^2 dx^3 dx^4$, picks up a factor of i and becomes purely imaginary. Consequently A_{euc} corresponding to all parity odd operators is imaginary.

If $\langle A \rangle \neq 0$, then from ordinary first order perturbation theory it follows that a (hypothetical) theory with a modified Lagrangian

¹⁸Also for the special case of the vectorial $\rho^+ \rho^0 \rho^-$ multiplet there is a relatively important one photon annihilation contribution, which the argument presented above misses.

$$\mathcal{L}_\lambda = \mathcal{L}_{\text{QCD}}(\lambda = 0) + \lambda \int d^3x A \quad (13.2)$$

has, for small λ , a shifted vacuum energy density

$$E(\lambda) = E(0) + \lambda \langle A \rangle, \quad (13.3)$$

with $\langle A \rangle = \langle A \rangle_0$ still computed for the $\lambda = 0$ vacuum. For a λ with an appropriate sign, $\lambda \langle A \rangle < 0$ and $E(\lambda) < E(0)$ – just as the energy of a spontaneously magnetized ferromagnet is lowered by adding an external \vec{B} field anti-parallel to the magnetization $\vec{\mu}$.

The euclidean path integral representation of the vacuum energy density for \mathcal{L}_λ is

$$E(\lambda) = -\frac{1}{V} \ln \int d[A_\mu] \int d[\psi] \int d[\bar{\psi}] e^{-\int d^4x \mathcal{L}_\lambda}. \quad (13.4)$$

We will next show that $E(\lambda) > E(0)$, negating the possibility that $E(\lambda) < E(0)$ and forbidding $\langle A \rangle \neq 0$.

If A is of the type indicated in Eq. (13.1), the $\int d[\psi] \int d[\bar{\psi}]$ integration can be carried out and

$$E(\lambda) = -\frac{1}{V} \ln \int d[A_\mu] e^{i\lambda A} \geq -\frac{1}{V} \ln \int d[A_\mu] = E(0), \quad (13.5)$$

since the oscillatory factor $e^{i\lambda A}$ always decreases the integral. The same is true if $\langle A \rangle = \langle \bar{\psi} \gamma_5 \psi \rangle \neq 0$. Adding λA to the Lagrangian is equivalent to introducing complex masses in the determinantal factor $\prod_i \text{Det}(\mathcal{D} + m_i)$ (e.g. $m_i \rightarrow m_i + i\lambda$) which again destroys the positivity of the determinantal factor, reduces $Z(\lambda)$, and increases $E(\lambda)$, so that Eq. (13.5) holds.

The fact that $Z(\lambda)$ is minimal for $\lambda = 0$ allows also the proof that of all the different QCD θ vacua (which can be generated by adding the topological density $\theta \tilde{F}F$ term to the Lagrangian), the one with the lowest vacuum energy is that with $\theta = 0$. (Also $\theta = \pi$ was excluded by similar arguments [146], a result suggested by dilute instanton calculations [107] and other considerations [63]).

14. QCD INEQUALITIES AND THE LARGE N_C LIMIT

We have commented on several occasions on the inequalities in the $N_c \rightarrow \infty$ limit. We will next show [20] that in this limit we have indeed the stronger version of the baryon-meson inequality

$$m_B \geq \frac{N_c}{2} m_\pi. \quad (14.1)$$

We will also indicate that the interflavor mesonic mass inequalities could be extended to non-pseudoscalars.

The Schwartz inequality implies that the baryonic correlation function $\langle B(x)B(y) \rangle = \int d\mu(A) [\Gamma S_A(x, y)^n \Gamma]$ with $S_A(x, y)$ the common fermion propagator, is smaller than $\left[\int d\mu(A) \text{tr}^n S_A^\dagger(x, y) S_A(x, y) \right]^{1/2}$. This last expression represents the correlation function of products of n pseudoscalar currents, $\langle 0 | [J^{ps}(x)]^n [J^{ps}(y)]^n | 0 \rangle$. We can show that in the large N_c limit this joint correlation function effectively factors into a product of $[\langle J^{ps}(x) J^{ps}(y) \rangle]^n$. Specifically, gluon exchanges between different $q\bar{q}$ bubbles in Fig. 12 do not modify the energy $N_c m_\pi$ by more than $\mathcal{O}(1)$, of the system viewed as separately propagating N_c $q\bar{q}$ pairs. Indeed, the color trace counting argument [67,147] indicates that the interaction energy between any $(q\bar{q})(q\bar{q})$ pair of bubbles is $\mathcal{O}(1/N_c)$. Since we have $N_c/2$ pairs, which can interact via planar diagrams of gluon exchanges, the total effect is $\mathcal{O}(1)$. The interaction of triplets (or a higher number) of bubbles is $\mathcal{O}(1/N_c^2)$, or $\mathcal{O}(1/N_c^k)$, $k > 2$, and is less important. Thus in the large $|x - y|$ limit $\int d\mu(A) \text{tr}^n S_A^\dagger(x, y) S_A(x, y) \simeq e^{-N m_\pi}$, and since $\langle B(x)B(y) \rangle \simeq e^{-m_B |x-y|}$, Eq. (14.1) follows.

To extend the interflavor mass relations consider the following three correlation functions of four flavor currents (see Fig. 12):

$$\begin{aligned} F_1 &= \langle 0 | J_{\pi^+}(x_1) J_{K^+}(x_2) J_{\pi^-}(y_1) J_{K^-}(y_2) | 0 \rangle \\ F_2 &= \langle 0 | J_{K^-}(x_1) J_{K^+}(x_2) J_{K^-}(y_1) J_{K^+}(y_2) | 0 \rangle \\ F_3 &= \langle 0 | J_{\pi^-}(x_1) J_{\pi^+}(x_2) J_{\pi^-}(y_1) J_{\pi^+}(y_2) | 0 \rangle, \end{aligned}$$

with the euclidean points x_1, x_2, y_1, y_2 forming a rectangle of height T and width τ in the, for example, 3 – 4 plane. In the large N_c limit, quark annihilation is suppressed and we have the planar quark diagrams indicating the possible

contractions. In the case of F_2 we specifically choose the contraction with $s\bar{s}$ exchanged in the vertical (T) direction, so that in all three cases we have $u\bar{u}$ exchanged in the horizontal (τ) direction. We can use the euclidean Hamiltonian to evolve the system in T , *e.g.*

$$\begin{aligned} F_1 &= \sum_n \langle 0 | J_{\pi^+}(x_1) J_{K^+}(x_2) | n \rangle \langle n | J_{\pi^-}(x_1) J_{K^-}(x_2) | 0 \rangle e^{-E_n T} \\ &= \sum_n |\langle 0 | J_{\pi^-}(x_1) J_{K^+}(x_2) | n \rangle|^2 e^{-E_n T}, \end{aligned} \quad (14.2)$$

with $\langle 0 | J_{\pi^-}(x_1) J_{K^+}(x_2) | n \rangle$ independent, by translational invariance, of the specific location in T of x_1, x_2 .

We can also evolve the system in τ to find analogous expressions:

$$F_1 = \sum_{n'} \langle 0 | J_{K^+}(x_2) J_{K^-}(y_2) | n' \rangle \langle n' | J_{\pi^+}(x_2) J_{\pi^-}(y_2) | 0 \rangle e^{-E_{n'} \tau} \quad (14.3a)$$

$$F_2 = \sum_{n'} |\langle 0 | J_{K^+}(x_2) J_{K^-}(y_2) | n' \rangle|^2 e^{-E_{n'} \tau} \quad (14.3b)$$

$$F_3 = \sum_{n'} |\langle 0 | J_{\pi^+}(x_2) J_{\pi^-}(y_2) | n' \rangle|^2 e^{-E_{n'} \tau} \quad (14.3c)$$

where, due to the choice of F_2 , we have the same states $|n'\rangle$ (with $\bar{u}u$ flavor) in all three cases. From the Schwartz inequality we have

$$|F_1|^2 \leq F_2 F_3 \quad (14.4)$$

which, by going back to the representation like Eq. (14.2) for F_1, F_2 , and F_3 , yields inequalities between the masses of the lowest intermediate states for the three cases

$$m_{u\bar{s}}^{(0)} \geq \frac{1}{2} \left[m_{u\bar{u}}^{(0)} + m_{s\bar{s}}^{(0)} \right], \quad (14.5)$$

since by construction the intermediate “ T -channel” states for F_2 are $s\bar{s}$ type states (and $u\bar{u}$ for F_3). As emphasized earlier in the large N_c limit the $m_{u\bar{u}}, m_{s\bar{s}}$ sectors are distinct from $m^{(0)}$, the flavor vacuum, and from each other. To get perfect squares in Eqs. (14.3b) and (14.3c), we need to have identical currents at x_1, x_2 and y_1, y_2 . Thus the quantum numbers of these $u\bar{u}, s\bar{s}$ (and $u\bar{s}$) states are those of $J_\pi J_\pi$, $C = +$, even G-parity, *e.g.* 0^{++} states.

Indeed, similar unitarity motivated inequalities were suggested earlier in the context of dual models and were applied to intercepts of Regge trajectories on which 0^{++} states lie [148], and it has been conjectured that in the large N_c limit QCD approaches a dual, string-like model. The present derivation pinpoints, however, the crucial element for deriving Eq. (14.5). It is that in the large N_c limit we can meaningfully separate the various planar contributions to the correlation function and each evolves separately under the appropriate $H_{i\bar{i}}$ (or $H_{i\bar{j}}$) Hamiltonian.

We note that the last argument did not utilize the measure positivity in the euclidean path integral, but rather the unitarity based, more general, spectral positivity. QCD inequalities have also been applied in the large N_c limit in (1+1) dimensions [149].

15. QCD INEQUALITIES FOR GLUEBALLS

QCD also predicts “glueball” states consisting of gluonic degrees of freedom and no quark flavors. Experimental evidence for such states exists at present [150] – but mixing with the many $q\bar{q}$ and/or $q\bar{q}q\bar{q}$ states in the 1 – 1.5 GeV region (where the glueball spectrum is estimated to start [151]) complicates the analysis.

The local density $F^2 = F_{\mu\nu}^a F_{\mu\nu}^a$ becomes, in the euclidean domain, $\vec{E}^2 + \vec{B}^2$ and maximizes all other F bilinears such as $\tilde{F}F \rightarrow i\vec{E} \cdot \vec{B}$. Thus, as pointed out by Muzinich and Nair [21,152], we have $F^2(x)F^2(y) \geq \tilde{F}F(x)\tilde{F}F(y)$. Due to measure positivity this translates into an inequality between the corresponding correlation functions

$$\begin{aligned} \langle 0 | F^2(x) F^2(y) | 0 \rangle &= \int d\mu(A) F^2(x) F^2(y) \\ &\geq \int d\mu(A) \tilde{F}F(x) \tilde{F}F(y) = \langle 0 | \tilde{F}F(x) \tilde{F}F(y) | 0 \rangle. \end{aligned} \quad (15.1)$$

$F^2(x), \tilde{F}F(x)$ create from the vacuum 0^{++} and 0^{-+} states respectively. Thus, following the standard argument, we derive the inequality

$$m_{\text{gb}}^{(0^{++})} \leq m_{\text{gb}}^{(0^{-+})} \quad (15.2)$$

between the masses of the lowest glueball states in the respective channels. Confinement and the existence of a mass gap in the gluonic sector prevents interpretation of Eq. (15.2) as a statement about gluon thresholds.

Any polynomial in the component of $F_{\mu\nu}$, used to create a glueball state of arbitrary J^{PC} , is bound by an appropriate power of F^2 . Thus Eq. (15.2) can be generalized to

$$m_{\text{gb}}^{(0^{++})} \leq (\text{mass of any glueball}). \quad (15.3)$$

All these correlation function inequalities are automatically satisfied if F^2 has a nonvanishing vacuum expectation value: $\langle 0|F^2|0\rangle \neq 0$. In this case, correlation functions involving F^2 [or $(F^2)^n$] have constant terms as $|x-y| \rightarrow \infty$, corresponding to the obvious zero mass 0^{++} “state”: the vacuum, and Eq. (15.3) need not hold.

In Ref. [153], West suggested that the inequalities (15.2) and (15.3) can be recovered if we use the time derivative of the correlator:

$$\begin{aligned} \frac{d}{dt} \langle 0|F^2(0)F^2(t, \vec{0})|0\rangle &= \langle 0|F^2(0)[H, F^2(t, \vec{0})]|0\rangle \\ &= \langle 0|F^2(0)H F^2(t, \vec{0})|0\rangle, \end{aligned} \quad (15.4)$$

and the corresponding expression for $\tilde{F}F$. The offending constant term in the intermediate summation would be absent in the new inequalities. The idea then is to prove that

$$\langle 0|FF(0)HFF(t, \vec{0})|0\rangle > \langle 0|\tilde{F}F(0)H\tilde{F}F(t, \vec{0})|0\rangle. \quad (15.5)$$

This could be accomplished by using the positivity of the Hamiltonian for each $A_\mu(x)$ background configuration separately in a path integral representation of the last two correlators. There are however subtleties in this argument which West tried to address.

In general, while the Hamiltonian is positive when operating on physical states, the latter states are obtained only after the path integral has been carried out, and the pointwise positivity of H for every $A_\mu(x)$ configuration is not *a priori* guaranteed. It is the case for the pure Yang-Mills theory if $H = \int dx(\vec{E}^2 + \vec{B}^2)$ ¹⁹ however, in this case $H|0\rangle = 0$, which has been assumed in the above argument, holds only after an appropriate subtraction has been made. Such a common subtraction will then modify Eq. (15.5) to

$$\begin{aligned} &\langle 0|FF(0)HFF(t, \vec{0})|0\rangle - c\langle 0|FF(0)FF(t, \vec{0})|0\rangle > \\ &\langle 0|\tilde{F}F(0)H\tilde{F}F(t, \vec{0})|0\rangle - c\langle 0|\tilde{F}F(0)\tilde{F}F(t, \vec{0})|0\rangle, \end{aligned} \quad (15.6)$$

with c positive. Due to Eq. (15.1) this may invalidate the desired inequality.

In passing we remark that $\langle 0|F^2|0\rangle \neq 0$ has been conjectured to be the driving mechanism for confinement. Its value controls the bag constant [154], the string tension in extended hadronic states [155], and enters QCD sum rules.

The glueball sector can be divided into “even” and “odd” parts consisting of states with quantum numbers of two or three gluons with appropriate orbital and spin angular momentum. Thus the J^{PC} states $0^{++}, 2^{++}, 0^{-+}, 2^{-+}$ belong to the even part and 1^{--} to the odd. If we adopt a simple “constituent” description of the lowest even (odd) states in terms of two (three) gluons bound by one gluon exchange potentials, then the arguments of Sec. 3 leading to the baryon-meson mass inequality $m_B \geq (3/2)m_M$ can be repeated here to prove the inequality

$$m_{3g}^{(0)} \geq \frac{3}{2}m_{2g}^{(0)} \quad (15.7)$$

between the masses of the lowest odd and even states. Just as in the meson (baryon) $3 \otimes \bar{3} \rightarrow 1(3 \otimes \bar{3} \rightarrow \bar{3})$, we have in the 2g (3g) state $8 \otimes \bar{8} \rightarrow 1(8 \otimes \bar{8} \rightarrow \bar{8})$ and we can repeat the argument by replacing $\lambda_1 \cdot \lambda_2$ in the fundamental representation by $\Lambda_1 \cdot \Lambda_2$ in the adjoint representation of $SU(3)_C$.

¹⁹Actually it is the euclidean Lagrangian which has this positive definite $\vec{E}^2 + \vec{B}^2$ form, and the euclidean Hamiltonian then has the form $\int (\vec{B}^2 - \vec{E}^2)$. A non-vanishing $\langle 0|H|0\rangle$ VEV then amounts to the nontrivial dynamical assumption of the dual Meissner effect in the QCD vacuum – namely the preponderance of large *magnetic* fluctuations.

Evidently, as the previous discussion suggests, a constituent valence model for glueballs is on much weaker footing than that for mesons and baryons. In particular, the latter (but not the former!) can be justified in the large N_c limit. If the even glueball spectrum starts at $1.5 - 2$ GeV, then Eq. (15.7) suggests that the lightest 1^{--} glueball may be near the J/ψ , ψ' states. Its putative mixing with the latter could then modify the perturbative approach to $J/\psi \rightarrow 3g$ decays and/or other matrix elements [156].

16. QCD INEQUALITIES IN THE EXOTIC SECTOR

So far we have focused on correlation functions of $q_a \bar{q}_a$ bilinear and $\epsilon^{abc} q_a q_b q_c$ trilinear currents. In the following we utilize $\langle J^{\text{ex}}(x) J^{\text{ex}}(y) \rangle$ with quartic “currents”:

$$J^{\text{ex}} \sim q_i(x) \bar{q}_j(x) q_k(x) \bar{q}_l(x), \quad (16.1)$$

to probe the “exotic” $M_{i\bar{j}k\bar{l}}$ sector. We also address the possibility that the lowest lying intermediate state in $\langle J(x) J(y) \rangle$ is not a stable one particle state, but rather a two particle threshold at $m_1 + m_2$.

This last issue has been encountered already for non-exotic currents. Thus, the lowest lying state in the vector $1^- u\bar{d}$ channel is *not* the $\rho(760)$ but the $\pi\pi$ threshold at ≈ 280 MeV. Since this happens because $m_\rho > 2m_\pi$, the Weingarten inequality $m_\rho \geq m_\pi$ is not invalidated.

Let us next analyze the general case $\langle 0 | J_a(x) J_a^\dagger(y) | 0 \rangle \geq \langle 0 | J_b(x) J_b^\dagger(y) | 0 \rangle$, when the lowest, non-exotic mesons in *both* channels are resonances of widths $\Gamma_a(\Gamma_b)$. If the states are narrow, *i.e.* $\Gamma_a < m_a^{(0)}, \Gamma_b < m_b^{(0)}$, then a mass inequality $m_a^{(0)} \leq m_b^{(0)}$ can be derived. The point is that the correlation function inequalities are derived for *all* $|x - y|$. By varying $|x - y|$ we effectively scan the spectrum since we keep changing the relative weight of different (μ^2) regions in Eqs. (8.2) and (8.3). In the $|x - y| \rightarrow 0$ limit the high μ^2 region dominates. The perturbative expressions for the correlation functions are adequate and indeed conform to the inequalities. In the other extreme, $|x - y| \rightarrow \infty$, the threshold region dominates and we have, *e.g.*, $\langle VV \rangle \sim \exp\{-2m_\pi|x - y|\}$.

However, following lattice calculations of hadronic masses, let us consider “intermediate times” during which the local $u(x)\gamma_\mu\bar{d}(x)$ state, for example, evolves into a true $\rho, q\bar{q}$ bound state, but has *not yet* evolved into the final decayed form of two pions (see Fig. 13). In the range $\Gamma_\rho^{-1} \gg |x - y| \gg m_\rho^{-1}$, from which meaningful mass values (and mass inequalities) could be extracted for the ρ resonance, $\langle 0 | J_\mu(x) J_\mu^\dagger(0) | 0 \rangle \sim \exp\{-m_\rho|x - y|\}$ is a valid approximation.

In this section we focus on the threshold regions and the $|x - y| \rightarrow \infty$ domain in the correlator inequalities. Since near threshold the kinetic energies are much smaller than the masses of the stable particles, nonrelativistic kinematics, and some aspects of a potential model (in the $\pi\pi, \pi K$, and KK channels) may be applicable.

The inequalities $m_{i\bar{j}}^{(0)} \geq \frac{1}{2} (m_{i\bar{i}}^{(0)} + m_{j\bar{j}}^{(0)})$ often become in the continuum limit trivial equalities $m_i + m_j = \frac{1}{2}(2m_i + 2m_j)$ [or $m_K + m_\pi = \frac{1}{2}(2m_K + 2m_\pi)$ when we have confined $i = u, j = \bar{s}$ quarks and a meson-meson continuum]. This is analogous to the trivialization of $m_\delta \leq 2m_\pi$ into $m_{2\pi} \leq 2m_\pi$ mentioned above.

If we consider systems confined to a volume of diameter R , we expect the various inequalities to be satisfied with a margin of order $\Delta E \simeq 1/2mR^2$, the level splitting for a system of size R . For the continuum, $R \rightarrow \infty$, and ΔE vanishes. However, the relevant quantities become the phase shifts. We wish to interpret the inequalities as nontrivial statements about the latter [20,157].

To this end, let us consider the “ $\text{tr}_{v_n} h_{12}$ ” inequalities (2.14):

$$\sum_{n=0}^N E_{ij}^{(n)} \geq \frac{1}{2} \sum_{n=0}^N (E_{ii}^{(n)} + E_{jj}^{(n)}), \quad (16.2)$$

with the sum extending over the first N excited states. If we put our system in a large box, then each time a “bound state” is generated (by increasing the strength of the attractive potential), the phase shift δ in the relevant channel changes by π . Levinson’s theorem [158] suggests replacing the discrete sum $\sum_{n=0}^N$ by $\frac{1}{\pi} \int^\Delta d\delta$, and Eq. (16.2) then becomes

$$\frac{1}{\pi} \int^\Delta d\delta E_{ij}(\delta) \geq \frac{1}{2} \frac{1}{\pi} \int^\Delta d\delta [E_{ii}(\delta) + E_{jj}(\delta)]. \quad (16.3)$$

Evidently (16.3) reverts back to (16.2) in the narrow resonance approximation with $\frac{d\delta}{dE}$ localized near the resonances $E^{(n)}$.

Near threshold $\delta = ka$, with k the center of mass momentum and a the scattering length. Using NR kinematics for $k_{ij}(E)$ we can obtain the relation [20]

$$\frac{1}{a_{ij}^2} \left(\frac{1}{m_i^2} + \frac{1}{m_j^2} \right) \geq \left(\frac{1}{a_{ii}^2} \frac{1}{m_i^2} + \frac{1}{a_{jj}^2} \frac{1}{m_j^2} \right). \quad (16.4)$$

Quarks are confined and for $i = s, j = \bar{u}$ in $0^{++}, 1^{--}, 2^{++}$, *etc.* channels, the lowest states are $\pi^+\pi^-, K\pi^-,$ and $K\bar{K}$, and one might use this inequality with $i, j \rightarrow K, \pi$. Scattering data for $\pi\pi$ and πK can be analyzed by considering $\pi N \rightarrow 2\pi N$ and $KN \rightarrow K\pi N$ scattering and extrapolating to the one pion exchange pole [159,160]. This extrapolation is much more difficult for the K exchange case, making a direct test of (16.4) difficult. However, the existence of the 0^{++} state in the $K\bar{K}$ system slightly below threshold is expected to enhance $a_{K\bar{K}}$ so that (16.4) would most likely hold.²⁰

Consider next the exotic current with 0^{++} quantum numbers:

$$J_\delta = J_{ij}^{ps}(x) J_{k\bar{l}}^{ps}(x) = \bar{\psi}_i(x) \gamma_5 \psi_j(x) \bar{\psi}_k(x) \gamma_5 \psi_l(x). \quad (16.5)$$

If all flavors are distinct, we have only one possible contraction, illustrated in Fig. 11(a), contributing to $J_\delta J_\delta$ which, using Eq. (8.20), can be written as

$$\langle 0 | J_\delta(x) J_\delta^\dagger(y) | 0 \rangle = \int d\mu(A) \text{tr} \left\{ [S_A^i(x, y)]^\dagger S_A^j(x, y) \right\} \text{tr} \left\{ [S_A^k(x, y)]^\dagger S_A^l(x, y) \right\}. \quad (16.6)$$

If $m_i^{(0)} = m_j^{(0)}, m_k^{(0)} = m_l^{(0)}$, then the integrand in Eq. (16.6) becomes the product of two perfect squares and $\langle J_\delta J_\delta \rangle$ maximizes all other exotic correlation functions. Espriu *et al.* [22] speculate that this is associated with the fact that the lowest exotic $q\bar{q}q\bar{q}$ states found in bag model calculations [161] are 0^{++} states.

Even more dramatic results follow [22] if we take all four, distinct, flavors, $i, j, k,$ and l to be degenerate. In this case we have $\langle J_\delta J_\delta \rangle = \int d\mu(A) \left\{ \text{tr} [S_A(x, y)^\dagger S_A(x, y)] \right\}^2$, which by the Schwartz inequality is larger than the square of the pseudoscalar propagator:

$$\langle J_\delta(x) J_\delta(y) \rangle \geq |\langle J^{ps} J^{ps} \rangle|^2. \quad (16.7)$$

While the last inequality is consistent with having a bound δ state in the $\pi^+\pi^{+'}$ ($\pi = \bar{u}\gamma_5 d, \pi' = \bar{u}'\gamma_5 d'$) channel, it does *not require* such a state. The “ δ ” state could simply be a $\pi\pi'$ threshold state and the inequality would be trivially satisfied as

$$m(\pi\pi) \text{ threshold} \leq m_\pi + m_{\pi'}. \quad (16.8)$$

We would like to interpret this, in analogy with our above discussion, as a statement that the low energy (threshold) interacts attractively. This in turn enhances the density of threshold states relative to the non-interacting, free case, and enhances the long distance euclidean correlators.

²⁰The inequality

$$\langle J_{K+K'-}(x) J_{K+K'-}(y) \rangle \langle J_{\pi+\pi'-}(x) J_{\pi+\pi'-}(y) \rangle \geq \left| \langle J_{K+\pi'+}(x) J_{K-\pi'-}(y) \rangle \right|^2,$$

with $J_{K+K'-} = J_{K+} J_{K'-}$, $J_{K+} = \bar{\psi}_s(x) \gamma_5 \psi_u(x)$, *etc.* is readily derived, if we introduce additional degenerate flavors $u', s', m_{u'} = m_u, m_{s'} = m_s$. As $|x - y| \rightarrow \infty$ the various correlation functions are dominated by the respective meson-meson thresholds. If we neglect the interaction between the propagating mesons, the above inequality becomes a trivial equality since each of the two-point functions factorizes, *e.g.* $\langle 0 | J_{\pi+}(x) J_{K'-}(x) J_{\pi+}(y) J_{K'-}(y) | 0 \rangle = f_\pi f_K D_\pi(x, y) D_K(x, y)$ with $f_\pi = \langle 0 | J_\pi | \pi \rangle$ and D_π the pion propagator. In this long distance, low energy limit, we can effectively treat the pions as elementary with interactions $\lambda_{\pi\pi}\pi^4, \lambda_{KK}K^4$, and $\lambda_{\pi K}\pi^2 K^2$. To first order in the λ s these interactions modify the two-point correlation function as follows: $\langle J_1(x) J_2(x) J_1^\dagger(y) J_2^\dagger(y) \rangle = F_1^2 F_2^2 D_{m_1}(x, y) D_{m_2}(x, y) - \lambda_{12} \int d^4x D_{m_1}(x, z) D_{m_2}(x, z) D_{m_1}(z, y) D_{m_2}(z, y)$. The second term represents the effect of one $m_1 m_2$ collision. By going to momentum space the z integration can be done and an inequality between the λ s is obtained [20]. Unfortunately, it contains, besides the masses, also a subtraction point μ_0 and will not be reproduced here. Note that the minus sign in front of the first order euclidean perturbative contribution reflects the expansion of e^{-Ht} . Thus a negative λ_{12} – corresponding to an attractive $\pi\pi$ interaction – enhances the joint propagation.

The connection between an attractive potential in the $i\bar{j}$ channel and the propagator $\langle 0|J_{ij}^\dagger(x)J_{ij}(y)|0\rangle$ can be directly seen in a potential model limit. With one of the particles infinitely heavy, the ij propagator is essentially that of the other particle moving in the attractive potential. The path integral expression for such a propagation is

$$\sum_{\text{paths}} e^{-\int L d\tau} = \sum_{\text{paths}} \exp \left\{ -\int \left[\frac{1}{2} \left(\frac{dx^\nu}{d\tau} \right)^2 - V(x^\nu) \right] d\tau \right\}, \quad (16.9)$$

with τ a ‘‘proper time’’ and $x^\nu(0) = x, x^\nu(\tau) = y$. Evidently an attractive potential ($V < 0$) will enhance the positive contributions of the individual paths. This is indeed expected from the interpretation of the free euclidean propagator as a diffusion kernel: the probability of the diffusing particle to return to the origin is clearly enhanced by an attractive potential. A more rigorous and systematic approach directly relating euclidean lattice correlators to phase shifts and scattering lengths was suggested by Lüscher [162]. It was utilized by Gupta *et al.* [157] to prove that the $\pi - \pi$ scattering length is positive.

The idea in Lüscher’s approach (see also Neuberger’s [163] suggestion of a calculational lattice method for determining f_π) is to use the finite size corrections to the correlators. The latter are the configuration space analog of the $1/R$ energy shifts discussed here. We refer the reader to the original Lüscher work [162] for further details.

We have argued that $m(\pi\pi') \leq (m_\pi + m_{\pi'})$ can be fulfilled by an interacting $\pi^+\pi^+$ threshold state if the scattering length is attractive (positive). The π and π' can only interact via gluon exchanges since they are composed of different quarks. The interesting fact that this interaction is attractive is in accord with an old result [164] that the retarded Van der Waals forces between systems of identical polarizabilities are always attractive.

Indeed the Casimir-Polder two-photon exchange interaction:

$$V_{CP}(\vec{r}) = \frac{1}{4\pi r^7} \left[-23 \left(\alpha_E^{(1)} \alpha_E^{(2)} + \alpha_M^{(1)} \alpha_M^{(2)} \right) + 7 \left(\alpha_E^{(1)} \alpha_M^{(2)} + \alpha_E^{(2)} \alpha_M^{(1)} \right) \right]$$

remains attractive so long as the ratios of electric and magnetic polarizabilities α_E/α_M for the two neutral systems (1) and (2) in question are similar. Our above result generalizes this attractive nature of the photon exchange to the full non-perturbative case, and applies also for nonabelian gauge interactions. (If, like in QCD, the theory is confining, then there is a mass gap in the pure glue sector, and we expect an exponential rather than power law falloff of the interaction. The attractive nature does however persist.)

We note that two independent lines of argument can suggest that the two-photon exchange interaction is attractive. The first nonrelativistic, second order perturbation theory argument applies if the systems (1) and (2) considered are in their respective ground states. The second, more general, relativistic field argument uses t -channel dispersion [79] and the positivity of the corresponding spectral functions when (1) = (2). Amusingly the conditions required for proving the inequality (16.7) simultaneously conform to both arguments, since the $i\bar{j}, k\bar{l}$ pseudoscalars are indeed the lowest states in their channels, and taking $m_i = m_k, m_j = m_l$ makes them (dynamically) identical. Finally we would like to mention that the second argument suggests [165] that contrary to some lore, two halves of a conducting spherical shell attract rather than repel.

In the real world the $\pi^+\pi^+$ scattering length is repulsive [166]. Indeed, with $u = u', d = d'$ we have the alternate contraction of Fig. 11(b). It has one fermion loop and makes hence a contribution of the opposite sign:

$$\langle J_\delta J_\delta \rangle = \int d\mu(A) \left\{ \left[\text{tr}(S_A^\dagger S_A) \right]^2 - \text{tr} \left[(S_A^\dagger S_A)^\dagger (S_A^\dagger S_A) \right] \right\}, \quad (16.10)$$

so that Eq. (16.7) can no longer be proven. Indeed at short distance, when the mesons’ wave functions overlap, we expect a repulsive Pauli effect which is reflected in the minus sign in Eq. (16.10). We have not been able to show that this extra negative term reverses the sign in Eq. (16.7), so that no $\pi^+\pi^+$ exotic bound state exists and $a_{\pi^+\pi^+} = a_{\pi\pi}(I=2)$ is repulsive.

17. QCD INEQUALITIES FOR FINITE TEMPERATURE AND FINITE CHEMICAL POTENTIAL

Recently there has been much interest in QCD at finite temperature and finite baryon density, *i.e.* finite chemical potential. This interest is partially motivated by the desire to better understand compact neutron / (strange) quark matter stars, and by the prospect that heavy ion collisions at the Relativistic Heavy Ion Collider (RHIC) can indicate the expected finite temperature phase transition.

In the following we would like to comment on the possible relevance of QCD inequalities in these cases. First, we note that all the correlator inequalities are maintained for $T > 0$. In the euclidean formulation, introduction of finite

temperature is simply equivalent to the imposing periodicity $\beta = 1/T$ in the time direction [167]. The restriction of the gauge field configurations in the euclidean path integral to such periodic configurations clearly does not spoil the positivity of the measure. Also the relation $\gamma_5 S_F^A(x, 0) \gamma_5 = S_F^{\dagger A}(x, 0)$ and the ensuing positivity of the fermionic determinant and the integrand in the pseudoscalar correlators are maintained at finite temperature – and therefore so are all the correlator inequalities.

Precisely because of the periodicity in time, we cannot use the Hamiltonian and its $t \rightarrow \infty$ limiting e^{-mt} behavior in order to infer bounds on masses smaller than $T = 1/\beta$. Therefore we cannot attempt, when $T \neq 0$, to prove that the axial global symmetry spontaneously breaks down, as this feature is closely tied to the massless pseudoscalar Nambu-Goldstone bosons. Indeed, numerous theoretical arguments [168,169] and lattice simulations have virtually proven that in QCD there is in fact a phase transition corresponding to axial symmetry restoration (and quark deconfinement) at a temperature $T_c \simeq \Lambda_{\text{QCD}}$. The exact character of this phase transition and its dependence on N_f , the number of quark flavors, was for a long time unclear.²¹ However, we believe that the Vafa-Witten results regarding the non-breaking of vectorial global symmetry [which rely on $S_F^A(x) \leq S_F^0(x)$] and even more so the one concerning the nonbreaking of parity (which depends only on bulk, *i.e.* free energy, properties) continue to hold for finite T QCD.²²

The QCD inequalities technique may be even less useful in discussing transient varying T phenomena, such as disoriented chiral condensates [172], suggested to occur in domains of cooling quark gluon plasma.

The introduction of a finite chemical potential, *i.e.* consideration of QCD in a background of uniform baryon density, has a much more drastic effect. It amounts to changing the fermionic part of the euclidean Lagrangian to

$$\mathcal{L}(\mu) = \sum_{i=1}^{N_f} [\bar{\psi}_i \gamma_\mu D_\mu \psi_i + \mu \bar{\psi}_i \gamma_0 \psi_i + m_i \bar{\psi}_i \psi_i] , \quad (17.1)$$

so that the new $\mu \neq 0$ propagator no longer satisfies $\gamma_5 S_F \gamma_5 = S_F^\dagger$, but rather

$$\gamma_5 S_F \gamma_5 = \gamma_5 \frac{1}{\not{D} + \mu \gamma_0 + m} \gamma_5 = \frac{1}{-\not{D} - \mu \gamma_0 + m} \neq S_F^\dagger , \quad (17.2)$$

and hence the positivity of the fermionic determinant can no longer be inferred. This not only prevents the proof of the QCD inequalities, but also excludes the utilization of lattice numerical simulations in which the statistics of occurrence of lattice gauge configurations prescribes their (positive!) weights. The various dramatic speculations concerning the high μ phase (involving parity breaking and even “color superconductivity” [173]) are therefore not excluded.

The special case of $N_c = 2$, *i.e.* SU(2) gauge theory, is a notable exception, and one can show measure positivity in this case even for $\mu \neq 0$. This result, which has been utilized for some time in lattice simulations [174] is readily proven by using

$$\gamma_5 C I_2 S_F \gamma_5 C I_2 = D^* . \quad (17.3)$$

In Eq. (17.3) C is $i\gamma_0\gamma_2$ and I_2 is the generator of the SU(2) color isospin, and it holds for arbitrary μ . This feature, which is due to the pseudoreality of SU(2), is essentially the same one used by Anishetty and Wyler [80] and Hsu [81] to extend the inequalities to chiral SU(2). It has been used by Kogut, Stephanov, and Toublan [174] in order to prove that the correlator of the 0^+ , $I = 0$ (*i.e.* antisymmetric in flavor) $\psi\psi$ combination

$$M_{\psi\psi} = \psi^\dagger C I_2 \gamma_5 \psi$$

can serve, for $\mu \neq 0$, as an upper bound for any other correlator. This implies that for $\mu \neq 0$ the 0^+ $\psi\psi$ diquark is the lightest boson. This complements the claim that for $\mu = 0$ and $N_c = 2$, the 0^+ $\psi\psi$ diquark is degenerate with the 0^- $\bar{\psi}\gamma_5\psi$ pion (see the end of Sec. 6), and nicely fits with the unique patterns of symmetry breaking suspected in this case [174].

²¹It is generally believed to be weakly first order [170], and could be N_f dependent. We will later make a conjecture that T_c monotonically decreases with N_f .

²²T. Cohen [171] utilized the QCD inequalities to suggest that not only is SU(3) axial symmetry restored above T_c , but also U(1)_A. Since the latter is broken via the QCD anomaly and not spontaneously, this result is rather surprising. Indeed as noted by Cohen the proof involves a technical assumption which may fail.

External electric and magnetic fields modify the hadronic spectrum. Indeed lattice calculations utilized external magnetic fields to probe, via the $\vec{\mu}\cdot\vec{B}$ interactions, the hadronic magnetic moments. Also very strong fields (the analogs of supercritical fields in superconductors) can even modify the phase structure of spontaneously broken gauge theories. In the context of QCD and other vectorial theories the measure positivity is clearly maintained in the presence of the external \vec{B} field. However, QCD inequalities such as BE (parapositronium) \geq BE (orthopositronium) or $m_\rho \geq m_\pi$ may be modified since the vector (triplet) state has a magnetic moment, and for a sufficiently strong external \vec{B} field ($|\vec{B}| \gtrsim \Lambda_{\text{QCD}}^2$), the state with $\vec{\mu}$ antiparallel to \vec{B} may become lower than the singlet pion. In this connection we recall the amusing suggestion [175] that in strong enough magnetic fields, existing in appropriate astrophysical environments, that this effect can reverse $m_n > m_p$ to $m_p > m_n$ with an inverted β decay!

Unlike the effect of high temperature and/or chemical potentials, we believe that strong magnetic fields do not cause deconfinement or chiral symmetry restoration. Indeed in the limit $B \gg \Lambda^2$ we expect, in analogy with the case of atomic physics [176], that in strong magnetic field stars the motion of the quarks becomes one dimensional, along the \vec{B} field lines. It is well known that in such cases confinement only gets stronger (even U(1) theories confine!), and so should S χ SB. It is an interesting, open conjecture which we would like to make here, that even moderate \vec{B} fields tend to enhance S χ SB, *e.g.* by enhancing the density near $\lambda = 0$ eigenvalues of the Dirac operator and thus, according to the Banks-Casher criterion, enhance the $\langle\bar{\psi}\psi\rangle$ condensate.

18. QCD INEQUALITIES FOR $\bar{Q}Q$ POTENTIALS, QUARK MASSES, AND WEAK TRANSITIONS

The main application of the techniques developed above is to obtain inequalities between directly measurable quantities such as hadron masses. However, there are several calculational approaches to QCD such as the potential model for heavy quarkonia [177–180], chiral perturbation theory for the low-lying mesonic sector [181], and QCD sum rules [93,94]. Each of these schemes depends on a few input parameters and makes many predictions. Applying the techniques of QCD inequalities to these input parameters could therefore yield a very large body of suggestive results.

The area in which most research along these lines has been done (in a large measure prior to, and independent from, the introduction of QCD inequalities in 1983) is that of potential models. The point is that given some general properties of the potential such as convexity of $V(r)$ or other features, we have a wealth of information concerning the level ordering, thanks to the work of Martin and collaborators [24,182,183]; Lieb [18]; Fulton and Feldman [184]; and others.

An early important observation was that the P-wave excitation in $c\bar{c}$ (or $b\bar{b}$) systems is lower than the first radial excitation: $E_{n_r+1,l} \geq E_{n_r,l+1}$. This deviation from the famous degeneracy in the pure Coulombic case is related to the fact that the QCD potential $V_{\text{QCD}}(r)$ does not satisfy $\nabla^2 V_{\text{QCD}} = 0$ but rather $\nabla^2 V_{\text{QCD}} \geq 0$ [184]. Also the assumption of a monotonically increasing, $\frac{dV}{dr} > 0$, convex potential, $\frac{d^2V}{dr^2} < 0$ allowed Baumgartner, Grosse and Martin [183] (BGM) to prove $E_{n,l} \leq E_{n-1,l+2}$.

In addition if $\frac{d^3V}{dr^3} > 0$ (or if $e^{-\lambda V}$ has a positive Fourier transform), then the baryon mass relations Eqs. (5.11a) and (5.11b) can be proved (see [18]). These relations, which prescribe the sign of deviation from linearity of masses in the decuplet or from the Gell-Mann – Okubo relation in the octet, were proven above only under the explicit additional assumption of flavor symmetric wave functions, a point emphasized by Richard and Taxil [25]. [Indeed as shown by Lieb [18] and by Martin, Richard, and Taxil [185], Eqs. (5.11a) and (5.11b) are violated for potentials $V = r^a$ with sufficiently large a .]

It is not clear at the present what are all of the model independent statements about $V_{\bar{Q}Q}(R)$ that can be proven. We would like to mention, however, the very elegant result of Bachas [186] on the convexity

$$V(R) \geq \frac{1}{2} \left[V \left(\frac{R-r}{2} \right) + V \left(\frac{R+r}{2} \right) \right] \quad (18.1)$$

of $V(R)$. Together with earlier work by Simon and Yaffe [187] which shows a monotonically increasing $V(R)$, this promotes the BGM level ordering into a QCD theorem, which is confirmed in the $c\bar{c}$ system (and partially tested in the $b\bar{b}$ system).

Let us next reproduce Bachas' proof. The static potential is defined in terms of a rectangular Wilson loop W [77] in the (t, \vec{r}) plane of height $T \rightarrow \infty$ and width R :

$$V(R) = \lim_{T \rightarrow \infty} \left[-\frac{1}{T} \ln \langle \text{tr} U(W) \rangle \right], \quad (18.2)$$

with $U(W)$ the ordered product of U_{links} around the loop W . We have the path integral representation

$$\langle \text{tr}U(W) \rangle = \frac{\int \prod_{\text{links}} d\mu(U) \text{tr}U(W)}{\int \prod_{\text{links}} d\mu(U)}, \quad (18.3)$$

with $d\mu(U) = \prod d[U] \exp\left(-\frac{1}{g^2}\right) \sum_{\square} \text{tr}U_p$ the positive lattice measure. We can write $W = W_1(\tilde{\phi}\tilde{W}_2)$, where $\tilde{\phi}\tilde{W}_2$, the line reversed version of the reflected path, denotes the reflection of the portion of W to the left of the hyperplane indicated by the dotted line in Fig. 14. Obviously $U(\tilde{x}) = U^\dagger(x)$ and thus $\text{tr}U(W) = \text{tr}[U(W_1)U^\dagger(W_2)]$. We can compare $\langle \text{tr}U(W) \rangle$ with the corresponding expressions for the symmetric Wilson loops of size $R+r, R-r$ obtained by joining W_1 and ϕW_1 or W_2 and ϕW_2 . By dividing the $d\mu(U)$ integration into variables to the left of, right of, and on the reflection plane, the expectation values of $\langle \text{tr}(W_1\phi W_1) \rangle$ and $\langle \text{tr}(W_2\phi W_2) \rangle$ can be written as perfect squares, *e.g.* $\langle \text{tr}(W_1\phi W_1) \rangle = \int d\mu_{\text{on}} \text{tr} \left[\left(\int d\mu_R W_1 \right) \left(\int d\mu_R W_1 \right)^\dagger \right] = \int d\mu_{\text{on}} \text{tr} \left[\left(\int d\mu_L W_1 \right) \left(\int d\mu_L W_1 \right)^\dagger \right]$ and the Schwartz inequality implies $\langle \text{tr}U(W_2)U(\phi W_2) \rangle \cdot \langle \text{tr}U(W_2)U(\phi W_2) \rangle \geq |\langle \text{tr}U(W_2)U(\phi W_2) \rangle|^2$. The definition of $V(R)$, Eq. (18.2), then readily yields the desired convexity (18.1).

Similar arguments were applied [188] to the Eichten-Feinberg [139] representation of the tensor and spin-spin potentials. The inequalities obtained are basically in accord with a scalar long range confining potential [189].

The masses of the different quark flavors in the QCD Lagrangian (or Hamiltonian) $H = H_0 + \sum_{i=1}^{N_f} m_i^{(0)} \bar{\psi}_i \psi_i$ are the only explicit dimensional parameters. ‘‘Dimensional transmutation’’ generates, however, an additional scale $\Lambda_{\text{QCD}} (\approx$ a few hundred MeV). Thus, unlike QED with $r_{\text{Bohr}} \simeq (m_e)^{-1}$ and Coulombic binding $\simeq m_e$, we expect that scaling all quark masses $m_i^{(0)} \rightarrow cm_i^{(0)}$ changes physical masses (lengths) by less than a factor c ($1/c$). As we next argue, the simple linear dependence of H_{QCD} on $m_i^{(0)}$ further restricts the variation of mass parameters as a function of $m_i^{(0)}$.

In quantum mechanics the ground state energy $E^{(0)}(\lambda)$ is a convex function of any set of parameters that the Hamiltonian depends upon linearly [190]. If $H(\vec{\lambda}) = H_0 + \sum \lambda_i H_i = H_0 + \vec{\lambda} \cdot \vec{H}$, and $\vec{\lambda} = \alpha \vec{\mu} + (1-\alpha)\vec{\nu}$, then $E^{(0)}(\vec{\lambda}) \leq \alpha E^{(0)}(\vec{\mu}) + (1-\alpha)E^{(0)}(\vec{\nu})$. [This result follows immediately from $H(\vec{\lambda}) = \alpha H(\vec{\mu}) + (1-\alpha)H(\vec{\nu})$ by taking expectation values in $\psi^{(0)}(\vec{\lambda})$, the ground state of $H(\vec{\lambda})$, and using the variational principle.]

We wish to apply this result to the masses $m_{ij}^{(0)}(J^{PC})$ of ground state mesons with different flavor and Lorentz quantum numbers. We are hindered by the fact that we are not free to vary $m_i^{(0)}$ and by the need to subtract the vacuum energy. However, in a large N_c approximation where $q_i \bar{q}_i$ do not annihilate and effects of closed quark loops are neglected, it is meaningful to describe each sector m_{ij} by a separate Hamiltonian $H_{ij} = H_{\text{QCD}}^{(0)} + m_i \bar{\psi}_i \psi_i + m_j \bar{\psi}_j \psi_j$. The knowledge of the masses of the $0^{--}, 1^{--}, 2^{++}, \dots$ flavor multiplets can then be used to constrain ratios of quark masses like $R = (m_c^{(0)} - m_s^{(0)}) / (m_s^{(0)} - m_u^{(0)})$ [191]. The result obtained is somewhat large but still consistent with the estimates of Gasser and Leutwyler [181], and correspond to a lower bound $m_s^{(0)} \geq 80\text{-}100$ MeV.²³

Over the last twenty years there has been an ongoing effort to address in a systematic way the low energy sector of hadronic physics, and in particular the sector containing light quarks only via chiral perturbation theory (χ PT). The idea is to incorporate $S\chi$ SB, the Goldstone pions and current algebra, and the ensuing low energy theorems via effective Lagrangians [194,195] which will manifest the desired symmetries and which are written in terms of the pionic fields only. Then one uses these chiral Lagrangians to perform a systematic expansion in the external momenta of the problem, and/or the pion mass divided by some ‘‘hadronic scale’’ usually taken to be $4\pi f_\pi$. These effective Lagrangians contain a series of terms $\mathcal{L}_1, \mathcal{L}_2, \dots$ which in general are ranked according to the number of derivatives appearing in each term. One then can also systematically compute higher loop processes. A particularly simple and elegant form of such an effective Lagrangian is the Skyrme model [196], which even incorporates the nucleon as a soliton state.

In principle all the coefficients of the terms in the effective Lagrangian are computable from QCD. In practice they are often fixed by fitting some low energy data. In any event, QCD inequalities can often be applied to constrain the range of these parameters. While no systematic program of this kind has been completed, some steps have been taken by Comellas *et al.* [197]. By expressing the currents in the inequality relating vector and pseudoscalar currents

²³It is amusing to note that the relatively ‘‘large’’ ϵ'/ϵ ratio (as compared with previous theoretical estimates [192]) recently found in high precision experiments on CP violating kaon decays [193] do indeed suggest a relatively low $m_s^{(0)} \simeq 80$ MeV. The fact that we have so far been able to obtain only the above modest lower bound, rather than, say, $m_s^{(0)} \geq 190$ MeV, makes it easier to accommodate the measured ϵ'/ϵ in the standard model. In passing we note that the smaller $m_s^{(0)}$ value would also favor the stability of strange quark matter [192,193]. Note however that if the new lattice calculation of ϵ'/ϵ (see next Footnote) is adopted, the above remark need not apply.

as a χ PT expansion in the pionic field, and also by using the momentum space version of these inequalities, bounds on parameters in the effective Lagrangian were obtained, and are well satisfied.

Over the last decade the heavy quark approximation was often used in connection with $Q\bar{q}$ or Qqq systems. This is based on the realization that in the infinite m_Q limit the heavy quark simply becomes a static color source leading to some universality relations, heavy quark symmetry, and a systematic expansion in inverse powers of m_Q [198–200]. The Witten pseudoscalar mass inequalities such as $2m(q, \bar{Q}) > m(q, \bar{q}) + m(Q, \bar{Q})$ become trivial in this limit where the $Q\bar{Q}$ system is essentially Coulombic, with infinite binding $\alpha_s^2 m_Q/r$. Despite an interesting effort on the part of Guralnik and Manohar [201], it is not clear [202] how this can be amended to yield useful inequalities.

Precise information on nonperturbative QCD parameters of weak decay is of particular importance and may decide the fate of the Standard Model with the three generation KM scheme [203]. It is worth pointing out that some inequalities between such matrix elements can be motivated [204]. Let us then consider the $K \rightarrow \pi\pi$ decay. In addition to the standard left-handed four fermion operators [say $A = \bar{s}(x)\gamma_\mu L u(x)\bar{u}(x)\gamma_\mu L d(x)$, with $L = 1 - \gamma_5$ the left projection operator], we can extract from “penguin diagrams” additional mixed terms of the form $B = \bar{s}(x)\gamma_\mu L u(x)\bar{u}(x)\gamma_\mu R d(x)$, with $R = 1 + \gamma_5$. After using soft pion and current algebra techniques to reduce one pion we need to evaluate $\langle K|A(\text{or } B)|\pi\rangle$ matrix elements. The latter can be related to the asymptotic limit when $|x - y|$ and $|y - z| \rightarrow \infty$ of the three-point function $\langle 0|\bar{s}(x)\gamma_5 u(x)A(y)\bar{u}(z)\gamma_5 d(z)|0\rangle$. The latter has the path integral form

$$\langle K|A|\pi\rangle = \int d\mu(A) \text{tr} [\gamma_5 S_A(x, y)\gamma_\mu(1 - \gamma_5)S_A(y, z)\gamma_5 S_A(z, y)\gamma_\mu(1 - \gamma_5)S_A(y, x)] ,$$

corresponding to the unique contraction in Fig. 15. A similar expression with the second $1 - \gamma_5 \rightarrow 1 + \gamma_5$ applies when $A \rightarrow B$. We have assumed a flavor symmetric limit and used the same propagator S_A for all the quarks. Using $\gamma_5 S_A(x, y)\gamma_5 = S^\dagger(y, x)$, the hermiticity of the euclidean γ_μ , and $(\gamma_5\gamma_\mu)^\dagger = -\gamma_5\gamma_\mu$, we can show that the mixed $L - R$ expression (case B) has a path integral with an integrand which is an absolute square. It is therefore larger than the expression for the “pure” $L - L$ case (A) and allows the conclusion that

$$\langle K|B|\pi\rangle \geq \langle K|A|\pi\rangle .$$

While the soft pion limit *and* flavor symmetry assumed in the derivation are considerably weaker than this result we do still find it interesting and suggestive.²⁴

19. QCD INEQUALITIES BEYOND THE TWO-POINT FUNCTIONS

Most of the preceding sections, and of the work on QCD inequalities to date, has focused on euclidean two-point functions. These correlation functions are sufficient for obtaining hadronic masses via the spectral representation. An obvious advantage of two-point functions is that the path integrals expressing them [Eqs. (8.10a) and (8.10b)] contain products of quark propagators $S_A(x, y)$ between the *same* points x and y . Thus it is easy to prove positivity of certain combinations, *e.g.* $\text{tr}[S_A^\dagger(x, y)S_A(x, y)]$ and the ensuing inequalities between the integrands of the path integrals for various two-point correlation functions. These algebraic inequalities which are true “pointwise” for each external $A_\mu(x)$ configuration do survive the path integration with the positive measure $d\mu(A)$.

Can we make general statements in the form of inequalities also for three-, four-, and higher point euclidean correlation functions? Consider a generic four-point correlation function $\langle J_a(x)J_b(u)J_c(y)J_d(v)\rangle$, with a, b, c, d referring to Lorentz and flavor quantum numbers. By appropriate contraction we obtain an expression for correlation functions of the following general type, where for simplicity we assumed degenerate quark flavors and hence the same propagator S_A :

$$\langle J_a(x)J_b(u)J_c(y)J_d(v)\rangle = \int d\mu(A) \text{tr} [\Gamma_a S_A(x, u)\Gamma_b S_A(u, y)\Gamma_c S_A(y, v)\Gamma_d S_A(v, x)] . \quad (19.1)$$

All propagators S_A in the path integral refer to *different* pairs of points and it is not obvious how to construct positive definite combinations for each external $A_\mu(x)$ configuration separately.

²⁴It is worth noting that the B matrix element with the “8” construction is one of the ingredients fixing the positive sign of ϵ'/ϵ . The QCD inequalities are generally not operative when we have disconnected flavor contractions as in the “eye” contraction of Fig. 16. Since the latter appears to dominate the lattice calculated matrix element [205], we unfortunately cannot fix the sign of this very important quantity by QCD inequalities alone.

However, if we wish to study hadronic properties beyond the mass spectrum such as couplings, scattering amplitudes, weak interaction matrix elements, or wave functions, we need to consider more than two-point correlation functions [206]. In particular correlation functions of the form given in Eq. (19.1) have been used in order to study the charge distribution of mesonic states. Let the current

$$J_a^\dagger = \bar{\psi}_i(x)\Gamma_a\psi_j(x), \quad (19.2)$$

with $x = (-T, \vec{0})$, create at the origin, at some remote past instant, a quark and antiquark of flavors i, \bar{j} in a specific Lorentz state. As the system evolves under the QCD Hamiltonian it settles into the wave function of the ground state meson in this channel. Specifically, we can infer from the spectral expression Eq. (8.3) that after time T the components of excited states in the wave function of the system are suppressed relative to the ground state amplitude by $e^{-T\Delta m}$, with Δm the mass gap between the ground state and the first excited state. If we wish to find the relative separation of the quarks in the ground state, we can probe the system again with two external currents $J_b(u)J_d(v)$ at $u = (0, \vec{r}_1)$, $v = (0, \vec{r}_2)$, with $\vec{r}_{1,2} = (\vec{R} \pm \vec{r})/2$ and \vec{r} the relative separation. The currents J_b, J_d should refer to the flavors i and j of the quarks respectively

$$J_b = \bar{\psi}_i\Gamma_b\psi_i, \quad J_d = \bar{\psi}_j\Gamma_d\psi_j, \quad (19.3)$$

and we will take $\Gamma_b = \Gamma_d = \Gamma$. Finally, in order to obtain the complete gauge invariant correlation function the two quarks are propagated back to the origin where they are annihilated at $v = (T, \vec{0})$ by the current $J_c = J_a^\dagger$. Various attempts have been made to measure, via lattice Monte-Carlo calculations, charge distributions (or form factors) for the ground state mesons [207,208]. In the following we will focus on the particular case of the pion, *i.e.* using

$$\begin{aligned} J_a^\dagger &= \bar{\psi}_u\gamma_5\psi_d(x) = J_c \\ J_b &= \bar{\psi}_u\Gamma\psi_u, \quad J_d = \bar{\psi}_d\Gamma\psi_d \end{aligned}$$

we define

$$F(t, \vec{r}) = \int d^3\vec{R} \left\langle 0 \left| J_a^\dagger(-T, \vec{0}) J_b \left(0, \frac{\vec{r} + \vec{R}}{2} \right) J_a(T, \vec{0}) J_d \left(0, \frac{-\vec{r} + \vec{R}}{2} \right) \right| 0 \right\rangle. \quad (19.4)$$

This function has the following general properties [105]:

1. $F(T, \vec{r}) \leq F(T, \vec{0})$, *i.e.* the ‘‘charge density’’ is maximal at the origin.
2. The Fourier transform (*i.e.* the ‘‘form factor’’)

$$L(T, \vec{p}) = \int e^{i\vec{p}\cdot\vec{r}} F(T, \vec{r}) \quad (19.5)$$

is positive for all T and \vec{p} values

$$L(T, \vec{p}) \geq 0. \quad (19.6)$$

Evidently (2) implies (1): $F(t, \vec{r})$ is also the Fourier transform of the positive $L(t, \vec{p})$, and hence has its maximum value $\int L(t, \vec{p}) d^3\vec{p}$ at the origin ($\vec{r} = 0$).

In order to prove (2) let us consider the four-point correlation function

$$\begin{aligned} F &= \int d\mu(A) \text{tr} [\gamma_5 S_A^i(x, u) \Gamma S_A^i(u, y) \gamma_5 S_A^i(y, u) \Gamma S_A^i(u, x)] \\ &= \int d\mu(A) \text{tr} \left\{ [S_A^i(u, x)]^\dagger \tilde{\Gamma} [S_A^i(y, u)]^\dagger S_A^i(y, u) \Gamma S_A^i(u, x) \right\}, \end{aligned} \quad (19.7)$$

where we have used the ‘‘charge conjugation’’ property $\gamma_5 S_A(x, y) \gamma_5 = S_A^\dagger(y, x)$. $\tilde{\Gamma}$ is defined as

$$\tilde{\Gamma} = \gamma_5 \Gamma \gamma_5 = \pm \Gamma = \pm \Gamma^\dagger. \quad (19.8)$$

Using $u, v = (0, \vec{r}_{1,2})$ we take the Fourier transform with respect to $\vec{r} = \vec{r}_1 - \vec{r}_2$, assigning momentum $\vec{p}(-\vec{p})$ to the quark (antiquark) at $\vec{r}_1(\vec{r}_2)$. Exchanging the order of the $d\mu(A)$ and $d\vec{r}_1 d\vec{r}_2$ integration the Fourier transform can be written as

$$\begin{aligned}
L(T, \vec{p}) &= \int d\mu(A) \int d\vec{r}_1 \int d\vec{r}_2 e^{i\vec{p}\cdot(\vec{r}_1 - \vec{r}_2)} \text{tr} \left\{ S(y, u) \Gamma S(u, x) [S(y, v) \Gamma S(v, x)]^\dagger \right\} \\
&= \int d\mu(A) \text{tr} \left| \int d\vec{r}_1 e^{i\vec{p}\cdot\vec{r}_1} S(y, u) \Gamma S(u, x) \right|^2,
\end{aligned} \tag{19.9}$$

and the manifest positivity of the integrand persists after the $d\mu(A)$ (≥ 0) integration, yielding the desired result $L(T, \vec{p}) \geq 0$.

While $F(t, \vec{r})$ and $L(t, \vec{p})$ are well-defined, gauge invariant, and, in principle, measurable quantities, the suggestive interpretations as “charge density” and “form factor” are more heuristic. In particular it is not evident from Eq. (19.4) why $F(T, \vec{r})$ is positive definite as $T \rightarrow \infty$. Here we interpret F as $|\psi_\pi(\vec{r})|^2$, with ψ_π the “pion wave function”. Recall, however, that, as emphasized in the conclusion of Sec. 8, the positivity of norms [and spectral weight functions in Eq. (8.3)] emerges only after the $d\mu(A)$ integration has been performed and need not be manifest for each external $A_\mu(x)$ configuration separately.

As \vec{r}_2 approaches \vec{r}_1 , $S(y, v)$ and $S(y, u)$ [and likewise $S(x, u)$, $S(x, v)$] in Eq. (19.1) connect one vertex to two nearby points. For a typical smooth $A_\mu(x)$ configuration we expect $S(y, v) \rightarrow S(y, u)$ and the mixed products will gradually become squares (see Fig. 17). This suggests that $F(T, \vec{r})$ is not only maximum at $\vec{r} = 0$ but is also monotonically increasing towards $\vec{r} = 0$. This property does not hold for all gauge configurations, but only after averaging, since we expect smooth $A_\mu(x)$ configurations to dominate in $\int d\mu(A)$. Thus a proof of the conjectured monotonicity of $F(T, \vec{r})$ requires understanding the correlation between $A_\mu(x)$ along neighboring paths and would depend on the specific form of the Yang-Mills action S_{YM} . This action prefers small variations of the gauge fields over a small region [gradients of A_μ yield \vec{E} and \vec{B} and $S_{YM} = \int d^4x (\vec{E}^2 + \vec{B}^2)$].

If we identify $F(T = \infty, \vec{r})$ with the pion’s charge density, then it is amusing to note that the monotonicity of the ground state wave function can be proven in nonrelativistic quark models [209] when the potential is purely attractive. The fairly simple argument employs the spherical rearrangement technique [210], showing that given any trial wave function will always lower the energy by “rearranging” its values into a radially monotonically decreasing set.

The present discussion of four-point correlation functions applies only to pseudoscalar currents $J_5(x)J_5(y)$. Indeed it is precisely for the spin singlet S-wave “pion” state that *all* components of the nonrelativistic quark model potential – the confining linear part, the Coulomb force at shorter range, *and* the very short range, hyperfine color magnetic interactions – are attractive.

20. SUMMARY AND SUGGESTED FUTURE DEVELOPMENTS

We have presented above many inequalities for hadronic masses and analyzed the possible theoretical and phenomenological aspects. Many results follow essentially from the positivity of the measure in the functional path integral for euclidean correlation functions in QCD (or other vectorial theories). This may be on occasion complemented by fairly mild assumptions on the number of light degenerate flavors or the Zweig rule (large N_c) suppression of $q\bar{q}$ annihilation. These results include the Weingarten mass relations, the two Vafa-Witten theorems, the convexity of the $\bar{Q}Q$ potential, $m_{\pi^+} > m_{\pi^0}$, and Witten’s interflavor relation for pseudoscalars.

The fact that so many results, which have far-reaching implications, can be proven with such minimal input, is truly fascinating. We believe, however (and will try to make slightly more concrete conjectures later), that many more results would follow if we appeal to the specific form of the QCD action and in particular to its “ferromagnetic” character.

A large class of meson-meson and baryon-baryon mass relations follow from the flavor independence (apart from the explicit mass terms) of H_{QCD} . This allows us to prove operator relations for H_{QCD} restricted to different flavor sectors, from the mass relations following – though *only* for flavor symmetric wave functions. Under fairly general assumptions we can also use Hamiltonian variational techniques to prove detailed baryon-meson inequalities. All of the above together with some general level ordering rules for the different J^{PC} states (again motivated by QCD inequalities applied to $q\bar{q}$ potentials) can serve as extremely useful “Hund like” rules of thumb in the hadronic domain. This in turn can restrict the masses (or J^{PC} quantum numbers) of new flavor combinations or radial excitations.

In many cases the inequalities are more sophisticated versions of relations suggested by a naive quark model. Eventually we hope that much of the vast information available on hadronic parameters (including scattering, wave functions, *etc.*) will be constrained by such inequalities.

On the more theoretical side the generic properties of QCD and all vector QCD-like theories should be analyzed. The constraints imposed by the inequalities on composite models of quarks and leptons, together with the anomaly matching conditions, are particularly interesting. The fermion-boson inequalities, $m_F^{(0)} \geq m_B^{(0)}$, exclude the protection of small masses for composite quarks and leptons via an unbroken global axial symmetry, in all cases when we

have vectorial, QCD-like, underlying dynamics. Such constraints are avoided by going to chiral gauge models or (supersymmetric) models with scalars where the measure positivity $d\mu(A)$ is lost. (In passing we note that large classes of scalar and scalar plus fermion theories are ruled out by “triviality” difficulties [211].)

We have often referred to the euclidean correlation function approach to deriving the QCD inequalities as “rigorous” and to that based on the Hamiltonian variational approach as more “heuristic”. It should be emphasized that this does not reflect any true *objective* distinction. Clearly the Hamiltonian and Lagrangian approaches to classical mechanics, and to quantum field theory, are equivalent and equally rigorous (or not) depending on the practitioner.

The Hamiltonian variational approach allows inputting various approximations and/or physics intuition much more readily, however. These inputs can motivate certain restrictions on the wave function(al)s allowed. An example is our restriction in the nonperturbative derivation of the baryon-meson inequalities (Sec. 6) to baryonic configurations with only *one* junction point (see Fig. 4).

Clearly any restrictions on the class of wave function(al)s allowed potentially pushes the energy of the ground state higher. Hence, in particular, our restricted baryon is *not* the true ground state baryon. If, however, we can assume that any network containing some extra junction (and in this case, also extra anti-junction) points corresponds to “massive” components in the wave function(al) (with essentially extra virtual baryon-antibaryon pairs), then such components are likely to be small in the true ground state, and thus fairly safe to neglect. Similar comments apply to the neglect of possible sextet internal fluxons in our ansatz functionals for the quadri- and pentaquarks (see App. F).

Much of the intuition for hadronic physics stems from naive quark models. In these, the baryon-meson wave functionals are approximated by $q_{\text{con}}q_{\text{con}}q_{\text{con}}$ and $\bar{q}_{\text{con}}q_{\text{con}}$ wave functions. Here q_{con} refers to “constituent quarks”, namely some effective quasiparticles obtained when some short distance modes are integrated. Clearly this concept would be on firmer ground if we could indeed show that the mass of the constituent u and d quarks – which in the $m_u^{(0)} = m_d^{(0)} = 0$ axial SU(2) symmetry limit is purely dynamical – is indeed generated by physics (instantaneous, or other) operating on distance scales smaller than the radius of the baryon or meson.²⁵

Because the constituent quarks are extended, complex entities, the “potentials” acting between them are in general rather complex – with spin-, flavor-, and possibly energy-dependence and non-locality. Still, the naive expectations for potentials generated via gluon exchange seem to lead to very successful predictions. Overall the naive quark model, which predated QCD by almost a decade, still provides more insight and results than any of the more sophisticated effective Lagrangian approaches. Justifying its usage from first principles would therefore constitute a major triumph and is certainly a worthwhile effort. In our discussion of the QCD inequalities we have encountered on several occasions [*e.g.* in discussing the pion mass and wave function, the interflavor relations, and the positivity of EM and more general vectorial interaction energies (see Secs. 9 and 12 and App. G)] a remarkable coincidence between the “naive” quark model and rigorous QCD inequalities. Thus the efforts to extract constraints on the interquark potentials from QCD, and then to utilize this rather broad class of potentials allowed to derive level ordering theorems and/or baryon-baryon mass relations (see App. B), is quite worthwhile.

Even when we have mass dependent $q_{\text{con}}\bar{q}_{\text{con}}$ interactions, the system does retain its symmetry under $q_i^{\text{con}} \leftrightarrow \bar{q}_j^{\text{con}}$, and one may thus wonder if just this single feature, abstracted from the constituent quark model, is sufficient to supply the flavor symmetry assumption which was the missing link in our proof of meson the interflavor relations in Sec. 5. Unfortunately this is *not* the case. Essentially the operation $\psi_i^{(0)}(d) \leftrightarrow \psi_j^{(0)}(\bar{u})$ in Sec. 5 corresponds to exchanging the “fundamental”, pointlike, flavor carrying, entities inside the extended constituent quarks. For sufficiently heavy quarks the “cloud” of light degrees of freedom ($u\bar{u}, d\bar{d}$, and possibly $s\bar{s}$ and gluons) are universal and flavor-independent. However, the clouds around s and u quarks may differ significantly. Hence the above symmetry assumption cannot be justified in this case when *one* quark is heavy, and indeed $2m_{K^*} \leq m_\rho + m_\phi$, which relies on an $s^{(0)} \leftrightarrow u^{(0)}$ exchange, does marginally fail.

Clearly the $c \leftrightarrow u$ and $b \rightarrow u$ exchanges are even less justified, yet since the hyperfine mass splittings are very small ($\approx 1/m_c$ or $1/m_b$), the naive, spin-dependent, potential model derivation of the inequalities holds.

The rigor – and corresponding paucity of the euclidean correlation function QCD inequalities – reflects, in our view, the lack of intuition as to which $A_\mu^a(x)$ field configurations are more important in the functional path integral.²⁶ This makes justifying the approximation of keeping certain field configurations more difficult, and is more of a handicap than a virtue. By developing such an intuition akin to that inspired by the quark model or strong coupling approximation

²⁵The celebrated example of the extended yet most useful Cooper pair quasiparticles indicates that this may not be a necessary condition.

²⁶This is clearly a subjective statement, as such intuition might have been developed by lattice gauge calculations. Indeed the positivity of contributions of field configurations to the pseudoscalar propagators was known to practitioners in this field prior to the advent of QCD inequalities.

(which suggested the more important components of wave function(al)s in the variational approach), we could obtain many more heuristic, yet very important and useful inequalities. In delineating directions for future research on the subject of this review, an obvious goal is to try and find more rigorous proofs for likely correct inequalities, whose present derivations are lacking. These inequalities would include the detailed, flavor-dependent baryon-meson mass inequalities; relations between masses of different mesons such as $m_{a_1(1^+)} \geq m_{\rho(1^-)}$; and mass relations for glueballs such as $m_{\text{gb}}^{0^{++}} \leq (\text{mass of any glueball})$.

We believe, however, that there are additional, promising, richer avenues for further research. These involve two general (although unfortunately not completely well defined) conjectures that we would like to make next, and the application of the QCD inequality techniques to observables other than hadron masses.

20.1. A conjecture on the N_f dependence of the QCD inequalities

We have seen that many of the QCD inequalities such as $m_N \geq m_\pi$ and $m_{u\bar{d}}^{(0^+)} \geq m_{u\bar{d}}^{(0^-)}$ are related to observed symmetry patterns, namely the spontaneously broken global axial and the conserved vectorial symmetries. The correlator inequalities hold for arbitrary N_f . Indeed for N_f degenerate quarks, N_f only appears in the positive determinantal factor via $[\text{Det}(\mathcal{D} + m)]^{N_f}$. In particular, all the inequalities hold in the “quenched approximation” in which $N_f = 0$ and the determinantal factor disappears altogether. It is well known that in the quenched limit, lattice calculations of QCD, such as hadronic masses, couplings, *etc.* simplify enormously and one has (within this approximation!) completely reliable results.

The QCD inequalities, for example $m_N \geq m_\pi$ and $m_\rho \geq m_\pi$, are often satisfied by a large margin. If we had, however, a systematic trend for the inequalities to become weaker in the sense, say, that m_N/m_π , m_ρ/m_π decrease as N_f increases, that could furnish very useful information such as

$$\left. \frac{m_N}{m_\pi} \right|_{\text{expt}} \leq \left. \frac{m_N}{m_\pi} \right|_{\text{quenched}}. \quad (20.1)$$

We would like to conjecture that this is indeed the case. Our motivation is the likely decrease of the “strength” of the $S\chi$ SB as manifested via the magnitude of $\langle q\bar{q} \rangle$ (measured in an appropriate way) with N_f . Indeed increasing N_f weakens – via enhanced screening – the $q\bar{q}$ gluon exchange interactions and consequently the expected value of $\langle q\bar{q} \rangle$.

Consider $\langle \bar{\psi}\psi \rangle_A = \langle \text{tr} S_F \rangle_A$, with $\langle \bar{\psi}\psi \rangle_A$ evaluated for a particular gauge background A [here $\langle \mathcal{O} \rangle_A = \int d\mu(A) \langle \mathcal{O} \rangle_A / \mathcal{Z}$]. We can write

$$\langle \text{tr} S_F \rangle_A = \sum_j \frac{1}{(i\lambda_j(A) + m)} = \sum_j \frac{m}{\lambda_j^2(A) + m^2}, \quad (20.2)$$

where in the last expression we paired together the γ_5 conjugated, non-vanishing eigenvalues $\pm i\lambda_j$ of \mathcal{D} . For the $m \rightarrow 0$ limit of interest, the Lorentzians become δ -functions and hence we have

$$\langle q\bar{q} \rangle \neq 0 \leftrightarrow \lim_{\lambda \rightarrow 0} \rho(\lambda) \neq 0,$$

with $\rho(\lambda)$ the density obtained after the $\frac{1}{\mathcal{Z}} \int d\mu(A)$ averaging of the eigenvalues of \mathcal{D} .

If $d\mu_0(A) = \int d[A_\mu(x)] \exp[-S_{YM}(A_\mu)]$ is the $N_f = 0$ measure, the conjectured decrease of $\langle \bar{\psi}\psi \rangle$ when $N_f = 0 \rightarrow N_f \neq 0$ amounts to:

$$\left\langle \prod_l [\lambda_l^2(A) + m^2] \sum_j [\lambda_j^2(A) + m^2]^{-1} \right\rangle_0 \leq \left\langle \prod_l [\lambda_l^2(A) + m^2] \right\rangle_0 \left\langle \sum_j [\lambda_j^2(A) + m^2]^{-1} \right\rangle_0, \quad (20.3)$$

with $\langle f \rangle_0$ indicating averaging with the $d\mu_0(A)$ measure. Since the factors $\prod_l (\lambda_l^2 + m^2)$ and $\sum_j (\lambda_j^2 + m^2)^{-1}$ appearing in the conjectured inequality (20.3) are, respectively, monotonically increasing (decreasing) with each λ , the conjecture is very suggestive. Indeed for *any two* positive functions of one variable $f(x)$ and $g(x)$ which are monotonically increasing (decreasing), $\langle f \rangle \langle g \rangle \geq \langle fg \rangle$. However, as pointed out to us by O. Kenneth [212], this inequality does not generally hold for functions of many variables. In the present context it implies that measures $d\mu(\lambda_1, \dots, \lambda_N)$ can be constructed for which the conjectured inequality (20.3) can be reversed. This inequality is therefore heuristic and depends on additional assumptions. Recalling our comment on functions of one variable, the inequality would apply if there were one dominant variable in the measure $d\mu[A(x)]$. Color confinement and asymptotic freedom suggest that

the overall scale R of the $A_\mu(x)$ fluctuations could serve in such a role. The enhanced weight of larger fluctuations coupled with the expected smallness of the corresponding $\lambda_i(A)$ indicates that this may indeed be the case.

Changing N_f changes the β function and hence, for fixed g^2 , also Λ_{QCD} . This in turn implies that the mass/length scales used in two lattice calculations with different N_f values should be appropriately changed to allow for meaningful comparisons.

In general hadron masses [and also $\sqrt{\sigma}$, with σ the string constant (\approx the coefficient of the linear potential in heavy quarkonia, and $\langle q\bar{q} \rangle^{1/3}$] scale linearly with Λ_{QCD} and comparing ratios of such quantities for different N_f values is straightforward. However, $m_{\pi^+} \approx \sqrt{f_\pi m_\pi} \approx \sqrt{\Lambda_{\text{QCD}} m_0}$, with m_0 the $(u+d)/2$ bare quark mass. Hence instead of Eq. (20.1) we should use

$$\frac{m_N f_\pi}{m_\pi^2} \leq \frac{m_N f_\pi}{m_\pi^2} \Big|_{\text{quenched}} . \quad (20.4)$$

In conclusion we recall yet another heuristic supporting argument for the conjectured decrease of $\langle q\bar{q} \rangle / (\Lambda_{\text{QCD}})^3$, *i.e.* of the quark condensate, with N_f . It is the restoration of Q_5 symmetries in exactly SUSY QCD theories [213] at moderate N_f/N_c ratios, for which asymptotic freedom (and even confinement) may still hold. Since real QCD is *not* supersymmetric, and further, since QCD inequalities may not apply for SUSY theories, the significance of this fact in the present context is not clear.

20.2. Conjectured inequalities related to the “ferromagnetic” nature of the QCD action

The monotonic pion (configuration space) wave function was motivated in the conclusion of Sec. 19 above by the ferromagnetic nature of the Yang-Mills action. In some ferromagnetic spin systems this feature is embodied in a rigorous set of Griffith’s inequalities [214] for the spin correlations. The analogous A_μ correlations are not gauge invariant but some gauge invariant versions can be conjectured.

The ferromagnetic character of QCD can motivate many other conjectured inequalities, of which we will mention just a few. An $E_1^a E_2^a(x)$ excitation at x (with 1 and 2 spatial indices of \vec{E}^a , the color electric field) and an $E_1^a E_2^a(y)$ excitation at y ²⁷ correspond intuitively to parallel “spins” (the corresponding plaquettes at x and y in the euclidean lattice are indeed parallel). Likewise $B_1^a B_2^a(x)$ and $B_1^a B_2^a(y)$ are “parallel”. However, $E_1^a(x) B_2^a(x)$ and $E_2^a(y) B_1^a(y)$ are not “parallel”. The preference of parallel configurations and the stronger positive correlation between such configurations suggests therefore that

$$\begin{aligned} \langle E_1^a(y) E_2^a(y) E_1^{a'}(x) E_2^{a'}(x) \rangle &\geq \langle E_1^a(y) B_2^a(y) E_2^{a'}(x) B_1^{a'}(x) \rangle \\ \langle B_1^a(y) B_2^a(y) B_1^{a'}(x) B_2^{a'}(x) \rangle &\geq \langle E_1^a(y) B_2^a(y) E_2^{a'}(x) B_1^{a'}(x) \rangle , \end{aligned}$$

and in particular

$$\langle E_1 E_2(x) E_1 E_2(y) \rangle \langle B_1 B_2(x) B_1 B_2(y) \rangle \geq |\langle E_1 B_2(x) E_2 B_1(y) \rangle|^2 . \quad (20.5)$$

which has been suggested by Muzinich and Nair [21,152] along with many other inequalities. Since $E_1 E_2$ (or $B_1 B_2$) and $E_1 B_2$ acting on the vacuum creates 2^{++} (2^{-+}) states, the last inequalities suggest that the lowest lying 2^{++} glueball is lighter than the lowest 2^{-+} state:

$$m_{2^{++}}^{(0)} \leq m_{2^{-+}}^{(0)} . \quad (20.6)$$

We believe that Eq. (20.5), many other Muzinich-Nair relations (some of which involve J dependence of masses as well), and other yet to be discovered relations are true, but also furnish tests not just of the measure positivity in QCD, but rather of the ferromagnetic nature of its action.

²⁷*i.e.* the state of the system obtained immediately after $E_1^a(x) E_2^a(x)$ operates on the vacuum. Here $a = 1 \dots 8$ is a color index, and 1 and 2 indicate the x_1 and x_2 components ($E_1 = F_1^0$ etc.).

20.3. Inequalities for quantities other than hadronic masses

The inequalities between two-point correlation functions and the variational Hamiltonian techniques naturally tend to yield inequalities between masses, rather than between other hadronic observables. We have seen, however, in Secs. 16 and 19, and at the end of Sec. 18, other applications of the QCD inequalities techniques involving scattering lengths, form factors, and weak matrix elements. In this last subsection we would like to consider yet another quantity, namely high energy hadronic cross sections. These attracted much attention in the sixties and seventies, in connection with “Regge pole” exchanges in the crossed t -channel, and the approximate “quark counting” suggested relation $\sigma_{\pi N} \approx \frac{2}{3}\sigma_{NN}$ was one of the early indicators for the relevance of the quark model.

In retrospect asymptotic cross sections may reflect physics which is quite different from that controlling meson and baryon masses. Hence while the quark counting rule also suggested $m_B \gtrsim \frac{3}{2}m_M$, which has been “transformed” here to the baryon-meson mass inequalities, it is not clear that we have analogous inequalities for hadronic cross sections:

$$\sigma_{NN} \gtrsim \frac{3}{2}\sigma_{MN}. \quad (20.7)$$

However, this is precisely what we would like to conjecture here (along with the more detailed flavor dependent variants). We have attempted to motivate such a conjecture by using intersecting chromoelectric fluxons as a model for high energy cross sections [215] and the stringy trial wave functionals of Sec. 6. While we have not succeeded (mainly because of “shadowing” – multiple intersections which are more prominent in baryon-baryon collisions), this model is highly inadequate as it does not account for the rising cross sections.

We note that if $\int_{\Omega_1} E_1^2 d^3x$ and $\int_{\Omega_2} E_2^2 d^3x$ roughly reflect the masses of hadrons 1 and 2 extending over Ω_1, Ω_2 , and $\int \vec{E}_1 \cdot \vec{E}_2 d^3x$ generates the Born scattering amplitude, we expect some relation of the form²⁸

$$\sigma_{12} \lesssim \frac{C}{\Lambda_{\text{QCD}}^4} m_1 m_2$$

Clearly the case of the Goldstone, almost massless pion is again very special.²⁹ The arguments of Sec. 14 could be formally extended to the (non-planar) exchanges pertinent to high energy cross sections. This would then suggest relations like $(\sigma_{\pi\pi})(\sigma_{NN}) \geq (\sigma_{\pi N})^2$, which unfortunately would be difficult to test.

Physics similar to that motivating the QCD inequalities could be used at many other length scales, and not only for underlying composite models. Thus some variant of the Schwartz propagator inequality (12.4) may have implications for the frequency of occurrence of like-sex non-identical twins, and the more heuristic interflavor inequalities of Sec. 5, can suggest many inequalities between bindings of polar molecules. We discuss these applications in App. H.

We believe that much more can and will be done on the subject of inequalities, both in and out of QCD.

ACKNOWLEDGMENTS

It is often difficult to trace the precise inception of any project. The motivation of S. Nussinov to prove a baryon-meson inequality, using lattice techniques, stemmed from a well defined origin. It was the summary talk in a lattice workshop (held in the summer of 1982 at Saclay) by the late Claude Itzykson. Itzykson, a pioneer of lattice QCD and one of the finest mathematical physicists of our generation, commented on the lack of rigorous results in QCD. Indeed even now, seventeen years later, there are preciously few such results.

The work of S.N. on QCD inequalities, and this review in particular, has been carried out during the last sixteen years at Tel Aviv University; Brookhaven National Laboratory; Los Alamos National Laboratory; Universities of Maryland, Pennsylvania, and Minnesota; MIT; and at Boston University, SUNY Stonybrook, and the University of South Carolina. The material in Sec. 16 is largely based on joint work with B. Sathiapalan, and Sec. 19 and a portion of Sec. 11 on work with M. Spiegelglas.

S.N. would like to acknowledge the crucial help of E. Lieb at a very early stage, and his contribution to Sec. 19; the friendly and helpful correspondance with D. Weingarten and discussions with E. Witten; the encouragement of

²⁸ $\sigma_{12} \sim m_1 m_2$ is expected if the total cross section is dominated by a tensor particle exchange, which in turn dominates (in the sense of vector meson dominance) the graviton couplings [31].

²⁹ The smallness of the pion mass relative to, for example, the ρ , stems in quark models from large short range hyperfine attraction. It is quite surprising that this hardly results in a smaller sized pion and in $\sigma_{\pi N} \leq \sigma_{\rho N}$ (the “rho-pi puzzle” [216]).

J. Sucher and S.L. Glashow; and the interest of the late Y. Dothan, W. Greenberg, R. Mohapatra, and J. Pati. The critical comments of A. Casher, E. Lieb, A. Martin, J.-M. Richard, P. Taxil, and E. Witten made S.N. realize some shortcomings of his earlier work. During the writing of the review S.N. enjoyed discussions with M. Cornwall, S. Elitzur, Y. Hosotani, O. Kenneth, H.J. Lipkin, A. Martin, I.J. Muzinich, and V.P. Nair. We are particularly grateful to B. Svetitsky for many helpful comments and advice, and to him and to B. Sathiapalan for reading earlier versions of the manuscript. S.N. would like to acknowledge the very warm hospitality of the Institute for Theoretical Physics at the University of Minnesota, and in recent years the University of South Carolina, which helped him very much in writing the review. M.L. would like to thank S.N. for introducing her to the subject QCD inequalities and for asking her to help with this review. The work of M.L. was supported by the Israel Science Foundation under Grant No. 255/96-1. Finally, S.N. would like to acknowledge a grant from the Israel Academy of Sciences.

APPENDIX A: LIEB'S COUNTEREXAMPLE TO EQ. (4.1)

Following Lieb [18] we prove that for the case of $m = \infty$ and two-body potentials which are infinite square wells:

$$V_{ij}(\vec{r}_i - \vec{r}_j) = V_{i.s.w.}(r) = \begin{cases} \infty, & r \geq r_0 \\ 0, & r \leq r_0 \end{cases} \quad (\text{A1})$$

the conjectured ‘‘convexity’’ relation

$$E^{(0)}(m, m, m) + E^{(0)}(m, M, M) \leq 2E^{(0)}(m, m, M) \quad (\text{A2})$$

is violated.

To achieve minimal (and indeed even finite!) ground state energies, the wave functions have to vanish when $|\vec{r}_i - \vec{r}_j| > r_0$ for any quark pair. For heavy quarks this can be done with no kinetic energy penalty. Thus let us fix $\vec{r}_1 = 0$ in all three wave functions $\psi^{(0)}(m, m, m)$, $\psi^{(0)}(m, m, M)$, and $\psi^{(0)}(m, M, M)$, thereby disposing also of the overall translational degrees of freedom. For $\psi^{(0)}(m, m, m)$ we could take all $\vec{r}_i = 0$, achieving the minimal possible energy: $E^{(0)}(m, m, m) = 0$. In $\psi^{(0)}(m, m, M)$ it is clearly advantageous to put also $\vec{r}_2 = \vec{r}_1 = 0$ so that the condition $|\vec{r}_3 - \vec{r}_2| \leq r_0$ is satisfied automatically once $|\vec{r}_3 - \vec{r}_1| \leq r_0$. Thus finding $E^{(0)}(m, m, M)$ reduces to finding the minimal energy of the one-body Hamiltonian $\vec{p}^2/2M + 2V(\vec{r})$, which for $V = V_{i.s.w.}$ is $h \equiv \vec{p}^2/2M + V(\vec{r})$.

On the other hand, $E^{(0)}(m, M, M)$ is the minimal energy of

$$\hat{h} = [\vec{p}_2^2/2M + V(\vec{r}_2)] + [\vec{p}_3^2/2M + V(\vec{r}_3)] + V(\vec{r}_2 - \vec{r}_3). \quad (\text{A3})$$

If $V(\vec{r}_2 - \vec{r}_3)$ were absent, \hat{h} separates into two one-body infinite square well problems and

$$E^{(0)}(\hat{h}) = 2E^{(0)}(h).$$

However, since $\langle V_{23} \rangle \geq 0$ we have

$$E^{(0)}(\hat{h}) \equiv E^{(0)}(m, M, M) \geq 2E^{(0)}(h) = 2E^{(0)}(m, m, M), \quad (\text{A4})$$

and the desired inequality (A2) is violated. Indeed $\psi_{mMM}^{(0)}(\vec{r}_1 = 0, \vec{r}_2, \vec{r}_3)$ has to vanish now in all of the region $|\vec{r}_2 - \vec{r}_3| \geq r_0$ in addition to the vanishing for $r_2 \geq r_0, r_3 \geq r_0$. Incorporating this extra constraint reduces the allowed six-dimensional volume in (\vec{r}_2, \vec{r}_3) space from $(4\pi r_0^3/3)^2$ to a fraction thereof. Obviously this will increase the kinetic energy from $2E^{(0)}(h)$ to $(2 + \alpha)E^{(0)}(h)$, with $\alpha \approx 1$.

By continuity we therefore expect Eq. (A2) to fail already when we approach the limit $m \rightarrow \infty$ and $V(r) \rightarrow V_{i.s.w.}(r)$, *e.g.* via

$$V(r) = c_n(r/r_0)^n, \quad n \rightarrow \infty. \quad (\text{A5})$$

In passing we note that $\exp[-\beta V_{i.s.w.}(r)] = \Theta(r - r_0)$ is indeed not a positive semidefinite operator, since its Fourier transform is not positive. This should be the case since we have, as indicated in the following Appendix, Lieb's theorem that the desired inequality holds when $\exp[-\beta V]$ is positive semidefinite. Also for $V(r) = r^n, n \geq 4$, a case for which another counter-example was produced first [39], $\exp[-\beta V(r)]$ is not positive semidefinite – consistent with the fact that it fails the convexity conditions.

APPENDIX B: DISCUSSION OF LIEB'S RESULTS FOR THREE-BODY HAMILTONIANS

Following Lieb [18], we prove the inequality (A2) when the potentials are flavor independent:

$$V(m, m) = V(M, M) = V(m, M) \equiv V ,$$

and $\exp[-\beta V(\vec{x} - \vec{y})]$ positive semidefinite.

The propagation over (imaginary) euclidean time β of the three-body system is given by $\langle X | e^{-\beta H} | X' \rangle$, with $X = (x_1, x_2, x_3)_{initial}$, $X' = (x_1, x_2, x_3)_{final}$. We compare three systems with

$$\begin{aligned} H_a &= T_1(x_1) + T_2(x_2) + T_2(x_3) + V_2(x_1, x_2) + V_2(x_1, x_3) + V_1(x_2, x_3) \\ H_b &= T_1(x_1) + T_2(x_2) + T_3(x_3) + V_3(x_1, x_2) + V_2(x_1, x_3) + V_1(x_2, x_3) \\ H_c &= T_1(x_1) + T_3(x_2) + T_3(x_3) + V_3(x_1, x_2) + V_3(x_1, x_3) + V_1(x_2, x_3) . \end{aligned} \quad (\text{B1})$$

For $X = X'$, $\mathcal{Z}_\beta(x) = \langle X | e^{-\beta H} | X \rangle$ is dominated, for $\beta \rightarrow \infty$, by the lowest energy state

$$\langle X | e^{-\beta H} | X \rangle = \sum_n |\langle X | n \rangle|^2 e^{-\beta E_n} \xrightarrow{\beta \rightarrow \infty} |\langle X | 0 \rangle|^2 e^{-\beta E_0} , \quad (\text{B2})$$

where we use the completeness sum over energy eigenstates.

Thus to prove the desired inequality

$$E^{(0)}(a) + E^{(0)}(c) \leq 2E^{(0)}(b)$$

it suffices to show that

$$\mathcal{Z}_\beta(a)\mathcal{Z}_\beta(c) \geq \mathcal{Z}_\beta^2(b) . \quad (\text{B3})$$

In general the path integral, and \mathcal{Z}_β in particular, is obtained by dividing the total evolution into many consecutive evolutions over small time steps, so that

$$\mathcal{Z}_\beta = \lim_{N \rightarrow \infty} \mathcal{Z}_\beta(N) = \left[\left(e^{-\beta T/N} e^{-\beta V/N} \right)^N \right] ,$$

with T and V the total one-body kinetic and two-body potential parts of the Hamiltonian $H = T + V$. Clearly it is sufficient to prove the inequality for each N .

We next insert a complete set of X -space states between each pair of $e^{-\beta T/N} e^{-\beta V/N}$ factors. This gives \mathcal{Z}_β as a path integral. Each such path consists of three (spatially) closed polygonal paths $\tilde{X}_1, \tilde{X}_2, \tilde{X}_3$, with \tilde{X}_1 consisting of the $N + 1$ points

$$\tilde{X}_1(0) = X_1, X_1(\beta/N), X_1(2\beta/N), \dots, X_1(N\beta/N) = X_1(\beta) = X_1 ,$$

and likewise for \tilde{X}_2 and \tilde{X}_3 (see Fig. 21). Since each factor

$$\langle X_1(j)X_2(j)X_3(j) | e^{-\beta T/N} e^{-\beta V/N} | X_1(j+1)X_2(j+1)X_3(j+1) \rangle \quad (\text{B4})$$

involves an evolution over an infinitesimal ‘‘time’’ β/N , the non-commutativity of the kinetic and potential parts of H is neglected. The kinetic single particle operators contribute to $\mathcal{Z}_\beta^N(a)$ a factor of

$$F_a = F_1(\tilde{X}_1)F_2(\tilde{X}_2)F_2(\tilde{X}_3) ,$$

and to $\mathcal{Z}_\beta^N(b)$ and $\mathcal{Z}_\beta^N(c)$

$$\begin{aligned} F_b &= F_1(\tilde{X}_1)F_2(\tilde{X}_2)F_3(\tilde{X}_3) \\ F_c &= F_1(\tilde{X}_1)F_3(\tilde{X}_2)F_3(\tilde{X}_3) \end{aligned}$$

with $F_i(X)$ corresponding to T_i in Eq. (B1) above.

The potential two-body operators contribute to \mathcal{Z}_β^N a product of three terms depending on the three pairs of paths. Specifically, the contributions in cases (a), (b), and (c) are

$$\begin{aligned}
\mathcal{Z}_\beta^N(a) &: G_2^N(\tilde{X}_1, \tilde{X}_2)G_2^N(\tilde{X}_1, \tilde{X}_3)G_1^N(\tilde{X}_2, \tilde{X}_3) \\
\mathcal{Z}_\beta^N(b) &: G_2^N(\tilde{X}_1, \tilde{X}_2)G_3^N(\tilde{X}_1, \tilde{X}_3)G_1^N(\tilde{X}_2, \tilde{X}_3) \\
\mathcal{Z}_\beta^N(c) &: G_3^N(\tilde{X}_1, \tilde{X}_2)G_3^N(\tilde{X}_1, \tilde{X}_3)G_1^N(\tilde{X}_2, \tilde{X}_3),
\end{aligned}$$

where the $G_i(\tilde{X}_k, \tilde{X}_l)$ are generated from $V_i(X_k, X_l)$ via

$$G_i(\tilde{X}_k, \tilde{X}_l) = \prod_{j=1}^N \exp[-(\beta/N)V_i(X_k(\beta j/N), X_l(\beta j/N))] .$$

For the particular case of V_1 , the fact that $e^{-\beta V_1/N}$ is positive semidefinite ensures that the N -fold tensor product defining $G_1(\tilde{X}_2, \tilde{X}_3)$ is also positive semidefinite. Collecting all terms and separating the $d^{3(N-1)}X_1$ integrations over the $N-1$ intermediate points X_1^2, \dots, X_1^N along the polygonal path \tilde{X}_1 we have

$$\begin{aligned}
\mathcal{Z}_\beta^N(a) &= \int d^{3(N-1)}X_1 F_1(\tilde{X}_1) \int d^{3(N-1)}X_2 \int d^{3(N-1)}X_3 \\
&\quad \times G_2^N(\tilde{X}_1, \tilde{X}_2)F_2(\tilde{X}_2)G_2^N(\tilde{X}_1, \tilde{X}_3)F_2(\tilde{X}_3)G_1^N(\tilde{X}_2, \tilde{X}_3) \\
\mathcal{Z}_\beta^N(b) &= \int d^{3(N-1)}X_1 F_1(\tilde{X}_1) \int d^{3(N-1)}X_2 \int d^{3(N-1)}X_3 \\
&\quad \times G_2^N(\tilde{X}_1, \tilde{X}_2)F_2(\tilde{X}_2)G_3^N(\tilde{X}_1, \tilde{X}_3)F_3(\tilde{X}_3)G_1^N(\tilde{X}_2, \tilde{X}_3) \\
\mathcal{Z}_\beta^N(c) &= \int d^{3(N-1)}X_1 F_1(\tilde{X}_1) \int d^{3(N-1)}X_2 \int d^{3(N-1)}X_3 \\
&\quad \times G_3^N(\tilde{X}_1, \tilde{X}_2)F_3(\tilde{X}_2)G_3^N(\tilde{X}_1, \tilde{X}_3)F_3(\tilde{X}_3)G_1^N(\tilde{X}_2, \tilde{X}_3) .
\end{aligned} \tag{B5}$$

Defining next the $N \times N$ matrices

$$\begin{aligned}
V_2^N(\tilde{X}_1, \tilde{X}_2) &= \sqrt{F_1(\tilde{X}_1)G_2^N(\tilde{X}_1, \tilde{X}_2)F_2(\tilde{X}_2)} \\
V_3^N(\tilde{X}_1, \tilde{X}_2) &= \sqrt{F_1(\tilde{X}_1)G_3^N(\tilde{X}_1, \tilde{X}_2)F_3(\tilde{X}_2)},
\end{aligned} \tag{B6}$$

we can write Eq. (B5) in the concise form

$$\begin{aligned}
\mathcal{Z}_\beta^N(a) &= \text{tr}(V_2^T \cdot G_1 \cdot V_2) \\
\mathcal{Z}_\beta^N(b) &= \text{tr}(V_2^T \cdot G_1 \cdot V_3) \\
\mathcal{Z}_\beta^N(c) &= \text{tr}(V_3^T \cdot G_1 \cdot V_3) .
\end{aligned} \tag{B7}$$

We note that the positivity of $F_1(\tilde{X}_1)$ was implicitly assumed in taking the square root in Eq. (B6). For the case of interest with $T_1 = \vec{p}_1^2/(2m_1)$, $\langle X_1 | e^{-\beta T} | X_1 \rangle$ is the probability for returning to the initial point in a Gaussian random walk after a time β . $F^N(X_1)$ is the probability that this happens for a specific path X_1 with $N-1$ specific intermediate steps, and hence is clearly positive. This positivity of the “heat kernel” can apparently be generalized to other relativistic forms of the kinetic energy, for example $T_1 = \sqrt{\vec{p}_1^2 + m_1^2}$.

To complete the proof we note that Eqs. (B7) define a “scalar product” of V_2 with itself, V_2 and V_3 , and V_3 with itself. This can be most clearly seen by transforming to the basis in which G_1 is diagonal with all diagonal elements real and positive. This change of basis leaves $\text{tr}(V_2^T G_1 V_3)$ invariant but casts it in the form

$$\sum_{\alpha, n} (V_2)_{\alpha n} (G_1)_{nn} (V_3)_{n\alpha} ,$$

which is bilinear in V_2 and V_3 and positive whenever two identical “V-vectors” (of length $[3(N-1)]^2$) are used. Hence these scalar products satisfy the Schwartz inequality which is precisely the desired result (B3).

It has been noted by Lieb that the assumption of having only two-body potentials is rather restrictive and we can allow also genuine three-body potentials $V(X_1, X_2, X_3)$ as long as $e^{-\beta V}$ is positive semidefinite as a function of X_2, X_3 .

APPENDIX C: PROOF OF EQ. (5.2)

We prove Eq. (5.2) using a concrete basis of states in which it holds for all matrix elements. We will use the Hamiltonian version of QCD with a spatial cubic lattice (sites \vec{n} , unit vectors $\hat{\eta}$ along the positive x, y, z axes).

The QCD Hamiltonian is written as [4,217]

$$\begin{aligned}
 H_{\text{QCD}} = & \frac{g^2}{2} \sum_{\vec{n}, \hat{\eta} > 0} \text{tr}(E_{\vec{n}, \vec{n} + \hat{\eta}})^2 + \frac{1}{2g^2} \sum_{\text{plaquettes}} \text{tr}(UUU^\dagger U^\dagger + \text{h.c.}) \\
 & + \sum_{i=1}^{N_f} \sum_{\vec{n}, \hat{\eta} > 0} \psi_i^\dagger(\vec{n}) U_{\vec{n}, \vec{n} + \hat{\eta}} \psi_i(\vec{n} + \hat{\eta}) + \text{h.c.} + \sum_{i=1}^{N_f} \sum_{\vec{n}} m_i \bar{\psi}_i(\vec{n}) \psi_i(\vec{n}) + \dots .
 \end{aligned} \tag{C1}$$

It depends on the SU(3) ‘‘connection’’ matrices $U_{\vec{n}, \vec{n} + \hat{\eta}}$ which live on lattice links between \vec{n} and $\vec{n} + \hat{\eta}$, the canonically conjugate generators $E_{\vec{n}, \vec{n} + \hat{\eta}}$, and the fermionic spinors $\psi_i(\vec{n})$ [and conjugate $\bar{\psi}_i(\vec{n})$] at each lattice site. The first three terms are analogous to the \vec{E}^2, \vec{B}^2 and $\bar{\psi}(x) \not{D} \psi(x)$ terms in the continuum Hamiltonian.

We adopt the ‘‘strong coupling’’ basis in which all $\text{tr}(E_{\vec{n}, \vec{n} + \hat{\eta}})^2$ are diagonal. At each lattice site we specify the spinors $\psi_i(\vec{n})$. The mass term is

$$\sum_{\vec{n}} \sum_{i=1}^{N_f} \psi_i^\dagger(\vec{n}) \gamma_0 m_i \psi_i(\vec{n}) . \tag{C2}$$

Each of the plaquette terms creates a minimal, closed, \vec{E} flux line going clockwise (or anti-clockwise) around an elementary plaquette. This will, in general, change $\text{tr}(E_{\vec{n}, \vec{n} + \hat{\eta}})^2$ on each of the four adjoining links and hence gives rise to non-diagonal elements in the representation considered here. Also the third $[\psi(x) \not{D} \psi(x)]$ term changes the lattice configuration by allowing the quark to ‘‘hop’’ to a neighboring site (dragging along a flux line), and by creating or annihilating $q_l \bar{q}_l$ pairs at neighboring sites.

We illustrate some of the matrix elements of H_{QCD} on a small 3×3 two-dimensional lattice in Fig. 7. Each of the columns and rows is labeled by a complete lattice configuration. In the matrix we indicate both the actual value of the matrix elements (above dotted line) and the specific terms of H_{QCD} contributing to it (below dotted line). We omit additional four-fold spinor indices for each of the occupied sites.

Local gauge invariance

$$\begin{aligned}
 \psi_i(\vec{n}) & \rightarrow V(\vec{n}) \psi_i(\vec{n}) \\
 \bar{\psi}_i(\vec{n}) & \rightarrow \bar{\psi}_i(\vec{n}) V^\dagger(\vec{n}) \\
 U_{\vec{n}, \vec{n} + \hat{\eta}} & \rightarrow V(\vec{n}) U_{\vec{n}, \vec{n} + \hat{\eta}} V^\dagger(\vec{n} + \hat{\eta}) \\
 E_{\vec{n}, \vec{n} + \hat{\eta}} & \rightarrow V(\vec{n}) E_{\vec{n}, \vec{n} + \hat{\eta}} V^\dagger(\vec{n} + \hat{\eta}) ,
 \end{aligned} \tag{C3}$$

is respected by all terms of H_{QCD} . It constrains the physically allowed states via Gauss’ equation

$$\sum_{\pm \hat{\eta}} E_{\vec{n}, \vec{n} + \hat{\eta}} = \sum_l \delta(\vec{r} - \vec{r}_l) Q_l , \tag{C4}$$

stating that the sum of all outgoing $E_{\vec{n}, \vec{n} + \hat{\eta}}$ flux lines [which generate $V(\vec{n})$] vanishes at all lattice sites \vec{n} except those \vec{r}_l with external color charges Q_l . (The Q_l are due to quarks. Up to $2N_f$ quarks and $2N_f$ antiquarks are allowed at each site by Fermi statistics.)

It is precisely via this Gauss condition that the specific (mesonic, baryonic *etc.*) sector becomes relevant. Figure 7 pertains to the $M_{u\bar{d}}$ sector. The simple configurations in Fig. 7 have just one u and one \bar{d} in the lattice. Eq. (C4) then simplifies into

$$\sum_{+\hat{\eta}} E_{\vec{n}, \vec{n} + \hat{\eta}} = \delta(\vec{r} - \vec{r}_u) \lambda + \delta(\vec{r} - \vec{r}_d) \lambda^\dagger , \tag{C5}$$

where $r_{u(\bar{d})}$ are the locations of $u(\bar{d})$, and λ, λ^\dagger are the corresponding color matrices.

Since H_{QCD} commutes with the gauge transformations, the evolution of the state on the lattice, allowing for creation of $q\bar{q}$ pairs at one lattice point and their subsequent separation and possible annihilation with other $q\bar{q}$, maintains the Gauss condition (C4) [though not, in general, its simple ‘‘valence’’ version (C5)]. Since the Gauss law constraints are common to all the mesonic sectors, they do not interfere with the suggested operator relation Eq. (5.2).

We start by showing that (5.2) is satisfied when we switch off the quark creation and annihilation terms and then work our way gradually to the general case.

1. In the simple case where $M_{i\bar{j}}$ consists of just the $q_i\bar{q}_j$ quarks and not other pairs, it is easy to see that all the non-mass terms in H_{QCD} have identical matrix elements in any H_{ij} sector. Also the Gauss law constraints are the same. The matrix elements depend only on the U 's and E 's and the generic quarks or antiquarks but not on the specific quark flavors. Taking for concreteness $ijkl = udsc$, we have flavor dependence only in the mass terms (ψ^C denotes a charge conjugated spinor of an antiquark):

$$H_{ud}^{\text{mass}} = m_u\psi^\dagger(\vec{r}_q)\gamma_0\psi(\vec{r}_q) + m_d(\psi^C)^\dagger(\vec{r}_{\bar{q}})\gamma_0\psi^C(\vec{r}_{\bar{q}}) \quad (\text{C6a})$$

$$H_{c\bar{s}}^{\text{mass}} = m_c\psi^\dagger(\vec{r}_q)\gamma_0\psi(\vec{r}_q) + m_s(\psi^C)^\dagger(\vec{r}_{\bar{q}})\gamma_0\psi^C(\vec{r}_{\bar{q}}) \quad (\text{C6b})$$

$$H_{u\bar{s}}^{\text{mass}} = m_u\psi^\dagger(\vec{r}_q)\gamma_0\psi(\vec{r}_q) + m_s(\psi^C)^\dagger(\vec{r}_{\bar{q}})\gamma_0\psi^C(\vec{r}_{\bar{q}}) \quad (\text{C6c})$$

$$H_{c\bar{d}}^{\text{mass}} = m_c\psi^\dagger(\vec{r}_q)\gamma_0\psi(\vec{r}_q) + m_d(\psi^C)^\dagger(\vec{r}_{\bar{q}})\gamma_0\psi^C(\vec{r}_{\bar{q}}). \quad (\text{C6d})$$

Since the same four terms appear in $H_{u\bar{d}} + H_{c\bar{s}}$ as in $H_{u\bar{s}} + H_{c\bar{d}}$, Eq. (5.2) is valid in this valence approximation:

$$H_{u\bar{s}} + H_{c\bar{d}} = H_{u\bar{d}} + H_{c\bar{s}} \quad (\text{subspace with two quarks}). \quad (\text{C7})$$

2. The above argument is not affected by the creation/annihilation terms of all pairs $x\bar{x} \neq u\bar{u}, d\bar{d}, s\bar{s}, c\bar{c}$. The created quarks or antiquarks cannot be Pauli blocked or annihilated by the valence quarks or antiquarks. Their effect, just like that of gauge fields, is common to $H_{u\bar{d}}, H_{c\bar{s}}$, etc.

3. Finally, we turn on also pair creation/annihilation of the valence flavors. We would then generate configurations such as $q_i^v(u_1\bar{u}_1) \dots (x_p\bar{x}_p)\bar{q}_j^v$ in which u_1 is at the same lattice site, and same spin and color state as the valence quark q_i^v . If $q_i^v = u$, such configurations should, by the Pauli principle, be disallowed. Also \bar{u}_1 could subsequently annihilate the valence quark. Both effects occur in $M_{u\bar{d}}$ and $M_{u\bar{s}}$ but not in $M_{c\bar{s}}$ and $M_{c\bar{d}}$. To avoid a possible difficulty in deriving Eq. (5.2) we will *define* the configuration corresponding to

$$u_v(u_1\bar{u}_1) \dots (x_p\bar{x}_p)\bar{d}_v \text{ in } M_{u\bar{d}} \text{ [or } u_v(u_1\bar{u}_1) \dots (x_p\bar{x}_p)\bar{s}_v \text{ in } M_{u\bar{s}}] \quad (\text{C8})$$

to be

$$c_v(c_1\bar{c}_1) \dots (x_p\bar{x}_p)\bar{d}_v \text{ in } M_{c\bar{d}} \text{ [or } c_v(c_1\bar{c}_1) \dots (x_p\bar{x}_p)\bar{s}_v \text{ in } M_{c\bar{s}}] . \quad (\text{C9})$$

This, rather than the definition with a common set of pairs, ensures that configurations excluded in $M_{u\bar{d}}$ or $M_{u\bar{s}}$ will be excluded in $M_{c\bar{d}}$ or $M_{c\bar{s}}$; and that for any subsequent $\bar{u}_1 u_v$ annihilation induced by $H_{u\bar{d}}$ or $H_{u\bar{s}}$ there will be a corresponding annihilation of $\bar{c}_1 c_v$ in $H_{c\bar{d}}$ or $H_{c\bar{s}}$. The diagonal mass terms which contributed to $H_{u\bar{d}} + H_{c\bar{s}}$ and $H_{c\bar{d}} + H_{u\bar{s}}$ in such configurations will still be the same. In each case we have $3m_u, 3m_c, m_d$ and m_s terms and a common set of non- $uscd$ quark masses due to other pair creation.

The construction of corresponding configurations is readily generalized to the case of arbitrary number of pairs with the flavors of the valence quark. A generic state in $M_{i\bar{j}}$ is

$$q_i(q_i^{(1)}\bar{q}_i^{(1)}) \dots (q_i^{(p_v)}\bar{q}_i^{(p_v)})(x\bar{x})^{n_x}(q_j^{(1)}\bar{q}_j^{(1)}) \dots (q_j^{(\bar{p}_v)}\bar{q}_j^{(\bar{p}_v)})\bar{q}_j. \quad (\text{C10})$$

The superscripts p_v, n_x, \dots simply count the number of pairs of type $(q_i\bar{q}_i), (x, \bar{x})$, etc. Altogether we have p_v pairs of the valence quark flavor, \bar{p}_v pairs of the valence antiquark flavor, and additional $x\bar{x}$ pairs. With the specific relation (5.2) in mind we will explicitly exhibit among those $x\bar{x}$ pairs the $(q_k\bar{q}_k)$ and $(q_l\bar{q}_l)$ pairs:

$$M_{i\bar{j}} = q_i(q_i\bar{q}_i)^{p_v}(q_j\bar{q}_j)^{\bar{p}_v}\bar{q}_j(q_k\bar{q}_k)^{p_1}(q_l\bar{q}_l)^{p_2}(x\bar{x})^{n_x} \dots \quad (\text{C11})$$

with $x \neq q_i, q_j, q_k, q_l$. The corresponding states in the other three mesonic sectors will be taken as

$$\begin{aligned} M_{k\bar{l}} &= q_k(q_k\bar{q}_k)^{p_v}(q_l\bar{q}_l)^{\bar{p}_v}\bar{q}_l(q_i\bar{q}_i)^{p_1}(q_j\bar{q}_j)^{p_2}(x\bar{x})^{n_x} \dots \\ M_{i\bar{l}} &= q_i(q_i\bar{q}_i)^{p_v}(q_l\bar{q}_l)^{\bar{p}_v}\bar{q}_l(q_k\bar{q}_k)^{p_1}(q_j\bar{q}_j)^{p_2}(x\bar{x})^{n_x} \dots \\ M_{k\bar{j}} &= q_k(q_k\bar{q}_k)^{p_v}(q_j\bar{q}_j)^{\bar{p}_v}\bar{q}_j(q_i\bar{q}_i)^{p_1}(q_l\bar{q}_l)^{p_2}(x\bar{x})^{n_x} \dots \end{aligned} \quad (\text{C12})$$

All of these configurations have the same total number of quarks and antiquarks: $N = 2 + 2p_v + 2\bar{p}_v + 2p_1 + 2p_2 + 2\sum_{x \neq ijk l} n_x$. Also the corresponding quarks (or antiquarks) in $M_{i\bar{j}}, M_{k\bar{l}}$, etc. are taken to be at the same locations with identical spinor and color states. The Gauss constraints, the antisymmetrization effects, and (except for mass contributions) also all matrix elements are the same for $H_{i\bar{j}}, H_{k\bar{l}}, H_{i\bar{l}}$ and $H_{k\bar{j}}$. Finally, we have in $H_{i\bar{j}} + H_{k\bar{l}}$ the same mass terms as in $H_{i\bar{l}} + H_{k\bar{j}}$. [Altogether there are $2p_1 + 2p_v + 1$ terms with m_i as a coefficient, the same number with coefficient m_k ; and $2p_2 + 2\bar{p}_v + 1$ terms with coefficients $m_j(m_l)$.] All of these terms make identical contributions to both sides of Eq. (5.2), which is therefore correct.

Viewing states with equal of numbers of (say) $c\bar{c}$ and $u\bar{u}$ pairs as “corresponding” states does *not* imply that heavy and low mass pairs occur with equal probability in physical states. This issue is determined by solving $H^{(ij)}|\Psi_{ij}\rangle = E^{(ij)}|\Psi_{ij}\rangle$ and heavy pairs are in fact strongly suppressed [218]. This is analagous to the relative separation $r_{q\bar{q}}$ in the example of Sec. 2, where $r_{c\bar{c}}$ and $r_{u\bar{u}}$ correspond to the same “generic” degree of freedom r . While solving the Schrödinger equations with $m_c \gg m_u$ leads to very different expectation values of r

$$\langle r \rangle_{J/\psi} \ll \langle r \rangle_{\omega} ,$$

the operator relation $H_{c\bar{c}} + H_{u\bar{u}} = 2H_{c\bar{u}}$ still holds for the nonrelativistic Hamiltonians.

APPENDIX D: ENUMERATION AND SPECIFICATION OF THE BARYON-MESON INEQUALITIES

Altogether we have forty two different flavor-spin baryonic “ground state” combinations consisting of $udscb$ quarks, when we do not distinguish between members of I -spin multiplets and assume no orbital, radial, or gluonic excitations. (Electromagnetic mass splittings were discussed in Sec. 12).

We consider first the $J^P = (3/2)^+$ “ Δ -like” baryons. In baryons made of three identical quarks bbb , ccc , sss (Ω^-), and $uuu = ddd$ (Δ^{++}, Δ^-), each diquark combination is in a spin triplet with $J^P = (3/2)^+$. Also, in all other $(3/2)^+$ states all quark pair subsystems, and hence the corresponding mesonic systems $q_i q_j (\rightarrow q_i \bar{q}_j), q_j q_k (\rightarrow q_j \bar{q}_k), q_k q_i (\rightarrow q_k \bar{q}_i)$, must be in the triplet, $S = 1$ state. Hence only vector meson masses appear on the right hand side of the inequalities. If we list all mesons in lexicographic order with $b > c > s > u, d$, we have the following $(3/2)^+$ states: uuu (Δ), suu (Σ^*), ssu (Ξ^*), sss (Ω^-), cuu (Σ_c^*), csu (Ξ_c^*), css (Ω_c^*); the doubly charmed baryons ccu and ccs ; the ccc state; and buu (Σ_b^*), bsu (Ξ_b^*), and bss (Ω_b^*). There are also the heavier states bcc , bbu , bbs , bbc , and finally bbb , which are unlikely to be discovered soon.

For the sake of completeness, we list in Table II all the relevant inequalities. The first five can already be tested and are satisfied with a reasonable margin in all cases. The next eight inequalities constitute lower bounds predicted for as yet undiscovered baryonic states, which hopefully can be verified in the near future. The remaining three will presumably be verified only in the distant future.

We move next to the $J^P = (1/2)^+$ baryons. Let us first focus on the case where we have two identical quarks, namely duu (p), suu (or sud with $I = 1$) (Σ^+), ssu (Ξ^-), cuu (Σ_c^{++}), css (Ξ_c), ccu , ccs , buu , bss , and bcc . In all these “ yx_1x_2 - type” states the identical flavor quarks x_1x_2 must be in a triplet state, namely

$$(\vec{s}_{x_1} + \vec{s}_{x_2})^2 = s_{x_1x_2}^2 = 1 \cdot (1 + 1) = 2. \quad (D1)$$

Writing next the total baryon spin as

$$(\vec{s}_{x_1} + \vec{s}_{x_2} + \vec{s}_y)^2 = (s_{x_1} + s_{x_2})^2 + 2\vec{s}_{x_1} \cdot \vec{s}_y + 2\vec{s}_{x_2} \cdot \vec{s}_y + (s_y)^2 = s_B^2 \quad (D2a)$$

or, using Eq. (D1) and $s_B = 1/2$:

$$2 + 2(\vec{s}_{x_1} \cdot \vec{s}_y + \vec{s}_{x_2} \cdot \vec{s}_y) + 3/4 = 3/4, \quad (D2b)$$

i.e.

$$\langle \vec{s}_{x_1} \cdot \vec{s}_y \rangle_B + \langle \vec{s}_{x_2} \cdot \vec{s}_y \rangle_B = -1, \quad (D2c)$$

with $\langle \rangle_B$ denoting the expectation value in the baryon state. Since we have $x_1 \leftrightarrow x_2$ symmetry of the above expectation values, we finally conclude that

$$\langle \vec{s}_{x_1} \cdot \vec{s}_y \rangle_B = \langle \vec{s}_{x_2} \cdot \vec{s}_y \rangle_B = -1/2. \quad (D3)$$

Hence each of the yx_i ($\rightarrow y\bar{x}_i$) subsystems must be a mixture of 3/4 singlet and 1/4 triplet states for which $\langle \vec{s} \cdot \vec{s} \rangle = -3/4$ and $+1/4$, respectively. This then implies, by collecting all the terms in $(x_1\bar{x}_2), (y\bar{x}_1), (x_2\bar{y})$, that the baryon-meson inequalities read as follows:

$$\begin{aligned} m_n &\geq \frac{m_\rho}{2} + \frac{1}{4}(3m_\pi + m_\rho) = \frac{3}{4}(m_\rho + m_\pi) \\ m_\Sigma &\geq \frac{m_\rho}{2} + \frac{1}{4}(3m_K + m_{K^*}) \\ m_\Xi &\geq \frac{m_\phi}{2} + \frac{1}{4}(3m_K + m_{K^*}) \\ m_{\Sigma_c} &\geq \frac{m_\rho}{2} + \frac{1}{4}(3m_D + m_{D^*}) \\ m_{\Sigma_b} &\geq \frac{m_\rho}{2} + \frac{1}{4}(3m_B + m_{B^*}). \end{aligned} \quad (D4)$$

We have similar relations for the doubly strange baryons:

$$\begin{aligned} m_{\Xi_c} &= m_{css}(1/2)^+ \geq \frac{m_\rho}{2} + \frac{1}{4}(3m_{D_s} + m_{D_s^*}) \\ m_{\Xi_b} &= m_{bss}(1/2)^+ \geq \frac{m_\rho}{2} + \frac{1}{4}(3m_{B_s} + m_{B_s^*}), \end{aligned} \quad (\text{D5})$$

and the doubly charmed baryons (hopefully to soon be found in FNAL experiments):

$$\begin{aligned} m_{ccu}(1/2)^+ &\geq \frac{m_{J/\psi}}{2} + \frac{1}{4}(3m_D + m_{D^*}) \\ m_{ccs}(1/2)^+ &\geq \frac{m_{J/\psi}}{2} + \frac{1}{4}(3m_{D_s} + m_{D_s^*}). \end{aligned} \quad (\text{D6})$$

The specific numerical values for all of the above and a few other x_1x_2y states are listed in Table II.

Among the remaining $(1/2)^+$ baryonic states composed of three different quark flavors, we have three “ Λ -type” states in which the light quark ud subsystem coupled to $I = 0$ (and hence to $s_{ud} = I_{ud} = 0$). The “ Σ -type” states with $I_{ud} = 1$ have already been discussed above. The “ Λ -type” states are

$$s \underbrace{ud}_{I=0, s=0} = \Lambda \quad c \underbrace{ud}_{I=0, s=0} = \Lambda_c \quad b \underbrace{ud}_{I=0, s=0} = \Lambda_b. \quad (\text{D7})$$

Using

$$(\vec{s}_{ud}) \equiv (\vec{s}_u + \vec{s}_d)^2 = 0$$

and

$$(\vec{s}_\Lambda) \equiv (\vec{s}_x + \vec{s}_{ud})^2 = 3/4,$$

we can now deduce, using also $u \leftrightarrow d$ exchange symmetry, that

$$\langle \vec{s}_x \cdot \vec{s}_u \rangle = \langle \vec{s}_x \cdot \vec{s}_d \rangle = 0. \quad (\text{D8})$$

Equation (D8) implies that in each $xu (\rightarrow x\bar{u})$ and $xd (\rightarrow x\bar{d})$ subsystem we have the opposite triplet-singlet mixture as in the previous case of Eq. (D3), namely 1/4 singlet and 3/4 triplet. Thus collecting these and the term corresponding to the singlet $ud \rightarrow u\bar{d} (\approx \pi)$ subsystems, we finally have:

$$\begin{aligned} m_\Lambda &\geq \frac{m_\pi}{2} + \frac{1}{4}(3m_K + m_{K^*}) \\ m_{\Lambda_c} &\geq \frac{m_\pi}{2} + \frac{1}{4}(3m_D + m_{D^*}) \\ m_{\Lambda_b} &\geq \frac{m_\pi}{2} + \frac{1}{4}(3m_B + m_{B^*}). \end{aligned} \quad (\text{D9})$$

The remaining baryonic states which consist of three different flavor quarks csu , bsu , bcu , and bcs are either of the “ Λ -type” in which the lighter two quarks couple to $S = 0$ subsystems, or of the “ Σ -type” in which the lighter two quarks couple to $S = 1$. Because the hyperfine interaction [$\propto (\vec{s}_i \cdot \vec{s}_j)/(m_i m_j)$] is bigger for the lighter quark system we expect that the Λ -type states will be lighter than the corresponding Σ -type states. This will be particularly so for the su subsystem in csu or bsu , which have been observed or are likely to be observed soon, than the bcu and bcs states. When we specify the spin q of the su subsystem to be $s_{q_1 q_2} = 1$ (or $s_{q_1 q_2} = 0$), and follow the previous discussion, we conclude that, for csu for example:

$$\langle \vec{s}_c \cdot \vec{s}_u \rangle + \langle \vec{s}_c \cdot \vec{s}_s \rangle = -1 \quad (\text{for } s_{ud} = 1) \quad (\text{D10a})$$

or

$$\langle \vec{s}_c \cdot \vec{s}_u \rangle + \langle \vec{s}_c \cdot \vec{s}_s \rangle = 0 \quad (\text{for } s_{ud} = 0). \quad (\text{D10b})$$

However, unlike in the previous cases, we cannot deduce that $\langle \vec{s}_Q \cdot \vec{s}_u \rangle_B = \langle \vec{s}_Q \cdot \vec{s}_d \rangle_B$ without appealing to the approximate Gell-Mann – Ne’eman $SU(3)$ $u \leftrightarrow s$ symmetry. If we do this nonetheless, as a first approximation, we obtain

$$m_{cus}(\Lambda) \geq \frac{m_K}{2} + \frac{1}{4} \left[\frac{(m_{D_s} + m_D)}{2} + \frac{3(m_{D_s^*} + m_{D^*})}{2} \right] \quad (\text{D11a})$$

$$m_{cus}(\Sigma) \geq \frac{m_K^*}{2} + \frac{1}{4} \left[\frac{(m_{D_s^*} + m_{D^*})}{2} + \frac{3(m_{D_s} + m_D)}{2} \right]. \quad (\text{D11b})$$

In the real case, we expect the spin-averaged variant, consisting of the symmetric combination of Eqs. (D11a) and (D11b) (this is the value we list in Table II, with the left hand side called m_{cus}):

$$\frac{1}{2} [m_{cus}(\Lambda) + m_{cus}(\Sigma)] \geq \frac{(m_K + m_{K^*})}{4} + \frac{(m_D + m_{D^*})}{4} + \frac{(m_{D_s} + m_{D_s^*})}{4}, \quad (\text{D12})$$

and in general we expect that the right hand sides of (D11a) and (D11b) to be respectively an over- (under-) estimate of the combined mesonic masses. Specifically, we expect that Eqs. (D11a) and (D11b) to be satisfied with a somewhat smaller (larger) than usual margin. The difference between the right hand side in Eq. (D11a) and Eq. (D11b) is

$$\frac{(m_{K^*} - m_K)}{2} + \frac{1}{2} \left[\frac{(m_D - m_{D^*})}{2} + \frac{(m_{D_s} - m_{D_s^*})}{2} \right] \approx 130 \text{MeV}. \quad (\text{D13})$$

We will not pursue this issue further here.

APPENDIX E: APPLICATION TO QUADRONIUM

It has been suggested that the puzzling narrow resonance found in heavy ion collisions is in some sense an $e^+e^-e^+e^-$ bound state [219]. The need to achieve very strong bindings ($\text{BE} \simeq m_e \simeq 0.5 \text{ MeV}$) in this normally weakly (electromagnetically) coupled system is a serious problem of the quadronium hypothesis. While the experimental motivations are questioned, we find that there is a nice, simple, application of the variational technique [220]. It has been suggested that we cannot really have a two-body dominated interaction in this system, and that new, unusual, four-body interactions are called for.

The following inequality on the binding energy of quadronium in terms of the binding of positronium serves to sharpen the issue. Let $\psi_Q = \psi^0(1\bar{1}2\bar{2})$ be the wave function of quadronium in its ground state. The Hamiltonian is

$$H_Q = T_1 + T_{\bar{1}} + T_2 + T_{\bar{2}} + V_{1\bar{1}} + V_{1\bar{2}} + V_{2\bar{1}} + V_{2\bar{2}} + V_{12} + V_{\bar{1}\bar{2}}. \quad (\text{E1})$$

Clearly we expect the repulsive electron-electron (V_{12}) and positron-positron ($V_{\bar{1}\bar{2}}$) interactions to lower the quadronium binding. Hence

$$\epsilon_B^0(Q) \leq \tilde{\epsilon}_B^0(Q), \quad (\text{E2})$$

with $\tilde{\epsilon}_B^0(Q)$ the binding of a fictitious Hamiltonian \tilde{H}_Q , which is the original H_Q with these repulsive interactions eliminated:

$$\tilde{H}_Q = T_1 + T_{\bar{1}} + T_2 + T_{\bar{2}} + V_{1\bar{1}} + V_{1\bar{2}} + V_{2\bar{1}} + V_{2\bar{2}}. \quad (\text{E3})$$

If we compare \tilde{H}_Q with the two-body Hamiltonians,

$$\begin{aligned} H_{1\bar{1}} &= T_1 + T_{\bar{1}} + V_{1\bar{1}}, & H_{1\bar{2}} &= T_1 + T_{\bar{2}} + V_{1\bar{2}} \\ H_{2\bar{1}} &= T_2 + T_{\bar{1}} + V_{2\bar{1}}, & H_{2\bar{2}} &= T_2 + T_{\bar{2}} + V_{2\bar{2}} \end{aligned}$$

we see that

$$2\tilde{H}_Q = H'_{1\bar{1}} + H'_{1\bar{2}} + H'_{2\bar{1}} + H'_{2\bar{2}}, \quad (\text{E4})$$

where $H'_{1\bar{1}}$ is obtained from $H_{1\bar{1}}$ by doubling the interaction: $H'_{1\bar{1}} = T_1 + T_{\bar{1}} + 2V_{1\bar{1}}$, *etc.* This can be achieved for the one-photon exchange by doubling the effective coupling strength $\alpha \rightarrow \alpha' = 2\alpha$. Equation (E4) can next be used in the by now familiar way to put an upper bound on $\tilde{\epsilon}_B^0(Q)$, and thus, via Eq. (E2), on $\epsilon_B^0(Q)$ as well. The bound is

$$\epsilon_B^0(Q) \leq 2\epsilon_B^0(P),$$

with $\epsilon_B^{\prime 0}(P)$ the binding of positronium in which the strength of the interaction has been doubled by $\alpha \rightarrow 2\alpha$. Thus we have

$$\epsilon_B^0(Q) \leq \tilde{\epsilon}_B^0(Q) \leq 2\epsilon_B^{\prime 0}(P). \quad (\text{E5})$$

The fact that the real positronium spectrum conforms so nicely to QED predictions with radiative corrections included strongly suggests that if $\alpha = 1/137$ is scaled up to $\alpha' = 2/237$ we can still treat the $e^+e^-e^+e^-$ system with the perturbatively calculated potential. In this case

$$\epsilon_B^{\prime 0}(P) \simeq (\alpha')^2 \frac{m}{4} = 2\alpha^2 \frac{m}{2} = 2\text{Ry} = 27\text{ eV},$$

and hence $\epsilon_B^0(Q) \leq 2\epsilon_B^{\prime 0}(P) \leq 54\text{ eV}$, and the binding falls short by about 10^4 of the required 0.5 MeV binding.

APPENDIX F: QCD INEQUALITIES FOR EXOTIC NOVEL HADRON STATES

Most known hadrons are $q_i\bar{q}_j$ mesons and $q_iq_jq_k$ baryons. We will refer to (non-gluon) states belonging to neither of the above two categories as “exotic”. Such states have been searched for and discussed for more than 30 years. “Duality” arguments predating QCD [60] suggested “ $q\bar{q}q\bar{q}$ ” states coupling mainly to baryon-antibaryon as the most likely exotic states. Within QCD hybrids ($q\bar{q} + \text{gluon}$) arise naturally [221]. Also $q\bar{q}s\bar{s}$ “bag states” were suggested as candidates for the f_0 and $K\bar{K}$ threshold states [222–224]. Considerations of hyperfine chromomagnetic interactions,

$$V_{HF} \approx \sum_{ij} \frac{(\vec{\sigma}_i \cdot \vec{\sigma}_j)(\vec{\lambda}_i \cdot \vec{\lambda}_j)}{m_i m_j} V(r_{ij}),$$

generated via one gluon exchange between the quarks q_i and q_j suggested a particular “hexaquark” $\mathcal{H} = uuddss$ [222] below the $\Lambda\Lambda$ threshold which could be strong interaction stable.³⁰ More recently similar considerations [227,228] singled out the specific “pentaquark” $\mathcal{P} = \bar{c}suud$ as a more likely strong interaction stable, new, exotic, bound state. Both states have been experimentally searched for with inconclusive results [229–231] in almost all cases.

The exotic states can be separated into disjoint color singlet hadrons.³¹ Indeed we have seen in Sec. 16 that for degenerate quark flavors (and most likely in other cases as well) there is an attractive interaction in the $q_i\bar{q}_j q_k\bar{q}_l$ channels. The question of whether these residual color forces between color singlet states can lead to weakly bound states, in analogy to the nuclear forces in the deuteron and other nuclei, is of some interest. However we believe that it is a detailed, delicate, issue that QCD inequalities cannot decide (much in the same way that the deuteron’s binding requires detailed calculation).

Here we would like to focus on the question whether genuine multiquark states – referred to in the literature qualitatively as “single bag states” – which have significantly higher than nuclear bindings, exist. The arguments for bound hexa- and pentaquark states utilized the *ad hoc* assumption that in all multiquark hadronic states the quarks are in the same “universal” bag as the baryons and mesons, and have the same hyperfine interactions. Here we will utilize the complementary, strong coupling picture, where the quarks in the exotic states are connected via electric flux lines into a more complex color network than the $q\bar{q}$ for mesons or the “Y” topology with one junction point for the baryons.

Let us first focus on quadriquarks. In the limit when two quarks (or antiquarks) are heavy, one can show directly that a novel pattern of an overall singlet system which cannot be broken into color singlet clusters will form [232]. In a $q_i q_j \bar{Q}_k \bar{Q}_l$ state, the two heavy quarks always bind coulombically into a color triplet $(\bar{Q}_k \bar{Q}_l)_3$ diquark with binding and size proportional to m_Q and m_Q^{-1} , respectively. The small $(\bar{Q}_k \bar{Q}_l)_3$ subsystem acts effectively as a heavy quark. Together with the light $q_i q_j$ it will then form, as a Λ_Q analog, the $q_i q_j \bar{Q}_k \bar{Q}_l$ quadriquark. Because of the small numerical coefficient in the coulombic energy, $E_B = \frac{1}{2} \left(\frac{\alpha_S}{2}\right)^2 \frac{m_Q}{2}$, the latter does not exceed $\Lambda_{\text{QCD}} \simeq 0.2\text{ GeV}$ even for $m_Q = m_B \simeq 5\text{ GeV}$. Hence the question of the stability of the novel pattern of color coupling – which in a strong coupling chromoelectric flux tube picture corresponds to the connected color network illustrated in Fig. 18 – remains open.

³⁰The existence of a $\Lambda\Lambda$ bound state could encourage the further conjecture [225,226] that higher $\Lambda^N = u^N d^N s^N$ “strangelets” exist and that at large densities strange quark matter is the most stable, which if true has fascinating astrophysical ramifications.

³¹With the exception of genuine “quantum number exotics”, for example 0^\pm or 1^\pm states that cannot decay into mesons.

In the following we would like to use QCD variational inequalities to address this problem. This we do by following the derivation in the same strong coupling, flux tube approximation as the baryon-meson mass inequalities in Sec. 6 above. Thus, let us take for the quadriquark wave functional:

$$|\Psi_{qq'\bar{Q}\bar{Q}'}\rangle = \sum_{\boxtimes} A_{\boxtimes} |\boxtimes\rangle, \quad (\text{F1})$$

with the possible generalizations maintaining the two junction points (1) and (2) (see the discussion in Sec. 6). We have used \boxtimes to symbolize the graph of Fig. 18. As indicated in Fig. 19 we can extract from $|\Psi_{qq'\bar{Q}\bar{Q}'}\rangle$ – and the wave functional of an anti-quadrquark superposed on it with flux lines reversed – trial wave functionals for the four mesons $Q\bar{Q}'$, $Q\bar{q}'$, $Q\bar{q}$, and $q\bar{q}'$. In the above Hilbert space, we then have the operator relation

$$2H_{QQ'\bar{q}\bar{q}'} = H_{Q\bar{Q}'} + H_{Q\bar{q}'} + H_{q\bar{q}'} + H_{q'\bar{Q}'}, \quad (\text{F2})$$

from which we obtain, via the variational principle, the mass inequality

$$2m_{QQ'\bar{q}\bar{q}'}^{(0)} \geq m_{Q\bar{Q}'}^{(0)} + m_{Q\bar{q}'}^{(0)} + m_{q\bar{q}'}^{(0)} + m_{q'\bar{Q}'}^{(0)}. \quad (\text{F3})$$

For the case $Q, Q' = c, qq' = u, d$, this binds from below the (hypothetical) quadronium mass by the known charmonium, charmed meson, and light meson masses. Specifically for $cc\bar{u}\bar{u}$ (or $cc\bar{d}\bar{d}$), the inequality reads:

$$m_{cc\bar{u}\bar{u}}^{(0)} \geq \frac{1}{2} [m_{J/\psi} + m_\rho + (1 + \alpha)m_{D^*} + (1 - \alpha)m_D], \quad (\text{F4})$$

where $m_{c\bar{c}} = m_{J/\psi}$ and $m_{u\bar{u}} = m_\rho$ follows from the generalized Pauli principle as discussed previously.³² The weights of the D and D^* depend on the total spin of the $cc\bar{u}\bar{u}$ system (see App. D). For example, consider $J^P = 1^+$ quantum numbers. In this case the transition quadriquark $\rightarrow DD$ is forbidden since the two D mesons can couple only to $0^+, 1^-, 2^+$ *etc.* The lowest state available for decay is then DD^* . Performing a calculation similar to those in App. D we find that $\alpha = 0$ is the correct weight and the inequality reads

$$\begin{aligned} m_{cc\bar{u}\bar{u}}^{(0)}(1^+) &\geq \frac{1}{2} (m_{J/\psi} + m_\rho + m_{D^*} + m_D) \\ m_{cc\bar{u}\bar{u}}^{(0)}(1^+) &\geq 3870.7 \text{ MeV} \approx m_{D^*} + m_D. \end{aligned} \quad (\text{F5})$$

Our previous comparisons of many baryon-meson inequalities with data indicate that these inequalities are satisfied with a margin of 150-300 MeV. Cohen and Lipkin [37] and Imbo [38] suggest heuristic arguments for this margin. Such a margin should *a fortiori* be valid for the quadriquark inequalities.³³ Thus we expect that the $cc\bar{u}\bar{u}$ state actually lies well above the D^*D threshold and therefore is unstable. The situation is very different for $cc\bar{u}\bar{d}$. In this case we could choose $u\bar{d}$ to be in the spin singlet state. This is consistent with the cc spin triplet diquark and the $\bar{u}\bar{d}$ spin singlet anti-diquark, with relative zero orbital angular momenta, adding up to an overall $J^P = 1^+$. The analog of Eq. (F5) is then

$$\begin{aligned} m_{cc\bar{u}\bar{d}}^{(0)}(1^+) &\geq \frac{1}{2} \left(m_{J/\psi} + m_\pi + \frac{3}{2}m_{D^*} + \frac{1}{2}m_D \right) \\ m_{cc\bar{u}\bar{d}}^{(0)}(1^+) &\geq 3590.6 \text{ MeV} \approx m_{D^*} + m_D - 300 \text{ MeV}, \end{aligned} \quad (\text{F6})$$

A bound $ccud(1^+)$ state with $m_{cc\bar{u}\bar{d}}^{(0)} \leq m_D + m_{D^*}$ would satisfy the inequality with a margin of approximately 300 MeV, and is therefore quite likely.

The analogs in the $Q = b$ system

$$\begin{aligned} m_{bb\bar{u}\bar{u}}^{(0)}(1^+) &\geq \frac{1}{2} (m_\Upsilon + m_\rho + m_{B^*} + m_B) \\ m_{bb\bar{u}\bar{u}}^{(0)}(1^+) &\geq 10416.3 \text{ MeV}, \end{aligned} \quad (\text{F7})$$

³²The identical uu or cc quarks are in the lowest $L = 0$ state, and hence the $u\bar{u}$ or $c\bar{c}$ in the corresponding meson should be in the triplet state.

³³Here we have for some of the $Q\bar{q}$ mesons *worse* trial wave functionals as compared with those extracted from baryons, namely mesonic strings consisting of three segments going through the two junction points.

and

$$\begin{aligned}
m_{bb\bar{u}\bar{d}}^{(0)}(1^+) &\geq \frac{1}{2} \left(m_\Upsilon + m_\pi + \frac{3}{2}m_{B^*} + \frac{1}{2}m_B \right) \\
m_{bb\bar{u}\bar{d}}^{(0)}(1^+) &\geq 10113.3 \text{ MeV}
\end{aligned} \tag{F8}$$

allow bindings in both flavor combinations, though again with a considerably higher safety margin in the $bb\bar{u}\bar{d}$ case.

In baryons each quark pair must couple to a $\bar{3}$. In the $QQ'qq'$ system the QQ' and qq' could also couple to a color sextet. Thus the segment connecting the junction points (1) and (2) in Fig. 18 would then carry a sextet flux – a possibility that our discussion above neglected. This is justified in the strong coupling limit. The potential energy $g^2 \int d^3x E^2$ then dominates, and the quadratic Casimir operator (to which $\int E^2$ is proportional) of the sextet is 10/3 times larger than that of $\bar{3}$. Nonetheless, the need to exclude the sextet flux, and the *related* fact that there is no alternative derivation in the weak coupling, one gluon exchange limit, puts the present inequalities on a weaker footing than that of the baryon-meson mass inequalities. We believe however the enhanced likelihood for a $cc\bar{u}\bar{d}$ quadriquark state suggested by the inequalities.

It is amusing to note that an alternative, purely hadronic approach to the problem of a bound DD^* state also suggests that D^0D^* (of a $cc\bar{u}\bar{d}$ composition) is more likely to be bound than D^0D^{0*} . Thus following Tornqvist [233] (who coined the name “deusons” for these deuteron-like extended mesonic states), let us consider the one pion exchange interaction in the D^*D channel. The resulting Yukawa force has, due to the $D\pi$ threshold – D^* proximity (*i.e.* $m_{D^*} - m_D - m_\pi \equiv \epsilon \ll m_\pi$), an anomalously large range $\simeq 1/\sqrt{2\epsilon m_\pi} \simeq 3 - 7 \text{ fm}^{34}$, and could generate a D^*D bound state. However, because of simple I -spin Clebsch-Gordan coefficients, the potential generated by the π^+ exchange in the $D^{*+}D^0 \leftrightarrow D^{*0}D^+$ system is *twice* as strong as that due to the π^0 exchange in the $D^{*0}D^0 \leftrightarrow D^{*0}D^0$ system, and a $D^{*+}D^0$ bound state is more likely.

Let us next consider pentaquarks in the same strong coupling flux string approximation. The corresponding novel connected color network is illustrated in Fig. 20. This “network” contains three junction points. At point (1), two light quark fluxes are coupled to a $\bar{3}$ flux, and at point (2) the same holds for the fluxes emanating from the other two light quarks. Finally at the third “anti-junction” point the three $\bar{3}$ fluxes originating from points (1), (2), and from the heavy antiquark \bar{Q} , couple to a singlet. As in the case of the quadriquark we could have coupled the fluxons in *either* the first vertex (1) or the second vertex (2) to a color sextet flux, which again is neglected in the strong coupling limit. For pentaquarks, we furthermore have an alternative (similar) network obtained by exchanging one of the u quarks from the uu in vertex (1) with the d quark in vertex (2) – which represents a different, though not necessarily orthogonal, color coupling configuration. By reversing the flux lines on the segments (2)- d and (3)- \bar{Q} indicated by the double arrows in Fig. 20, and ignoring the intermediate fluxon between (2) and (3), we can extract from a “stringy” pentaquark wave functional trial wave functionals for a charmed baryon (cuu in this specific case) and an $s\bar{d}$ meson.

The full Hamiltonian for the quark and fluxon system is

$$H = \sum_{\text{quark}} H_{D_i} + \sum_{\text{flux segment}} \int [(\vec{E})^2 + (\vec{B})^2] , \tag{F9}$$

where H_{D_i} are the Dirac Hamiltonians for the quark, $(\vec{E})^2$ represents the “potential energy” density for the fluxons, and $(\vec{B})^2$ plays the role of kinetic energy for moving and distorting the string segments and the ∇_i in H_{D_i} “moves” the tip quarks.

Omitting (the generally positive contribution of) the (2)-(3) flux segment will only reduce the energy. This and the fact that the trial configurations of the baryons and mesons thus extracted do not optimize the wave functionals of the meson and baryon at rest, strongly suggest the inequality

$$m_{\mathcal{P}} \geq m_{s\bar{d}} + m_{cuu} . \tag{F10}$$

Because of the Pauli principle the two u quarks in cuu which are color antisymmetric and flavor symmetric must be spin symmetric and hence couple to $S_{uu} = 1$. Since these subconfigurations originate from the specific pentaquark state for which the four light quarks’ spin has to add to a total spin $S = 0$, we must also have $S_{s\bar{d}} = 1$. This means that we have to identify the $s\bar{d}$ meson with K^* (980) and the baryon with Σ_c (2445) with a total mass of $m_{\Sigma_c} + m_{K^*} = 3334 \text{ MeV}$, which is way above the threshold at 2906.8 MeV. In general, however, the pentaquark state

³⁴Because of the P-wave $D^* \rightarrow D\pi$ vertex this is compensated by a reduced effective coupling.

consists of a superposition of various flavor assignments at the tips of the same color network. The right-hand side of Eq. (F10) should therefore contain, in general, some weighted average so that

$$m_{\mathcal{P}} \geq \alpha \left[m_{s\bar{d}(S=1)} + m_{ccu(S=1)} \right] + \beta \left[m_{s\bar{u}} + m_{cud} \right] + \gamma \left[m_{u\bar{d}} + m_{csu} \right] + \delta \left[m_{u\bar{u}(S=1)} + m_{csd(S=1)} \right], \quad (\text{F11})$$

with $\alpha + \beta + \gamma + \delta = 1$ and $\alpha, \beta, \gamma, \delta \geq 0$. The spins in the last configuration are fixed by the same consideration as those used in the case of $s\bar{d} - cuu$ separation discussed above. The corresponding total mass

$$m_{\rho} + m_{\Xi_c} = 3221.3 \text{ MeV}$$

is 315 MeV above the $D_s - p$ threshold. In the other two configurations we will have in general admixtures of the lighter pseudoscalar π and K states, and of the lighter Λ_c baryon. The lightest combination is

$$m_{\pi} + m_{\Xi_c} = 2605.2 \text{ MeV}.$$

(The other alternative including the kaon,

$$m_K + m_{\Lambda_c} = 2778.6 \text{ MeV}$$

is only 128 MeV below threshold.)

We need an unlikely large admixture of the particular $\pi + \Xi_c$ configuration to bring the right-hand side of Eq. (F11) below 2906.8 MeV, the $D_s - p$ threshold. The baryon-meson inequalities are generally satisfied with a substantial margin of $\simeq 150$ MeV. If this is also the case for the relation in Eq. (F11), then it appears that the present inequalities cannot allow for a stable pentaquark bound state.

It should be emphasized that the present approach, assuming that confinement via the specific mechanism of color flux tubes (or strings) is the dominant aspect, is practically orthogonal to the one-gluon exchange potential approach. Indeed in the latter, confinement is assumed from the outset by simply postulating that all the quarks in penta- and hexaquark states are inside the same universal bag. Yet confinement forces play a minimal role in the pentaquark binding. Rather, the overriding consideration is to maximize the overall hyperfine interaction even if that involves having large components of the wave function with qq pairs in a color sextet state. It is therefore logically consistent that the inequalities derived in the framework of one approach conflict with a prediction of a bound pentaquark in another framework.

Nonetheless, the inequalities do suggest that if the pentaquark is not found, then neither QCD nor the naive quark models which so nicely explain the baryonic and mesonic spectra are at fault, but rather a lack of proper treatment of the basic confinement mechanism as adapted for these circumstances of pentaquark and/or hexaquark configurations.

One other class of exotics are hybrid states containing an extra gluon such as $(\bar{\psi}_i \psi_j)_8 G$ and $(\psi_i \psi_j \psi_k)_8 G$. The $(\dots)_8$ notation indicates that the quarks in the hadron couple to a color octet, which then forms the color singlet hadron with an additional gluon. To probe this sector, we should consider correlators of the form:

$$H(x, 0) = \left\langle 0 \left| \left[\psi_i^a(x) \bar{\psi}_j^b(x) \lambda_{ab}^r G_r(x) \right]^\dagger \left[\psi_i^{a'}(0) \bar{\psi}_j^{b'}(0) \lambda_{a'b'}^{r'} G_{r'}(0) \right] \right| 0 \right\rangle. \quad (\text{F12})$$

If we represent the gluons via a field strength, then $H(x, 0)$ can be written schematically as

$$H(x, 0) = \int d\mu(A) F_{\mu\nu}(x) F_{\mu\nu}(0) S_A^i(x, 0) S_A^j(x, 0), \quad (\text{F13})$$

and hence a Schwartz-type inequality implies

$$|H|^2 \leq \int d\mu(A) F_{\mu\nu}^2(x) F_{\mu\nu}^2(0) \int d\mu(A) S_A^i(x, 0)^\dagger S_A^i(x, 0) \int d\mu(A) S_A^j(x, 0)^\dagger S_A^j(x, 0). \quad (\text{F14})$$

This would imply, *if* the difficulty with the vacuum expectation value $\langle 0 | F^2 | 0 \rangle$ could somehow be surmounted, that

$$m_{\text{hybrid}} \leq \frac{1}{2} (m_{\text{glueball}} + m_{\pi}) \simeq 0.8 \text{ GeV}, \quad (\text{F15})$$

which is a rather weak bound, from a phenomenological point of view.

A similar inequality in the context of SUSY models (in the $m_{\text{squark}} \rightarrow \infty$ limit)³⁵ has proven useful in assessing the symmetry (phase) structure of that theory. Specifically, the possibility that massless, singlet, fermionic composites of $q_i \bar{q}_j$ and a gluino may manifest unbroken chiral symmetries, has been ruled out. This was done by proving a QCD inequality between the mass of this state (the “hybridino”) and the mass of the pion [121]:

$$\left[m_{\text{hybrid}} = m^{(0)}(q_i \bar{q}_j \tilde{g}) \right] \geq \left[m_{q_i \bar{q}_j}^{(0^-)} = m_\pi \right]. \quad (\text{F16})$$

Since unlike for gluons with nonlinear self-couplings one can define here the gluino propagator, the derivation of the last inequalities along lines paralleling those of Weingarten’s in deriving $m_N \geq m_\pi$ (see Sec. 10), is fairly straightforward.

The hybridino-hybridino correlator (written in a concise, index-free form) can be bound by Schwartz inequalities:

$$\begin{aligned} \langle J_{\text{hyb}}^\dagger(x) J_{\text{hyb}}(0) \rangle &= \int d\mu S_\psi S_{\bar{\psi}} S_\lambda \\ &\leq \int d\mu (|S_\psi|^2)^{1/2} (|S_{\bar{\psi}}|^2)^{1/2} (|S_\lambda|^2)^{1/2} \\ &\leq \left(\int d\mu |S_\psi|^2 \right)^{1/2} \left(\int d\mu |S_{\bar{\psi}}|^2 |S_\lambda|^2 \right)^{1/2} \\ &\leq \left(\int d\mu |S_\psi|^2 \right)^{1/2} \left(\int d\mu |S_{\bar{\psi}}|^2 \right)^{1/2} \left(\int d\mu |S_\lambda|^2 \right)^{1/2}. \end{aligned} \quad (\text{F17})$$

The first and second factors in the last expression are the square root of a pion propagator. Hence

$$\langle J_{\text{hyb}}^\dagger(x) J_{\text{hyb}}(0) \rangle \leq e^{-m_\pi |x|}, \quad (\text{F18})$$

and Eq. (F16) follows.

APPENDIX G: QCD INEQUALITIES BETWEEN EM CORRECTIONS TO NUCLEAR SCATTERING

In this Appendix we combine the results of Sec. 12 on the essentially positive nature of the EM contribution to the energies, and the approach of Sec. 16, in order to apply “electromagnetic QCD inequalities” to scattering states. To this end we first elaborate on some of the material of Sec. 16.

We have seen in Sec. 16 that QCD arguments leading to relations of the form

$$B(aa) + B(bb) \leq 2B(ab) \quad (\text{G1})$$

between binding in channels (aa) , (bb) , and (ab) are useful even if there are no bound states in those channels. Thus, imagine that the relative coordinate $\vec{r} = \vec{r}_1 - \vec{r}_2$ of the particle pair is confined to a sphere $|\vec{r}| \leq R$, with R an infrared cutoff larger than the relevant scales in the problem. Let $\epsilon_{n,l}^0$ and $\epsilon_{n,l}$ denote the levels in various l channels without and with (respectively) the interparticle interactions turned on. Both sets of levels become dense as $R \rightarrow \infty$. [In particular, the free energies are $\epsilon_{n,l}^0 = (k_{n,l}^0)^2/2m$ with $k_{n,l}^0 R \equiv x_{n,l}^0 \simeq (n\pi/2 + l\pi/2 + \dots)$, the n th zero of $j_l(x)$.] Yet a careful study of the shifts $\Delta(n,l) \equiv -\epsilon_{n,l} + \epsilon_{n,l}^0$ reveals the full information on the phase shifts in various channels.

The key observation is that the binding energy inequalities hold in general even when the R cutoff is placed, since the relevant QCD or nuclear interactions are short range. These imply then that $\Delta_{n,l}(aa) + \Delta_{n,l}(bb) \leq 2\Delta_{n,l}(ab)$. [For the unperturbed part we have trivially, from the definition of reduced masses, $\epsilon_{n,l}^0(aa) + \epsilon_{n,l}^0(bb) \equiv 2\epsilon_{n,l}^0(ab)$.] Therefore the density of levels $\frac{dn_l(ab)}{dk}$ in the (ab) channel is larger than the average of these densities in the (aa) and (bb) channels.

Levinson’s theorem implies that the phase shift $\delta_l^{(ab)}(k)$ serves as a “level counter” in the continuum limit. Hence

$$\frac{dn_l(ab)}{dk} \simeq \frac{d\delta_l(ab)}{dk}. \quad (\text{G2})$$

³⁵From the discussion at the end of Sec. 11, a decoupling of the squarks and elimination of their Yukawa couplings is indeed required if any QCD-type inequalities are to be proven.

However, in the $k \rightarrow 0$ limit the last quantity is the scattering length for $l = 0$. The inequality

$$\frac{d\delta(aa)}{dk} + \frac{d\delta(bb)}{dk} \leq 2 \frac{d\delta(ab)}{dk}, \quad (\text{G3})$$

yields in the $k \rightarrow 0$ limit the desired inequality between scattering lengths

$$a(aa) + a(bb) \leq 2a(ab). \quad (\text{G4})$$

We would next like to argue that the statement on the $\Delta I = 2$ energy shifts of NN continuum states, for example

$$\Delta BE(pp) + \Delta BE(nn) \leq 2\Delta BE(pn)_{I=1} \quad (\text{G5})$$

does imply the corresponding inequality for the respective scattering lengths

$$a(pp) + a(nn) \leq 2a(pn). \quad (\text{G6})$$

The notation $\Delta BE(pn)_{I=1}$ in Eq. (G5) refers to the shift from the idealized $\Delta BE(pn)_{I=1}$ of some continuum level in the $I = 1$ (flavor symmetrized) np state for the case when $\alpha_{EM} = 0$ and $m_u^{(0)} = m_d^{(0)}$. In this exact I -spin limit, all $(pn)_{I=1}$, (pp) , and (nn) states would be the same, and hence so would be phase shifts, scattering lengths, *etc.*

The $\Delta I = 2$ combination $2\Delta BE(pn)_{I=1} - \Delta BE(nn) - \Delta BE(pp)$ and the similar combination of phase shifts, level densities, and scattering lengths are effected only by electromagnetism – *i.e.* by $\alpha_{EM} \neq 0$. The general feature of positivity of such electromagnetic self energies can therefore be applied. This is so since the positivity applies not only for ground states but to any set of corresponding states which have equal charge density in the $\alpha_{EM} = 0, m_u^{(0)} = m_d^{(0)}$ limit. This then implies the positivity of all these combinations and in particular the desired relation (G6).

In applying the suggested scattering length inequality (G6), we face a “technical” difficulty. The long-range Coulombic interaction yields a (logarithmically) infinite Coulombic phase. In order to extract a meaningful result for $a(pp)$, one must subtract this Coulomb phase shift. Our inequality is based precisely on the positive nature of the Coulombic self-interaction. Thus subtraction of even a part of this interaction could, in principle, invalidate the derivation of the inequality. Indeed, the very approach to continuum phase shifts by quantization in a finite sphere of radius R is jeopardized by the $1/r$ infinite range potential.

We can, however, avoid the Coulombic pp phase shifts and still have a meaningful relation. This relies on the observation that screened versions of the Coulomb potential (*i.e.* Yukawa potential) still yield positive EM self-interactions [specifically the momentum space representation $(\mu^2 + k^2)^{-1}$ is positive]. We can choose the cutoff μ^{-1} to be of the order of the sum of the radii of the two nucleons. Thus the long-range Coulombic phase shift will be screened away, yet all other manifestations of EM interactions which occur during the nucleons’ overlap will be maintained. These include the EM interactions between quarks in the two different nucleons or between their mesonic charge clouds, or more subtle indirect EM effects such as the $\pi^+ - \pi^0$ mass difference and the resulting different ranges for π^+, π^0 exchange potentials [234].

It is the latter effects which occur also in the np and nn systems, which we wish to consider. We cannot prove that the above cutoff procedure is indeed equivalent to Coulomb phase subtraction. However, any cutoff μ [or even arbitrary positive superpositions of potentials with different cutoffs, such as $\int d\mu^2 \sigma(\mu) e^{\mu r}/r$] can be used. Hence for scattering lengths computed with this cutoff, Eq. (G6) holds

$$a^{\sigma(\mu)}(pp) + a^{\sigma(\mu)}(nn) \leq 2a^{\sigma(\mu)}(pn). \quad (\text{G7})$$

We therefore believe that this inequality applies to the quoted “nuclear parts”. Recent measurements indicate that the suggested inequality is indeed satisfied with a wide margin.

In principle, the original general relation (G3) contains much more information than that used to derive the scattering length inequality by taking $l = 0$ and going to the $k \rightarrow 0$ limit. Thus many other inequalities for other scattering parameters in all l waves can be derived for the two nucleon system, although these are not as useful and cannot be readily compared with data.

Inequalities analagous to (G6) should hold for any $I = 1/2$ isospin multiplet. This in particular we should have

$$a(^3\text{He}^3\text{He}) + a(^3\text{H}^3\text{H}) \leq 2a(^3\text{He}^3\text{H}). \quad (\text{G8})$$

The $I = 2$ part can be extracted not only in scattering of two particles which are members of the same I -spin doublet. This suggests relations of the form

$$\begin{aligned}
a(p^3\text{H}) + a(n^3\text{He}) &\geq a(p^3\text{He}) + a(n^3\text{H}) \\
a(K^+n) + a(K^0p) &\geq a(K^+p) + a(K^0n) \\
a(K^0n) + a(K^-p) &\geq a(K^0p) + a(K^-n),
\end{aligned} \tag{G9}$$

and many more. Since many of these relations involve unstable nuclear isotopes, testing them requires radioactive beam facilities.

Finally we note that purely EM $\Delta I = 2$ combinations of masses or scattering lengths can be found for nuclei of higher I -spin.

APPENDIX H: QCD-LIKE INEQUALITIES IN ATOMIC, CHEMICAL, AND BIOLOGICAL CONTEXTS

In this last Appendix we present various inequalities inspired by (more or less) justified analogies with the binding energy and correlator inequalities.

1. Mass relations between compounds of different isotopes

Different isotopes provide an almost ideal example of “flavor independent” interactions. Thus, let there be n_1 stable isotopes of a specific atom $(Z^{(1)}, A_1^{(1)}) \dots (Z^{(1)}, A_{n_1}^{(1)})$ and n_2 of another $(Z^{(2)}, A_1^{(2)}) \dots (Z^{(2)}, A_{n_2}^{(2)})$. In the adiabatic (Born-Oppenheimer) approximation [235], it is clear that the interatomic interactions are independent of the specific isotopes $Z^{(1)}A_i^{(1)}$ and $Z^{(2)}A_j^{(2)}$ chosen. The arguments in Sec. 19 then imply that the binding energies B_{ij} of the n_1n_2 possible compounds thus formed are a convex function of a reduced mass μ sampled at the values

$$\mu_{ij} = \frac{m(Z^{(1)}A_i^{(1)})m(Z^{(2)}A_j^{(2)})}{m(Z^{(1)}A_i^{(1)}) + m(Z^{(2)}A_j^{(2)})}, \tag{H1}$$

with $m(Z, A)$ the nuclear masses. This includes in particular the analog of the interflavor mass inequalities³⁶ $BE(x, x) + BE(x, y) \leq 2BE(x, y)$, *e.g.*

$$\begin{aligned}
BE(\text{H}_2) + BE(\text{D}_2) &\leq 2BE(\text{HD}) \\
BE(^{16}\text{O}_2) + BE(^{18}\text{O}_2) &\leq 2BE(^{16}\text{O}_2 + ^{18}\text{O}_2).
\end{aligned} \tag{H2}$$

We have not investigated the availability of data verifying these many true mass inequalities.

The flavor (*i.e.* isotopic) independence arguments can be extended to more complex atomic compounds like XXZ , XZZ , *etc.* and the “convexity” relations (*e.g.* the analogs of those conjectured for baryons in QCD) are likely to hold. This will indeed be the case if the two- and three-body interactions between the nuclei satisfy the condition of positive $\exp\{V\}$ utilized in Lieb’s proof in App. B. We are indebted to Phil Allen [236], for pointing out to us this rather nice test of QCD-like inequalities.

2. Conjectured inequalities for chemical bindings

Atoms with closed shells or even a given (n, l) subshell constituting one Slater determinant of all possible m_l, m_s states are singlets of any relevant quantum numbers. This suggests using such states, say $(\text{Ne}|Z = 10)$, as vacuum states upon which we can build “particle” states $X = (\text{Na}|Z = 11)$ or “hole” states $\bar{X} = (\text{F}|Z = 9)$. Likewise another noble gas “vacuum”, say $(\text{Ar}|Z = 18)$, yields $Y = (\text{K}|Z = 19)$, $\bar{Y} = (\text{Cl}|Z = 17)$. If we use this identification of vacuums, particles, and antiparticles, we might be tempted to conjecture, in “analogy” with Eq. (2.7), that

$$BE(X\bar{X}) + BE(Y\bar{Y}) \geq BE(X\bar{Y}) + BE(Y\bar{X}). \tag{H3}$$

³⁶The BE refers to the true molecular ground states or to sums over the first n states. The fact that Bose/Fermi statistics can imply even/odd J s in the rotation band of homoisotopic compounds has a negligible effect and can be corrected for.

This yields, for example,

$$\begin{aligned} BE(\text{NaF}) + BE(\text{KCl}) &\geq BE(\text{NaCl}) + BE(\text{KF}) \\ BE(\text{MgO}) + BE(\text{CaS}) &\geq BE(\text{MgS}) + BE(\text{CaO}), \end{aligned} \tag{H4}$$

etc. We might, however, consider half-filled shells, *e.g.* C, Si, *etc.* with an equal number of electrons and holes to be the correct atomic analog of the vacuum, in which case Eq. (H3) translates into

$$BE(\text{LiF}) + BE(\text{NaCl}) \geq BE(\text{LiCl}) + BE(\text{NaF}), \tag{H5}$$

etc.

3. Mass inequalities in nuclear physics

For a while we were excited about the prospect [237] that true QCD inequalities could show that even-even $N = Z$ states are – barring Coulomb effects – the most tightly bound.

The sophisticated third order Garvey-Kelson [238] difference relations connect masses of many isotopes. However, there is no obvious pattern of deviations from the relations, and we have not found a simple motivation for any such pattern.

4. A biological analog for inequalities between correlators

The pseudoscalar mass inequalities of Sec. 12 reflect simple Schwartz inequalities for correlators, *i.e.* for weighted bilinears in quark propagators. Generically the latter have gauge interaction induced “phases”. These cancel in the $\text{tr}(S_i S_i^\dagger)$ combinations appearing in the particular case of the pseudoscalar propagators.³⁷

In an extremely wide variety of circumstances we may encounter joint propagation of two equal or two different entities. Quantum phases are typically irrelevant and we can assign a positive probability for the propagation of “ \mathcal{A} ” from “ P_1 ” to “ P_2 ” for any given set of relevant influencing “factors” A_n – the analog of the background gauge fields in the QCD case:

$$\mathcal{P} \{ \mathcal{A}(\text{at } P_1) \rightarrow \mathcal{A}(\text{at } P_2) \} |_{\{A_n\}}. \tag{H6}$$

The overall probability of \mathcal{A} “propagating” from P_1 to P_2 is then given by a “functional” (path integrated) averaging over the distribution of the $\{A_n\}$ factors:

$$\mathcal{P} \{ \mathcal{A}(\text{at } 1) \rightarrow \mathcal{A}(\text{at } 2) \} = \int d\mu \{ A_1 \dots A_n \} \mathcal{P} \{ \mathcal{A}(\text{at } 1) \rightarrow \mathcal{A}(\text{at } 2) \} |_{\{A_n\}}, \tag{H7}$$

with a normalized $\int d\mu \{ A \} = 1$ positive measure of $\{ A_1 \dots A_n \}$.

The probability of the joint propagation of $\mathcal{A}(1), \mathcal{B}(1) \rightarrow \mathcal{A}(2), \mathcal{B}(2)$ is given by the corresponding weighted average of the bilinear product of propagators:

$$\mathcal{P} \left\{ \begin{array}{l} \mathcal{A}(1) \rightarrow \mathcal{A}(2) \\ \mathcal{B}(1) \rightarrow \mathcal{B}(2) \end{array} \right\} = \int d\mu \{ A_i \} \mathcal{P} \{ \mathcal{A}(1) \rightarrow \mathcal{A}(2) \} |_{\{A_n\}} \cdot \mathcal{P} \{ \mathcal{B}(1) \rightarrow \mathcal{B}(2) \} |_{\{A_n\}}. \tag{H8}$$

Likewise, the probability of joint propagation of *two* \mathcal{A} objects from (1) to (2) (or *two* \mathcal{B} objects) is given by a similar expression involving squares of propagators:

$$\mathcal{P} \left\{ \begin{array}{l} \mathcal{A}(1) \rightarrow \mathcal{A}(2) \\ \mathcal{A}(1) \rightarrow \mathcal{A}(2) \end{array} \right\} = \int d\mu \{ A_i \} [\mathcal{P} \{ \mathcal{A}(1) \rightarrow \mathcal{A}(2) \} |_{\{A_n\}}]^2, \tag{H9}$$

and

³⁷Schwartz inequalities have often been used in other contexts of particle physics. See, *e.g.*, Ref. [239].

$$\mathcal{P} \left\{ \begin{array}{l} \mathcal{B}(1) \rightarrow \mathcal{B}(2) \\ \mathcal{B}(1) \rightarrow \mathcal{B}(2) \end{array} \right\} = \int d\mu \{A_i\} [\mathcal{P} \{ \mathcal{B}(1) \rightarrow \mathcal{B}(2) \} |_{\{A_n\}}]^2 . \quad (\text{H10})$$

The Schwartz inequality readily implies the final desired relation:

$$\mathcal{P} \left\{ \begin{array}{l} \mathcal{A}(1) \rightarrow \mathcal{A}(2) \\ \mathcal{A}(1) \rightarrow \mathcal{A}(2) \end{array} \right\} \cdot \mathcal{P} \left\{ \begin{array}{l} \mathcal{B}(1) \rightarrow \mathcal{B}(2) \\ \mathcal{B}(1) \rightarrow \mathcal{B}(2) \end{array} \right\} \geq \left[\mathcal{P} \left\{ \begin{array}{l} \mathcal{A}(1) \rightarrow \mathcal{A}(2) \\ \mathcal{B}(1) \rightarrow \mathcal{B}(2) \end{array} \right\} \right]^2 . \quad (\text{H11})$$

There are certainly innumerable applications of the above relation in all areas of science technology and life sciences (most of which were very likely well known for some time). In the last page of this review we consider one particular, somewhat intriguing, and exotic application concerning the sex of non-identical twins.

The conception of non-identical twins can be viewed as the joint propagation in the same (or relatively similar³⁸) “background” of two sperms. Hence we expect that for non-identical twins,³⁹

$$\mathcal{P}(\text{male, male})\mathcal{P}(\text{female, female}) \geq [\mathcal{P}(\text{female, male})]^2 . \quad (\text{H12})$$

Clearly the probability of any specific single (or double) conception need not be accurately reflected in the percentages at birth. We could however still derive the same inequalities if we consider not merely the propagation from “inception” to “conception” but also the subsequent nine month long “timelike” propagation to birth.

The extent to which the inequality (H12) is satisfied, *i.e.* the deviation of the ratio of the RHS and LHS from unity, can serve as a measure of the overall degree of non-parallelism of the male and female birth “vectors”, *i.e.* as a crude measure of the total importance of “variables” known, or as yet unknown, in determining the sex of the fetus, which is a quantity of considerable interest.

A priori [240] there could be some unique rather surprising effect which would disqualify our proof and possibly reverse the sign in Eq. (H12). This would be the case if there were a *direct interaction* between the propagating elements – in this case the fetuses of the two twins. Thus following the biblical story of the rather unrestful pregnancy of Rebekah [241] with Esau and Jacob (a clear case of non-identical twins!), we can assume that the competition between equal sex brothers (and possibly sisters) extends to the prenatal stages. Clearly if it is too strong it could conceivably disrupt (MM) and (FF) births, thus tending to reverse the sign of the effect considered. Hopefully this is not the case.

We have not attempted to verify any of the above non-QCD mass inequalities. In particular, the last twin inequalities may require rather extensive statistical analysis.⁴⁰ We hope that the inequalities will eventually be tested.

- [1] See, *e.g.*, C. Itzykson and J.-B. Zuber, *Quantum Field Theory*, (McGraw Hill, New York, 1980).
- [2] For early references, see E.A. Abers and B.W. Lee, *Phys. Rep.* **9C**, 1 (1973).
- [3] See, *e.g.*, M. Creutz, L. Jacobs, and C. Rebbi, *Phys. Rep.* **95**, 201 (1983).
- [4] M. Creutz, *Quarks, Gluons, and Lattices*, (Cambridge University Press, Cambridge, 1983).
- [5] I. Montvay, *Rev. Mod. Phys.* **59**, 263 (1987).
- [6] D. Weingarten, *Phys. Rev. Lett.* **51**, 1830 (1983).
- [7] C. Vafa and E. Witten, *Nucl. Phys.* **B234**, 173 (1984).
- [8] C. Vafa and E. Witten, *Phys. Rev. Lett.* **53**, 535 (1984).
- [9] C. Vafa and E. Witten, *Comm. Math. Phys.* **95**, 257 (1984).
- [10] E. Witten, *Phys. Rev. Lett.* **51**, 2351 (1983).
- [11] S. Nussinov, *Phys. Rev. Lett.* **51**, 2081 (1983).
- [12] G. 't Hooft, in *Recent Development in Gauge Theories, Proceedings of the Cargese Summer Institute 1979*, ed. G. 't Hooft *et al.* (Plenum Press, New York, 1980).
- [13] Y. Frishman, A. Schwimmer, T. Banks, and S. Yankielowicz, *Nucl. Phys.* **B177**, 157 (1981).
- [14] S. Nussinov, *Phys. Lett.* **B136**, 93 (1984).

³⁸If the two eggs are fertilized in subsequent encounters.

³⁹ $\mathcal{P}(F, M)$ refers to half the probability of mixed-sex twins – say in which the female was born first.

⁴⁰Construction of a clean sample of non-identical twins (nonbiased by sex consideration!) is a highly demanding task.

- [15] J.-M. Richard, Phys. Lett. **B139**, 408 (1984).
- [16] J.P. Ader, J.-M. Richard, and P. Taxil, Phys. Rev. D **25**, 2370 (1982).
- [17] S. Nussinov, Phys. Rev. Lett. **52**, 966 (1984).
- [18] E. Lieb, Phys. Rev. Lett. **54**, 1987 (1985).
- [19] S. Nussinov, Phys. Lett. **B139**, 203 (1984).
- [20] S. Nussinov and B. Sathiapalan, Nucl. Phys. **B26**, 285 (1985).
- [21] I.J. Muzinich and V.P. Nair, Phys. Lett. **B178**, 105 (1986).
- [22] D. Espriu, M. Gross, and J.F. Wheeler, Phys. Lett. **B146**, 67 (1984).
- [23] S.G. Goodyear, Preprint Edinburgh 84/318.
- [24] R. Bertlmann and A. Martin, Nucl. Phys. **B168**, 111 (1980).
- [25] J.-M. Richard and P. Taxil, Ann. Phys. **150**, 267 (1983).
- [26] J.-M. Richard, Phys. Rept. **212**, 1 (1992).
- [27] R. Shankar, *Principles of Quantum Mechanics*, (Plenum Press, New York, 1980).
- [28] A treatment of the hadronic spectrum with hyperfine effects is given in A. de Rujula, H. Georgi, and S.L. Glashow, Phys. Rev. D **12**, 47 (1975).
- [29] E.M. Levin and L.L. Frankfurt, JETP Letters **2**, 65 (1965).
- [30] H.J. Lipkin and F. Scheck, Phys. Rev. Lett. **16**, 71 (1966).
- [31] P.G.O. Freund and Y. Nambu, Phys. Rev. Lett. **34**, 1645 (1975).
- [32] For a general review of the “naive” quark model, see H.J. Lipkin, Phys. Rep. **8C**, 175 (1973).
- [33] A.W. Hendry and D.B. Lichtenberg, Fortsch. Phys. **33**, 139 (1985).
- [34] J.L. Basdevant, A. Martin, and J.-M. Richard, Nucl. Phys. **B343**, 69 (1990).
- [35] S. Mandelstam, Nucl. Phys. **B213**, 149 (1983).
- [36] M. Baker, L. Carson, J.S. Ball, and F. Zachariassen, Nucl. Phys. **B229**, 456 (1983).
- [37] I. Cohen and H.J. Lipkin, Phys. Lett. **B93**, 56 (1980).
- [38] T.D. Imbo, Phys. Lett. **B398**, 374 (1997).
- [39] A. Martin, Phys. Lett. **B287**, 251 (1992).
- [40] G. Zweig, CERN-TH-412, 1964.
- [41] H.J. Lipkin, Phys. Lett. **B225**, 287 (1989).
- [42] J.-M. Richard and P. Taxil, Phys. Rev. Lett. **54**, 847 (1985).
- [43] G. 't Hooft, Nucl. Phys. **B138**, 1 (1978).
- [44] S. Mandelstam, Phys. Rev. D **19**, 2391 (1979).
- [45] Y. Aharonov, A. Casher, and S. Yankielowicz, Nucl. Phys. **B146**, 256 (1978).
- [46] T. Kovacs and E.T. Tomboulis, Phys. Rev. D **57**, 4054 (1998); Phys. Lett. **B443** 239 (1998).
- [47] J.M. Cornwall, Phys. Rev. D **57**, 7589 (1998); *ibid.* **58**, 105028 (1998).
- [48] J. Greensite and J. Winchester, Phys. Rev. D **40**, 4167 (1989).
- [49] A. Polyakov, Phys. Scripta **T15**, 191 (1987).
- [50] Y. Nambu, lectures prepared for the Copenhagen Summer Symposium, 1970 (unpublished); T. Goto, Prog. Theor. Phys. **46**, 1560 (1971).
- [51] L. Susskind, Nuovo Cimento **69**, 457 (1970).
- [52] L. Susskind in *Les Houches 1976 Proceedings, Weak and Electromagnetic Interactions at High Energies*, ed. R. Balian and C.H. Llewellyn Smith, (Elsevier, Amsterdam, 1977).
- [53] P. Horgan, J. Kuti, and J.-M. Richard, Phys. Lett. **B94**, 401 (1980).
- [54] S. Nussinov, Phys. Lett. **B180**, 124 (1979).
- [55] G. Alexander, I. Cohen, and E. Levin, Phys. Lett. **B452**, 159 (1999).
- [56] S. Nussinov, unpublished.
- [57] S. Iwao, Prog. Theo. Phys. **74**, 1350 (1985); Nuovo Cim. Lett. **41**, 257 (1984); Nuovo Cim. Lett. **40**, 373 (1984).
- [58] Particle Data Group, C. Caso *et al.*, The European Physical Journal **C3**, 1 (1998).
- [59] S. Adler and R. Dashen, *Current Algebra*, (Benjamin, New York, 1968).
- [60] J.L. Rosner, Phys. Rev. Lett. **21**, 950 (1968).
- [61] C. Lovelace, Phys. Lett. **B28**, 264 (1968); J.A. Shapiro, Phys. Rev. **197**, 1345 (1969).
- [62] G. 't Hooft, Phys. Rep. **142**, 357 (1986).
- [63] E. Witten, Nucl. Phys. **B156**, 269 (1979); G. Veneziano, Phys. Lett. **B95**, 90 (1980).
- [64] M. Gell-Mann and Y. Ne'eman, *The Eightfold Way*, (Benjamin, New York, 1963).
- [65] For a review of $\eta\eta'$ mixing, see F. Gilman and R. Kauffman, Phys. Rev. D **36**, 2761 (1987).
- [66] A. Falk, Phys. Rev. Lett. **77**, 223 (1996).
- [67] S. Coleman, in *Lectures at 1979 International School of Subnuclear Physics, Erice*, ed. A. Zichichi, (Plenum Press, New York, 1979).
- [68] S. Ratti, in *Proceedings of The Workshop on Hadron Spectroscopy*, ed. T. Bressani, A. Feliciello, and A. Filippi (Frascati

Physics Series Vol. 15, INFN, 1999).

- [69] J. Schwinger, Phys. Rev. **82**, 664 (1951).
- [70] A careful discussion of these issues with the transfer matrix playing the role of the Hamiltonian was given in the context of a lattice gauge theory by M. Lüscher, Comm. Math. Phys. **54**, 283 (1977).
- [71] G. Domokos and S. Kovesi-Domokos, Phys. Lett. **B159**, 284 (1985).
- [72] S. Adler, Phys. Rev. **177**, 2426 (1969).
- [73] S. S. Bell and R. Jackiw, Nuovo Cimento **60A**, 47 (1969).
- [74] K. Fujikawa, Phys. Rev. D **21**, 2848 (1980).
- [75] A. Hasenfratz and P. Hasenfratz Phys. Lett. **B104**, 489 (1981).
- [76] L. Susskind, Phys. Rev. D **16**, 3031 (1977).
- [77] K. Wilson, Phys. Rev. D **10**, 2455 (1974); and in *New Phenomena in Subnuclear Physics*, ed. A. Zichichi, (Plenum Press, New York, 1977).
- [78] D.B. Kaplan, Phys. Lett. **B288**, 342 (1992).
- [79] G. Feinberg and J. Sucher, Phys. Rev. A **2**, 2395 (1970).
- [80] R. Anishetty and D. Wyler, Phys. Lett. **154B**, 401 (1985).
- [81] S.D.H. Hsu, Phys. Rev. D **48**, 4458 (1993).
- [82] E. Witten, Phys. Lett. **117B**, 324 (1982).
- [83] J. Goldstone, Nuovo Cimento **19**, 154 (1961).
- [84] Y. Nambu and G. Jona-Lasinio, Phys. Rev. **122**, 345 (1961).
- [85] M. Gell-Mann, R.J. Oakes, and B. Renner, Phys. Rev. **175**, 2195 (1968).
- [86] V. Azcoiti and A. Galante, Phys. Rev. Lett. **83**, 1518 (1999).
- [87] T. Kato Israel, J. Math. **13**, 135 (1972).
- [88] R.P. Feynman and A.R. Hibbs, *Quantum Mechanics and Path Integrals*, (McGraw-Hill, New York, 1965).
- [89] Y. Aharonov and A. Casher, Phys. Rev. A **19**, 2461 (1979).
- [90] E. Titchmarsh, *Theory of Functions*, (Oxford University Press, London, 1939).
- [91] D. Weingarten and J. Chalifour, Ann. Phys. (N.Y.) **123**, 61 (1977).
- [92] Chiral phase transitions at finite temperature were discussed, *e.g.*, by R. Pisarski in *Quark Confinement and Liberation, Proceedings of Berkeley Quark Confinement*, ed. F. Klinkhamer and M. Halpern, (World Scientific, Singapore, 1985).
- [93] M.A. Shifman, A.I. Weinstein, and V.I. Zakharov, Nucl. Phys. **B147**, 385, 448 (1979).
- [94] L. Reinders, H. Rubinstein, and S. Yasaki, Phys. Rep. **127C**, 1 (1985).
- [95] T. Banks and A. Casher, Nucl. Phys. **B169**, 102 (1980).
- [96] A. Casher, Phys. Lett. **B83**, 395 (1979).
- [97] H. Harari and N. Seiberg, Nucl. Phys. **B204**, 141 (1981).
- [98] M. Peskin, in *Proceedings of 10th International Symposium on Lepton and Photon Interactions at High Energy*, ed. W. Pfeil, (Bonn, 1981).
- [99] I. Bars, in *Proceedings of College Park Superstrings*, ed. S. J. Gates and R. Mohapatra, (World Scientific, Singapore, 1981).
- [100] E. Eichten, K. Lane, and M. Peskin, Phys. Rev. Lett. **50**, 811 (1983).
- [101] S. Coleman and B. Grossman, Nucl. Phys. **B203**, 205 (1982).
- [102] H. Georgi and S. L. Glashow, Phys. Rev. D , 429 (1972).
- [103] S.L. Adler and W.A. Bardeen, Phys. Rev. **182**, 1517 (1969).
- [104] S. Coleman and E. Witten, Phys. Rev. Lett. **45**, 100 (1980).
- [105] S. Nussinov and M. Spiegelglas, Phys. Lett. **B181**, 134 (1986).
- [106] A.A. Belavin, A. Polyakov, A. Schwartz, and Y. Tyupkin, Phys. Rev. Lett. **30**, 1343 (1973).
- [107] D.A. Callan, Jr., R. Dashen, and D.J. Gross, Phys. Rev. D **17**, 2717 (1978).
- [108] D.G. Caldi, Phys. Rev. Lett. **39**, 121 (1977).
- [109] M. Rafecas and V. Vento, Phys. Lett. **B297**, 186 (1992).
- [110] A. Ferrando and V. Vento, Z. Phys. **C63**, 485 (1994).
- [111] J. Stern, hep-ph/9801282.
- [112] I. Kogan, A. Kovner, and M. Shifman, Phys. Rev. D **59**, 016001 (1999).
- [113] A.S. Goldhaber and M. Nieto, Rev. Mod. Phys. **43**, 277 (1971).
- [114] J.M. Gipson, Y. Tosa, and R.E. Marshak, Phys. Rev. D **32**, 284 (1985).
- [115] S. Raby, S. Dimopoulos, and L. Susskind, Nucl. Phys. **B169**, 373 (1980).
- [116] H. Georgi, Nucl. Phys. **B266**, 274 (1986).
- [117] B.-R. Zhou, Phys. Lett. **B215**, 364 (1988); Commun. Theor. Phys. **18**, 347 (1992); *ibid.* **19**, 377 (1993).
- [118] J.C. Pati and A. Salam, Phys. Rev. D **8**, 1240 (1973);
O.W. Greenberg and J. Sucher, Phys. Lett. **B99**, 339 (1981).
- [119] J.M. Gerard, Y. Okamoto, and R.E. Marshak, Phys. Lett. **B169**, 386 (1986).
- [120] S. King, Phys. Lett. **B174**, 303 (1986).
- [121] O. Aharony, J. Sonnenschein, M.E. Peskin, and S. Yankielowicz, Phys. Rev. D **52**, 6157 (1995).

- [122] H. Nishino, hep-th/9804162.
- [123] M. Cvetič, Univ. of Maryland Preprint 85-23 (1984).
- [124] L.F. Abbott and E. Farhi, Nucl. Phys. **B189**, 547 (1981); Phys. Lett. **B101**, 69 (1981).
- [125] M. Claudson, E. Farhi, and R.L. Jaffe, Phys. Rev. D **34**, 873 (1986).
- [126] H.B. Nielsen and M. Ninomiya, Nucl. Phys. **B185**, 20 (1981).
- [127] R. Narayanan and H. Neuberger, Phys. Lett. **B302**, 62 (1993).
- [128] V. Furman and Y. Shamir, Nucl. Phys. **B439**, 54 (1995).
- [129] T. Blum and A. Soni, Phys. Rev. D **56**, 174 (1997); Phys. Rev. Lett. **79**, 3595 (1997).
- [130] M. Lüscher, Nucl. Phys. **B549**, 295 (1999).
- [131] T. Das, G.S. Guralnik, V.S. Mathur, F.E. Low, and J.E. Young, Phys. Rev. Lett. **18**, 759 (1967).
- [132] H. Burkhardt and W.N. Cottingham, Annals. Phys. **56**, 453 (1970).
- [133] H. Harari, Phys. Rev. Lett. **18**, 319 (1967).
- [134] T. Das, V.S. Mathur, and S. Okubo, Phys. Rev. Lett. **18**, 761 (1967).
- [135] S. Weinberg, Phys. Rev. Lett. **18**, 507 (1967).
- [136] E.V. Shuryak and J.J.M. Verbaarschot, Nucl. Phys. **B410**, 55 (1993).
- [137] G. Altarelli and R. Barbieri, Phys. Lett. **B253**, 161 (1991).
- [138] M. Peskin and T. Takeuchi, Phys. Rev. D **46** 381 (1992).
- [139] E. Eichten and F. Feinberg, Phys. Rev. D **23**, 2824 (1981).
- [140] T. Appelquist and F. Sannino, Phys. Rev. D **59**, 067702 (1999).
- [141] A. Casher, private communication.
- [142] M. E. Peskin, Nucl. Phys. **B175**, 197 (1980).
- [143] J. P. Preskil, Nucl. Phys. **B177**, 21 (1980).
- [144] S. Weinberg, Phys. Rev. D **19**, 1277 (1979).
- [145] L. Susskind, Phys. Rev. D **20**, 2619 (1979).
- [146] P. Sikivie and C.B. Thorn, Phys. Lett. **B234**, 132 (1990);
M. Asorey and F. Falceto, Phys. Rev. Lett. **77**, 3074 (1996).
- [147] G. 't Hooft, Nucl. Phys. **B75**, 461 (1974).
- [148] D.D. Coon and D.A. Geffen, *Proceedings of the Third International Conference on Experimental Meson Spectroscopy*, ed. Arthur H. Rosenfeld and Kwan-Wu Lai, (American Institute of Physics, New York, 1972).
- [149] K. Aoki and T. Ichihara, Phys. Rev. D **52**, 6435 (1995).
- [150] See, e.g., A.V. Anisovich *et al.*, Phys. Lett. **B449**, 145 (1999).
- [151] For a general discussion of glueballs, see e.g. S. Meshkov, in *Proceedings of Aspen Winter Physics Conference*, ed. M. Block, (New York Academy of Sciences, New York, 1986).
- [152] I.J. Muzinich and V.P. Nair, Phys. Lett. **B178**, 105 (1986).
- [153] Geoffrey B. West, Phys. Rev. Lett. **77**, 2622 (1996).
- [154] D. Hasenfrantz and J. Kuti, Phys. Rep. **40C**, 75 (1978).
- [155] K. Johnson and C.B. Thorn, Phys. Rev. D **13**, 1934 (1976).
- [156] S. Brodsky, G.P. Lepage, and S.F. Tuan, Phys. Rev. Lett. **59**, 621 (1987).
- [157] R. Gupta, A. Patel, and S. Sharpe, Phys. Rev. D **48**, 388 (1993).
- [158] See, e.g. K. Gottfried, *Quantum Mechanics*, (Benjamin, New York, 1966).
- [159] G.F. Chew and F.E. Low, Phys. Rev. **113**, 1640 (1959).
- [160] D. Morgan and M.R. Pennington, to be published in the second DAPHNE Physics Handbook.
- [161] R.L. Jaffe, Phys. Rev. D **15**, 267, 281 (1977).
- [162] M. Lüscher, Nucl. Phys. **B354**, 531 (1991); Commun. Math. Phys. **104**, 177 (1986); *ibid.* **105**, 153 (1986).
- [163] H. Neuberger, Phys. Rev. Lett. **60**, 889 (1988).
- [164] G. Feinberg and J. Sucher, Jour. Chem. Phys. **48**, 3333 (1968).
- [165] O. Kenneth and S. Nussinov, unpublished.
- [166] This is suggested by soft pion plus current algebra estimates of S. Weinberg and Y. Tomazawa, see Ref. [59]; and by universally coupled exchange *à la* Sakurai and is in accord with the experimental information available.
- [167] J. Kapusta, *Finite Temperature Field Theory*, (Cambridge University Press, Cambridge, 1989).
- [168] L.G. Yaffe and B. Svetitsky, Phys. Rev. D **26**, 963 (1982).
- [169] N. Weiss, Phys. Rev. D **24**, 475 (1981); *ibid.* **25**, 2667 (1982).
- [170] See, e.g. *LATTICE 98: Proceedings of the 16th International Symposium on Lattice Field Theory*, ed. T. DeGrant, C. Detar, R. Sugar, and D. Toussaint (North-Holland, Amsterdam, 1999).
- [171] T. Cohen, Phys. Rev. D **54**, 1867 (1996).
- [172] See e.g. K. Rajagopal and F. Wilczek, Nucl. Phys. **B404**, 577 (1993);
J.-P. Blaizot and A. Krzywicki, Phys. Rev. D **50**, 442 (1994);
J.D. Bjorken, Acta Phys. Polon. **B28**, 2773 (1997).
- [173] M. Alford, K. Rajagopal, and F. Wilczek, Phys. Lett. **B422**, 247 (1998);
R. Rapp, T. Schäfer, E.V. Shuryak, and M. Velkovsky, Phys. Rev. Lett. **81**, 53 (1998);

- R. Pisarski and D. Rischke, Phys. Rev. **D60**, 094013 (1999).
- [174] J.B. Kogut, M.A. Stephanov, and D. Toublan, [hep-ph/9906346](#).
- [175] M. Bander and H.R. Rubinstein, Phys. Lett. B317, 187 (1993).
- [176] D. Lai and E.E. Salpeter, [astro-ph/9510123](#), [astro-ph/9510124](#).
- [177] See *e.g.* C. Quigg and J.L. Rosner, Phys. Rep. **56**, 167 (1979).
- [178] J.-M. Richard, Nucl. Phys. Proc. Suppl. **39BC**, 441 (1995).
- [179] W. Kwong and J.L. Rosner, Phys. Rev. **D44**, 212 (1991).
- [180] R. Roncaglia, A. Dzierba, D.B. Lichtenberg and E. Predazzi, Phys. Rev. **D51**, 1248 (1995).
- [181] J. Gasser and H. Leutwyler, Phys. Rep. **87**, 77 (1982).
- [182] A.K. Common and A. Martin, Europhys. Lett. **4**, 1349 (1987).
- [183] B. Baumgartner, H. Grosse, and A. Martin, Nucl. Phys. **B254**, 528 (1985); *ibid* Phys. Lett. **B146**, 363 (1984).
- [184] G. Feldman and T. Fulton, Nucl. Phys. **B154**, 441 (1979).
- [185] A. Martin, J.-M. Richard, and P. Taxil, Phys. Lett. **B176**, 223 (1986).
- [186] C. Bachas, Phys. Rev. D **33**, 2723 (1986);
E. Seiler, Phys. Rev. D **18**, 482 (1978).
- [187] B. Simon and L. Yaffe, Phys. Lett. **B115**, 143 (1982).
- [188] D. Gromes, Phys. Lett. **B202**, 262 (1988).
- [189] W. Buchmuller, Phys. Lett. **B112**, 479 (1982).
- [190] See *e.g.* W. Thirring, *Quanten-mechanik von Atomen und Molekulen, Vol. 3*, (Springer, Berlin, 1979).
- [191] S. Nussinov, Phys. Lett. **B164**, 366 (1985).
- [192] E. de Rafael, *CP Violation and the Limits of the Standard Model*, (Benjamin/Cummings, California, 1994).
- [193] Y.B. Hsiung [KTeV Collaboration], To be published in the proceedings of International Workshop on CP Violation in K, Tokyo, Japan, 18-19 December 1998.
- [194] J. Cornwall, R. Jackiw, and E. Tomboulis, Phys. Rev. D **10**, 2428 (1974).
- [195] D. Espriu, E. de Rafael, and J. Taron, Nucl. Phys. **B345**, 22 (1990).
- [196] T.H.R. Skyrme, Nucl. Phys. **31**, 556 (1962);
G.S. Adkins, C.R. Nappi, and E. Witten, Nucl. Phys. **B228**, 552 (1983).
- [197] J. Comellas, J. Latorre, and J. Taron, Phys. Lett. **B360**, 109 (1995).
- [198] S. Nussinov and W. Wetzel, Phys. Rev. D **36**, 130 (1987).
- [199] M. B. Voloshin and M.A. Shifman, Sov. J. Nucl. Phys. **45**, 292 (1987); *ibid.* **47**, 511 (1988).
- [200] N. Isgur and M.B. Wise, Phys. Lett. **B232**, 113 (1989); *ibid.* **B237**, 527 (1990).
- [201] Z. Guralnik and A. Manohar, Phys. Lett. **B302**, 103 (1993).
- [202] I.I. Bigi and N.G. Uraltsev, Phys. Lett. **B321**, 412 (1994).
- [203] M. Kobayashi and T. Maskawa, Prog. Theor. Phys. **49**, 652 (1973).
- [204] J. Alfaro, R.C. Brower, and M.B. Gavela, Phys. Lett. **B147**, 357 (1984).
- [205] T. Blum *et al.*, [hep-lat/9908025](#);
T. Blum and A. Soni, [hep-lat/9909108](#).
- [206] S. Nussinov and M. Spiegelglas, Phys. Lett. **B202**, 265 (1988).
- [207] K. Barad, M. Ogilvie, and C. Rebbi, Phys. Lett. **B143**, 22 (1984);
ibid., Ann. Phys. **168**, 284 (1986).
- [208] W. Wilcox and K.F. Liu, Phys. Lett. **B172**, 62 (1986);
G. Martinelli and C.T. Sachrajda, Nucl. Phys. **B306**, 865 (1988).
- [209] I. Herbst and S. Nussinov, Phys. Rev. D **17**, 1362 (1978).
- [210] H.J. Brascamp, E.H. Lieb, and J.M. Luttinger, J. Func. Anal. **17**, 227 (1974).
- [211] M. Aizenmann, Phys. Rev. Lett. **47**, 1 (1981);
J. Frohlich, Nucl. Phys. **B200**, 281 (1982).
- [212] O. Kenneth, private communication.
- [213] N. Seiberg, Phys. Rev. D **49**, 6857 (1994); Nucl. Phys. **B435**, 129 (1995).
- [214] D. Griffiths, in *Phase Transitions and Critical Phenomena, Vol. I*, edited by C. Domb and M.S. Green (Academic Press, 1976).
- [215] S. Nussinov, Phys. Rev. D **50**, 3167 (1994).
- [216] D.G. Caldi and H. Pagels, Phys. Rev. **D14**, 809 (1976).
- [217] J. Kogut and L. Susskind, Phys. Rev. D **11**, 395 (1975).
- [218] See *e.g.* A. Casher, H. Neuberger, and S. Nussinov, Phys. Rev. D **20**, 179 (1979).
- [219] For an extensive review, see J. J. Griffin, Int. J. Mod. Phys. **6**, 1985 (1991).
- [220] S. Nussinov, Phys. Lett. **B314**, 397 (1993).
- [221] J. Finger, D. Horn, and J.E. Mandula, Phys. Rev. D **20**, 3253 (1979).
- [222] R.L. Jaffe, Phys. Rev. Lett. **38**, 195 (1977).
- [223] T. Barnes, F.E. Close, and S. Monaghan, Phys. Lett. **B110**, 159 (1982).
- [224] N. N. Achasov, S.A. Devyanin, and G.N. Shestakov, Z. Phys. **C22**, 53 (1984);

N.N. Achasov, hep-ph/9910540.

- [225] E. Farhi and R.L. Jaffe, Phys. Rev. D **30**, 2379 (1984).
- [226] E. Witten, Phys. Rev. D **30**, 272 (1984).
- [227] H.J. Lipkin, Phys. Lett. **B195**, 484 (1987); Nucl. Phys. **A625**, 207 (1997).
- [228] C. Gignoux, B. Silvestre-Brac, and J.-M. Richard, Phys. Lett. **B193**, 323 (1987); S. Fleck, C. Gignoux, J.-M. Richard, and B. Silvestre-Brac, Phys. Lett. **B220**, 616 (1989).
- [229] Murray Moinester, Z. Phys. **A335**, 349 (1996); M.A. Moinester, D. Ashery, L.G. Landsberg, and H.J. Lipkin, Z. Phys. **A356**, 207 (1996).
- [230] BNL-E888 Collaboration, Nucl. Phys. **A585**, 97c (1995); BNL-E888 Collaboration, Phys. Rev. D **53**, 3487 (1996).
- [231] D. Ashery, Few-Body Suppl. **10**, 295 (1999).
- [232] A. Manohar and M. Wise, Nucl. Phys. **B399**, 17 (1993).
- [233] N.A. Tornqvist, Nuovo Cim. **107A**, 2471 (1994).
- [234] U. van Kolck, J.L. Friar, and T. Goldman, Phys. Lett. **B371**, 169 (1996).
- [235] A. Schild, Annals Phys. **93**, 88 (1975); *ibid.* **99**, 434 (1976).
- [236] P. Allen, private communication.
- [237] T. Cohen, nucl-th/9811038, nucl-th/9811044.
- [238] G.T. Garvey and I. Kelson, Phys. Rev. Lett. **16**, 197 (1966).
- [239] H. Terazawa, Rept. No. COO-3505B-22.
- [240] I. Eshel, private communication.
- [241] Genesis 25:22.

FIG. 1. Vertex and propagator insertion of the one gluon exchange diagram with the $\lambda_1 \cdot \lambda_2$ structure intact.

FIG. 2. The general two quark interaction is a sum of $\lambda_1 \cdot \lambda_2$ (octet exchange) and $1_1 \cdot 1_2$ (singlet exchange) interactions.

FIG. 3. A non-separable three body interaction in the baryon due to the three gluon vertex which is shown, however, to vanish.

FIG. 4. (a) The color string picture for a meson. (b) The color network for a qqq baryon with one junction.

FIG. 5. Illustration of how a given Y configuration in a baryonic wave functional yields configurations for three mesonic trial wave functionals. The relation $2H_{123} = H_{1\bar{2}} + H_{2\bar{3}} + H_{3\bar{1}}$ is illustrated by the fact that the B^2 term depicted by the small string distortion, the $\bar{\psi}D\psi$ terms depicted by the motion of the end quarks, and the E^2 (corresponding to the weighted string length) all appear twice.

FIG. 6. The triangular inequalities and relevant vectors for the comparison of the potential energies in the strong coupling limit of the baryonic Y configuration and mesonic subsystems.

FIG. 7. Some matrix elements $\langle \text{configuration}' | H_{\text{QCD}} | \text{configuration} \rangle$ on a small 3×3 dimensional lattice. The upper entry in each box is the matrix element with $\mu \simeq 1/a$ the lattice energy scale. The lower entry indicates the terms in the Hamiltonian contributing to this particular matrix element.

FIG. 8. Configurations in the generalized baryonic wave functional which still allow separation into three mesonic subsystems.

FIG. 9. Flavor connected (a) and flavor disconnected (b) contraction contributing to two-point correlation functions of quark bilinears.

FIG. 10. The focusing effect of a parallel B field on charged particles propagating from x to y and its limited effect on propagation between regions of size Δ once $B \geq 1/\Delta^2$.

FIG. 11. (a) The unique contraction when all flavor indices are distinct. (b) An alternate contraction when we have permutable quarks in the two currents.

FIG. 12. The planar duality diagrams representing the euclidean correlations F_1, F_2 , and F_3 . For F_2 we use only the specific contraction with $u\bar{u}(s\bar{s})$ exchanged in the $\tau(T)$ channel respectively.

FIG. 13. The evolution of an initial $u\bar{d}1^-$ state on different time scales.

FIG. 14. The original Wilson loop (W), its parts W_1 and W_2 , and the reflection paths used in proving Eq. (18.3).

FIG. 15. The unique “8” pattern of contraction relevant to the $\langle K|B|\pi \rangle \geq \langle K|A|\pi \rangle$ inequality.

FIG. 16. The “eye” contraction relevant to the $\langle K^0|A|0 \rangle$ matrix element.

FIG. 17. Illustration of how as $\vec{r} \rightarrow 0$ and $u \rightarrow v$ (and the diamond-like configuration degenerates into a vertical line), we tend to get, due to the smoothness of the A_μ configuration, similar propagators, and hence a monotonic decrease of $\psi_\pi(|\vec{r}|)$ with $|\vec{r}|$.

FIG. 18. The color string network for a quadriquark with two light quarks and two heavy quarks.

FIG. 19. The color string network for a quadriquark (solid line) plus its doubled network with flux lines reversed (dashed line).

FIG. 20. (a) The color network for the putative pentaquark state with three junction points (1), (2), (3). (b) The string picture of the trial baryon + meson states obtained from that of the pentaquark by omitting the (2) - (3) string bit, and reversing the flux direction in the (2) - d_e and (3) - \bar{Q}_f sections.

FIG. 21. The three polygonal paths $\tilde{X}_1, \tilde{X}_2, \tilde{X}_3$ consisting of the overall periodic propagation of the particles at X_1, X_2, X_3 from “ t ” = $\beta = 0$ to “ t ” = β with $X_i(\beta) = X_i(0)$.

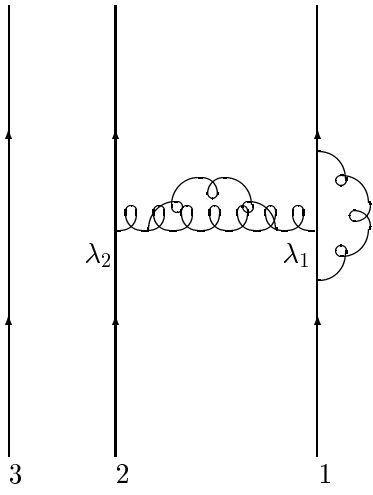

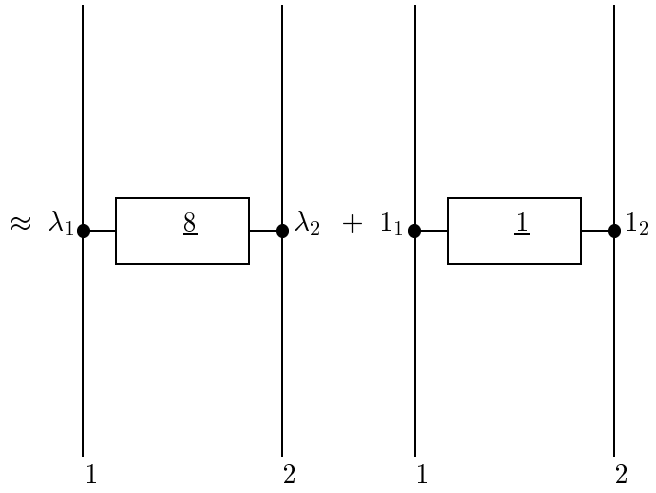
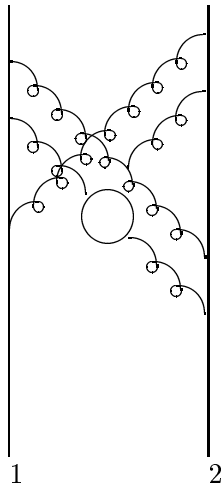

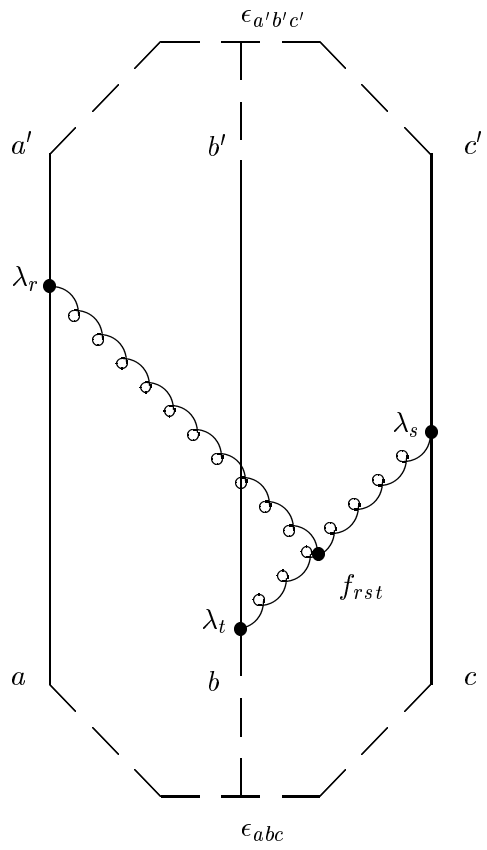

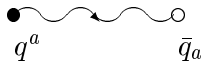

(a)

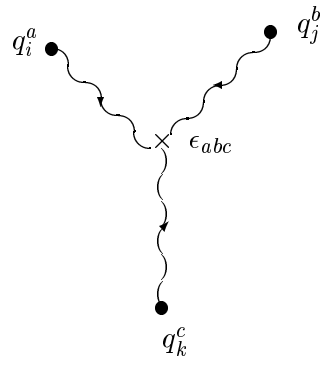

(b)

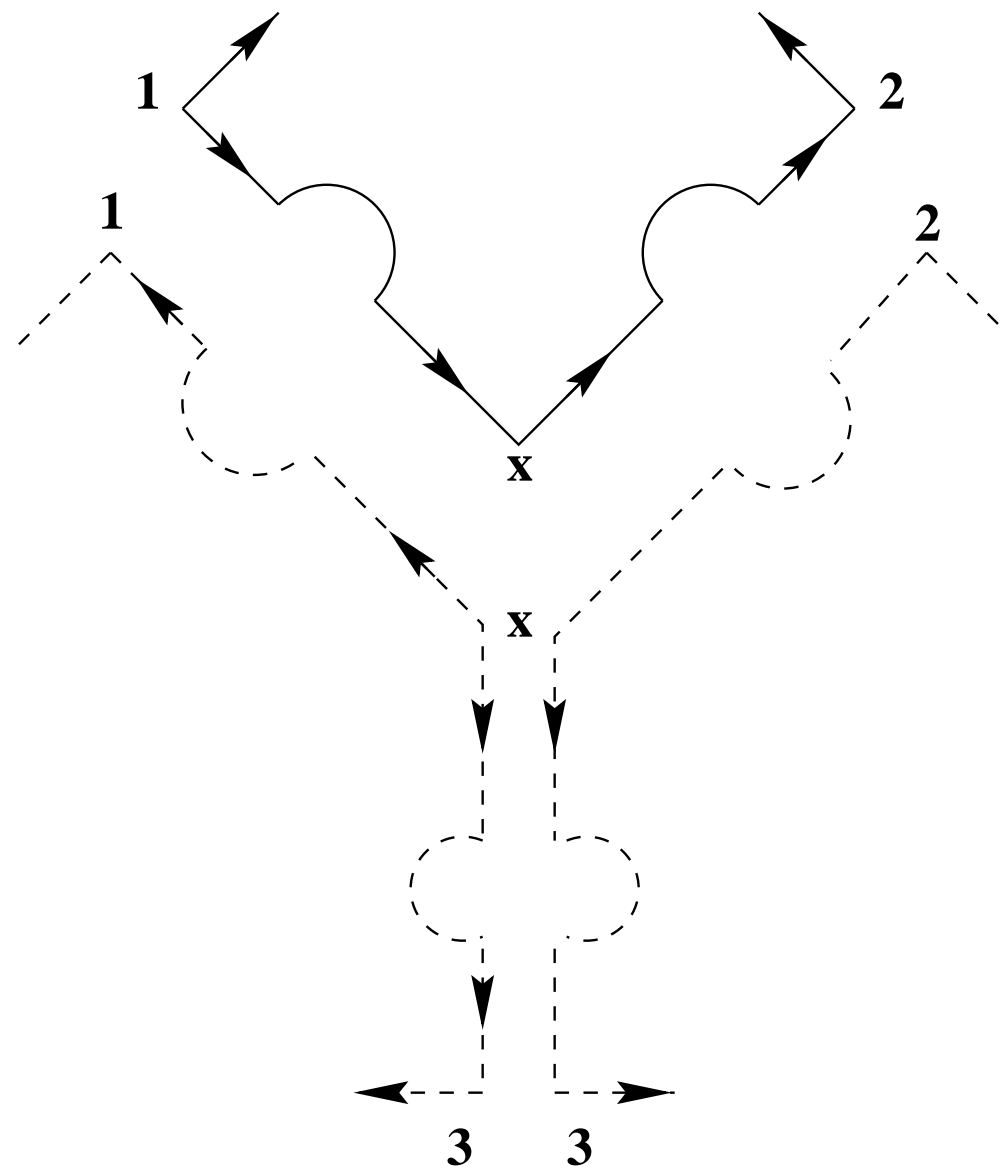
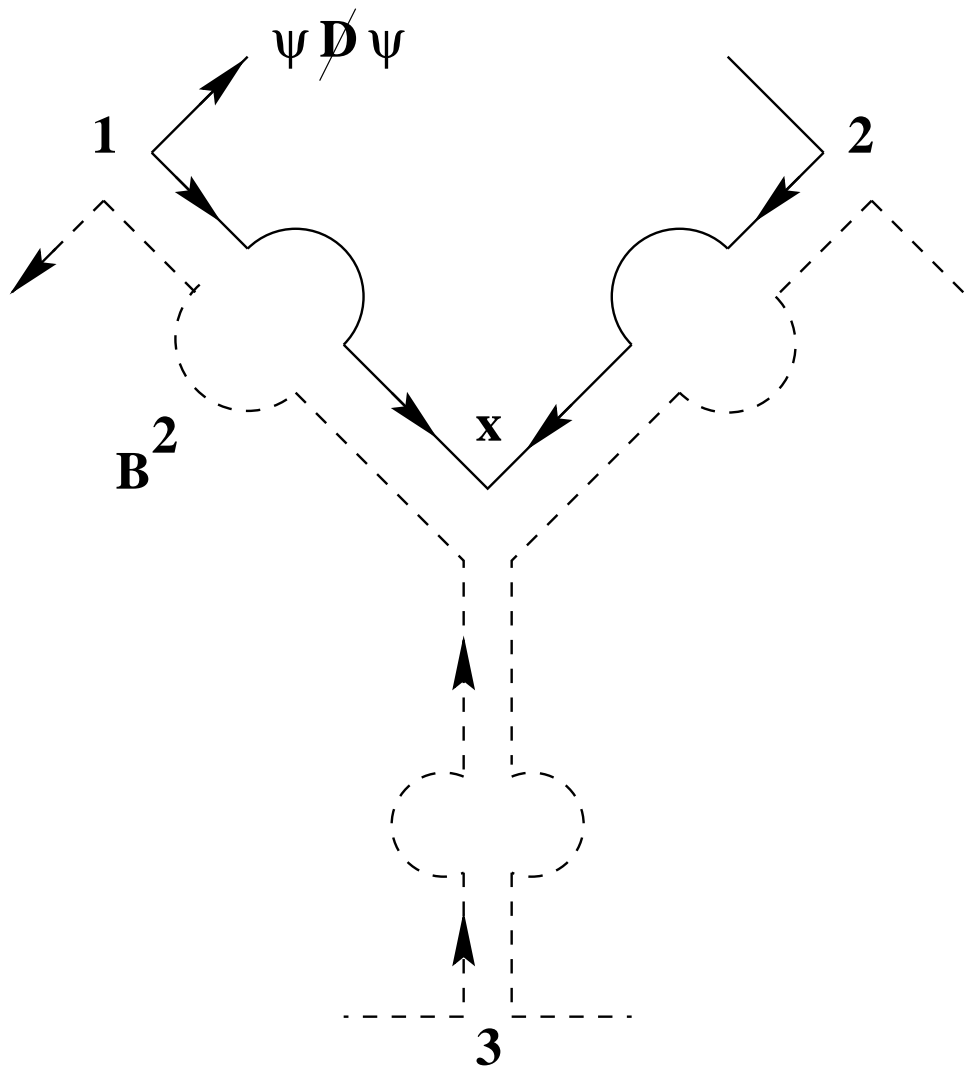

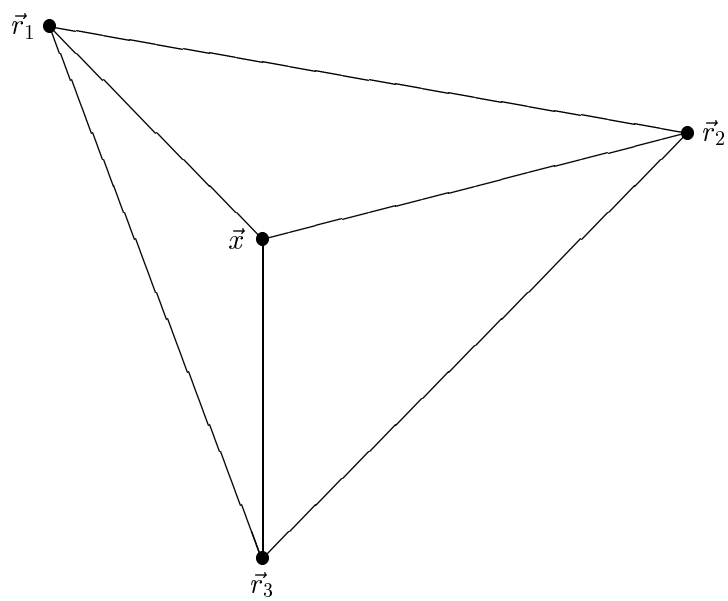

conf										
conf'			\bar{d}		u					
			$g^2\mu + m_1 + m_2$		$(1/g^2)\mu$		0			
			$E^2 + m\bar{\psi}\psi$		$(1/g^2)U^\dagger U^\dagger U U$					
			$(1/g^2)\mu$		$g^2\mu + m_1 + m_2$		$g\mu$			
			$(1/g^2)U^\dagger U^\dagger U U$		$E^2 + m\bar{\psi}\psi$		$\bar{\psi}_n U_{nn} \psi_{n+\mu}$			
			0		$g\mu$		$g^2\mu + m_1 + m_2$			
					$\bar{\psi}_n U_{nn} \psi_{n+\mu}$		$E^2 + m\bar{\psi}\psi$			

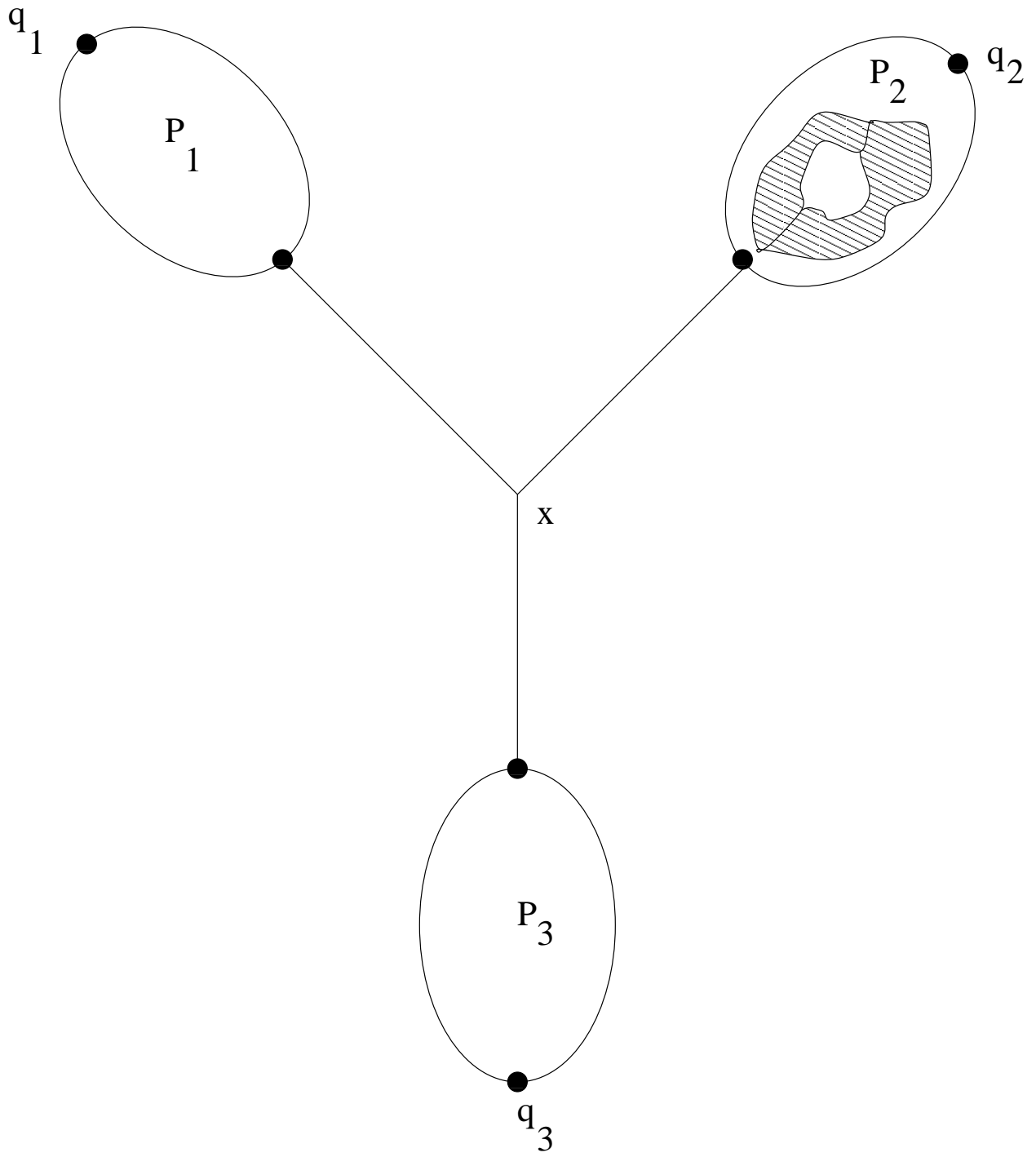

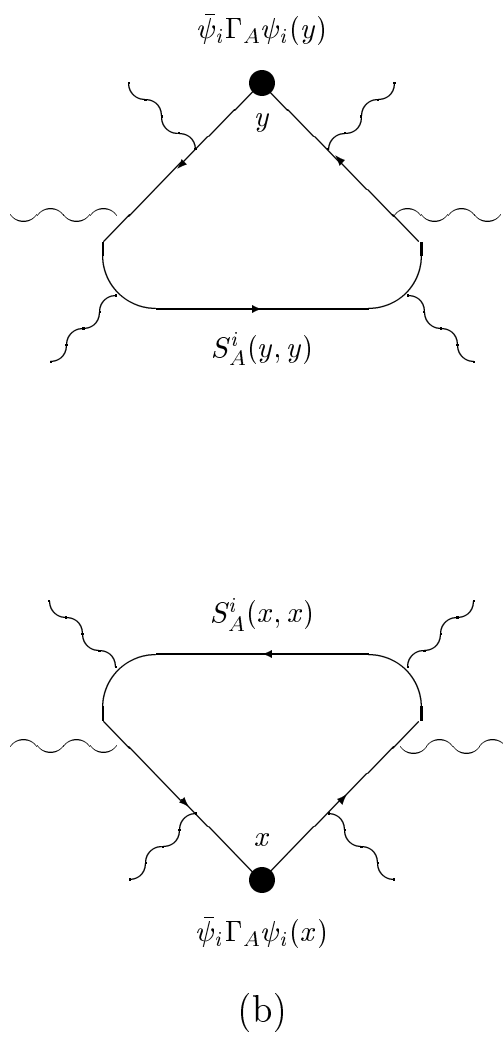
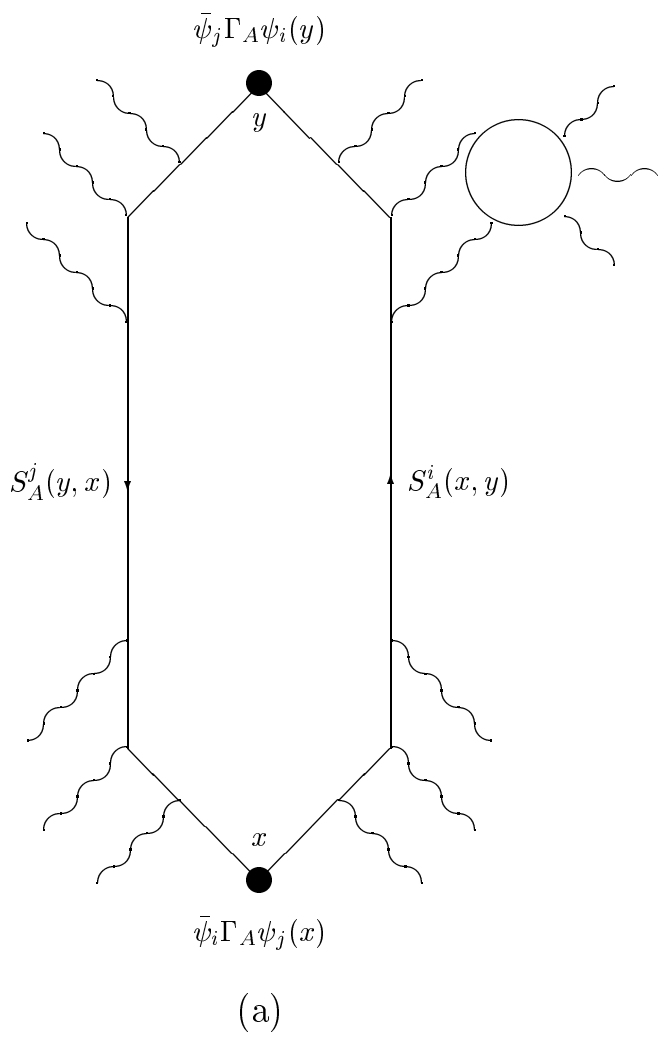

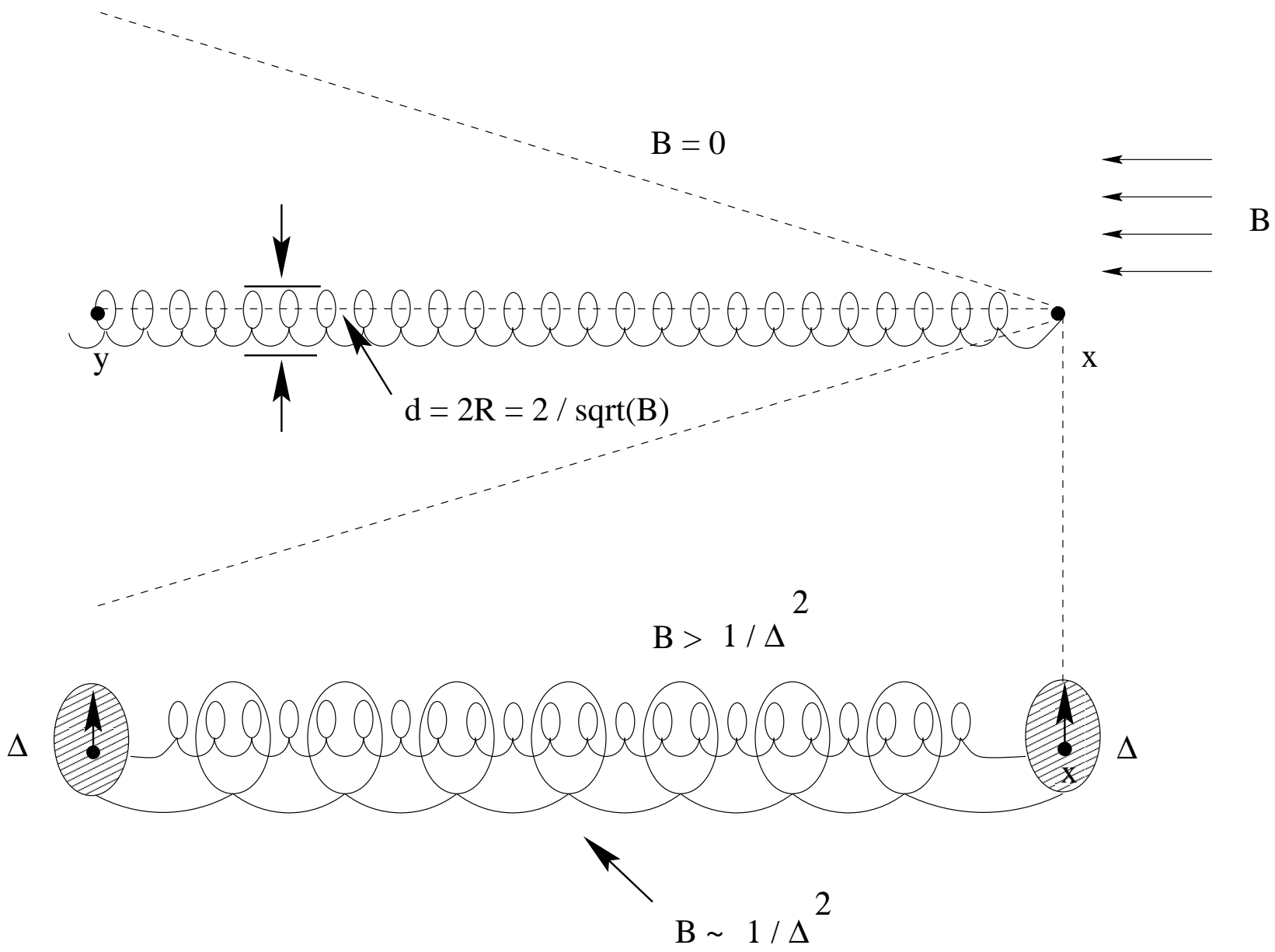

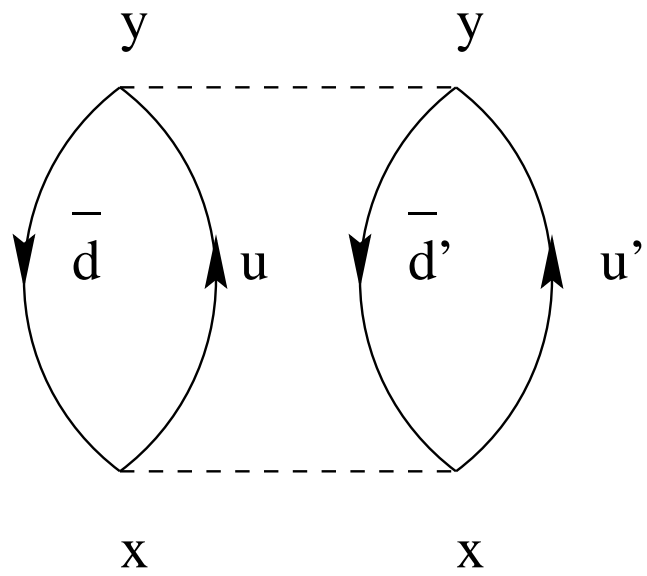

(a)

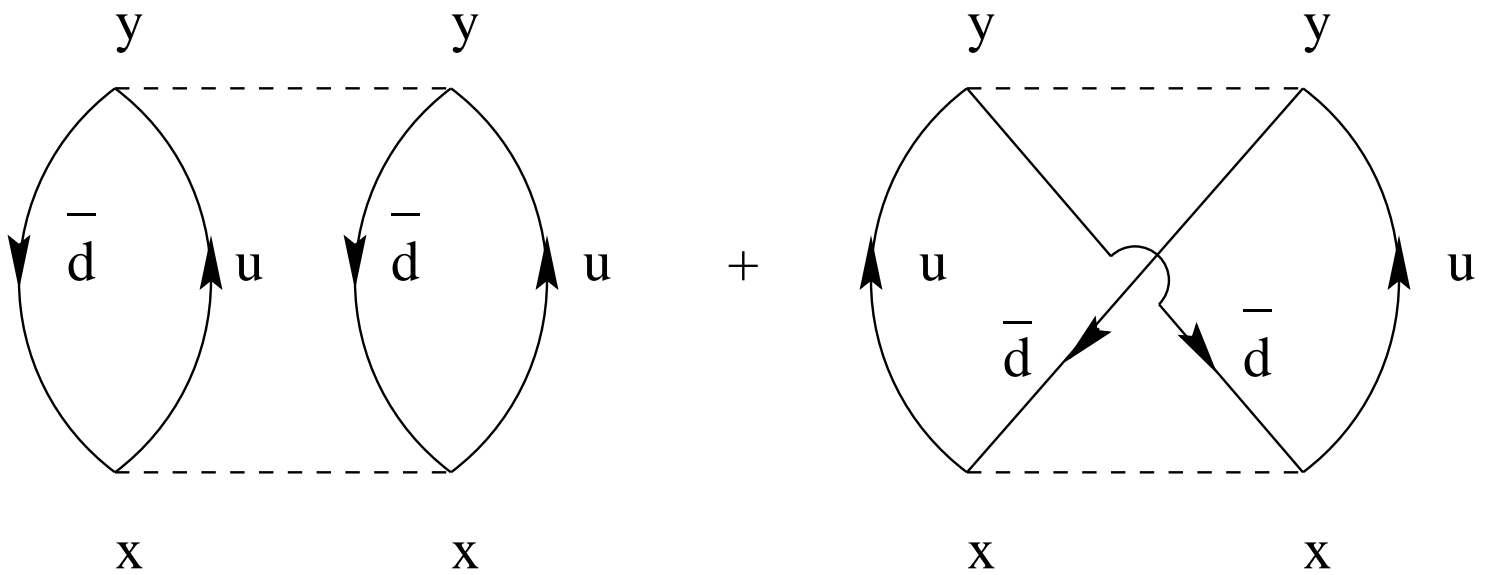

(b)

