

Quantum Field Theory

Part I: Spin Zero

Mark Srednicki

Department of Physics
University of California
Santa Barbara, CA 93106

mark@physics.ucsb.edu

This is a draft version of Part I of a three-part introductory textbook on quantum field theory.

Part I: Spin Zero

- 0) Preface
- 1) Attempts at Relativistic Quantum Mechanics (prerequisite: none)
- 2) Lorentz Invariance (prerequisite: 1)
- 3) Relativistic Quantum Fields and Canonical Quantization (2)
- 4) The Spin-Statistics Theorem (3)
- 5) The LSZ Reduction Formula (3)
- 6) Path Integrals in Quantum Mechanics (none)
- 7) The Path Integral for the Harmonic Oscillator (6)
- 8) The Path Integral for Free Field Theory (3, 7)
- 9) The Path Integral for Interacting Field Theory (8)
- 10) Scattering Amplitudes and the Feynman Rules (5, 9)
- 11) Cross Sections and Decay Rates (10)
- 12) The Lehmann-Källén Form of the Exact Propagator (9)
- 13) Dimensional Analysis with $\hbar = c = 1$ (3)
- 14) Loop Corrections to the Propagator (10, 12, 13)
- 15) The One-Loop Correction in Lehmann-Källén Form (14)
- 16) Loop Corrections to the Vertex (14)
- 17) Other 1PI Vertices (16)
- 18) Higher-Order Corrections and Renormalizability (17)
- 19) Perturbation Theory to All Orders: the Skeleton Expansion (18)
- 20) Two-Particle Elastic Scattering at One Loop (10, 19)
- 21) The Quantum Action (19)
- 22) Continuous Symmetries and Conserved Currents (8)
- 23) Discrete Symmetries: P , C , T , and Z (22)
- 24) Unstable Particles and Resonances (10, 14)
- 25) Infrared Divergences (20)
- 26) Other Renormalization Schemes (25)
- 27) Formal Development of the Renormalization Group (26)
- 28) Nonrenormalizable Theories and Effective Field Theory (26)
- 29) Spontaneous Symmetry Breaking (3)
- 30) Spontaneous Symmetry Breaking and Loop Corrections (19, 29)
- 31) Spontaneous Breakdown of Continuous Symmetries (29)
- 32) Nonabelian Symmetries (31)

0: Preface

This is a draft version of Part I of a three-part introductory textbook on quantum field theory. The book is based on a one-year course that I have taught off-and-on for the past 20 years. My goal is to present the basic concepts and formalism of QFT as simply and straightforwardly as possible, emphasizing its logical structure. To this end, I have tried to take the simplest possible example of each phenomenon, and then to work through it in great detail.

In this part, Spin Zero, the primary example is φ^3 theory in six space-time dimensions. While this theory has no apparent relevance to the real world, it has many advantages as a pedagogical case study. For example, unlike φ^4 theory, φ^3 theory has nontrivial renormalization of the propagator at one loop. In six dimensions, the φ^3 coupling is dimensionless, and asymptotically free. The theory is simple enough to allow a complete calculation of the one-loop $\varphi\varphi \rightarrow \varphi\varphi$ scattering amplitude, renormalized in an on-shell scheme. This amplitude is singular in the limit of zero particle mass, and this leads inexorably to an examination of infrared divergences, alternative renormalization schemes, and the renormalization group.

I have tried to make this book user friendly, both for students and instructors. Each of the three main parts is divided into numerous sections; each section treats a single topic or idea, and is as self-contained as possible. An equation is rarely referenced outside of the section in which it appears; if an earlier formula is needed, it is repeated. The book's table of contents includes, for each section, a list of the sections that serve as the immediate prerequisites. This allows instructors to reorder the presentation to fit individual preference, and students to access topics of interest quickly.

Eventually, there will be more problems, and solutions to most of them.

Any comments, suggestions, corections, etc, would be very welcome. Please send them to mark@physics.ucsb.edu.

Please note: *there are no references*. For thorough guides to the literature, see, for example, Weinberg's *The Quantum Theory of Fields*, Peskin & Schroeder's *Introduction to Quantum Field Theory*, or Siegel's *Fields*.

1: Attempts at relativistic quantum mechanics

In order to combine quantum mechanics and relativity, we must first understand what we mean by “quantum mechanics” and “relativity”. Let us begin with quantum mechanics.

Somewhere in most textbooks on the subject, one can find a list of the “axioms of quantum mechanics”. These include statements along the lines of

The state of the system is represented by a vector in Hilbert space.

Observables are represented by hermitian operators.

The measurement of an observable always yields one of its eigenvalues as the result.

And so on. We do not need to review these closely here. The axiom we need to focus on is the one that says that the time evolution of the state of the system is governed by the Schrödinger equation,

$$i\hbar \frac{\partial}{\partial t} |\psi, t\rangle = H |\psi, t\rangle, \quad (1)$$

where H is the hamiltonian operator, representing the total energy.

Let us consider a very simple system: a spinless, nonrelativistic particle with no forces acting on it. In this case, the hamiltonian is

$$H = \frac{1}{2m} \mathbf{P}^2, \quad (2)$$

where m is the particle’s mass, and \mathbf{P} is the momentum operator. In the position basis, eq. (1) becomes

$$i\hbar \frac{\partial}{\partial t} \psi(\mathbf{x}, t) = -\frac{\hbar^2}{2m} \nabla^2 \psi(\mathbf{x}, t), \quad (3)$$

where $\psi(\mathbf{x}, t) = \langle \mathbf{x} | \psi, t \rangle$ is the position-space wave function. We would like to generalize this to relativistic motion.

The obvious way to proceed is to take

$$H = +\sqrt{\mathbf{P}^2 c^2 + m^2 c^4}, \quad (4)$$

which gives the correct energy-momentum relation. If we formally expand this hamiltonian in inverse powers of the speed of light c , we get

$$H = mc^2 + \frac{1}{2m} \mathbf{P}^2 + \dots . \quad (5)$$

This is simply a constant (the rest energy), plus the usual nonrelativistic hamiltonian, eq. (2), plus higher-order corrections. With the hamiltonian given by eq. (4), the Schrödinger equation becomes

$$i\hbar \frac{\partial}{\partial t} \psi(\mathbf{x}, t) = +\sqrt{-\hbar^2 c^2 \nabla^2 + m^2 c^4} \psi(\mathbf{x}, t). \quad (6)$$

The square root of the differential operator looks nasty, but it is perfectly well defined in momentum space. Have we, then, succeeded in constructing a relativistic form of quantum mechanics?

To answer this, we must first examine what we mean by “relativity”. Special relativity tells us that physics *looks the same* in all *inertial frames*. To explain what *this* means, let us first suppose that a certain spacetime coordinate system (ct, \mathbf{x}) represents (by fiat) an inertial frame. Let us define $x^0 = ct$, and write x^μ , where $\mu = 0, 1, 2, 3$, in place of (ct, \mathbf{x}) . It is also convenient (for reasons not at all obvious at this point) to define $x_0 = -x^0$ and $x_i = x^i$, where $i = 1, 2, 3$. More succinctly, we can introduce the *metric of flat spacetime*,

$$g_{\mu\nu} = \begin{pmatrix} -1 & & & \\ & +1 & & \\ & & +1 & \\ & & & +1 \end{pmatrix}. \quad (7)$$

We then have $x_\mu = g_{\mu\nu} x^\nu$, where a repeated index is summed. To invert this formula, we need to introduce the inverse of g , which is confusingly also called g , except with both indices up:

$$g^{\mu\nu} = \begin{pmatrix} -1 & & & \\ & +1 & & \\ & & +1 & \\ & & & +1 \end{pmatrix}. \quad (8)$$

We then have $g^{\mu\nu}g_{\nu\rho} = \delta^{\mu}_{\rho}$, where δ^{μ}_{ρ} is the Kronecker delta (equal to one if its two indices take on the same value, zero otherwise). Now we can also write $x^{\mu} = g^{\mu\nu}x_{\nu}$. It is a general rule that, for any pair of repeated indices, one must be a superscript, and one must be a subscript. Also, unsummed indices must match (in both name and height) on the left and right sides of any valid equation.

Now we are ready to specify what we mean by an inertial frame. If the coordinates x^{μ} represent an inertial frame (which they do, by assumption), then so do any other coordinates \bar{x}^{μ} that are related by

$$\bar{x}^{\mu} = \Lambda^{\mu}_{\nu}x^{\nu} + a^{\mu} , \quad (9)$$

where Λ^{μ}_{ν} is a *Lorentz transformation matrix* and a^{μ} is a *translation vector*. Both Λ^{μ}_{ν} and a^{μ} are constant (that is, independent of x^{μ}). Furthermore, Λ^{μ}_{ν} must obey

$$g_{\mu\nu}\Lambda^{\mu}_{\rho}\Lambda^{\nu}_{\sigma} = g_{\rho\sigma} . \quad (10)$$

Eq.(10) ensures that the *invariant squared distance* between two different spacetime points that are labeled by x^{μ} and x'^{μ} in one inertial frame, and by \bar{x}^{μ} and \bar{x}'^{μ} in another, is the same. This squared distance is defined to be

$$(x - x')^2 \equiv g_{\mu\nu}(x - x')^{\mu}(x - x')^{\nu} = (\mathbf{x} - \mathbf{x}')^2 - c^2(t - t')^2 . \quad (11)$$

In the second frame, we have

$$\begin{aligned} (\bar{x} - \bar{x}')^2 &= g_{\mu\nu}(\bar{x} - \bar{x}')^{\mu}(\bar{x} - \bar{x}')^{\nu} \\ &= g_{\mu\nu}\Lambda^{\mu}_{\rho}\Lambda^{\nu}_{\sigma}(x - x')^{\rho}(x - x')^{\sigma} \\ &= g_{\rho\sigma}(x - x')^{\rho}(x - x')^{\sigma} \\ &= (x - x')^2 , \end{aligned} \quad (12)$$

as desired.

When we say that *physics looks the same*, we mean that two observers (Alice and Bob, say) using two different sets of coordinates (representing two different inertial frames) should agree on the predicted results of all possible experiments. In the case of quantum mechanics, this requires Alice and Bob to agree on the value of the wave function at a particular spacetime point,

a point which is called x by Alice and \bar{x} by Bob. Thus if Alice's predicted wave function is $\psi(x)$, and Bob's is $\bar{\psi}(\bar{x})$, then $\psi(x) = \bar{\psi}(\bar{x})$. Therefore, the two functions $\psi(x)$ and $\bar{\psi}(\bar{x})$ are related by

$$\bar{\psi}(x) = \psi(\Lambda^{-1}(x - a)) , \quad (13)$$

where $(\Lambda^{-1})^\mu{}_\nu = \Lambda_\nu{}^\mu$. [This formula for Λ^{-1} follows from eq. (10); see section 2.] Furthermore, in order to maintain $\psi(x) = \bar{\psi}(\bar{x})$ throughout spacetime, $\psi(x)$ and $\bar{\psi}(\bar{x})$ must obey the *same* equation of motion.

Let us see if this is true of our candidate Schrödinger equation for relativistic quantum mechanics, eq. (6). First let us define some useful notation for spacetime derivatives:

$$\partial_\mu \equiv \frac{\partial}{\partial x^\mu} = \left(+\frac{1}{c} \frac{\partial}{\partial t}, \nabla \right) , \quad (14)$$

$$\partial^\mu \equiv \frac{\partial}{\partial x_\mu} = \left(-\frac{1}{c} \frac{\partial}{\partial t}, \nabla \right) . \quad (15)$$

Note that $\partial^\mu x^\nu = g^{\mu\nu}$, so that our matching-index-height rule is satisfied. Also, $\bar{\partial}^\mu = \Lambda^\mu{}_\nu \partial^\nu$, which means that ∂^μ transforms in the same way as x^μ . To verify this, note that

$$g^{\rho\sigma} = \bar{\partial}^\rho \bar{x}^\sigma = (\Lambda^\rho{}_\mu \partial^\mu)(\Lambda^\sigma{}_\nu x^\nu + a^\sigma) = \Lambda^\rho{}_\mu \Lambda^\sigma{}_\nu (\partial^\mu x^\nu) = \Lambda^\rho{}_\mu \Lambda^\sigma{}_\nu g^{\mu\nu} , \quad (16)$$

and that $g^{\rho\sigma} = \Lambda^\rho{}_\mu \Lambda^\sigma{}_\nu g^{\mu\nu}$ is just another form of eq. (10) [again, see section 2].

Rewriting eq. (6) in this notation yields

$$i\hbar c \partial_0 \psi(x) = +\sqrt{-\hbar^2 c^2 \sum_{i=1}^3 \partial_i^2 + m^2 c^4} \psi(x) . \quad (17)$$

We should also have

$$i\hbar c \bar{\partial}_0 \bar{\psi}(\bar{x}) = +\sqrt{-\hbar^2 c^2 \sum_{i=1}^3 \bar{\partial}_i^2 + m^2 c^4} \bar{\psi}(\bar{x}) . \quad (18)$$

Now replace $\bar{\psi}(\bar{x})$ with $\psi(x)$, and use $\bar{\partial}_\mu = \Lambda_\mu{}^\nu \partial_\nu$ to get

$$i\hbar c \Lambda_0{}^\nu \partial_\nu \psi(x) = +\sqrt{-\hbar^2 c^2 \sum_{i=1}^3 (\Lambda_i{}^\nu \partial_\nu)^2 + m^2 c^4} \psi(x) . \quad (19)$$

It is obvious that eq. (19) does not have the same form as eq. (17). There is a *preferred frame* where the derivative that is not under the square-root sign is purely a time derivative. In any other inertial frame, it is a linear combination of time and space derivatives. Thus, our candidate Schrödinger equation is *not* consistent with relativity.

So, let's try something else: square the differential operators on each side of eq. (17) before applying them to the wave function. Then we get

$$-\hbar^2 c^2 \partial_0^2 \psi(x) = (-\hbar^2 c^2 \nabla^2 + m^2 c^4) \psi(x) . \quad (20)$$

After rearranging and identifying $\partial^2 \equiv \partial^\mu \partial_\mu = -\partial_0^2 + \nabla^2$,

$$(-\partial^2 + m^2 c^2 / \hbar^2) \psi(x) = 0 . \quad (21)$$

This is the *Klein-Gordon equation*.

To see if it is consistent with relativity, start with Bob's version of the equation, $(-\bar{\partial}^2 + m^2 c^2 / \hbar^2) \bar{\psi}(\bar{x})$. Replace $\bar{\psi}(\bar{x})$ with $\psi(x)$, and note that

$$\bar{\partial}^2 = g_{\mu\nu} \bar{\partial}^\mu \bar{\partial}^\nu = g_{\mu\nu} \Lambda^\mu{}_\rho \Lambda^\nu{}_\sigma \partial^\rho \partial^\sigma = \partial^2 . \quad (22)$$

Thus, we get eq. (21) back again! This means that the Klein-Gordon equation *is* consistent with relativity: it takes the same form in every inertial frame.

This is the good news. The bad news is that we have violated one of the axioms of quantum mechanics: eq. (1), the Schrödinger equation in its abstract form. The abstract Schrödinger equation has the fundamental property of being first order in the time derivative, whereas the Klein-Gordon equation is second order. This may not seem too important, but in fact it has drastic consequences. One of these is that the norm of a state,

$$\langle \psi, t | \psi, t \rangle = \int d^3x \langle \psi, t | \mathbf{x} \rangle \langle \mathbf{x} | \psi, t \rangle = \int d^3x \psi^*(x) \psi(x), \quad (23)$$

is not in general time independent. Thus probability is not conserved. The Klein-Gordon equation obeys relativity, but not quantum mechanics.

Dirac attempted to solve this problem (for spin-one-half particles) by introducing an extra discrete label on the wave function, to account for spin: $\psi_a(x)$, $a = 1, 2$. He then tried a Schrödinger equation of the form

$$i\hbar \frac{\partial}{\partial t} \psi_a(x) = \left(-i\hbar c (\alpha^j)_{ab} \partial_j + mc^2 (\beta)_{ab} \right) \psi_b(x) , \quad (24)$$

where all repeated indices are summed, and α^j and β are matrices in spin-space. This equation, the *Dirac equation*, is linear in both time *and* space derivatives, and so has a chance to obey the rules of both quantum mechanics and relativity. In fact, it manifestly obeys the rules of quantum mechanics, and so the norm $\sum_{a=1,2} \int d^3x |\psi_a(x)|^2$ is time independent, as it should be. To gain some understanding of its properties under Lorentz transformations, let us consider the hamiltonian it specifies,

$$H_{ab} = cP_j(\alpha^j)_{ab} + mc^2(\beta)_{ab} , \quad (25)$$

where P_j is a component of the momentum operator. If we square this hamiltonian, we get

$$(H^2)_{ab} = c^2 P_j P_k (\alpha^j \alpha^k)_{ab} + mc^3 P_j (\alpha^j \beta + \beta \alpha^j)_{ab} + (mc^2)^2 (\beta^2)_{ab} . \quad (26)$$

Since $P_j P_k$ is symmetric on exchange of j and k , we can replace $\alpha^j \alpha^k$ by its symmetric part, $\frac{1}{2}\{\alpha^j, \alpha^k\}$, where $\{A, B\} = AB + BA$ is the anticommutator. Then, if we choose matrices such that

$$\{\alpha^j, \alpha^k\}_{ab} = 2\delta^{jk}\delta_{ab} , \quad \{\alpha^j, \beta\}_{ab} = 0 , \quad (\beta^2)_{ab} = \delta_{ab} , \quad (27)$$

we will get

$$(H^2)_{ab} = (\mathbf{P}^2 c^2 + m^2 c^4) \delta_{ab} . \quad (28)$$

Thus, the eigenstates of H^2 are momentum eigenstates, with H^2 eigenvalue $\mathbf{p}^2 c^2 + m^2 c^4$. This is, of course, the correct relativistic energy-momentum relation. While it is outside the scope of this section to demonstrate it, it turns out that the Dirac equation is fully consistent with relativity provided the Dirac matrices obey eq. (27). So we have succeeded in constructing a quantum mechanical, relativistic theory!

There are, however, some problems. First, the Dirac matrices must be at least 4×4 , and not 2×2 as we would like (in order to account for electron spin). To see this, note that the 2×2 Pauli matrices obey $\{\sigma^i, \sigma^j\} = 2\delta^{ij}$, and are thus candidates for the Dirac α^i matrices. However, there is no fourth matrix that anticommutes with these three (easily proven by writing down the most general 2×2 matrix and working out the three anticommutators explicitly). Also, the Dirac matrices must be even dimensional. To see this,

first define the matrix $\gamma \equiv \beta\alpha^1\alpha^2\alpha^3$. This matrix obeys $\gamma^2 = 1$ and also $\{\gamma, \alpha^i\} = \{\gamma, \beta\} = 0$. Hence, using the cyclic property of matrix traces on $\gamma\beta\gamma$, we have $\text{Tr } \gamma\beta\gamma = \text{Tr } \gamma^2\beta = \text{Tr } \beta$. On the other hand, using $\beta\gamma = -\gamma\beta$, we also have $\text{Tr } \gamma\beta\gamma = -\text{Tr } \gamma^2\beta = -\text{Tr } \beta$. Thus, $\text{Tr } \beta$ is equal to minus itself, and hence must be zero. (Similarly, we can show $\text{Tr } \alpha^i = 0$.) Also, $\beta^2 = 1$ implies that the eigenvalues of β are all ± 1 . Because β has zero trace, these eigenvalues must sum to zero, and hence the dimension of the matrix must be even. Thus the Dirac matrices must be at least 4×4 , and it remains for us to interpret the two extra possible “spin” states.

However, these extra states cause a more severe problem than a mere overcounting. Acting on a momentum eigenstate, H becomes the matrix $c\boldsymbol{\alpha} \cdot \mathbf{p} + mc^2\beta$. The trace of this matrix is zero. Thus the four eigenvalues must be $+E(\mathbf{p}), +E(\mathbf{p}), -E(\mathbf{p}), -E(\mathbf{p})$, where $E(\mathbf{p}) = +(\mathbf{p}^2c^2 + m^2c^4)^{1/2}$. The negative eigenvalues are the problem: they indicate that there is no ground state. In a more elaborate theory that included interactions with photons, there seems to be no reason why a positive energy electron could not emit a photon and drop down into a negative energy state. This downward cascade could continue forever. (The same problem also arises in attempts to interpret the Klein-Gordon equation as a modified form of quantum mechanics.)

Dirac made a wildly brilliant attempt to fix this problem of negative energy states. His solution is based on an empirical fact about electrons: they obey the Pauli exclusion principle. It is impossible to put more than one of them in the same quantum state. What if, Dirac speculated, all the negative energy states were *already occupied*? In this case, a positive energy electron could not drop into one of these states, by Pauli exclusion!

Many questions immediately arise. Why don't we see the negative electric charge of this *Dirac sea* of electrons? Dirac's answer: because we're used to it. (More precisely, the physical effects of a uniform charge density depend on the boundary conditions at infinity that we impose on Maxwell's equations, and there is a choice that renders such a uniform charge density invisible.) However, Dirac noted, if one of these negative energy electrons were excited into a positive energy state (by, say, a sufficiently energetic photon), it would leave behind a *hole* in the sea of negative energy electrons. This hole would

appear to have positive charge, and positive energy. Dirac therefore predicted (in 1927) the existence of the *positron*, a particle with the same mass as the electron, but opposite charge. The positron was found experimentally five years later.

However, we have now jumped from an attempt at a quantum description of a *single* relativistic particle to a theory that apparently requires an *infinite* number of particles. Even if we accept this, we still have not solved the problem of how to describe particles like photons or pions or alpha nuclei that do *not* obey Pauli exclusion.

At this point, it is worthwhile to stop and reflect on why it has proven to be so hard to find an acceptable relativistic wave equation for a single quantum particle. Perhaps there is something wrong with our basic approach.

And there is. Recall the axiom of quantum mechanics that says that “Observables are represented by hermitian operators.” This is not entirely true. There is one observable in quantum mechanics that is *not* represented by a hermitian operator: time. Time enters into quantum mechanics only when we announce that the “state of the system” depends on an extra parameter t . This parameter is not the eigenvalue of any operator. This is in sharp contrast to the particle’s position \mathbf{x} , which *is* the eigenvalue of an operator. Thus, space and time are treated very differently, a fact that is obscured by writing the Schrödinger equation in terms of the position-space wave function $\psi(\mathbf{x}, t)$. Since space and time are treated asymmetrically, it is not surprising that we are having trouble incorporating a symmetry which mixes them up.

So, what are we to do?

In principle, the problem could be an intractable one: it might be *impossible* to combine quantum mechanics and relativity. In this case, there would have to be some meta-theory, one that reduces in the nonrelativistic limit to quantum mechanics, and in the classical limit to relativistic particle dynamics, but is actually neither.

This, however, turns out not to be the case. We can solve our problem, but we must put space and time on an equal footing at the outset. There are two ways to do this. One is to demote position from its status as an operator, and render it as an extra label, like time. The other is to promote

time to an operator.

Let us discuss the second option first. If time becomes an operator, what replaces the Schrödinger equation? Luckily, in relativistic theories, there are plenty of times lying around. We can use the *proper time* τ of the particle (or, more technically, any affine parameter along its worldline) as the “extra” parameter, while promoting coordinate time T to an operator. In the Heisenberg picture (where the state of the system is fixed, but the operators are functions of time that obey the classical equations of motion), we would have operators $X^\mu(\tau)$, where $X^0 = T$. Relativistic quantum mechanics can indeed be developed along these lines, but it is surprisingly complicated to do so. (The many times are the problem; any monotonic function of τ is just as good a candidate as τ itself for the proper time, and this infinite redundancy of descriptions must be understood and accounted for.)

One of the advantages of considering different formalisms is that they may suggest different directions for generalizations. For example, once we have $X^\mu(\tau)$, why not consider adding some more parameters? Then we would have, for example, $X^\mu(\sigma, \tau)$. Classically, this would give us a continuous family of worldlines, what we might call a *worldsheet*, and so $X^\mu(\sigma, \tau)$ would describe a propagating *string*. This is indeed the starting point for string theory.

Thus, promoting time to an operator is a viable option, but is complicated in practice. Let us then turn to the other option, demoting position to a label. The first question is, label on what? The answer is, *on operators*. Thus, consider assigning an operator to each point \mathbf{x} in space; call these operators $\varphi(\mathbf{x})$. A set of operators like this is called a *quantum field*. In the Heisenberg picture, the operators are also time dependent:

$$\varphi(\mathbf{x}, t) = e^{iHt/\hbar} \varphi(\mathbf{x}, 0) e^{-iHt/\hbar}. \quad (29)$$

Thus, both position and (in the Heisenberg picture) time are now labels on operators; neither is itself the eigenvalue of an operator.

So, now we have two different approaches to relativistic quantum theory, approaches that might, in principle, yield different results. This, however, is not the case: it turns out that any relativistic quantum physics that can be treated in one formalism can also be treated in the other. Which we use is a

matter of convenience and taste. And, *quantum field theory*, the formalism in which position and time are both labels on operators, is by far the more convenient and efficient. (For particles, anyway; for strings, the opposite seems to be true, at least as of this writing.)

There is another useful equivalence: ordinary nonrelativistic quantum mechanics, for a fixed number of particles, can be rewritten as a quantum field theory. This is an informative exercise, since the corresponding physics is already familiar. Let us carry it out.

Begin with the position-basis Schrödinger equation for n particles, all with the same mass m , moving in an external potential $U(\mathbf{x})$, and interacting with each other via an interparticle potential $V(\mathbf{x}_1 - \mathbf{x}_2)$:

$$i\hbar \frac{\partial}{\partial t} \psi = \left[\sum_{j=1}^n \left(-\frac{\hbar^2}{2m} \nabla_j^2 + U(\mathbf{x}_j) \right) + \sum_{j=1}^n \sum_{k=1}^{j-1} V(\mathbf{x}_j - \mathbf{x}_k) \right] \psi, \quad (30)$$

where $\psi = \psi(\mathbf{x}_1, \dots, \mathbf{x}_n; t)$ is the position-space wave function. The quantum mechanics of this system can be rewritten in the abstract form of eq. (1) by first introducing (in, for now, the Schrödinger picture) a quantum field $a(\mathbf{x})$ and its hermitian conjugate $a^\dagger(\mathbf{x})$. We take these operators to have the commutation relations

$$[a(\mathbf{x}), a(\mathbf{x}')] = 0, \quad [a^\dagger(\mathbf{x}), a^\dagger(\mathbf{x}')] = 0, \quad [a(\mathbf{x}), a^\dagger(\mathbf{x}')] = \delta^3(\mathbf{x} - \mathbf{x}'), \quad (31)$$

where $\delta^3(\mathbf{x})$ is the three-dimensional Dirac delta function. Thus, $a^\dagger(\mathbf{x})$ and $a(\mathbf{x})$ behave like harmonic-oscillator creation and annihilation operators that are labeled by a continuous index. In terms of them, we introduce the hamiltonian operator of our quantum field theory,

$$H = \int d^3x a^\dagger(\mathbf{x}) \left(-\frac{\hbar^2}{2m} \nabla^2 + U(\mathbf{x}) \right) a(\mathbf{x}) + \frac{1}{2} \int d^3x d^3y V(\mathbf{x} - \mathbf{y}) a^\dagger(\mathbf{x}) a^\dagger(\mathbf{y}) a(\mathbf{y}) a(\mathbf{x}). \quad (32)$$

Now consider a time-dependent state of the form

$$|\psi, t\rangle = \int d^3x_1 \dots d^3x_n \psi(\mathbf{x}_1, \dots, \mathbf{x}_n; t) a^\dagger(\mathbf{x}_1) \dots a^\dagger(\mathbf{x}_n) |0\rangle, \quad (33)$$

where $\psi(\mathbf{x}_1, \dots, \mathbf{x}_n; t)$ is some function of the n particle positions and time, and $|0\rangle$ is the *vacuum state*, the state that is annihilated by all the a 's:

$a(\mathbf{x})|0\rangle = 0$. It is now straightforward (though tedious) to verify that the abstract Schrödinger equation, eq. (1), is obeyed if and only if the function ψ satisfies eq. (30).

Thus we can interpret the state $|0\rangle$ as a state of “no particles”, the state $a^\dagger(\mathbf{x}_1)|0\rangle$ as a state with one particle at position \mathbf{x}_1 , the state $a^\dagger(\mathbf{x}_1)a^\dagger(\mathbf{x}_2)|0\rangle$ as a state with one particle at position \mathbf{x}_1 and another at position \mathbf{x}_2 , and so on. The operator

$$N = \int d^3x a^\dagger(\mathbf{x})a(\mathbf{x}) \quad (34)$$

counts the total number of particles. It commutes with the hamiltonian, as is easily checked; thus, if we start with a state of n particles, we remain with a state of n particles at all times.

However, we can imagine generalizations of this version of the theory (generalizations that would not be possible without the field formalism) in which the number of particles is *not* conserved. For example, we could try adding to H a term like

$$\Delta H \propto \int d^3x [a^\dagger(\mathbf{x})a^2(\mathbf{x}) + \text{h.c.}] . \quad (35)$$

This term does *not* commute with N , and so the number of particles would not be conserved with this addition to H .

Theories in which the number of particles can change as time evolves are a good thing: they are needed for correct phenomenology. We are already familiar with the notion that atoms and molecules can emit and absorb photons, and so we had better have a formalism that can incorporate this phenomenon. We are less familiar with emission and absorption (that is to say, creation and annihilation) of electrons, but this process also occurs in nature; it is less common because it must be accompanied by the emission or absorption of a positron, antiparticle to the electron. There are not a lot of positrons around to facilitate electron annihilation, while e^+e^- pair creation requires us to have on hand at least $2mc^2$ of energy available for the rest-mass energy of these two particles. The photon, on the other hand, is its own antiparticle, and has zero rest mass; thus photons are easily and copiously produced and destroyed.

There is another important aspect of the quantum theory specified by eqs. (32) and (33). Because the creation operators commute with each other,

only the completely symmetric part of ψ survives the integration in eq. (33). Therefore, without loss of generality, we can restrict our attention to ψ 's of this type:

$$\psi(\dots \mathbf{x}_i \dots \mathbf{x}_j \dots; t) = +\psi(\dots \mathbf{x}_j \dots \mathbf{x}_i \dots; t) . \quad (36)$$

This means that we have a theory of *bosons*, particles that (like photons or pions or alpha nuclei) obey Bose-Einstein statistics. If we want Fermi-Dirac statistics instead, we must replace eq. (31) with

$$\{a(\mathbf{x}), a(\mathbf{x}')\} = 0 , \quad \{a^\dagger(\mathbf{x}), a^\dagger(\mathbf{x}')\} = 0 , \quad \{a(\mathbf{x}), a^\dagger(\mathbf{x}')\} = \delta^3(\mathbf{x} - \mathbf{x}') , \quad (37)$$

where again $\{A, B\} = AB + BA$ is the anticommutator. Now only the fully antisymmetric part of ψ survives the integration in eq. (33), and so we can restrict our attention to

$$\psi(\dots \mathbf{x}_i \dots \mathbf{x}_j \dots; t) = -\psi(\dots \mathbf{x}_j \dots \mathbf{x}_i \dots; t) . \quad (38)$$

Thus we have a theory of *fermions*. It is straightforward to check that the abstract Schrödinger equation, eq. (1), still implies that ψ obeys the differential equation (30). [Now, however, the ordering of the last two a operators in the last term of H , eq. (32), becomes important, and it must be as written.] Interestingly, there is no simple way to write down a quantum field theory with particles that obey Boltzmann statistics, corresponding to a wave function with no particular symmetry. This is a hint of the *spin-statistics* theorem, which applies to *relativistic* quantum field theory. It says that *interacting* particles with integer spin must be bosons, and *interacting* particles with half-integer spin must be fermions. In our *nonrelativistic* example, the interacting particles clearly have spin zero (because their creation operators carry no labels that could be interpreted as corresponding to different spin states), but can be either bosons or fermions, as we have seen.

Now that we have seen how to rewrite the nonrelativistic quantum mechanics of multiple bosons or fermions as a quantum field theory, it is time to try to construct a relativistic version.

Problems

1.1) Show that the state defined in eq. (33) obeys the abstract Schrödinger equation, eq. (1), with the hamiltonian of eq. (32), if and only if the wave function obeys eq. (30). Your demonstration should apply both to the case of bosons, where the particle creation and annihilation operators obey the commutation relations of eq. (31), and to fermions, where the particle creation and annihilation operators obey the anticommutation relations of eq. (37).

1.2) Show explicitly that $[N, H] = 0$, where H is given by eq. (32) and N by eq. (34).

2: Lorentz Invariance

Prerequisite: 1

A *Lorentz transformation* is a linear, homogeneous change of coordinates from x^μ to \bar{x}^μ ,

$$\bar{x}^\mu = \Lambda^\mu{}_\nu x^\nu, \quad (39)$$

that preserves the *invariant squared distance* from the origin, $x^2 = x^\mu x_\mu = g_{\mu\nu} x^\mu x^\nu = \mathbf{x}^2 - t^2$; this means that the matrix $\Lambda^\mu{}_\nu$ must obey

$$g_{\mu\nu} \Lambda^\mu{}_\rho \Lambda^\nu{}_\sigma = g_{\rho\sigma}, \quad (40)$$

where

$$g_{\mu\nu} = \begin{pmatrix} -1 & & & \\ & +1 & & \\ & & +1 & \\ & & & +1 \end{pmatrix}. \quad (41)$$

is the flat-space metric.

Note that this set of transformations includes ordinary spatial rotations: take $\Lambda^0{}_0 = 1$, $\Lambda^0{}_i = \Lambda^i{}_0 = 0$, and $\Lambda^i{}_j = R_{ij}$, where R is an orthogonal rotation matrix.

The set of all Lorentz transformations [that is, matrices obeying eq. (40)] forms a *group*: the product of any two Lorentz transformations is another Lorentz transformation, the product is associative, and every Lorentz transformation has an inverse. It is easy to demonstrate these statements explicitly. For example, to find the inverse transformation $(\Lambda^{-1})^\mu{}_\nu$, note that the left-hand side of eq. (40) can be written as $\Lambda_{\nu\rho} \Lambda^\nu{}_\sigma$, and that we can raise the ρ index on both sides to get $\Lambda_{\nu}{}^\rho \Lambda^\nu{}_\sigma = \delta^\rho{}_\sigma$. On the other hand, by definition, $(\Lambda^{-1})^\rho{}_\nu \Lambda^\nu{}_\sigma = \delta^\rho{}_\sigma$. Therefore

$$(\Lambda^{-1})^\rho{}_\nu = \Lambda_{\nu}{}^\rho. \quad (42)$$

Another useful version of eq. (40) is

$$g^{\mu\nu} \Lambda^\rho{}_\mu \Lambda^\sigma{}_\nu = g^{\rho\sigma} . \quad (43)$$

To get this, start with eq. (40), but with the inverse transformations $(\Lambda^{-1})^\mu{}_\rho$ and $(\Lambda^{-1})^\nu{}_\sigma$. Then use eq. (42), raise all down indices, and lower all up indices. The result is eq. (43).

For an infinitesimal Lorentz transformation, we can write

$$\Lambda^\mu{}_\nu = \delta^\mu{}_\nu + \delta\omega^\mu{}_\nu . \quad (44)$$

Eq. (40) can be used to show that $\delta\omega$ with both indices down (or up) is antisymmetric:

$$\delta\omega_{\rho\sigma} = -\delta\omega_{\sigma\rho} . \quad (45)$$

Thus there are six independent infinitesimal Lorentz transformations (in four spacetime dimensions). These can be divided into three rotations ($\delta\omega_{ij} = -\varepsilon_{ijk} \hat{n}_k \delta\theta$ for a rotation by angle $\delta\theta$ about the unit vector $\hat{\mathbf{n}}$) and three boosts ($\delta\omega_{i0} = \hat{n}_i \delta\eta$ for a boost in the direction $\hat{\mathbf{n}}$ by *rapidity* $\delta\eta$).

Not all Lorentz transformations can be reached by compounding infinitesimal ones. If we take the determinant of eq. (42), we get $(\det \Lambda)^{-1} = \det \Lambda$, which implies $\det \Lambda = \pm 1$. Transformations with $\det \Lambda = +1$ are *proper*, and transformations with $\det \Lambda = -1$ are *improper*. Note that the product of any two proper Lorentz transformations is also proper. Also, infinitesimal transformations of the form $\Lambda = 1 + \delta\omega$ are proper. Therefore, any transformation that can be reached by compounding infinitesimal ones is proper. The proper transformations form a *subgroup* of the Lorentz group.

Another subgroup is that of the *orthochronous* Lorentz transformations: those for which $\Lambda^0{}_0 \geq +1$. Note that eq. (40) implies $(\Lambda^0{}_0)^2 - \Lambda^i{}_0 \Lambda^i{}_0 = 1$; thus, either $\Lambda^0{}_0 > +1$ or $\Lambda^0{}_0 < -1$. An infinitesimal transformation is clearly orthochronous, and it is straightforward to show that the product of two orthochronous transformations is also orthochronous.

Thus, the Lorentz transformations that can be reached by compounding infinitesimal ones are both proper and orthochronous, and they form a subgroup. We can introduce two discrete transformations that take us out of

this subgroup: *parity* and *time reversal*. The parity transformation is

$$\mathcal{P}^\mu{}_\nu = (\mathcal{P}^{-1})^\mu{}_\nu = \begin{pmatrix} +1 & & & \\ & -1 & & \\ & & -1 & \\ & & & -1 \end{pmatrix}. \quad (46)$$

It is orthochronous, but improper. The time-reversal transformation is

$$\mathcal{T}^\mu{}_\nu = (\mathcal{T}^{-1})^\mu{}_\nu = \begin{pmatrix} -1 & & & \\ & +1 & & \\ & & +1 & \\ & & & +1 \end{pmatrix}. \quad (47)$$

It is nonorthochronous and improper.

Generally, when a theory is said to be *Lorentz invariant*, this means under the proper orthochronous subgroup only. Parity and time reversal are treated separately. It is possible for a quantum field theory to be invariant under the proper orthochronous subgroup, but not under parity and/or time-reversal.

From here on, in this section, we will treat the proper orthochronous subgroup only. Parity and time reversal will be treated in section 23.

In quantum theory, symmetries are represented by unitary (or antiunitary) operators. This means that we associate a unitary operator $U(\Lambda)$ to each proper, orthochronous Lorentz transformation Λ . These operators must obey the composition rule

$$U(\Lambda'\Lambda) = U(\Lambda')U(\Lambda). \quad (48)$$

For an infinitesimal transformation, we can write

$$U(1+\delta\omega) = I + \frac{i}{2}\delta\omega_{\mu\nu}M^{\mu\nu}, \quad (49)$$

where $M^{\mu\nu} = -M^{\nu\mu}$ is a set of hermitian operators called the *generators of the Lorentz group*. If we start with $U(\Lambda)^{-1}U(\Lambda')U(\Lambda) = U(\Lambda^{-1}\Lambda'\Lambda)$ and let $\Lambda' = 1 + \delta\omega'$, we can show that

$$U(\Lambda)^{-1}M^{\mu\nu}U(\Lambda) = \Lambda^\mu{}_\rho\Lambda^\nu{}_\sigma M^{\rho\sigma}. \quad (50)$$

Thus, each vector index on $M^{\mu\nu}$ undergoes its own Lorentz transformation. This is a general result: any operator carrying one or more vector indices

should behave similarly. For example, consider the energy-momentum four-vector P^μ , where P^0 is the hamiltonian H and P^i are the components of the total three-momentum operator. We expect

$$U(\Lambda)^{-1}P^\mu U(\Lambda) = \Lambda^\mu{}_\nu P^\nu . \quad (51)$$

If we now let $\Lambda = 1 + \delta\omega$ in eq. (50), we get the commutation relations

$$[M^{\mu\nu}, M^{\rho\sigma}] = i(g^{\mu\rho}M^{\nu\sigma} - (\mu\leftrightarrow\nu)) - (\rho\leftrightarrow\sigma) . \quad (52)$$

We can identify the components of the angular momentum operator \mathbf{J} with $J_i \equiv \frac{1}{2}\varepsilon_{ijk}M^{jk}$, and the components of the boost operator \mathbf{K} with $K_i \equiv M^{i0}$. We then find from eq. (52) that

$$\begin{aligned} [J_i, J_j] &= +i\varepsilon_{ijk}J_k , \\ [J_i, K_j] &= +i\varepsilon_{ijk}K_k , \\ [K_i, K_j] &= -i\varepsilon_{ijk}J_k . \end{aligned} \quad (53)$$

The first of these is the usual set of commutators for angular momentum, and the second says that \mathbf{K} transforms as a three-vector under rotations. The third implies that a series of boosts can be equivalent to a rotation.

Similarly, we can let $\Lambda = 1 + \delta\omega$ in eq. (51) to get

$$[P^\mu, M^{\rho\sigma}] = i(g^{\mu\rho}P^\sigma - (\rho\leftrightarrow\sigma)) , \quad (54)$$

which becomes

$$\begin{aligned} [J_i, H] &= 0 , \\ [J_i, P_j] &= +i\varepsilon_{ijk}P_k , \\ [K_i, H] &= +iP_i , \\ [K_i, P_j] &= +i\delta_{ij}H , \end{aligned} \quad (55)$$

Also, the components of P^μ should commute with each other:

$$\begin{aligned} [P_i, P_j] &= 0 , \\ [P_i, H] &= 0 . \end{aligned} \quad (56)$$

Together, eqs. (53), (55), and (56) form the *Poincaré algebra*.

Let us now consider what should happen to a quantum scalar field $\varphi(x)$ under a Lorentz transformation. We begin by recalling how time evolution works in the Heisenberg picture:

$$e^{+iHt}\varphi(\mathbf{x}, 0)e^{-iHt} = \varphi(\mathbf{x}, t) . \quad (57)$$

Obviously, this should have a relativistic generalization,

$$e^{-iPx}\varphi(0)e^{+iPx} = \varphi(x) , \quad (58)$$

where $Px = P^\mu x_\mu = \mathbf{P}\cdot\mathbf{x} - Ht$. We can make this a little fancier by defining the unitary *spacetime translation operator*

$$T(a) \equiv \exp(-iP^\mu a_\mu) . \quad (59)$$

Then we have

$$T(a)^{-1}\varphi(x)T(a) = \varphi(x - a) . \quad (60)$$

For an infinitesimal translation,

$$T(\delta a) = I - i\delta a_\mu P^\mu . \quad (61)$$

Comparing eqs. (49) and (61), we see that eq. (60) leads us to expect

$$U(\Lambda)^{-1}\varphi(x)U(\Lambda) = \varphi(\Lambda^{-1}x) . \quad (62)$$

Derivatives of φ then carry vector indices that transform in the appropriate way, e.g.,

$$U(\Lambda)^{-1}\partial^\mu\varphi(x)U(\Lambda) = \Lambda^\mu{}_\rho\bar{\partial}^\rho\varphi(\Lambda^{-1}x) , \quad (63)$$

where the bar on a derivative means that it is with respect to the argument $\bar{x} = \Lambda^{-1}x$. Eq. (63) also implies

$$U(\Lambda)^{-1}\partial^2\varphi(x)U(\Lambda) = \bar{\partial}^2\varphi(\Lambda^{-1}x) , \quad (64)$$

so that the Klein-Gordon equation, $(-\partial^2 + m^2)\varphi = 0$, is Lorentz invariant.

Problems

- 2.1) Verify that eq. (45) follows from eq. (40).
 2.2) Verify that eq. (50) follows from $U(\Lambda)^{-1}U(\Lambda')U(\Lambda) = U(\Lambda^{-1}\Lambda'\Lambda)$.
 2.3) Verify that eq. (52) follows from eq. (50).
 2.4) Verify that eq. (53) follows from eq. (52).
 2.5) Verify that eq. (54) follows from eq. (51).
 2.6) Verify that eq. (55) follows from eq. (54).
 2.7) What property should the translation operator $T(a)$ have that could be used to prove eq. (56)?
 2.8) Let us write

$$\Lambda^\rho{}_\tau = \delta^\rho{}_\tau + \frac{i}{2}\delta\omega_{\mu\nu}(S_V^{\mu\nu})^\rho{}_\tau, \quad (65)$$

where

$$(S_V^{\mu\nu})^\rho{}_\tau \equiv \frac{1}{i}(g^{\mu\rho}\delta^\nu{}_\tau - g^{\nu\rho}\delta^\mu{}_\tau) \quad (66)$$

are matrices which constitute the *vector representation* of the Lorentz generators.

- a) Argue that the matrices $S_V^{\mu\nu}$ have the same commutation relations as the the operators $M^{\mu\nu}$.
 b) For a rotation by an angle θ about the z axis, we have

$$\Lambda^\mu{}_\nu = \begin{pmatrix} 1 & 0 & 0 & 0 \\ 0 & \cos\theta & -\sin\theta & 0 \\ 0 & \sin\theta & \cos\theta & 0 \\ 0 & 0 & 0 & 1 \end{pmatrix}. \quad (67)$$

Show that

$$\Lambda = \exp(-i\theta S_V^{12}). \quad (68)$$

- c) For a boost by *rapidity* η in the z direction, we have

$$\Lambda^\mu{}_\nu = \begin{pmatrix} \cosh\eta & 0 & 0 & \sinh\eta \\ 0 & 1 & 0 & 0 \\ 0 & 0 & 1 & 0 \\ \sinh\eta & 0 & 0 & \cosh\eta \end{pmatrix}. \quad (69)$$

Show that

$$\Lambda = \exp(+i\eta S_V^{30}). \quad (70)$$

3: Relativistic Quantum Fields and Canonical Quantization

Prerequisite: 2

Let us go back and drastically simplify the hamiltonian we constructed in section 1, reducing it to that of free particles:

$$\begin{aligned} H &= \int d^3x a^\dagger(\mathbf{x}) \left(-\frac{1}{2m} \nabla^2 \right) a(\mathbf{x}) \\ &= \int d^3p \frac{1}{2m} \mathbf{p}^2 \tilde{a}^\dagger(\mathbf{p}) \tilde{a}(\mathbf{p}) , \end{aligned} \quad (71)$$

where

$$\tilde{a}(\mathbf{p}) = \int \frac{d^3x}{(2\pi)^{3/2}} e^{-i\mathbf{p}\cdot\mathbf{x}} a(\mathbf{x}) . \quad (72)$$

Note that we have simplified our notation by setting $\hbar = 1$; the appropriate factors of \hbar can always be restored in any of our formulas via dimensional analysis. The commutation (or anticommutation) relations of the $\tilde{a}(\mathbf{p})$ and $\tilde{a}^\dagger(\mathbf{p})$ operators are

$$\begin{aligned} [\tilde{a}(\mathbf{p}), \tilde{a}(\mathbf{p}')]_{\mp} &= 0 , \\ [\tilde{a}^\dagger(\mathbf{p}), \tilde{a}^\dagger(\mathbf{p}')]_{\mp} &= 0 , \\ [\tilde{a}(\mathbf{p}), \tilde{a}^\dagger(\mathbf{p}')]_{\mp} &= \delta^3(\mathbf{p} - \mathbf{p}') , \end{aligned} \quad (73)$$

where $[A, B]_{\mp}$ is either the commutator (if we want a theory of bosons) or the anticommutator (if we want a theory of fermions). Thus $\tilde{a}^\dagger(\mathbf{p})$ can be interpreted as creating a state of definite momentum \mathbf{p} , and eq. (71) describes a theory of free particles. The ground state is the *vacuum* $|0\rangle$; it is annihilated by $\tilde{a}(\mathbf{p})$,

$$\tilde{a}(\mathbf{p})|0\rangle = 0 , \quad (74)$$

and so its energy eigenvalue is zero. The other eigenstates of H are all of the form $\tilde{a}^\dagger(\mathbf{p}_1) \dots \tilde{a}^\dagger(\mathbf{p}_n)|0\rangle$, and the corresponding energy eigenvalue is $E(\mathbf{p}_1) + \dots + E(\mathbf{p}_n)$, where $E(\mathbf{p}) = \frac{1}{2m}\mathbf{p}^2$.

It is easy to see how to generalize this theory to a relativistic one; all we need to do is use the relativistic energy formula $E(\mathbf{p}) = +(\mathbf{p}^2c^2 + m^2c^4)^{1/2}$:

$$H = \int d^3p (\mathbf{p}^2c^2 + m^2c^4)^{1/2} \tilde{a}^\dagger(\mathbf{p})\tilde{a}(\mathbf{p}) . \quad (75)$$

Now we have a theory of free *relativistic* spin-zero particles, and they can be either bosons or fermions.

Is this theory really Lorentz invariant? We will answer this question (in the affirmative) in a very roundabout way: by constructing it again, from a rather different point of view, a point of view that emphasizes Lorentz invariance from the beginning.

We will start with the *classical* physics of a *real scalar field* $\varphi(x)$. *Real* means that $\varphi(x)$ assigns a real number to every point in spacetime. *Scalar* means that Alice [who uses coordinates x^μ and calls the field $\varphi(x)$] and Bob [who uses coordinates \bar{x}^μ , related to Alice's coordinates by $\bar{x}^\mu = \Lambda^\mu_\nu x^\nu + a^\nu$, and calls the field $\bar{\varphi}(\bar{x})$], agree on the numerical value of the field: $\varphi(x) = \bar{\varphi}(\bar{x})$. This then implies that the equation of motion for $\varphi(x)$ must be the same as that for $\bar{\varphi}(\bar{x})$. We have already met an equation of this type: the Klein-Gordon equation, $(-\partial^2 + m^2)\varphi(x) = 0$. (Here, to simplify the notation, we have set $c = 1$ in addition to $\hbar = 1$. As with \hbar , factors of c can be restored, if desired, by dimensional analysis.) Let us adopt this as the equation of motion we would like $\varphi(x)$ to obey.

It should be emphasized at this point that we are doing *classical physics* of a *real scalar field*. We are *not* to think of $\varphi(x)$ as a quantum wave function. Thus, there should not be any factors of \hbar in this version of the Klein-Gordon equation. This means that the parameter m must have dimensions of inverse length; m is *not* (yet) to be thought of as a mass.

The equation of motion can be derived from variation of an action $S = \int dt L$, where L is the lagrangian. Since the Klein-Gordon equation is local, we expect that the lagrangian can be written as the space integral of a *lagrangian density* \mathcal{L} : $L = \int d^3x \mathcal{L}$. Thus, $S = \int d^4x \mathcal{L}$. The integration measure d^4x is Lorentz invariant: if we change to coordinates $\bar{x}^\mu = \Lambda^\mu_\nu x^\nu$, we

have $d^4\bar{x} = |\det \Lambda| d^4x = d^4x$. Thus, for the action to be Lorentz invariant, the lagrangian density must be a Lorentz scalar: $\mathcal{L}(x) = \bar{\mathcal{L}}(\bar{x})$. Then we have $\bar{S} = \int d^4\bar{x} \bar{\mathcal{L}}(\bar{x}) = \int d^4x \mathcal{L}(x) = S$. Any simple function of φ is a Lorentz scalar, and so are products of derivatives with all indices contracted, such as $\partial^\mu \varphi \partial_\mu \varphi$. We will take for \mathcal{L}

$$\mathcal{L} = -\frac{1}{2} \partial^\mu \varphi \partial_\mu \varphi - \frac{1}{2} m^2 \varphi^2 + \Lambda_0, \quad (76)$$

where Λ_0 is an arbitrary constant. We find the equation motion (also known as the *Euler-Lagrange equation*) by making an infinitesimal variation $\delta\varphi(x)$ in $\varphi(x)$, and requiring the corresponding variation of the action to vanish:

$$\begin{aligned} 0 &= \delta S \\ &= \int d^4x \left[-\frac{1}{2} \partial^\mu \delta\varphi \partial_\mu \varphi - \frac{1}{2} \partial^\mu \varphi \partial_\mu \delta\varphi - m^2 \varphi \delta\varphi \right] \\ &= \int d^4x \left[+\partial^\mu \partial_\mu \varphi - m^2 \varphi \right] \delta\varphi. \end{aligned} \quad (77)$$

In the last line, we have integrated by parts in each of the first two terms, putting both derivatives on φ . We assume $\delta\varphi(x)$ vanishes at infinity in any direction (spatial or temporal), so that there is no surface term. Since $\delta\varphi$ has an arbitrary x dependence, eq. (77) can be true if and only if $(-\partial^2 + m^2)\varphi = 0$.

One solution of the Klein-Gordon equation is a plane wave of the form $\exp(i\mathbf{k}\cdot\mathbf{x} \pm i\omega t)$, where \mathbf{k} is an arbitrary real wave-vector, and

$$\omega = +(\mathbf{k}^2 + m^2)^{1/2}. \quad (78)$$

The general solution (assuming boundary conditions that do not allow φ to become infinite at spatial infinity) is then

$$\varphi(\mathbf{x}, t) = \int \frac{d^3k}{f(k)} \left[a(\mathbf{k}) e^{i\mathbf{k}\cdot\mathbf{x} - i\omega t} + b(\mathbf{k}) e^{i\mathbf{k}\cdot\mathbf{x} + i\omega t} \right], \quad (79)$$

where $a(\mathbf{k})$ and $b(\mathbf{k})$ are arbitrary functions of the wave vector \mathbf{k} , and $f(k)$ is a redundant function of the magnitude of \mathbf{k} which we have inserted for later convenience. Note that, *if* we were attempting to interpret $\varphi(x)$ as a quantum wave function (which we most definitely are *not*), then the second

term would constitute the “negative energy” contributions to the wave function. This is because a plane-wave solution of the nonrelativistic Schrödinger equation for a single particle looks like $\exp(i\mathbf{p}\cdot\mathbf{x} - iE(\mathbf{p})t)$, with $E(\mathbf{p}) = \frac{1}{2m}\mathbf{p}^2$; there is a minus sign in front of the positive energy. We *are* trying to interpret eq. (79) as a *real* classical field, but this formula does not generically result in φ being real. We must impose $\varphi^*(x) = \varphi(x)$, where

$$\begin{aligned}\varphi^*(\mathbf{x}, t) &= \int \frac{d^3k}{f(k)} \left[a^*(\mathbf{k})e^{-i\mathbf{k}\cdot\mathbf{x} + i\omega t} + b^*(\mathbf{k})e^{-i\mathbf{k}\cdot\mathbf{x} - i\omega t} \right] \\ &= \int \frac{d^3k}{f(k)} \left[a^*(\mathbf{k})e^{-i\mathbf{k}\cdot\mathbf{x} + i\omega t} + b^*(-\mathbf{k})e^{+i\mathbf{k}\cdot\mathbf{x} - i\omega t} \right].\end{aligned}\quad (80)$$

In the second line, we have changed the dummy integration variable \mathbf{k} (in the second term only) to $-\mathbf{k}$. Comparing eqs. (79) and (80), we see that $\varphi^*(x) = \varphi(x)$ requires $b^*(-\mathbf{k}) = a(\mathbf{k})$. Imposing this condition, we can rewrite φ as

$$\begin{aligned}\varphi(\mathbf{x}, t) &= \int \frac{d^3k}{f(k)} \left[a(\mathbf{k})e^{i\mathbf{k}\cdot\mathbf{x} - i\omega t} + a^*(-\mathbf{k})e^{i\mathbf{k}\cdot\mathbf{x} + i\omega t} \right] \\ &= \int \frac{d^3k}{f(k)} \left[a(\mathbf{k})e^{i\mathbf{k}\cdot\mathbf{x} - i\omega t} + a^*(\mathbf{k})e^{-i\mathbf{k}\cdot\mathbf{x} + i\omega t} \right] \\ &= \int \frac{d^3k}{f(k)} \left[a(\mathbf{k})e^{ikx} + a^*(\mathbf{k})e^{-ikx} \right],\end{aligned}\quad (81)$$

where $kx = \mathbf{k}\cdot\mathbf{x} - \omega t$ is the Lorentz-invariant product of the four-vectors $x^\mu = (t, \mathbf{x})$ and $k^\mu = (\omega, \mathbf{k})$: $kx = k^\mu x_\mu = g_{\mu\nu}k^\mu x^\nu$. Note that

$$k^2 = k^\mu k_\mu = \mathbf{k}^2 - \omega^2 = -m^2. \quad (82)$$

It is now convenient to choose $f(k)$ so that $d^3k/f(k)$ is Lorentz invariant. An integration measure that is manifestly invariant under orthochronous Lorentz transformations is $d^4k \delta(k^2 + m^2) \theta(k^0)$, where $\theta(x)$ is the unit step function, and k^0 is treated as an independent integration variable. We then have

$$\int_{-\infty}^{+\infty} dk^0 \delta(k^2 + m^2) \theta(k^0) = \frac{1}{2\omega}. \quad (83)$$

Here we have used the rule

$$\int_{-\infty}^{+\infty} dx \delta(g(x)) = \sum_i \frac{1}{|g'(x_i)|}, \quad (84)$$

where $g(x)$ is any smooth function of x with simple zeros at $x = x_i$; in our case, the only zero is at $k^0 = \omega$.

Thus we see that if we take $f(k) \propto \omega$, then $d^3k/f(k)$ will be Lorentz invariant. We will take $f(k) = (2\pi)^3 2\omega$. It is then convenient to give the corresponding Lorentz-invariant differential its own name:

$$\widetilde{d}k \equiv \frac{d^3k}{(2\pi)^3 2\omega}. \quad (85)$$

Thus we finally have

$$\varphi(x) = \int \widetilde{d}k \left[a(\mathbf{k}) e^{ikx} + a^*(\mathbf{k}) e^{-ikx} \right]. \quad (86)$$

We can also invert this formula to get $a(\mathbf{k})$ in terms of $\varphi(x)$. We have

$$\begin{aligned} \int d^3x e^{-ikx} \varphi(x) &= \frac{1}{2\omega} a(\mathbf{k}) + \frac{1}{2\omega} e^{2i\omega t} a(-\mathbf{k}), \\ \int d^3x e^{-ikx} \partial_0 \varphi(x) &= -\frac{i}{2} a(\mathbf{k}) + \frac{i}{2} e^{2i\omega t} a(-\mathbf{k}). \end{aligned} \quad (87)$$

We can combine these to get

$$\begin{aligned} a(\mathbf{k}) &= \int d^3x e^{-ikx} \left[i \partial_0 \varphi(x) + \omega \varphi(x) \right] \\ &= i \int d^3x e^{-ikx} \overleftrightarrow{\partial}_0 \varphi(x), \end{aligned} \quad (88)$$

where $f \overleftrightarrow{\partial}_\mu g = f(\partial_\mu g) - (\partial_\mu f)g$, and $\partial_0 \varphi = \partial\varphi/\partial t = \dot{\varphi}$. Note that $a(\mathbf{k})$ is time independent.

Now that we have the lagrangian, we can construct the hamiltonian by the usual rules. Recall that, given a lagrangian $L(q_i, \dot{q}_i)$ as a function of some coordinates q_i and their time derivatives \dot{q}_i , the conjugate momenta are given by $p_i = \partial L / \partial \dot{q}_i$, and the hamiltonian by $H = \sum_i p_i \dot{q}_i - L$. In our case, the role of $q_i(t)$ is played by $\varphi(\mathbf{x}, t)$, with \mathbf{x} playing the role of a (continuous) index. The appropriate generalizations are then

$$\Pi(x) = \frac{\partial \mathcal{L}}{\partial \dot{\varphi}(x)} \quad (89)$$

and

$$\mathcal{H} = \Pi\dot{\varphi} - \mathcal{L} , \quad (90)$$

where \mathcal{H} is the *hamiltonian density*, and the hamiltonian itself is $H = \int d^3x \mathcal{H}$. In our case, we have

$$\Pi(x) = \dot{\varphi}(x) \quad (91)$$

and

$$\mathcal{H} = \frac{1}{2}\Pi^2 + \frac{1}{2}(\nabla\varphi)^2 + \frac{1}{2}m^2\varphi^2 - \Lambda_0 . \quad (92)$$

Using eq. (86), we can write H in terms of the $a(\mathbf{k})$ and $a^*(\mathbf{k})$ coefficients:

$$\begin{aligned} H &= -\Lambda_0 V + \frac{1}{2} \int \widetilde{dk} \widetilde{dk}' d^3x \left[\right. \\ &\quad \left. \left(-i\omega a(\mathbf{k})e^{ikx} + i\omega a^*(\mathbf{k})e^{-ikx} \right) \left(-i\omega' a(\mathbf{k}')e^{ik'x} + i\omega' a^*(\mathbf{k}')e^{-ik'x} \right) \right. \\ &\quad \left. + \left(+i\mathbf{k} a(\mathbf{k})e^{ikx} - i\mathbf{k} a^*(\mathbf{k})e^{-ikx} \right) \cdot \left(+i\mathbf{k}' a(\mathbf{k}')e^{ik'x} - i\mathbf{k}' a^*(\mathbf{k}')e^{-ik'x} \right) \right. \\ &\quad \left. + m^2 \left(a(\mathbf{k})e^{ikx} + a^*(\mathbf{k})e^{-ikx} \right) \left(a(\mathbf{k}')e^{ik'x} + a^*(\mathbf{k}')e^{-ik'x} \right) \right] \\ &= -\Lambda_0 V + \frac{1}{2}(2\pi)^3 \int \widetilde{dk} \widetilde{dk}' \left[\right. \\ &\quad \delta^3(\mathbf{k} - \mathbf{k}') (+\omega\omega' + \mathbf{k} \cdot \mathbf{k}' + m^2) \\ &\quad \times \left(a^*(\mathbf{k})a(\mathbf{k}')e^{-i(\omega-\omega')t} + a(\mathbf{k})a^*(\mathbf{k}')e^{+i(\omega-\omega')t} \right) \\ &\quad + \delta^3(\mathbf{k} + \mathbf{k}') (-\omega\omega' - \mathbf{k} \cdot \mathbf{k}' + m^2) \\ &\quad \times \left(a(\mathbf{k})a(\mathbf{k}')e^{-i(\omega+\omega')t} + a^*(\mathbf{k})a^*(\mathbf{k}')e^{+i(\omega+\omega')t} \right) \\ &= -\Lambda_0 V + \frac{1}{2} \int \widetilde{dk} \frac{1}{2\omega} \left[\right. \\ &\quad \left. (+\omega^2 + \mathbf{k}^2 + m^2) \left(a^*(\mathbf{k})a(\mathbf{k}) + a(\mathbf{k})a^*(\mathbf{k}) \right) \right. \\ &\quad \left. + (-\omega^2 + \mathbf{k}^2 + m^2) \left(a(\mathbf{k})a(-\mathbf{k}) + a^*(\mathbf{k})a^*(-\mathbf{k}) \right) \right] \\ &= -\Lambda_0 V + \frac{1}{2} \int \widetilde{dk} \omega \left(a^*(\mathbf{k})a(\mathbf{k}) + a(\mathbf{k})a^*(\mathbf{k}) \right) , \quad (93) \end{aligned}$$

where V is the volume of space. We have made use of $\omega = (\mathbf{k}^2 + m^2)^{1/2}$ and $\widetilde{dk} = d^3k/(2\pi)^3 2\omega$ at various points. Also, we have been careful to keep the ordering of $a(\mathbf{k})$ and $a^*(\mathbf{k})$ unchanged throughout, in anticipation of passing to the quantum theory where these classical functions will become operators that may not commute.

Let us take up the quantum theory now. We can go from classical to quantum mechanics via *canonical quantization*. This means that we promote q_i and p_i to operators, with commutation relations $[q_i, q_j] = 0$, $[p_i, p_j] = 0$, and $[q_i, p_j] = i\hbar\delta_{ij}$. In the Heisenberg picture, these operators should be taken at equal times. In our case, where the “index” is continuous (and we have set $\hbar = 1$), this becomes

$$\begin{aligned} [\varphi(\mathbf{x}, t), \varphi(\mathbf{x}', t)] &= 0, \\ [\Pi(\mathbf{x}, t), \Pi(\mathbf{x}', t)] &= 0, \\ [\varphi(\mathbf{x}, t), \Pi(\mathbf{x}', t)] &= i\delta^3(\mathbf{x} - \mathbf{x}') . \end{aligned} \tag{94}$$

From these, and from eqs. (88) and (91), we can deduce

$$\begin{aligned} [a(\mathbf{k}), a(\mathbf{k}')] &= 0, \\ [a^\dagger(\mathbf{k}), a^\dagger(\mathbf{k}')] &= 0, \\ [a(\mathbf{k}), a^\dagger(\mathbf{k}')] &= (2\pi)^3 2\omega \delta^3(\mathbf{k} - \mathbf{k}') . \end{aligned} \tag{95}$$

We are now denoting $a^*(\mathbf{k})$ as $a^\dagger(\mathbf{k})$, since $a^\dagger(\mathbf{k})$ is now the hermitian conjugate (rather than the complex conjugate) of the operator $a(\mathbf{k})$. We can now rewrite the hamiltonian as

$$H = \int \widetilde{d^3k} \omega a^\dagger(\mathbf{k})a(\mathbf{k}) + (\mathcal{E}_0 - \Lambda_0)V , \tag{96}$$

where $\mathcal{E}_0 = \frac{1}{2} \int d^3k \omega$ is the total zero-point energy of all the oscillators per unit volume, and, using $(2\pi)^3 \delta^3(\mathbf{k}) = \int d^3x e^{i\mathbf{k}\cdot\mathbf{x}}$, we have interpreted $(2\pi)^3 \delta^3(\mathbf{0})$ as the volume of space V . If you try to evaluate \mathcal{E}_0 , you will find that it is infinite. However, Λ_0 was arbitrary, so we are free to choose $\Lambda_0 = \mathcal{E}_0$, whether or not \mathcal{E}_0 is infinite. And that is what we will do. With this choice, the ground state has energy eigenvalue zero.

The hamiltonian of eq. (96) is now the same as that of eq. (75), with $a(\mathbf{k}) = [(2\pi)^3 2\omega]^{1/2} \tilde{a}(\mathbf{k})$. The commutation relations (73) and (95) are also equivalent, if we choose commutators (rather than anticommutators) in eq. (73). Thus, *we have re-derived the hamiltonian of free relativistic bosons by quantization of a scalar field whose equation of motion is the Klein-Gordon equation.*

What if we want fermions? Then we should use anticommutators in eqs. (94) and (95). There is a problem, though; eq. (93) does not then become eq. (96). Instead, we get $H = -\Lambda_0 V$, a constant! Clearly there is something wrong with using anticommutators. This is another hint of the spin-statistics theorem, which we will take up in section 4.

Next, we would like to add Lorentz-invariant interactions to our theory. With the formalism we have developed, this is easy to do. Any local function of $\varphi(x)$ is a Lorentz scalar, and so if we add a term like φ^3 or φ^4 to the lagrangian density \mathcal{L} , the resulting action will still be Lorentz invariant. Now, however, we will have interactions among the particles. Our next task is to deduce the consequences of these interactions.

However, we already have enough tools at our disposal to prove the spin-statistics theorem for spin-zero particles, and that is what we turn to next.

Problems

3.1) Derive eq. (95) from eqs. (88) and (91).

3.2) Use the commutation relations, eq. (95), to show explicitly that a state of the form

$$|k_1 \dots k_n\rangle \equiv a^\dagger(\mathbf{k}_1) \dots a^\dagger(\mathbf{k}_n)|0\rangle \quad (97)$$

is an eigenstate of the hamiltonian, eq. (96), with eigenvalue $\omega_1 + \dots + \omega_n$. The vacuum $|0\rangle$ is annihilated by $a(\mathbf{k})$, $a(\mathbf{k})|0\rangle = 0$, and we take $\Lambda_0 = \mathcal{E}_0$ in eq. (96).

3.3) Use $U(\Lambda)^{-1}\varphi(x)U(\Lambda) = \varphi(\Lambda^{-1}x)$ to show that

$$\begin{aligned} U(\Lambda)^{-1}a(\mathbf{k})U(\Lambda) &= a(\Lambda^{-1}\mathbf{k}) , \\ U(\Lambda)^{-1}a^\dagger(\mathbf{k})U(\Lambda) &= a^\dagger(\Lambda^{-1}\mathbf{k}) , \end{aligned} \quad (98)$$

and hence that

$$U(\Lambda)|k_1 \dots k_n\rangle = |\Lambda k_1 \dots \Lambda k_n\rangle , \quad (99)$$

where $|k_1 \dots k_n\rangle = a^\dagger(\mathbf{k}_1) \dots a^\dagger(\mathbf{k}_n)|0\rangle$ is a state of n particles with momenta k_1, \dots, k_n .

3.4) Consider a complex (that is, nonhermitian) scalar field φ with lagrangian density

$$\mathcal{L} = -\partial^\mu \varphi^\dagger \partial_\mu \varphi - m^2 \varphi^\dagger \varphi + \Lambda_0 . \quad (100)$$

- a) Show that φ obeys the Klein-Gordon equation.
- b) Treat φ and φ^\dagger as independent fields, and find the conjugate momentum for each. Compute the hamiltonian density in terms of these conjugate momenta and the fields themselves (but not their time derivatives).
- c) Write the mode expansion of φ as

$$\varphi(x) = \int \widetilde{d\mathbf{k}} \left[a(\mathbf{k}) e^{i\mathbf{k}x} + b^\dagger(\mathbf{k}) e^{-i\mathbf{k}x} \right] . \quad (101)$$

Express $a(\mathbf{k})$ and $b(\mathbf{k})$ in terms of φ and φ^\dagger and their time derivatives.

d) Assuming canonical commutation relations for the fields and their conjugate momenta, find the commutation relations obeyed by $a(\mathbf{k})$ and $b(\mathbf{k})$ and their hermitian conjugates.

e) Express the hamiltonian in terms of $a(\mathbf{k})$ and $b(\mathbf{k})$ and their hermitian conjugates. What value must Λ_0 have in order for the ground state to have zero energy?

4: The Spin-Statistics Theorem

Prerequisite: 3

Let us consider a theory of free, spin-zero particles specified by the hamiltonian

$$H_0 = \int \widetilde{d}k \, \omega \, a^\dagger(\mathbf{k}) a(\mathbf{k}) , \quad (102)$$

where $\omega = (\mathbf{k}^2 + m^2)^{1/2}$, and either the commutation or anticommutation relations

$$\begin{aligned} [a(\mathbf{k}), a(\mathbf{k}')]_{\mp} &= 0 , \\ [a^\dagger(\mathbf{k}), a^\dagger(\mathbf{k}')]_{\mp} &= 0 , \\ [a(\mathbf{k}), a^\dagger(\mathbf{k}')]_{\mp} &= (2\pi)^3 2\omega \delta^3(\mathbf{k} - \mathbf{k}') . \end{aligned} \quad (103)$$

Of course, if we want a theory of bosons, we should use commutators, and if we want fermions, we should use anticommutators.

Now let us consider adding terms to the hamiltonian that will result in *local, Lorentz invariant* interactions. In order to do this, it is convenient to define a non-hermitian field,

$$\varphi^+(\mathbf{x}, 0) \equiv \int \widetilde{d}k \, e^{i\mathbf{k}\cdot\mathbf{x}} a(\mathbf{k}) \quad (104)$$

and its hermitian conjugate

$$\varphi^-(\mathbf{x}, 0) \equiv \int \widetilde{d}k \, e^{-i\mathbf{k}\cdot\mathbf{x}} a^\dagger(\mathbf{k}) . \quad (105)$$

These are then time-evolved with H_0 :

$$\begin{aligned} \varphi^+(\mathbf{x}, t) &= e^{iH_0 t} \varphi^+(\mathbf{x}, 0) e^{-iH_0 t} = \int \widetilde{d}k \, e^{ikx} a(\mathbf{k}) , \\ \varphi^-(\mathbf{x}, t) &= e^{iH_0 t} \varphi^-(\mathbf{x}, 0) e^{-iH_0 t} = \int \widetilde{d}k \, e^{-ikx} a^\dagger(\mathbf{k}) . \end{aligned} \quad (106)$$

Note that the usual hermitian free field $\varphi(x)$ is just the sum of these: $\varphi(x) = \varphi^+(x) + \varphi^-(x)$.

For a proper orthochronous Lorentz transformation Λ , we have

$$U(\Lambda)^{-1}\varphi(x)U(\Lambda) = \varphi(\Lambda^{-1}x) . \quad (107)$$

This implies that the particle creation and annihilation operators transform as

$$\begin{aligned} U(\Lambda)^{-1}a(\mathbf{k})U(\Lambda) &= a(\Lambda^{-1}\mathbf{k}) , \\ U(\Lambda)^{-1}a^\dagger(\mathbf{k})U(\Lambda) &= a^\dagger(\Lambda^{-1}\mathbf{k}) . \end{aligned} \quad (108)$$

This, in turn, implies that $\varphi^+(x)$ and $\varphi^-(x)$ are Lorentz scalars:

$$U(\Lambda)^{-1}\varphi^\pm(x)U(\Lambda) = \varphi^\pm(\Lambda^{-1}x) . \quad (109)$$

We will then have local, Lorentz invariant interactions if we take the interaction lagrangian density \mathcal{L}_1 to be a hermitian function of $\varphi^+(x)$ and $\varphi^-(x)$.

To proceed we need to recall some facts about time-dependent perturbation theory in quantum mechanics. The transition amplitude $\mathcal{T}_{f \leftarrow i}$ to start with an initial state $|i\rangle$ at time $t = -\infty$ and end with a final state $|f\rangle$ at time $t = +\infty$ is

$$\mathcal{T}_{f \leftarrow i} = \langle f | \text{T exp} \left[-i \int_{-\infty}^{+\infty} dt H_I(t) \right] | i \rangle , \quad (110)$$

where $H_I(t)$ is the perturbing hamiltonian in the *interaction picture*,

$$H_I(t) = \exp(+iH_0t)H_1 \exp(-iH_0t) , \quad (111)$$

H_0 is the unperturbed hamiltonian, and T is the *time ordering symbol*: a product of operators to its right is to be ordered, not as written, but with operators at later times to the left of those at earlier times. Using eq. (106), we can write

$$H_I(t) = \int d^3x \mathcal{H}_I(x) , \quad (112)$$

where $\mathcal{H}_I(x)$ is an ordinary function of $\varphi^+(x)$ and $\varphi^-(x)$.

Here is the key point: for the transition amplitude $\mathcal{T}_{f \leftarrow i}$ to be Lorentz invariant, the time ordering must be *frame independent*. The time ordering

of two spacetime points x and x' is frame independent if their separation is *timelike*; this means that $(x - x')^2 < 0$. Two spacetime points whose separation is *spacelike*, $(x - x')^2 > 0$, can have different temporal ordering in different frames. In order to avoid $\mathcal{T}_{f \leftarrow i}$ being different in different frames, we must then require

$$\left[\mathcal{H}_I(x), \mathcal{H}_I(x') \right] = 0 \quad \text{whenever} \quad (x - x')^2 > 0. \quad (113)$$

Obviously, $[\varphi^+(x), \varphi^+(x')]_{\mp} = [\varphi^-(x), \varphi^-(x')]_{\mp} = 0$. However,

$$\begin{aligned} [\varphi^+(x), \varphi^-(x')]_{\mp} &= \int \widetilde{d\mathbf{k}} \widetilde{d\mathbf{k}'} e^{i(kx - k'x')} [a(\mathbf{k}), a^\dagger(\mathbf{k}')]_{\mp} \\ &= \int \widetilde{d\mathbf{k}} e^{ik(x-x')} \\ &= \frac{m}{4\pi^2 r} K_1(mr) \\ &\equiv C(r). \end{aligned} \quad (114)$$

In the next-to-last line, we have taken $(x - x')^2 = r^2 > 0$, and $K_1(z)$ is the modified Bessel function. (This Lorentz-invariant integral is most easily evaluated in the frame where $t' = t$.) The function $C(r)$ is *not* zero for any $r > 0$. (Not even when $m = 0$; in this case, $C(r) = 1/4\pi^2 r^2$.) On the other hand, $\mathcal{H}_I(x)$ must involve both $\varphi^+(x)$ and $\varphi^-(x)$, by hermiticity. Thus, generically, we will not be able to satisfy eq. (113).

To resolve this problem, let us try using only particular linear combinations of $\varphi^+(x)$ and $\varphi^-(x)$. Define

$$\begin{aligned} \varphi_\lambda(x) &\equiv \varphi^+(x) + \lambda \varphi^-(x), \\ \varphi_\lambda^\dagger(x) &\equiv \varphi^-(x) + \lambda^* \varphi^+(x), \end{aligned} \quad (115)$$

where λ is an arbitrary complex number. We then have

$$\begin{aligned} [\varphi_\lambda(x), \varphi_\lambda^\dagger(x')]_{\mp} &= [\varphi^+(x), \varphi^-(x')]_{\mp} + |\lambda|^2 [\varphi^-(x), \varphi^+(x')]_{\mp} \\ &= (1 \mp |\lambda|^2) C(r) \end{aligned} \quad (116)$$

and

$$\begin{aligned} [\varphi_\lambda(x), \varphi_\lambda(x')]_{\mp} &= \lambda [\varphi^+(x), \varphi^-(x')]_{\mp} + \lambda [\varphi^-(x), \varphi^+(x')]_{\mp} \\ &= \lambda(1 \mp 1) C(r). \end{aligned} \quad (117)$$

Thus, if we want $\varphi_\lambda(x)$ to either commute or anticommute with both $\varphi_\lambda(x')$ and $\varphi_\lambda^\dagger(x')$ at spacelike separations, we must choose $|\lambda| = 1$, *and* we must choose commutators. Then (and only then), we can build a suitable $\mathcal{H}_I(x)$ by making it a hermitian function of $\varphi_\lambda(x)$.

But this has simply returned us to the theory of a real scalar field, because, for $\lambda = e^{i\alpha}$, $e^{-i\alpha/2}\varphi_\lambda(x)$ is hermitian. In fact, if we make the replacement $a(\mathbf{k}) \rightarrow e^{i\alpha/2}a(\mathbf{k})$ (which does not change the commutation relations of these operators), then $e^{-i\alpha/2}\varphi_\lambda(x) = \varphi(x) = \varphi^+(x) + \varphi^-(x)$. Thus, our attempt to start with the creation and annihilation operators $a^\dagger(\mathbf{k})$ and $a(\mathbf{k})$ as the fundamental objects has simply led us back to the real, commuting, scalar field $\varphi(x)$ as the fundamental object.

Let us return to thinking of $\varphi(x)$ as fundamental, with a lagrangian density specified by some function of the Lorentz scalars $\varphi(x)$ and $\partial^\mu\varphi(x)\partial_\mu\varphi(x)$. Then, quantization will result in $[\varphi(x), \varphi(x')]_{\mp} = 0$ for $t = t'$. If we choose anticommutators, then $[\varphi(x)]^2 = 0$ and $[\partial_\mu\varphi(x)]^2 = 0$, resulting in $\mathcal{L} = 0$. This clearly does not make sense.

This situation turns out to generalize to fields of higher spin, in any number of spacetime dimensions. One choice of quantization (commutators or anticommutators) always leads to vanishing \mathcal{L} (or to an \mathcal{L} that is a total derivative), and this choice is disallowed. Furthermore, the allowed choice is always commutators for fields of integer spin, and anticommutators for fields of half-integer spin. If we try treating the particle creation and annihilation operators as fundamental, rather than the fields, we find a situation similar to that of the spin-zero case, and are led to the reconstruction of a field that must obey the appropriate quantization scheme.

5: The LSZ Reduction Formula

Prerequisite: 3

Let us now consider how to construct appropriate initial and final states for scattering experiments. In the free theory, we can create a state of one particle by acting on the vacuum state with the creation operator:

$$|k\rangle = a^\dagger(\mathbf{k})|0\rangle, \quad (118)$$

where

$$a^\dagger(\mathbf{k}) = -i \int d^3x e^{ikx} \overleftrightarrow{\partial}_0 \varphi(x). \quad (119)$$

Recall that $a^\dagger(\mathbf{k})$ is time independent in the free theory. The state $|k\rangle$ has the Lorentz-invariant normalization

$$\langle k|k'\rangle = (2\pi)^3 2\omega \delta^3(\mathbf{k} - \mathbf{k}'), \quad (120)$$

where $\omega = (\mathbf{k}^2 + m^2)^{1/2}$.

Let us consider an operator that (in the free theory) creates a particle localized in momentum space near \mathbf{k}_1 , and localized in position space near the origin:

$$a_1^\dagger \equiv \int d^3k f_1(\mathbf{k}) a^\dagger(\mathbf{k}), \quad (121)$$

where

$$f_1(\mathbf{k}) \propto \exp[-(\mathbf{k} - \mathbf{k}_1)^2/4\sigma^2] \quad (122)$$

is an appropriate wave packet, and σ is its width in momentum space. If we time evolve (in the Schrödinger picture) the state created by this time-independent operator, then the wave packet will propagate (and spread out). The particle will thus be localized far from the origin as $t \rightarrow \pm\infty$. If we

consider instead an initial state of the form $|i\rangle = a_1^\dagger a_2^\dagger |0\rangle$, where $\mathbf{k}_1 \neq \mathbf{k}_2$, then the two particles are widely separated in the far past.

Let us guess that this still works in the interacting theory. One complication is that $a^\dagger(\mathbf{k})$ will no longer be time independent, and so a_1^\dagger , eq. (121), becomes time dependent as well. Our guess for a suitable initial state of a scattering experiment is then

$$|i\rangle = \lim_{t \rightarrow -\infty} a_1^\dagger(t) a_2^\dagger(t) |0\rangle. \quad (123)$$

By appropriately normalizing the wave packets, we can make $\langle i|i\rangle = 1$, and we will assume that this is the case. Similarly, we can consider a final state

$$|f\rangle = \lim_{t \rightarrow +\infty} a_{1'}^\dagger(t) a_{2'}^\dagger(t) |0\rangle, \quad (124)$$

where $\mathbf{k}'_1 \neq \mathbf{k}'_2$, and $\langle f|f\rangle = 1$. This describes two widely separated particles in the far future. (We could also consider acting with more creation operators, if we are interested in the production of some extra particles in the collision of two.) Now the scattering amplitude is simply given by $\langle f|i\rangle$.

We need to find a more useful expression for $\langle f|i\rangle$. To this end, let us note that

$$\begin{aligned} a_1^\dagger(+\infty) - a_1^\dagger(-\infty) &= \int_{-\infty}^{+\infty} dt \partial_0 a_1^\dagger(t) \\ &= -i \int d^3k f_1(\mathbf{k}) \int d^4x \partial_0 (e^{ikx} \overleftrightarrow{\partial}_0 \varphi(x)) \\ &= -i \int d^3k f_1(\mathbf{k}) \int d^4x e^{ikx} (\partial_0^2 + \omega^2) \varphi(x) \\ &= -i \int d^3k f_1(\mathbf{k}) \int d^4x e^{ikx} (\partial_0^2 + \mathbf{k}^2 + m^2) \varphi(x) \\ &= -i \int d^3k f_1(\mathbf{k}) \int d^4x e^{ikx} (\partial_0^2 - \overleftarrow{\nabla}^2 + m^2) \varphi(x) \\ &= -i \int d^3k f_1(\mathbf{k}) \int d^4x e^{ikx} (\partial_0^2 - \overrightarrow{\nabla}^2 + m^2) \varphi(x) \\ &= -i \int d^3k f_1(\mathbf{k}) \int d^4x e^{ikx} (-\partial^2 + m^2) \varphi(x). \quad (125) \end{aligned}$$

The first equality is just the fundamental theorem of calculus. To get the second, we substituted the definition of $a_1^\dagger(t)$, and combined the d^3x from this definition with the dt to get d^4x . The third comes from straightforward

evaluation of the time derivatives. The fourth uses $\omega^2 = \mathbf{k}^2 + m^2$. The fifth writes \mathbf{k}^2 as $-\nabla^2$ acting on $e^{i\mathbf{k}\cdot\mathbf{x}}$. The sixth uses integration by parts to move the ∇^2 onto the field $\varphi(x)$; here the wave packet is needed to avoid a surface term. The seventh simply identifies $\partial_0^2 - \nabla^2$ as $-\partial^2$.

In free-field theory, the right-hand side of eq. (125) is zero, since $\varphi(x)$ obeys the Klein-Gordon equation. In an interacting theory, with (say) $\mathcal{L}_1 = \frac{1}{6}g\varphi^3$, we have instead $(-\partial^2 + m^2)\varphi = \frac{1}{2}g\varphi^2$. Thus the right-hand side of eq. (125) is not zero in an interacting theory.

Rearranging eq. (125), we have

$$a_1^\dagger(-\infty) = a_1^\dagger(+\infty) + i \int d^3k f_1(\mathbf{k}) \int d^4x e^{ikx} (-\partial^2 + m^2)\varphi(x). \quad (126)$$

We will also need the hermitian conjugate of this formula, which (after a little more rearranging) reads

$$a_1(+\infty) = a_1(-\infty) + i \int d^3k f_1(\mathbf{k}) \int d^4x e^{-ikx} (-\partial^2 + m^2)\varphi(x). \quad (127)$$

Let us return to the scattering amplitude,

$$\langle f|i \rangle = \langle 0|a_{1'}(+\infty)a_{2'}(+\infty)a_1^\dagger(-\infty)a_2^\dagger(-\infty)|0 \rangle. \quad (128)$$

Note that the operators are in time order. Thus, if we feel like it, we can put in a *time-ordering symbol* without changing anything:

$$\langle f|i \rangle = \langle 0|T a_{1'}(+\infty)a_{2'}(+\infty)a_1^\dagger(-\infty)a_2^\dagger(-\infty)|0 \rangle. \quad (129)$$

The symbol T means the product of operators to its right is to be ordered, not as written, but with operators at later times to the left of those at earlier times.

Now let us use eqs. (126) and (127) in eq. (129). The time-ordering symbol automatically moves all $a_{i'}(-\infty)$'s to the right, where they annihilate $|0\rangle$. Similarly, all $a_i^\dagger(+\infty)$'s move to the left, where they annihilate $\langle 0|$.

The wave packets no longer play a key role, and we can take the $\sigma \rightarrow 0$ limit in eq. (122), so that $f_1(\mathbf{k}) = \delta^3(\mathbf{k} - \mathbf{k}_1)$. The initial and final states now have a delta-function normalization, the multiparticle generalization of

eq. (120). We are left with

$$\begin{aligned} \langle f|i\rangle &= i^{n+n'} \int d^4x_1 e^{ik_1x_1} (-\partial_1^2 + m^2) \dots \\ &\quad d^4x'_1 e^{-ik'_1x'_1} (-\partial_1'^2 + m^2) \dots \\ &\quad \times \langle 0|T\varphi(x_1) \dots \varphi(x'_1) \dots |0\rangle . \end{aligned} \quad (130)$$

This formula has been written to apply to the more general case of n incoming particles and n' outgoing particles; the ellipses stand for similar factors for each of the other incoming and outgoing particles.

Eq. (130) is the *Lehmann-Symanzik-Zimmerman reduction formula*, or LSZ formula for short. It is one of the key equations of quantum field theory.

However, we cheated a little in our derivation of the LSZ formula, because we assumed that the creation operators of *free* field theory would work comparably in the *interacting* theory. This is a rather suspect assumption, and so we must review it.

Let us consider what we can deduce about the energy and momentum eigenstates of the interacting theory on physical grounds. First, we assume that there is a unique ground state $|0\rangle$, with zero energy and momentum. The first excited state is a state of a single particle with mass m . This state can have an arbitrary three-momentum \mathbf{k} , and then has energy $E = \omega = (\mathbf{k}^2 + m^2)^{1/2}$. The next excited state is that of two particles. These two particles could form a bound state with energy *less* than $2m$ (like the hydrogen atom in quantum electrodynamics), but, to keep things simple, let us assume that there are no such bound states. Then the lowest possible energy of a two-particle state is $2m$. However, a two-particle state with zero total three-momentum can have *any* energy above $2m$, because the two particles could have some *relative* momentum that contributes to their total energy. Thus we are led to a picture of the states of theory as shown in fig. (1).

Now let us consider what happens when we act on the ground state with the field operator $\varphi(x)$. To this end, it is helpful to write

$$\varphi(x) = \exp(-iP^\mu x_\mu) \varphi(0) \exp(+iP^\mu x_\mu) , \quad (131)$$

where P^μ is the energy-momentum four-vector. (This equation, introduced in section 2, is just the relativistic generalization of the Heisenberg equation.)

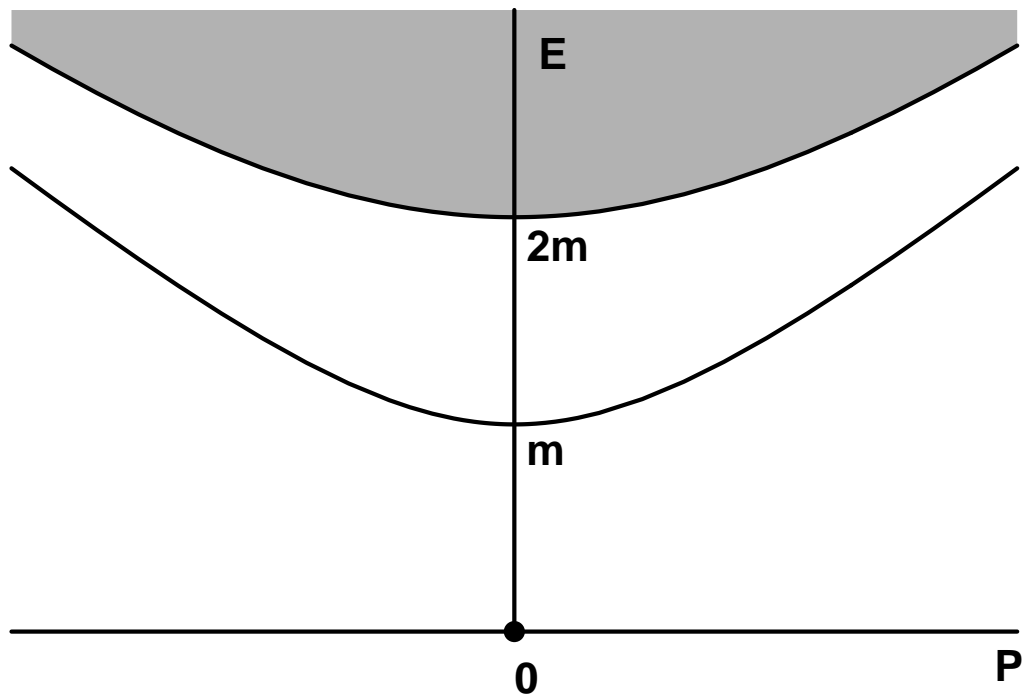

Figure 1: The exact energy eigenstates in the (\mathbf{P}, E) plane. The ground state is isolated at $(\mathbf{0}, 0)$, the one-particle states form an isolated hyperbola that passes through $(\mathbf{0}, m)$, and the multi-particle continuum lies at and above the hyperbola that passes through $(\mathbf{0}, 2m)$.

Now let us sandwich $\varphi(x)$ between the ground state (on the right), and other possible states (on the left). For example, let us put the ground state on the left as well. Then we have

$$\begin{aligned}\langle 0|\varphi(x)|0\rangle &= \langle 0|e^{-iPx}\varphi(0)e^{+iPx}|0\rangle \\ &= \langle 0|\varphi(0)|0\rangle .\end{aligned}\tag{132}$$

To get the second line, we used $P^\mu|0\rangle = 0$. The final expression is just a Lorentz-invariant number. Since $|0\rangle$ is the exact ground state of the interacting theory, we have (in general) no idea what this number is.

We would like $\langle 0|\varphi(0)|0\rangle$ to be zero. This is because we would like $a_1^\dagger(\pm\infty)$, when acting on $|0\rangle$, to create a single particle state. We do *not* want $a_1^\dagger(\pm\infty)$ to create a linear combination of a single particle state and the ground state. But this is precisely what will happen if $\langle 0|\varphi(0)|0\rangle$ is not zero.

So, if $v \equiv \langle 0|\varphi(0)|0\rangle$ is not zero, we will shift the field $\varphi(x)$ by the constant v . This means that we go back to the lagrangian, and replace $\varphi(x)$ everywhere by $\varphi(x) + v$. This is just a change of the name of the operator of interest, and does not affect the physics. However, the shifted $\varphi(x)$ obeys $\langle 0|\varphi(x)|0\rangle = 0$.

Let us now consider $\langle p|\varphi(x)|0\rangle$, where $|p\rangle$ is a one-particle state with four-momentum p , normalized according to eq. (120). Again using eq. (131), we have

$$\begin{aligned}\langle p|\varphi(x)|0\rangle &= \langle p|e^{-iPx}\varphi(0)e^{+iPx}|0\rangle \\ &= e^{-ipx}\langle p|\varphi(0)|0\rangle ,\end{aligned}\tag{133}$$

where $\langle p|\varphi(0)|0\rangle$ is a Lorentz-invariant number. It is a function of p , but the only Lorentz-invariant functions of p are functions of p^2 , and p^2 is just the constant $-m^2$. So $\langle p|\varphi(0)|0\rangle$ is just some number that depends on m and (presumably) the other parameters in the lagrangian.

We would like $\langle p|\varphi(0)|0\rangle$ to be one. That is what it is in free-field theory, and we know that, in free-field theory, $a_1^\dagger(\pm\infty)$ creates a correctly normalized one-particle state. Thus, for $a_1^\dagger(\pm\infty)$ to create a correctly normalized one-particle state in the interacting theory, we must have $\langle p|\varphi(0)|0\rangle = 1$.

So, if $v \equiv \langle 0|\varphi(0)|0\rangle$ is not zero, we will shift the field $\varphi(x)$ by the constant v . This means that we go back to the lagrangian, and replace $\varphi(x)$ everywhere by $\varphi(x) + v$. This is just a change of the name of the operator of interest, and does not affect the physics. However, the shifted $\varphi(x)$ obeys $\langle 0|\varphi(x)|0\rangle = 0$.

So, if $\langle p|\varphi(0)|0\rangle$ is not equal to one, we will rescale (or, one might say, *renormalize*) $\varphi(x)$ by a multiplicative constant. This is just a change of the name of the operator of interest, and does not affect the physics. However, the rescaled $\varphi(x)$ obeys $\langle p|\varphi(0)|0\rangle = 1$.

Finally, consider $\langle p, n|\varphi(x)|0\rangle$, where $|p, n\rangle$ is a multiparticle state with total four-momentum p , and n is short for all other labels (such as relative momenta) needed to specify this state. We have

$$\begin{aligned}\langle p, n|\varphi(x)|0\rangle &= \langle p, n|e^{-iPx}\varphi(0)e^{+iPx}|0\rangle \\ &= e^{-ipx}\langle p, n|\varphi(0)|0\rangle \\ &= e^{-ipx}A_n(\mathbf{p}) ,\end{aligned}\tag{134}$$

where $A_n(\mathbf{p})$ is a function of Lorentz invariant products of the various (relative and total) four-momenta needed to specify the state. Note that, from fig. (1), $p^0 = (\mathbf{p}^2 + M^2)^{1/2}$ with $M \geq 2m$. The invariant mass M is one of the parameters included in the set n .

We would like $\langle p, n|\varphi(x)|0\rangle$ to be zero, because we would like $a_1^\dagger(\pm\infty)$, when acting on $|0\rangle$, to create a single particle state. We do *not* want $a_1^\dagger(\pm\infty)$ to create any multiparticle states. But this is precisely what may happen if $\langle p, n|\varphi(x)|0\rangle$ is not zero.

Actually, we are being a little too strict. We really need $\langle p, n|a_1^\dagger(\pm\infty)|0\rangle$ to be zero, and perhaps it will be zero even if $\langle p, n|\varphi(x)|0\rangle$ is not. Also, we really should test $a_1^\dagger(\pm\infty)|0\rangle$ only against *normalizable* states. Mathematically, non-normalizable states cause all sorts of trouble; mathematicians don't consider them to be states at all. In physics, this usually doesn't bother us, but here we must be especially careful. So let us write

$$|\psi\rangle = \sum_n \int d^3p \psi_n(\mathbf{p})|p, n\rangle ,\tag{135}$$

where the $\psi_n(\mathbf{p})$'s are wave packets for the total three-momentum \mathbf{p} . Note that eq. (135) is highly schematic; the sum over n is shorthand for integrals over various continuous parameters (relative momenta).

Now we want to examine

$$\langle \psi | a_1^\dagger(t) | 0 \rangle = -i \sum_n \int d^3p \psi_n^*(\mathbf{p}) \int d^3k f_1(\mathbf{k}) \int d^3x e^{ikx} \overleftrightarrow{\partial}_0 \langle p, n | \varphi(x) | 0 \rangle. \quad (136)$$

We will take the limit $t \rightarrow \pm\infty$ in a moment. Using eq. (134), eq. (136) becomes

$$\begin{aligned} \langle \psi | a_1^\dagger(t) | 0 \rangle &= -i \sum_n \int d^3p \psi_n^*(\mathbf{p}) \int d^3k f_1(\mathbf{k}) \int d^3x (e^{ikx} \overleftrightarrow{\partial}_0 e^{-ipx}) A_n(\mathbf{p}) \\ &= \sum_n \int d^3p \psi_n^*(\mathbf{p}) \int d^3k f_1(\mathbf{k}) \int d^3x (p^0 + k^0) e^{i(k-p)x} A_n(\mathbf{p}). \end{aligned} \quad (137)$$

Next we use $\int d^3x e^{i(\mathbf{k}-\mathbf{p})\cdot\mathbf{x}} = (2\pi)^3 \delta^3(\mathbf{k} - \mathbf{p})$ to get

$$\langle \psi | a_1^\dagger(t) | 0 \rangle = \sum_n \int d^3p (2\pi)^3 (p^0 + k^0) \psi_n^*(\mathbf{p}) f_1(\mathbf{p}) A_n(\mathbf{p}) e^{i(p^0 - k^0)t}, \quad (138)$$

where $p^0 = (\mathbf{p}^2 + M^2)^{1/2}$ and $k^0 = (\mathbf{p}^2 + m^2)^{1/2}$.

Now comes the key point. Note that p^0 is strictly greater than k^0 , because $M \geq 2m$. Thus the integrand of eq. (138) contains a phase factor that oscillates more and more rapidly as $|\mathbf{p}| \rightarrow \infty$. Therefore, by the *Riemann-Lebesgue lemma*, the right-hand side of eq. (138) vanishes as $t \rightarrow \pm\infty$.

Physically, this means that a one-particle wave packet spreads out differently than a multiparticle wave packet, and the overlap between them goes to zero as the elapsed time goes to infinity. Thus, even though our operator $a_1^\dagger(t)$ creates some multiparticle states that we don't want, we can "follow" the one-particle state that we do want by using an appropriate wave packet. By waiting long enough, we can make the multiparticle contribution to the scattering amplitude as small as we like.

Let us recap. The basic formula for a scattering amplitude in terms of the fields of an interacting quantum field theory is the LSZ formula, which is worth writing down again:

$$\langle f | i \rangle = i^{n+n'} \int d^4x_1 e^{ik_1x_1} (-\partial_1^2 + m^2) \dots$$

$$d^4x_1' e^{-ik_1'x_1'}(-\partial_{1'}^2 + m^2) \dots \times \langle 0 | T \varphi(x_1) \dots \varphi(x_1') \dots | 0 \rangle . \quad (139)$$

The LSZ formula is valid *provided* that the field obeys

$$\langle 0 | \varphi(x) | 0 \rangle = 0 \quad \text{and} \quad \langle k | \varphi(x) | 0 \rangle = e^{-ikx} . \quad (140)$$

These normalization conditions may conflict with our original choice of field and parameter normalization in the lagrangian. Consider, for example, a lagrangian originally specified as

$$\mathcal{L} = -\frac{1}{2} \partial^\mu \varphi \partial_\mu \varphi - \frac{1}{2} m^2 \varphi^2 + \frac{1}{6} g \varphi^3 . \quad (141)$$

After shifting and rescaling (and renaming some parameters), we will have instead

$$\mathcal{L} = -\frac{1}{2} Z_\varphi \partial^\mu \varphi \partial_\mu \varphi - \frac{1}{2} Z_m m^2 \varphi^2 + \frac{1}{6} Z_g g \varphi^3 + Y \varphi . \quad (142)$$

Here the three Z 's and Y are as yet unknown constants. They must be chosen to ensure the validity of eq. (140); this gives us two conditions in four unknowns. We also require that the parameter m in \mathcal{L} be the actual, physical mass of the particle. Finally, the parameter g is fixed in terms of some particular scattering cross section by some definite formula. (For example, in quantum electrodynamics, the parameter analogous to g is the electron charge e . The low-energy Coulomb scattering cross section is proportional to e^2 , with a definite constant of proportionality and no higher-order corrections; this relationship defines e .) Thus we have four conditions in four unknowns, and it is possible to calculate Y and the three Z 's order by order in perturbation theory.

Next, we must develop the tools needed to compute the correlation functions $\langle 0 | T \varphi(x_1) \dots | 0 \rangle$ in an interacting quantum field theory.

Problems

5.1) Work out the LSZ reduction formula for the complex scalar field that was introduced in problem 3.3. Note that we must specify the type (a or b) of each incoming and outgoing particle.

6: Path Integrals in Quantum Mechanics

Prerequisite: none

Consider the nonrelativistic quantum mechanics of one particle in one dimension; the hamiltonian is

$$H(P, Q) = \frac{1}{2m}P^2 + V(Q), \quad (143)$$

where P and Q are operators obeying $[Q, P] = i$. (We set $\hbar = 1$ for notational convenience.) We wish to evaluate the probability amplitude for the particle to start at position q' at time t' , and end at position q'' at time t'' . This amplitude is $\langle q'' | e^{-iH(t''-t')} | q' \rangle$, where $|q'\rangle$ and $|q''\rangle$ are eigenstates of the position operator Q .

We can also formulate this question in the Heisenberg picture, where operators are time dependent and the state of the system is time independent, as opposed to the more familiar Schrödinger picture. In the Heisenberg picture, we write $Q(t) = e^{iHt} Q e^{-iHt}$. We can then define an instantaneous eigenstate of $Q(t)$ via $Q(t)|q, t\rangle = q|q, t\rangle$. These instantaneous eigenstates can be expressed explicitly as $|q, t\rangle = e^{+iHt}|q\rangle$, where $Q|q\rangle = q|q\rangle$. Then our transition amplitude can be written as $\langle q'', t'' | q', t' \rangle$ in the Heisenberg picture.

To evaluate $\langle q'', t'' | q', t' \rangle$, we begin by dividing the time interval $T \equiv t'' - t'$ into $N + 1$ equal pieces of duration $\delta t = T/(N + 1)$. Then introduce N complete sets of position eigenstates to get

$$\langle q'', t'' | q', t' \rangle = \int \prod_{j=1}^N dq_j \langle q'' | e^{-iH\delta t} | q_N \rangle \langle q_N | e^{-iH\delta t} | q_{N-1} \rangle \dots \langle q_1 | e^{-iH\delta t} | q' \rangle. \quad (144)$$

The integrals over the q 's all run from $-\infty$ to $+\infty$.

Now consider $\langle q_2 | e^{-iH\delta t} | q_1 \rangle$. We can use the Campbell-Baker-Hausdorff formula

$$\exp(A + B) = \exp(A) \exp(B) \exp(-\frac{1}{2}[A, B] + \dots) \quad (145)$$

to write

$$\exp(-iH\delta t) = \exp[-i(\delta t/2m)P^2] \exp[-i\delta tV(Q)] \exp[O(\delta t^2)] . \quad (146)$$

Then, in the limit of small δt , we should be able to ignore the final exponential. Inserting a complete set of momentum states then gives

$$\begin{aligned} \langle q_2 | e^{-iH\delta t} | q_1 \rangle &= \int dp_1 \langle q_2 | e^{-i(\delta t/2m)P^2} | p_1 \rangle \langle p_1 | e^{-i\delta tV(Q)} | q_1 \rangle \\ &= \int dp_1 e^{-i(\delta t/2m)p_1^2} e^{-i\delta tV(q_1)} \langle q_2 | p_1 \rangle \langle p_1 | q_1 \rangle \\ &= \int \frac{dp_1}{2\pi} e^{-i(\delta t/2m)p_1^2} e^{-i\delta tV(q_1)} e^{ip_1(q_2 - q_1)} . \\ &= \int \frac{dp_1}{2\pi} e^{-iH(p_1, q_1)\delta t} e^{ip_1(q_2 - q_1)} . \end{aligned} \quad (147)$$

To get the third line, we used $\langle q | p \rangle = (2\pi)^{-1/2} \exp(ipq)$.

If we happen to be interested in more general hamiltonians than eq. (143), then we must worry about the ordering of the P and Q operators in any term that contains both. If we adopt *Weyl ordering*, where the quantum hamiltonian $H(P, Q)$ is given in terms of the classical hamiltonian $H(p, q)$ by

$$H(P, Q) \equiv \int \frac{dx}{2\pi} \frac{dk}{2\pi} e^{ixP + ikQ} \int dp dq e^{-ixp - ikq} H(p, q) , \quad (148)$$

then eq. (147) is not quite correct; in the last line, $H(p_1, q_1)$ should be replaced with $H(p_1, \bar{q})$, where $\bar{q} = \frac{1}{2}(q_1 + q_2)$. For the hamiltonian of eq. (143), which is Weyl ordered, this replacement makes no difference in the limit $\delta t \rightarrow 0$.

Adopting Weyl ordering for the general case, we now have

$$\langle q'', t'' | q', t' \rangle = \int dp_0 \prod_{j=1}^N \frac{dp_j dq_j}{2\pi} e^{ip_j(q_{j+1} - q_j)} e^{-iH(p_j, \bar{q}_j)\delta t} , \quad (149)$$

where $\bar{q}_j = \frac{1}{2}(q_{j+1} + q_j)$. If we now define $\dot{q}_j \equiv (q_{j+1} - q_j)/\delta t$, and take the formal limit of $\delta t \rightarrow 0$, then

$$\langle q'', t'' | q', t' \rangle = \int \mathcal{D}p \mathcal{D}q \exp \left[i \int_{t'}^{t''} dt (p(t)\dot{q}(t) - H(p(t), q(t))) \right] . \quad (150)$$

The integration is to be understood as over all paths in phase space that start at $q(t') = q'$ (with an arbitrary value of the initial momentum) and end at $q(t'') = q''$ (with an arbitrary value of the final momentum).

If $H(p, q)$ is no more than quadratic in the momenta [as is the case for eq. (143)], then the integral over p is gaussian, and can be done in closed form. If the term that is quadratic in p is independent of q [as is the case for eq. (143)], then the prefactors generated by the gaussian integrals are all constants, and can be absorbed into the definition of $\mathcal{D}q$. The result of integrating out p is then

$$\langle q'', t'' | q', t' \rangle = \int \mathcal{D}q \exp \left[i \int_{t'}^{t''} dt L(\dot{q}(t), q(t)) \right], \quad (151)$$

where $L(\dot{q}, q)$ is computed by first finding the stationary point of the p integral by solving

$$0 = \frac{\partial}{\partial p} (p\dot{q} - H(p, q)) = \dot{q} - \frac{\partial H(p, q)}{\partial p} \quad (152)$$

for p in terms of \dot{q} and q , and then plugging this solution back into $p\dot{q} - H$ to get L . We recognize this procedure from classical mechanics: we are passing from the hamiltonian formulation to the lagrangian formulation.

Now that we have eqs. (150) and (151), what are we going to do with them? Let us begin by considering some generalizations; let us examine, for example, $\langle q'', t'' | Q(t_1) | q', t' \rangle$, where $t' < t_1 < t''$. This is given by

$$\langle q'', t'' | Q(t_1) | q', t' \rangle = \langle q'' | e^{-iH(t''-t_1)} Q e^{-iH(t_1-t')} | q' \rangle. \quad (153)$$

In the path integral formula, the extra operator Q inserted at time t_1 will simply result in an extra factor of $q(t_1)$. Thus

$$\langle q'', t'' | Q(t_1) | q', t' \rangle = \int \mathcal{D}p \mathcal{D}q q(t_1) e^{iS}, \quad (154)$$

where $S = \int_{t'}^{t''} dt (p\dot{q} - H)$. Now let us go in the other direction; consider $\int \mathcal{D}p \mathcal{D}q q(t_1) q(t_2) e^{iS}$. This clearly requires the operators $Q(t_1)$ and $Q(t_2)$, but their order depends on whether $t_1 < t_2$ or $t_2 < t_1$. Thus we have

$$\int \mathcal{D}p \mathcal{D}q q(t_1) q(t_2) e^{iS} = \langle q'', t'' | T Q(t_1) Q(t_2) | q', t' \rangle. \quad (155)$$

where \mathbb{T} is the *time ordering symbol*: a product of operators to its right is to be ordered, not as written, but with operators at later times to the left of those at earlier times. This is significant, because time-ordered products enter into the LSZ formula for scattering amplitudes.

To further develop these methods, we need another trick: *functional derivatives*. We define the functional derivative $\delta/\delta f(t)$ via

$$\frac{\delta}{\delta f(t_1)} f(t_2) = \delta(t_1 - t_2) , \quad (156)$$

where $\delta(t)$ is the Dirac delta function. Also, functional derivatives are defined to satisfy all the usual rules of derivatives (product rule, chain rule, etc). Eq. (156) can be thought of as the continuous generalization of $(\partial/\partial x_i)x_j = \delta_{ij}$.

Now, consider modifying the lagrangian of our theory by including external forces acting on the particle:

$$H(p, q) \rightarrow H(p, q) - f(t)q(t) - h(t)p(t) , \quad (157)$$

where $f(t)$ and $h(t)$ are specified functions. In this case we will write

$$\langle q'', t'' | q', t' \rangle_{f,h} = \int \mathcal{D}p \mathcal{D}q \exp \left[i \int_{t'}^{t''} dt (p\dot{q} - H + fq + hp) \right] . \quad (158)$$

where H is the original hamiltonian. Then we have

$$\begin{aligned} \frac{1}{i} \frac{\delta}{\delta f(t_1)} \langle q'', t'' | q', t' \rangle_{f,h} &= \int \mathcal{D}p \mathcal{D}q q(t_1) e^{i \int dt [p\dot{q} - H + fq + hp]} , \\ \frac{1}{i} \frac{\delta}{\delta f(t_1)} \frac{1}{i} \frac{\delta}{\delta f(t_2)} \langle q'', t'' | q', t' \rangle_{f,h} &= \int \mathcal{D}p \mathcal{D}q q(t_1)q(t_2) e^{i \int dt [p\dot{q} - H + fq + hp]} , \\ \frac{1}{i} \frac{\delta}{\delta h(t_1)} \langle q'', t'' | q', t' \rangle_{f,h} &= \int \mathcal{D}p \mathcal{D}q p(t_1) e^{i \int dt [p\dot{q} - H + fq + hp]} , \end{aligned} \quad (159)$$

and so on. After we are done bringing down as many factors of $q(t_i)$ or $p(t_i)$ as we like, we can set $f(t) = h(t) = 0$, and return to the original hamiltonian. Thus,

$$\begin{aligned} &\langle q'', t'' | \mathbb{T}Q(t_1) \dots P(t_n) \dots | q', t' \rangle \\ &= \frac{1}{i} \frac{\delta}{\delta f(t_1)} \dots \frac{1}{i} \frac{\delta}{\delta h(t_n)} \dots \langle q'', t'' | q', t' \rangle_{f,h} \Big|_{f=h=0} . \end{aligned} \quad (160)$$

Suppose we are also interested in initial and final states other than position eigenstates. Then we must multiply by the wave functions for these states, and integrate. We will be interested, in particular, in the ground state as both the initial and final state. Also, we will take the limits $t' \rightarrow -\infty$ and $t'' \rightarrow +\infty$. The object of our attention is then

$$\langle 0|0\rangle_{f,h} = \lim_{\substack{t' \rightarrow -\infty \\ t'' \rightarrow +\infty}} \int dq'' dq' \psi_0^*(q'') \langle q'', t'' | q', t' \rangle_{f,h} \psi_0(q') , \quad (161)$$

where $\psi_0(q) = \langle q|0\rangle$ is the ground-state wave function. Eq. (161) is a rather cumbersome formula, however. We will, therefore, employ a trick to simplify it.

Let $|n\rangle$ denote an eigenstate of H with eigenvalue E_n . We will suppose that $E_0 = 0$; if this is not the case, we will shift H by an appropriate constant. Next we write

$$\begin{aligned} |q', t'\rangle &= e^{iHt'} |q'\rangle \\ &= \sum_{n=0}^{\infty} e^{iHt'} |n\rangle \langle n|q'\rangle \\ &= \sum_{n=0}^{\infty} \psi_n^*(q') e^{iE_n t'} |n\rangle , \end{aligned} \quad (162)$$

where $\psi_n(q) = \langle q|n\rangle$ is the wave function of the n th eigenstate. Now, replace H with $(1-i\epsilon)H$ in eq. (162), where ϵ is a small positive infinitesimal. Then, take the limit $t' \rightarrow -\infty$ of eq. (162) with ϵ held fixed. Every state except the ground state is then multiplied by a vanishing exponential factor, and so the limit is simply $\psi_0^*(q')|0\rangle$. Next, multiply by an arbitrary function $\chi(q')$, and integrate over q' . The only requirement is that $\langle 0|\chi\rangle \neq 0$. We then have a constant times $|0\rangle$, and this constant can be absorbed into the normalization of the path integral. A similar analysis of $\langle q'', t''| = \langle q''|e^{-iHt''}$ shows that the replacement $H \rightarrow (1-i\epsilon)H$ also picks out the ground state as the final state in the $t'' \rightarrow +\infty$ limit.

What all this means is that if we use $(1-i\epsilon)H$ instead of H , we can be cavalier about the boundary conditions on the endpoints of the path. Any reasonable boundary conditions will result in the ground state as both the

initial and final state. Thus we have

$$\langle 0|0\rangle_{f,h} = \int \mathcal{D}p \mathcal{D}q \exp\left[i \int_{-\infty}^{+\infty} dt (p\dot{q} - (1-i\epsilon)H + fq + hp)\right]. \quad (163)$$

Now let us suppose that $H = H_0 + H_1$, where we can solve for the eigenstates and eigenvalues of H_0 , and H_1 can be treated as a perturbation. Suppressing the $i\epsilon$, eq. (163) can be written as

$$\begin{aligned} \langle 0|0\rangle_{f,h} &= \int \mathcal{D}p \mathcal{D}q \exp\left[i \int_{-\infty}^{+\infty} dt (p\dot{q} - H_0(p, q) - H_1(p, q) + fq + hp)\right] \\ &= \exp\left[-i \int_{-\infty}^{+\infty} dt H_1\left(\frac{1}{i} \frac{\delta}{\delta h(t)}, \frac{1}{i} \frac{\delta}{\delta f(t)}\right)\right] \\ &\quad \times \int \mathcal{D}p \mathcal{D}q \exp\left[i \int_{-\infty}^{+\infty} dt (p\dot{q} - H_0(p, q) + fq + hp)\right]. \end{aligned} \quad (164)$$

To understand the second line of this equation, take the exponential prefactor inside the path integral. Then the functional derivatives (that appear as the arguments of H_1) just pull out appropriate factors of $p(t)$ and $q(t)$, generating the right-hand side of the first line. We presumably can compute the functional integral in the second line, since it involves only the solvable hamiltonian H_0 . The exponential prefactor can then be expanded in powers of H_1 to generate a perturbation series.

If H_1 depends only on q (and not on p), and if we are only interested in time-ordered products of Q 's (and not P 's), and if H is no more than quadratic in P , and if the term quadratic in P does not involve Q , *then* eq. (164) can be simplified to

$$\begin{aligned} \langle 0|0\rangle_f &= \exp\left[i \int_{-\infty}^{+\infty} dt L_1\left(\frac{1}{i} \frac{\delta}{\delta f(t)}\right)\right] \\ &\quad \times \int \mathcal{D}q \exp\left[i \int_{-\infty}^{+\infty} dt (L_0(\dot{q}, q) + fq)\right]. \end{aligned} \quad (165)$$

where $L_1(q) = -H_1(q)$.

Problems

6.1a) Find an explicit formula for $\mathcal{D}q$ in eq. (151). Your formula should be of the form $\mathcal{D}q = C \prod_{j=1}^N dq_j$, where C is a constant that you should compute.

b) For the case of a free particle, $V(Q) = 0$, evaluate the path integral of eq. (151) explicitly. Hint: integrate over q_1 , then q_2 , etc, and look for a pattern. Express your final answer in terms of q' , t' , q'' , t'' , and m . Restore \hbar by dimensional analysis.

c) Compute $\langle q'', t'' | q', t' \rangle = \langle q'' | e^{-iH(t''-t')} | q' \rangle$ by inserting a complete set of momentum eigenstates, and performing the integral over the momentum. Compare with your result in part (b).

7: The Path Integral for the Harmonic Oscillator

Prerequisite: 6

Consider a harmonic oscillator with hamiltonian

$$H(P, Q) = \frac{1}{2m}P^2 + \frac{1}{2}m\omega^2Q^2 . \quad (166)$$

We begin with the formula from section 6 for the ground state to ground state transition amplitude in the presence of an external force, specialized to the case of a harmonic oscillator:

$$\langle 0|0\rangle_f = \int \mathcal{D}p \mathcal{D}q \exp i \int_{-\infty}^{+\infty} dt [pq - (1-i\epsilon)H + fq] . \quad (167)$$

Looking at eq.(166), we see that multiplying H by $1-i\epsilon$ is equivalent to the replacements $m^{-1} \rightarrow (1-i\epsilon)m^{-1}$ [or, equivalently, $m \rightarrow (1+i\epsilon)m$] and $m\omega^2 \rightarrow (1-i\epsilon)m\omega^2$. Passing to the lagrangian formulation then gives

$$\langle 0|0\rangle_f = \int \mathcal{D}q \exp i \int_{-\infty}^{+\infty} dt \left[\frac{1}{2}(1+i\epsilon)m\dot{q}^2 - \frac{1}{2}(1-i\epsilon)m\omega^2q^2 + fq \right] . \quad (168)$$

From now on, we will simplify the notation by setting $m = 1$.

Next, let us use Fourier-transformed variables,

$$\tilde{q}(E) = \int_{-\infty}^{+\infty} dt e^{iEt} q(t) , \quad q(t) = \int_{-\infty}^{+\infty} \frac{dE}{2\pi} e^{-iEt} \tilde{q}(E) . \quad (169)$$

The expression in square brackets in eq. (168) becomes

$$\begin{aligned} [\dots] = \frac{1}{2} \int_{-\infty}^{+\infty} \frac{dE}{2\pi} \frac{dE'}{2\pi} e^{-i(E+E')t} & \left[\left(-(1+i\epsilon)EE' - (1-i\epsilon)\omega^2 \right) \tilde{q}(E)\tilde{q}(E') \right. \\ & \left. + \tilde{f}(E)\tilde{q}(E') + \tilde{f}(E')\tilde{q}(E) \right] . \end{aligned} \quad (170)$$

Note that the only t dependence is now in the prefactor. Integrating over t then generates a factor of $2\pi\delta(E + E')$. Then we can easily integrate over E' to get

$$\begin{aligned}
S &= \int_{-\infty}^{+\infty} dt [\dots] \\
&= \frac{1}{2} \int_{-\infty}^{+\infty} \frac{dE}{2\pi} \left[\left((1+i\epsilon)E^2 - (1-i\epsilon)\omega^2 \right) \tilde{q}(E)\tilde{q}(-E) \right. \\
&\quad \left. + \tilde{f}(E)\tilde{q}(-E) + \tilde{f}(-E)\tilde{q}(E) \right]. \tag{171}
\end{aligned}$$

The factor in large parentheses is equal to $E^2 - \omega^2 + i(E^2 + \omega^2)\epsilon$, and we can absorb the positive coefficient into ϵ to get $E^2 - \omega^2 + i\epsilon$.

Now it is convenient to change integration variables to

$$\tilde{x}(E) = \tilde{q}(E) + \frac{\tilde{f}(E)}{E^2 - \omega^2 + i\epsilon}. \tag{172}$$

Then we get

$$S = \frac{1}{2} \int_{-\infty}^{+\infty} \frac{dE}{2\pi} \left[\tilde{x}(E)(E^2 - \omega^2 + i\epsilon)\tilde{x}(-E) - \frac{\tilde{f}(E)\tilde{f}(-E)}{E^2 - \omega^2 + i\epsilon} \right]. \tag{173}$$

Furthermore, because eq. (172) is just a shift by a constant, $\mathcal{D}q = \mathcal{D}x$. Now we have

$$\begin{aligned}
\langle 0|0 \rangle_f &= \exp \left[\frac{i}{2} \int_{-\infty}^{+\infty} \frac{dE}{2\pi} \frac{\tilde{f}(E)\tilde{f}(-E)}{-E^2 + \omega^2 - i\epsilon} \right] \\
&\quad \times \int \mathcal{D}x \exp \left[\frac{i}{2} \int_{-\infty}^{+\infty} \frac{dE}{2\pi} \tilde{x}(E)(E^2 - \omega^2 + i\epsilon)\tilde{x}(-E) \right]. \tag{174}
\end{aligned}$$

Now comes the key point. The path integral on the second line of eq. (174) is what we get for $\langle 0|0 \rangle_f$ in the case $f = 0$. On the other hand, if there is no external force, a system in its ground state will remain in its ground state, and so $\langle 0|0 \rangle_{f=0} = 1$. Thus we find

$$\langle 0|0 \rangle_f = \exp \left[\frac{i}{2} \int_{-\infty}^{+\infty} \frac{dE}{2\pi} \frac{\tilde{f}(E)\tilde{f}(-E)}{-E^2 + \omega^2 - i\epsilon} \right]. \tag{175}$$

We can also rewrite this in terms of time-domain variables as

$$\langle 0|0\rangle_f = \exp\left[\frac{i}{2} \int_{-\infty}^{+\infty} dt dt' f(t)G(t-t')f(t')\right], \quad (176)$$

where

$$G(t-t') = \int_{-\infty}^{+\infty} \frac{dE}{2\pi} \frac{e^{-iE(t-t')}}{-E^2 + \omega^2 - i\epsilon}. \quad (177)$$

Note that $G(t-t')$ is a Green's function for the oscillator equation of motion:

$$\left(\frac{\partial^2}{\partial t^2} + \omega^2\right) G(t-t') = \delta(t-t'). \quad (178)$$

This can be seen directly by plugging eq. (177) into eq. (178) and then taking the $\epsilon \rightarrow 0$ limit. We can also evaluate $G(t-t')$ explicitly by contour integration; the result is

$$G(t-t') = \frac{i}{2\omega} \exp(-i\omega|t-t'|). \quad (179)$$

Consider now the formula from section 6 for the time-ordered product of operators. In the case of initial and final ground states, it becomes

$$\langle 0|TQ(t_1) \dots |0\rangle = \frac{1}{i} \frac{\delta}{\delta f(t_1)} \dots \langle 0|0\rangle_f \Big|_{f=0}. \quad (180)$$

Using our explicit formula, eq. (176), we have

$$\begin{aligned} \langle 0|TQ(t_1)Q(t_2)|0\rangle &= \frac{1}{i} \frac{\delta}{\delta f(t_1)} \frac{1}{i} \frac{\delta}{\delta f(t_2)} \langle 0|0\rangle_f \Big|_{f=0} \\ &= \frac{1}{i} \frac{\delta}{\delta f(t_1)} \left[\int_{-\infty}^{+\infty} dt' G(t_2-t')f(t') \right] \langle 0|0\rangle_f \Big|_{f=0} \\ &= \left[\frac{1}{i} G(t_2-t_1) + (\text{term with } f\text{'s}) \right] \langle 0|0\rangle_f \Big|_{f=0} \\ &= \frac{1}{i} G(t_2-t_1). \end{aligned} \quad (181)$$

We can continue in this way to compute the ground-state expectation value of the time-ordered product of more $Q(t)$'s. If the number of $Q(t)$'s is odd, then there is always a left-over $f(t)$ in the prefactor, and so the result is

zero. If the number of $Q(t)$'s is even, then we must pair up the functional derivatives in an appropriate way to get a nonzero result. Thus, for example,

$$\begin{aligned} \langle 0 | T Q(t_1) Q(t_2) Q(t_3) Q(t_4) | 0 \rangle &= \frac{1}{i^2} \left[G(t_1 - t_2) G(t_3 - t_4) \right. \\ &\quad + G(t_1 - t_3) G(t_2 - t_4) \\ &\quad \left. + G(t_1 - t_4) G(t_2 - t_3) \right]. \end{aligned} \quad (182)$$

More generally,

$$\langle 0 | T Q(t_1) \dots Q(t_{2n}) | 0 \rangle = \frac{1}{i^n} \sum_{\text{pairings}} G(t_{i_1} - t_{i_2}) \dots G(t_{i_{2n-1}} - t_{i_{2n}}). \quad (183)$$

Problems

7.1) Starting with eq. (177), verify eq. (179).

7.2) Starting with eq. (179), verify eq. (178).

7.3a) Use the Heisenberg equation of motion, $\dot{A} = i[H, A]$, to find explicit expressions for \dot{Q} and \dot{P} . Solve these to get the Heisenberg-picture operators $Q(t)$ and $P(t)$ in terms of the Schrödinger picture operators Q and P .

b) Write the Schrödinger picture operators Q and P in terms of the creation and annihilation operators a and a^\dagger , where $H = \hbar\omega(a^\dagger a + \frac{1}{2})$. Then, using your result from part (a), write the Heisenberg-picture operators $Q(t)$ and $P(t)$ in terms of a and a^\dagger .

c) Using your result from part (b), and $a|0\rangle = \langle 0|a^\dagger = 0$, verify eq. (181).

8: The Path Integral for Free Field Theory

Prerequisite: 3, 7

Our results for the harmonic oscillator can be straightforwardly generalized to a free field theory with hamiltonian density

$$\mathcal{H}_0 = \frac{1}{2}\Pi^2 + \frac{1}{2}(\nabla\varphi)^2 + \frac{1}{2}m^2\varphi^2 . \quad (184)$$

The dictionary we need is

$$\begin{aligned} q(t) &\longrightarrow \varphi(\mathbf{x}, t) && \text{(classical field)} \\ Q(t) &\longrightarrow \varphi(\mathbf{x}, t) && \text{(operator field)} \\ f(t) &\longrightarrow J(\mathbf{x}, t) && \text{(classical source)} \end{aligned} \quad (185)$$

The distinction between the classical field $\varphi(x)$ and the corresponding operator field should be clear from context.

To employ the ϵ trick, we multiply \mathcal{H}_0 by $1 - i\epsilon$. The results are equivalent to replacing m^2 in \mathcal{H}_0 with $m^2 - i\epsilon$. From now on, for notational simplicity, we will write m^2 when we really mean $m^2 - i\epsilon$.

Let us write down the path integral (also called the *functional integral*) for our free field theory:

$$Z_0(J) \equiv \langle 0|0 \rangle_J = \int \mathcal{D}\varphi e^{i \int d^4x [\mathcal{L}_0 + J\varphi]} , \quad (186)$$

where

$$\mathcal{L}_0 = -\frac{1}{2}\partial^\mu\varphi\partial_\mu\varphi - \frac{1}{2}m^2\varphi^2 . \quad (187)$$

Note that when we say *path integral*, we now mean a path in the space of field configurations.

We can evaluate $Z_0(J)$ by mimicking what we did for the harmonic oscillator in section 7. We introduce four-dimensional Fourier transforms,

$$\tilde{\varphi}(k) = \int d^4x e^{-ikx} \varphi(x), \quad \varphi(x) = \int \frac{d^4k}{(2\pi)^4} e^{ikx} \tilde{\varphi}(k), \quad (188)$$

where $kx = -k^0t + \mathbf{k} \cdot \mathbf{x}$, and k^0 is an integration variable. Then, starting with $S_0 = \int d^4x [\mathcal{L}_0 + J\varphi]$, we get

$$S_0 = \frac{1}{2} \int \frac{d^4k}{(2\pi)^4} [-\tilde{\varphi}(k)(k^2 + m^2)\tilde{\varphi}(-k) + \tilde{J}(k)\tilde{\varphi}(-k) + \tilde{J}(-k)\tilde{\varphi}(k)], \quad (189)$$

where $k^2 = \mathbf{k}^2 - (k^0)^2$. We now change path integration variables to

$$\tilde{\chi}(k) = \tilde{\varphi}(k) - \frac{\tilde{J}(k)}{k^2 + m^2}. \quad (190)$$

Since this is merely a shift by a constant, we have $\mathcal{D}\varphi = \mathcal{D}\chi$. The action becomes

$$S_0 = \frac{1}{2} \int \frac{d^4k}{(2\pi)^4} \left[\frac{\tilde{J}(k)\tilde{J}(-k)}{k^2 + m^2} - \tilde{\chi}(k)(k^2 + m^2)\tilde{\chi}(-k) \right]. \quad (191)$$

Just as for the harmonic oscillator, the integral over χ simply yields a factor of $Z_0(0) = \langle 0|0 \rangle_{J=0} = 1$. Therefore

$$\begin{aligned} Z_0(J) &= \exp \left[\frac{i}{2} \int \frac{d^4k}{(2\pi)^4} \frac{\tilde{J}(k)\tilde{J}(-k)}{k^2 + m^2 - i\epsilon} \right] \\ &= \exp \left[\frac{i}{2} \int d^4x d^4x' J(x)\Delta(x-x')J(x') \right]. \end{aligned} \quad (192)$$

Here we have defined the *Feynman propagator*,

$$\Delta(x-x') = \int \frac{d^4k}{(2\pi)^4} \frac{e^{ik(x-x')}}{k^2 + m^2 - i\epsilon}. \quad (193)$$

The Feynman propagator is a Green's function for the Klein-Gordon equation,

$$(-\partial_x^2 + m^2)\Delta(x-x') = \delta^4(x-x'). \quad (194)$$

This can be seen directly by plugging eq. (193) into eq. (194) and then taking the $\epsilon \rightarrow 0$ limit. We can also evaluate $\Delta(x - x')$ explicitly by treating the k^0 integral on the right-hand side of eq. (193) as a contour integration in the complex k^0 plane, and then evaluating the contour integral via the residue theorem. The result is

$$\begin{aligned}\Delta(x - x') &= \int \widetilde{dk} e^{i\mathbf{k}\cdot(\mathbf{x}-\mathbf{x}')-i\omega|t-t'|} \\ &= i\theta(t-t') \int \widetilde{dk} e^{ik(x-x')} + i\theta(t'-t) \int \widetilde{dk} e^{-ik(x-x')} ,\end{aligned}\quad (195)$$

where $\theta(t)$ is the unit step function. The integral over \widetilde{dk} can also be performed in terms of Bessel functions; see section 4.

Now, by analogy with the formula for the ground-state expectation value of a time-ordered product of operators for the harmonic oscillator, we have

$$\langle 0 | \mathbb{T} \varphi(x_1) \dots | 0 \rangle = \frac{1}{i} \frac{\delta}{\delta J(x_1)} \dots Z_0(J) \Big|_{J=0} . \quad (196)$$

Using our explicit formula, eq. (192), we have

$$\begin{aligned}\langle 0 | \mathbb{T} \varphi(x_1) \varphi(x_2) | 0 \rangle &= \frac{1}{i} \frac{\delta}{\delta J(x_1)} \frac{1}{i} \frac{\delta}{\delta J(x_2)} Z_0(J) \Big|_{J=0} \\ &= \frac{1}{i} \frac{\delta}{\delta J(x_1)} \left[\int d^4x' \Delta(x_2 - x') J(x') \right] Z_0(J) \Big|_{J=0} \\ &= \left[\frac{1}{i} \Delta(x_2 - x_1) + (\text{term with } J\text{'s}) \right] Z_0(J) \Big|_{J=0} \\ &= \frac{1}{i} \Delta(x_2 - x_1) .\end{aligned}\quad (197)$$

We can continue in this way to compute the ground-state expectation value of the time-ordered product of more φ 's. If the number of φ 's is odd, then there is always a left-over J in the prefactor, and so the result is zero. If the number of φ 's is even, then we must pair up the functional derivatives in an appropriate way to get a nonzero result. Thus, for example,

$$\begin{aligned}\langle 0 | \mathbb{T} \varphi(x_1) \varphi(x_2) \varphi(x_3) \varphi(x_4) | 0 \rangle &= \frac{1}{i^2} \left[\Delta(x_1 - x_2) \Delta(x_3 - x_4) \right. \\ &\quad + \Delta(x_1 - x_3) \Delta(x_2 - x_4) \\ &\quad \left. + \Delta(x_1 - x_4) \Delta(x_2 - x_3) \right] .\end{aligned}\quad (198)$$

More generally,

$$\langle 0 | T \varphi(x_1) \dots \varphi(x_{2n}) | 0 \rangle = \frac{1}{i^n} \sum_{\text{pairings}} \Delta(x_{i_1} - x_{i_2}) \dots \Delta(x_{i_{2n-1}} - x_{i_{2n}}). \quad (199)$$

This result is known as *Wick's theorem*.

Problems

8.1) Starting with eq. (193), verify eq. (194).

8.2) Starting with eq. (193), verify eq. (195).

8.3) Use eq. (86), the commutation relations eq. (95), and $a(\mathbf{k})|0\rangle = 0$, $\langle 0|a^\dagger(\mathbf{k}) = 0$ to verify the last line of eq. (197).

8.4) The retarded and advanced Green's functions for the Klein-Gordon wave operator satisfy $\Delta_{\text{ret}}(x - y) = 0$ for $x^0 \geq y^0$ and $\Delta_{\text{adv}}(x - y) = 0$ for $x^0 \leq y^0$. Find the pole prescriptions on the right-hand side of eq. (193) that yield these Green's functions.

8.5) Let $Z_0(J) = \exp iW_0(J)$, and evaluate the real and imaginary parts of $W_0(J)$.

8.6) Repeat the analysis of this section for the complex scalar field that was introduced in problem 3.3, and further studied in problem 5.1. Write your source term in the form $J^\dagger \varphi + J \varphi^\dagger$, and find an explicit formula, analogous to eq. (192), for $Z_0(J^\dagger, J)$. Write down the appropriate generalization of eq. (196), and use it to compute $\langle 0 | T \varphi(x_1) \varphi(x_2) | 0 \rangle$, $\langle 0 | T \varphi^\dagger(x_1) \varphi(x_2) | 0 \rangle$, and $\langle 0 | T \varphi^\dagger(x_1) \varphi^\dagger(x_2) | 0 \rangle$. Then verify your results by using the method of problem 8.3. Finally, give the appropriate generalization of eq. (199).

9: The Path Integral for Interacting Field Theory

Prerequisite: 8

Let us consider an interacting quantum field theory specified by a lagrangian of the form

$$\mathcal{L} = -\frac{1}{2}Z_\varphi\partial^\mu\varphi\partial_\mu\varphi - \frac{1}{2}Z_m m^2\varphi^2 + \frac{1}{6}Z_g g\varphi^3 + Y\varphi. \quad (200)$$

As we discussed at the end of section 5, we fix the parameter m by requiring it to be equal to the actual mass of the particle (equivalently, the energy of the first excited state relative to the ground state), and we fix the parameter g by requiring some particular scattering cross section to depend on g in some particular way. (We will have more to say about this after we have learned to calculate cross sections.) We also assume that the field is normalized by

$$\langle 0|\varphi(x)|0\rangle = 0 \quad \text{and} \quad \langle k|\varphi(x)|0\rangle = e^{-ikx}. \quad (201)$$

Here $|0\rangle$ is the ground state, normalized via $\langle 0|0\rangle = 1$, and $|k\rangle$ is a state of one particle with four-momentum k^μ , where $k^2 = k^\mu k_\mu = -m^2$, normalized via

$$\langle k'|k\rangle = (2\pi)^3 2k^0 \delta^3(\mathbf{k}' - \mathbf{k}). \quad (202)$$

Thus we have four conditions (the specified values of m , g , $\langle 0|\varphi|0\rangle$, and $\langle k|\varphi|0\rangle$), and we will use these four conditions to determine the values of the four remaining parameters (Y and the three Z 's) that appear in \mathcal{L} .

Before going further, we should note that this theory (known as φ^3 theory, pronounced “phi-cubed”) actually has a fatal flaw. The hamiltonian density is

$$\mathcal{H} = \frac{1}{2}Z_\varphi^{-1}\Pi^2 - Y\varphi + \frac{1}{2}Z_m m^2\varphi^2 - \frac{1}{6}Z_g g\varphi^3. \quad (203)$$

Classically, we can make this arbitrarily negative by choosing an arbitrarily large value for φ . Quantum mechanically, this means that this hamiltonian has no ground state. If we start off near $\varphi = 0$, we can tunnel through the potential barrier to large φ , and then “roll down the hill”. However, this process is invisible in perturbation theory in g . The situation is exactly analogous to the problem of a harmonic oscillator perturbed by an x^3 term. This system has no ground state, but perturbation theory (both time dependent and time independent) does not “know” this. We will be interested in eq. (200) only as an example of how to do perturbation expansions in a simple context, and so we will overlook this problem.

We would like to evaluate the path integral for this theory,

$$Z(J) \equiv \langle 0|0 \rangle_J = \int \mathcal{D}\varphi e^{i \int d^4x [\mathcal{L}_0 + \mathcal{L}_1 + J\varphi]} . \quad (204)$$

We can evaluate $Z(J)$ by mimicking what we did for quantum mechanics. Specifically, we can rewrite eq. (204) as

$$\begin{aligned} Z(J) &= e^{i \int d^4x \mathcal{L}_1(\frac{1}{i} \frac{\delta}{\delta J(x)})} \int \mathcal{D}\varphi e^{i \int d^4x [\mathcal{L}_0 + J\varphi]} . \\ &\propto e^{i \int d^4x \mathcal{L}_1(\frac{1}{i} \frac{\delta}{\delta J(x)})} Z_0(J) , \end{aligned} \quad (205)$$

where $Z_0(J)$ is the result in free-field theory,

$$Z_0(J) = \exp \left[\frac{i}{2} \int d^4x d^4x' J(x) \Delta(x - x') J(x') \right] . \quad (206)$$

We have written $Z(J)$ as proportional to (rather than equal to) the right-hand side of eq. (205) because the ϵ trick does not give us the correct overall normalization; instead, we must require $Z(0) = 1$, and enforce this by hand.

Note that, in eq. (206), we have implicitly assumed that

$$\mathcal{L}_0 = -\frac{1}{2} \partial^\mu \varphi \partial_\mu \varphi - \frac{1}{2} m^2 \varphi^2 , \quad (207)$$

since this is the \mathcal{L}_0 that gives us eq. (206). Therefore, the rest of \mathcal{L} must be included in \mathcal{L}_1 . We write

$$\begin{aligned} \mathcal{L}_1 &= \frac{1}{6} Z_g g \varphi^3 + \mathcal{L}_{\text{ct}} , \\ \mathcal{L}_{\text{ct}} &= -\frac{1}{2} (Z_\varphi - 1) \partial^\mu \varphi \partial_\mu \varphi - \frac{1}{2} (Z_m - 1) m^2 \varphi^2 + Y \varphi , \end{aligned} \quad (208)$$

where \mathcal{L}_{ct} is called the *counterterm* lagrangian. We expect that, as $g \rightarrow 0$, $Y \rightarrow 0$ and $Z_i \rightarrow 1$. In fact, as we will see, $Y = O(g)$ and $Z_i = 1 + O(g^2)$.

In order to make use of eq. (206), we will have to compute lots and lots of functional derivatives of $Z_0(J)$. Let us begin by ignoring the counterterms, and computing

$$\begin{aligned} Z_1(J) &\propto \exp \left[\frac{i}{6} Z_g g \int d^4x \left(\frac{1}{i} \frac{\delta}{\delta J(x)} \right)^3 \right] Z_0(J) \\ &\propto \sum_{V=0}^{\infty} \frac{1}{V!} \left[\frac{i Z_g g}{6} \int d^4x \left(\frac{1}{i} \frac{\delta}{\delta J(x)} \right)^3 \right]^V \\ &\quad \times \sum_{P=0}^{\infty} \frac{1}{P!} \left[\frac{i}{2} \int d^4y d^4z J(y) \Delta(y-z) J(z) \right]^P. \end{aligned} \quad (209)$$

If we focus on a term in eq. (209) with particular values of V and P , then the number of surviving sources (after we take all the functional derivatives) is $E = 2P - 3V$. (Here E stands for *external*, a terminology that should become clearer by the end of the next section; V stands for *vertex* and P for *propagator*.) The overall phase factor of such a term is then $i^V (1/i)^{3V} i^P = i^{V+E-P}$, and the $3V$ functional derivatives can act on the $2P$ sources in $(2P)!/(3V)!$ different combinations. However, many of resulting expressions are algebraically identical.

To organize them, we introduce *Feynman diagrams*. In these diagrams, a line segment (straight or curved) stands for a propagator $\frac{1}{i} \Delta(x-y)$, a filled circle at one end of a line segment for a source $i \int d^4x J(x)$, and a vertex joining three line segments for $i Z_g g \int d^4x$. The complete set of diagrams for different values of E and V are shown in figs. (2–13).

To count the number of terms on the right-hand side of eq. (209) that result in a particular diagram, we first note that, in each diagram, the number of lines is P , the number of lines connected to a source is E , and the number of vertices is V . In a given diagram, there are $2^P P!$ ways of rearranging the sources (before we take the functional derivatives) without changing the resulting diagram. Similarly, there are $(3!)^V V!$ ways of rearranging the functional derivatives (before they act on the sources) without changing the resulting diagram. These counting factors neatly cancel the numbers from the dual Taylor expansions in eq. (209).

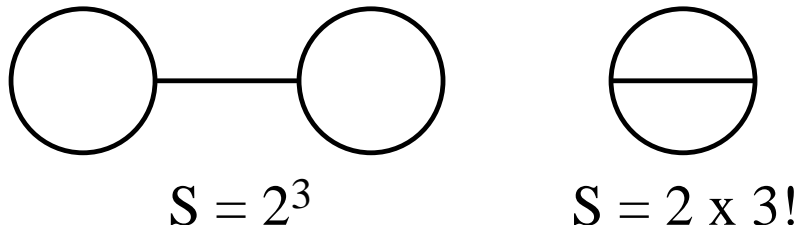

Figure 2: All connected diagrams with $E = 0$ and $V = 2$.

However, this procedure generally results in an overcounting of the number of terms that give equal results. This happens when some rearrangement of derivatives gives the *same* match-up to sources as some rearrangement of sources. This possibility is always connected to some symmetry property of the diagram, and so the factor by which we have overcounted is called the *symmetry factor*. The figures show the symmetry factor S of each diagram.

Consider, for example, the second diagram of fig. (2). The propagators can be rearranged in $3!$ ways, and all these rearrangements can be duplicated by exchanging derivatives. Furthermore the endpoints of each propagator can be swapped, and the effect duplicated by swapping the two vertices. Thus, $S = 2 \times 3! = 12$.

Let us consider two more examples. In the first diagram of fig. (7), the exchange of the two external propagators (along with their attached sources) can be duplicated by exchanging all the derivatives at one vertex for those at the other. Also, the effect of swapping the top and bottom semicircular propagators can be duplicated by swapping the corresponding derivatives within each vertex. Thus, the symmetry factor is $S = 2 \times 2 = 4$.

In the diagram of fig. (12), we can exchange derivatives to match swaps of the top and bottom external propagators on the left, or the top and bottom external propagators on the right, or the set of external propagators on the left with the set of external propagators on the right. Thus, the symmetry factor is $S = 2 \times 2 \times 2 = 8$.

The diagrams in figs. (2–13) are all simply connected (or just *connected* for short), but these are not the only contributions to $Z(J)$. The most general diagram consists of a product of several connected diagrams. Let C_I stand

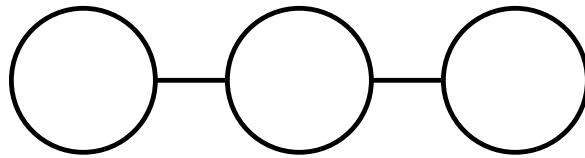

$$S = 2^4$$

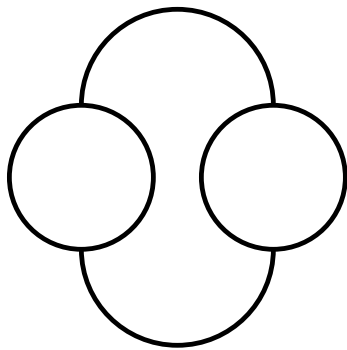

$$S = 2^4$$

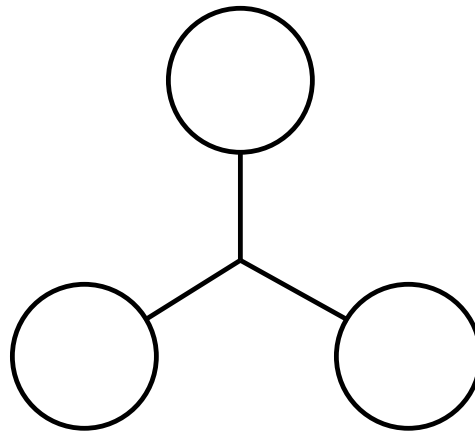

$$S = 2^3 \times 3!$$

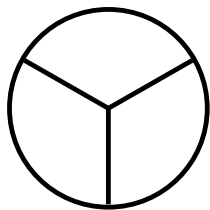

$$S = 4!$$

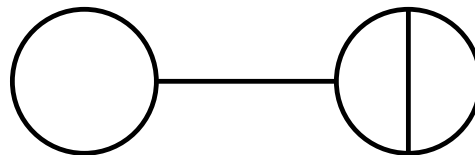

$$S = 2^3$$

Figure 3: All connected diagrams with $E = 0$ and $V = 4$.

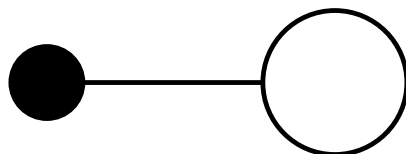

$$S = 2$$

Figure 4: All connected diagrams with $E = 1$ and $V = 1$.

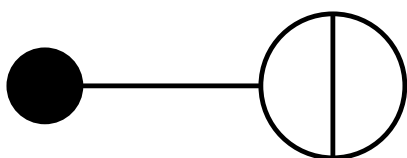

$$S = 2^2$$

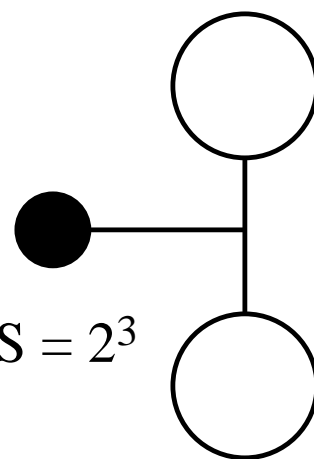

$$S = 2^3$$

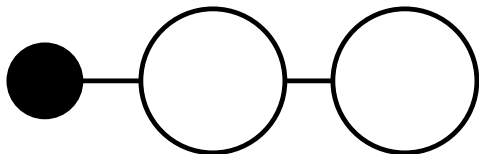

$$S = 2^2$$

Figure 5: All connected diagrams with $E = 1$ and $V = 3$.

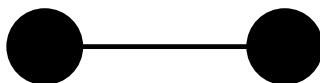

$$S = 2$$

Figure 6: All connected diagrams with $E = 2$ and $V = 0$.

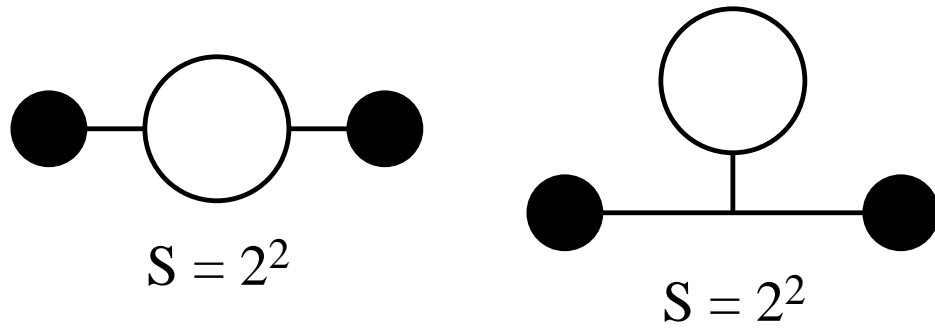

Figure 7: All connected diagrams with $E = 2$ and $V = 2$.

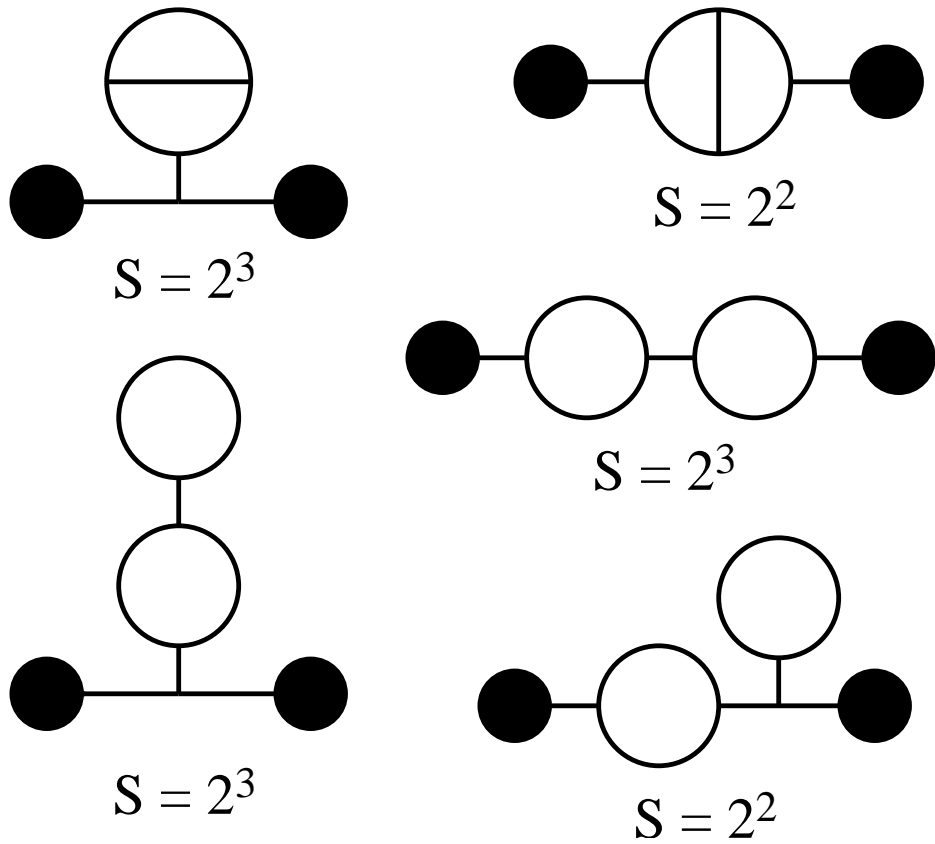

Figure 8: Diagrams with $E = 2$ and $V = 4$ (continued in the next figure).

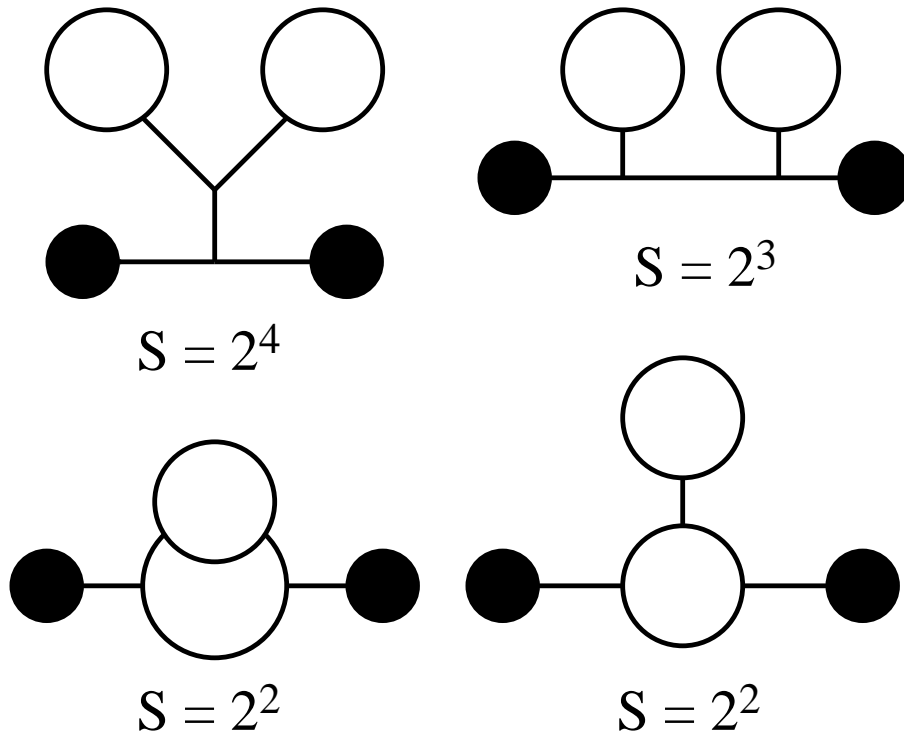

Figure 9: Diagrams with $E = 2$ and $V = 4$ (continued from the previous figure).

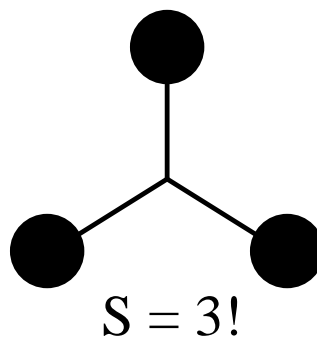

Figure 10: All connected diagrams with $E = 3$ and $V = 1$.

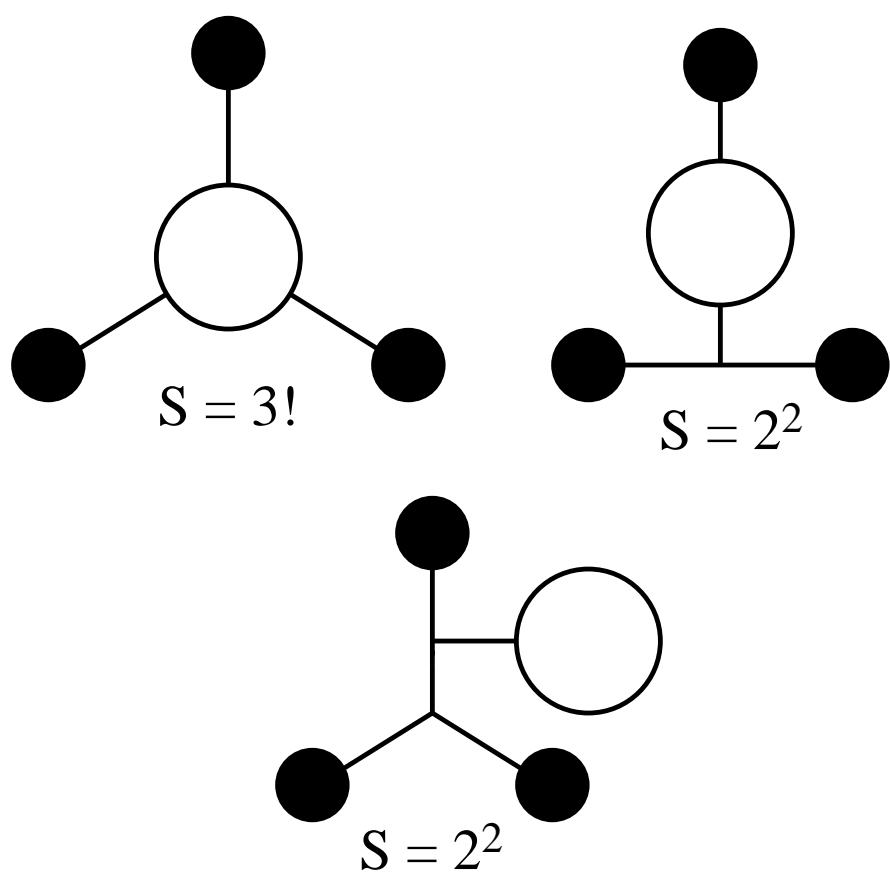

Figure 11: All connected diagrams with $E = 3$ and $V = 3$.

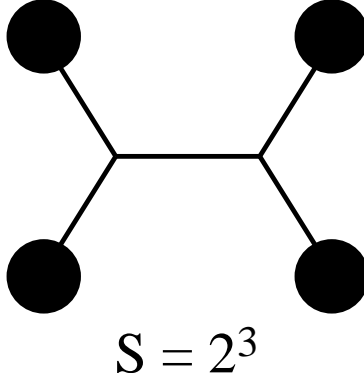

Figure 12: All connected diagrams with $E = 4$ and $V = 2$.

for a particular connected diagram, including its symmetry factor. A general diagram D can then be expressed as

$$D = \frac{1}{S_D} \prod_I (C_I)^{n_I} , \quad (210)$$

where n_I is an integer that counts the number of C_I 's in D , and S_D is the *additional* symmetry factor for D (that is, the part of the symmetry factor that is not already accounted for by the symmetry factors already included in each of the connected diagrams). We now need to determine S_D .

Since we have already accounted for propagator and vertex rearrangements *within* each C_I , we need to consider only exchanges of propagators and vertices among *different* connected diagrams. These can leave the total diagram D unchanged only if (1) the exchanges are made among different but *identical* connected diagrams, and only if (2) the exchanges involve *all* of the propagators and vertices in a given connected diagram. If there are n_I factors of C_I in D , there are $n_I!$ ways to make these rearrangements. Overall, then, we have

$$S_D = \prod_I n_I! . \quad (211)$$

Now $Z_1(J)$ is given (up to an overall normalization) by summing all diagrams D , and each D is labeled by the integers n_I . Therefore

$$Z_1(J) \propto \sum_{\{n_I\}} D$$

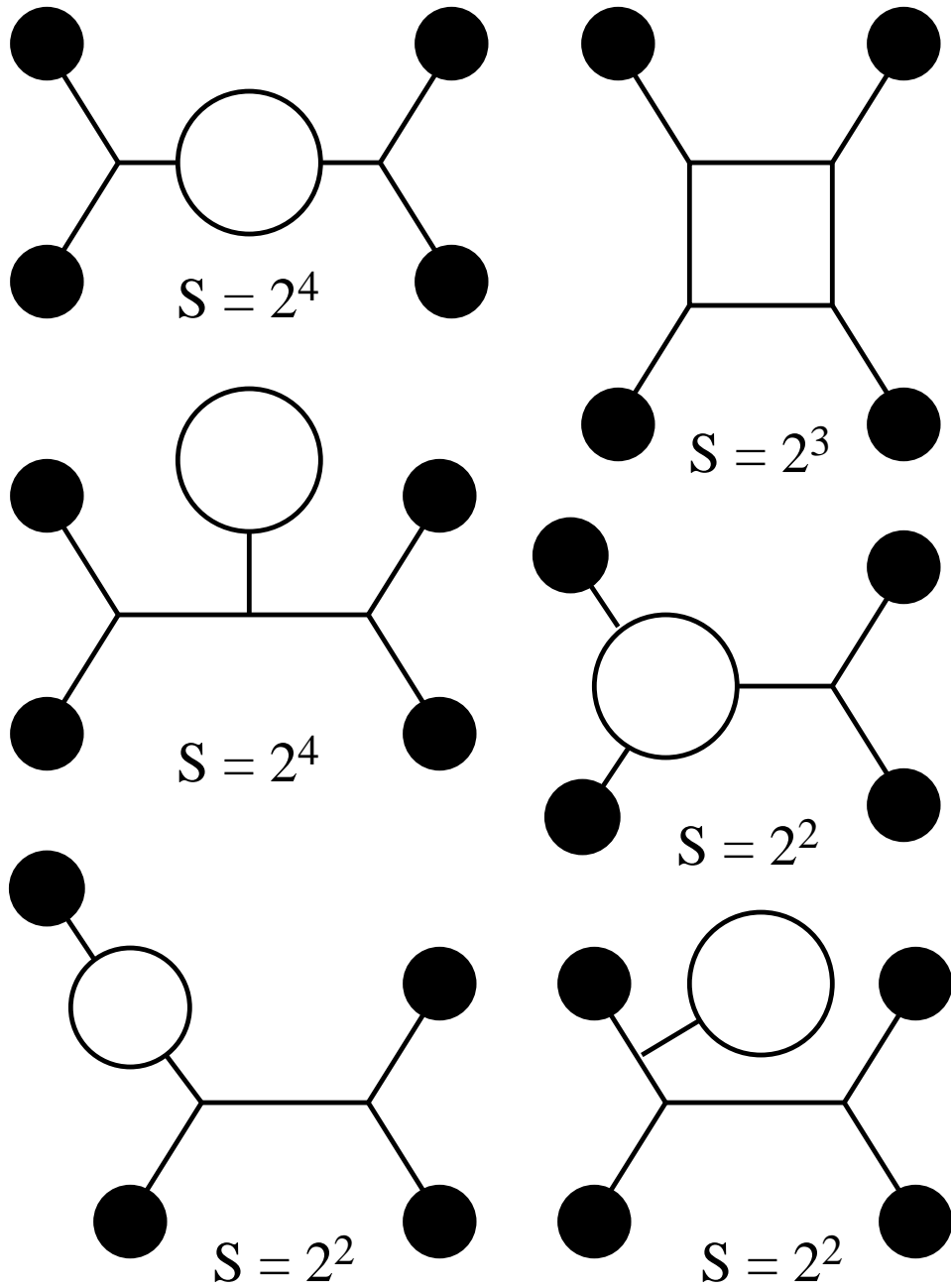

Figure 13: All connected diagrams with $E = 4$ and $V = 4$.

$$\begin{aligned}
&\propto \sum_{\{n_I\}} \prod_I \frac{1}{n_I!} (C_I)^{n_I} \\
&\propto \prod_I \sum_{n_I=0}^{\infty} \frac{1}{n_I!} (C_I)^{n_I} \\
&\propto \prod_I \exp(C_I) \\
&\propto \exp(\sum_I C_I) .
\end{aligned} \tag{212}$$

Thus we have a remarkable result: $Z_1(J)$ is given by the exponential of the sum of *connected* diagrams. This makes it easy to impose the normalization $Z_1(0) = 1$: we simply omit the *vacuum diagrams* (those with no sources), like those of figs. (2) and (3). We then have

$$Z_1(J) = \exp[iW_1(J)] , \tag{213}$$

where we have defined

$$iW_1(J) \equiv \sum_{I \neq \{0\}} C_I , \tag{214}$$

and the notation $I \neq \{0\}$ means that the vacuum diagrams are omitted from the sum, so that $W_1(0) = 0$. [We have included a factor of i on the left-hand side of eq. (214) because then $W_1(J)$ is real in free-field theory; see problem 8.5.]

Were it not for the counterterms in \mathcal{L}_1 , we would have $Z(J) = Z_1(J)$. Let us see what we would get if this was, in fact, the case. In particular, let us compute the vacuum expectation value of the field $\varphi(x)$, which is given by

$$\begin{aligned}
\langle 0|\varphi(x)|0\rangle &= \frac{1}{i} \frac{\delta}{\delta J(x)} Z_1(J) \Big|_{J=0} \\
&= \frac{\delta}{\delta J(x)} W_1(J) \Big|_{J=0} .
\end{aligned} \tag{215}$$

This expression is then the sum of all diagrams [such as those in figs. (4) and (5)] that have a single source, with the source removed:

$$\langle 0|\varphi(x)|0\rangle = \frac{1}{2}ig \int d^4y \frac{1}{i}\Delta(x-y) \frac{1}{i}\Delta(y-y) + O(g^3) . \tag{216}$$

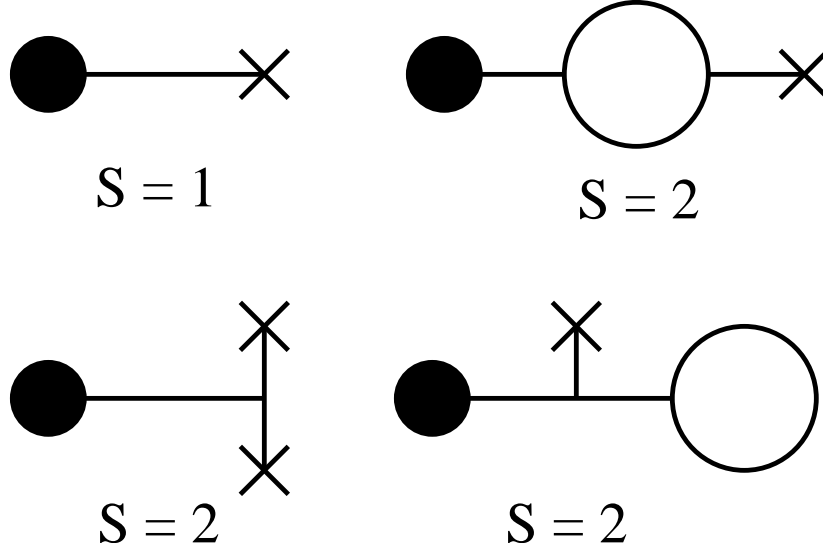

Figure 14: All connected diagrams with $E = 1$, $X \geq 1$ (where X is the number of one-point vertices from the linear counterterm), and $V + X \leq 3$.

Here we have set $Z_g = 1$ in the first term, since $Z_g = 1 + O(g^2)$. We see the vacuum-expectation value of $\varphi(x)$ is not zero, as is required for the validity of the LSZ formula. To fix this, we must introduce the counterterm $Y\varphi$. Including this term in the interaction lagrangian \mathcal{L}_1 introduces a new kind of vertex, one where a single line segment ends; the corresponding vertex factor is $iY \int d^4y$. The simplest diagrams including this new vertex are shown in fig. (14), with an X standing for the vertex.

Assuming $Y = O(g)$, only the first diagram in fig. (14) contributes at $O(g)$, and we have

$$\langle 0|\varphi(x)|0\rangle = \left(iY + \frac{1}{2}(ig)\frac{1}{i}\Delta(0)\right) \int d^4y \frac{1}{i}\Delta(x-y) + O(g^3). \quad (217)$$

Thus, in order to have $\langle 0|\varphi(x)|0\rangle = 0$, we should choose

$$Y = \frac{1}{2}ig\Delta(0) + O(g^3). \quad (218)$$

The factor of i is disturbing, because Y must be a real number: it is the coefficient of a hermitian operator in the hamiltonian, as seen in eq. (203).

Therefore, $\Delta(0)$ must be purely imaginary, or we are in trouble. We have

$$\Delta(0) = \int \frac{d^4k}{(2\pi)^4} \frac{1}{k^2 + m^2 - i\epsilon}. \quad (219)$$

Eq. (219) does not clearly show whether or not $\Delta(0)$ is purely imaginary, but it does reveal another problem: the integral diverges at large k , and $\Delta(0)$ is infinite.

To make some progress, we will modify the propagator in an ad hoc way:

$$\Delta(x-y) \rightarrow \int \frac{d^4k}{(2\pi)^4} \frac{e^{ik(x-y)}}{k^2 + m^2 - i\epsilon} \left(\frac{\Lambda^2}{k^2 + \Lambda^2 - i\epsilon} \right)^2. \quad (220)$$

Here Λ is a new parameter called the *ultraviolet cutoff*. It has dimensions of energy, and we assume that it is much larger than any energy of physical interest. Note that the modified propagator has the same Lorentz-transformation properties as the original, so the Lorentz invariance of the theory should not be affected. In the limit $\Lambda \rightarrow \infty$, the modified $\Delta(x-y)$ goes back to the original one.

We can now evaluate the modified $\Delta(0)$ with the methods of section 14; the result is

$$\Delta(0) = \frac{i}{16\pi^2} \Lambda^2. \quad (221)$$

Thus Y is real, as required. We can now formally take the limit $\Lambda \rightarrow \infty$. The parameter Y becomes infinite, but $\langle 0|\varphi(x)|0\rangle$ remains zero, at least to this order in g .

It may be disturbing to have a parameter in the lagrangian which is formally infinite. However, such parameters are not directly measurable, and so need not obey our preconceptions about their magnitudes. Also, it is important to remember that Y includes a factor of g ; this means that we can expand in powers of Y as part of our general expansion in powers of g . When we compute something measurable (like a scattering cross section), all the formally infinite numbers will cancel in a well-defined way, leaving behind finite coefficients for the various powers of g . We will see how this works in detail in sections 14–20.

As we go to higher orders in g , things become more complicated, but in principle the procedure is the same. Thus, at $O(g^3)$, we sum up the diagrams

of figs. (5) and (14), and then add to Y whatever $O(g^3)$ term is needed to maintain $\langle 0|\varphi(x)|0\rangle = 0$. In this way we can determine the value of Y order by order in powers of g .

Once this is done, there is a remarkable simplification. Our adjustment of Y to keep $\langle 0|\varphi(x)|0\rangle = 0$ means that the sum of all connected diagrams with a single source is zero. Consider now that same infinite set of diagrams, but replace the source in each of them with some other subdiagram. Here is the point: *no matter what this replacement subdiagram is, the sum of all these diagrams is still zero*. Therefore, we need not bother to compute any of them! The rule is this: ignore any diagram that, when a single line is cut, falls into two parts, *one of which has no sources*. All of these diagrams (known as *tadpoles*) are canceled by the Y counterterm, no matter what subdiagram they are attached to. The diagrams that remain (and need to be computed!) are shown in figs. (15) and (16).

We turn next to the remaining two counterterms. For notational simplicity we define

$$A = Z_\varphi - 1, \quad B = Z_m - 1, \quad (222)$$

and recall that we expect each of these to be $O(g^2)$. We now have

$$Z(J) = \exp \left[-\frac{i}{2} \int d^4x \left(\frac{1}{i} \frac{\delta}{\delta J(x)} \right) (-A\partial_x^2 + Bm^2) \left(\frac{1}{i} \frac{\delta}{\delta J(x)} \right) \right] Z_1(J). \quad (223)$$

We have integrated by parts to put both ∂_x 's onto one $\delta/\delta J(x)$. Also, we have cheated a little: the time derivatives in this interaction really need to be treated by including an extra source term for the conjugate momentum $\Pi = \dot{\varphi}$. However, the terms with space derivatives are correctly treated, and the time derivatives must work out comparably by Lorentz invariance.

Eq. (223) results in a new vertex at which two lines meet. The corresponding vertex factor is $(-i) \int d^4x (A\partial_x^2 + Bm^2)$; the ∂_x^2 acts on the x in one or the other (but not both) propagators. (Which one does not matter, and can be changed via integration by parts.) Diagrammatically, all we need do is sprinkle these new vertices onto the propagators in our existing diagrams. How many of these vertices we need to add depends on the order in g we are working to achieve.

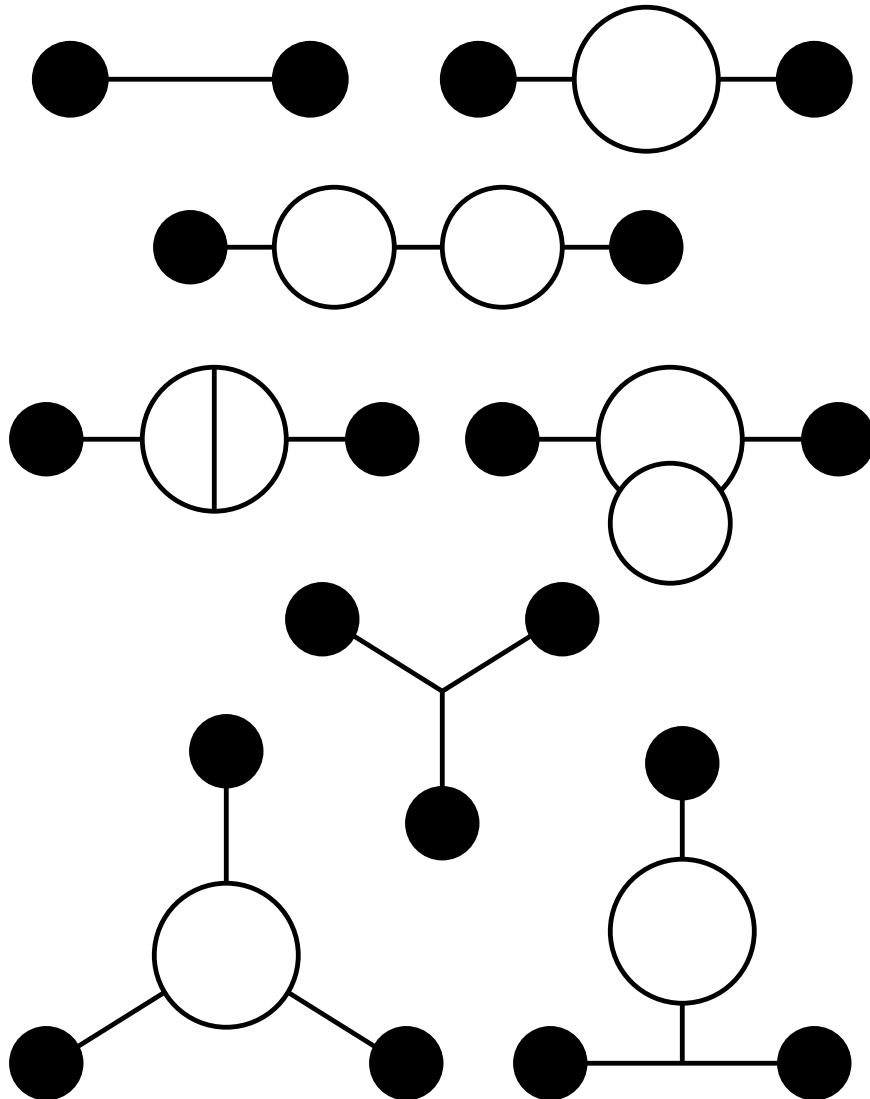

Figure 15: All connected diagrams without tadpoles with $E \leq 3$ and $V \leq 4$.

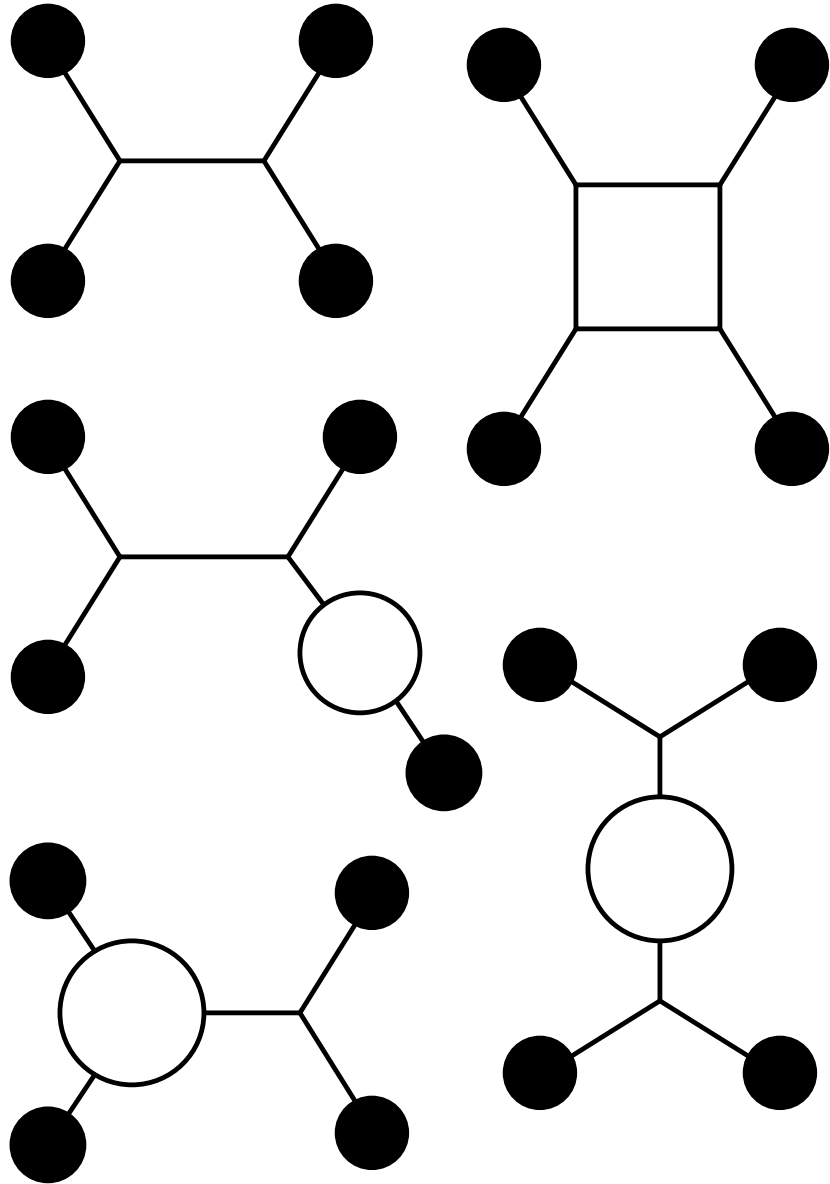

Figure 16: All connected diagrams without tadpoles with $E = 4$ and $V \leq 4$.

This completes our calculation of $Z(J)$ in φ^3 theory. We express it as

$$Z(J) = \exp[iW(J)] , \quad (224)$$

where $W(J)$ is given by the sum of all connected diagrams with no tadpoles and at least two sources, and including the counterterm vertices just discussed.

Now that we have $Z(J)$, we must find out what we can do with it.

Problems

9.1) Compute the symmetry factor for each diagram in figs. (15) and (16). (You can then check your answers by consulting the earlier figures.)

9.2) Consider a real scalar field with $\mathcal{L} = \mathcal{L}_0 + \mathcal{L}_1$, where

$$\begin{aligned} \mathcal{L}_0 &= -\frac{1}{2}\partial^\mu\varphi\partial_\mu\varphi - \frac{1}{2}m^2\varphi^2 , \\ \mathcal{L}_1 &= -\frac{1}{24}Z_\lambda\lambda\varphi^4 + \mathcal{L}_{\text{ct}} , \\ \mathcal{L}_{\text{ct}} &= -\frac{1}{2}(Z_\varphi-1)\partial^\mu\varphi^\dagger\partial_\mu\varphi - \frac{1}{2}(Z_m-1)m^2\varphi^\dagger\varphi . \end{aligned}$$

a) What kind of vertex appears in the diagrams for this theory (that is, how many line segments does it join?), and what is the associated vertex factor?

b) Ignoring the counterterms, draw all the connected diagrams with $1 \leq E \leq 4$ and $0 \leq V \leq 2$, and find their symmetry factors.

c) Explain why we did not have to include a counterterm linear in φ to cancel tadpoles.

9.3) Consider a complex scalar field (see problems 3.3, 5.1, and 8.5) with $\mathcal{L} = \mathcal{L}_0 + \mathcal{L}_1$, where

$$\begin{aligned} \mathcal{L}_0 &= -\partial^\mu\varphi^\dagger\partial_\mu\varphi - m^2\varphi^\dagger\varphi , \\ \mathcal{L}_1 &= -\frac{1}{4}Z_\lambda\lambda(\varphi^\dagger\varphi)^2 + \mathcal{L}_{\text{ct}} , \\ \mathcal{L}_{\text{ct}} &= -(Z_\varphi-1)\partial^\mu\varphi^\dagger\partial_\mu\varphi - (Z_m-1)\varphi^\dagger\varphi . \end{aligned}$$

This theory has two kinds of sources, J and J^\dagger , and so we need a way to tell which is which when we draw the diagrams. Rather than labeling the source blobs with a J or J^\dagger , we will indicate which is which by putting an arrow on the attached propagator that points *towards* the source if it is a J^\dagger , and *away* from the source if it is a J .

a) What kind of vertex appears in the diagrams for this theory, and what is the associated vertex factor? Hint: your answer should involve those arrows!

b) Ignoring the counterterms, draw all the connected diagrams with $1 \leq E \leq 4$ and $0 \leq V \leq 2$, and find their symmetry factors. Hint: the arrows are important!

9.4) Consider the integral

$$\exp W(g, J) \equiv \frac{1}{\sqrt{2\pi}} \int_{-\infty}^{+\infty} dx \exp\left[-\frac{1}{2}x^2 + \frac{1}{6}gx^3 + Jx\right]. \quad (225)$$

This integral does not converge, but it can be used to generate a joint power series in g and J ,

$$W(g, J) = \sum_{V=0}^{\infty} \sum_{E=0}^{\infty} C_{V,E} g^V J^E. \quad (226)$$

a) Show that

$$C_{V,E} = \sum_I \frac{1}{S_I}, \quad (227)$$

where the sum is over all connected Feynman diagrams with E sources and V three-point vertices, and S_I is the symmetry factor for each diagram.

b) Use eqs. (225) and (226) to compute $C_{V,E}$ for $V \leq 4$ and $E \leq 4$. (This is most easily done with a symbolic manipulation program like Maple or Mathematica.) Verify that the symmetry factors given in figs. (2–13) satisfy the sum rule of eq. (227).

c) Now consider $W(g, J+Y)$, with Y fixed by the “no tadpole” condition

$$\left. \frac{\partial}{\partial J} W(g, J+Y) \right|_{J=0} = 0. \quad (228)$$

Then write

$$W(g, J+Y) = \sum_{V=0}^{\infty} \sum_{E=0}^{\infty} \tilde{C}_{V,E} g^V J^E. \quad (229)$$

Show that

$$\tilde{C}_{V,E} = \sum_I \frac{1}{S_I}, \quad (230)$$

where the sum is over all connected Feynman diagrams with E sources and V three-point vertices and *no tadpoles*, and S_I is the symmetry factor for each diagram.

d) Let $Y = a_1 g + a_3 g^3 + \dots$, and use eq. (228) to determine a_1 and a_3 . Compute $\tilde{C}_{V,E}$ for $V \leq 4$ and $E \leq 4$. Verify that the symmetry factors for the diagrams in figs. (15–16) satisfy the sum rule of eq. (230).

10: Scattering Amplitudes and the Feynman Rules

Prerequisite: 5, 9

Now that we have an expression for $Z(J) = \exp iW(J)$, we can take functional derivatives to compute vacuum expectation values of time-ordered products of fields. Consider the case of two fields; we define the exact propagator via

$$\frac{1}{i}\Delta(x_1 - x_2) \equiv \langle 0 | T \varphi(x_1) \varphi(x_2) | 0 \rangle . \quad (231)$$

For notational simplicity let us define

$$\delta_j \equiv \frac{1}{i} \frac{\delta}{\delta J(x_j)} . \quad (232)$$

Then we have

$$\begin{aligned} \langle 0 | T \varphi(x_1) \varphi(x_2) | 0 \rangle &= \delta_1 \delta_2 Z(J) \Big|_{J=0} \\ &= \delta_1 \delta_2 iW(J) \Big|_{J=0} - \delta_1 iW(J) \Big|_{J=0} \delta_2 iW(J) \Big|_{J=0} \\ &= \delta_1 \delta_2 iW(J) \Big|_{J=0} . \end{aligned} \quad (233)$$

To get the last line we used $\delta_x W(J) \Big|_{J=0} = \langle 0 | \varphi(x) | 0 \rangle = 0$. Diagrammatically, δ_1 removes a source, and labels the propagator endpoint x_1 . Thus $\frac{1}{i}\Delta(x_1 - x_2)$ is given by the sum of diagrams with two sources, with those sources removed and the endpoints labeled x_1 and x_2 . (The labels must be applied in both ways. If the diagram was originally symmetric on exchange of the two sources, the associated symmetry factor of 2 is then canceled by the double labeling.) At lowest order, the only contribution is the “barbell” diagram of fig. (6) with the sources removed. Thus we recover the obvious fact that $\frac{1}{i}\Delta(x_1 - x_2) = \frac{1}{i}\Delta(x_1 - x_2) + O(g^2)$. We will take up the subject of the $O(g^2)$ corrections in section 14.

For now, let us go on to compute

$$\begin{aligned}
\langle 0|\mathrm{T}\varphi(x_1)\varphi(x_2)\varphi(x_3)\varphi(x_4)|0\rangle &= \delta_1\delta_2\delta_3\delta_4 Z(J) \\
&= \left[\delta_1\delta_2\delta_3\delta_4 iW \right. \\
&\quad + (\delta_1\delta_2 iW)(\delta_3\delta_4 iW) \\
&\quad + (\delta_1\delta_3 iW)(\delta_2\delta_4 iW) \\
&\quad \left. + (\delta_1\delta_4 iW)(\delta_2\delta_3 iW) \right]_{J=0}. \quad (234)
\end{aligned}$$

We have dropped terms that contain a factor of $\langle 0|\varphi(x)|0\rangle = 0$. According to eq. (233), the last three terms in eq. (234) simply give products of the exact propagators. Let us see what happens when these terms are inserted into the LSZ formula for two incoming and two outgoing particles,

$$\begin{aligned}
\langle f|i\rangle &= i^4 \int d^4x_1 d^4x_2 d^4x'_1 d^4x'_2 e^{i(k_1x_1+k_2x_2-k'_1x'_1-k'_2x'_2)} \\
&\quad \times (-\partial_1^2 + m^2)(-\partial_2^2 + m^2)(-\partial_{1'}^2 + m^2)(-\partial_{2'}^2 + m^2) \\
&\quad \times \langle 0|\mathrm{T}\varphi(x_1)\varphi(x_2)\varphi(x'_1)\varphi(x'_2)|0\rangle. \quad (235)
\end{aligned}$$

If we consider, for example, $\frac{1}{i}\Delta(x_1-x'_1)\frac{1}{i}\Delta(x_2-x'_2)$ as one term in the correlation function in eq. (235), we get from this term

$$\begin{aligned}
&\int d^4x_1 d^4x_2 d^4x'_1 d^4x'_2 e^{i(k_1x_1+k_2x_2-k'_1x'_1-k'_2x'_2)} F(x_{11'})F(x_{22'}) \\
&= (2\pi)^4\delta^4(k_1-k'_1)(2\pi)^4\delta^4(k_2-k'_2)\tilde{F}(\bar{k}_{11'})\tilde{F}(\bar{k}_{22'}), \quad (236)
\end{aligned}$$

where $F(x_{ij}) \equiv (-\partial_i^2 + m^2)(-\partial_j^2 + m^2)\Delta(x_{ij})$, $\tilde{F}(k)$ is its Fourier transform, $x_{ij'} \equiv x_i - x'_j$, and $\bar{k}_{ij'} \equiv \frac{1}{2}(k_i + k'_j)$. The important point is the two delta functions: these tell us that the four-momenta of the two outgoing particles (1' and 2') are equal to the four-momenta of the two incoming particles (1 and 2). In other words, no scattering has occurred. This is not the event whose probability we wish to compute! The other two similar terms in eq. (234) either contribute to “no scattering” events, or vanish due to factors like $\delta^4(k_1+k_2)$ (which is zero because $k_1^0+k_2^0 \geq 2m > 0$). In general, the diagrams that contribute to the scattering process of interest are only those that are *fully connected*: every endpoint can be reached from every other endpoint by tracing through the diagram. These are the diagrams that arise

from all the δ 's acting on a single factor of W . Therefore, from here on, we restrict our attention to those diagrams alone. We define the *connected* correlation functions via

$$\langle 0 | T \varphi(x_1) \dots \varphi(x_E) | 0 \rangle_C \equiv \delta_1 \dots \delta_E iW(J) \Big|_{J=0}, \quad (237)$$

and use these instead of $\langle 0 | T \varphi(x_1) \dots \varphi(x_E) | 0 \rangle$ in the LSZ formula.

Returning to eq. (234), we have

$$\langle 0 | T \varphi(x_1) \varphi(x_2) \varphi(x'_1) \varphi(x'_2) | 0 \rangle_C = \delta_1 \delta_2 \delta_{1'} \delta_{2'} iW \Big|_{J=0}. \quad (238)$$

The lowest-order (in g) nonzero contribution to this comes from the diagram of fig. (12), which has four sources and two vertices. The four δ 's remove the four sources; there are $4!$ ways of matching up the δ 's to the sources. These 24 diagrams can then be collected into 3 groups of 8 diagrams each; the 8 diagrams in each group are identical. The 3 distinct diagrams are shown in fig. (17). Note that the factor of 8 neatly cancels the symmetry factor $S = 8$ of this diagram.

This is a general result for *tree diagrams* (those with no closed loops): once the sources have been stripped off and the endpoints labeled, each diagram with a distinct endpoint labeling has an overall symmetry factor of one. The tree diagrams for a given process represent the lowest-order (in g) nonzero contribution to that process.

We now have

$$\begin{aligned} & \langle 0 | T \varphi(x_1) \varphi(x_2) \varphi(x'_1) \varphi(x'_2) | 0 \rangle_C \\ &= (ig)^2 \left(\frac{1}{i}\right)^5 \int d^4y d^4z \Delta(y-z) \\ & \quad \times \left[\Delta(x_1-y) \Delta(x_2-y) \Delta(x'_1-z) \Delta(x'_2-z) \right. \\ & \quad + \Delta(x_1-y) \Delta(x'_1-y) \Delta(x_2-z) \Delta(x'_2-z) \\ & \quad \left. + \Delta(x_1-y) \Delta(x'_2-y) \Delta(x_2-z) \Delta(x'_1-z) \right] \\ & \quad + O(g^4). \end{aligned} \quad (239)$$

Next, we use eq. (239) in the LSZ formula, eq. (235). Each Klein-Gordon wave operator acts on a propagator to give

$$(-\partial_i^2 + m^2) \Delta(x_i - y) = \delta^4(x_i - y). \quad (240)$$

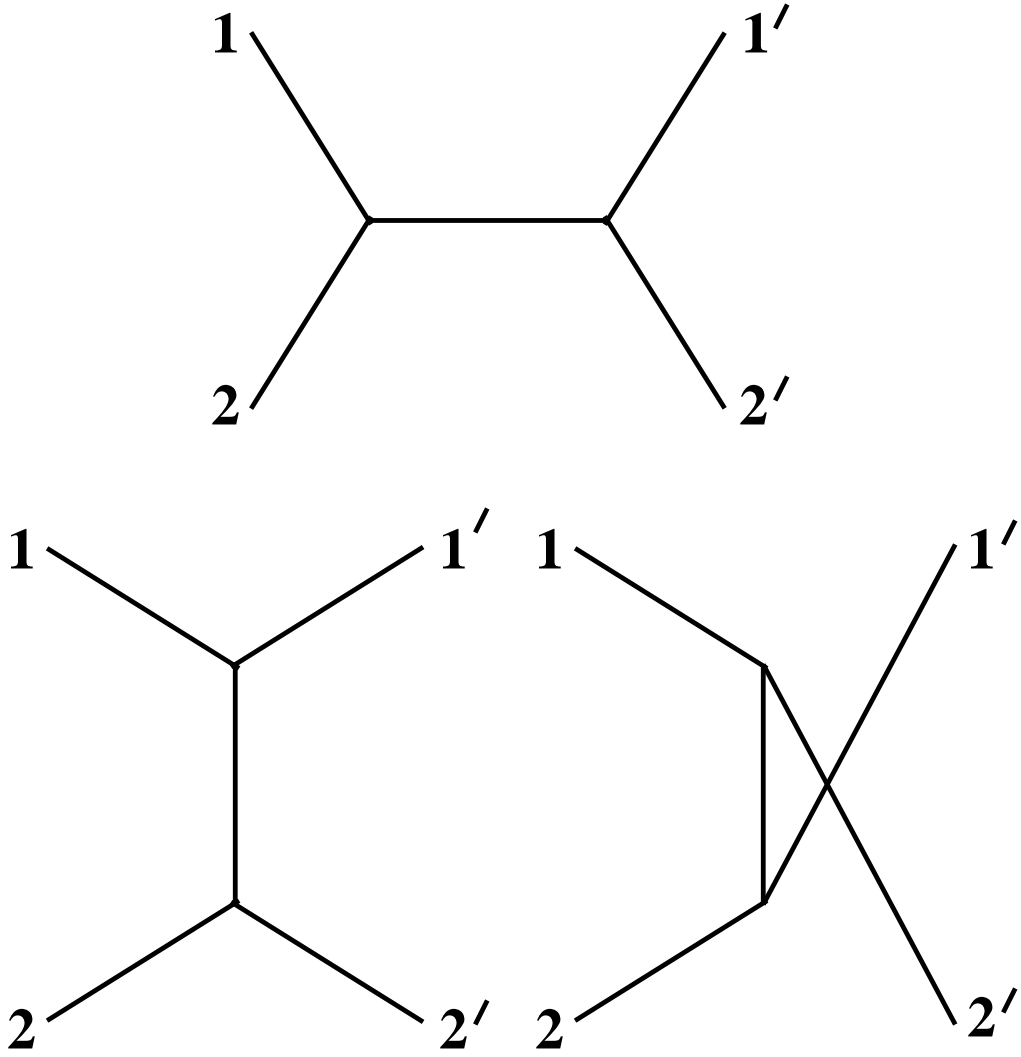

Figure 17: The three tree-level Feynman diagrams that contribute to the connected correlation function $\langle 0 | T \varphi(x_1) \varphi(x_2) \varphi(x'_1) \varphi(x'_2) | 0 \rangle_C$.

The integrals over the external spacetime labels $x_{1,2,1',2'}$ are then trivial, and we get

$$\begin{aligned} \langle f|i \rangle = (ig)^2 \left(\frac{1}{i}\right) \int d^4y d^4z \Delta(y-z) & \left[e^{i(k_1y+k_2y-k'_1z-k'_2z)} \right. \\ & + e^{i(k_1y+k_2z-k'_1y-k'_2z)} \\ & \left. + e^{i(k_1y+k_2z-k'_1z-k'_2y)} \right] + O(g^4) . \end{aligned} \quad (241)$$

This can be simplified by substituting

$$\Delta(y-z) = \int \frac{d^4k}{(2\pi)^4} \frac{e^{ik(y-z)}}{k^2 + m^2 - i\epsilon} \quad (242)$$

into eq. (239). Then the spacetime arguments appear only in phase factors, and we can integrate them to get delta functions:

$$\begin{aligned} \langle f|i \rangle &= ig^2 \int \frac{d^4k}{(2\pi)^4} \frac{1}{k^2 + m^2 - i\epsilon} \\ &\quad \times \left[(2\pi)^4 \delta^4(k_1+k_2+k) (2\pi)^4 \delta^4(k'_1+k'_2+k) \right. \\ &\quad + (2\pi)^4 \delta^4(k_1-k'_1+k) (2\pi)^4 \delta^4(k'_2-k_2+k) \\ &\quad \left. + (2\pi)^4 \delta^4(k_1-k'_2+k) (2\pi)^4 \delta^4(k'_1-k_2+k) \right] + O(g^4) \quad (243) \\ &= ig^2 (2\pi)^4 \delta^4(k_1+k_2-k'_1-k'_2) \\ &\quad \times \left[\frac{1}{(k_1+k_2)^2 + m^2} + \frac{1}{(k_1-k'_1)^2 + m^2} + \frac{1}{(k_1-k'_2)^2 + m^2} \right] \\ &\quad + O(g^4) . \end{aligned} \quad (244)$$

In eq. (244), we have left out the $i\epsilon$'s for notational convenience only; m^2 is really $m^2 - i\epsilon$. The overall delta function in eq. (244) tells that that four-momentum is conserved in the scattering process, which we should, of course, expect. For a general scattering process, it is then convenient to define a scattering matrix element \mathcal{T} via

$$\langle f|i \rangle = i(2\pi)^4 \delta^4(k_{\text{in}} - k_{\text{out}}) \mathcal{T} , \quad (245)$$

where k_{in} and k_{out} are the total four-momenta of the incoming and outgoing particles, respectively.

Examining the calculation which led to eq. (244), we can take away some universal features that lead to a simple set of *Feynman rules* for computing contributions to \mathcal{T} for a given scattering process. The Feynman rules are:

1) Draw lines (called *external lines*) for each incoming and each outgoing particle.

2) Leave one end of each external line free, and attach the other to a vertex at which exactly three lines meet. Include extra *internal lines* in order to do this. In this way, draw all possible diagrams that are *topologically inequivalent*.

3) On each incoming line, draw an arrow pointing towards the vertex. On each outgoing line, draw an arrow pointing away from the vertex. On each internal line, draw an arrow with an arbitrary direction.

4) Assign each line its own four-momentum. The four-momentum of an external line should be the four-momentum of the corresponding particle.

5) Think of the four-momenta as flowing along the arrows, and conserve four-momentum at each vertex. For a tree diagram, this fixes the momenta on all the internal lines.

6) The value of a diagram consists of the following factors: for each external line, 1; for each vertex, $iZ_\varphi g$; for each internal line, $-i/(k^2 + m^2 - i\epsilon)$, where k is the four-momentum of that line.

7) A diagram with L closed loops will have L internal momenta that are not fixed by Rule 4. Integrate over each of these momenta ℓ_i with measure $d^4\ell_i/(2\pi)^4$

8) A loop diagram may have some leftover symmetry factors if there are exchanges of *internal* propagators and vertices that leave the diagram unchanged; in this case, divide the value of the diagram by the symmetry factor associated with exchanges of internal propagators and vertices.

9) Include diagrams with the *counterterm vertex* that connects two propagators, each with the same four-momentum k . The value of this vertex is $-i(Ak^2 + Bm^2)$, where $A = Z_\varphi - 1$ and $B = Z_m - 1$, and each is $O(g^2)$.

10) The value of $i\mathcal{T}$ is given by a sum over the values of all these diagrams.

For the two-particle scattering process, the tree diagrams resulting from these rules are shown in fig. (18).

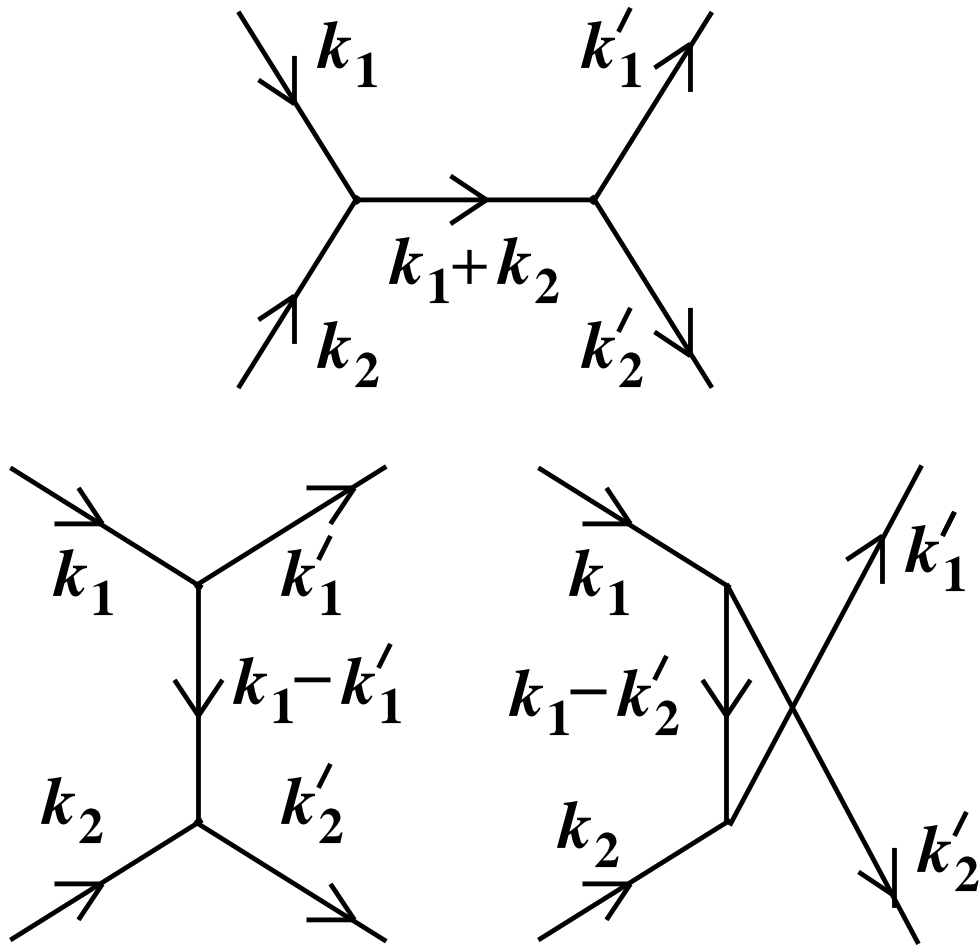

Figure 18: The tree-level s -, t -, and u -channel diagrams contributing to $i\mathcal{T}$ for two particle scattering.

Now that we have our procedure for computing the scattering amplitude \mathcal{T} , we must see how to relate it to a measurable cross section.

Problems

10.1) Write down the Feynman rules for the complex scalar field of problem 9.3. Remember that there are two kinds of particles now (which we can think of as positively and negatively charged), and that your rules must have a way of distinguishing them. Hint: the most direct approach requires two kinds of arrows: momentum arrows (as discussed in this section) and what we might call “charge” arrows (as discussed in problem 9.3). Try to find a more elegant approach that requires only one kind of arrow.

10.2) Consider a complex scalar field φ that interacts with a real scalar field χ via $\mathcal{L}_1 = g\chi\partial^\mu\varphi^\dagger\partial_\mu\varphi$. Use a solid line for the φ propagator and a dashed line for the χ propagator. Draw the vertex (remember the arrows!), and find the associated vertex factor.

10.3) Consider a real scalar field with $\mathcal{L}_1 = \frac{1}{2}g\varphi\partial^\mu\varphi\partial_\mu\varphi$. Find the associated vertex factor.

10.4) Consider a theory of three real scalar fields (A , B , and C) with

$$\begin{aligned} \mathcal{L} = & -\frac{1}{2}\partial^\mu A\partial_\mu A - \frac{1}{2}m_A^2 A^2 \\ & -\frac{1}{2}\partial^\mu B\partial_\mu B - \frac{1}{2}m_B^2 B^2 \\ & -\frac{1}{2}\partial^\mu C\partial_\mu C - \frac{1}{2}m_C^2 C^2 \\ & + gABC . \end{aligned} \tag{246}$$

Write down the tree-level scattering amplitude (given by the sum of the contributing tree diagrams) for each of the following processes:

$$AA \rightarrow AA ,$$

$$AA \rightarrow AB ,$$

$$AA \rightarrow BB ,$$

$$AA \rightarrow BC ,$$

$$\begin{aligned}
AB &\rightarrow AB, \\
AB &\rightarrow AC.
\end{aligned}
\tag{247}$$

Your answers should take the form

$$\mathcal{T} = g^2 \left[\frac{c_s}{m_s^2 - s} + \frac{c_t}{m_t^2 - t} + \frac{c_u}{m_u^2 - u} \right],
\tag{248}$$

where, in each case, each c_i is a positive integer, and each m_i^2 is m_A^2 or m_B^2 or m_C^2 . Hint: \mathcal{T} may be zero for some processes.

11: Cross Sections and Decay Rates

Prerequisite: 10

Now that we have a method for computing the scattering amplitude \mathcal{T} , we must convert it into something that could be measured in an experiment.

In practice, we are almost always concerned with one of two generic cases: one incoming particle, for which we compute a *decay rate*, or two incoming particles, for which we compute a *cross section*. We begin with the latter.

Let us also specialize, for now, to the case of two outgoing particles as well as two incoming particles. In φ^3 theory, we found in section 10 that in this case we have

$$\mathcal{T} = g^2 \left[\frac{1}{(k_1+k_2)^2 + m^2} + \frac{1}{(k_1-k'_1)^2 + m^2} + \frac{1}{(k_1-k'_2)^2 + m^2} \right] + O(g^4), \quad (249)$$

where k_1 and k_2 are the four-momenta of the two incoming particles, k'_1 and k'_2 are the four-momenta of the two outgoing particles, and $k_1 + k_2 = k'_1 + k'_2$. Also, these particles are all *on shell*: $k_i^2 = -m_i^2$. (Here, for later use, we allow for the possibility that the particles all have different masses.)

Let us think about the kinematics of this process. In the *center-of-mass frame*, or *CM frame* for short, we take $\mathbf{k}_1 + \mathbf{k}_2 = \mathbf{0}$, and choose \mathbf{k}_1 to be in the $+z$ direction. Now the only variable left to specify about the initial state is the magnitude of \mathbf{k}_1 . Equivalently, we could specify the total energy in the CM frame, $E_1 + E_2$. However, it is even more convenient to define a Lorentz scalar $s \equiv -(k_1+k_2)^2$. In the CM frame, s reduces to $(E_1+E_2)^2$; s is therefore called the *center-of-mass energy squared*. Then, since $E_1 = (\mathbf{k}_1^2 + m_1^2)^{1/2}$ and $E_2 = (\mathbf{k}_1^2 + m_2^2)^{1/2}$, we can solve for $|\mathbf{k}_1|$ in terms of s , with the result

$$|\mathbf{k}_1| = \frac{1}{2\sqrt{s}} \sqrt{s^2 - 2(m_1^2 + m_2^2)s + (m_1^2 - m_2^2)^2} \quad (\text{CM frame}). \quad (250)$$

Now consider the two outgoing particles. Since momentum is conserved, we must have $\mathbf{k}'_1 + \mathbf{k}'_2 = \mathbf{0}$, and since energy is conserved, we must also have $(E'_1 + E'_2)^2 = s$. Then we find

$$|\mathbf{k}'_1| = \frac{1}{2\sqrt{s}} \sqrt{s^2 - 2(m_1^2 + m_2^2)s + (m_1^2 - m_2^2)^2} \quad (\text{CM frame}) . \quad (251)$$

Now the only variable left to specify about the final state is the angle θ between \mathbf{k}_1 and \mathbf{k}'_1 . However, it is often more convenient to work with the Lorentz scalar $t \equiv -(k_1 - k'_1)^2$, which is related to θ by

$$t = m_1^2 + m_1'^2 - 2E_1 E'_1 + 2|\mathbf{k}_1||\mathbf{k}'_1| \cos \theta . \quad (252)$$

This formula is valid in any frame.

The Lorentz scalars s and t are two of the three *Mandelstam variables*, defined as

$$\begin{aligned} s &\equiv -(k_1 + k_2)^2 = -(k'_1 + k'_2)^2 , \\ t &\equiv -(k_1 - k'_1)^2 = -(k_2 - k'_2)^2 , \\ u &\equiv -(k_1 - k'_2)^2 = -(k_2 - k'_1)^2 . \end{aligned} \quad (253)$$

The three Mandelstam variables are not independent; they satisfy the linear relation

$$s + t + u = m_1^2 + m_2^2 + m_1'^2 + m_2'^2 . \quad (254)$$

In terms of s , t , and u , we can rewrite eq. (249) as

$$\mathcal{T} = g^2 \left[\frac{1}{m^2 - s} + \frac{1}{m^2 - t} + \frac{1}{m^2 - u} \right] + O(g^4) , \quad (255)$$

which demonstrates the notational utility of the Mandelstam variables.

Now let us consider a different frame, the *fixed target* or *FT frame* (also sometimes called the *lab frame*), in which particle #2 is initially at rest: $\mathbf{k}_2 = \mathbf{0}$. In this case we have

$$|\mathbf{k}_1| = \frac{1}{2m_2} \sqrt{s^2 - 2(m_1^2 + m_2^2)s + (m_1^2 - m_2^2)^2} \quad (\text{FT frame}) . \quad (256)$$

Note that, from eqs. (256) and (250),

$$m_2 |\mathbf{k}_1|_{\text{FT}} = \sqrt{s} |\mathbf{k}_1|_{\text{CM}} . \quad (257)$$

This will be useful later.

We would now like to derive a formula for the differential scattering cross section. In order to do so, we assume that the whole experiment is taking place in a big box of volume V , and lasts for a large time T . We should really think about wave packets coming together, but we will use some simple shortcuts instead. Also, to get a more general answer, we will let the number of outgoing particles be arbitrary.

Recall from section 10 that the overlap between the initial and final states is given by

$$\langle f|i\rangle = i(2\pi)^4\delta^4(k_{\text{in}}-k_{\text{out}})\mathcal{T} . \quad (258)$$

To get a probability, we must square $\langle f|i\rangle$, and divide by the norms of the initial and final states:

$$P = \frac{|\langle f|i\rangle|^2}{\langle f|f\rangle\langle i|i\rangle} . \quad (259)$$

The numerator of this expression is

$$|\langle f|i\rangle|^2 = [(2\pi)^4\delta^4(k_{\text{in}}-k_{\text{out}})]^2 |\mathcal{T}|^2 . \quad (260)$$

We write the square of the delta function as

$$[(2\pi)^4\delta^4(k_{\text{in}}-k_{\text{out}})]^2 = (2\pi)^4\delta^4(k_{\text{in}}-k_{\text{out}}) \times (2\pi)^4\delta^4(0) , \quad (261)$$

and note that

$$(2\pi)^4\delta^4(0) = \int d^4x e^{i0\cdot x} = VT . \quad (262)$$

Also, the norm of a single particle state is given by

$$\langle k|k\rangle = (2\pi)^3 2k^0\delta^3(\mathbf{0}) = 2k^0V . \quad (263)$$

Thus we have

$$\langle i|i\rangle = 4E_1E_2V^2 , \quad (264)$$

$$\langle f|f\rangle = \prod_{j=1}^{n'} 2k_j^0V , \quad (265)$$

where n' is the number of outgoing particles.

If we now divide eq. (259) by the elapsed time T , we get a probability per unit time

$$\dot{P} = \frac{(2\pi)^4 \delta^4(k_{\text{in}} - k_{\text{out}}) V |\mathcal{T}|^2}{4E_1 E_2 V^2 \prod_{j=1}^{n'} 2k_j'^0 V}. \quad (266)$$

This is the probability per unit time to scatter into a set of outgoing particles with precise momenta. To get something measurable, we should sum each outgoing three-momentum \mathbf{k}'_j over some small range. Due to the box, all three-momenta are quantized: $\mathbf{k}'_j = (2\pi/L)\mathbf{n}'_j$, where $V = L^3$, and \mathbf{n}'_j is a three-vector with integer entries. (Here we have assumed periodic boundary conditions, but this choice does not affect the final result.) In the limit of large L , we have

$$\sum_{\mathbf{n}'_j} \rightarrow \frac{V}{(2\pi)^3} \int d^3k'_j. \quad (267)$$

Thus we should multiply \dot{P} by a factor of $V d^3k'_j / (2\pi)^3$ for each outgoing particle. Then we get

$$\dot{P} = \frac{(2\pi)^4 \delta^4(k_{\text{in}} - k_{\text{out}})}{4E_1 E_2 V} |\mathcal{T}|^2 \prod_{j=1}^{n'} \widetilde{dk}'_j, \quad (268)$$

where we have identified the Lorentz-invariant phase-space differential

$$\widetilde{dk} \equiv \frac{d^3k}{(2\pi)^3 2k^0} \quad (269)$$

that we first introduced in section 3.

To convert \dot{P} to a differential cross section $d\sigma$, we must divide by the incident flux. Let us see how this works in the FT frame, where particle #2 is at rest. The incident flux is the number of particles per unit volume that are striking the target particle (#2), times their speed. We have one incident particle (#1) in a volume V with speed $v = |\mathbf{k}_1|/E_1$, and so the incident flux is $|\mathbf{k}_1|/E_1 V$. Dividing eq. (268) by this flux cancels the last factor of V , and replaces E_1 in the denominator with $|\mathbf{k}_1|$. We also set $E_2 = m_2$ and note that eq. (256) gives $|\mathbf{k}_1| m_2$ as a function of s ; $d\sigma$ will be Lorentz invariant if, in other frames, we simply use this function as the value of $|\mathbf{k}_1| m_2$. Adopting this convention, and using eq. (257), we have

$$d\sigma = \frac{1}{4|\mathbf{k}_1|_{\text{CM}} \sqrt{s}} |\mathcal{T}|^2 d\text{LIPS}_{n'}, \quad (270)$$

where $|\mathbf{k}_1|_{\text{CM}}$ is given as a function of s by eq. (250), and we have defined the n' -body Lorentz-invariant phase-space measure

$$d\text{LIPS}_{n'} \equiv (2\pi)^4 \delta^4(k_1 + k_2 - \sum_{j=1}^{n'} k'_j) \prod_{j=1}^{n'} \widetilde{dk}'_j . \quad (271)$$

Eq. (270) is our final result for the differential cross section for the scattering of two incoming particles into n' outgoing particles.

Let us now specialize to the case of two outgoing particles. We need to evaluate

$$d\text{LIPS}_2 = (2\pi)^4 \delta^4(k_1 + k_2 - k'_1 - k'_2) \widetilde{dk}'_1 \widetilde{dk}'_2 . \quad (272)$$

Since $d\text{LIPS}_2$ is Lorentz invariant, we can compute it in any convenient frame. Let us work in the CM frame, where $\mathbf{k}_1 + \mathbf{k}_2 = \mathbf{0}$ and $E_1 + E_2 = \sqrt{s}$; then we have

$$d\text{LIPS}_2 = \frac{1}{4(2\pi)^2 E'_1 E'_2} \delta(E'_1 + E'_2 - \sqrt{s}) \delta^3(\mathbf{k}'_1 + \mathbf{k}'_2) d^3k'_1 d^3k'_2 . \quad (273)$$

We can use the spatial part of the delta function to integrate over $d^3k'_2$, with the result

$$d\text{LIPS}_2 = \frac{1}{4(2\pi)^2 E'_1 E'_2} \delta(E'_1 + E'_2 - \sqrt{s}) d^3k'_1 , \quad (274)$$

where now

$$E'_1 = \sqrt{\mathbf{k}'_1{}^2 + m_1^2} \quad \text{and} \quad E'_2 = \sqrt{\mathbf{k}'_1{}^2 + m_2^2} . \quad (275)$$

Next, let us write

$$d^3k'_1 = |\mathbf{k}'_1|^2 d|\mathbf{k}'_1| d\Omega_{\text{CM}} , \quad (276)$$

where $d\Omega_{\text{CM}} = \sin\theta d\theta d\phi$ is the differential solid angle, and θ is the angle between \mathbf{k}_1 and \mathbf{k}'_1 in the CM frame. We can carry out the integral over the magnitude of \mathbf{k}'_1 in eq. (274) using $\int dx \delta(f(x)) = \sum_i |f'(x_i)|^{-1}$, where x_i satisfies $f(x_i) = 0$. In our case, the argument of the delta function vanishes at just one value of $|\mathbf{k}'_1|$, the value given by eq. (251). Also, the derivative of that argument with respect to $|\mathbf{k}'_1|$ is

$$\frac{\partial}{\partial |\mathbf{k}'_1|} (E'_1 + E'_2 - \sqrt{s}) = \frac{|\mathbf{k}'_1|}{E'_1} + \frac{|\mathbf{k}'_1|}{E'_2}$$

$$\begin{aligned}
&= |\mathbf{k}'_1| \left(\frac{E'_1 + E'_2}{E'_1 E'_2} \right) \\
&= \frac{|\mathbf{k}'_1| \sqrt{s}}{E'_1 E'_2}.
\end{aligned} \tag{277}$$

Putting all of this together, we get

$$d\text{LIPS}_2 = \frac{|\mathbf{k}'_1|}{16\pi^2 \sqrt{s}} d\Omega_{\text{CM}}. \tag{278}$$

Combining this with eq. (270), we have

$$\frac{d\sigma}{d\Omega_{\text{CM}}} = \frac{1}{64\pi^2 s} \frac{|\mathbf{k}'_1|}{|\mathbf{k}_1|} |\mathcal{T}|^2, \tag{279}$$

where $|\mathbf{k}_1|$ and $|\mathbf{k}'_1|$ are the functions of s given by eqs. (250) and (251), and $d\Omega_{\text{CM}}$ is the differential solid angle in the CM frame.

The differential cross section can also be expressed in a frame-independent manner by noting that, in the CM frame, we can take the differential of eq. (252) at fixed s to get

$$dt = 2 |\mathbf{k}_1| |\mathbf{k}'_1| d\cos\theta \tag{280}$$

$$= 2 |\mathbf{k}_1| |\mathbf{k}'_1| \frac{d\Omega_{\text{CM}}}{2\pi}. \tag{281}$$

Now we can rewrite eq. (279) as

$$\frac{d\sigma}{dt} = \frac{1}{64\pi s |\mathbf{k}_1|^2} |\mathcal{T}|^2, \tag{282}$$

where $|\mathbf{k}_1|$ is given as a function of s by eq. (250).

We can now transform $d\sigma/dt$ into $d\sigma/d\Omega$ in any frame we might like (such as the FT frame) by taking the differential of eq. (252) in that frame. In general, though, $|\mathbf{k}'_1|$ depends on θ as well as s , so the result is more complicated than it is in eq. (280) for the CM frame.

Returning to the general case of n' outgoing particles, we can define a Lorentz invariant *total cross section* by integrating completely over all the

outgoing momenta, and dividing by an appropriate *symmetry factor* S . If there are n'_i identical outgoing particles of type i , then

$$S = \prod_i n'_i! , \quad (283)$$

and

$$\sigma = \frac{1}{S} \int d\sigma , \quad (284)$$

where $d\sigma$ is given by eq. (270). We need the symmetry factor because merely integrating over all the outgoing momenta in $dLIPS_{n'}$ treats the final state as being labeled by an *ordered* list of these momenta. But if some outgoing particles are identical, this is not correct; the momenta of the identical particles should be specified by an *unordered* list [because, for example, the state $a_1^\dagger a_2^\dagger |0\rangle$ is identical to the state $a_2^\dagger a_1^\dagger |0\rangle$]. The symmetry factor provides the appropriate correction.

In the case of two outgoing particles, eq. (284) becomes

$$\sigma = \frac{1}{S} \int d\Omega_{\text{CM}} \frac{d\sigma}{d\Omega_{\text{CM}}} \quad (285)$$

$$= \frac{2\pi}{S} \int_{-1}^{+1} d\cos\theta \frac{d\sigma}{d\Omega_{\text{CM}}} , \quad (286)$$

where $S = 2$ if the two outgoing particles are identical, and $S = 1$ if they are distinguishable. Equivalently, we can compute σ from eq. (282) via

$$\sigma = \frac{1}{S} \int_{t_{\min}}^{t_{\max}} dt \frac{d\sigma}{dt} , \quad (287)$$

where t_{\min} and t_{\max} are given by eq. (252) in the CM frame with $\cos\theta = -1$ and $+1$, respectively. To compute σ with eq. (286), we should first express t and u in terms of s and θ via eqs. (252) and (254), and then integrate over θ at fixed s . To compute σ with eq. (287), we should first express u in terms of s and t via eq. (254), and then integrate over t at fixed s .

Let us see how all this works for the scattering amplitude of φ^3 theory, eq. (255). In this case, all the masses are equal, and so, in the CM frame, $E = \frac{1}{2}\sqrt{s}$ for all four particles, and $|\mathbf{k}'_1| = |\mathbf{k}_1| = \frac{1}{2}(s - 4m^2)^{1/2}$. Then eq. (252) becomes

$$t = -\frac{1}{2}(s - 4m^2)(1 - \cos\theta) . \quad (288)$$

From eq. (254), we also have

$$u = -\frac{1}{2}(s - 4m^2)(1 + \cos \theta). \quad (289)$$

Thus $|\mathcal{T}|^2$ is quite a complicated function of s and θ . In the nonrelativistic limit, $|\mathbf{k}_1| \ll m$ or equivalently $s - 4m^2 \ll m^2$, we have

$$\begin{aligned} \mathcal{T} = & \frac{5g^2}{3m^2} \left[1 - \frac{8}{15} \left(\frac{s - 4m^2}{m^2} \right) + \frac{5}{18} \left(1 + \frac{27}{25} \cos^2 \theta \right) \left(\frac{s - 4m^2}{m^2} \right)^2 + \dots \right] \\ & + O(g^4). \end{aligned} \quad (290)$$

Thus the differential cross section is nearly isotropic. In the extreme relativistic limit, $|\mathbf{k}_1| \gg m$ or equivalently $s \gg m^2$, we have

$$\begin{aligned} \mathcal{T} = & \frac{g^2}{s \sin^2 \theta} \left[3 + \cos^2 \theta - \left(\frac{(3 + \cos^2 \theta)^2}{\sin^2 \theta} - 16 \right) \frac{m^2}{s} + \dots \right] \\ & + O(g^4). \end{aligned} \quad (291)$$

Now the differential cross section is sharply peaked in the forward ($\theta = 0$) and backward ($\theta = \pi$) directions.

We can compute the total cross section σ from eq. (287). We have in this case $t_{\min} = -(s - 4m^2)$ and $t_{\max} = 0$. Since the two outgoing particles are identical, the symmetry factor is $S = 2$. Then setting $u = 4m^2 - s - t$, and performing the integral in eq. (287) over t at fixed s , we get

$$\begin{aligned} \sigma = & \frac{g^4}{32\pi s(s - 4m^2)} \left[\frac{2}{m^2} + \frac{s - 4m^2}{(s - m^2)^2} - \frac{2}{s - 3m^2} \right. \\ & \left. + \frac{4m^2}{(s - m^2)(s - 2m^2)} \ln \left(\frac{s - 3m^2}{m^2} \right) \right] + O(g^6). \end{aligned} \quad (292)$$

In the nonrelativistic limit, this becomes

$$\sigma = \frac{25g^4}{1152\pi m^6} \left[1 - \frac{79}{60} \left(\frac{s - 4m^2}{m^2} \right) + \dots \right] + O(g^6). \quad (293)$$

In the extreme relativistic limit, we get

$$\sigma = \frac{g^4}{16\pi m^2 s^2} \left[1 + \frac{7}{2} \frac{m^2}{s} + \dots \right] + O(g^6). \quad (294)$$

These results illustrate how even a very simple quantum field theory can yield specific predictions for cross sections that could be tested experimentally.

Let us now turn to the other basic problem mentioned at the beginning of this section: the case of a single incoming particle that *decays* to n' other particles.

We have an immediate conceptual problem. According to our development of the LSZ formula in section 5, each incoming and outgoing particle should correspond to a single-particle state that is an exact eigenstate of the exact hamiltonian. This is clearly not the case for a particle that can decay. Referring to fig. (139), the hyperbola of such a particle must lie above the continuum threshold. Strictly speaking, then, the LSZ formula is not applicable.

A proper understanding of this issue requires a study of loop corrections that we will undertake in section 24. For now, we will simply assume that the LSZ formula continues to hold for a single incoming particle. Then we can retrace the steps from eq. (259) to eq. (268); the only change is that the norm of the initial state is now

$$\langle i|i \rangle = 2E_1 V \tag{295}$$

instead of eq. (264). Identifying the differential decay rate $d\Gamma$ with \dot{P} then gives

$$d\Gamma = \frac{1}{2E_1} |\mathcal{T}|^2 d\text{LIPS}_{n'} , \tag{296}$$

where now $k_2 = 0$ and $s = m_1^2$. In the CM frame (which is now the rest frame of the initial particle), we have $E_1 = m_1$; in other frames, the relative factor of E_1/m_1 in $d\Gamma$ accounts for relativistic time dilation of the decay rate.

We can also define a total decay rate by integrating over all the outgoing momenta, and dividing by the symmetry factor of eq. (283):

$$\Gamma = \frac{1}{S} \int d\Gamma . \tag{297}$$

Problems

11.1a) Consider a theory of a two real scalar fields A and B with an interaction $\mathcal{L}_1 = gAB^2$. Assuming that $m_A > 2m_B$, compute the total decay rate of the A particle at tree level.

b) Consider a theory of a real scalar field φ and a complex scalar field χ with $\mathcal{L}_1 = g\varphi\chi^\dagger\chi$. Assuming that $m_\varphi > 2m_\chi$, compute the total decay rate of the φ particle at tree level.

12: The Lehmann-Källén Form of the Exact Propagator

Prerequisite: 9

Before turning to the subject of loop corrections to scattering amplitudes, it will be helpful to consider what we can learn about the exact propagator $\Delta(x - y)$ from general principles. We define the exact propagator via

$$\Delta(x - y) \equiv i \langle 0 | T \varphi(x) \varphi(y) | 0 \rangle . \quad (298)$$

We take the field $\varphi(x)$ to be normalized so that

$$\langle 0 | \varphi(x) | 0 \rangle = 0 \quad \text{and} \quad \langle k | \varphi(x) | 0 \rangle = e^{-ikx} , \quad (299)$$

where the one-particle state $|k\rangle$ has the normalization

$$\langle k | k' \rangle = (2\pi)^3 2\omega \delta^3(\mathbf{k} - \mathbf{k}') , \quad (300)$$

with $\omega = (\mathbf{k}^2 + m^2)^{1/2}$. The corresponding completeness statement is

$$\int \widetilde{dk} |k\rangle \langle k| = I_1 , \quad (301)$$

where I_1 is the identity operator in the one-particle subspace, and

$$\widetilde{dk} \equiv \frac{d^3k}{(2\pi)^3 2\omega} \quad (302)$$

is the Lorentz invariant phase-space differential. We also define the exact momentum-space propagator $\tilde{\Delta}(k^2)$ via

$$\Delta(x - y) \equiv \int \frac{d^4k}{(2\pi)^4} e^{ik(x-y)} \tilde{\Delta}(k^2) . \quad (303)$$

In free-field theory, the momentum-space propagator is

$$\tilde{\Delta}(k^2) = \frac{1}{k^2 + m^2 - i\epsilon} . \quad (304)$$

It has an isolated pole at $k^2 = -m^2$ with residue one; m is the actual, physical mass of the particle, the mass that enters into the energy-momentum relation.

Now let us return to the exact propagator, eq. (298), take $x^0 > y^0$, and insert a complete set of energy eigenstates between the two fields. Recall from section 5 that there are three general classes of energy eigenstates: (1) The ground state or vacuum $|0\rangle$, which is a single state with zero energy and momentum. (2) The one particle states $|k\rangle$, specified by a three-momentum \mathbf{k} and with energy $\omega = (\mathbf{k}^2 + m^2)^{1/2}$. (3) States in the multiparticle continuum $|k, n\rangle$, specified by a three-momentum \mathbf{k} and other parameters (such as relative momenta among the different particles) that we will collectively denote as n . The energy of one of these states is $\omega = (\mathbf{k}^2 + M^2)^{1/2}$, where $M \geq 2m$; M is one of the parameters in the set n . Thus we get

$$\begin{aligned} \langle 0|\varphi(x)\varphi(y)|0\rangle &= \langle 0|\varphi(x)|0\rangle\langle 0|\varphi(y)|0\rangle \\ &+ \int \tilde{d}\mathbf{k} \langle 0|\varphi(x)|k\rangle\langle k|\varphi(y)|0\rangle \\ &+ \sum_n \int \tilde{d}\mathbf{k} \langle 0|\varphi(x)|k, n\rangle\langle k, n|\varphi(y)|0\rangle . \end{aligned} \quad (305)$$

The first two terms can be simplified via eq. (299). Also, writing the field as $\varphi(x) = \exp(-iP^\mu x_\mu)\varphi(0)\exp(+iP^\mu x_\mu)$, where P^μ is the energy-momentum operator, gives us

$$\langle k, n|\varphi(x)|0\rangle = e^{-ikx}\langle k, n|\varphi(0)|0\rangle , \quad (306)$$

where $k^0 = (\mathbf{k}^2 + M^2)^{1/2}$. We now have

$$\langle 0|\varphi(x)\varphi(y)|0\rangle = \int \tilde{d}\mathbf{k} e^{ik(x-y)} + \sum_n \int \tilde{d}\mathbf{k} e^{ik(x-y)} |\langle k, n|\varphi(0)|0\rangle|^2 . \quad (307)$$

Next, we define the *spectral density*

$$\rho(s) \equiv \sum_n |\langle k, n|\varphi(0)|0\rangle|^2 \delta(s - M^2) . \quad (308)$$

Obviously, $\rho(s) \geq 0$ for $s \geq 4m^2$, and $\rho(s) = 0$ for $s < 4m^2$. Now we have

$$\langle 0|\varphi(x)\varphi(y)|0\rangle = \int \widetilde{d}k e^{ik(x-y)} + \int_{4m^2}^{\infty} ds \rho(s) \int \widetilde{d}k e^{ik(x-y)}. \quad (309)$$

In the first term, $k^0 = (\mathbf{k}^2 + m^2)^{1/2}$, and in the second term, $k^0 = (\mathbf{k}^2 + s)^{1/2}$. Clearly we can also swap x and y to get

$$\langle 0|\varphi(y)\varphi(x)|0\rangle = \int \widetilde{d}k e^{-ik(x-y)} + \int_{4m^2}^{\infty} ds \rho(s) \int \widetilde{d}k e^{-ik(x-y)}. \quad (310)$$

as well. We can then combine eqs. (309) and (310) into a formula for the time-ordered product

$$\langle 0|T\varphi(x)\varphi(y)|0\rangle = \theta(x^0 - y^0)\langle 0|\varphi(x)\varphi(y)|0\rangle + \theta(y^0 - x^0)\langle 0|\varphi(y)\varphi(x)|0\rangle, \quad (311)$$

where $\theta(t)$ is the unit step function, by means of the identity

$$\int \frac{d^4k}{(2\pi)^4} \frac{e^{ik(x-y)}}{k^2 + m^2 - i\epsilon} = i\theta(x^0 - y^0) \int \widetilde{d}k e^{ik(x-y)} + i\theta(y^0 - x^0) \int \widetilde{d}k e^{-ik(x-y)}; \quad (312)$$

the derivation of eq. (312) was sketched in section 8. Combining eqs. (309), (310), (311), and (312), we get

$$i\langle 0|T\varphi(x)\varphi(y)|0\rangle = \int \frac{d^4k}{(2\pi)^4} e^{ik(x-y)} \left[\frac{1}{k^2 + m^2 - i\epsilon} + \int_{4m^2}^{\infty} ds \rho(s) \frac{1}{k^2 + s - i\epsilon} \right]. \quad (313)$$

Comparing eqs. (298), (303), and (313), we see that

$$\tilde{\Delta}(k^2) = \frac{1}{k^2 + m^2 - i\epsilon} + \int_{4m^2}^{\infty} ds \rho(s) \frac{1}{k^2 + s - i\epsilon}. \quad (314)$$

This is the *Lehmann-Källén form* of the exact momentum-space propagator $\tilde{\Delta}(k^2)$. We note in particular that $\tilde{\Delta}(k^2)$ has an isolated pole at $k^2 = -m^2$ with residue one, just like the propagator in free-field theory.

13: Dimensional Analysis with $\hbar = c = 1$

Prerequisite: 3

We have set $\hbar = c = 1$. This allows us to convert a time T to a length L via $T = L/c$, and a length L to a mass M via $M = \hbar c^{-1}/L$. Thus any quantity A can be thought of as having units of mass to some some power (positive, negative, or zero) that we will call $[A]$. For example,

$$[m] = +1 , \quad (315)$$

$$[x^\mu] = -1 , \quad (316)$$

$$[\partial^\mu] = +1 , \quad (317)$$

$$[d^d x] = -d . \quad (318)$$

In the last line, we have generalized our considerations to theories in d space-time dimensions.

Let us now consider a scalar field in d spacetime dimensions with lagrangian density

$$\mathcal{L} = -\frac{1}{2}\partial^\mu\varphi\partial_\mu\varphi - \frac{1}{2}m^2\varphi^2 - \sum_{n=3}^N \frac{1}{n!}g_n\varphi^n . \quad (319)$$

The action is

$$S = \int d^d x \mathcal{L} , \quad (320)$$

and the path integral is

$$Z(J) = \int \mathcal{D}\varphi \exp\left[i \int d^d x (\mathcal{L} + J\varphi)\right] . \quad (321)$$

From eq. (321), we see that the action S must be dimensionless, because it appears as the argument of the exponential function. Therefore

$$[S] = 0 . \quad (322)$$

From eqs. (322) and (318), we see that

$$[\mathcal{L}] = +d . \tag{323}$$

Then, from eqs. (323) and (317), and the fact that $\partial^\mu \varphi \partial_\mu \varphi$ is a term in \mathcal{L} , we see that we must have

$$[\varphi] = \frac{1}{2}(d - 2) . \tag{324}$$

Then, since $g_n \varphi^n$ is also a term in \mathcal{L} , we must have

$$[g_n] = d - \frac{n}{2}(d - 2) . \tag{325}$$

In particular, for the φ^3 theory we have been working with, we have

$$[g_3] = \frac{1}{2}(6 - d) . \tag{326}$$

Thus we see that the coupling constant of φ^3 theory is dimensionless in $d = 6$ spacetime dimensions.

Theories with dimensionless couplings tend to be more interesting than theories with dimensionful couplings. This is because any nontrivial dependence of a scattering amplitude on a coupling must be expressed as a function of a dimensionless parameter. If the coupling is itself dimensionful, this parameter must be the ratio of the coupling to the appropriate power of either the particle mass m (if it isn't zero) or, in the high-energy regime $s \gg m^2$, the Mandelstam variable s . Thus the relevant parameter is $g s^{-[g]/2}$. If $[g]$ is negative [and it usually is: see eq. (325)], then $g s^{-[g]/2}$ blows up at high energies, and the perturbative expansion breaks down. This behavior is connected to the *nonrenormalizability* of theories with couplings with negative mass dimension, a subject we will take up in section 18. It turns out that, at best, such theories require an infinite number of input parameters to make sense. In the opposite case, $[g]$ positive, the theory becomes trivial at high energy, because $g s^{-[g]/2}$ goes rapidly to zero.

Thus the case of $[g] = 0$ is just right: scattering amplitudes can have a nontrivial dependence on g at all energies.

Therefore, from here on, we will be primarily interested in φ^3 theory in $d = 6$ spacetime dimensions, where $[g_3] = 0$.

14: Loop Corrections to the Propagator

Prerequisite: 10, 12, 13

In section 10, we wrote the exact propagator as

$$\frac{1}{i}\Delta(x_1-x_2) \equiv \langle 0 | T \varphi(x_1) \varphi(x_2) | 0 \rangle = \delta_1 \delta_2 iW(J) \Big|_{J=0}, \quad (327)$$

where $iW(J)$ is the sum of connected diagrams, and δ_i acts to remove a source from a diagram and label the corresponding propagator endpoint x_i . In φ^3 theory, the $O(g^2)$ corrections to $\frac{1}{i}\Delta(x_1-x_2)$ come from the diagrams of fig. (19). To compute them, it is simplest to work directly in momentum space, following the Feynman rules of section 10. An appropriate assignment of momenta to the lines is shown in fig. (19); we then have

$$\frac{1}{i}\tilde{\Delta}(k^2) = \frac{1}{i}\tilde{\Delta}(k^2) + \frac{1}{i}\tilde{\Delta}(k^2) [i\Pi(k^2)] \frac{1}{i}\tilde{\Delta}(k^2) + O(g^4), \quad (328)$$

where

$$\tilde{\Delta}(k^2) = \frac{1}{k^2 + m^2 - i\epsilon} \quad (329)$$

is the free-field propagator, and

$$\begin{aligned} i\Pi(k^2) &= \frac{1}{2}(ig)^2 \left(\frac{1}{i}\right)^2 \int \frac{d^d\ell}{(2\pi)^d} \tilde{\Delta}((\ell+k)^2) \tilde{\Delta}(\ell^2) \\ &\quad - i(Ak^2 + Bm^2) + O(g^4). \end{aligned} \quad (330)$$

Here we have written the integral appropriate for d spacetime dimensions; for now we will leave d arbitrary, but later we will want to focus on $d = 6$, where the coupling g is dimensionless. The factor of one-half is due to the symmetry factor associated with exchanging the top and bottom semicircular propagators. Also, we have written the vertex factor as ig rather than $iZ_g g$

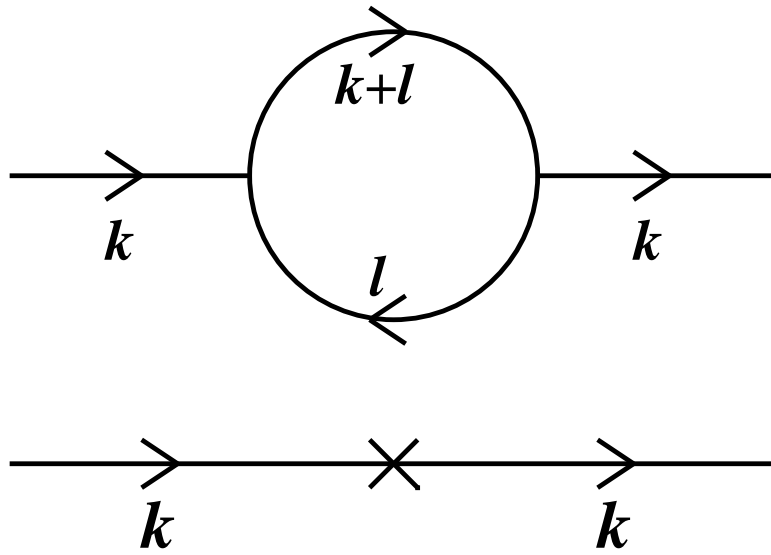

Figure 19: The $O(g^2)$ corrections to the propagator.

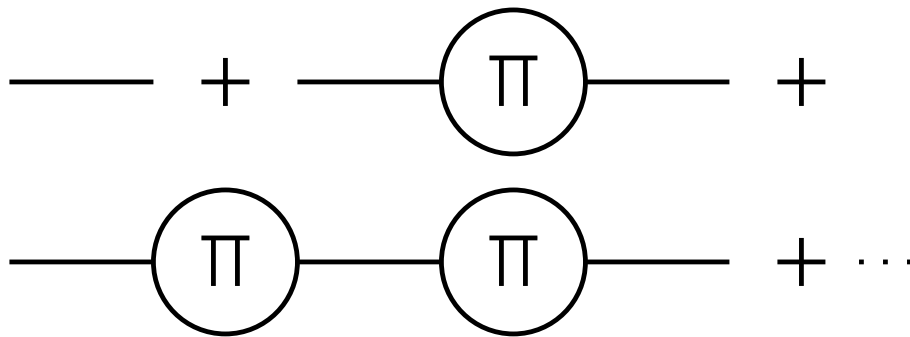

Figure 20: The infinite series of insertions of $\Pi(k^2)$.

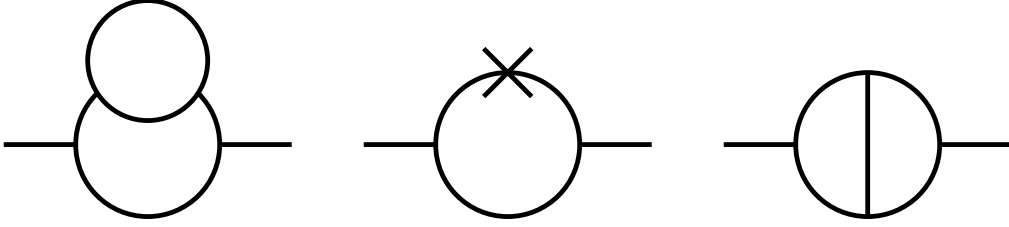

Figure 21: The $O(g^4)$ contributions to $\Pi(k^2)$.

because we expect $Z_g = 1 + O(g^2)$, and so the $Z_g - 1$ contribution can be lumped into the $O(g^4)$ term. In the second term, $A = Z_\varphi - 1$ and $B = Z_m - 1$ are both expected to be $O(g^2)$.

Before evaluating $\Pi(k^2)$, let us consider the infinite series of diagrams that result from further insertions of $\Pi(k^2)$, as shown in fig. (20). We have

$$\begin{aligned} \frac{1}{i}\tilde{\Delta}(k^2) &= \frac{1}{i}\tilde{\Delta}(k^2) + \frac{1}{i}\tilde{\Delta}(k^2)[i\Pi(k^2)]\frac{1}{i}\tilde{\Delta}(k^2) \\ &\quad + \frac{1}{i}\tilde{\Delta}(k^2)[i\Pi(k^2)]\frac{1}{i}\tilde{\Delta}(k^2)[i\Pi(k^2)]\frac{1}{i}\tilde{\Delta}(k^2) \\ &\quad + \dots \end{aligned} \quad (331)$$

This sum will include *all* the diagrams that contribute to $\tilde{\Delta}(k^2)$ if we define $i\Pi(k^2)$ to be given by the sum of all diagrams that are *one-particle irreducible*, or 1PI for short. A diagram is 1PI if it is still simply connected after any one line is cut. The $O(g^4)$ contributions to $i\Pi(k^2)$ are shown in fig. (21). In writing down the value of one of these diagrams, we omit the two external propagators.

The nice thing about eq. (331) is that it represents a geometric series that can be summed up to give

$$\tilde{\Delta}(k^2) = \frac{1}{k^2 + m^2 - i\epsilon - \Pi(k^2)}. \quad (332)$$

$\Pi(k^2)$ is called the *self-energy* of the particle.

In section 12, we learned that the exact propagator has a pole at $k^2 = -m^2$ with residue one. This is consistent with eq. (332) if and only if

$$\Pi(-m^2) = 0, \quad (333)$$

$$\Pi'(-m^2) = 0, \quad (334)$$

where the prime denotes a derivative with respect to k^2 . We will use eqs. (333) and (334) to fix the values of A and B .

Next we turn to the evaluation of the $O(g^2)$ contribution to $i\Pi(k^2)$ in eq. (330). We have the immediate problem that the integral on the right-hand side clearly diverges at large ℓ for $d \geq 4$. We faced a similar situation in section 9 when we evaluated the lowest-order tadpole diagram. There we modified $\tilde{\Delta}(\ell^2)$ by changing its behavior at large ℓ^2 . Here, for now, we will simply restrict our attention to $d < 4$, where the integral in eq. (330) is finite. Later we will see what we can say about larger values of d .

We will evaluate the integral in eq. (330) with a series of tricks. We first use *Feynman's formula* to combine denominators,

$$\frac{1}{a_1 \dots a_n} = \int dF_n (x_1 a_1 + \dots + x_n a_n)^{-n}, \quad (335)$$

where the integration measure over the *Feynman parameters* x_i is

$$\int dF_n = (n-1)! \int_0^1 dx_1 \dots dx_n \delta(x_1 + \dots + x_n - 1). \quad (336)$$

This measure is normalized so that

$$\int dF_n 1 = 1. \quad (337)$$

Eq. (335) can be proven by direct evaluation for $n = 2$, and by induction for $n > 2$.

In the case at hand, we have

$$\begin{aligned} \tilde{\Delta}((k+\ell)^2)\tilde{\Delta}(\ell^2) &= \frac{1}{(\ell^2 + m^2)((\ell + k)^2 + m^2)} \\ &= \int_0^1 dx \left[x((\ell + k)^2 + m^2) + (1-x)(\ell^2 + m^2) \right]^{-2} \\ &= \int_0^1 dx \left[\ell^2 + 2x\ell \cdot k + xk^2 + m^2 \right]^{-2} \\ &= \int_0^1 dx \left[(\ell + xk)^2 + x(1-x)k^2 + m^2 \right]^{-2} \\ &= \int_0^1 dx \left[q^2 + D \right]^{-2}, \end{aligned} \quad (338)$$

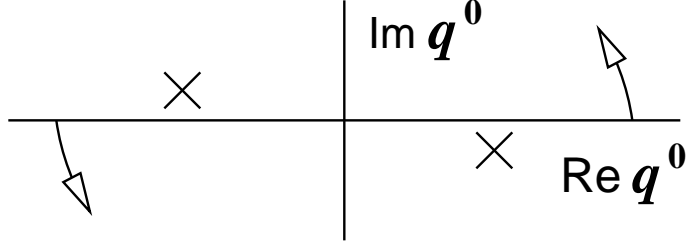

Figure 22: The q^0 integration contour along the real axis can be rotated to the imaginary axis without passing through the poles at $q^0 = -\omega + i\epsilon$ and $q^0 = +\omega - i\epsilon$.

where we have suppressed the $i\epsilon$'s for notational convenience; they can be restored via the replacement $m^2 \rightarrow m^2 - i\epsilon$. In the last line we have defined $q \equiv \ell + xk$ and

$$D \equiv x(1-x)k^2 + m^2 . \quad (339)$$

We then change the integration variable in eq. (330) from ℓ to q ; the jacobian is trivial, and we have $d^d\ell = d^dq$.

Next, think of the integral over q^0 from $-\infty$ to $+\infty$ as a contour integral in the complex q^0 plane. If the integrand vanishes fast enough as $|q^0| \rightarrow \infty$, we can rotate this contour clockwise by 90° , as shown in fig. (22), so that it runs from $-i\infty$ to $+i\infty$. In making this *Wick rotation*, the contour does not pass over any poles. (The $i\epsilon$'s are needed to make this statement unambiguous.) Thus the value of the integral is unchanged. It is now convenient to define a euclidean d -dimensional vector \bar{q} via $q^0 = i\bar{q}_d$ and $q_j = \bar{q}_j$; then $q^2 = \bar{q}^2$, where

$$\bar{q}^2 = \bar{q}_1^2 + \dots + \bar{q}_d^2 . \quad (340)$$

Also, $d^dq = i d^d\bar{q}$. Therefore, in general,

$$\int d^dq f(q^2 - i\epsilon) = i \int d^d\bar{q} f(\bar{q}^2) \quad (341)$$

as long as $f(\bar{q}^2) \rightarrow 0$ faster than $1/\bar{q}^d$ as $\bar{q} \rightarrow \infty$.

Now we can write

$$\Pi(k^2) = \frac{1}{2}g^2 I(k^2) - Ak^2 - Bm^2 + O(g^4) , \quad (342)$$

where

$$I(k^2) \equiv \int_0^1 dx \int \frac{d^d \bar{q}}{(2\pi)^d} \frac{1}{(\bar{q}^2 + D)^2} . \quad (343)$$

It is now straightforward to evaluate the d -dimensional integral over \bar{q} in spherical coordinates.

Before we perform this calculation, however, let us introduce another trick, one that can simplify the task of fixing A and B through the imposition of eqs. (333) and (334). Here is the trick: differentiate $\Pi(k^2)$ twice with respect to k^2 to get

$$\Pi''(k^2) = \frac{1}{2} g^2 I''(k^2) + O(g^4) , \quad (344)$$

where, from eqs. (343) and (339),

$$I''(k^2) = \int_0^1 dx \, 6x^2(1-x)^2 \int \frac{d^d \bar{q}}{(2\pi)^d} \frac{1}{(\bar{q}^2 + D)^4} . \quad (345)$$

Then, after we evaluate these integrals, we can get $\Pi(k^2)$ by integrating with respect to k^2 , subject to the boundary conditions of eqs. (333) and (334). In this way we can construct $\Pi(k^2)$ without ever explicitly computing A and B .

Notice that this trick does something else for us as well. The integral over \bar{q} in eq. (345) is finite for any $d < 8$, whereas the original integral in eq. (343) is finite only for $d < 4$. This expanded range of d now includes the value of greatest interest, $d = 6$.

How did this happen? We can gain some insight by making a Taylor expansion of $\Pi(k^2)$ about $k^2 = -m^2$:

$$\begin{aligned} \Pi(k^2) &= \left[\frac{1}{2} g^2 I(-m^2) + (A - B) m^2 \right] \\ &\quad + \left[\frac{1}{2} g^2 I'(-m^2) + A \right] (k^2 + m^2) \\ &\quad + \frac{1}{2!} \left[\frac{1}{2} g^2 I''(-m^2) \right] (k^2 + m^2)^2 + \dots \\ &\quad + O(g^4) . \end{aligned} \quad (346)$$

From eqs. (343) and (339), it is straightforward to see that $I(-m^2)$ is divergent for $d \geq 4$, $I'(-m^2)$ is divergent for $d \geq 6$, and, in general, $I^{(n)}(-m^2)$ is divergent for $d \geq 4 + 2n$. We can use the $O(g^2)$ terms in A and B to cancel off the $\frac{1}{2} g^2 I(-m^2)$ and $\frac{1}{2} g^2 I'(-m^2)$ terms in $\Pi(k^2)$, whether or not they are

divergent. But if we are to end up with a finite $\Pi(k^2)$, all of the remaining terms must be finite, since we have no more free parameters left to adjust. This is the case for $d < 8$.

Of course, for $4 \leq d < 8$, the values of A and B (and hence the lagrangian coefficients $Z = 1 + A$ and $Z_m = 1 + B$) are formally infinite, and this may be disturbing. However, these coefficients are not directly measurable, and so need not obey our preconceptions about their magnitudes. Also, it is important to remember that A and B each includes a factor of g^2 ; this means that we can expand in powers of A and B as part of our general expansion in powers of g . When we compute $\Pi(k^2)$ (which enters into observable cross sections), all the formally infinite numbers cancel in a well-defined way, provided $d < 8$.

For $d \geq 8$, this procedure breaks down, and we do not obtain a finite expression for $\Pi(k^2)$. In this case, we say that the theory is *nonrenormalizable*. We will discuss the criteria for renormalizability of a theory in detail in section 18. It turns out that φ^3 theory is renormalizable for $d \leq 6$. (The problem with $6 < d < 8$ arises from higher-order corrections, as we will see in section 18.)

Now let us return to the calculation of $\Pi(k^2)$. Rather than using the trick of first computing $\Pi''(k^2)$, we will instead evaluate $\Pi(k^2)$ directly from eq. (343) as a function of d for $d < 4$. Then we will analytically continue the result to arbitrary d . This procedure is known as *dimensional regularization*. Then we will fix A and B by imposing eqs. (333) and (334), and finally take the limit $d \rightarrow 6$.

We could just as well use the method of section 9. Making the replacement

$$\tilde{\Delta}(p^2) \rightarrow \frac{1}{p^2 + m^2 - i\epsilon} \frac{\Lambda^2}{p^2 + \Lambda^2 - i\epsilon}, \quad (347)$$

where Λ is a parameter with dimensions of mass called the *ultraviolet cutoff*, renders the $O(g^2)$ term in $\Pi(k^2)$ finite for $d < 8$; This procedure is known as *Pauli-Villars regularization*. We then evaluate $\Pi(k^2)$ as a function of Λ , fix A and B by imposing eqs. (333) and (334), and take the $\Lambda \rightarrow \infty$ limit. Calculations with Pauli-Villars regularization are generally much more cumbersome than they are with dimensional regularization. However, the final result for $\Pi(k^2)$ is the same. Eq. (346) demonstrates that *any* regularization

scheme will give the same result for $d < 8$, at least as long as it preserves the Lorentz invariance of the integrals.

We therefore turn to the evaluation of $I(k^2)$, eq. (343). The angular part of the integral over \bar{q} yields the area Ω_d of the unit sphere in d dimensions, which is $\Omega_d = 2\pi^{d/2}/\Gamma(\frac{1}{2}d)$. (This is most easily verified by computing the gaussian integral $\int d^d\bar{q} e^{-\bar{q}^2}$ in both cartesian and spherical coordinates.) Here $\Gamma(x)$ is the Euler gamma function; for a nonnegative integer n and small x ,

$$\Gamma(n+1) = n! , \quad (348)$$

$$\Gamma(n+\frac{1}{2}) = \frac{(2n)!}{n!2^n} \sqrt{\pi} , \quad (349)$$

$$\Gamma(-n+x) = \frac{(-1)^n}{n!} \left[\frac{1}{x} - \gamma + \sum_{k=1}^n k^{-1} + O(x) \right] , \quad (350)$$

where $\gamma = 0.5772\dots$ is the Euler-Mascheroni constant.

The radial part of the \bar{q} integral can also be evaluated in terms of gamma functions. The overall result (generalized slightly for later use) is

$$\int \frac{d^d\bar{q}}{(2\pi)^d} \frac{(\bar{q}^2)^a}{(\bar{q}^2 + D)^b} = \frac{\Gamma(b-a-\frac{1}{2}d)\Gamma(a+\frac{1}{2}d)}{(4\pi)^{d/2}\Gamma(b)\Gamma(\frac{1}{2}d)} D^{-(b-a-d/2)} . \quad (351)$$

In the case of interest, eq. (343), we have $a = 0$ and $b = 2$.

There is one more complication to deal with. Recall that we want to focus on $d = 6$ because in that case g is dimensionless. However, for general d , g has mass dimension $\varepsilon/2$, where

$$\varepsilon \equiv 6 - d . \quad (352)$$

To account for this, we introduce a new parameter $\tilde{\mu}$ with dimensions of mass, and make the replacement

$$g \rightarrow g\tilde{\mu}^{\varepsilon/2} . \quad (353)$$

In this way g remains dimensionless for all ε . Of course, $\tilde{\mu}$ is not an actual parameter of the $d = 6$ theory. Therefore, nothing measurable (like a cross section) can depend on it.

This seemingly innocuous statement is actually quite powerful, and will eventually serve as the foundation of the renormalization group.

We now return to eq. (343), use eq. (350), and set $d = 6 - \varepsilon$; we get

$$I(k^2) = \frac{\Gamma(-1+\frac{\varepsilon}{2})}{(4\pi)^3} \int_0^1 dx D \left(\frac{4\pi}{D} \right)^{\varepsilon/2}. \quad (354)$$

Hence, with the substitution of eq. (353), and defining

$$\alpha \equiv \frac{g^2}{(4\pi)^3} \quad (355)$$

for notational convenience, we have

$$\begin{aligned} \Pi(k^2) &= \frac{1}{2}\alpha \Gamma(-1+\frac{\varepsilon}{2}) \int_0^1 dx D \left(\frac{4\pi\tilde{\mu}^2}{D} \right)^{\varepsilon/2} \\ &\quad - Ak^2 - Bm^2 + O(\alpha^2). \end{aligned} \quad (356)$$

Now we can take the $\varepsilon \rightarrow 0$ limit, using eq. (350) and

$$A^{\varepsilon/2} = 1 + \frac{\varepsilon}{2} \ln A + O(\varepsilon^2). \quad (357)$$

The result is

$$\begin{aligned} \Pi(k^2) &= -\frac{1}{2}\alpha \left[\left(\frac{2}{\varepsilon} + 1 \right) \left(\frac{1}{6}k^2 + m^2 \right) + \int_0^1 dx D \ln \left(\frac{4\pi\tilde{\mu}^2}{e^\gamma D} \right) \right] \\ &\quad - Ak^2 - Bm^2 + O(\alpha^2). \end{aligned} \quad (358)$$

Here we have used $\int_0^1 dx D = \frac{1}{6}k^2 + m^2$. It is now convenient to define

$$\mu \equiv \sqrt{4\pi} e^{-\gamma/2} \tilde{\mu}, \quad (359)$$

and rearrange things to get

$$\begin{aligned} \Pi(k^2) &= \frac{1}{2}\alpha \int_0^1 dx D \ln(D/m^2) \\ &\quad - \left\{ \frac{1}{6}\alpha \left[\frac{1}{\varepsilon} + \ln(\mu/m) + \frac{1}{2} \right] + A \right\} k^2 \\ &\quad - \left\{ \alpha \left[\frac{1}{\varepsilon} + \ln(\mu/m) + \frac{1}{2} \right] + B \right\} m^2 + O(\alpha^2). \end{aligned} \quad (360)$$

If we take A and B to have the form

$$A = -\frac{1}{6}\alpha \left[\frac{1}{\varepsilon} + \ln(\mu/m) + \frac{1}{2} + \kappa_A \right] + O(\alpha^2), \quad (361)$$

$$B = -\alpha \left[\frac{1}{\varepsilon} + \ln(\mu/m) + \frac{1}{2} + \kappa_B \right] + O(\alpha^2), \quad (362)$$

where κ_A and κ_B are purely numerical constants, then we get

$$\Pi(k^2) = \frac{1}{2}\alpha \int_0^1 dx D \ln(D/m^2) + \alpha \left(\frac{1}{6}\kappa_A k^2 + \kappa_B m^2 \right) + O(\alpha^2). \quad (363)$$

Thus this choice of A and B renders $\Pi(k^2)$ finite and independent of μ , as required.

To fix κ_A and κ_B , we must still impose the conditions $\Pi(-m^2) = 0$ and $\Pi'(-m^2) = 0$. The easiest way to do this is to first note that, schematically,

$$\Pi(k^2) = \frac{1}{2}\alpha \int_0^1 dx D \ln D + \text{linear in } k^2 \text{ and } m^2 + O(\alpha^2). \quad (364)$$

We can then impose $\Pi(-m^2) = 0$ via

$$\Pi(k^2) = \frac{1}{2}\alpha \int_0^1 dx D \ln(D/D_0) + \text{linear in } (k^2 + m^2) + O(\alpha^2). \quad (365)$$

where

$$D_0 \equiv D \Big|_{k^2=-m^2} = [1-x(1-x)]m^2. \quad (366)$$

Now it is straightforward to differentiate eq. (365) with respect to k^2 , and find that $\Pi'(-m^2)$ vanishes for

$$\Pi(k^2) = \frac{1}{2}\alpha \int_0^1 dx D \ln(D/D_0) - \frac{1}{12}\alpha(k^2 + m^2) + O(\alpha^2). \quad (367)$$

The integral over x can be done in closed form; the result is

$$\Pi(k^2) = \frac{1}{12}\alpha \left[c_1 k^2 + c_2 m^2 + 2k^2 f(r) \right] + O(\alpha^2), \quad (368)$$

where $c_1 = 3 - \pi\sqrt{3}$, $c_2 = 3 - 2\pi\sqrt{3}$, and

$$f(r) = r^{-3/2} \tanh^{-1}(r^{1/2}), \quad (369)$$

$$r = k^2/(k^2 + 4m^2). \quad (370)$$

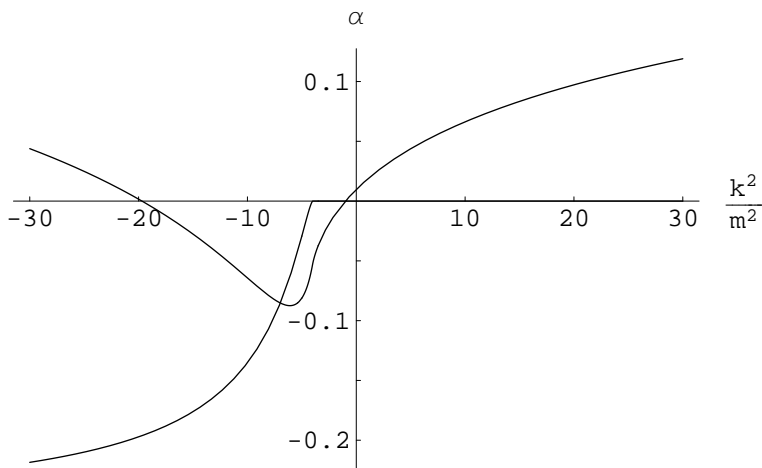

Figure 23: The real and imaginary parts of $\Pi(k^2)$ in units of α .

There is a square-root branch point at $k^2 = -4m^2$, and $\Pi(k^2)$ acquires an imaginary part for $k^2 < -4m^2$; we will discuss this further in the next section.

We can write the exact propagator as

$$\tilde{\Delta}(k^2) = \left(\frac{1}{1 - \Pi(k^2)/(k^2 + m^2)} \right) \frac{1}{k^2 + m^2 - i\epsilon}. \quad (371)$$

In fig. (23), we plot the real and imaginary parts of $\Pi(k^2)/(k^2 + m^2)$ in units of α . We see that its values are quite modest for the plotted range. For much larger values of $|k^2|$, we have

$$\frac{\Pi(k^2)}{k^2 + m^2} \simeq \frac{1}{12}\alpha \left[\ln(k^2/m^2) + c_1 \right] + O(\alpha^2). \quad (372)$$

If we had kept track of the $i\epsilon$'s, k^2 would be $k^2 - i\epsilon$; when k^2 is negative, we have $\ln(k^2 - i\epsilon) = \ln|k^2| - i\pi$. The imaginary part of $\Pi(k^2)/(k^2 + m^2)$ therefore approaches the asymptotic value of $-\frac{1}{12}\pi\alpha + O(\alpha^2)$ when k^2 is large and negative. The real part of $\Pi(k^2)/(k^2 + m^2)$, however, continues to increase logarithmically with $|k^2|$ when $|k^2|$ is large. We will begin to address the meaning of this in section 25.

Problems

- 14.1) Compute the numerical values of κ_A and κ_B .
- 14.2) Compute the $O(\lambda)$ correction to the propagator in φ^4 theory (see problem 9.2). What are the $O(\lambda)$ terms in A and B ?
- 14.3) Repeat problem 14.2 for the theory of problem 9.3.

15: The One-Loop Correction in Lehmann-Källén Form

Prerequisite: 14

In section 12, we found that the exact propagator could be written in Lehmann-Källén form as

$$\tilde{\Delta}(k^2) = \frac{1}{k^2 + m^2 - i\epsilon} + \int_{4m^2}^{\infty} ds \rho(s) \frac{1}{k^2 + s - i\epsilon}, \quad (373)$$

where the *spectral density* $\rho(s)$ is real and nonnegative. In section 14, on the other hand, we found that the exact propagator could be written as

$$\tilde{\Delta}(k^2) = \frac{1}{k^2 + m^2 - i\epsilon - \Pi(k^2)}, \quad (374)$$

and that, to $O(g^2)$ in φ^3 theory in six dimensions,

$$\Pi(k^2) = \frac{1}{2}\alpha \int_0^1 dx D \ln(D/D_0) - \frac{1}{12}\alpha(k^2 + m^2) + O(\alpha^2), \quad (375)$$

where

$$\alpha \equiv g^2/(4\pi)^3, \quad (376)$$

$$D = x(1-x)k^2 + m^2 - i\epsilon, \quad (377)$$

$$D_0 = [1-x(1-x)]m^2. \quad (378)$$

In this section, we will attempt to reconcile eqs. (374) and (375) with eq. (373).

Let us begin by considering the imaginary part of the propagator. We will always take k^2 and m^2 to be real, and explicitly include the appropriate factors of $i\epsilon$ whenever they are needed.

We can use eq. (373) and the identity

$$\begin{aligned} \frac{1}{x - i\epsilon} &= \frac{x}{x^2 + \epsilon^2} + \frac{i\epsilon}{x^2 + \epsilon^2} \\ &= P \frac{1}{x} + i\pi\delta(x), \end{aligned} \quad (379)$$

where P means the principal part, to write

$$\begin{aligned}\text{Im } \tilde{\Delta}(k^2) &= \pi\delta(k^2 + m^2) + \int_{4m^2}^{\infty} ds \rho(s) \pi\delta(k^2 + s) . \\ &= \pi\delta(k^2 + m^2) + \pi\rho(-k^2) ,\end{aligned}\tag{380}$$

where $\rho(s) \equiv 0$ for $s < 4m^2$. Thus we have

$$\pi\rho(s) = \text{Im } \tilde{\Delta}(-s) \quad \text{for } s \geq 4m^2 .\tag{381}$$

Let us now suppose that $\text{Im } \Pi(k^2) = 0$ for some range of k^2 . (In section 14, we saw that the $O(\alpha)$ contribution to $\Pi(k^2)$ is purely real for $k^2 > -4m^2$.) Then, from eqs. (374) and (379), we get

$$\text{Im } \tilde{\Delta}(k^2) = \pi\delta(k^2 + m^2 - \Pi(k^2)) \quad \text{for } \text{Im } \Pi(k^2) = 0 .\tag{382}$$

From $\Pi(-m^2) = 0$, we know that the argument of the delta function vanishes at $k^2 = -m^2$, and from $\Pi'(-m^2) = 0$, we know that the derivative of this argument with respect to k^2 equals one at $k^2 = -m^2$. Therefore

$$\text{Im } \tilde{\Delta}(k^2) = \pi\delta(k^2 + m^2) \quad \text{for } \text{Im } \Pi(k^2) = 0 .\tag{383}$$

Comparing this with eq. (380), we see that $\rho(-k^2) = 0$ if $\text{Im } \Pi(k^2) = 0$

Now suppose $\text{Im } \Pi(k^2)$ is *not* zero for some range of k^2 . (In section 14, we saw that the $O(\alpha)$ contribution to $\Pi(k^2)$ has a nonzero imaginary part for $k^2 < -4m^2$.) Then we can ignore the $i\epsilon$ in eq. (374), and

$$\text{Im } \tilde{\Delta}(k^2) = \frac{\text{Im } \Pi(k^2)}{(k^2 + m^2 + \text{Re } \Pi(k^2))^2 + (\text{Im } \Pi(k^2))^2} \quad \text{for } \text{Im } \Pi(k^2) \neq 0 .\tag{384}$$

Comparing this with eq. (380) we see that

$$\pi\rho(s) = \frac{\text{Im } \Pi(-s)}{(-s + m^2 + \text{Re } \Pi(-s))^2 + (\text{Im } \Pi(-s))^2} .\tag{385}$$

Since we know $\rho(s) = 0$ for $s < 4m^2$, this tells us that we must also have $\text{Im } \Pi(-s) = 0$ for $s < 4m^2$, or equivalently $\text{Im } \Pi(k^2) = 0$ for $k^2 > -4m^2$. This is just what we found for the $O(\alpha)$ contribution to $\Pi(k^2)$ in section 14.

We can also see this directly from eq. (375), without doing the integral over x . The integrand in this formula is real as long as the argument of the logarithm is real and positive. From eq. (377), we see that D is real and positive if and only if $x(1-x)k^2 > -m^2$. The maximum value of $x(1-x)$ is $1/4$, and so the argument of the logarithm is real and positive for the whole integration range $0 \leq x \leq 1$ if and only if $k^2 > -4m^2$. In this regime, $\text{Im} \Pi(k^2) = 0$. On the other hand, for $k^2 < -4m^2$, the argument of the logarithm becomes negative for some of the integration range, and so $\text{Im} \Pi(k^2) \neq 0$ for $k^2 < -4m^2$. This is exactly what we need to reconcile eqs. (374) and (375) with eq. (373).

16: Loop Corrections to the Vertex

Prerequisite: 14

Consider the $O(g^3)$ diagram of fig. (24), which corrects the φ^3 vertex. In this section we will evaluate this diagram.

We can define an exact three-point vertex function $i\mathbf{V}_3(k_1, k_2, k_3)$ as the sum of one-particle irreducible diagrams with three external lines carrying momenta k_1 , k_2 , and k_3 , all incoming, with $k_1 + k_2 + k_3 = 0$ by momentum conservation. (In adopting this convention, we allow k_i^0 to have either sign; if k_i is the momentum of an external particle, then the sign of k_i^0 is positive if the particle is incoming, and negative if it is outgoing.) The original vertex $iZ_g g$ is the first term in this sum, and the diagram of fig. (24) is the second. Thus we have

$$i\mathbf{V}_3(k_1, k_2, k_3) = iZ_g g + (ig)^3 \left(\frac{1}{i}\right)^3 \int \frac{d^d \ell}{(2\pi)^d} \tilde{\Delta}((\ell - k_1)^2) \tilde{\Delta}((\ell + k_2)^2) \tilde{\Delta}(\ell^2) + O(g^5). \quad (386)$$

In the second term, we have set $Z_g = 1 + O(g^2)$. We proceed immediately to the evaluation of this integral, using the series of tricks from section 14.

First we use Feynman's formula to write

$$\begin{aligned} & \tilde{\Delta}((\ell - k_1)^2) \tilde{\Delta}((\ell + k_2)^2) \tilde{\Delta}(\ell^2) \\ &= \int dF_3 \left[x_1(\ell - k_1)^2 + x_2(\ell + k_2)^2 + x_3 \ell^2 + m^2 \right]^{-3}, \end{aligned} \quad (387)$$

where

$$\int dF_3 = 2 \int_0^1 dx_1 dx_2 dx_3 \delta(x_1 + x_2 + x_3 - 1). \quad (388)$$

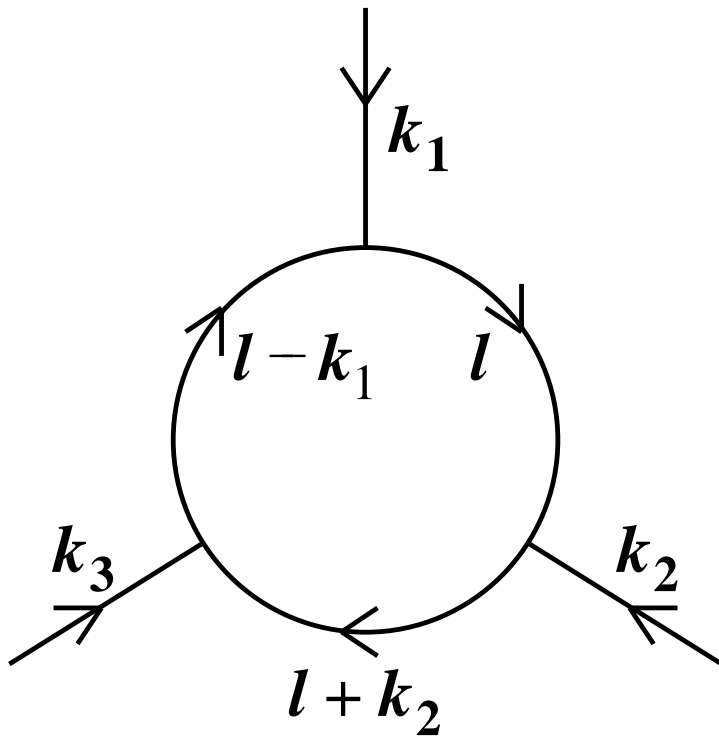

Figure 24: The $O(g^3)$ correction to the vertex $iV_3(k_1, k_2, k_3)$.

We manipulate the right-hand side of eq. (387) to get

$$\begin{aligned}
& \tilde{\Delta}((\ell-k_1)^2)\tilde{\Delta}((\ell+k_2)^2)\tilde{\Delta}(\ell^2) \\
&= \int dF_3 \left[\ell^2 - 2\ell \cdot (x_1 k_1 - x_2 k_2) + x_1 k_1^2 + x_2 k_2^2 + m^2 \right]^{-3} \\
&= \int dF_3 \left[(\ell - x_1 k_1 + x_2 k_2)^2 + x_1(1-x_1)k_1^2 + x_2(1-x_2)k_2^2 \right. \\
&\quad \left. + 2x_1 x_2 k_1 \cdot k_2 + m^2 \right]^{-3} \\
&= \int dF_3 \left[q^2 + D \right]^{-3} .
\end{aligned} \tag{389}$$

In the last line, we have defined $q \equiv \ell - x_1 k_1 + x_2 k_2$, and

$$\begin{aligned}
D &\equiv x_1(1-x_1)k_1^2 + x_2(1-x_2)k_2^2 + 2x_1 x_2 k_1 \cdot k_2 + m^2 \\
&= x_2 x_3 k_1^2 + x_3 x_1 k_2^2 + x_1 x_2 k_3^2 + m^2 .
\end{aligned} \tag{390}$$

To get the more symmetric form of D , we used $k_3^2 = (k_1+k_2)^2$, $x_1+x_2+x_3 = 1$, and swapped $x_1 \leftrightarrow x_2$.

After making a Wick rotation of the q^0 contour, we have

$$\mathbf{V}_3(k_1, k_2, k_3)/g = Z_g + g^2 \int dF_3 \int \frac{d^d \bar{q}}{(2\pi)^d} \frac{1}{(\bar{q}^2 + D)^3} + O(g^4) , \tag{391}$$

where \bar{q} is a euclidean vector. This integral diverges for $d \geq 6$. We therefore evaluate it for $d < 6$, using the general formula from section 14; the result is

$$\int \frac{d^d \bar{q}}{(2\pi)^d} \frac{1}{(\bar{q}^2 + D)^3} = \frac{\Gamma(3-\frac{1}{2}d)}{2(4\pi)^{d/2}} D^{-(3-d/2)} . \tag{392}$$

Now we set $d = 6 - \varepsilon$. To keep g dimensionless, we make the replacement $g \rightarrow g\tilde{\mu}^{\varepsilon/2}$. Then we have

$$\mathbf{V}_3(k_1, k_2, k_3)/g = Z_g + \frac{1}{2}\alpha \Gamma\left(\frac{\varepsilon}{2}\right) \int dF_3 \left(\frac{4\pi\tilde{\mu}^2}{D} \right)^{\varepsilon/2} + O(\alpha^2) , \tag{393}$$

where $\alpha = g^2/(4\pi)^3$. Now we can take the $\varepsilon \rightarrow 0$ limit. The result is

$$\mathbf{V}_3(k_1, k_2, k_3)/g = Z_g + \frac{1}{2}\alpha \left[\frac{2}{\varepsilon} + \int dF_3 \ln \left(\frac{4\pi\tilde{\mu}^2}{e^\gamma D} \right) \right] + O(\alpha^2) , \tag{394}$$

where we have used $\int dF_3 = 1$. We now let $\mu^2 = 4\pi e^{-\gamma} \tilde{\mu}^2$, set

$$Z_g = 1 + C , \quad (395)$$

and rearrange to get

$$\begin{aligned} \mathbf{V}_3(k_1, k_2, k_3)/g &= 1 + \left\{ \alpha \left[\frac{1}{\varepsilon} + \ln(\mu/m) \right] + C \right\} \\ &\quad - \frac{1}{2} \alpha \int dF_3 \ln(D/m^2) \\ &\quad + O(\alpha^2) . \end{aligned} \quad (396)$$

If we take C to have the form

$$C = -\alpha \left[\frac{1}{\varepsilon} + \ln(\mu/m) + \kappa_C \right] + O(\alpha^2) , \quad (397)$$

where κ_C is a purely numerical constant, we get

$$\mathbf{V}_3(k_1, k_2, k_3)/g = 1 - \frac{1}{2} \alpha \int dF_3 \ln(D/m^2) - \kappa_C \alpha + O(\alpha^2) . \quad (398)$$

Thus this choice of C renders $\mathbf{V}_3(k_1, k_2, k_3)$ finite and independent of μ , as required.

We now need a condition, analogous to $\Pi(-m^2) = 0$ and $\Pi'(-m^2) = 0$, to fix the value of κ_C . These conditions on $\Pi(k^2)$ were mandated by known properties of the exact propagator, but there is nothing directly comparable for the vertex. Different choices of κ_C correspond to different definitions of the coupling g . This is because, in order to measure g , we would measure a cross section that depends on g ; these cross sections also depend on κ_C . Thus we can use any value for κ_C that we might fancy, as long as we all agree on that value when we compare our calculations with experimental measurements. It is then most convenient to simply set $\kappa_C = 0$. This corresponds to the condition

$$\mathbf{V}_3(0, 0, 0) = g . \quad (399)$$

This condition can then also be used to fix the higher-order (in g) terms in Z_g .

The integrals over the Feynman parameters in eq. (398) cannot be done in closed form, but it is easy to see that if (for example) $|k_1^2| \gg m^2$, then

$$\mathbf{V}_3(k_1, k_2, k_3)/g \simeq 1 - \frac{1}{2}\alpha \left[\ln(k_1^2/m^2) + O(1) \right] + O(\alpha^2). \quad (400)$$

Thus the magnitude of the one-loop correction to the vertex function increases logarithmically with $|k_i^2|$ when $|k_i^2| \gg m^2$. This is the same behavior that we found for $\Pi(k^2)/(k^2 + m^2)$ in section 14.

Problems

16.1) Compute the $O(\lambda^2)$ correction to \mathbf{V}_4 in φ^4 theory (see problem 9.2). Take $\mathbf{V}_4 = \lambda$ when all four external momenta are on shell, and $s = 4m^2$. What is the $O(\lambda)$ contribution to C ?

16.2) Repeat problem 16.1 for the theory of problem 9.3.

17: Other 1PI Vertices

Prerequisite: 16

In section 16, we defined the three-point vertex function $i\mathbf{V}_3(k_1, k_2, k_3)$ as the sum of all one-particle irreducible diagrams with three external lines, with the external propagators removed. We can extend this definition to the n -point vertex $i\mathbf{V}_n(k_1, \dots, k_n)$.

There are two key differences between $\mathbf{V}_{n>3}$ and \mathbf{V}_3 in φ^3 theory. The first is that there is no tree-level contribution to $\mathbf{V}_{n>3}$. The second is that the one-loop contribution to $\mathbf{V}_{n>3}$ is finite for $d < 2n$. In particular, the one-loop contribution to $\mathbf{V}_{n>3}$ is finite for $d = 6$.

Let us see how this works for the case $n = 4$. We treat all the external momenta as incoming, so that $k_1 + k_2 + k_3 + k_4 = 0$. One of the three contributing one-loop diagrams is shown in fig. (25); in this diagram, the k_3 vertex is opposite to the k_1 vertex. Two other inequivalent diagrams are then obtained by swapping $k_3 \leftrightarrow k_2$ and $k_3 \leftrightarrow k_4$. We then have

$$\begin{aligned} i\mathbf{V}_4 &= g^4 \int \frac{d^6\ell}{(2\pi)^6} \tilde{\Delta}((\ell-k_1)^2) \tilde{\Delta}((\ell+k_2)^2) \tilde{\Delta}((\ell+k_2+k_3)^2) \tilde{\Delta}(\ell^2) \\ &\quad + (k_3 \leftrightarrow k_2) + (k_3 \leftrightarrow k_4) \\ &\quad + O(g^6). \end{aligned} \tag{401}$$

Feynman's formula gives

$$\begin{aligned} &\tilde{\Delta}((\ell-k_1)^2) \tilde{\Delta}((\ell+k_2)^2) \tilde{\Delta}((\ell+k_2+k_3)^2) \tilde{\Delta}(\ell^2) \\ &= \int dF_4 \left[x_1(\ell-k_1)^2 + x_2(\ell+k_2)^2 + x_3(\ell+k_2+k_3)^2 + x_4\ell^2 + m^2 \right]^{-4} \\ &= \int dF_4 \left[q^2 + D_{1234} \right]^{-4}, \end{aligned} \tag{402}$$

where $q = \ell - x_1 k_1 + x_2 k_2 + x_3(k_2 + k_3)$ and, after making repeated use of $x_1 + x_2 + x_3 + x_4 = 1$ and $k_1 + k_2 + k_3 + k_4 = 0$,

$$D_{1234} = x_1 x_4 k_1^2 + x_2 x_4 k_2^2 + x_2 x_3 k_3^2 + x_1 x_3 k_4^2 + x_1 x_2 (k_1 + k_2)^2 + x_3 x_4 (k_2 + k_3)^2 + m^2 . \quad (403)$$

We see that the integral over q is finite for $d < 8$, and in particular for $d = 6$. After a Wick rotation of the q^0 contour and applying the general formula of section 14, we find

$$\int \frac{d^6 q}{(2\pi)^6} \frac{1}{(q^2 + D)^4} = \frac{i}{6(4\pi)^3 D} . \quad (404)$$

Thus we get

$$\mathbf{V}_4 = \frac{g^4}{6(4\pi)^3} \int dF_4 \left(\frac{1}{D_{1234}} + \frac{1}{D_{1324}} + \frac{1}{D_{1243}} \right) + O(g^6) . \quad (405)$$

This expression is finite and well-defined; the same is true for the one-loop contribution to \mathbf{V}_n for all $n > 3$.

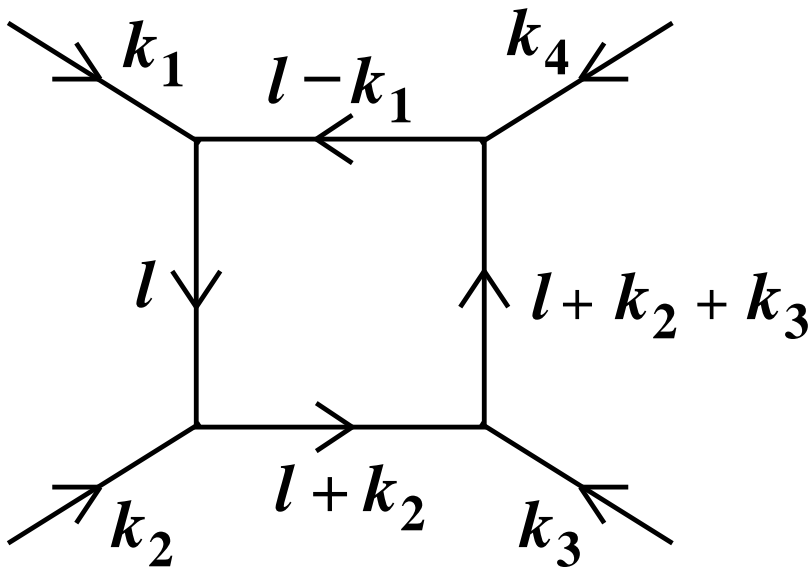

Figure 25: One of the three one-loop Feynman diagrams contributing to the four-point vertex $i\mathbf{V}_4(k_1, k_2, k_3, k_4)$; the other two are obtained by swapping $k_3 \leftrightarrow k_2$ and $k_3 \leftrightarrow k_4$.

18: Higher-Order Corrections and Renormalizability

Prerequisite: 17

In sections 14–17, we computed the one-loop diagrams with two, three, and four external lines for φ^3 theory in six dimensions. We found that the first two involved divergent momentum integrals, but that these divergences could be absorbed into the coefficients of terms in the lagrangian. If this is true for all higher-order (in g) contributions to the propagator and to the one-particle irreducible vertex functions (with $n \geq 3$ external lines), then we say that the theory is *renormalizable*. If this is not the case, and further divergences arise, it may be possible to absorb them by adding some new terms to the lagrangian. If a finite number of such new terms is required, the theory is still said to be renormalizable. However, if an infinite number of new terms is required, then the theory is said to be *nonrenormalizable*.

In this section we wish to consider the circumstances under which a theory is renormalizable. As an example, we will analyze a scalar field theory in d spacetime dimensions of the form

$$\mathcal{L} = -\frac{1}{2}Z_\varphi\partial^\mu\varphi\partial_\mu\varphi - \frac{1}{2}Z_m m^2\varphi^2 - \sum_{n=3}^{\infty} \frac{1}{n!}Z_n g_n\varphi^n. \quad (406)$$

Consider a Feynman diagram with E external lines, I internal lines, L closed loops, and V_n vertices that connect n lines. (Here V_n is just a number, not to be confused with the vertex function \mathbf{V}_n .) Do the momentum integrals associated with this diagram diverge?

We begin by noting that each closed loop gives a factor of $d^d\ell_i$, and each internal propagator gives a factor of $1/(p^2 + m^2)$, where p is some linear combination of external momenta k_i and loop momenta ℓ_i . The diagram would then appear to have an ultraviolet divergence at large ℓ_i if there are

more ℓ 's in the numerator than there are in the denominator. The number of ℓ 's in the numerator minus the number of ℓ 's in the denominator is the diagram's *superficial degree of divergence*

$$D \equiv dL - 2I , \quad (407)$$

and the diagram appears to be divergent if

$$D \geq 0 . \quad (408)$$

Next we derive a more useful formula for D . The diagram has E external lines, so another contributing diagram is the tree diagram where all the lines are joined by a single vertex, with vertex factor $-iZ_E g_E$; this is, in fact, the value of this entire diagram, which then has mass dimension $[g_E]$. (The Z 's are all dimensionless, by definition.) Therefore, the original diagram also has mass dimension $[g_E]$, since both are contributions to the same scattering amplitude:

$$[\text{diagram}] = [g_E] . \quad (409)$$

On the other hand, the mass dimension of any diagram is given by the sum of the mass dimensions of its components, namely

$$[\text{diagram}] = dL - 2I + \sum_{n=3}^{\infty} V_n [g_n] . \quad (410)$$

From eqs. (407), (409), and (410), we get

$$D = [g_E] - \sum_{n=3}^{\infty} V_n [g_n] . \quad (411)$$

This is the formula we need.

From eq. (411), it is immediately clear that if any $[g_n] < 0$, we expect uncontrollable divergences, since D increases with every added vertex of this type. Therefore, *a theory with any $[g_n] < 0$ is nonrenormalizable.*

According to our results in section 13, the coupling constants have mass dimension

$$[g_n] = d - \frac{n}{2}(d - 2) , \quad (412)$$

and so we have

$$[g_n] < 0 \quad \text{if} \quad n > \frac{2d}{d-2}. \quad (413)$$

Thus we are limited to powers no higher than φ^4 in four dimensions, and no higher than φ^3 in six dimensions.

The same criterion applies to more complicated theories as well: *a theory is nonrenormalizable if any coefficient of any term in the lagrangian has negative mass dimension.*

What about theories with couplings with only positive or zero mass dimension? We see from eq. (411) that the only dangerous diagrams (those with $D \geq 0$) are those for which $[g_E] \geq 0$. But in this case, we can absorb the divergence simply by adjusting the value of Z_E . This discussion also applies to the propagator; we can think of $\Pi(k^2)$ as representing the loop-corrected counterterm vertex $Ak^2 + Bm^2$, with A and Bm^2 playing the roles of two couplings. We have $[A] = 0$ and $[Bm^2] = 2$, so the contributing diagrams are expected to be divergent (as we have already seen in detail), and the divergences must be absorbed into A and Bm^2 .

D is called the *superficial* degree of divergence because a diagram might diverge even if $D < 0$, or might be finite even if $D \geq 0$. The latter can happen if there are cancellations among ℓ 's in the numerator; quantum electrodynamics provides an example of this phenomenon that we will encounter in Part III. For now we turn our attention to the case of diagrams with $D < 0$ that nevertheless diverge.

Consider, for example, the diagrams of fig. (26) and (27). The one-loop diagram of fig. (26) with $E = 4$ is finite, but the two-loop correction from the first diagram of fig. (27) is not: the bubble on the upper propagator diverges. This is an example of a *divergent subdiagram*. However, this is not a problem in this case, because this divergence is canceled by the second diagram of fig. (27), which has a counterterm vertex in place of the bubble.

This is the generic situation: divergent subdiagrams are diagrams that, considered in isolation, have $D \geq 0$. These are precisely the diagrams whose divergences can be canceled by adjusting the Z factor of the corresponding tree diagram (in theories where $[g_n] \geq 0$ for all nonzero g_n).

Thus, we expect that theories with couplings whose mass dimensions are

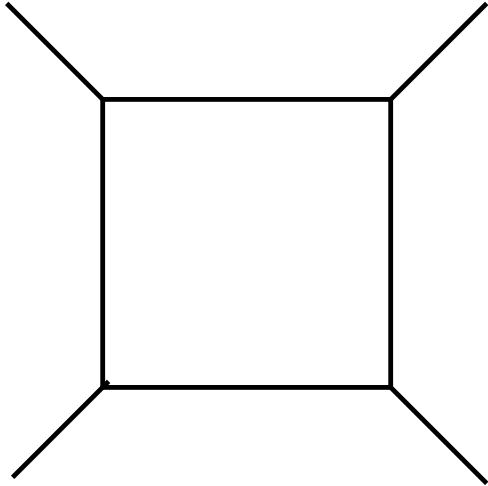

Figure 26: The one-loop contribution to \mathbf{V}_4 .

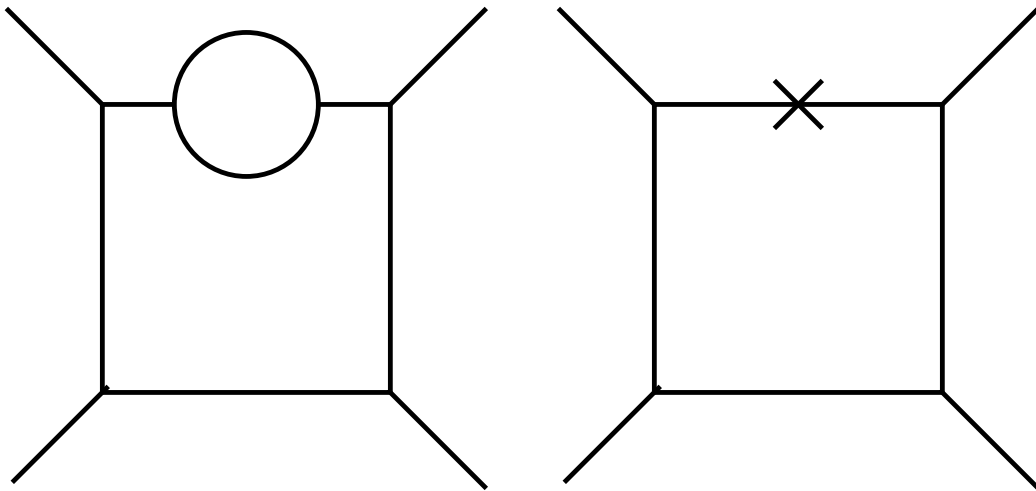

Figure 27: A two-loop contribution to \mathbf{V}_4 , and the corresponding counterterm insertion.

all positive or zero will be renormalizable. A detailed study of the properties of the momentum integrals in Feynman diagrams is necessary to give a complete proof of this. It turns out to be true without further restrictions for theories that have spin-zero and spin-one-half fields only.

Theories with spin-one fields are renormalizable for $d = 4$ if and only if these spin-one fields are associated with a *gauge symmetry*. We will study this in Part III.

Theories of fields with spin greater than one are never renormalizable for $d \geq 4$.

19: Perturbation Theory to All Orders: the Skeleton Expansion

Prerequisite: 18

In section 18, we found that, generally, a theory is renormalizable if all of its lagrangian coefficients have positive or zero mass dimension. In this section, using φ^3 theory in six dimensions as our example, we will see how to construct a finite expression for a scattering amplitude to arbitrarily high order in the φ^3 coupling g .

We begin by summing all one-particle irreducible diagrams with two external lines; this gives us the propagator correction $\Pi(k^2)$. Order by order in g , we must adjust the value of the counterterm coefficients $A = Z_\varphi - 1$ and $B = Z_m - 1$ to maintain the conditions $\Pi(-m^2) = 0$ and $\Pi'(-m^2) = 0$.

We next sum all 1PI diagrams with three external lines; this gives us the vertex function $\mathbf{V}_3(k_1, k_2, k_3)$. Order by order in g , we must adjust the value of $C = Z_g - 1$ to maintain the condition $\mathbf{V}_3(0, 0, 0) = g$.

Next we consider the other 1PI vertex functions $\mathbf{V}_n(k_1, \dots, k_n)$ for $4 \leq n \leq E$, where E is the number of external lines in the process of interest. We compute these using a *skeleton expansion*. This means that we draw all the contributing diagrams, but omit diagrams that include either propagator or vertex corrections. That is, we consider only diagrams that are not only 1PI, but also 2PI and 3PI: they remain simply connected when any one, two, or three lines are cut. (Cutting three lines may isolate a single tree-level vertex, but nothing more complicated.)

We take the propagators and vertices in these diagrams to be given by the *exact* propagator $\tilde{\Delta}(k^2) = (k^2 + m^2 - \Pi(k^2))^{-1}$ and vertex $\mathbf{V}_3(k_1, k_2, k_3)$, rather than by the tree-level propagator $\tilde{\Delta}(k^2) = (k^2 + m^2)^{-1}$ and vertex g . (More precisely, by the exact propagator and vertex computed to however high an order in g we wish to go, or could manage to do.) Then we sum these *skeleton diagrams* to get \mathbf{V}_n for $4 \leq n \leq E$.

Next we draw all *tree-level* diagrams contributing to the process of interest (which has E external lines), including not only three-point vertices, but also n -point vertices for $n = 3, 4, \dots, E$. Then we evaluate these diagrams using the exact propagator $\tilde{\Delta}(k^2)$ for internal lines, and the exact 1PI vertices \mathbf{V}_n .

External lines are assigned a factor of one. This is because, in the LSZ formula, each Klein-Gordon wave operator becomes (in momentum space) a factor of $k_i^2 + m^2$ that multiplies each external propagator, leaving behind only the residue of the pole in that propagator at $k_i^2 = -m^2$. We have constructed the exact propagator so that this residue is precisely one.

A careful examination of this complete procedure will reveal that we have now included all of the original contributing Feynman diagrams, with the correct counting factors.

Thus we now know how to compute an arbitrary scattering amplitude to arbitrarily high order. The procedure is the same in any quantum field theory; only the form of the propagators and vertices change, depending on the spins of the fields.

The tree-level diagrams of the final step can be thought of as the Feynman diagrams of a *quantum action* (or *effective action*, or *quantum effective action*) $\Gamma(\varphi)$. There is a simple and interesting relationship between the effective action $\Gamma(\varphi)$ and the sum of connected diagrams with sources $iW(J)$. We derive it in section 21.

20: Two-Particle Elastic Scattering at One Loop

Prerequisite: 10, 19

We now illustrate the general rules of section 19 by computing the two-particle elastic scattering amplitude, including all one-loop corrections, in φ^3 theory in six dimensions. *Elastic* means that the number of outgoing particles (of each species, in more general contexts) is the same as the number of incoming particles (of each species).

We computed the amplitude for this process at tree level in section 10, with the result

$$i\mathcal{T}_{\text{tree}} = \frac{1}{i}(ig)^2 \left[\tilde{\Delta}(-s) + \tilde{\Delta}(-t) + \tilde{\Delta}(-u) \right], \quad (414)$$

where $\tilde{\Delta}(-s) = 1/(-s + m^2 - i\epsilon)$ is the free-field propagator, and s , t , and u are the Mandelstam variables. Later we will need to remember that s is positive, that t and u are negative, and that $s + t + u = 4m^2$.

The exact scattering amplitude is given by the diagrams of fig. (28), with all propagators and vertices interpreted as *exact* propagators and vertices. (Recall, however, that each external propagator contributes only the residue of the pole at $k^2 = -m^2$, and that this residue is one; thus the factor associated with each external line is simply one.) We get the one-loop approximation to the exact amplitude by using the one-loop expressions for the internal propagators and vertices. We thus have

$$i\mathcal{T}_{1\text{-loop}} = \frac{1}{i} \left\{ [i\mathbf{V}_3(s)]^2 \tilde{\Delta}(-s) + [i\mathbf{V}_3(t)]^2 \tilde{\Delta}(-t) + [i\mathbf{V}_3(u)]^2 \tilde{\Delta}(-u) \right\} + i\mathbf{V}_4(s, t, u), \quad (415)$$

where, suppressing the $i\epsilon$'s,

$$\tilde{\Delta}(-s) = \frac{1}{-s + m^2 - \Pi(-s)}, \quad (416)$$

$$\Pi(-s) = \frac{1}{2}\alpha \int_0^1 dx D_2(s) \ln(D_2(s)/D_0) - \frac{1}{12}\alpha(-s + m^2), \quad (417)$$

$$\mathbf{V}_3(s)/g = 1 - \frac{1}{2}\alpha \int dF_3 \ln(D_3(s)/m^2), \quad (418)$$

$$\mathbf{V}_4(s, t, u) = \frac{1}{6}g^2\alpha \int dF_4 \left[\frac{1}{D_4(s, t)} + \frac{1}{D_4(t, u)} + \frac{1}{D_4(u, s)} \right]. \quad (419)$$

Here $\alpha = g^2/(4\pi)^3$, the Feynman integration measure is

$$\begin{aligned} \int dF_n f(x) &= (n-1)! \int_0^1 dx_1 \dots dx_n \delta(x_1 + \dots + x_n - 1) f(x) \\ &= (n-1)! \int_0^1 dx_1 \int_0^{1-x_1} dx_2 \dots \int_0^{1-x_1-\dots-x_{n-2}} dx_{n-1} \\ &\quad \times f(x) \Big|_{x_n=1-x_1-\dots-x_{n-1}}, \end{aligned} \quad (420)$$

and we have defined

$$D_2(s) = -x(1-x)s + m^2, \quad (421)$$

$$D_0 = +[1-x(1-x)]m^2, \quad (422)$$

$$D_3(s) = -x_1x_2s + [1-(x_1+x_2)x_3]m^2, \quad (423)$$

$$D_4(s, t) = -x_1x_2s - x_3x_4t + [1-(x_1+x_2)(x_3+x_4)]m^2. \quad (424)$$

We obtain $\mathbf{V}_3(s)$ from the general three-point function $\mathbf{V}_3(k_1, k_2, k_3)$ by setting two of the three k_i^2 to $-m^2$, and the third to $-s$. We obtain $\mathbf{V}_4(s, t, u)$ from the general four-point function $\mathbf{V}_4(k_1, \dots, k_4)$ by setting all four k_i^2 to $-m^2$, $(k_1 + k_2)^2$ to $-s$, $(k_1 + k_3)^2$ to $-t$, and $(k_1 + k_4)^2$ to $-u$. (Recall that the vertex functions are defined with all momenta treated as incoming; here we have identified $-k_3$ and $-k_4$ as the outgoing momenta.)

Eqs. (415–424) are formidable expressions. To gain some intuition about them, let us consider the limit of high-energy, fixed angle scattering, where we take s , $|t|$, and $|u|$ all much larger than m^2 . Equivalently, we are considering the amplitude in the limit of zero particle mass.

We can then set $m^2 = 0$ in $D_2(s)$, $D_3(s)$, and $D_4(s, t)$. For the self-energy, we get

$$\begin{aligned} \Pi(-s) &= -\frac{1}{2}\alpha s \int_0^1 dx x(1-x) \left[\ln\left(\frac{-s}{m^2}\right) + \ln\left(\frac{x(1-x)}{1-x(1-x)}\right) \right] + \frac{1}{12}\alpha s \\ &= -\frac{1}{12}\alpha s \left[\ln(-s/m^2) + 3 - \pi\sqrt{3} \right]. \end{aligned} \quad (425)$$

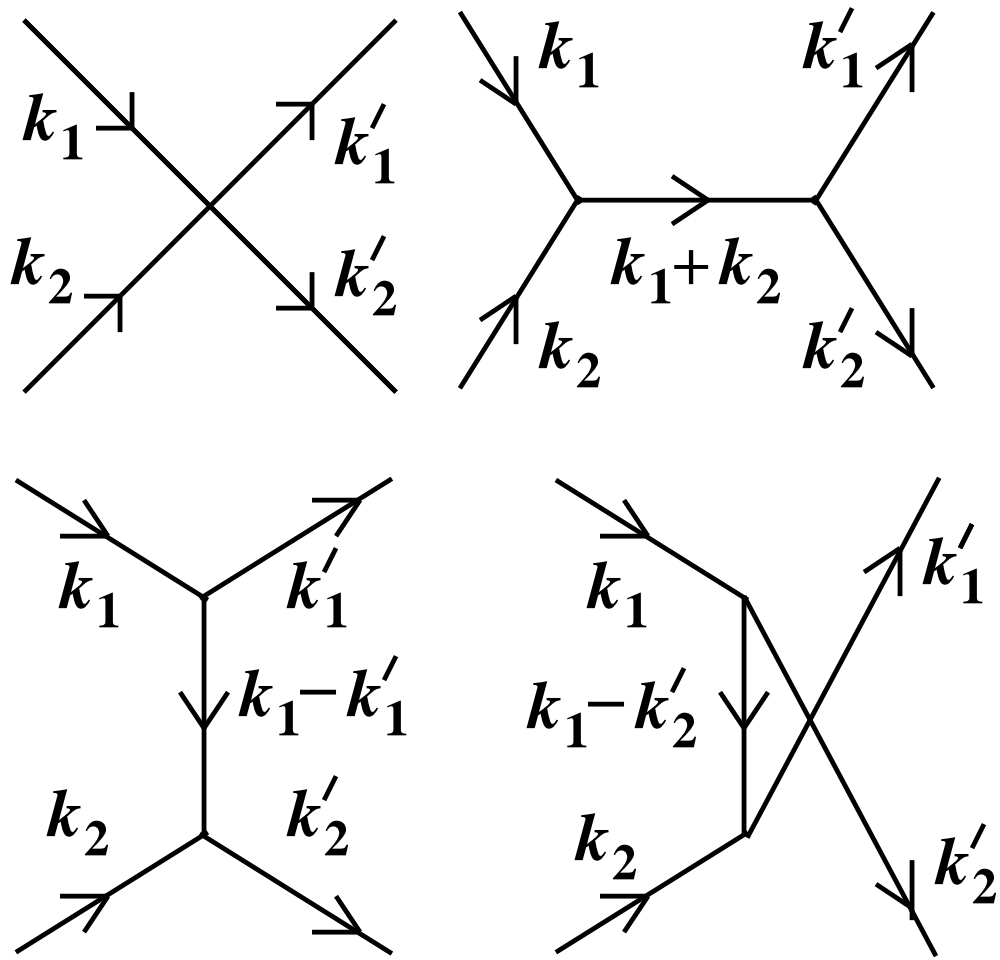

Figure 28: The Feynman diagrams contributing to the two-particle elastic scattering amplitude; in these diagrams, the lines and points represent the exact propagators and vertices.

Thus,

$$\begin{aligned}\tilde{\Delta}(-s) &= \frac{1}{-s - \Pi(-s)} \\ &= -\frac{1}{s} \left(1 + \frac{1}{12}\alpha \left[\ln(-s/m^2) + 3 - \pi\sqrt{3} \right] \right) + O(\alpha^2) .\end{aligned}\quad (426)$$

The appropriate branch of the logarithm is found by replacing s by $s + i\epsilon$. For s real and positive, $-s$ lies just below the negative real axis, and so

$$\ln(-s) = \ln s - i\pi . \quad (427)$$

For t (or u), which is negative, we have instead

$$\begin{aligned}\ln(-t) &= \ln |t| , \\ \ln t &= \ln |t| + i\pi .\end{aligned}\quad (428)$$

For the three-point vertex, we get

$$\begin{aligned}\mathbf{V}_3(s)/g &= 1 - \frac{1}{2}\alpha \int dF_3 \left[\ln(-s/m^2) + \ln(x_1 x_2) \right] , \\ &= 1 - \frac{1}{2}\alpha \left[\ln(-s/m^2) - 3 \right] ,\end{aligned}\quad (429)$$

where the same comments about the appropriate branch apply.

For the four-point vertex, after some intrigue with the integral over the Feynman parameters, we get

$$\begin{aligned}\int \frac{dF_4}{D_4(s, t)} &= -\frac{3}{s+t} \left(\pi^2 + [\ln(s/t)]^2 \right) \\ &= +\frac{3}{u} \left(\pi^2 + [\ln(s/t)]^2 \right) ,\end{aligned}\quad (430)$$

where the second line follows from $s + t + u = 0$.

Putting all of this together, we have

$$\mathcal{T}_{1\text{-loop}} = g^2 \left[F(s, t, u) + F(t, u, s) + F(u, s, t) \right] , \quad (431)$$

where

$$F(s, t, u) \equiv -\frac{1}{s} \left(1 - \frac{11}{12}\alpha \left[\ln(-s/m^2) + c \right] - \frac{1}{2}\alpha \left[\ln(t/u) \right]^2 \right) , \quad (432)$$

and $c = (6\pi^2 + \pi\sqrt{3} - 39)/11 = 2.33$. This is a typical result of a loop calculation: the original tree-level amplitude is corrected by powers of logarithms of kinematic variables.

21: The Quantum Action

Prerequisite: 19

In section 19, we saw how to compute (in φ^3 theory in six dimensions) the 1PI vertex functions $\mathbf{V}_n(k_1, \dots, k_n)$ for $n \geq 4$ via the *skeleton expansion*: draw all Feynman diagrams with n external lines that are one-, two-, and three-particle irreducible, and compute them using the exact propagator $\tilde{\Delta}(k^2)$ and three-point vertex function $\mathbf{V}_3(k_1, k_2, k_3)$.

We now define the *quantum action* (or *effective action*, or *quantum effective action*)

$$\begin{aligned} \Gamma(\varphi) \equiv & \frac{1}{2} \int \frac{d^6k}{(2\pi)^6} \tilde{\varphi}(-k) (k^2 + m^2 - \Pi(k^2)) \tilde{\varphi}(k) \\ & + \sum_{n=3}^{\infty} \frac{1}{n!} \int \frac{d^6k_1}{(2\pi)^6} \cdots \frac{d^6k_n}{(2\pi)^6} (2\pi)^6 \delta^6(k_1 + \dots + k_n) \\ & \times \mathbf{V}_n(k_1, \dots, k_n) \tilde{\varphi}(k_1) \cdots \tilde{\varphi}(k_n), \end{aligned} \quad (433)$$

where $\tilde{\varphi}(k) = \int d^6x e^{-ikx} \varphi(x)$. The quantum action has the property that the *tree-level* Feynman diagrams it generates give the *complete* scattering amplitude of the original theory.

In this section, we will determine the relationship between $\Gamma(\varphi)$ and the sum of connected diagrams with sources, $iW(J)$, introduced in section 9. Recall that $W(J)$ is related to the path integral

$$Z(J) = \int \mathcal{D}\varphi \exp \left[iS(\varphi) + i \int d^6x J\varphi \right], \quad (434)$$

where $S = \int d^6x \mathcal{L}$ is the action, via

$$Z(J) = \exp[iW(J)]. \quad (435)$$

Consider now the path integral

$$Z_{\Gamma}(J) \equiv \int \mathcal{D}\varphi \exp \left[i\Gamma(\varphi) + i \int d^6x J\varphi \right] \quad (436)$$

$$= \exp[iW_{\Gamma}(J)] . \quad (437)$$

$W_{\Gamma}(J)$ is given by the sum of connected diagrams (with sources) in which each line represents the exact propagator, and each n -point vertex represents the exact 1PI vertex \mathbf{V}_n . $W_{\Gamma}(J)$ would be equal to $W(J)$ if we included only tree diagrams in $W_{\Gamma}(J)$.

We can isolate the tree-level contribution to a path integral by means of the following trick. Introduce a dimensionless parameter that we will call \hbar , and the path integral

$$Z_{\Gamma,\hbar}(J) \equiv \int \mathcal{D}\varphi \exp \left[\frac{i}{\hbar} \left(\Gamma(\varphi) + \int d^6x J\varphi \right) \right] \quad (438)$$

$$= \exp[iW_{\Gamma,\hbar}(J)] . \quad (439)$$

In a given connected diagram with sources, every propagator (including those that connect to sources) is multiplied by \hbar , every source by $1/\hbar$, and every vertex by $1/\hbar$. The overall factor of \hbar is then \hbar^{P-E-V} , where V is the number of vertices, E is the number of sources (equivalently, the number of external lines after we remove the sources), and P is the number of propagators (external and internal). We next note that $P-E-V$ is equal to $L-1$, where L is the number of closed loops. This can be seen by counting the number of internal momenta and the constraints among them. Specifically, assign an unfixed momentum to each internal line; there are $P-E$ of these momenta. Then the V vertices provide V constraints. One linear combination of these constraints gives overall momentum conservation, and so does not constrain the internal momenta. Therefore, the number of internal momenta left unfixed by the vertex constraints is $(P-E)-(V-1)$, and the number of unfixed momenta is the same as the number of loops L .

So, $W_{\Gamma,\hbar}(J)$ can be expressed as a power series in \hbar of the form

$$W_{\Gamma,\hbar}(J) = \sum_{L=0}^{\infty} \hbar^{L-1} W_{\Gamma,L}(J) . \quad (440)$$

If we take the formal limit of $\hbar \rightarrow 0$, the dominant term is the one with $L = 0$, which is given by the sum of tree diagrams only. This is just what we want. We conclude that

$$W(J) = W_{\Gamma, L=0}(J) . \quad (441)$$

Next we perform the path integral in eq. (438) by the method of stationary phase. We find the point (actually, the field configuration) at which the exponent is stationary; this is given by the solution of the *quantum equation of motion*

$$\frac{\delta}{\delta\varphi(x)}\Gamma(\varphi) = -J(x) . \quad (442)$$

Let $\varphi_J(x)$ denote the solution of eq. (442) with a specified source function $J(x)$. Then the stationary-phase approximation to $Z_{\Gamma, \hbar}(J)$ is

$$Z_{\Gamma, \hbar}(J) = \exp \left[\frac{i}{\hbar} \left(\Gamma(\varphi_J) + \int d^6x J\varphi_J \right) + O(\hbar^0) \right] . \quad (443)$$

Combining the results of eqs. (439), (440), (441), and (443), we find

$$W(J) = \Gamma(\varphi_J) + \int d^6x J\varphi_J . \quad (444)$$

This is the main result of this section.

Let us explore it further. Recall from section 9 that the vacuum expectation value of the field operator $\varphi(x)$ is given by

$$\langle 0|\varphi(x)|0\rangle = \frac{\delta}{\delta J(x)}W(J) \Big|_{J=0} . \quad (445)$$

Now consider what we get if we do not set $J = 0$ after taking the derivative:

$$\langle 0|\varphi(x)|0\rangle_J \equiv \frac{\delta}{\delta J(x)}W(J) . \quad (446)$$

This is the vacuum expectation value of $\varphi(x)$ in the presence of a nonzero source function $J(x)$. We can get some more information about it by using eq. (444) for $W(J)$. Making use of the product rule for derivatives, we have

$$\langle 0|\varphi(x)|0\rangle_J = \frac{\delta}{\delta J(x)}\Gamma(\varphi_J) + \varphi_J(x) + \int d^6y J(y) \frac{\delta\varphi_J(y)}{\delta J(x)} . \quad (447)$$

We can evaluate the first term on the right-hand side by using the chain rule,

$$\frac{\delta}{\delta J(x)}\Gamma(\varphi_J) = \int d^6y \frac{\delta\Gamma(\varphi_J)}{\delta\varphi_J(y)} \frac{\delta\varphi_J(y)}{\delta J(x)} . \quad (448)$$

Then we can combine the first and third terms on the right-hand side of eq. (447) to get

$$\langle 0|\varphi(x)|0\rangle_J = \int d^6y \left[\frac{\delta\Gamma(\varphi_J)}{\delta\varphi_J(y)} + J(y) \right] \frac{\delta\varphi_J(y)}{\delta J(x)} + \varphi_J(x) . \quad (449)$$

Now we note from eq. (442) that the factor in large brackets on the right-hand side of eq. (449) vanishes, and so

$$\langle 0|\varphi(x)|0\rangle_J = \varphi_J(x) . \quad (450)$$

That is, the vacuum expectation value of the field operator $\varphi(x)$ in the presence of a nonzero source function is also the solution to the quantum equation of motion, eq. (442).

We can also write the quantum action in terms of a *derivative expansion*,

$$\Gamma(\varphi) = \int d^6x \left[-\mathcal{U}(\varphi) - \frac{1}{2}\mathcal{Z}(\varphi)\partial^\mu\varphi\partial_\mu\varphi + \dots \right] , \quad (451)$$

where the ellipses stand for an infinite number of terms with more and more derivatives, and $\mathcal{U}(\varphi)$ and $\mathcal{Z}(\varphi)$ are ordinary functions (not functionals) of $\varphi(x)$. $\mathcal{U}(\varphi)$ is called the *quantum potential* (or *effective potential*, or *quantum effective potential*), and it plays an important conceptual role in theories with spontaneous symmetry breaking; see section 28. However, it is rarely necessary to compute it explicitly, except in those cases where we are unable to do so.

Problems

21.1) Show that

$$\Gamma(\varphi) = W(J_\varphi) - \int d^6x J_\varphi\varphi , \quad (452)$$

where $J_\varphi(x)$ is the solution of

$$\frac{\delta}{\delta J(x)} W(J) = \varphi(x) \quad (453)$$

for a specified $\varphi(x)$.

21.2) Consider performing the path integral in the presence of a *background field* $\bar{\varphi}(x)$; we define

$$\exp[iW(J; \bar{\varphi})] \equiv \int \mathcal{D}\varphi \exp\left[iS(\varphi + \bar{\varphi}) + i \int d^6x J\varphi \right]. \quad (454)$$

Then $W(J; 0)$ is the original $W(J)$ of eq. (435). We also define the quantum action in the presence of the background field,

$$\Gamma(\varphi; \bar{\varphi}) \equiv W(J_\varphi; \bar{\varphi}) - \int d^6x J_\varphi \varphi, \quad (455)$$

where $J_\varphi(x)$ is the solution of

$$\frac{\delta}{\delta J(x)} W(J; \bar{\varphi}) = \varphi(x) \quad (456)$$

for a specified $\varphi(x)$. Show that

$$\Gamma(\varphi; \bar{\varphi}) = \Gamma(\varphi + \bar{\varphi}; 0), \quad (457)$$

where $\Gamma(\varphi, 0)$ is the original quantum action of eq. (433).

22: Continuous Symmetries and Conserved Currents

Prerequisite: 8

Suppose we have a set of scalar fields $\varphi_a(x)$, and a lagrangian density $\mathcal{L}(x) = \mathcal{L}(\varphi_a(x), \partial_\mu \varphi_a(x))$. Consider what happens to $\mathcal{L}(x)$ if we make an infinitesimal change $\varphi_a(x) \rightarrow \varphi_a(x) + \delta\varphi_a(x)$ in each field. We have $\mathcal{L}(x) \rightarrow \mathcal{L}(x) + \delta\mathcal{L}(x)$, where $\delta\mathcal{L}(x)$ is given by the chain rule,

$$\delta\mathcal{L}(x) = \frac{\partial\mathcal{L}}{\partial\varphi_a(x)} \delta\varphi_a(x) + \frac{\partial\mathcal{L}}{\partial(\partial_\mu\varphi_a(x))} \partial_\mu\delta\varphi_a(x). \quad (458)$$

Next consider the classical equations of motion (also known as the Euler-Lagrange equations, or the *field equations*), given by the action principle

$$\frac{\delta S}{\delta\varphi_a(x)} = 0, \quad (459)$$

where $S = \int d^4y \mathcal{L}(y)$ is the action, and $\delta/\delta\varphi_a(x)$ is a functional derivative. We have (with repeated indices implicitly summed)

$$\begin{aligned} \frac{\delta S}{\delta\varphi_a(x)} &= \int d^4y \frac{\delta\mathcal{L}(y)}{\delta\varphi_a(x)} \\ &= \int d^4y \left[\frac{\partial\mathcal{L}(y)}{\partial\varphi_b(y)} \frac{\delta\varphi_b(y)}{\delta\varphi_a(x)} + \frac{\partial\mathcal{L}(y)}{\partial(\partial_\mu\varphi_b(y))} \frac{\delta(\partial_\mu\varphi_b(y))}{\delta\varphi_a(x)} \right] \\ &= \int d^4y \left[\frac{\partial\mathcal{L}(y)}{\partial\varphi_b(y)} \delta_{ba} \delta^4(y-x) + \frac{\partial\mathcal{L}(y)}{\partial(\partial_\mu\varphi_b(y))} \delta_{ba} \partial_\mu \delta^4(y-x) \right] \\ &= \frac{\partial\mathcal{L}(x)}{\partial\varphi_a(x)} - \partial_\mu \frac{\partial\mathcal{L}(x)}{\partial(\partial_\mu\varphi_a(x))}. \end{aligned} \quad (460)$$

We can use this result to make the replacement

$$\frac{\partial \mathcal{L}(x)}{\partial \varphi_a(x)} \rightarrow \partial_\mu \frac{\partial \mathcal{L}(x)}{\partial (\partial_\mu \varphi_a(x))} + \frac{\delta S}{\delta \varphi_a(x)} \quad (461)$$

in eq. (458). Then, combining two of the terms, we get

$$\delta \mathcal{L}(x) = \partial_\mu \left(\frac{\partial \mathcal{L}(x)}{\partial (\partial_\mu \varphi_a(x))} \delta \varphi_a(x) \right) + \frac{\delta S}{\delta \varphi_a(x)} \delta \varphi_a(x). \quad (462)$$

Next we identify the object in large parentheses in eq. (462) as the *Noether current*

$$j^\mu(x) \equiv \frac{\partial \mathcal{L}(x)}{\partial (\partial_\mu \varphi_a(x))} \delta \varphi_a(x). \quad (463)$$

Eq. (462) then implies

$$\partial_\mu j^\mu(x) = \delta \mathcal{L}(x) - \frac{\delta S}{\delta \varphi_a(x)} \delta \varphi_a(x). \quad (464)$$

If the classical field equations are satisfied, then the second term on the right-hand side of eq. (464) vanishes.

The Noether current plays a special role if we can find a set of infinitesimal field transformations that leaves the lagrangian unchanged, or *invariant*. In this case, we have $\delta \mathcal{L} = 0$, and we say that the lagrangian has a *continuous symmetry*. From eq. (464), we then have $\partial_\mu j^\mu = 0$ whenever the field equations are satisfied, and we say that the Noether current is *conserved*. In terms of its space and time components, this means that

$$\frac{\partial}{\partial t} j^0(x) + \nabla \cdot \mathbf{j}(x) = 0. \quad (465)$$

If we interpret $j^0(x)$ as a *charge density*, and $\mathbf{j}(x)$ as the corresponding *current density*, then eq. (465) expresses the local conservation of this charge.

Let us see an example of this. Consider a theory of a *complex* scalar field with lagrangian

$$\mathcal{L} = -\partial^\mu \varphi^\dagger \partial_\mu \varphi - m^2 \varphi^\dagger \varphi - \frac{1}{4} \lambda (\varphi^\dagger \varphi)^2. \quad (466)$$

We can also rewrite \mathcal{L} in terms of two real scalar fields by setting $\varphi = (\varphi_1 + i\varphi_2)/\sqrt{2}$ to get

$$\mathcal{L} = -\frac{1}{2} \partial^\mu \varphi_1 \partial_\mu \varphi_1 - \frac{1}{2} \partial^\mu \varphi_2 \partial_\mu \varphi_2 - \frac{1}{2} m^2 (\varphi_1^2 + \varphi_2^2) - \frac{1}{16} \lambda (\varphi_1^2 + \varphi_2^2)^2. \quad (467)$$

In the form of eq. (466), it is obvious that \mathcal{L} is left invariant by the transformation

$$\varphi(x) \rightarrow e^{-i\alpha}\varphi(x) , \quad (468)$$

where α is a real number. This is called a $U(1)$ transformation, a transformation by a unitary 1×1 matrix. In terms of φ_1 and φ_2 , this transformation reads

$$\begin{pmatrix} \varphi_1(x) \\ \varphi_2(x) \end{pmatrix} \rightarrow \begin{pmatrix} \cos \alpha & \sin \alpha \\ -\sin \alpha & \cos \alpha \end{pmatrix} \begin{pmatrix} \varphi_1(x) \\ \varphi_2(x) \end{pmatrix}. \quad (469)$$

If we think of (φ_1, φ_2) as a two-component vector, then eq. (469) is just a rotation of this vector in the plane by angle α . Eq. (469) is called an $SO(2)$ transformation, a transformation by an orthogonal 2×2 matrix with a special value of the determinant (namely $+1$, as opposed to -1 , the only other possibility for an orthogonal matrix). We have learned that a $U(1)$ transformation can be mapped into an $SO(2)$ transformation.

The infinitesimal form of eq. (468) is

$$\begin{aligned} \varphi(x) &\rightarrow \varphi(x) - i\alpha\varphi(x) , \\ \varphi^\dagger(x) &\rightarrow \varphi^\dagger(x) + i\alpha\varphi^\dagger(x) , \end{aligned} \quad (470)$$

where α is now infinitesimal. In eq. (463), we should treat φ and φ^\dagger as independent fields. The Noether current is then

$$\begin{aligned} j^\mu &= \frac{\partial \mathcal{L}}{\partial(\partial_\mu \varphi)} \delta\varphi + \frac{\partial \mathcal{L}}{\partial(\partial_\mu \varphi^\dagger)} \delta\varphi^\dagger \\ &= (-\partial^\mu \varphi^\dagger)(-i\alpha\varphi) + (-\partial^\mu \varphi)(+i\alpha\varphi^\dagger) \\ &= \alpha \text{Im}(\varphi^\dagger \overleftrightarrow{\partial}^\mu \varphi) , \end{aligned} \quad (471)$$

where $A \overleftrightarrow{\partial}^\mu B \equiv A \partial^\mu B - (\partial^\mu A) B$. It is conventional to drop the infinitesimal parameter on the right-hand side in the final expression for the Noether current.

We can also repeat this exercise using the $SO(2)$ form of the transformation. For infinitesimal α , eq. (469) becomes $\delta\varphi_1 = +\alpha\varphi_2$ and $\delta\varphi_2 = -\alpha\varphi_1$.

Then the Noether current is

$$\begin{aligned}
 j^\mu &= \frac{\partial \mathcal{L}}{\partial(\partial_\mu \varphi_1)} \delta \varphi_1 + \frac{\partial \mathcal{L}}{\partial(\partial_\mu \varphi_2)} \delta \varphi_2 \\
 &= (-\partial^\mu \varphi_1)(+\alpha \varphi_2) + (-\partial^\mu \varphi_2)(-\alpha \varphi_1) \\
 &= \alpha (\varphi_1 \overleftrightarrow{\partial}^\mu \varphi_2),
 \end{aligned} \tag{472}$$

which is (hearteningly) equivalent to eq. (471).

Let us define the total charge

$$Q \equiv \int d^3x j^0(x) = \int d^3x \operatorname{Im}(\varphi^\dagger \overleftrightarrow{\partial}^0 \varphi), \tag{473}$$

and investigate its properties. If we integrate eq. (465) over d^3x , use Gauss's law to write the volume integral of $\nabla \cdot \mathbf{j}$ as a surface integral, and assume that the boundary conditions at infinity fix $\mathbf{j}(x) = 0$ on that surface, then we find that Q is constant in time. To get a better idea of the physical implications of this, let us rewrite Q using the free-field expansions

$$\begin{aligned}
 \varphi(x) &= \int \widetilde{d}\mathbf{k} [a(\mathbf{k})e^{i\mathbf{k}x} + b^*(\mathbf{k})e^{-i\mathbf{k}x}], \\
 \varphi^\dagger(x) &= \int \widetilde{d}\mathbf{k} [b(\mathbf{k})e^{i\mathbf{k}x} + a^*(\mathbf{k})e^{-i\mathbf{k}x}].
 \end{aligned} \tag{474}$$

We have written $a^*(\mathbf{k})$ and $b^*(\mathbf{k})$ rather than $a^\dagger(\mathbf{k})$ and $b^\dagger(\mathbf{k})$ because so far our discussion has been about the classical field theory. In a theory with interactions, these formulae (and their first time derivatives) are valid at any one particular time (say, $t = -\infty$). Then, we can plug them into eq. (473), and find (after some manipulation similar to what we did for the hamiltonian in section 3)

$$Q = \int \widetilde{d}\mathbf{k} [a^*(\mathbf{k})a(\mathbf{k}) - b(\mathbf{k})b^*(\mathbf{k})]. \tag{475}$$

In the quantum theory, this becomes an operator that counts the number of a particles minus the number of b particles. This number is then time-independent, and so the scattering amplitude vanishes identically for any process that changes the value of Q . This can be seen directly from the Feynman rules, which conserve Q at every vertex.

To better understand the implications of the Noether current in the quantum theory, we begin by considering the infinitesimal transformation $\varphi_a(x) \rightarrow \varphi_a(x) + \delta\varphi_a(x)$ as a change of integration variable in the path integral,

$$Z(J) = \int \mathcal{D}\varphi e^{i[S + \int d^4y J_a \varphi_a]} . \quad (476)$$

As with any integral, its value is unchanged by a change of integration variable. In our case, this change is just a shift, with unit jacobian, and so the measure $\mathcal{D}\varphi$ is unchanged. Thus we have

$$\begin{aligned} 0 &= \delta Z(J) \\ &= i \int \mathcal{D}\varphi e^{i[S + \int d^4y J_b \varphi_b]} \int d^4x \left(\frac{\delta S}{\delta \varphi_a(x)} + J_a(x) \right) \delta \varphi_a(x) . \end{aligned} \quad (477)$$

Since this is true for arbitrary $\delta\varphi_a(x)$, we can remove it (and the integral over d^4x) from the right-hand side. We can also take n functional derivatives with respect to $J_{a_j}(x_j)$, and then set $J = 0$, to get

$$\begin{aligned} 0 &= \int \mathcal{D}\varphi e^{iS} \left[i \frac{\delta S}{\delta \varphi_a(x)} \varphi_{a_1}(x_1) \dots \varphi_{a_n}(x_n) \right. \\ &\quad \left. + \sum_{j=1}^n \varphi_{a_1}(x_1) \dots \delta_{aa_j} \delta^4(x-x_j) \dots \varphi_{a_n}(x_n) \right] \end{aligned} \quad (478)$$

$$\begin{aligned} &= i \langle 0 | \text{T} \frac{\delta S}{\delta \varphi_a(x)} \varphi_{a_1}(x_1) \dots \varphi_{a_n}(x_n) | 0 \rangle \\ &\quad + \sum_{j=1}^n \langle 0 | \text{T} \varphi_{a_1}(x_1) \dots \delta_{aa_j} \delta^4(x-x_j) \dots \varphi_{a_n}(x_n) | 0 \rangle . \end{aligned} \quad (479)$$

These are the *Schwinger-Dyson equations* for the theory.

To get a feel for them, let us look at free-field theory for a single real scalar field, for which $\delta S / \delta \varphi(x) = (\partial_x^2 - m^2)\varphi(x)$. For $n = 1$ we get

$$(-\partial_x^2 + m^2) i \langle 0 | \text{T} \varphi(x) \varphi(x_1) | 0 \rangle = \delta^4(x-x_1) . \quad (480)$$

That the Klein-Gordon wave operator should sit outside the time-ordered product (and hence act on the time-ordering step functions) is clear from

the path integral form of eq. (478). We see from eq. (480) that the free-field propagator, $\Delta(x-x_1) = i\langle 0|\text{T}\varphi(x)\varphi(x_1)|0\rangle$, is a Green's function for the Klein-Gordon wave operator, a fact we first learned in section 8.

More generally, we can write

$$\langle 0|\text{T}\frac{\delta S}{\delta\varphi_a(x)}\varphi_{a_1}(x_1)\dots\varphi_{a_n}(x_n)|0\rangle = 0 \quad \text{for } x \neq x_{1,\dots,n}. \quad (481)$$

We see that the classical equation of motion is satisfied by a quantum field inside a correlation function, as long as its spacetime argument differs from those of all the other fields. When this is not the case, we get extra *contact terms*.

Let us now consider a theory that has a continuous symmetry and a corresponding Noether current. Take eq. (479) and multiply it by $\delta\varphi_a(x)$, where $\delta\varphi_a(x)$ is the infinitesimal change in $\varphi_a(x)$ that results in $\delta\mathcal{L}(x) = 0$. Now sum over the index a , and use eq. (464). The result is the *Ward identity*

$$0 = \partial_\mu\langle 0|\text{T}j^\mu(x)\varphi_{a_1}(x_1)\dots\varphi_{a_n}(x_n)|0\rangle + i\sum_{j=1}^n\langle 0|\text{T}\varphi_{a_1}(x_1)\dots\delta\varphi_{a_j}(x)\delta^4(x-x_j)\dots\varphi_{a_n}(x_n)|0\rangle. \quad (482)$$

Thus, conservation of the Noether current holds in the quantum theory, with the current inside a correlation function, up to contact terms with a specific form that depends on the details of the infinitesimal transformation that leaves \mathcal{L} invariant.

The Noether current is also useful in a slightly more general context. Suppose we have a transformation of the fields such that $\delta\mathcal{L}(x)$ is not zero, but instead is a total divergence: $\delta\mathcal{L}(x) = \partial_\mu K^\mu(x)$ for some $K^\mu(x)$. Then there is still a conserved current, now given by

$$j^\mu(x) = \frac{\partial\mathcal{L}(x)}{\partial(\partial_\mu\varphi_a(x))}\delta\varphi_a(x) - K^\mu(x). \quad (483)$$

An example of this is provided by the symmetry of *spacetime translations*. We transform the fields via $\varphi_a(x) \rightarrow \varphi_a(x+a)$, where a^μ is a constant four-vector. The infinitesimal version of this is $\varphi_a(x) \rightarrow \varphi_a(x) + a^\nu\partial_\nu\varphi_a(x)$, and so we have $\delta\varphi_a(x) = a^\nu\partial_\nu\varphi_a(x)$. Under this transformation, we obviously

have $\mathcal{L}(x) \rightarrow \mathcal{L}(x+a)$, and so $\delta\mathcal{L}(x) = a^\nu \partial_\nu \mathcal{L}(x) = \partial_\nu(a^\nu \mathcal{L}(x))$. Thus in this case $K^\nu(x) = a^\nu \mathcal{L}(x)$, and the conserved current is

$$\begin{aligned} j^\mu(x) &= \frac{\partial\mathcal{L}(x)}{\partial(\partial_\mu\varphi_a(x))} a^\nu \partial_\nu \varphi_a(x) - a^\mu \mathcal{L}(x) \\ &= -a_\nu T^{\mu\nu}(x) , \end{aligned} \quad (484)$$

where we have defined the *stress-energy* or *energy-momentum tensor*

$$T^{\mu\nu}(x) \equiv - \frac{\partial\mathcal{L}(x)}{\partial(\partial_\mu\varphi_a(x))} \partial^\nu \varphi_a(x) + g^{\mu\nu} \mathcal{L}(x) . \quad (485)$$

For a renormalizable theory of a set of real scalar fields $\varphi_a(x)$, the lagrangian takes the form

$$\mathcal{L} = -\frac{1}{2} \partial^\mu \varphi_a \partial_\mu \varphi_a - V(\varphi) , \quad (486)$$

where $V(\varphi)$ is a polynomial in the φ_a 's. In this case

$$T^{\mu\nu} = \partial^\mu \varphi_a \partial^\nu \varphi_a + g^{\mu\nu} \mathcal{L} . \quad (487)$$

In particular,

$$T^{00} = \frac{1}{2} \Pi_a^2 + \frac{1}{2} (\nabla \varphi_a)^2 + V(\varphi) , \quad (488)$$

where $\Pi_a = \partial_0 \varphi_a$ is the canonical momentum conjugate to the field φ_a . We recognize T^{00} as the *hamiltonian density* \mathcal{H} that corresponds to the lagrangian density of eq. (486). Then, by Lorentz symmetry, T^{0j} must be the corresponding momentum density. We have

$$T^{0j} = \partial^0 \varphi_a \partial^j \varphi_a = -\Pi_a \nabla^j \varphi_a . \quad (489)$$

If we use the free-field expansion for a set of real scalar fields [the same as eq. (474) but with $b(\mathbf{k}) = a(\mathbf{k})$ for each field], we find that the momentum operator is given by

$$P^j = \int d^3x T^{0j}(x) = \int \widetilde{dk} k^j a_a^\dagger(\mathbf{k}) a_a(\mathbf{k}) . \quad (490)$$

We therefore identify the *energy-momentum four-vector* as

$$P^\mu = \int d^3x T^{0\mu}(x) . \quad (491)$$

Recall that in section 2 we defined the *spacetime translation operator* as

$$T(a) \equiv \exp(-iP^\mu a_\mu) , \quad (492)$$

and announced that it had the property that

$$T(a)^{-1}\varphi(x)T(a) = \varphi(x - a) . \quad (493)$$

Now that we have an explicit formula for P^μ , we can check this. This is easiest to do for infinitesimal a^μ ; then eq. (493) becomes

$$[\varphi(x), P^\mu] = \frac{1}{i}\partial^\mu\varphi(x) . \quad (494)$$

This can indeed be verified by using the canonical commutation relations for $\varphi(x)$ and $\Pi(x)$.

One more symmetry we can investigate is Lorentz symmetry. If we make an infinitesimal Lorentz transformation, we have $\varphi_a(x) \rightarrow \varphi_a(x + \delta\omega x)$, where $\delta\omega \cdot x$ is shorthand for $\delta\omega^\nu{}_\rho x^\rho$. This case is very similar to that of spacetime translations; the only difference is that the translation parameter a^ν is now x dependent, $a^\nu \rightarrow \delta\omega^\nu{}_\rho x^\rho$. The resulting conserved current is

$$\mathcal{M}^{\mu\nu\rho}(x) = x^\nu T^{\mu\rho}(x) - x^\rho T^{\mu\nu}(x) , \quad (495)$$

and it obeys $\partial_\mu \mathcal{M}^{\mu\nu\rho} = 0$, with the derivative contracted with the first index. $\mathcal{M}^{\mu\nu\rho}$ is antisymmetric on its second two indices; this comes about because $\delta\omega^{\nu\rho}$ is antisymmetric. The conserved charges associated with this current are

$$M^{\nu\rho} = \int d^3x \mathcal{M}^{0\nu\rho}(x) , \quad (496)$$

and these are the *generators of the Lorentz group* that were introduced in section 3. Again, we can use the canonical commutation relations for the fields to check that the Lorentz generators have the right commutation relations, both with the fields and with each other.

23: Discrete Symmetries: P , T , C , and Z

Prerequisite: 22

In section 2, we studied the *proper orthochronous* Lorentz transformations, which are continuously connected to the identity. In this section, we will consider the effects of *parity*,

$$\mathcal{P}^\mu{}_\nu = (\mathcal{P}^{-1})^\mu{}_\nu = \begin{pmatrix} +1 & & & \\ & -1 & & \\ & & -1 & \\ & & & -1 \end{pmatrix}. \quad (497)$$

and *time reversal*,

$$\mathcal{T}^\mu{}_\nu = (\mathcal{T}^{-1})^\mu{}_\nu = \begin{pmatrix} -1 & & & \\ & +1 & & \\ & & +1 & \\ & & & +1 \end{pmatrix}. \quad (498)$$

We will also consider certain other discrete transformations that are not Lorentz transformations, but are usefully treated together.

Recall from section 2 that for every proper orthochronous Lorentz transformation $\Lambda^\mu{}_\nu$ there is an associated unitary operator $U(\Lambda)$ with the property that

$$U(\Lambda)^{-1}\varphi(x)U(\Lambda) = \varphi(\Lambda^{-1}x). \quad (499)$$

Thus for parity and time-reversal, we expect that there are corresponding unitary operators

$$P \equiv U(\mathcal{P}), \quad (500)$$

$$T \equiv U(\mathcal{T}), \quad (501)$$

such that

$$P^{-1}\varphi(x)P = \varphi(\mathcal{P}x) , \quad (502)$$

$$T^{-1}\varphi(x)T = \varphi(\mathcal{T}x) . \quad (503)$$

There is, however, an extra possible complication. If we make a second parity or time-reversal transformation, we get

$$P^{-2}\varphi(x)P^2 = \varphi(x) , \quad (504)$$

$$T^{-2}\varphi(x)T^2 = \varphi(x) , \quad (505)$$

and so the field returns to itself. Since the field is in principle an observable—it is a hermitian operator—this is required. However, another possibility, different from eqs. (502) and (503) but nevertheless consistent with eqs. (504) and (505), is

$$P^{-1}\varphi(x)P = -\varphi(\mathcal{P}x) , \quad (506)$$

$$T^{-1}\varphi(x)T = -\varphi(\mathcal{T}x) . \quad (507)$$

This possible extra minus sign cannot arise for proper orthochronous Lorentz transformations, because they are continuously connected to the identity, and for the identity transformation (that is, no transformation at all), we must obviously have the plus sign.

If the minus sign appears on the right-hand side, we say that the field is *odd under parity* (or time reversal). If a scalar field is odd under parity, we sometimes say that it is a *pseudoscalar*. [It is still a scalar under proper orthochronous Lorentz transformations; that is, eq. (499) still holds. Thus the appellation *scalar* often means eq. (499), and *either* eq. (502) *or* eq. (506), and that is how we will use the term.]

So, how do we know which is right, eqs. (502) and (503), or eqs. (506) and (507)? The general answer is that we get to choose, but there is a key principle to guide our choice: if at all possible, we want to define P and T so that the lagrangian density is even,

$$P^{-1}\mathcal{L}(x)P = +\mathcal{L}(\mathcal{P}x) , \quad (508)$$

$$T^{-1}\mathcal{L}(x)T = +\mathcal{L}(\mathcal{T}x) . \quad (509)$$

Then, after we integrate over d^4x to get the action S , the action will be invariant. This means that parity and time-reversal are *conserved*.

For theories with spin-zero fields only, it is clear that the choice of eqs. (502) and (503) always leads to eqs. (508) and (509), and so there is no reason to flirt with eqs. (506) and (507). For theories that also include spin-one-half fields, certain scalar bilinears in these fields are necessarily odd under parity and time reversal, as we will see in section 39. If a scalar field couples to such a bilinear, then eqs. (508) and (509) will hold if and only if we choose eqs. (506) and (507) for that scalar, and so that is what we must do.

There is one more interesting fact about the time-reversal operator T : it is *antiunitary*, rather than unitary. *Antiunitary* means that $T^{-1}iT = -i$.

To see why this must be the case, consider a Lorentz transformation of the energy-momentum four-vector,

$$U(\Lambda)^{-1}P^\mu U(\Lambda) = \Lambda^\mu{}_\nu P^\nu . \quad (510)$$

For parity and time-reversal, we therefore expect

$$P^{-1}P^\mu P = \mathcal{P}^\mu{}_\nu P^\nu , \quad (511)$$

$$T^{-1}P^\mu T = \mathcal{T}^\mu{}_\nu P^\nu . \quad (512)$$

In particular, for $\mu = 0$, we expect $P^{-1}HP = +H$ and $T^{-1}HT = -H$. The first of these is fine; it says the hamiltonian is invariant under parity, which is what we want. [It may be that no operator exists that satisfies either eq. (502) or eq. (506), and also eq. (511); in this case we say that parity is *explicitly broken*.] However, eq. (512) is a disaster: it says that the hamiltonian is invariant under time-reversal if and only if $H = -H$. This is clearly untrue for a system whose energy is bounded below and unbounded above, as we always have in a realistic quantum field theory.

Can we just toss in an extra minus sign on the right-hand side of eq. (512), as we did for eq. (507)? The answer is no. We constructed P^μ explicitly in terms of the fields in section 22, and it is easy to check that choosing eq. (507) for the fields does not yield an extra minus sign in eq. (512) for the energy-momentum four-vector.

Let us reconsider the origin of eq. (510). We can derive it from

$$U(\Lambda)^{-1}T(a)U(\Lambda) = T(\Lambda^{-1}a) , \quad (513)$$

where $T(a) = \exp(-iP \cdot a)$ is the spacetime translation operator (not to be confused with the time-reversal operator!), which transforms the field via

$$T(a)^{-1}\varphi(x)T(a) = \varphi(x - a) . \quad (514)$$

We can get eq. (513) (up to a possible phase that turns out to be irrelevant) from

$$\begin{aligned} U(\Lambda)^{-1}T(a)^{-1}U(\Lambda)\varphi(x)U(\Lambda)^{-1}T(a)U(\Lambda) \\ &= U(\Lambda)^{-1}T(a)^{-1}\varphi(\Lambda x)T(a)U(\Lambda) \\ &= U(\Lambda)^{-1}\varphi(\Lambda x - a)U(\Lambda) \\ &= \varphi(x - \Lambda^{-1}a) \\ &= T(\Lambda^{-1}a)^{-1}\varphi(x)T(\Lambda^{-1}a) . \end{aligned} \quad (515)$$

Now, treat a^μ as infinitesimal in eq. (513) to get

$$\begin{aligned} U(\Lambda)^{-1}(I - ia_\mu P^\mu)U(\Lambda) &= I - i(\Lambda^{-1})_\nu{}^\mu a_\mu P^\nu \\ &= I - i\Lambda^\mu{}_\nu a_\mu P^\nu . \end{aligned} \quad (516)$$

For time-reversal, this becomes

$$T^{-1}(I - ia_\mu P^\mu)T = I - iT^\mu{}_\nu a_\mu P^\nu . \quad (517)$$

If we now identify the coefficients of $-ia_\mu$ on each side, we get eq. (512). *But*, we will get that extra minus sign that we need if we impose the antiunitary condition

$$T^{-1}iT = -i . \quad (518)$$

And so that is what we must do.

We turn now to other unitary operators that change the signs of scalar fields, but do nothing to their spacetime arguments. Suppose we have a theory with real scalar fields $\varphi_a(x)$, and a unitary operator Z that obeys

$$Z^{-1}\varphi_a(x)Z = \eta_a\varphi_a(x) , \quad (519)$$

where η_a is either $+1$ or -1 for each field. We will call Z a Z_2 operator, because Z_2 is the additive group of the integers modulo 2, which is equivalent

to the multiplicative group of $+1$ and -1 . This also implies that $Z^2 = 1$, and so $Z^{-1} = Z$. (For theories with spin-zero fields only, the same is also true of P and T , but things are more subtle for higher spin, as we will see in Parts II and III.)

Consider the theory of a complex scalar field $\varphi = (\varphi_1 + i\varphi_2)/\sqrt{2}$ that was introduced in section 22, with lagrangian

$$\mathcal{L} = -\partial^\mu \varphi^\dagger \partial_\mu \varphi - m^2 \varphi^\dagger \varphi - \frac{1}{4} \lambda (\varphi^\dagger \varphi)^2 \quad (520)$$

$$= -\frac{1}{2} \partial^\mu \varphi_1 \partial_\mu \varphi_1 - \frac{1}{2} \partial^\mu \varphi_2 \partial_\mu \varphi_2 - \frac{1}{2} m^2 (\varphi_1^2 + \varphi_2^2) - \frac{1}{16} \lambda (\varphi_1^2 + \varphi_2^2)^2. \quad (521)$$

In the form of eq. (520), \mathcal{L} is obviously invariant under the U(1) transformation

$$\varphi(x) \rightarrow e^{-i\alpha} \varphi(x). \quad (522)$$

In the form of eq. (521), \mathcal{L} is obviously invariant under the equivalent SO(2) transformation,

$$\begin{pmatrix} \varphi_1(x) \\ \varphi_2(x) \end{pmatrix} \rightarrow \begin{pmatrix} \cos \alpha & \sin \alpha \\ -\sin \alpha & \cos \alpha \end{pmatrix} \begin{pmatrix} \varphi_1(x) \\ \varphi_2(x) \end{pmatrix}. \quad (523)$$

However, it is also obvious that \mathcal{L} has an additional discrete symmetry,

$$\varphi(x) \leftrightarrow \varphi^\dagger(x) \quad (524)$$

in the form of eq. (520), or equivalently

$$\begin{pmatrix} \varphi_1(x) \\ \varphi_2(x) \end{pmatrix} \rightarrow \begin{pmatrix} +1 & 0 \\ 0 & -1 \end{pmatrix} \begin{pmatrix} \varphi_1(x) \\ \varphi_2(x) \end{pmatrix}. \quad (525)$$

in the form of eq. (521). This discrete symmetry is called *charge conjugation*. It always occurs as a companion to a continuous U(1) symmetry. In terms of the two real fields, it enlarges the group from SO(2) (the group of 2×2 orthogonal matrices with determinant $+1$) to O(2) (the group of 2×2 orthogonal matrices).

We can implement charge conjugation by means of a particular Z_2 operator C that obeys

$$C^{-1} \varphi(x) C = \varphi^\dagger(x), \quad (526)$$

or equivalently

$$C^{-1}\varphi_1(x)C = +\varphi_1(x) , \quad (527)$$

$$C^{-1}\varphi_2(x)C = -\varphi_2(x) . \quad (528)$$

We then have

$$C^{-1}\mathcal{L}(x)C = \mathcal{L}(x) , \quad (529)$$

and so charge conjugation is a symmetry of the theory. Physically, it implies that the scattering amplitudes are unchanged if we exchange all the a -type particles (which have charge $+1$) with all the b -type particles (which have charge -1). This means, in particular, that the a and b particles must have exactly the same mass. We say that b is a 's *antiparticle*.

More generally, we can also have Z_2 symmetries that are not related to antiparticles. Consider, for example, φ^4 theory, where φ is a real scalar field with lagrangian

$$\mathcal{L} = -\frac{1}{2}\partial^\mu\varphi\partial_\mu\varphi - \frac{1}{2}m^2\varphi^2 - \frac{1}{24}\lambda\varphi^4 . \quad (530)$$

If we define the Z_2 operator Z via

$$Z^{-1}\varphi(x)Z = -\varphi(x) , \quad (531)$$

then \mathcal{L} is obviously invariant. We therefore have $Z^{-1}HZ = H$, or equivalently $[Z, H] = 0$, where H is the hamiltonian. If we assume that (as usual) the ground state is unique, then, since Z commutes with H , the ground state must also be an eigenstate of Z . We can fix the phase of Z [which is undetermined by eq. (531)] via

$$Z|0\rangle = Z^{-1}|0\rangle = +|0\rangle . \quad (532)$$

Then, using eqs. (531) and (532), we have

$$\begin{aligned} \langle 0|\varphi(x)|0\rangle &= \langle 0|ZZ^{-1}\varphi(x)ZZ^{-1}|0\rangle \\ &= -\langle 0|\varphi(x)|0\rangle . \end{aligned} \quad (533)$$

Since $\langle 0|\varphi(x)|0\rangle$ is equal to minus itself, it must be zero. Thus, as long as the ground state is unique, *the Z_2 symmetry of φ^4 theory guarantees that the field has zero vacuum expectation value*. We therefore do not need to enforce this condition with a counterterm $Y\varphi$, as we did in φ^3 theory. (The assumption of a unique ground state does not necessarily hold, however, as we will see in section 28.)

24: Unstable Particles and Resonances

Prerequisite: 10, 14

Consider a theory of two real scalar fields, φ and χ , with lagrangian

$$\mathcal{L} = -\frac{1}{2}\partial^\mu\varphi\partial_\mu\varphi - \frac{1}{2}m_\varphi^2\varphi^2 - \frac{1}{2}\partial^\mu\chi\partial_\mu\chi - \frac{1}{2}m_\chi^2\chi^2 + \frac{1}{2}g\varphi\chi^2 + \frac{1}{6}h\varphi^3, \quad (534)$$

This theory is renormalizable in six dimensions, where g and h are dimensionless coupling constants.

Let us assume that $m_\varphi > 2m_\chi$. Then it is kinematically possible for the φ particle to decay into two χ particles. The amplitude for this process is given at tree level by the Feynman diagram of fig. (29), and is simply $\mathcal{T} = g$. We can also choose to work in an on-shell renormalization scheme in which we define g by saying that the exact $\varphi\chi^2$ vertex function $\mathbf{V}_3(k, k'_1, k'_2)$ equals g when all three particles are on shell: $k^2 = -m_\varphi^2$, $k_1'^2 = k_2'^2 = -m_\chi^2$. This implies that

$$\mathcal{T} = g \quad (535)$$

exactly.

According to the formulae of section 11, the differential decay rate (in the rest frame of the initial φ particle) is

$$d\Gamma = \frac{1}{2m_\varphi} d\text{LIPS}_2 |\mathcal{T}|^2, \quad (536)$$

where $d\text{LIPS}_2$ is the Lorentz invariant phase space differential for two outgoing particles, introduced in section 11. We must make a slight adaptation for six dimensions:

$$d\text{LIPS}_2 \equiv (2\pi)^6 \delta^6(k'_1 + k'_2 - k) \widetilde{dk}'_1 \widetilde{dk}'_2. \quad (537)$$

Here $k = (m_\varphi, \mathbf{0})$ is the energy-momentum of the decaying particle, and

$$\widetilde{dk} = \frac{d^5k}{(2\pi)^5 2\omega} \quad (538)$$

is the Lorentz-invariant phase-space differential for one particle. Recall that we can also write it as

$$\widetilde{dk} = \frac{d^6k}{(2\pi)^6} 2\pi\delta(k^2 + m_\chi^2) \theta(k^0), \quad (539)$$

where $\theta(x)$ is the unit step function. Performing the integral over k^0 turns eq. (539) into eq. (538).

Repeating for six dimensions what we did in section 11 for four dimensions, we find

$$d\text{LIPS}_2 = \frac{|\mathbf{k}'_1|^3}{4(2\pi)^4 m_\varphi} d\Omega, \quad (540)$$

where $|\mathbf{k}'_1| = \frac{1}{2}(m_\varphi^2 - 4m_\chi^2)^{1/2}$ is the magnitude of the spatial momentum of one of the outgoing particles. We can now plug this into eq. (536), and integrate $\int d\Omega = \Omega_5 = 2\pi^{5/2}/\Gamma(\frac{5}{2}) = \frac{8}{3}\pi^2$. We also need a symmetry factor of one half, due to the presence of two identical particles in the final state. The result is

$$\Gamma = \frac{1}{2} \cdot \frac{1}{2m_\varphi} \int d\text{LIPS}_2 |\mathcal{T}|^2 \quad (541)$$

$$= \frac{1}{12}\pi\alpha(1 - 4m_\chi^2/m_\varphi^2)^{3/2} m_\varphi, \quad (542)$$

where $\alpha = g^2/(4\pi)^3$.

However, as we discussed in section 11, we have a conceptual problem. According to our development of the LSZ formula in section 5, each incoming and outgoing particle should correspond to a single-particle state that is an exact eigenstate of the exact hamiltonian. This is clearly not the case for a particle that can decay.

Let us, then, compute something else instead: the correction to the φ propagator from a loop of χ particles, as shown in fig. (30). The diagram is the same as the one we already analyzed in section 14, except that the internal propagators contain m_χ instead of m_φ . (There is also a contribution

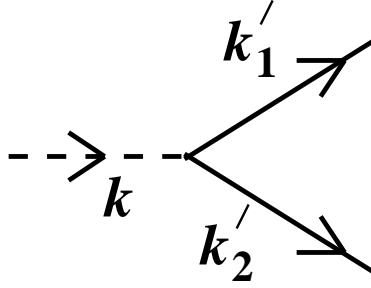

Figure 29: The tree-level Feynman diagram for the decay of a φ particle (dashed line) into two χ particles (solid lines).

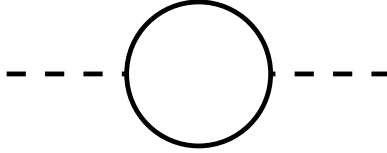

Figure 30: A loop of χ particles correcting the φ propagator.

from a loop of φ particles, but we can ignore it if we assume that $h \ll g$.) We have

$$\Pi(k^2) = \frac{1}{2}\alpha \int_0^1 dx D \ln D - A'k^2 - B'm_\varphi^2, \quad (543)$$

where

$$D = x(1-x)k^2 + m_\chi^2 - i\epsilon, \quad (544)$$

and A' and B' are the finite counterterm coefficients that remain after the infinities have been absorbed. We now try to fix A' and B' by imposing the usual on-shell conditions $\Pi(-m_\varphi^2) = 0$ and $\Pi'(-m_\varphi^2) = 0$.

But, we have a problem. For $k^2 = -m_\varphi^2$ and $m_\varphi > 2m_\chi$, D is negative for part of the range of x . Therefore $\ln D$ has an imaginary part. This imaginary part cannot be canceled by A' and B' , since A' and B' must be real: they are coefficients of hermitian operators in the lagrangian. The best we can do is $\text{Re} \Pi(-m_\varphi^2) = 0$ and $\text{Re} \Pi'(-m_\varphi^2) = 0$. Imposing these gives

$$\Pi(k^2) = \frac{1}{2}\alpha \int_0^1 dx D \ln(D/|D_0|) - \frac{1}{12}\alpha(k^2 + m_\varphi^2), \quad (545)$$

where

$$D_0 = -x(1-x)m_\varphi^2 + m_\chi^2. \quad (546)$$

Now let us compute the imaginary part of $\Pi(k^2)$. This arises from the integration range $x_- < x < x_+$, where $x_\pm = \frac{1}{2} \pm \frac{1}{2}(1 + m_\chi^2/k^2)^{1/2}$ are the roots of $D = 0$ when $k^2 < -4m_\chi^2$. In this range, $\text{Im} \ln D = -i\pi$; the minus sign arises because, according to eq. (544), D has a small negative imaginary part. Now we have

$$\begin{aligned} \text{Im} \Pi(k^2) &= -\frac{1}{2}\pi\alpha \int_{x_-}^{x_+} dx D \\ &= -\frac{1}{12}\pi\alpha(1 + 4m_\chi^2/k^2)^{3/2} k^2 \end{aligned} \quad (547)$$

when $k^2 < -4m_\chi^2$. Evaluating eq. (547) at $k^2 = -m_\varphi^2$, we get

$$\text{Im} \Pi(-m_\varphi^2) = \frac{1}{12}\pi\alpha(1 - 4m_\chi^2/m_\varphi^2)^{3/2} m_\varphi^2. \quad (548)$$

From this and eq. (542), we see that

$$\text{Im} \Pi(-m_\varphi^2) = m_\varphi \Gamma. \quad (549)$$

This is not an accident. Instead, it is a general rule. We will argue this in two ways: first, from the mathematics of Feynman diagrams, and second, from the physics of resonant scattering in quantum mechanics.

We begin with the mathematics of Feynman diagrams. Return to the diagrammatic expression for $\Pi(k^2)$, before we evaluated any of the integrals:

$$\begin{aligned} \Pi(k^2) &= -\frac{1}{2}ig^2 \int \frac{d^6\ell_1}{(2\pi)^6} \frac{d^6\ell_2}{(2\pi)^6} (2\pi)^6 \delta^6(\ell_1 + \ell_2 - k) \\ &\quad \times \frac{1}{\ell_1^2 + m_\chi^2 - i\epsilon} \frac{1}{\ell_2^2 + m_\chi^2 - i\epsilon} \\ &\quad - (Ak^2 + Bm_\varphi^2). \end{aligned} \quad (550)$$

Here, for later convenience, we have assigned the internal lines momenta ℓ_1 and ℓ_2 , and explicitly included the momentum-conserving delta function that fixes one of them. We can take the imaginary part of $\Pi(k^2)$ by using the identity

$$\frac{1}{x - i\epsilon} = P\frac{1}{x} + i\pi\delta(x), \quad (551)$$

where P means the principal part. We then get, in a shorthand notation,

$$\text{Im } \Pi(k^2) = -\frac{1}{2}g^2 \int (P_1 P_2 - \pi^2 \delta_1 \delta_2) . \quad (552)$$

Next, we notice that the integral in eq. (550) is the real part of the Fourier transform of $[\Delta(x-y)]^2$, where

$$\Delta(x-y) = \int \frac{d^6 k}{(2\pi)^6} \frac{e^{ik(x-y)}}{k^2 + m_\chi^2 - i\epsilon} \quad (553)$$

is the Feynman propagator. Recall (from problem 8.4) that we can get the retarded or advanced propagator (rather than the Feynman propagator) by replacing the ϵ in eq. (553) with, respectively, $-\epsilon$ or $+\epsilon$, where $s \equiv \text{sign}(k^0)$. Therefore, in eq. (552), replacing δ_1 with $-s_1 \delta_1$ and δ_2 with $+s_2 \delta_2$ yields an integral that is the real part of the Fourier transform of $\Delta_{\text{ret}}(x-y) \Delta_{\text{adv}}(x-y)$. But this product is zero, because the first factor vanishes when $x^0 \geq y^0$, and the second when $x^0 \leq y^0$. So we can subtract the modified integrand from the original without changing the value of the integral. Thus we have

$$\text{Im } \Pi(k^2) = \frac{1}{2}g^2 \pi^2 \int (1 + s_1 s_2) \delta_1 \delta_2 . \quad (554)$$

The factor of $1 + s_1 s_2$ vanishes if ℓ_1^0 and ℓ_2^0 have opposite signs, and equals 2 if they have the same sign. Because the delta function in eq. (550) enforces $\ell_1^0 + \ell_2^0 = k^0$, and $k^0 = m_\varphi$ is positive, both ℓ_1^0 and ℓ_2^0 must be positive. So we can replace the factor of $1 + s_1 s_2$ in eq. (554) with $2\theta_1 \theta_2$, where $\theta_i = \theta(\ell_i^0)$. Rearranging the numerical factors, we have

$$\begin{aligned} \text{Im } \Pi(k^2) &= \frac{1}{4}g^2 \int \frac{d^6 \ell_1}{(2\pi)^6} \frac{d^6 \ell_2}{(2\pi)^6} (2\pi)^6 \delta^6(\ell_1 + \ell_2 - k) \\ &\quad \times 2\pi \delta(\ell_1^2 + m_\chi^2) \theta(\ell_1^0) 2\pi \delta(\ell_2^2 + m_\chi^2) \theta(\ell_2^0) . \end{aligned} \quad (555)$$

If we now set $k^2 = -m_\varphi^2$, use eqs. (537) and (539), and recall that $\mathcal{T} = g$ is the decay amplitude, we can rewrite eq. (555) as

$$\text{Im } \Pi(-m_\varphi^2) = \frac{1}{4} \int d\text{LIPS}_2 |\mathcal{T}|^2 . \quad (556)$$

Comparing eqs. (541) and (556), we see that we indeed have

$$\text{Im } \Pi(-m_\varphi^2) = m_\varphi \Gamma . \quad (557)$$

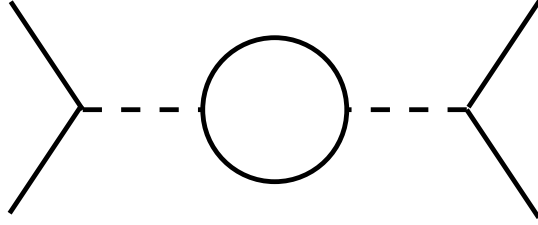

Figure 31: $\chi\chi$ scattering with an intermediate φ propagator in the s -channel.

This relation persists at higher orders in perturbation theory. Our analysis can be generalized to give the *Cutkosky rules* for computing the imaginary part of any Feynman diagram, but this is beyond the scope of our current interest.

To get a more physical understanding of this result, recall that in nonrelativistic quantum mechanics, a metastable state with energy E_0 and angular momentum quantum number ℓ shows up as a *resonance* in the partial-wave scattering amplitude,

$$f_\ell(E) \sim \frac{1}{E - E_0 + i\Gamma/2}. \quad (558)$$

If we imagine convolving this amplitude with a wave packet $\tilde{\psi}(E)e^{-iEt}$, we will find a time dependence

$$\begin{aligned} \psi(t) &\sim \int dE \frac{1}{E - E_0 + i\Gamma/2} \tilde{\psi}(E)e^{-iEt} \\ &\sim e^{-iE_0t - \Gamma t/2}. \end{aligned} \quad (559)$$

Therefore $|\psi(t)|^2 \sim e^{-\Gamma t}$, and we identify Γ as the inverse lifetime of the metastable state.

In the relativistic case, consider the scattering $\chi\chi \rightarrow \chi\chi$ with an intermediate φ propagator, as shown in fig. (31). In this case we have

$$\mathcal{T} = \frac{g^2}{-s + m_\varphi^2 - \Pi(-s)} + (s \rightarrow t) + (s \rightarrow u). \quad (560)$$

If s is close m_φ^2 , we can ignore vertex corrections, because we have chosen a renormalization scheme in which these vanish when all particles are on shell.

Let us, then, tune the center-of-mass energy squared s to be close to m_φ^2 . Specifically, let

$$s = (m_\varphi + \varepsilon)^2 \simeq m_\varphi^2 + 2m_\varphi\varepsilon , \quad (561)$$

where $\varepsilon \ll m_\varphi$ is the amount of energy by which our incoming particles are *off resonance*. We then have

$$\mathcal{T} \simeq \frac{-g^2/2m_\varphi}{\varepsilon + \Pi(-m_\varphi^2)/2m_\varphi} . \quad (562)$$

Recalling that $\text{Re}\Pi(-m_\varphi^2) = 0$, and comparing with eq. (558), we see that we should make the identification of eq. (557).

25: Infrared Divergences

Prerequisite: 20

In section 20, we computed the $\varphi\varphi \rightarrow \varphi\varphi$ scattering amplitude in ϕ^3 theory in six dimensions in the high-energy limit (s , $|t|$, and $|u|$ all much larger than m^2). We found that

$$\mathcal{T} = \mathcal{T}_0 \left[1 - \frac{11}{12}\alpha \left(\ln(s/m^2) + O(m^0) \right) + O(\alpha^2) \right], \quad (563)$$

where $\mathcal{T}_0 = -g^2(s^{-1} + t^{-1} + u^{-1})$ is the tree-level result, and the $O(m^0)$ term includes everything without a *large logarithm* that blows up in the limit $m \rightarrow 0$. [In writing \mathcal{T} in this form, we have traded factors of $\ln t$ and $\ln u$ for $\ln s$ by first using $\ln t = \ln s + \ln(t/s)$, and then hiding the $\ln(t/s)$ terms in the $O(m^0)$ catchall.]

Suppose we are interested in the limit of massless particles. The large log is then problematic, since it blows up in this limit. What does this mean?

It means we have made a mistake. Actually, two mistakes. In this section, we will remedy one of them.

Throughout the physical sciences, it is necessary to make various idealizations of problems in order to make progress (recall the “massless springs” and “frictionless planes” of freshman mechanics). Sometimes these idealizations can lead us into trouble, and that is one of the things that has gone wrong here.

We have assumed that we can isolate individual particles. The reasoning behind this was carefully explained in section 5. However, our reasoning breaks down in the massless limit. In this case, it is possible that the scattering process involved the creation of some extra very low energy (or *soft*) particles that escaped detection. Or, there may have been some extra soft

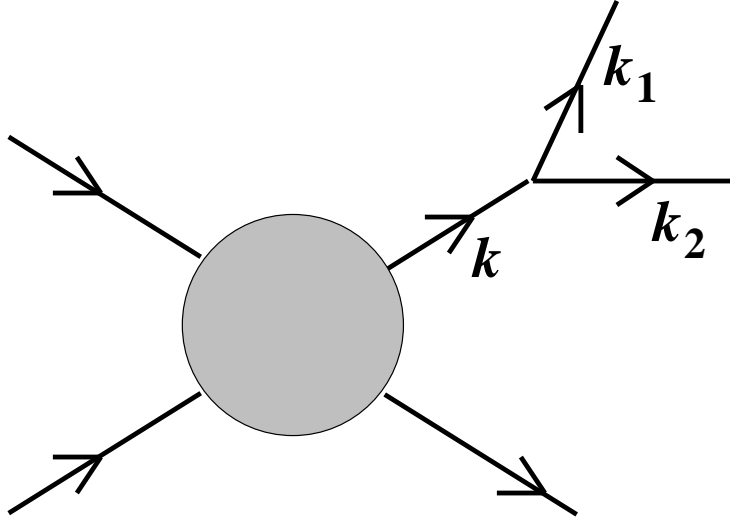

Figure 32: An outgoing particle splits into two. The gray circle stands for the sum of all diagrams contributing to the original amplitude $i\mathcal{T}$.

particles hiding in the initial state that discreetly participated in the scattering process. Or, what was seen as a single high-energy particle may actually have been two or more particles that were moving collinearly and sharing the energy.

Let us, then, correct our idealization of a perfect detector and account for these possibilities. We will work with φ^3 theory, initially in d spacetime dimensions.

Let \mathcal{T} be the amplitude for some scattering process in φ^3 theory. Now consider the possibility that one of the outgoing particles in this process splits into two, as shown in fig. (32). The amplitude for this new process is given in terms of \mathcal{T} by

$$\mathcal{T}_{\text{split}} = ig \frac{-i}{k^2 + m^2} \mathcal{T} , \quad (564)$$

where $k = k_1 + k_2$, and k_1 and k_2 are the on-shell four-momenta of the two particles produced by the split. (For notational convenience, we drop our usual primes on the outgoing momenta.) The key point is this: in the massless limit, it is possible for $1/(k^2 + m^2)$ to diverge.

To understand the physical consequences of this possibility, we should compute an appropriate cross-section. To get the cross section for the original process (without the split), we multiply $|\mathcal{T}|^2$ by \widetilde{dk} (as well as by similar differentials for other outgoing particles, and by an overall energy-momentum delta function). For the process with the split, we multiply $|\mathcal{T}_{\text{split}}|^2$ by $\frac{1}{2}\widetilde{dk}_1\widetilde{dk}_2$ instead of \widetilde{dk} . (The factor of one-half is for counting of identical particles.) If we assume that (due to some imperfection) our detector cannot tell whether or not the one particle actually split into two, then we should (according to the usual rules of quantum mechanics) add the probabilities for the two events, which are distinguishable in principle. We can therefore define an effectively observable squared-amplitude via

$$|\mathcal{T}|_{\text{obs}}^2 \widetilde{dk} = |\mathcal{T}|^2 \widetilde{dk} + |\mathcal{T}_{\text{split}}|^2 \frac{1}{2}\widetilde{dk}_1\widetilde{dk}_2 + \dots \quad (565)$$

Here the ellipses stand for all other similar processes involving emission of one or more extra particles in the final state, or absorption of one or more extra particles in the initial state. We can simplify eq. (565) by including a factor of

$$1 = (2\pi)^{d-1} 2\omega \delta^{d-1}(\mathbf{k}_1 + \mathbf{k}_2 - \mathbf{k}) \widetilde{dk} \quad (566)$$

in the second term. Now all terms in eq. (565) include a factor of \widetilde{dk} , so we can drop it. Then, using eq. (564), we get

$$|\mathcal{T}|_{\text{obs}}^2 \equiv |\mathcal{T}|^2 \left[1 + \frac{g^2}{(k^2 + m^2)^2} (2\pi)^{d-1} 2\omega \delta^{d-1}(\mathbf{k}_1 + \mathbf{k}_2 - \mathbf{k}) \frac{1}{2}\widetilde{dk}_1\widetilde{dk}_2 + \dots \right]. \quad (567)$$

Now we come to the point: in the massless limit, the phase space integral in the second term in eq. (567) can diverge. This is because, for $m = 0$,

$$k^2 = (k_1 + k_2)^2 = -4\omega_1\omega_2 \sin^2(\theta/2), \quad (568)$$

where θ is the angle between the spatial momenta \mathbf{k}_1 and \mathbf{k}_2 , and $\omega_{1,2} = |\mathbf{k}_{1,2}|$. Also, for $m = 0$,

$$\widetilde{dk}_1\widetilde{dk}_2 \sim (\omega_1^{d-3} d\omega_1) (\omega_2^{d-3} d\omega_2) (\sin^{d-3} \theta d\theta). \quad (569)$$

Therefore, for small θ ,

$$\frac{\widetilde{dk}_1\widetilde{dk}_2}{(k^2)^2} \sim \frac{d\omega_1}{\omega_1^{5-d}} \frac{d\omega_2}{\omega_2^{5-d}} \frac{d\theta}{\theta^{7-d}}. \quad (570)$$

Thus the integral over each ω diverges at the low end for $d \leq 4$, and the integral over θ diverges at the low end for $d \leq 6$. These divergent integrals would be cut off (and rendered finite) if we kept the mass m nonzero, as we will see below.

Our discussion leads us to expect that the $m \rightarrow 0$ divergence in the second term of eq.(567) should *cancel* the $m \rightarrow 0$ divergence in the loop correction to $|\mathcal{T}|^2$. We will now see how this works (or fails to work) in detail for the familiar case of two-particle scattering in six spacetime dimensions, where \mathcal{T} is given by eq.(563). For $d = 6$, there is no problem with soft particles (corresponding to the small- ω divergence), but there is a problem with collinear particles (corresponding to the small- θ divergence).

Let us assume that our imperfect detector cannot tell one particle from two nearly collinear particles if the angle θ between their spatial momenta is less than some small angle δ . Since we ultimately want to take the $m \rightarrow 0$ limit, we will evaluate eq.(567) with $m^2/\mathbf{k}^2 \ll \delta^2 \ll 1$.

We can immediately integrate over d^5k_2 using the delta function, which results in setting $\mathbf{k}_2 = \mathbf{k} - \mathbf{k}_1$ everywhere. Let β then be the angle between \mathbf{k}_1 (which is still to be integrated over) and \mathbf{k} (which is fixed). For two-particle scattering, $|\mathbf{k}| = \frac{1}{2}\sqrt{s}$ in the limit $m \rightarrow 0$. We then have

$$(2\pi)^5 2\omega \delta^5(\mathbf{k}_1 + \mathbf{k}_2 - \mathbf{k}) \frac{1}{2} \widetilde{dk}_1 \widetilde{dk}_2 \rightarrow \frac{\Omega_4}{4(2\pi)^5} \frac{\omega}{\omega_1 \omega_2} |\mathbf{k}_1|^4 d|\mathbf{k}_1| \sin^3 \beta d\beta, \quad (571)$$

where $\Omega_4 = 2\pi^2$ is the area of the unit four-sphere. Now let γ be the angle between \mathbf{k}_2 and \mathbf{k} . The geometry of this trio of vectors implies $\theta = \beta + \gamma$, $|\mathbf{k}_1| = (\sin \gamma / \sin \theta) |\mathbf{k}|$, and $|\mathbf{k}_2| = (\sin \beta / \sin \theta) |\mathbf{k}|$. All three of the angles are small and positive, and it then is useful to write $\beta = x\theta$ and $\gamma = (1-x)\theta$, with $0 \leq x \leq 1$ and $\theta \leq \delta \ll 1$.

In the low mass limit, we can safely set $m = 0$ everywhere in eq.(567) except in the propagator, $1/(k^2 + m^2)$. Then, expanding to leading order in both θ and m , we find (after some algebra)

$$k^2 + m^2 \simeq -x(1-x)\mathbf{k}^2 \left[\theta^2 + (m^2/\mathbf{k}^2)f(x) \right], \quad (572)$$

where $f(x) = (1-x+x^2)/(x-x^2)^2$. Everywhere else in eq.(567), we can safely set $\omega_1 = |\mathbf{k}_1| = (1-x)|\mathbf{k}|$ and $\omega_2 = |\mathbf{k}_2| = x|\mathbf{k}|$. Then, changing the

integration variables in eq. (571) from $|\mathbf{k}_1|$ and β to x and θ , we get

$$|\mathcal{T}|_{\text{obs}}^2 = |\mathcal{T}|^2 \left[1 + \frac{g^2 \Omega_4}{4(2\pi)^5} \int_0^1 x(1-x) dx \int_0^\delta \frac{\theta^3 d\theta}{[\theta^2 + (m^2/\mathbf{k}^2)f(x)]^2} + \dots \right]. \quad (573)$$

Performing the integral over θ yields

$$\frac{1}{2} \ln(\delta^2 \mathbf{k}^2 / m^2) - \frac{1}{2} \ln f(x) - \frac{1}{2}. \quad (574)$$

Then, performing the integral over x and using $\Omega_4 = 2\pi^2$ and $\alpha = g^2/(4\pi)^3$, we get

$$|\mathcal{T}|_{\text{obs}}^2 = |\mathcal{T}|^2 \left[1 + \frac{1}{12} \alpha (\ln(\delta^2 \mathbf{k}^2 / m^2) + c) + \dots \right], \quad (575)$$

where $c = (4 - 3\sqrt{3}\pi)/36 = -0.34$.

The displayed correction term accounts for the possible splitting of *one* of the two outgoing particles. Obviously, there is an identical correction for the other outgoing particle. Less obviously (but still true), there is an identical correction for each of the two incoming particles. (A glib explanation is that we are computing an effective amplitude-squared, and this is the same for the reverse process, with in and outgoing particles switched. So in and out particles should be treated symmetrically.) Then, since we have a total of four in and out particles (before accounting for any splitting),

$$|\mathcal{T}|_{\text{obs}}^2 = |\mathcal{T}|^2 \left[1 + \frac{4}{12} \alpha (\ln(\delta^2 \mathbf{k}^2 / m^2) + c) + O(\alpha^2) \right]. \quad (576)$$

We have now accounted for the $O(\alpha)$ corrections due to the failure of our detector to separate two particles whose spatial momenta are nearly parallel. Combining this with eq. (563), and recalling that $\mathbf{k}^2 = \frac{1}{4}s$, we get

$$\begin{aligned} |\mathcal{T}|_{\text{obs}}^2 &= |\mathcal{T}_0|^2 \left[1 - \frac{11}{6} \alpha (\ln(s/m^2) + O(m^0)) + O(\alpha^2) \right] \\ &\quad \times \left[1 + \frac{1}{3} \alpha (\ln(\delta^2 s/m^2) + O(m^0)) + O(\alpha^2) \right] \\ &= |\mathcal{T}_0|^2 \left[1 - \alpha \left(\frac{3}{2} \ln(s/m^2) + \frac{1}{3} \ln(1/\delta^2) + O(m^0) \right) \right. \\ &\quad \left. + O(\alpha^2) \right]. \end{aligned} \quad (577)$$

We now have two kinds of large logs. One is $\ln(1/\delta^2)$; this factor depends on the properties of our detector. If we build a very good detector, one

for which $\alpha \ln(1/\delta^2)$ is not small, then we will have to do more work, and calculate higher-order corrections to eq. (577).

The other large log is our original nemesis $\ln(s/m^2)$. This factor blows up in the massless limit. This means that there is still a mistake hidden somewhere in our analysis.

26: Other Renormalization Schemes

Prerequisite: 25

To find the remaining mistake in eq. (577), we must review our renormalization procedure. Recall our result from section 14 for the one-loop correction to the propagator,

$$\begin{aligned} \Pi(k^2) = & - \left[A + \frac{1}{6}\alpha \left(\frac{1}{\varepsilon} + \frac{1}{2} \right) \right] k^2 - \left[B + \alpha \left(\frac{1}{\varepsilon} + \frac{1}{2} \right) \right] m^2 \\ & + \frac{1}{2}\alpha \int_0^1 dx D \ln(D/\mu^2) + O(\alpha^2), \end{aligned} \quad (578)$$

where $\alpha = g^2/(4\pi)^3$ and $D = x(1-x)k^2 + m^2$. The derivative of $\Pi(k^2)$ with respect to k^2 is

$$\begin{aligned} \Pi'(k^2) = & - \left[A + \frac{1}{6}\alpha \left(\frac{1}{\varepsilon} + \frac{1}{2} \right) \right] \\ & + \frac{1}{2}\alpha \int_0^1 dx x(1-x) \left[\ln(D/\mu^2) + 1 \right] + O(\alpha^2). \end{aligned} \quad (579)$$

We previously determined A and B via the requirements $\Pi(-m^2) = 0$ and $\Pi'(-m^2) = 0$. The first condition ensures that the exact propagator $\tilde{\Delta}(k^2)$ has a pole at $k^2 = -m^2$, and the second ensures that the residue of this pole is one. Recall that the field must be normalized in this way for the validity of the LSZ formula.

We now consider the massless limit. We have $D = x(1-x)k^2$, and we should apparently try to impose $\Pi(0) = \Pi'(0) = 0$. However, $\Pi(0)$ is now automatically zero for any values of A and B , while $\Pi'(0)$ is ill defined.

Physically, the problem is that the one-particle states are no longer separated from the multiparticle continuum by a finite gap in energy. Mathematically, the pole in $\tilde{\Delta}(k^2)$ at $k^2 = -m^2$ merges with the branch point at $k^2 = -4m^2$, and is no longer a simple pole.

The only way out of this difficulty is to change the *renormalization scheme*. Let us first see what this means in the case $m \neq 0$, where we know what we are doing.

Let us try making a different choice of A and B . Specifically, let

$$\begin{aligned} A &= -\frac{1}{6}\alpha\frac{1}{\varepsilon} + O(\alpha^2) , \\ B &= -\alpha\frac{1}{\varepsilon} + O(\alpha^2) . \end{aligned} \tag{580}$$

Here we have chosen A and B to cancel the infinities, and nothing more; we say that A and B have no *finite parts*. This choice represents a different *renormalization scheme*. Our original choice (which, up until now, we have pretended was inescapable!) is called the *on-shell* or OS scheme. The choice of eq. (580) is called the *modified minimal-subtraction* or $\overline{\text{MS}}$ (pronounced “emm-ess-bar”) scheme. [“Modified” because we introduced μ via $g \rightarrow g\tilde{\mu}^{\varepsilon/2}$, with $\mu^2 = 4\pi e^{-\gamma}\tilde{\mu}^2$; had we set $\mu = \tilde{\mu}$ instead, the scheme would be just plain *minimal subtraction* or MS.] Now we have

$$\Pi_{\overline{\text{MS}}}(k^2) = -\frac{1}{12}\alpha(k^2 + 6m^2) + \frac{1}{2}\alpha \int_0^1 dx D \ln(D/\mu^2) + O(\alpha^2) , \tag{581}$$

as compared to our old result in the on-shell scheme,

$$\Pi_{\text{OS}}(k^2) = -\frac{1}{12}\alpha(k^2 + m^2) + \frac{1}{2}\alpha \int_0^1 dx D \ln(D/D_0) + O(\alpha^2) , \tag{582}$$

where again $D = x(1-x)k^2 + m^2$, and $D_0 = [-x(1-x)+1]m^2$. Notice that $\Pi_{\overline{\text{MS}}}(k^2)$ has a well-defined $m \rightarrow 0$ limit, whereas $\Pi_{\text{OS}}(k^2)$ does not. On the other hand, $\Pi_{\overline{\text{MS}}}(k^2)$ depends explicitly on the fake parameter μ , whereas $\Pi_{\text{OS}}(k^2)$ does not.

What does this all mean?

First, in the $\overline{\text{MS}}$ scheme, the propagator $\Delta_{\overline{\text{MS}}}(k^2)$ will no longer have a pole at $k^2 = -m^2$. The pole will be somewhere else. However, *by definition*, the actual physical mass m_{ph} of the particle is determined by the location of this pole: $k^2 = -m_{\text{ph}}^2$. Thus, the lagrangian parameter m is no longer the same as m_{ph} .

Furthermore, the residue of this pole is no longer one. Let us call the residue R . The LSZ formula must now be corrected by multiplying its right-

hand side by a factor of $R^{-1/2}$ for each external particle (incoming or outgoing). This is because it is the field $R^{-1/2}\varphi(x)$ that now has unit amplitude to create a one-particle state.

Note also that, in the LSZ formula, each Klein-Gordon wave operator should be $-\partial^2 + m_{\text{ph}}^2$, and not $-\partial^2 + m^2$; also, each external four-momentum should square to $-m_{\text{ph}}^2$, and not $-m^2$. A review of the derivation of the LSZ formula clearly shows that each of these mass parameters must be the actual particle mass, and not the parameter in the lagrangian.

Finally, in the LSZ formula, each external line will contribute a factor of R when the associated Klein-Gordon wave operator hits the external propagator and cancels its momentum-space pole, leaving behind the residue R . Combined with the correction factor of $R^{-1/2}$ for each field, we get a net factor of $R^{1/2}$ for each external line when using the $\overline{\text{MS}}$ scheme. Internal lines each contribute a factor of $(-i)/(k^2 + m^2)$, where m is the lagrangian-parameter mass, and each vertex contributes a factor of $iZ_g g$, where g is the lagrangian-parameter coupling.

Let us now compute the relation between m and m_{ph} , and then compute R . We have

$$\Delta_{\overline{\text{MS}}}(k^2)^{-1} = k^2 + m^2 - \Pi_{\overline{\text{MS}}}(k^2), \quad (583)$$

and, by definition,

$$\Delta_{\overline{\text{MS}}}(-m_{\text{ph}}^2)^{-1} = 0. \quad (584)$$

Setting $k^2 = -m_{\text{ph}}^2$ in eq. (583), using eq. (584), and rearranging, we find

$$m_{\text{ph}}^2 = m^2 - \Pi_{\overline{\text{MS}}}(-m_{\text{ph}}^2). \quad (585)$$

Since $\Pi_{\overline{\text{MS}}}(k^2)$ is $O(\alpha)$, we see that the difference between m_{ph}^2 and m^2 is $O(\alpha)$. Therefore, on the right-hand side, we can replace m_{ph}^2 with m^2 , and only make an error of $O(\alpha^2)$. Thus

$$m_{\text{ph}}^2 = m^2 - \Pi_{\overline{\text{MS}}}(-m^2) + O(\alpha^2). \quad (586)$$

Working this out, we get

$$m_{\text{ph}}^2 = m^2 - \frac{1}{2}\alpha \left[\frac{1}{6}m^2 - m^2 + \int_0^1 dx D_0 \ln(D_0/\mu^2) \right] + O(\alpha^2), \quad (587)$$

where $D_0 = [1-x(1-x)]m^2$. Doing the integrals yields

$$m_{\text{ph}}^2 = m^2 \left[1 + \frac{5}{12}\alpha \left(\ln(\mu^2/m^2) + c' \right) + O(\alpha^2) \right]. \quad (588)$$

where $c' = (34 - 3\pi\sqrt{3})/15 = 1.18$.

Now, physics should be independent of the fake parameter μ . However, the right-hand side of eq. (588) depends explicitly on μ . It must, be, then, that m and α take on different numerical values as μ is varied, in just the right way to leave physical quantities (like m_{ph}) unchanged.

We can use this information to find differential equations that tell us how m and α change with μ . For example, take the logarithm of eq. (588) and divide by two to get

$$\ln m_{\text{ph}} = \ln m + \frac{5}{12}\alpha \left(\ln(\mu/m) + \frac{1}{2}c' \right) + O(\alpha^2). \quad (589)$$

Now differentiate with respect to $\ln \mu$ and require m_{ph} to remain fixed:

$$\begin{aligned} 0 &= \frac{d}{d \ln \mu} \ln m_{\text{ph}} \\ &= \frac{1}{m} \frac{dm}{d \ln \mu} + \frac{5}{12}\alpha + O(\alpha^2). \end{aligned} \quad (590)$$

To get the second line, we had to assume that $d\alpha/d \ln \mu = O(\alpha^2)$, which we will verify shortly. Then, rearranging eq. (590) gives

$$\frac{dm}{d \ln \mu} = \left(-\frac{5}{12}\alpha + O(\alpha^2) \right) m. \quad (591)$$

The factor in large parentheses on the right is called the *anomalous dimension* of the mass parameter, and it is often given the name $\gamma_m(\alpha)$.

Turning now to the residue R , we have

$$R^{-1} = \frac{d}{dk^2} \left[\Delta_{\overline{\text{MS}}}(k^2)^{-1} \right] \Big|_{k^2 = -m_{\text{ph}}^2}. \quad (592)$$

Using eq. (583), we get

$$\begin{aligned} R^{-1} &= 1 - \Pi'_{\overline{\text{MS}}}(-m_{\text{ph}}^2) \\ &= 1 - \Pi'_{\overline{\text{MS}}}(-m^2) + O(\alpha^2) \\ &= 1 + \frac{1}{12}\alpha \left(\ln(\mu^2/m^2) + c'' \right) + O(\alpha^2), \end{aligned} \quad (593)$$

where $c'' = (17 - 3\pi\sqrt{3})/3 = 0.23$.

We can also use $\overline{\text{MS}}$ to define the vertex function. We take

$$C = -\alpha \frac{1}{\xi} + O(\alpha^2), \quad (594)$$

and so

$$\mathbf{V}_{3,\overline{\text{MS}}}(k_1, k_2, k_3) = g \left[1 - \frac{1}{2}\alpha \int dF_3 \ln(D/\mu^2) + O(\alpha^2) \right] \quad (595)$$

where $D = xyk_1^2 + yzk_2^2 + zpk_3^2 + m^2$.

Let us now compute the $\varphi\varphi \rightarrow \varphi\varphi$ scattering amplitude in our fancy new renormalization scheme. In the low-mass limit, repeating the steps that led to eq. (563), and including the LSZ correction factor $(R^{1/2})^4$, we get

$$\mathcal{T} = R^2 \mathcal{T}_0 \left[1 - \frac{11}{12}\alpha \left(\ln(s/\mu^2) + O(m^0) \right) + O(\alpha^2) \right], \quad (596)$$

where $\mathcal{T}_0 = -g^2(s^{-1} + t^{-1} + u^{-1})$ is the tree-level result. Now using R from eq. (593), we find

$$\mathcal{T} = \mathcal{T}_0 \left[1 - \alpha \left(\frac{11}{12} \ln(s/\mu^2) + \frac{1}{6} \ln(\mu^2/m^2) + O(m^0) \right) + O(\alpha^2) \right]. \quad (597)$$

To get an observable amplitude-squared with an imperfect detector, we must square eq. (597) and multiply it by the correction factor we derived in section 25,

$$|\mathcal{T}|_{\text{obs}}^2 = |\mathcal{T}|^2 \left[1 + \frac{1}{3}\alpha \left(\ln(\delta^2 s/m^2) + O(m^0) \right) + O(\alpha^2) \right], \quad (598)$$

where δ is the angular resolution of the detector. Combining this with eq. (597), we get

$$|\mathcal{T}|_{\text{obs}}^2 = |\mathcal{T}_0|^2 \left[1 - \alpha \left(\frac{3}{2} \ln(s/\mu^2) + \frac{1}{3} \ln(1/\delta^2) + O(m^0) \right) + O(\alpha^2) \right]. \quad (599)$$

All factors of $\ln m^2$ have disappeared! Finally, we have obtained an expression that has a well-defined $m \rightarrow 0$ limit.

Of course, μ is still a fake parameter, and so $|\mathcal{T}|_{\text{obs}}^2$ cannot depend on it. It must be, then, that the explicit dependence on μ in eq. (599) is canceled by the implicit μ dependence of α . We can use this information to figure out how α must vary with μ . Noting that $|\mathcal{T}_0|^2 = O(g^4) = O(\alpha^2)$, we have

$$\ln |\mathcal{T}|_{\text{obs}}^2 = C_1 + 2 \ln \alpha + 3\alpha \left(\ln \mu + C_2 \right) + O(\alpha^2), \quad (600)$$

where C_1 and C_2 are independent of μ and α (but depend on the Mandelstam variables). Differentiating with respect to $\ln \mu$ then gives

$$\begin{aligned} 0 &= \frac{d}{d \ln \mu} \ln |\mathcal{T}|_{\text{obs}}^2 \\ &= \frac{2}{\alpha} \frac{d\alpha}{d \ln \mu} + 3\alpha + O(\alpha^2), \end{aligned} \tag{601}$$

or, after rearranging,

$$\frac{d\alpha}{d \ln \mu} = -\frac{3}{2}\alpha^2 + O(\alpha^3). \tag{602}$$

The right-hand side of this equation is called the *beta function*.

Returning to eq. (599), we are free to choose any convenient value of μ that we might like. To avoid introducing unnecessary large logs, we should choose $\mu^2 \sim s$.

To compare the results at different values of s , we need to solve eq. (602). Keeping only the leading term in the beta function, the solution is

$$\alpha(\mu_2) = \frac{\alpha(\mu_1)}{1 + \frac{3}{2}\alpha(\mu_1) \ln(\mu_2/\mu_1)}. \tag{603}$$

Thus, as μ increases, $\alpha(\mu)$ decreases. A theory with this property is said to be *asymptotically free*. In this case, the tree-level approximation (in the $\overline{\text{MS}}$ scheme with $\mu^2 \sim s$) becomes better and better at higher and higher energies.

Of course, the opposite is true as well: as μ decreases, $\alpha(\mu)$ increases. As we go to lower and lower energies, the theory becomes more and more strongly coupled.

If the particle mass is nonzero, this process stops at $\mu \sim m$. This is because the minimum value of s is $4m^2$, and so the factor of $\ln(s/\mu^2)$ becomes an unwanted large log for $\mu \ll m$. We should therefore not use values of μ below m . Perturbation theory is still good at these low energies if $\alpha(m) \ll 1$.

If the particle mass is zero, $\alpha(\mu)$ continues to increase at lower and lower energies, and eventually perturbation theory breaks down. This is a signal that the low-energy physics may be quite different from what we expect on the basis of a perturbative analysis.

In the case of φ^3 theory, we know what the correct low-energy physics is: the perturbative ground state is unstable against tunneling through the potential barrier, and there is no true ground state. Asymptotic freedom is, in this case, a signal of this impending disaster.

Much more interesting is asymptotic freedom in a theory that *does* have a true ground state, such as quantum chromodynamics. In this example, the particle excitations are colorless hadrons, rather than the quarks and gluons we would expect from examining the lagrangian.

If the sign of the beta function is positive, then the theory is *infrared free*. The coupling increases as μ increases, and, at sufficiently high energy, perturbation theory breaks down. On the other hand, the coupling decreases as we go to lower energies. Once again, though, we should stop this process at $\mu \sim m$ if the particles have nonzero mass. Quantum electrodynamics with massive electrons (but, of course, massless photons) is in this category.

Still more complicated behaviors are possible if the beta function has a zero at a nonzero value of α . We briefly consider this case in the next section.

Problems

26.1) In φ^4 theory (see problem 9.2), compute the beta function to $O(\lambda^2)$, the anomalous dimension of m to $O(\lambda)$, , and the anomalous dimension of φ to $O(\lambda)$.

26.2) Repeat problem 26.1 for the theory of problem 9.3.

27: Formal Development of the Renormalization Group

Prerequisite: 26

In section 26 we introduced the $\overline{\text{MS}}$ renormalization scheme, and used the fact that physical observables must be independent of the fake parameter μ to figure out how the lagrangian parameters m and g must change with μ . In this section we re-derive these results from a much more formal (but computationally simpler) point of view, and see how they extend to all orders of perturbation theory. Equations that tells us how the lagrangian parameters (and other objects that are not directly measurable, like correlation functions) vary with μ are collectively called the equations of the *renormalization group*.

Let us recall the lagrangian of our theory, and write it in two different ways. In $d = 6 - \varepsilon$ dimensions, we have

$$\mathcal{L} = -\frac{1}{2}Z_\varphi\partial^\mu\varphi\partial_\mu\varphi - \frac{1}{2}Z_m m^2\varphi^2 + \frac{1}{6}Z_g g\tilde{\mu}^{\varepsilon/2}\varphi^3 + Y\varphi \quad (604)$$

and

$$\mathcal{L} = -\frac{1}{2}\partial^\mu\varphi_0\partial_\mu\varphi_0 - \frac{1}{2}m_0^2\varphi_0^2 + \frac{1}{6}g_0\varphi_0^3 + Y_0\varphi_0 . \quad (605)$$

The fields and parameters in eq. (604) are the *renormalized* fields and parameters. (And in particular, they are renormalized using the $\overline{\text{MS}}$ scheme, with $\mu^2 = 4\pi e^{-\gamma}\tilde{\mu}^2$.) The fields and parameters in eq. (605) are the *bare* fields and parameters. Comparing eqs. (604) and (605) gives us the relationships between them:

$$\varphi_0(x) = Z_\varphi^{1/2}\varphi(x) , \quad (606)$$

$$m_0 = Z_\varphi^{-1/2}Z_m^{1/2}m , \quad (607)$$

$$g_0 = Z_\varphi^{-3/2}Z_g g\tilde{\mu}^{\varepsilon/2} , \quad (608)$$

$$Y_0 = Z_\varphi^{-1/2}Y . \quad (609)$$

Recall that, after using dimensional regularization, the infinities coming from loop integrals take the form of inverse powers of $\varepsilon = 6 - d$. In the $\overline{\text{MS}}$ renormalization scheme, we choose the Z 's to cancel off these powers of $1/\varepsilon$, and nothing more. Therefore the Z 's can be written as

$$Z_\varphi = 1 + \sum_{n=1}^{\infty} \frac{a_n(\alpha)}{\varepsilon^n}, \quad (610)$$

$$Z_m = 1 + \sum_{n=1}^{\infty} \frac{b_n(\alpha)}{\varepsilon^n}, \quad (611)$$

$$Z_g = 1 + \sum_{n=1}^{\infty} \frac{c_n(\alpha)}{\varepsilon^n}, \quad (612)$$

where $\alpha = g^2/(4\pi)^3$. Computing $\Pi(k^2)$ and $\mathbf{V}_3(k_1, k_2, k_3)$ in perturbation theory in the $\overline{\text{MS}}$ scheme gives us Taylor series in α for $a_n(\alpha)$, $b_n(\alpha)$, and $c_n(\alpha)$. So far we have found

$$a_1(\alpha) = -\frac{1}{6}\alpha + O(\alpha^2), \quad (613)$$

$$b_1(\alpha) = -\alpha + O(\alpha^2), \quad (614)$$

$$c_1(\alpha) = -\alpha + O(\alpha^2), \quad (615)$$

and that $a_n(\alpha)$, $b_n(\alpha)$, and $c_n(\alpha)$ are all at least $O(\alpha^2)$ for $n \geq 2$.

Next we turn to the trick that we will employ to compute the beta function for α , the anomalous dimension of m , and other useful things. This is the trick: *bare fields and parameters must be independent of μ* .

Why is this so? Recall that we introduced μ when we found that we had to regularize the theory to avoid infinities in the loop integrals of Feynman diagrams. We argued at the time (and ever since) that physical quantities had to be independent of μ . Thus μ is not really a parameter of the theory, but just a crutch that we had to introduce at an intermediate stage of the calculation. In principle, the theory is completely specified by the values of the bare parameters, and, if we were smart enough, we would be able to compute the exact scattering amplitudes in terms of them, without ever introducing μ . Since the exact scattering amplitudes are independent of μ , the bare parameters must be as well.

Let us start with g_0 . It is convenient to define

$$\alpha_0 \equiv g_0^2/(4\pi)^3 = Z_g^2 Z_\varphi^{-3} \tilde{\mu}^\varepsilon \alpha , \quad (616)$$

and also

$$G(\alpha, \varepsilon) \equiv \ln\left(Z_g^2 Z_\varphi^{-3}\right) . \quad (617)$$

From the general structure of eqs. (610) and (612), we have

$$G(\alpha, \varepsilon) = \sum_{n=1}^{\infty} \frac{G_n(\alpha)}{\varepsilon^n} , \quad (618)$$

where, in particular,

$$\begin{aligned} G_1(\alpha) &= 2c_1(\alpha) - 3a_1(\alpha) \\ &= -\frac{3}{2}\alpha + O(\alpha^2) . \end{aligned} \quad (619)$$

The logarithm of eq. (616) can now be written as

$$\ln \alpha_0 = G(\alpha, \varepsilon) + \ln \alpha + \varepsilon \ln \tilde{\mu} . \quad (620)$$

Next, differentiate eq. (620) with respect to $\ln \mu$, and require α_0 to be independent of it:

$$\begin{aligned} 0 &= \frac{d}{d \ln \mu} \ln \alpha_0 \\ &= \frac{\partial G(\alpha, \varepsilon)}{\partial \alpha} \frac{d\alpha}{d \ln \mu} + \frac{1}{\alpha} \frac{d\alpha}{d \ln \mu} + \varepsilon . \end{aligned} \quad (621)$$

Now regroup the terms, multiply by α , and use eq. (618) to get

$$0 = \left(1 + \frac{\alpha G'_1(\alpha)}{\varepsilon} + \frac{\alpha G'_2(\alpha)}{\varepsilon^2} + \dots\right) \frac{d\alpha}{d \ln \mu} + \varepsilon \alpha . \quad (622)$$

Next we use some physical reasoning: $d\alpha/d \ln \mu$ is the rate at which α must change to compensate for a small change in $\ln \mu$. If compensation is possible at all, this rate should be finite in the $\varepsilon \rightarrow 0$ limit. Therefore, in a renormalizable theory, we should have

$$\frac{d\alpha}{d \ln \mu} = -\varepsilon \alpha + \beta(\alpha) . \quad (623)$$

The first term, $-\varepsilon\alpha$, is fixed by matching the $O(\varepsilon)$ terms in eq. (622). The second term, the beta function $\beta(\alpha)$, is similarly determined by matching the $O(\varepsilon^0)$ terms; the result is

$$\beta(\alpha) = \alpha^2 G'_1(\alpha) . \quad (624)$$

Terms that are higher-order in $1/\varepsilon$ must also cancel, and this determines all the other $G'_n(\alpha)$'s in terms of $G'_1(\alpha)$. Thus, for example, cancellation of the $O(\varepsilon^{-1})$ terms fixes $G'_2(\alpha) = \alpha G'_1(\alpha)^2$. These relations among the $G'_n(\alpha)$'s can of course be checked order by order in perturbation theory.

From eq. (624) and eq. (619), we find that the beta function is

$$\beta(\alpha) = -\frac{3}{2}\alpha^2 + O(\alpha^3) . \quad (625)$$

Hearteningly, this is the same result we found in section 26 by requiring the observed scattering cross section $|\mathcal{T}|_{\text{obs}}^2$ to be independent of μ . However, simply as a matter of practical calculation, it is much easier to compute $G_1(\alpha)$ than it is to compute $|\mathcal{T}|_{\text{obs}}^2$.

Next consider the invariance of m_0 . We begin by defining

$$\begin{aligned} M(\alpha, \varepsilon) &\equiv \ln\left(Z_m^{1/2} Z_\varphi^{-1/2}\right) \\ &= \sum_{n=1}^{\infty} \frac{M_n(\alpha)}{\varepsilon^n} . \end{aligned} \quad (626)$$

From eqs. (613) and (615) we have

$$\begin{aligned} M_1(\alpha) &= \frac{1}{2}b_1(\alpha) - \frac{1}{2}a_1(\alpha) \\ &= -\frac{5}{12}\alpha + O(\alpha^2) . \end{aligned} \quad (627)$$

Then, from eq. (607), we have

$$\ln m_0 = M(\alpha, \varepsilon) + \ln m . \quad (628)$$

Take the derivative with respect to $\ln \mu$ and require m_0 to be unchanged:

$$\begin{aligned} 0 &= \frac{d}{d \ln \mu} \ln m_0 \\ &= \frac{\partial M(\alpha, \varepsilon)}{\partial \alpha} \frac{d\alpha}{d \ln \mu} + \frac{1}{m} \frac{dm}{d \ln \mu} . \\ &= \frac{\partial M(\alpha, \varepsilon)}{\partial \alpha} \left(-\varepsilon\alpha + \beta(\alpha)\right) + \frac{1}{m} \frac{dm}{d \ln \mu} . \end{aligned} \quad (629)$$

Rearranging, we find

$$\begin{aligned} \frac{1}{m} \frac{dm}{d \ln \mu} &= (\varepsilon \alpha - \beta(\alpha)) \sum_{n=1}^{\infty} \frac{M'_n(\alpha)}{\varepsilon^n} \\ &= \alpha M'_1(\alpha) + \dots, \end{aligned} \quad (630)$$

where the ellipses stand for terms with powers of $1/\varepsilon$. In a renormalizable theory, $dm/d \ln \mu$ should be finite in the $\varepsilon \rightarrow 0$ limit, and so these terms must actually all be zero. Therefore, the anomalous dimension of the mass, defined via

$$\gamma_m(\alpha) \equiv \frac{1}{m} \frac{dm}{d \ln \mu}, \quad (631)$$

is given by

$$\begin{aligned} \gamma_m(\alpha) &= \alpha M'_1(\alpha) \\ &= -\frac{5}{12} \alpha + O(\alpha^2). \end{aligned} \quad (632)$$

Comfortingly, this is just what we found in section 26.

Let us now consider the propagator in the $\overline{\text{MS}}$ renormalization scheme,

$$\tilde{\Delta}(k^2) = i \int d^6x e^{ikx} \langle 0 | T \varphi(x) \varphi(0) | 0 \rangle. \quad (633)$$

The bare propagator,

$$\tilde{\Delta}_0(k^2) = i \int d^6x e^{ikx} \langle 0 | T \varphi_0(x) \varphi_0(0) | 0 \rangle, \quad (634)$$

should be (by the now-familiar argument) independent of μ . The bare and renormalized propagators are related by

$$\tilde{\Delta}_0(k^2) = Z_\varphi \tilde{\Delta}(k^2). \quad (635)$$

Taking the logarithm and differentiating with respect to $\ln \mu$, we get

$$\begin{aligned} 0 &= \frac{d}{d \ln \mu} \ln \tilde{\Delta}_0(k^2) \\ &= \frac{d \ln Z_\varphi}{d \ln \mu} + \frac{d}{d \ln \mu} \ln \tilde{\Delta}(k^2) \\ &= \frac{d \ln Z_\varphi}{d \ln \mu} + \frac{1}{\tilde{\Delta}(k^2)} \left(\frac{\partial}{\partial \ln \mu} + \frac{d\alpha}{d \ln \mu} \frac{\partial}{\partial \alpha} + \frac{dm}{d \ln \mu} \frac{\partial}{\partial m} \right) \tilde{\Delta}(k^2). \end{aligned} \quad (636)$$

We can write

$$\ln Z_\varphi = \frac{a_1(\alpha)}{\varepsilon} + \frac{a_2(\alpha) - \frac{1}{2}a_1^2(\alpha)}{\varepsilon^2} + \dots \quad (637)$$

Then we have

$$\begin{aligned} \frac{d \ln Z_\varphi}{d \ln \mu} &= \frac{\partial \ln Z_\varphi}{\partial \alpha} \frac{d \alpha}{d \ln \mu} \\ &= \left(\frac{a_1'(\alpha)}{\varepsilon} + \dots \right) (-\varepsilon \alpha + \beta(\alpha)) \\ &= -\alpha a_1'(\alpha) + \dots, \end{aligned} \quad (638)$$

where the ellipses in the last line stand for terms with powers of $1/\varepsilon$. Since $\tilde{\Delta}(k^2)$ should vary smoothly with μ in the $\varepsilon \rightarrow 0$ limit, these must all be zero. We then define the *anomalous dimension of the field*

$$\gamma_\varphi(\alpha) \equiv \frac{1}{2} \frac{d \ln Z_\varphi}{d \ln \mu}. \quad (639)$$

From eq. (638) we find

$$\begin{aligned} \gamma_\varphi(\alpha) &= -\frac{1}{2} \alpha a_1'(\alpha) \\ &= +\frac{1}{12} \alpha + O(\alpha^2). \end{aligned} \quad (640)$$

Eq. (636) can now be written as

$$\left(\frac{\partial}{\partial \ln \mu} + \beta(\alpha) \frac{\partial}{\partial \alpha} + \gamma_m(\alpha) m \frac{\partial}{\partial m} + 2\gamma_\varphi(\alpha) \right) \tilde{\Delta}(k^2) = 0 \quad (641)$$

in the $\varepsilon \rightarrow 0$ limit. This is the *Callan-Symanzik equation* for the propagator.

The Callan-Symanzik equation is most interesting in the massless limit, and for a theory with a zero of the beta function at a nonzero value of α . So, let us suppose that $\beta(\alpha_*) = 0$ for some $\alpha_* \neq 0$. Then, for $\alpha = \alpha_*$ and $m = 0$, the Callan-Symanzik equation becomes

$$\left(\frac{\partial}{\partial \ln \mu} + 2\gamma_\varphi(\alpha_*) \right) \tilde{\Delta}(k^2) = 0. \quad (642)$$

The solution is

$$\tilde{\Delta}(k^2) = \frac{C(\alpha_*)}{k^2} \left(\frac{\mu^2}{k^2} \right)^{-\gamma_\varphi(\alpha_*)}, \quad (643)$$

where $C(\alpha_*)$ is an integration constant. (We used the fact that $\tilde{\Delta}(k^2)$ has mass dimension -2 to get the k^2 dependence in addition to the μ dependence.) Thus the naive scaling law $\tilde{\Delta}(k^2) \sim k^{-2}$ is changed to $\tilde{\Delta}(k^2) \sim k^{-2[1-\gamma_\varphi(\alpha_*)]}$. This has applications in the theory of critical phenomena, which is beyond the scope of this book.

28: Nonrenormalizable Theories and Effective Field Theory

Prerequisite: 27

So far we have been discussing only renormalizable theories. In this section, we investigate what meaning can be assigned to nonrenormalizable theories, following an approach pioneered by Ken Wilson.

We will begin by analyzing a renormalizable theory from a new point of view. Consider, as an example, φ^4 theory in four spacetime dimensions:

$$\mathcal{L} = -\frac{1}{2}Z_\varphi\partial^\mu\varphi\partial_\mu\varphi - \frac{1}{2}Z_m m_{\text{ph}}^2\varphi^2 - \frac{1}{24}Z_\lambda\lambda_{\text{ph}}\varphi^4. \quad (644)$$

(This example is actually problematic, because φ^4 theory is *trivial*, a technical term we will explain later. For now we proceed with a perturbative analysis.) We take the renormalizing Z factors to be defined in an on-shell scheme, and have emphasized this by writing the particle mass as m_{ph} and the coupling constant as λ_{ph} . We define λ_{ph} as the value of the exact 1PI four-point vertex with zero external four-momenta:

$$\lambda_{\text{ph}} \equiv \mathbf{V}_4(0, 0, 0, 0). \quad (645)$$

The path integral is given by

$$Z(J) = \int \mathcal{D}\varphi e^{iS + i\int J\varphi}, \quad (646)$$

where $S = \int d^4x \mathcal{L}$ and $\int J\varphi$ is short for $\int d^4x J\varphi$.

Our first step in analyzing this theory will be to perform the Wick rotation (applied to loop integrals in section 14) directly on the action. We define a euclidean time $\tau \equiv it$. Then we have

$$Z(J) = \int \mathcal{D}\varphi e^{-S_E - \int J\varphi}, \quad (647)$$

where $S_E = \int d^4x \mathcal{L}_E$, $d^4x = d^3x d\tau$,

$$\mathcal{L}_E = \frac{1}{2} Z_\varphi \partial_\mu \varphi \partial_\mu \varphi + \frac{1}{2} Z_m m_{\text{ph}}^2 \varphi^2 + \frac{1}{24} Z_\lambda \lambda_{\text{ph}} \varphi^4, \quad (648)$$

and

$$\partial_\mu \varphi \partial_\mu \varphi = (\partial\varphi/\partial\tau)^2 + (\nabla\varphi)^2. \quad (649)$$

Note that each term in S_E is always positive (or zero) for any field configuration $\varphi(x)$. This is the advantage of working in euclidean space: eq. (647), the *euclidean path integral*, is strongly damped (rather than rapidly oscillating) at large values of the field and/or its derivatives, and this makes its convergence properties more obvious.

Next, we Fourier transform to (euclidean) momentum space via

$$\varphi(x) = \int \frac{d^4k}{(2\pi)^4} e^{ikx} \tilde{\varphi}(k). \quad (650)$$

The euclidean action becomes

$$\begin{aligned} S_E &= \frac{1}{2} \int \frac{d^4k}{(2\pi)^4} \tilde{\varphi}(-k) (Z_\varphi k^2 + Z_m m_{\text{ph}}^2) \tilde{\varphi}(k) \\ &\quad + \frac{1}{24} Z_\lambda \lambda_{\text{ph}} \int \frac{d^4k_1}{(2\pi)^4} \dots \frac{d^4k_4}{(2\pi)^4} (2\pi)^4 \delta^4(k_1 + k_2 + k_3 + k_4) \\ &\quad \times \tilde{\varphi}(k_1) \tilde{\varphi}(k_2) \tilde{\varphi}(k_3) \tilde{\varphi}(k_4). \end{aligned} \quad (651)$$

Note that $k^2 = \mathbf{k}^2 + k_\tau^2 \geq 0$.

Now we define a particular energy scale Λ as the *ultraviolet cutoff*. It should be much larger than the particle mass m_{ph} , or any other energy scale of practical interest. Then we perform the path integral over all $\tilde{\varphi}(k)$ with $|k| > \Lambda$. We also take $\tilde{J}(k) = 0$ for $|k| > \Lambda$. Then we find

$$Z(J) = \int \mathcal{D}\varphi_{|k| < \Lambda} e^{-S_{\text{eff}}(\varphi; \Lambda) - \int J\varphi}, \quad (652)$$

where

$$e^{-S_{\text{eff}}(\varphi; \Lambda)} = \int \mathcal{D}\varphi_{|k| > \Lambda} e^{-S_E(\varphi)}. \quad (653)$$

$S_{\text{eff}}(\varphi; \Lambda)$ is called the *Wilsonian effective action*. We can write the corresponding lagrangian density as

$$\begin{aligned} \mathcal{L}_{\text{eff}}(\varphi; \Lambda) &= \frac{1}{2} Z(\Lambda) \partial_\mu \varphi \partial_\mu \varphi + \frac{1}{2} m^2(\Lambda) \varphi^2 + \frac{1}{24} \lambda(\Lambda) \varphi^4 \\ &\quad + \sum_i c_{n,d,i}(\Lambda) \mathcal{O}_{n,d,i}, \end{aligned} \quad (654)$$

where the Fourier components of $\varphi(x)$ are now cut off at $|k| > \Lambda$:

$$\varphi(x) = \int_0^\Lambda \frac{d^4k}{(2\pi)^4} e^{ikx} \tilde{\varphi}(k). \quad (655)$$

The operators $\mathcal{O}_{n,d,i}$ in eq. (654) consist of all terms (other than those already written explicitly on the first line) that we can construct out of an even number $2n$ of φ fields (the number must be even in order to respect the $\varphi \leftrightarrow -\varphi$ symmetry of the original lagrangian) with an even number $2d$ of derivatives acting on them (with all the vector indices contracted in pairs). The index i keeps track of operators with the same values of n and d that are not equivalent after integrations by parts. The operator $\mathcal{O}_{n,d,i}$ has mass dimension $D = 2n + 2d \geq 6$.

The coefficients $Z(\Lambda)$, $m^2(\Lambda)$, $\lambda(\Lambda)$, and $c_{n,d,i}(\Lambda)$ in eq. (654) are all *finite* functions of Λ . This is established by the following argument. We can differentiate eq. (652) with respect to $J(x)$ to compute correlation functions of the renormalized field $\varphi(x)$, and correlation functions of renormalized fields are finite. Using eq. (652), we can compute these correlation functions as a series of Feynman diagrams, with Feynman rules based on \mathcal{L}_{eff} . These rules include an ultraviolet cutoff Λ on the loop momenta, since the fields with higher momenta have already been *integrated out*. Thus all of the loop integrals in these diagrams are finite. Therefore the other parameters that enter the diagrams— $Z(\Lambda)$, $m^2(\Lambda)$, $\lambda(\Lambda)$, and $c_{n,d,i}(\Lambda)$ —must be finite as well, in order to end up with finite correlation functions.

To compute these parameters, we can think of eq. (651) as the action for two kinds of fields, those with $|k| < \Lambda$ and those with $|k| > \Lambda$. Then we draw all 1PI diagrams with external lines for $|k| < \Lambda$ fields only. The dominant contribution to $c_{n,d,i}(\Lambda)$ is then given by a one-loop diagram with $2n$ external lines (representing $|k| < \Lambda$ fields), n vertices, and a $|k| > \Lambda$ field circulating in the loop; see fig. (33).

With $2n$ external lines, there are $(2n)!$ ways of assigning the external momenta to the lines, but $2^n \times n \times 2$ of these give the same diagram: 2^n for exchanging the two external lines that meet at any one vertex; n for rotations of the diagram; and 2 for reflection of the diagram.

The simplest case to consider is $\mathcal{O}_{n,0} \equiv \varphi^{2n}$. Since there are no derivatives on the external fields, we can set all of the external momenta to zero; then all

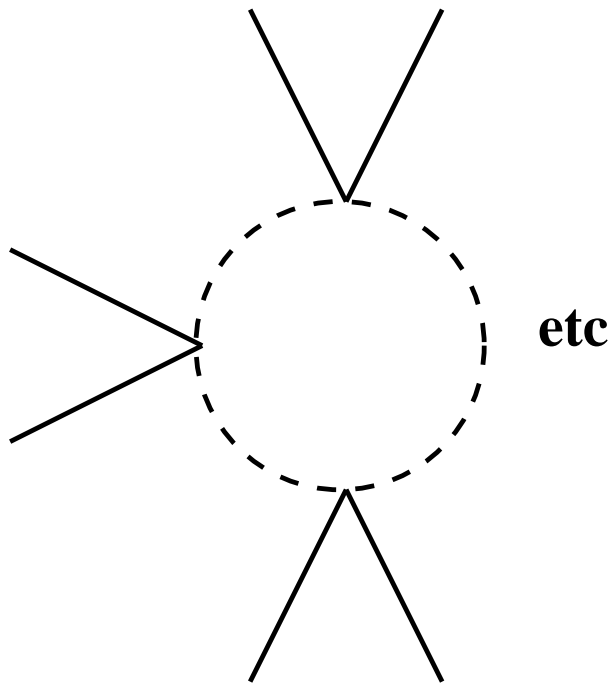

Figure 33: A one-loop 1PI diagram with $2n$ external lines. Each external line represents a field with $|k| < \Lambda$. The internal (dashed) line represents a field with $|k| > \Lambda$.

$(2n)!/(2^n 2n)$ diagrams have the same value. With a euclidean action, each internal line contributes a factor of $1/(k^2 + m_{\text{ph}}^2)$, and each vertex contributes a factor of $-Z_\lambda \lambda_{\text{ph}} = -\lambda_{\text{ph}} + O(\lambda_{\text{ph}}^2)$. The vertex factor associated with the term $c_{n,0}(\Lambda) \varphi^{2n}$ in \mathcal{L}_{eff} is $-(2n)! c_{n,0}(\Lambda)$. Thus we have

$$-(2n)! c_{n,0}(\Lambda) = \frac{(-\lambda_{\text{ph}})^n (2n)!}{2^n 2n} \int_{\Lambda}^{\infty} \frac{d^4 k}{(2\pi)^4} \left(\frac{1}{k^2 + m_{\text{ph}}^2} \right)^n + O(\lambda_{\text{ph}}^{n+1}). \quad (656)$$

For $2n \geq 6$, the integral converges, and we find

$$c_{n,0}(\Lambda) = -\frac{(-\lambda_{\text{ph}}/2)^n}{32\pi^2 n(n-2)} \frac{1}{\Lambda^{2n-4}} + O(\lambda_{\text{ph}}^{n+1}). \quad (657)$$

We have taken $\Lambda \gg m_{\text{ph}}$, and dropped terms down by powers of m_{ph}/Λ .

For $2n = 4$, we have to include the tree-level vertex; in this case, we have

$$-\lambda(\Lambda) = -Z_\lambda \lambda_{\text{ph}} + \frac{3}{2} (-\lambda_{\text{ph}})^2 \int_{\Lambda}^{\infty} \frac{d^4 k}{(2\pi)^4} \left(\frac{1}{k^2 + m_{\text{ph}}^2} \right)^2 + O(\lambda_{\text{ph}}^3). \quad (658)$$

This integral diverges. To evaluate it, recall that the one-loop contribution to the exact four-point vertex is given by the *same* diagram, but with fields of *all* momenta circulating in the loop. Thus we have

$$-\mathbf{V}_4(0, 0, 0, 0) = -Z_\lambda \lambda_{\text{ph}} + \frac{3}{2} (-\lambda_{\text{ph}})^2 \int_0^{\infty} \frac{d^4 k}{(2\pi)^4} \left(\frac{1}{k^2 + m_{\text{ph}}^2} \right)^2 + O(\lambda_{\text{ph}}^3). \quad (659)$$

Then, using $\mathbf{V}_4(0, 0, 0, 0) = \lambda_{\text{ph}}$ and subtracting eq. (658) from eq. (659), we get

$$-\lambda_{\text{ph}} + \lambda(\Lambda) = \frac{3}{2} (-\lambda_{\text{ph}})^2 \int_0^{\Lambda} \frac{d^4 k}{(2\pi)^4} \left(\frac{1}{k^2 + m_{\text{ph}}^2} \right)^2 + O(\lambda_{\text{ph}}^3). \quad (660)$$

Evaluating the (now finite!) integral and rearranging, we have

$$\lambda(\Lambda) = \lambda_{\text{ph}} + \frac{3}{16\pi^2} \lambda_{\text{ph}}^2 \left[\ln(\Lambda/m_{\text{ph}}) - \frac{1}{2} \right] + O(\lambda_{\text{ph}}^3). \quad (661)$$

Note that this result has the problem of a *large log*; the second term is smaller than the first only if $\lambda_{\text{ph}} \ln(\Lambda/m_{\text{ph}}) \ll 1$. To cure this problem, we must change the renormalization scheme. We will take up this issue shortly, but first let us examine the case of two external lines while continuing to use the on-shell scheme.

For the case of two external lines, the one-loop diagram has just one vertex, and by momentum conservation, the loop integral is completely independent of the external momentum. This implies that the one-loop contribution to $Z(\Lambda)$ vanishes, and so we have

$$Z(\Lambda) = 1 + O(\lambda_{\text{ph}}^2). \quad (662)$$

The one-loop diagram does, however, give a nonzero contribution to $m^2(\Lambda)$; after including the tree-level term, we find

$$-m^2(\Lambda) = -Z_m m_{\text{ph}}^2 + \frac{1}{2}(-\lambda_{\text{ph}}) \int_{\Lambda}^{\infty} \frac{d^4k}{(2\pi)^4} \frac{1}{k^2 + m_{\text{ph}}^2} + O(\lambda_{\text{ph}}^2). \quad (663)$$

This integral diverges. To evaluate it, recall that the one-loop contribution to the exact particle mass-squared is given by the *same* diagram, but with fields of *all* momenta circulating in the loop. Thus we have

$$-m_{\text{ph}}^2 = -Z_m m_{\text{ph}}^2 + \frac{1}{2}(-\lambda_{\text{ph}}) \int_0^{\infty} \frac{d^4k}{(2\pi)^4} \frac{1}{k^2 + m_{\text{ph}}^2} + O(\lambda_{\text{ph}}^2). \quad (664)$$

Then, subtracting eq. (663) from eq. (664), we get

$$-m_{\text{ph}}^2 + m^2(\Lambda) = \frac{1}{2}(-\lambda_{\text{ph}}) \int_0^{\Lambda} \frac{d^4k}{(2\pi)^4} \frac{1}{k^2 + m_{\text{ph}}^2} + O(\lambda_{\text{ph}}^2). \quad (665)$$

Evaluating the (now finite!) integral and rearranging, we have

$$m^2(\Lambda) = m_{\text{ph}}^2 - \frac{\lambda_{\text{ph}}}{16\pi^2} [\Lambda^2 - m_{\text{ph}}^2 \ln(\Lambda^2/m_{\text{ph}}^2)] + O(\lambda_{\text{ph}}^2). \quad (666)$$

We see that we now have an even worse situation than we did with the large log in $\lambda(\Lambda)$: the correction term is *quadratically divergent*.

As already noted, to fix these problems we must change the renormalization scheme. In the context of an effective action with a specific value of

the cutoff Λ_0 , there is a simple way to do so: we simply treat $Z(\Lambda_0)$, $m^2(\Lambda_0)$, $\lambda(\Lambda_0)$, and $c_{n,d,i}(\Lambda_0)$ as the input parameters, and then see what physics emerges at energy scales well below Λ_0 . We can set $Z(\Lambda_0) = 1$, with the understanding that the field no longer has the LSZ normalization (and that we will have to correct the LSZ formula to account for this). We will also assume that the parameters $\lambda(\Lambda_0)$, $m^2(\Lambda_0)$, and $c_{n,d,i}(\Lambda_0)$ are all small when measured in units of the cutoff:

$$\lambda(\Lambda_0) \ll 1, \quad (667)$$

$$|m^2(\Lambda_0)| \ll \Lambda_0^2, \quad (668)$$

$$c_{n,d,i}(\Lambda_0) \ll \frac{1}{\Lambda_0^{2n+2d-4}}. \quad (669)$$

The proposal to treat the effective action as the fundamental starting point may not seem very appealing. For one thing, we now have an infinite number of parameters to specify, rather than two! Also, we now have an explicit cutoff in place, rather than trying to have a theory that works at all energy scales.

On the other hand, it may well be that quantum field theory does not work at arbitrarily high energies. For example, quantum fluctuations in spacetime itself should become important above the *Planck scale*, which is given by the inverse square root of Newton's constant, and has the numerical value of 10^{19} GeV (compared to, say, the proton mass, which is 1 GeV).

So, let us leave the cutoff Λ_0 in place for now. We will then make a two-pronged analysis. First, we will see what happens at much lower energies. Then, we will see what happens if we try to take the limit $\Lambda_0 \rightarrow \infty$.

We begin by examining lower energies. To make things more tractable, we will set

$$c_{n,d,i}(\Lambda_0) = 0; \quad (670)$$

later we will examine the effects of a more general choice.

A nice way to see what happens at lower energies is to integrate out some more high-energy degrees of freedom. Let us, then, perform the functional integral over Fourier modes $\tilde{\varphi}(k)$ with $\Lambda < |k| < \Lambda_0$; we have

$$e^{-S_{\text{eff}}(\varphi;\Lambda)} = \int \mathcal{D}\varphi_{\Lambda < |k| < \Lambda_0} e^{-S_{\text{eff}}(\varphi;\Lambda_0)}. \quad (671)$$

We can do this calculation in perturbation theory, mimicking the procedure that we used earlier. We find

$$m^2(\Lambda) = m^2(\Lambda_0) + \frac{1}{2}\lambda(\Lambda_0) \int_{\Lambda}^{\Lambda_0} \frac{d^4k}{(2\pi)^4} \frac{1}{k^2 + m^2(\Lambda_0)} + \dots, \quad (672)$$

$$\lambda(\Lambda) = \lambda(\Lambda_0) - \frac{3}{2}\lambda^2(\Lambda_0) \int_{\Lambda}^{\Lambda_0} \frac{d^4k}{(2\pi)^4} \left(\frac{1}{k^2 + m^2(\Lambda_0)} \right)^2 + \dots, \quad (673)$$

$$c_{n,0}(\Lambda) = -\frac{(-1)^n}{2^n 2n} \lambda^n(\Lambda_0) \int_{\Lambda}^{\Lambda_0} \frac{d^4k}{(2\pi)^4} \left(\frac{1}{k^2 + m^2(\Lambda_0)} \right)^n + \dots, \quad (674)$$

where the ellipses stand for higher-order corrections. For Λ not too much less than Λ_0 (and, in particular, for $|m^2(\Lambda_0)| \ll \Lambda^2$), we find

$$m^2(\Lambda) = m^2(\Lambda_0) + \frac{1}{16\pi^2} \lambda(\Lambda_0) (\Lambda_0^2 - \Lambda^2) + \dots, \quad (675)$$

$$\lambda(\Lambda) = \lambda(\Lambda_0) - \frac{3}{16\pi^2} \lambda^2(\Lambda_0) \ln \frac{\Lambda_0}{\Lambda} + \dots, \quad (676)$$

$$c_{n,0}(\Lambda) = -\frac{(-1)^n}{32\pi^2 2^n n(n-2)} \lambda^n(\Lambda_0) \left(\frac{1}{\Lambda^{2n-4}} - \frac{1}{\Lambda_0^{2n-4}} \right) + \dots. \quad (677)$$

We see from this that the corrections to $m^2(\Lambda)$, which is the only coefficient with positive mass dimension, are dominated by contributions from the *high* end of the integral. On the other hand, the corrections to $c_{n,d,i}(\Lambda)$, coefficients with negative mass dimension, are dominated by contributions from the *low* end of the integral. And the corrections to $\lambda(\Lambda)$, which is dimensionless, come equally from all portions of the range of integration.

For the $c_{n,d,i}(\Lambda)$, this means that their starting values at Λ_0 were not very important, as long as eq. (669) is obeyed. Nonzero starting values would contribute another term of order $1/\Lambda_0^{2n-4}$ to $c_{n,0}(\Lambda)$, but all such terms are less important than the one of order $1/\Lambda^{2n-4}$ that comes from doing the integral down to $|k| = \Lambda$.

Similarly, nonzero values of $c_{n,d,i}(\Lambda_0)$ would make subdominant contributions to $\lambda(\Lambda)$. As an example, consider the contribution of the diagram in fig. (34). Ignoring numerical factors, the vertex factor is $c_{6,0}(\Lambda_0)$, and the loop integral is the same as the one that enters into $m^2(\Lambda)$; it yields a factor

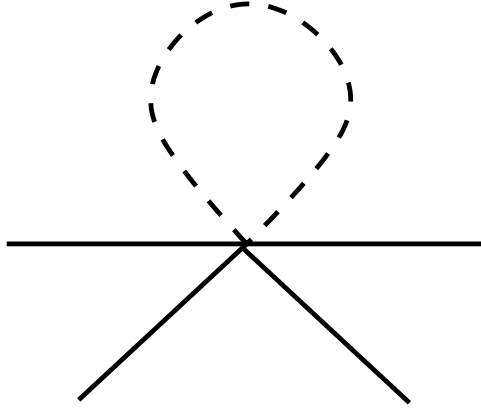

Figure 34: A one-loop contribution to the φ^4 vertex for fields with $|k| < \Lambda$. The internal (dashed) line represents a field with $|k| > \Lambda$.

of $\Lambda_0^2 - \Lambda^2 \sim \Lambda_0^2$. Thus the contribution of this diagram to $\lambda(\Lambda)$ is of order $c_{6,0}(\Lambda_0)\Lambda_0^2$. This is a pure number that, according to eq. (669), is small. This contribution is missing the logarithmic enhancement factor $\ln(\Lambda_0/\Lambda)$ that we see in eq. (676).

On the other hand, for $m^2(\Lambda)$, there are infinitely many contributions of order Λ_0^2 when $c_{n,d,i}(\Lambda_0) \neq 0$. These must add up to give $m^2(\Lambda)$ a value that is much smaller. Indeed, we want to continue the process down to lower and lower values of Λ , with $m^2(\Lambda)$ dropping until it becomes of order m_{ph}^2 at $\Lambda \sim m_{\text{ph}}$. For this to happen, there must be very precise cancellations among all the terms of order Λ_0^2 that contribute to $m^2(\Lambda)$. In some sense, it is more “natural” to have $m_{\text{ph}}^2 \sim \lambda(\Lambda_0)\Lambda_0^2$, rather than to arrange for these very precise cancellations. This philosophical issue is called the *fine-tuning problem*, and it generically arises in theories with spin-zero fields.

In theories with higher-spin fields only, the action typically has more symmetry when these fields are massless, and this typically prevents divergences that are worse than logarithmic. These theories are said to be *technically natural*, while theories with spin-zero fields (with physical masses well below the cutoff) generally are not. (The only exceptions are theories where *supersymmetry* relates spin-zero and spin-one-half fields; the spin-zero fields then inherit the technical naturalness of their spin-one-half partners.) For now,

in φ^4 theory, we will simply accept the necessity of fine-tuning in order to have $m_{\text{ph}} \ll \Lambda$.

Returning to eqs. (675–677), we can recast them as differential equations that tell us how these parameters change with the value of the cutoff Λ . In particular, let us do this for $\lambda(\Lambda)$. We take the derivative of eq. (676) with respect to Λ , multiply by Λ , and then set $\Lambda_0 = \Lambda$ to get

$$\frac{d}{d \ln \Lambda} \lambda(\Lambda) = \frac{3}{16\pi^2} \lambda^2(\Lambda) + \dots \quad (678)$$

Notice that the right-hand side of eq. (676) is apparently the same as the *beta function* $\beta(\lambda) \equiv d\lambda/d \ln \mu$ that we calculated in section 26, where it represented the rate of change in the $\overline{\text{MS}}$ parameter λ that was needed to compensate for a change in the $\overline{\text{MS}}$ renormalization scale μ . Eq. (676) gives us a new physical interpretation of the beta function: it is the rate of change in the coefficient of the φ^4 term in the effective action as we vary the ultraviolet cutoff in that action.

Actually, though, there is a technical detail: it is really $Z(\Lambda)^{-2}\lambda(\Lambda)$ that is most closely analogous to the $\overline{\text{MS}}$ parameter λ . This is because, if we rescaled φ so that it had a canonical kinetic term of $\frac{1}{2}\partial_\mu\varphi\partial_\mu\varphi$, then $Z(\Lambda)^{-2}\lambda(\Lambda)$ would be the coefficient of the φ^4 term. Since $Z(\Lambda) = 1 + O(\lambda^2(\Lambda))$, this has no effect at the one-loop level, but it does matter at two loops. At three and higher loops, other differences can arise as well, due to the different underlying definitions of the coupling λ in the cutoff scheme and the $\overline{\text{MS}}$ scheme.

We now have the overall picture of Wilson’s approach to quantum field theory. First, define a quantum field theory via an action with an explicit momentum cutoff in place. (This can be done in various ways: for example, we could replace continuous spacetime with a discrete *lattice* of points with *lattice spacing* a ; then there is an effective largest momentum of order $1/a$. This scheme is very useful as a starting point for nonperturbative computer calculations.) Then, lower the cutoff by integrating out higher-momentum degrees of freedom. As a result, the coefficients in the effective action will change. If the field theory is weakly coupled—which in practice means eqs. (667–669) are obeyed—then the coefficients of the operators with negative mass dimension will start to take on the values we would have computed for them in perturbation theory, regardless of their precise initial

values. If we continuously rescale the fields to have canonical kinetic terms, then the dimensionless coupling constant(s) will change according to their beta functions. Up to at least the two-loop level, these beta functions are identical to those that we would find in the $\overline{\text{MS}}$ scheme. The final results, at an energy scale E well below the initial cutoff Λ_0 , are the same as we would predict via renormalized perturbation theory, up to small corrections by powers of E/Λ_0 .

The advantage of the Wilson scheme is that it gives a nonperturbative definition of the theory which is applicable even if the theory is *not* weakly coupled. With a spacetime lattice providing the cutoff, other techniques (typically requiring large-scale computer calculations) can be brought to bear on strongly-coupled theories.

The Wilson scheme also allows us to give physical meaning to nonrenormalizable theories. Given an action for a nonrenormalizable theory, we can regard it as an effective action. We should then impose a momentum cutoff Λ_0 , where Λ_0 can be defined by saying that the coefficient of every operator \mathcal{O}_i with mass dimension $D_i > 4$ is given by $c_i/\Lambda_0^{D_i-4}$ with $c_i \leq 1$. Then we can use this theory for physics at energies below Λ_0 . At energies E far below Λ_0 , the effective theory will look like a renormalizable one, up to corrections by powers of E/Λ_0 . (This renormalizable theory might simply be a free-field theory with *no* interactions, or no theory at all if there are no particles with physical masses well below Λ_0 .)

We now turn to the final issue: can we remove the cutoff completely?

Returning to the example of φ^4 theory, let us suppose that we are somehow able to compute the exact beta function. Then we can integrate the renormalization-group equation $d\lambda/d\ln\Lambda = \beta(\lambda)$ from $\Lambda = m_{\text{ph}}$ to $\Lambda = \Lambda_0$ to get

$$\int_{\lambda(m_{\text{ph}})}^{\lambda(\Lambda_0)} \frac{d\lambda}{\beta(\lambda)} = \ln \frac{\Lambda_0}{m_{\text{ph}}} . \quad (679)$$

We would like to take the limit $\Lambda_0 \rightarrow \infty$. Obviously, the right-hand side of eq. (679) becomes infinite in this limit, and so the left-hand side must as well.

However, it may not. Recall that, for small λ , $\beta(\lambda)$ is positive, and it increases faster than λ . If this is true for all λ , then the left-hand side of eq. (679) will approach a fixed, finite value as we take the upper limit of

integration to infinity. This yields a maximum possible value for the initial cutoff, given by

$$\ln \frac{\Lambda_{\max}}{m_{\text{ph}}} \equiv \int_{\lambda(m_{\text{ph}})}^{\infty} \frac{d\lambda}{\beta(\lambda)} . \quad (680)$$

If we approximate the exact beta function with its leading term, $3\lambda^2/16\pi^2$, and use the leading term in eq. (661) to get $\lambda(m_{\text{ph}}) = \lambda_{\text{ph}}$, then we find

$$\Lambda_{\max} \simeq m_{\text{ph}} e^{16\pi^2/3\lambda_{\text{ph}}} . \quad (681)$$

The existence of a maximum possible value for the cutoff means that we cannot take the limit as the cutoff goes to infinity; we *must* use an effective action with a cutoff as our starting point. If we insist on taking the cutoff to infinity, then the only possible value of λ_{ph} is $\lambda_{\text{ph}} = 0$. Thus, φ^4 theory is *trivial* in the limit of infinite cutoff: there are no interactions. (There is much evidence for this, but as yet no rigorous proof. The same is true of quantum electrodynamics, as was first conjectured by Landau; in this case, Λ_{\max} is known as the location of the *Landau pole*.)

However, the cutoff *can* be removed if the beta function grows no faster than λ at large λ ; then the left-hand side of eq. (679) would diverge as we take the upper limit of integration to infinity. Or, $\beta(\lambda)$ could drop to zero (and then become negative) at some finite value λ_* . Then, if $\lambda_{\text{ph}} < \lambda_*$, the left-hand side of eq. (679) would diverge as the upper limit of integration approaches λ_* . In this case, the effective coupling at higher and higher energies would remain fixed at λ_* , and $\lambda = \lambda_*$ is called an *ultraviolet fixed point* of the renormalization group.

If the beta function is negative for $\lambda = \lambda(m_{\text{ph}})$, the theory is said to be *asymptotically free*, and $\lambda(\Lambda)$ *decreases* as the cutoff is increased. In this case, there is no barrier to taking the limit $\Lambda \rightarrow \infty$. In four spacetime dimensions, the only asymptotically free theories are nonabelian gauge theories with spin-one and spin-one-half fields only.

29: Spontaneous Symmetry Breaking

Prerequisite: 3

Consider φ^4 theory, where φ is a real scalar field with lagrangian

$$\mathcal{L} = -\frac{1}{2}\partial^\mu\varphi\partial_\mu\varphi - \frac{1}{2}m^2\varphi^2 - \frac{1}{24}\lambda\varphi^4. \quad (682)$$

As we discussed in section 23, this theory has a Z_2 symmetry: \mathcal{L} is invariant under $\varphi(x) \rightarrow -\varphi(x)$, and we can define a unitary operator Z that implements this:

$$Z^{-1}\varphi(x)Z = -\varphi(x). \quad (683)$$

We also have $Z^2 = 1$, and so $Z^{-1} = Z$. Since unitarity implies $Z^{-1} = Z^\dagger$, this makes Z hermitian as well as unitary.

Now suppose that the parameter m^2 is, in spite of its name, negative rather than positive. We can write \mathcal{L} in the form

$$\mathcal{L} = -\frac{1}{2}\partial^\mu\varphi\partial_\mu\varphi - V(\varphi), \quad (684)$$

where the potential is

$$\begin{aligned} V(\varphi) &= \frac{1}{2}m^2\varphi^2 + \frac{1}{24}\lambda\varphi^4 \\ &= \frac{1}{24}\lambda(\varphi^2 - v^2)^2 - \frac{1}{24}\lambda v^4. \end{aligned} \quad (685)$$

In the second line, we have defined

$$v \equiv +(6|m^2|/\lambda)^{1/2}. \quad (686)$$

We can (and will) drop the last, constant, term in eq. (685). From eq. (685) it is clear that there are two classical field configurations that minimize the energy: $\varphi(x) = +v$ and $\varphi(x) = -v$. This is in contrast to the usual case

of positive m^2 , for which the minimum-energy classical field configuration is $\varphi(x) = 0$.

We can expect that the quantum theory will follow suit. For $m^2 < 0$, there will be two ground states, $|0+\rangle$ and $|0-\rangle$, with the property that

$$\begin{aligned}\langle 0+|\varphi(x)|0+\rangle &= +v, \\ \langle 0-|\varphi(x)|0-\rangle &= -v,\end{aligned}\tag{687}$$

up to quantum corrections from loop diagrams that we will treat in detail in section 30. These two ground states are exchanged by the operator Z ,

$$Z|0+\rangle = |0-\rangle,\tag{688}$$

and they are orthogonal: $\langle 0+|0-\rangle = 0$.

This last claim requires some comment. Consider a similar problem in quantum mechanics,

$$H = \frac{1}{2}p^2 + \frac{1}{24}\lambda(x^2 - v^2)^2.\tag{689}$$

We could find two approximate ground states in this case, specified by the approximate wave functions

$$\psi_{\pm}(x) = \langle x|0\pm\rangle \sim \exp[-\omega(x \mp v)^2/2],\tag{690}$$

where $\omega = (\lambda v^2/3)^{1/2}$ is the frequency of small oscillations about the minimum. However, the true ground state would be a symmetric linear combination of these. The antisymmetric linear combination would have a slightly higher energy, due to the effects of quantum tunneling.

We can regard a field theory as an infinite set of oscillators, one for each point in space, each with a hamiltonian like eq. (689), and coupled together by the $(\nabla\varphi)^2$ term in the field-theory hamiltonian. There is a tunneling amplitude for each oscillator, but to turn the field-theoretic state $|0+\rangle$ into $|0-\rangle$, *all* the oscillators have to tunnel, and so the tunneling amplitude gets raised to the power of the number of oscillators, that is, to the power of infinity (more precisely, to a power that scales like the volume of space). Therefore, in the limit of infinite volume, $\langle 0+|0-\rangle$ vanishes.

Thus we can pick either $|0+\rangle$ or $|0-\rangle$ to use as the ground state. Let us choose $|0+\rangle$. Then we can define a shifted field,

$$\rho(x) = \varphi(x) - v, \quad (691)$$

which obeys $\langle 0+|\rho(x)|0+\rangle = 0$. (We must still worry about loop corrections, which we will do at the end of this section.) The potential becomes

$$\begin{aligned} V(\varphi) &= \frac{1}{24}\lambda[(\rho + v)^2 - v^2]^2 \\ &= \frac{1}{6}\lambda v^2 \rho^2 + \frac{1}{6}\lambda v \rho^3 + \frac{1}{24}\lambda \rho^4, \end{aligned} \quad (692)$$

and so the lagrangian is now

$$\mathcal{L} = -\frac{1}{2}\partial^\mu \rho \partial_\mu \rho - \frac{1}{6}\lambda v^2 \rho^2 - \frac{1}{6}\lambda v \rho^3 - \frac{1}{24}\lambda \rho^4. \quad (693)$$

We see that the coefficient of the ρ^2 term is $\frac{1}{6}\lambda v^2 = |m^2|$. This coefficient should be identified as $\frac{1}{2}m_\rho^2$, where m_ρ is the mass of the the corresponding ρ particle. Also, we see that the shifted field now has a cubic as well as a quartic interaction.

Eq. (693) specifies a perfectly sensible, renormalizable quantum field theory, but it no longer has an obvious Z_2 symmetry. We say that the Z_2 symmetry is *hidden*, or *secret*, or (most popular of all) *spontaneously broken*.

This leads to a question about renormalization. If we include renormalizing Z factors in the original lagrangian, we get

$$\mathcal{L} = -\frac{1}{2}Z_\varphi \partial^\mu \varphi \partial_\mu \varphi - \frac{1}{2}Z_m m^2 \varphi^2 - \frac{1}{24}Z_\lambda \lambda \varphi^4. \quad (694)$$

For positive m^2 , these three Z factors are sufficient to absorb infinities for $d \leq 4$, where the mass dimension of λ is positive or zero. On the other hand, looking at the lagrangian for negative m^2 after the shift, eq. (693), we would seem to need an extra Z factor for the ρ^3 term. Also, once we have a ρ^3 term, we would expect to need to add a ρ term to cancel tadpoles. So, the question is, are the original three Z factors sufficient to absorb all the divergences in the Feynman diagrams derived from eq. (694)?

The answer is yes. To see why, consider the quantum action (introduced in section 21)

$$\Gamma(\varphi) = \frac{1}{2} \int \frac{d^4 k}{(2\pi)^4} \tilde{\varphi}(-k) (k^2 + m^2 - \Pi(k^2)) \tilde{\varphi}(k)$$

$$\begin{aligned}
& + \sum_{n=3}^{\infty} \frac{1}{n!} \int \frac{d^4 k_1}{(2\pi)^4} \cdots \frac{d^4 k_n}{(2\pi)^4} (2\pi)^4 \delta^4(k_1 + \cdots + k_n) \\
& \quad \times \mathbf{V}_n(k_1, \dots, k_n) \tilde{\varphi}(k_1) \cdots \tilde{\varphi}(k_n) , \tag{695}
\end{aligned}$$

computed with $m^2 > 0$. The ingredients of $\Gamma(\varphi)$ —the self-energy $\Pi(k^2)$ and the exact 1PI vertices \mathbf{V}_n —are all made finite and well-defined (in, say, the $\overline{\text{MS}}$ renormalization scheme) by adjusting the three Z factors in eq. (694). Furthermore, for $m^2 > 0$, the quantum action inherits the Z_2 symmetry of the classical action. To see this, we note that \mathbf{V}_n must zero for odd n , simply because there is no way to draw a 1PI diagram with an odd number of external lines using only a four-point vertex. Thus $\Gamma(\varphi)$ also has the Z_2 symmetry.

The quantum action also inherits any linear continuous symmetry of the classical action that is also a symmetry of the integration measure $\mathcal{D}\varphi$; see problem 29.1. (By *linear*, we mean any symmetry whose infinitesimal transformation $\delta\varphi_i(x)$ is linear in $\phi_j(x)$ and its derivatives.) This condition of invariance of the integration measure is almost always met; when it is not, the symmetry is said to be *anomalous*. We will meet an anomalous symmetry in section 75.

Once we have computed the quantum action for $m^2 > 0$, we can go ahead and consider the case of $m^2 < 0$. Recall from section 21 that the quantum equation of motion in the presence of a source is $\delta\Gamma/\delta\varphi(x) = -J(x)$, and that the solution of this equation is also the vacuum expectation value of $\varphi(x)$. Now set $J(x) = 0$, and look for a translationally invariant (that is, constant) solution $\varphi(x) = v$. If there is more than one such solution, we want the one(s) with the lowest energy. This is equivalent to minimizing the quantum potential $\mathcal{U}(\varphi)$, where

$$\Gamma(\varphi) = \int d^4x \left[-\mathcal{U}(\varphi) - \frac{1}{2}\mathcal{Z}(\varphi)\partial^\mu\varphi\partial_\mu\varphi + \dots \right] , \tag{696}$$

and the ellipses stand for terms with more derivatives. In a weakly coupled theory, we can expect the loop-corrected potential $\mathcal{U}(\varphi)$ to be qualitatively similar to the classical potential $V(\varphi)$. Therefore, for $m^2 < 0$, we expect that there are two minima of $\mathcal{U}(\varphi)$ with equal energy, located at $\varphi(x) = \pm v$, where $v = \langle 0|\varphi(x)|0\rangle$ is the exact vacuum expectation value of the field.

Thus we have a description of spontaneous symmetry breaking in the quantum theory based on the quantum action, and the quantum action is made finite by adjusting only the three Z factors that appear in the original, symmetric form of the lagrangian.

In the next section, we will see how this works in explicit calculations.

Problems

29.1) Consider a classical action $\int d^4x \mathcal{L}$ that is invariant under an infinitesimal transformation of the form

$$\delta\varphi_i(x) = \alpha D_{ij}\varphi_j(x) , \tag{697}$$

where α is an infinitesimal parameter, and D_{ij} is a matrix containing constants and (possibly) derivatives with respect to x . We assume that the integration measure $\mathcal{D}\varphi$ is also invariant. Show that $\delta\Gamma(\varphi)$ vanishes.

30: Spontaneous Symmetry Breaking and Loop Corrections

Prerequisite: 19, 29

Consider φ^4 theory, where φ is a real scalar field with lagrangian

$$\mathcal{L} = -\frac{1}{2}Z_\varphi\partial^\mu\varphi\partial_\mu\varphi - \frac{1}{2}Z_m m^2\varphi^2 - \frac{1}{24}Z_\lambda\lambda\varphi^4. \quad (698)$$

In $d = 4$ spacetime dimensions, the coupling λ is dimensionless.

We begin by considering the case $m^2 > 0$, where the Z_2 symmetry of \mathcal{L} under $\varphi \rightarrow -\varphi$ is manifest. We wish to compute the three renormalizing Z factors. We work in $d = 4 - \varepsilon$ dimensions, and take $\lambda \rightarrow \lambda\tilde{\mu}^\varepsilon$ (where $\tilde{\mu}$ has dimensions of mass) so that λ remains dimensionless.

The propagator correction $\Pi(k^2)$ is given by the diagrams of fig. (35), which yield

$$i\Pi(k^2) = \frac{1}{2}(-i\lambda\tilde{\mu}^\varepsilon)\frac{1}{i}\tilde{\Delta}(0) - i(Ak^2 + Bm^2), \quad (699)$$

where $A = Z_\varphi - 1$ and $B = Z_m - 1$, and

$$\tilde{\Delta}(0) = \int \frac{d^d\ell}{(2\pi)^d} \frac{1}{\ell^2 + m^2}. \quad (700)$$

Using the usual bag of tricks from section 14, we find

$$\tilde{\mu}^\varepsilon\tilde{\Delta}(0) = \frac{-i}{(4\pi)^2} \left[\frac{2}{\varepsilon} + 1 + \ln(\mu^2/m^2) \right] m^2, \quad (701)$$

where $\mu^2 = 4\pi e^{-\gamma}\tilde{\mu}^2$. Thus

$$\Pi(k^2) = \frac{\lambda}{2(4\pi)^2} \left[\frac{2}{\varepsilon} + 1 + \ln(\mu^2/m^2) \right] m^2 - Ak^2 - Bm^2. \quad (702)$$

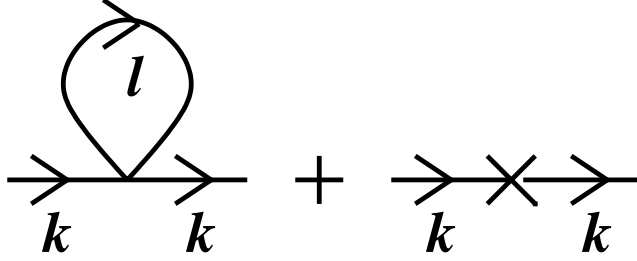

Figure 35: $O(\lambda)$ corrections to $\Pi(k^2)$.

From eq. (702) we see that we must have

$$A = O(\lambda^2), \quad (703)$$

$$B = \frac{\lambda}{16\pi^2} \left[\frac{1}{\varepsilon} + \kappa_B \right] + O(\lambda^2), \quad (704)$$

where κ_B is a finite constant. In the $\overline{\text{MS}}$ renormalization scheme, we take $\kappa_B = 0$, but we will leave κ_B arbitrary for now.

Next we turn to the vertex correction, given by the diagram of fig. (36), plus two others with $k_2 \leftrightarrow k_3$ and $k_2 \leftrightarrow k_4$; all momenta are treated as incoming. We have

$$i\mathbf{V}_4(k_1, k_2, k_3, k_4) = -iZ_\lambda\lambda + \frac{1}{2}(-i\lambda)^2 \left(\frac{1}{i}\right)^2 \left[iF(-s) + iF(-t) + iF(-u) \right] + O(\lambda^3). \quad (705)$$

Here we have defined $s = -(k_1 + k_2)^2$, $t = -(k_1 + k_3)^2$, $u = -(k_1 + k_4)^2$, and

$$iF(k^2) \equiv \tilde{\mu}^\varepsilon \int \frac{d^d\ell}{(2\pi)^d} \frac{1}{((\ell+k)^2 + m^2)(\ell^2 + m^2)} = \frac{i}{16\pi^2} \left[\frac{2}{\varepsilon} + \int_0^1 dx \ln(\mu^2/D) \right], \quad (706)$$

where $D = x(1-x)k^2 + m^2$. Setting $Z_\lambda = 1 + C$ in eq. (705), we see that we need

$$C = \frac{3\lambda}{16\pi^2} \left[\frac{1}{\varepsilon} + \kappa_C \right] + O(\lambda^2), \quad (707)$$

where κ_C is a finite constant.

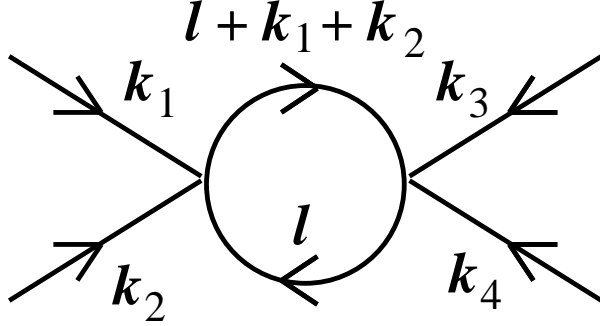

Figure 36: The $O(\lambda^2)$ correction to $V_3(k_1, k_2, k_3)$. Two other diagrams, obtained from this one via $k_2 \leftrightarrow k_3$ and $k_2 \leftrightarrow k_4$, also contribute.

We may as well pause to compute the beta function, $\beta(\lambda) = d\lambda/d\ln\mu$, where the derivative is taken with the bare coupling λ_0 held fixed, and the finite parts of the counterterms set to zero, in accord with the $\overline{\text{MS}}$ prescription. We have

$$\lambda_0 = Z_\lambda Z_\varphi^{-2} \lambda \tilde{\mu}^\varepsilon, \quad (708)$$

with

$$\ln(Z_\lambda Z_\varphi^{-2}) = \frac{3\lambda}{16\pi^2} \frac{1}{\varepsilon} + O(\lambda^2). \quad (709)$$

A review of the procedure of section 27 reveals that the first term in the beta function is given by λ times the coefficient of $1/\varepsilon$ in eq. (709). Therefore,

$$\beta(\lambda) = \frac{3\lambda^2}{16\pi^2} + O(\lambda^3). \quad (710)$$

The beta function is positive, which means that the theory becomes more and more strongly coupled at higher and higher energies.

Now we consider the more interesting case of $m^2 < 0$, which results in the spontaneous breakdown of the Z_2 symmetry.

Following the procedure of section 29, we set $\varphi(x) = \rho(x) + v$, where $v = (6|m^2|/\lambda)^{1/2}$ minimizes the potential (without Z factors). Then the lagrangian becomes (with Z factors)

$$\begin{aligned} \mathcal{L} = & -\frac{1}{2}Z_\varphi \partial^\mu \rho \partial_\mu \rho - \frac{1}{2}(\frac{3}{4}Z_\lambda - \frac{1}{4}Z_m)m_\rho^2 \rho^2 \\ & + \frac{1}{2}(Z_m - Z_\lambda)(3/\lambda \tilde{\mu}^\varepsilon)^{1/2} m_\rho^3 \rho - \frac{1}{6}Z_\lambda (3\lambda \tilde{\mu}^\varepsilon)^{1/2} m_\rho \rho^3 - \frac{1}{24}Z_\lambda \lambda \tilde{\mu}^\varepsilon \rho^4, \end{aligned} \quad (711)$$

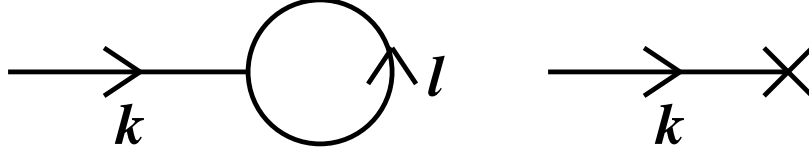

Figure 37: The $O(\lambda)$ correction to the vacuum expectation value of the ρ field.

where $m_\rho^2 = 2|m^2|$. Now we can compute various one-loop corrections.

We begin with the vacuum expectation value of ρ . The $O(\lambda)$ correction is given by the diagrams of fig. (37). The three-point vertex factor is $-iZ_\lambda g_3$, where g_3 can be read off of eq. (711):

$$g_3 = (3\lambda\tilde{\mu}^\varepsilon)^{1/2}m_\rho. \quad (712)$$

The one-point vertex factor is iY , where Y can also be read off of eq. (711):

$$Y = \frac{1}{2}(Z_m - Z_\lambda)(3/\lambda\tilde{\mu}^\varepsilon)^{1/2}m_\rho^3. \quad (713)$$

Following the discussion of section 9, we then find that

$$\langle 0|\rho(x)|0\rangle = \left(iY + \frac{1}{2}(-iZ_\lambda g_3)\frac{1}{i}\tilde{\Delta}(0) \right) \int d^4y \frac{1}{i}\Delta(x-y), \quad (714)$$

plus higher-order corrections. Using eqs. (712) and (713), and eq. (701) with $m^2 \rightarrow m_\rho^2$, the factor in large parentheses in eq. (714) becomes

$$\frac{i}{2}(3/\lambda)^{1/2}m_\rho^3 \left(Z_m - Z_\lambda + \frac{\lambda}{16\pi^2} \left[\frac{2}{\varepsilon} + 1 + \ln(\mu^2/m_\rho^2) \right] + O(\lambda^2) \right). \quad (715)$$

Using $Z_m = 1 + B$ and $Z_\lambda = 1 + C$, with B and C from eqs. (704) and (707), the factor in large parentheses in eq. (715) becomes

$$\frac{\lambda}{16\pi^2} \left[\kappa_B - \kappa_C + 1 + \ln(\mu^2/m_\rho^2) \right]. \quad (716)$$

All the $1/\varepsilon$'s have canceled. The remaining finite vacuum expectation value for $\rho(x)$ can now be removed by choosing

$$\kappa_B - \kappa_C = -1 - \ln(\mu^2/m_\rho^2). \quad (717)$$

This will also cancel all diagrams with one-loop tadpoles.

Next we consider the ρ propagator. The diagrams contributing to the $O(\lambda)$ correction are shown in fig. (38). The counterterm insertion is $-iX$, where, again reading off of eq. (711),

$$X = Ak^2 + \left(\frac{3}{4}C - \frac{1}{4}B\right)m_\rho^2. \quad (718)$$

Putting together the results of eq. (699) for the first diagram (with $m^2 \rightarrow m_\rho^2$), eq. (706) for the second (ditto), and eq. (718) for the third, we get

$$\begin{aligned} \Pi(k^2) &= -\frac{1}{2}(\lambda\tilde{\mu}^\varepsilon)\frac{1}{i}\tilde{\Delta}(0) + \frac{1}{2}g_3^2F(k^2) - X + O(\lambda^2) \\ &= \frac{\lambda}{32\pi^2}m_\rho^2\left[\frac{2}{\varepsilon} + 1 + \ln(\mu^2/m_\rho^2)\right] \\ &\quad + \frac{\lambda}{32\pi^2}m_\rho^2\left[\frac{2}{\varepsilon} + \int_0^1 dx \ln(\mu^2/D)\right] \\ &\quad - Ak^2 - \left(\frac{3}{4}C - \frac{1}{4}B\right)m_\rho^2 + O(\lambda^2). \end{aligned} \quad (719)$$

Again using eqs. (704) and (707) for B and C , we see that all the $1/\varepsilon$'s cancel, and we're left with

$$\begin{aligned} \Pi(k^2) &= \frac{\lambda}{32\pi^2}m_\rho^2\left[1 + \ln(\mu^2/m_\rho^2) + \int_0^1 dx \ln(\mu^2/D) + \frac{1}{2}(9\kappa_C - \kappa_B)\right] \\ &\quad + O(\lambda^2). \end{aligned} \quad (720)$$

We can now choose to work in an OS scheme, where we require $\Pi(-m_\rho^2) = 0$ and $\Pi'(-m_\rho^2) = 0$. We see that, to this order in λ , $\Pi(k^2)$ is independent of k^2 . Thus, we automatically have $\Pi'(-m_\rho^2) = 0$, and we can choose $9\kappa_C - \kappa_B$ to fix $\Pi(-m_\rho^2) = 0$. Together with eq. (717), this completely determines κ_B and κ_C to this order in λ .

Next we consider the one-loop correction to the three-point vertex, given by the diagrams of fig. (39). We wish to show that the infinities are canceled by the value of $Z_\lambda = 1 + C$ that we have already determined. The first diagram in fig. (39) is finite, and so for our purposes we can ignore it. The remaining three, plus the original vertex, sum up to give

$$\begin{aligned} i\mathbf{V}_3(k_1, k_2, k_3)_{\text{div}} &= -iZ_\lambda g_3 + \frac{1}{2}(-i\lambda)(-ig_3)\left(\frac{1}{i}\right)^2 \\ &\quad \times \left[iF(k_1^2) + iF(k_2^2) + iF(k_3^2)\right] \\ &\quad + O(\lambda^{5/2}), \end{aligned} \quad (721)$$

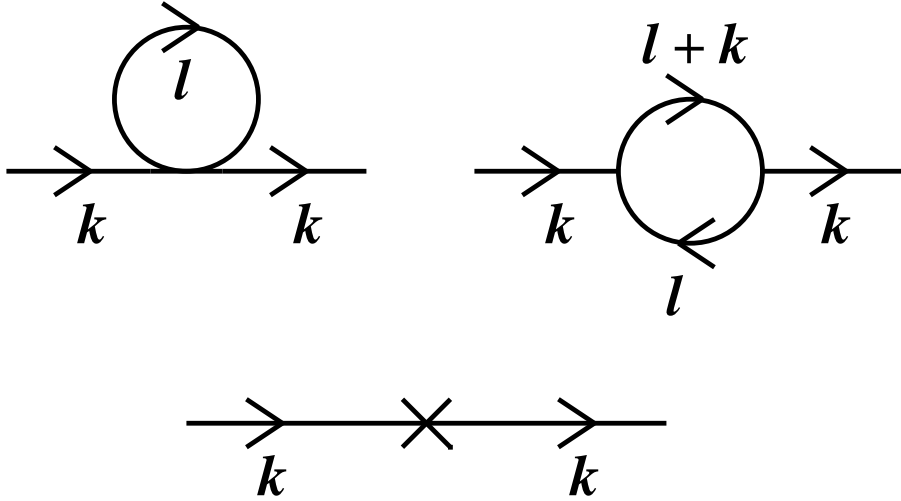

Figure 38: $O(\lambda)$ corrections to the ρ propagator.

where the subscript div means that we are keeping only the divergent part. Using eq. (706), we have

$$\mathbf{V}_3(k_1, k_2, k_3)_{\text{div}} = -g_3 \left(1 + C - \frac{3\lambda}{16\pi^2} \frac{1}{\varepsilon} + O(\lambda^2) \right). \quad (722)$$

From eq. (707), we see that the divergent terms do indeed cancel to this order in λ .

Finally, we have the correction to the four-point vertex. In this case, the divergent diagrams are just those of fig. (35), and so the calculation of the divergent part of \mathbf{V}_4 is exactly the same as it is when $m^2 > 0$ (but with m_ρ in place of m). Since we have already done that calculation (it was how we determined C in the first place), we need not repeat it.

We have thus seen how we can compute the divergent parts of the counterterms in the simpler case of $m^2 > 0$, where the Z_2 symmetry is unbroken, and that these counterterms will also serve to cancel the divergences in the more complicated case of $m^2 < 0$, where the Z_2 symmetry is spontaneously broken. This a general rule for renormalizable theories with spontaneous symmetry breaking, regardless of the nature of the symmetry group.

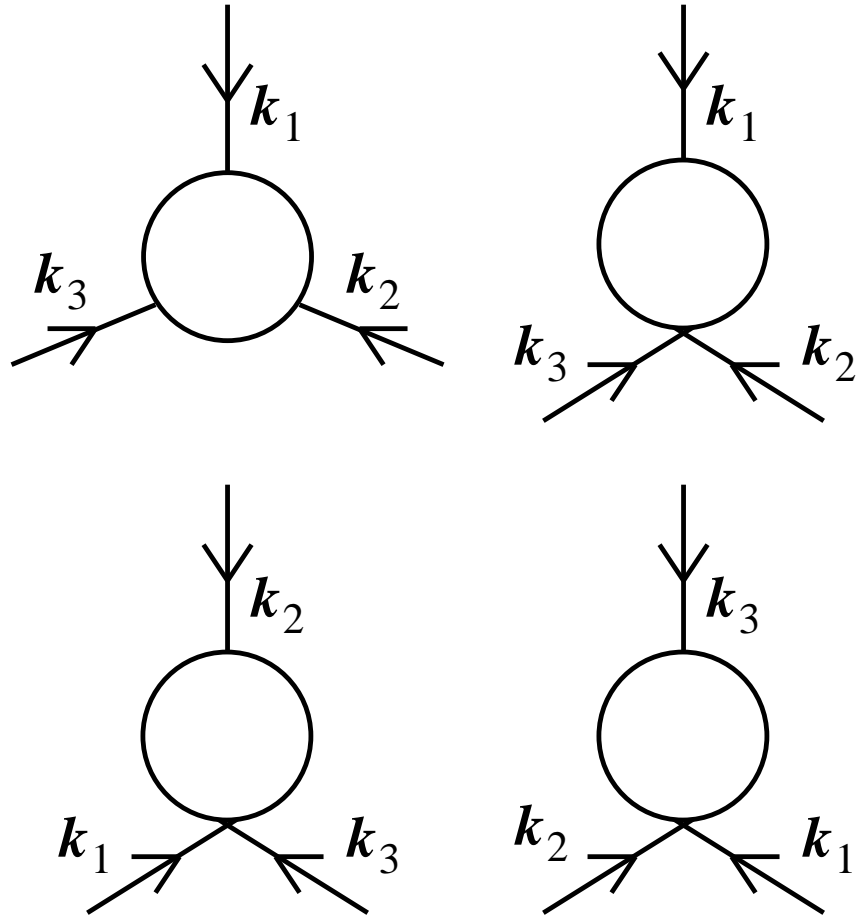

Figure 39: $O(\lambda)$ corrections to the ρ propagator.

31: Spontaneous Breakdown of Continuous Symmetries

Prerequisite: 29

Consider the theory (introduced in section 22) of a complex scalar field φ with

$$\mathcal{L} = -\partial^\mu \varphi^\dagger \partial_\mu \varphi - m^2 \varphi^\dagger \varphi - \frac{1}{4} \lambda (\varphi^\dagger \varphi)^2 . \quad (723)$$

This lagrangian is obviously invariant under the U(1) transformation

$$\varphi(x) \rightarrow e^{-i\alpha} \varphi(x) , \quad (724)$$

where α is a real number. We can also rewrite \mathcal{L} in terms of two real scalar fields by setting $\varphi = (\varphi_1 + i\varphi_2)/\sqrt{2}$ to get

$$\mathcal{L} = -\frac{1}{2} \partial^\mu \varphi_1 \partial_\mu \varphi_1 - \frac{1}{2} \partial^\mu \varphi_2 \partial_\mu \varphi_2 - \frac{1}{2} m^2 (\varphi_1^2 + \varphi_2^2) - \frac{1}{16} \lambda (\varphi_1^2 + \varphi_2^2)^2 . \quad (725)$$

In terms of φ_1 and φ_2 , the U(1) transformation becomes an SO(2) transformation,

$$\begin{pmatrix} \varphi_1(x) \\ \varphi_2(x) \end{pmatrix} \rightarrow \begin{pmatrix} \cos \alpha & \sin \alpha \\ -\sin \alpha & \cos \alpha \end{pmatrix} \begin{pmatrix} \varphi_1(x) \\ \varphi_2(x) \end{pmatrix} . \quad (726)$$

If we think of (φ_1, φ_2) as a two-component vector, then eq. (726) is just a rotation of this vector in the plane by angle α .

Now suppose that m^2 is negative. The minimum of the potential of eq. (723) is achieved for $\varphi(x) = v e^{-i\theta}/\sqrt{2}$, where $v = (4|m^2|/\lambda)^{1/2}$ and the phase θ is arbitrary. (The factor of the square root of two is conventional). Thus we have a continuous family of minima of the potential, parameterized by θ . Under the U(1) transformation of eq. (724), θ changes to $\theta + \alpha$; thus the different minimum-energy field configurations are all related to each other by the symmetry.

In the quantum theory, we therefore expect to find a continuous family of ground states, labeled by θ , with the property that

$$\langle \theta | \varphi(x) | \theta \rangle = \frac{1}{\sqrt{2}} v e^{-i\theta} . \quad (727)$$

Also, according to the discussion in section 29, we expect $\langle \theta' | \theta \rangle = 0$ for $\theta' \neq \theta$.

Returning to classical language, there is a *flat direction* in field space that we can move along without changing the energy. The physical consequence of this is the existence of a massless particle called a *Goldstone boson*.

Let us see how this works, first using the SO(2) form of the theory, eq. (725). We will choose the phase $\theta = 0$, and write

$$\begin{aligned} \varphi_1(x) &= v + a(x) , \\ \varphi_2(x) &= b(x) . \end{aligned} \quad (728)$$

Substituting this into eq. (725), we find

$$\begin{aligned} \mathcal{L} &= -\frac{1}{2} \partial^\mu a \partial_\mu a - \frac{1}{2} \partial^\mu b \partial_\mu b \\ &\quad - |m^2| a^2 - \frac{1}{2} \lambda^{1/2} |m| a (a^2 + b^2) - \frac{1}{16} \lambda (a^2 + b^2)^2 . \end{aligned} \quad (729)$$

We see from this that the a field has a mass given by $\frac{1}{2} m_a^2 = |m^2|$. The b field, on the other hand, is massless, and we identify it as the Goldstone boson.

A different parameterization brings out the role of the massless field more clearly. In terms of the complex field $\varphi(x)$, we write

$$\varphi(x) = \frac{1}{\sqrt{2}} (v + \rho(x)) \exp(-i\chi(x)/v) . \quad (730)$$

Substituting this into eq. (723), we get

$$\begin{aligned} \mathcal{L} &= -\frac{1}{2} \partial^\mu \rho \partial_\mu \rho - \frac{1}{2} \left(1 + \frac{\rho}{v}\right)^2 \partial^\mu \chi \partial_\mu \chi \\ &\quad - |m^2| \rho^2 - \frac{1}{2} \lambda^{1/2} |m| \rho^3 - \frac{1}{16} \lambda \rho^4 . \end{aligned} \quad (731)$$

We see from this that the ρ field has a mass given by $\frac{1}{2} m_\rho^2 = |m^2|$, and that the χ field is massless. These are the same particle masses we found using the parameterization of eq. (728). This is not an accident: the particle masses

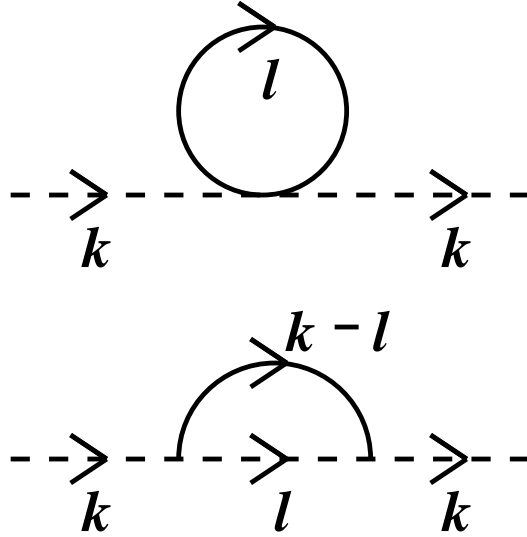

Figure 40: $O(\lambda)$ corrections to the χ propagator.

and scattering amplitudes should be independent of how we choose to write the fields.

Note that the χ field does not appear in the potential at all. Thus it parameterizes the flat direction. In terms of the ρ and χ fields, the $U(1)$ transformation takes the simple form $\chi(x) \rightarrow \chi(x) + \alpha$.

Does the masslessness of the χ field survive loop corrections? It does. We will first give a diagrammatic proof, and then a general argument based on properties of the quantum action.

Before proceeding to diagrams, recall from section 30 that (in a renormalizable theory) we can cancel all divergences by including renormalizing Z factors in the original, symmetric form of the lagrangian [in the case at hand, either eq. (723) or (725)] with $m^2 > 0$. This is important because the lagrangian in the form of eq. (731) looks nonrenormalizable. The coefficients of the interaction terms $\rho \partial^\mu \chi \partial_\mu \chi$ and $\rho^2 \partial^\mu \chi \partial_\mu \chi$ are v^{-1} and v^{-2} , which have mass dimension -1 and -2 . Coupling constants with negative mass dimension usually signal nonrenormalizability, but here we know that the hidden $U(1)$ symmetry saves us from this disaster.

Consider, then, the one-loop corrections to the χ propagator shown in

fig. (40). The three-point vertex factor is $2iv^{-1}k_1 \cdot k_2$, where k_1 and k_2 are the two momenta on the χ lines (both treated as incoming), and the four-point vertex factor is $2iv^{-2}k_1 \cdot k_2$. The first diagram thus has a vertex factor of $-2iv^{-2}k^2$, and the loop contributes a factor of $\frac{1}{i}\tilde{\Delta}(0)$. The important point is that the diagram is proportional to k^2 ; there is no term independent of k^2 , which would contribute to a mass term for the χ field. The second diagram is proportional to $(k \cdot \ell)^2/(\ell^2 + m_\rho^2)$. When we integrate over ℓ , we can use the identity

$$\int d^d\ell \ell^\mu \ell^\nu f(\ell^2) = \frac{1}{d} g^{\mu\nu} \int d^d\ell \ell^2 f(\ell^2). \quad (732)$$

To get eq. (732), we note that, by Lorentz invariance, the integral on the left-hand side must be proportional to $g^{\mu\nu}$; we then verify the equality by contracting each side with $g_{\mu\nu}$. Therefore,

$$\int d^d\ell \frac{(k \cdot \ell)^2}{\ell^2 + m_\rho^2} \propto k^2. \quad (733)$$

Thus we see that the second diagram is also proportional to k^2 . It should be clear that this will be true of any diagram we draw, because of the nature of the vertices. Thus, the χ particle remains exactly massless.

The same conclusion can be reached by considering the quantum action $\Gamma(\varphi)$, which includes all loop corrections. According to our discussion in section 29, the quantum action has the same symmetries as the classical action. Therefore, in the case at hand,

$$\Gamma(\varphi) = \Gamma(e^{-i\alpha}\varphi). \quad (734)$$

Spontaneous symmetry breaking occurs if the minimum of $\Gamma(\varphi)$ is at a constant, nonzero value of φ . Because of eq. (734), the phase of this constant is arbitrary. Therefore, there must be a flat direction in field space, corresponding to the phase of $\varphi(x)$. The physical consequence of this flat direction is a massless particle, the Goldstone boson.

32: Nonabelian Symmetries

Prerequisite: 31

Consider the theory (introduced in section 22) of a two real scalar fields φ_1 and φ_2 with

$$\mathcal{L} = -\frac{1}{2}\partial^\mu\varphi_1\partial_\mu\varphi_1 - \frac{1}{2}\partial^\mu\varphi_2\partial_\mu\varphi_2 - \frac{1}{2}m^2(\varphi_1^2 + \varphi_2^2) - \frac{1}{16}\lambda(\varphi_1^2 + \varphi_2^2)^2. \quad (735)$$

We can generalize this to the case of N real scalar fields φ_i with

$$\mathcal{L} = -\frac{1}{2}\partial^\mu\varphi_i\partial_\mu\varphi_i - \frac{1}{2}m^2\varphi_i\varphi_i - \frac{1}{16}\lambda(\varphi_i\varphi_i)^2, \quad (736)$$

where a repeated index is summed. This lagrangian is clearly invariant under the $\text{SO}(N)$ transformation

$$\varphi_i(x) \rightarrow R_{ij}\varphi_j(x), \quad (737)$$

where R is an orthogonal matrix with unit determinant: $R^T = R^{-1}$, $\det R = +1$. (This lagrangian is also clearly invariant under the Z_2 symmetry $\varphi_i(x) \leftrightarrow -\varphi_i(x)$, which enlarges $\text{SO}(N)$ to $\text{O}(N)$; however, in this section we will be concerned with the continuous $\text{SO}(N)$ part of the symmetry.)

Next we will need some results from group theory. Consider an infinitesimal $\text{SO}(N)$ transformation,

$$R_{ij} = \delta_{ij} - \theta_{ij} + O(\theta^2). \quad (738)$$

Orthogonality of R implies that θ is real and antisymmetric. It is convenient to express θ in terms of a basis set of hermitian matrices $(T^a)_{ij}$. The index a runs from 1 to $\frac{1}{2}N(N-1)$, the number of linearly independent, hermitian, antisymmetric, $N \times N$ matrices. We can, for example, choose each T^a to have

a single nonzero entry $-i$ above the main diagonal, and a corresponding $+i$ below the main diagonal. These matrices obey the normalization condition

$$\text{Tr}(T^a T^b) = 2\delta^{ab} . \quad (739)$$

In terms of them, we can write $\theta_{jk} = i\theta^a (T^a)_{jk}$, where θ^a is a set of $\frac{1}{2}N(N-1)$ real, infinitesimal parameters.

The T^a 's are the *generator matrices* of $\text{SO}(N)$. The product of any two $\text{SO}(N)$ rotations is another $\text{SO}(N)$ rotation. This implies that the commutator of any two T^a 's must be a linear combination of T^a 's:

$$[T^a, T^b] = i f^{abc} T^c . \quad (740)$$

The real numerical factors f^{abc} in eq. (740) are the *structure coefficients* of the group. If $f^{abc} = 0$, the group is *abelian*. Otherwise, it is *nonabelian*. Thus, $\text{U}(1)$ and $\text{SO}(2)$ are abelian groups (since they each have only one generator that obviously must commute with itself), and $\text{SO}(N)$ for $N \geq 3$ is nonabelian.

If we multiply eq. (740) on the right by T^d , take the trace, and use eq. (739), we find

$$f^{abd} = -\frac{1}{2}i \text{Tr}([T^a, T^b]T^d) . \quad (741)$$

Using the cyclic property of the trace, we find that f^{abd} must be completely antisymmetric. Taking the complex conjugate of eq. (741) (and remembering that the T^a 's are hermitian matrices), we find that f^{abd} must be real.

The simplest nonabelian group is $\text{SO}(3)$. In this case, we can choose $(T^a)_{ij} = -i\varepsilon^{aij}$, where ε^{ijk} is the completely antisymmetric Levi-Civita symbol, with $\varepsilon^{123} = +1$. The commutation relations become

$$[T^a, T^b] = i\varepsilon^{abc} T^c . \quad (742)$$

That is, the structure coefficients of $\text{SO}(3)$ are given by $f^{abc} = \varepsilon^{abc}$.

Let us return to eq. (736), and consider the case $m^2 < 0$. The minimum of the potential of eq. (736) is achieved for $\varphi_i(x) = v_i$, where $v^2 = v_i v_i = 4|m^2|/\lambda$, and the direction in which the N -component vector \vec{v} points is arbitrary. In the quantum theory, we interpret v_i as the vacuum expectation value of the quantum field $\varphi_i(x)$. We can choose our coordinate system so

that $v_i = v\delta_{iN}$; that is, the vacuum expectation value lies entirely in the last component.

Now consider making an infinitesimal $\text{SO}(N)$ transformation,

$$\begin{aligned}
v_i &\rightarrow R_{ij}v_j \\
&= v_i - \theta_{ij}v_j \\
&= v_i - i\theta^a(T^a)_{ij}v_j \\
&= v\delta_{iN} - i\theta^a(T^a)_{iN}v .
\end{aligned} \tag{743}$$

For some choices of θ^a , the second term on the right-hand side of eq. (743) vanishes. This happens if the corresponding T^a has no nonzero entry in the last column. Recall that each T^a has a single $-i$ above the main diagonal (and a corresponding $+i$ below the main diagonal). Thus, there are $N-1$ T^a 's with a nonzero entry in the last column: those with the $-i$ in the first row and last column, in the second row and last column, etc, down to the $N-1^{\text{th}}$ row and last column. These T^a 's are said to be *broken* generators: a generator is broken if $(T^a)_{ij}v_j \neq 0$, and unbroken if $(T^a)_{ij}v_j = 0$.

An infinitesimal $\text{SO}(N)$ transformation that involves a broken generator changes the vacuum expectation value of the field, but not the energy. Thus, each broken generator corresponds to a *flat direction* in field space. Each flat direction implies the existence of a corresponding massless particle. This is *Goldstone's theorem*: there is one massless Goldstone boson for each broken generator.

The unbroken generators, on the other hand, do not change the vacuum expectation value of the field. Therefore, after rewriting the lagrangian in terms of shifted fields (each with zero vacuum expectation value), there should still be a manifest symmetry corresponding to the set of unbroken generators. In the present case, the number of unbroken generators is

$$\frac{1}{2}N(N-1) - (N-1) = \frac{1}{2}(N-1)(N-2) . \tag{744}$$

This is the number of generators of $\text{SO}(N-1)$. Therefore, we expect $\text{SO}(N-1)$ to be an obvious symmetry of the lagrangian after it is written in terms of shifted fields.

Let us see how this works in the present case. We can rewrite eq. (736) as

$$\mathcal{L} = -\frac{1}{2}\partial^\mu\varphi_i\partial_\mu\varphi_i - V(\varphi) , \quad (745)$$

with

$$V(\varphi) = \frac{1}{16}\lambda(\varphi_i\varphi_i - v^2)^2 , \quad (746)$$

where $v = (4|m^2|/\lambda)^{1/2}$, and the repeated index i is implicitly summed from 1 to N . Now let $\varphi_N(x) = v + \rho(x)$, and plug this into eq. (745). With the repeated index i now implicitly summed from 1 to $N-1$, we have

$$\mathcal{L} = -\frac{1}{2}\partial^\mu\varphi_i\partial_\mu\varphi_i - \frac{1}{2}\partial^\mu\rho\partial_\mu\rho - V(\rho, \varphi) , \quad (747)$$

where

$$\begin{aligned} V(\rho, \varphi) &= \frac{1}{16}\lambda[(v+\rho)^2 + \varphi_i\varphi_i - v^2]^2 \\ &= \frac{1}{16}\lambda(2v\rho + \rho^2 + \varphi_i\varphi_i)^2 \\ &= \frac{1}{4}\lambda v^2\rho^2 + \frac{1}{4}\lambda v\rho(\rho^2 + \varphi_i\varphi_i)^2 + \frac{1}{16}\lambda(\rho^2 + \varphi_i\varphi_i)^2 . \end{aligned} \quad (748)$$

There is indeed a manifest $\text{SO}(N-1)$ symmetry in eqs. (747) and (748). Also, the $N-1$ φ_i fields are massless: they are the expected $N-1$ Goldstone bosons.

Consider now a theory with N *complex* scalar fields φ_i , and a lagrangian

$$\mathcal{L} = -\partial^\mu\varphi_i^\dagger\partial_\mu\varphi_i - m^2\varphi_i^\dagger\varphi_i - \frac{1}{4}\lambda(\varphi_i^\dagger\varphi_i)^2 , \quad (749)$$

where a repeated index is summed. This lagrangian is clearly invariant under the $\text{U}(N)$ transformation

$$\varphi_i(x) \rightarrow U_{ij}\varphi_j(x) , \quad (750)$$

where U is a unitary matrix: $U^\dagger = U^{-1}$. We can write $U_{ij} = e^{-i\theta}\tilde{U}_{ij}$, where θ is a real parameter and $\det\tilde{U}_{ij} = +1$; \tilde{U}_{ij} is called a *special* unitary matrix. Clearly the product of two special unitary matrices is another special unitary matrix; the $N \times N$ special unitary matrices form the group $\text{SU}(N)$. The group $\text{U}(N)$ is the *direct product* of the group $\text{U}(1)$ and the group $\text{SU}(N)$; we write $\text{U}(N) = \text{U}(1) \times \text{SU}(N)$.

Consider an infinitesimal $SU(N)$ transformation,

$$\tilde{U}_{ij} = \delta_{ij} - i\theta^a (T^a)_{ij} + O(\theta^2), \quad (751)$$

where θ^a is a set of real, infinitesimal parameters. Unitarity of \tilde{U} implies that the generator matrices T^a are hermitian, and $\det \tilde{U} = +1$ implies that each T^a is traceless. (This follows from the general matrix formula $\ln \det A = \text{Tr} \ln A$.) The index a runs from 1 to N^2-1 , the number of linearly independent, hermitian, traceless, $N \times N$ matrices. We can choose these matrices to obey the normalization condition of eq. (739). For $SU(2)$, the generators can be chosen to be the Pauli matrices; the structure coefficients of $SU(2)$ then turn out to be $f^{abc} = 2\varepsilon^{abc}$, the same as those of $SO(3)$, up to an irrelevant overall factor [which could be removed by changing the numerical factor on right-hand side of eq. (739) from 2 to $\frac{1}{2}$].

For $SU(N)$, we can choose the T^a 's in the following way. First, there are the $SO(N)$ generators, with one $-i$ above the main diagonal a corresponding $+i$ below; there are $\frac{1}{2}N(N-1)$ of these. Next, we get another set by putting one $+1$ above the main diagonal and a corresponding $+1$ below; there are $\frac{1}{2}N(N-1)$ of these. Finally, there are diagonal matrices with n 1's along the main diagonal, followed a single entry $-n$, followed by zeros [times an overall normalization constant to enforce eq. (739)]; there are $N-1$ of these. The total is N^2-1 , as required.

We could now return to eq. (749), consider the case $m^2 < 0$, and examine spontaneous breaking of the $U(N)$ symmetry. However, the lagrangian of eq. (749) is actually invariant under a larger symmetry group, namely $SO(2N)$. To see this, write each complex scalar field in terms of two real scalar fields, $\varphi_j = (\varphi_{j1} + i\varphi_{j2})/\sqrt{2}$. Then

$$\varphi_j^\dagger \varphi_j = \frac{1}{2}(\varphi_{11}^2 + \varphi_{12}^2 + \dots + \varphi_{N1}^2 + \varphi_{N2}^2). \quad (752)$$

Thus, we have $2N$ real scalar fields that enter \mathcal{L} symmetrically, and so the actual symmetry group of eq. (745) is $SO(2N)$, rather than just the obvious subgroup $U(N)$.

We will, however, meet the $SU(N)$ groups again in Parts II and III, where they will play a more important role.