

On the structure of Verma modules over Virasoro and Neveu-Schwarz algebras.

A. Astashkevich ^{*†}

October 28, 1995

1 Introduction

The main goal of this paper is to present a different proof of the theorem of B. L. Feigin and D. B. Fuchs (see [Fe-Fu 1]) about the structure of Verma modules over Virasoro algebra and to state some new results about the structure of Verma modules over Neveu-Schwarz algebra. This proof has two advantages: first, it is simpler in the most interesting cases (for example in the so called minimal models), and second, it can be generalized for Neveu-Schwarz algebra for some class of Verma modules.

This text arose as a result of trying to understand the original proof of B. L. Feigin and D. B. Fuchs. The original proof uses some facts about Jantzen's filtration which I could not prove and nobody could explain to me. That is why I tried to find another proof.

I would like to express my deep gratitude to M. Finkelberg, E. Frenkel and W. Soergel for valuable discussions. I am happy to thank Professor V.G. Kac for his interest in my work and his questions. I am greatly indebted to D.B. Fuchs for numerous conversations and his constant care.

^{*}Supported by Rosenbaum Fellowship

[†]Department of Mathematics, MIT, Cambridge, MA 02139
e-mail address: ast@math.mit.edu

2 Notation

2.1 Virasoro algebra and Verma modules.

Let \mathcal{L} be the Lie algebra of algebraic vector fields on \mathbf{C}^* with the basis L_i , $i \in \mathbf{Z}$ and commutators

$$[L_i, L_j] = (j - i)L_{i+j}.$$

The Virasoro algebra, $\mathcal{V}ir$, is a one dimensional central extension of \mathcal{L} corresponding to the cocycle $(L_i, L_j) \rightarrow \delta_{-i,j} \frac{(j^3 - j)}{12}$. We have the following basis in the Virasoro algebra L_i , $i \in \mathbf{Z}$ and C and commutators

$$[L_i, C] = 0,$$

$$[L_i, L_j] = (j - i)L_{i+j} + \delta_{-i,j} \frac{(j^3 - j)}{12} C.$$

Both algebras are \mathbf{Z} -graded: $\deg L_i = i$ and $\deg C = 0$. Let us denote by \mathfrak{h} a Lie algebra with the basis L_0 and C , by \mathfrak{n}^- a Lie algebra with the basis $\{L_{-i}, i \in \mathbf{N}\}$, and by \mathfrak{n}^+ a Lie algebra with the basis $\{L_i, i \in \mathbf{N}\}$. We also denote by \mathfrak{b}^+ a Lie algebra with the basis L_i and C , $i \in \mathbf{Z}_+$. All these algebras \mathfrak{h} , \mathfrak{n}^- , \mathfrak{n}^+ and \mathfrak{b}^+ are subalgebras of $\mathcal{V}ir$. We have a Cartan type decomposition of $\mathcal{V}ir$

$$\begin{aligned} \mathcal{V}ir &= \mathfrak{n}^- \oplus \mathfrak{h} \oplus \mathfrak{n}^+ \\ \mathcal{V}ir &= \mathfrak{n}^- \oplus \mathfrak{b}^+. \end{aligned}$$

Let $h, c \in \mathbf{C}$. Let us consider a one dimensional module $\mathbf{C}_{h,c}$ over \mathfrak{b}^+ such that \mathfrak{n}^+ acts by zero, L_0 is a multiplication by h and C is a multiplication by c . Verma module $M_{h,c}$ over the Virasoro algebra is by definition an induced module from $\mathbf{C}_{h,c}$

$$M_{h,c} = \text{Ind}_{\mathfrak{b}^+}^{\mathcal{V}ir} \mathbf{C}_{h,c}.$$

We have a natural inclusion of $\mathbf{C}_{h,c} \hookrightarrow M_{h,c}$. So we have a vector $\mathbf{v} \in M_{h,c}$ corresponding to $\mathbf{1} \in \mathbf{C}_{h,c}$. Sometimes we will write $\mathbf{v}_{h,c}$ to stress that this vector lies in $M_{h,c}$. Vector \mathbf{v} is called the vacuum vector.

Let us make a few remarks about Verma modules. First, any Verma module $M_{h,c}$ is a free module over $\mathbf{U}(\mathfrak{n}^-)$. Therefore, we have the following basis in $M_{h,c}$:

$$L_{-i_k} L_{-i_{k-1}} \dots L_{-i_2} L_{-i_1} \mathbf{v}_{h,c}$$

where $i_k \geq i_{k-1} \geq \dots \geq i_1 \geq 1$.

The operator L_0 on $M_{h,c}$ is semisimple. We can consider the eigenspace decomposition of $M_{h,c}$,

$$M_{h,c} = \bigoplus_{i=0}^{\infty} M_{h,c}^i,$$

where L_0 acts as a multiplication by $h - i$ on $M_{h,c}^i$. It is easy to see that this decomposition respects the grading on $\mathcal{V}ir$. We say that vector $\mathbf{w} \in M_{h,c}$ has level n if $\mathbf{w} \in M_{h,c}^n$.

Vector \mathbf{w} is called singular if it has some level n ($n \in \mathbf{Z}_+$) and \mathfrak{n}^+ acts by zero on this vector. It is obvious that any singular vector generates a submodule isomorphic to Verma module. If a singular vector has level n then it generates $M_{h-n,c}$.

2.2 Categories \mathcal{O}_c , \mathcal{O} , Shapovalov's form and Kac determinant formula.

Let us define categories \mathcal{O}_c and \mathcal{O} .

We say that module $\mathbf{M} \in \mathcal{O}_c$ if it satisfies the following conditions:

- 1) C acts on \mathbf{M} as a multiplication by c .
- 2) L_0 acts semisimply on \mathbf{M} and we have a decomposition of \mathbf{M}

$$\mathbf{M} = \bigoplus_{h \in \mathbf{C}} \mathbf{M}_h, \quad \text{where } L_0 \text{ acts on } \mathbf{M}_h \text{ as a multiplication by } h$$

and $\dim(\mathbf{M}_h) < \infty$ for any $h \in \mathbf{C}$.

3) \mathfrak{n}^+ acts locally finite on \mathbf{M} . This means that for any $\mathbf{w} \in \mathbf{M}$, $\mathbf{U}(\mathfrak{n}^+) \mathbf{w}$ is a finite dimensional space.

We define category \mathcal{O} as a direct sum of \mathcal{O}_c over all $c \in \mathbf{C}$.

Example: Module $M_{h,c} \in \mathcal{O}_c$.

Let us define for every module $\mathbf{M} \in \mathcal{O}_c$ a contragredient module $\overline{\mathbf{M}} \in \mathcal{O}_c$ in the following way:

$$\overline{\mathbf{M}}_h \stackrel{def}{=} \mathbf{M}'_h$$

L_i acts on $\overline{\mathbf{M}}$ as L'_{-i} and C acts as a multiplication by c .

It is obvious that $\mathbf{w} \stackrel{def}{=} \mathbf{v}'_{h,c} \in \overline{\mathbf{M}}_{h,c}$ is a singular vector thus we get a map $\mathbf{B} : M_{h,c} \rightarrow M'_{h,c}$. This map defines a bilinear form on the module $M_{h,c}$ (Shapovalov's form). One can show that this form is symmetric. By definition this form is contravariant. It is easy to check that the spaces, $M_{h,c}^n$ and $M_{h,c}^m$ for $n \neq m$ are orthogonal. Since we have a basis in $M_{h,c}^n$ we can calculate the determinant of the form \mathbf{B}_n - restriction of \mathbf{B} on $M_{h,c}^n$. The result is well known.

Kac determinant formula:

$$\det^2(\mathbf{B}_n) = Const \prod_{\substack{k,l \\ kl \leq n}} \Phi_{k,l}(h,c)^{p(n-kl)}, \quad \text{where}$$

$$\Phi_{k,l}(h,c) = \left(h + \frac{(k^2-1)(c-13)}{24} + \frac{(kl-1)}{2} \right) \left(h + \frac{(l^2-1)(c-13)}{24} + \frac{(kl-1)}{2} \right) + \frac{(k^2-l^2)^2}{16}.$$

This formula gives us a condition under which the module $M_{h,c}$ is irreducible. It is obvious that if Verma module is reducible then it contains at least one singular vector.

Remark. We can define the form \mathbf{B} in another way. Let $\omega : \mathbf{U}(\mathcal{V}ir) \rightarrow \mathbf{U}(\mathcal{V}ir)$ be an anti-involution such that

$$\begin{aligned} \omega(L_i) &\stackrel{def}{=} L_{-i} \\ \omega(C) &\stackrel{def}{=} C. \end{aligned}$$

Let for $\mathbf{w} \in M_{h,c}$, $\langle \mathbf{w} \rangle$ be the vacuum expectation value

$$\langle \mathbf{w} \rangle \stackrel{def}{=} \mathbf{a}, \quad \text{where}$$

$$\mathbf{w} = \mathbf{a}\mathbf{v}_{h,c} + \sum_{i_k \geq i_{k-1} \geq \dots \geq i_1 \geq 1} \mathbf{a}_{i_1, \dots, i_k} L_{-i_k} L_{-i_{k-1}} \dots L_{-i_2} L_{-i_1} \mathbf{v}_{h,c}.$$

Then for $x, y \in \mathbf{U}(\mathcal{V}ir)$ we have

$$\mathbf{B}(x(\mathbf{v}_{h,c}), y(\mathbf{v}_{h,c})) \stackrel{def}{=} \langle \omega(x)y(\mathbf{v}_{h,c}) \rangle.$$

2.3 References.

All these facts are well-known and can be found in [Kac-Ra] or [Fe-Fu 1].

3 Singular vectors in Verma modules over Virasoro

Theorem 3.1. ([Fu 1]) *At each level n only one singular vector \mathbf{w} can exist. If a singular vector \mathbf{w} exists then we have the following formula for it*

$$\mathbf{w} = (L_{-1})^n \mathbf{v}_{h,c} + \sum_{\substack{i_k + \dots + i_1 = n \\ i_k \geq i_{k-1} \geq \dots \geq i_1 \geq 1 \\ i_k \geq 2}} \mathbf{P}_{i_1, \dots, i_k}^{(n)}(h, c) L_{-i_k} L_{-i_{k-1}} \dots L_{-i_2} L_{-i_1} \mathbf{v}_{h,c}$$

which defines \mathbf{w} up to multiplication by a constant. $\mathbf{P}_{i_1, \dots, i_k}^{(n)}(h, c)$ are polynomials in h and c .

Proof: First of all, any element $\mathbf{w} \in M_{h,c}^n$ can be written in a unique way in the form:

$$\mathbf{w} = \mathbf{a}(L_{-1})^n \mathbf{v}_{h,c} + \sum_{\substack{i_k + \dots + i_1 = n \\ i_k \geq i_{k-1} \geq \dots \geq i_1 \geq 1 \\ i_k \geq 2}} \mathbf{a}_{i_1, \dots, i_k} L_{-i_k} L_{-i_{k-1}} \dots L_{-i_2} L_{-i_1} \mathbf{v}_{h,c}.$$

Let us order the monomials, $L_{-i_k} L_{-i_{k-1}} \dots L_{-i_2} L_{-i_1}$ ($i_k \geq i_{k-1} \geq \dots \geq i_1 \geq 1$), in the following way. We say that $L_{-i_k} L_{-i_{k-1}} \dots L_{-i_2} L_{-i_1}$ is greater than $L_{-j_l} L_{-j_{l-1}} \dots L_{-j_2} L_{-j_1}$ if $i_1 = j_1, i_2 = j_2, \dots, i_m = j_m$ and $i_{m+1} > j_{m+1}$ for some m .

Example: $(L_{-1})^n < L_{-2}(L_{-1})^{n-2} < L_{-3}(L_{-1})^{n-3} < \dots$

Let us assume that \mathbf{w} is a singular vector. This means that for any $i \geq 1$ $L_i \mathbf{w} = 0$. Our goal is to express all coefficients $\mathbf{a}_{i_1, \dots, i_k}$ as

$\mathbf{a} \times (\text{some polynomial depending only on } h \text{ and } c)$.

We will show that this can be done by induction. If we know all coefficients $\mathbf{a}_{i_1, \dots, i_k}$ for $L_{-i_k} L_{-i_{k-1}} \dots L_{-i_2} L_{-i_1} < L_{-j_l} L_{-j_{l-1}} \dots L_{-j_2} L_{-j_1}$ then we can express the coefficient $\mathbf{a}_{j_1, \dots, j_l}$ as a sum of $\mathbf{a}_{i_1, \dots, i_k} \mathbf{Q}_{i_1, \dots, i_k}(h, c)$, where $\mathbf{Q}_{i_1, \dots, i_k}(h, c)$ are polynomials in h and c .

Let $j_1 = j_2 = \dots = j_s = 1$ and $j_{s+1} > 1$. Then let us calculate the coefficient

$$\text{at } L_{-j_l} L_{-j_{l-1}} \dots L_{-j_{s+2}} (L_{-1})^{s+1} \mathbf{v}_{h,c} \text{ in } L_{j_{s+1}-1} \mathbf{w}.$$

One can see that it has the following form:

$$(2j_{s+1} - 1) \mathbf{a}_{j_1, \dots, j_l} + \\ + \sum_{\substack{i_k \geq i_{k-1} \geq \dots \geq i_1 \geq 1 \\ L_{-i_k} L_{-i_{k-1}} \dots L_{-i_2} L_{-i_1} < L_{-j_l} L_{-j_{l-1}} \dots L_{-j_2} L_{-j_1}}} \mathbf{a}_{i_1, \dots, i_k} \mathbf{Q}_{i_1, \dots, i_k}(h, c),$$

where $\mathbf{a}_{1, \dots, 1} = \mathbf{a}$. Since this coefficient equals zero we can express $\mathbf{a}_{j_1, \dots, j_l}$ as a sum of $\mathbf{a}_{i_1, \dots, i_k} \mathbf{Q}_{i_1, \dots, i_k}(h, c)$, where $\mathbf{Q}_{i_1, \dots, i_k}(h, c)$ are polynomials in h and c , and the sum is over such indices i_1, \dots, i_k that

$$L_{-i_k} L_{-i_{k-1}} \dots L_{-i_2} L_{-i_1} < L_{-j_l} L_{-j_{l-1}} \dots L_{-j_2} L_{-j_1}.$$

By induction we immediately get that $\mathbf{a}_{j_1, \dots, j_l}$ is of the form

$$\mathbf{a} \times (\text{some polynomial depending only on } h, c).$$

From this the proposition follows immediately.

Q.E.D.

Now let us look at the Kac determinant formula:

$$\det^2(\mathbf{B}_n) = \text{Const} \prod_{\substack{k, l \\ kl \leq n}} \Phi_{k,l}(h, c).$$

Equation $\Phi_{k,l}(h, c) = 0$ defines a rational curve (\mathbf{C}^*) in \mathbf{C}^2 . This curve can be given by the formulas:

$$h(t) = \frac{1 - k^2}{4}t + \frac{1 - kl}{2} + \frac{1 - l^2}{4}t^{-1},$$

$$c(t) = 6t + 13 + 6t^{-1}.$$

Denote this curve by $\mathcal{F}(k, l)$.

The Kac determinant formula shows that for almost all $t \in \mathbf{C}^*$ (except finite number) there exist a singular vector in $M_{h(t), c(t)}$ at level kl . We get the following corollary of proposition 3.1.

Corollary 3.2. ([Fu 1]) *For any natural numbers k and l there exist a unique map $\mathbf{S}_{k,l} : \mathcal{F}(k, l) \rightarrow \mathbf{U}(\mathfrak{n}^-)_{kl}$ which has the following form:*

$$\mathbf{S}_{k,l}(t) = \sum_{\substack{i_k + \dots + i_1 = kl \\ i_r \geq i_{r-1} \geq \dots \geq i_1 \geq 1}} \mathbf{P}_{i_1, \dots, i_r}^{k,l}(t) L_{-i_r} L_{-i_{r-1}} \dots L_{-i_2} L_{-i_1} \mathbf{v}_{h,c}$$

where $\mathbf{P}_{1, \dots, 1}^{k,l} \equiv 1$ and $\mathbf{P}_{i_1, \dots, i_r}^{k,l}(t)$ is a polynomial in t and t^{-1} for any i_1, \dots, i_r and such that $\mathbf{S}_{k,l}(t) \mathbf{v}_{h,c}$ is a singular vector in the module $M_{h(t), c(t)}$, where $h(t)$ and $c(t)$ are given by the formulas above (i.e., t is a parameter on the curve $\mathcal{F}(k, l)$).

Proof: Follows immediately from the proposition 3.1.

Q.E.D.

We have a trivial vector bundle $\mathbf{U}(\mathfrak{n}^-)_{kl}$ over $\mathbf{C}P^1$ and we have a section $\mathbf{S}_{k,l}(t)$ of this bundle over \mathbf{C}^* . Consider this section as a meromorphic section of our vector bundle over $\mathbf{C}P^1$. Now we would like to calculate the orders of the poles at points zero and infinity.

Let us formulate the final result. The proof of the following theorem is technical and can be found in [Ast-Fu].

Theorem 3.3. *The coefficient at $L_{-i_r} L_{-i_{r-1}} \dots L_{-i_2} L_{-i_1}$ in $\mathbf{S}_{k,l}(t)$ has degree in t less or equal than $l(k-1)$. The degree in t is equal to $l(k-1)$ only at the monomial $(L_k)^l$ and the coefficient at $t^{l(k-1)}$ equals $((k-1)!)^l$.*

As a corollary of the last theorem one get the following important result.

Theorem 3.4. *The orders of the poles of the section $\mathbf{S}_{k,l}(t)$ of the trivial vector bundle $\mathbf{U}(\mathfrak{n}^-)_{kl}$ over $\mathbf{C}P^1$ are equal to $l(k-1)$ at ∞ and $k(l-1)$ at 0 .*

Proof: Obvious.

Q.E.D.

4 Jantzen's filtration.

The main goal of this section is to define Jantzen's filtration and to formulate all properties of it which we need.

Let \mathcal{C} be a smooth algebraic curve over \mathbf{C} with the sheaf of functions \mathcal{O} and two vector bundles M and \overline{M} . Denote the corresponding sheaves by \mathcal{M} and $\overline{\mathcal{M}}$. Suppose we have a map $\mathbf{B} : M \rightarrow \overline{M}$ of the vector bundles. Then for any point $p \in \mathcal{C}$ we get Jantzen's filtration on the fiber of M at point p . Let us define it. Let τ be a local parameter at point $p \in \mathcal{C}$. Consider the ring \mathcal{O}_p and the modules \mathcal{M}_p and $\overline{\mathcal{M}}_p$ over it. These modules are free and we have a map $\mathbf{B}_p : \mathcal{M}_p \rightarrow \overline{\mathcal{M}}_p$. The fibers of M and \overline{M} at point p are exactly $\mathcal{M}_p/\tau\mathcal{M}_p$ and $\overline{\mathcal{M}}_p/\tau\overline{\mathcal{M}}_p$. We denote them by V and W respectively. Now we will define a decreasing filtration $\dots V^{(2)} \subseteq V^{(1)} \subseteq V^{(0)} = V$.

Definition: $V^{(n)}$ is spanned by such vectors v that there exists an element $\tilde{v} \in \mathcal{M}_p$ with the following properties:

- i) Under the projection $\mathcal{M}_p \xrightarrow{\pi} \mathcal{M}_p/\tau\mathcal{M}_p = V$ $\pi(\tilde{v}) = v$.
- ii) $\mathbf{B}_p(\tilde{v}) \in \tau^n \overline{\mathcal{M}}_p$.

From the definition it is obvious that the filtration depends only on the map \mathbf{B} in some neighborhood of point p .

Suppose we have a symmetric bilinear form \mathbf{B} on the vector bundle M . Take $\overline{M} = M'$ - the dual vector bundle. Bilinear form provides a map $M \rightarrow M' = \overline{M}$. So we obtain Jantzen's filtration on every fiber of the vector bundle M . From now on we assume that we have a vector bundle M and a bilinear form \mathbf{B} on it. Choose a point $p \in \mathcal{C}$ and let us denote the induced map from $V \rightarrow V'$ by $\mathbf{B}_{(p)}$ where V is a fiber of M at point p .

Properties of Jantzen's filtration.

- 1) $V^{(1)} = \text{Ker}(\mathbf{B}_{(p)})$
- 2) Let us assume that we have two maps A and $A' : M \rightarrow M$ such that $\mathbf{B}(Av, w) = \mathbf{B}(v, A'w)$ for any two sections $v, w \in \Gamma(\mathcal{U}, \mathcal{M})$ where \mathcal{U} is any open subset of \mathcal{C} . We have induced maps $A_{(p)}$ and $A'_{(p)} : V \rightarrow V$ and it is easy to check that

$$A_{(p)}(V^{(n)}) \subseteq V^{(n)}.$$

Indeed, if $v \in V^{(n)}$ then there exists $\tilde{v} \in \mathcal{M}_p$ such that $\mathbf{B}_p(\tilde{v}) \in \tau^n \overline{\mathcal{M}}_p$. This means that for any $w \in \mathcal{M}_p$ $\mathbf{B}_p(\tilde{v}, w) \in \tau^n \mathcal{O}_p$. Therefore, in order to check

that $A_{(p)}v \in V^{(n)}$ it is sufficient to show that for any $w \in \mathcal{M}_p$ $\mathbf{B}_p(A_p \tilde{v}, w) \in \tau^n \mathcal{O}_p$. But $\mathbf{B}_p(A_p \tilde{v}, w) = \mathbf{B}_p(\tilde{v}, A'_p w) \in \tau^n \mathcal{O}_p$ because $A'_p w \in \mathcal{M}_p$ for any $w \in \mathcal{M}_p$.

3) Let us assume that the form \mathbf{B} is non-degenerate at the generic point. Then we can define a determinant of this form as a section of the following line bundle $(\Lambda^{\dim M} M)^{\otimes 2}$.

$$\det(\mathbf{B}) \in \Gamma(\mathcal{C}, ((\Lambda^{\dim M} M)^{\otimes 2})').$$

We have the following formula:

$$\text{ord}_\tau(\det(\mathbf{B})) = \sum_{i=1}^{\infty} \dim(V^{(i)}).$$

The statement is local, so to prove it, it is enough to consider a free module \mathcal{M}_p over \mathcal{O}_p and a bilinear form \mathbf{B}_p . In such case the formula is almost obvious. One can find a proof of it in the Jantzen's book (see [Ja]).

4) Assume that the form \mathbf{B} is symmetric and non-degenerate at generic point. Then it induces non-degenerate symmetric bilinear form on each quotient $V^{(i)}/V^{(i+1)}$ where $i \in \mathbf{N}$.

The statement is local. One can find the proof of it in Jantzen's book (see [Ja]).

5) Assume that we have a smooth algebraic surface, \mathcal{S} , over \mathbf{C} , a point, $p \in \mathcal{S}$, and two smooth curves \mathcal{C}_1 and \mathcal{C}_2 which intersect transversally at this point. Suppose we have a vector bundle M over \mathcal{S} and a bilinear form \mathbf{B} on M which is non-degenerate at the generic point of the surface \mathcal{S} . We will denote the fiber of the vector bundle M at point p by V . In addition, assume that we have two sections \tilde{v} and $\tilde{w} \in \Gamma(\mathcal{S}, M)$ such that

- a) $v = \tilde{v}(p) = \tilde{w}(p) \in V$
- b) $\mathbf{B}|_{\mathcal{C}_1}(\tilde{v}|_{\mathcal{C}_1}, \bullet) = 0$ and $\mathbf{B}|_{\mathcal{C}_2}(\tilde{w}|_{\mathcal{C}_2}, \bullet) = 0$.

Let \mathcal{C} be any smooth curve which contains point p . If we restrict the vector bundle M and the form \mathbf{B} to \mathcal{C} we obtain Jantzen's filtration on the vector space V if we restrict our vector bundle M and the form \mathbf{B} to \mathcal{C} . The claim is

$$v \in V^{(2)}.$$

Proof: The statement is local, therefore we can consider a free module \mathcal{M}_p over the local ring $\mathcal{O}_{\mathcal{S}, p}$. Moreover, we can take completions with respect to the maximal ideal $\mathfrak{m} \subset \mathcal{O}_{\mathcal{S}, p}$. Then $\hat{\mathcal{O}}_{\mathcal{S}, p} \cong \mathbf{C}[[x, y]]$ and we can assume that the

curves \mathcal{C}_1 and \mathcal{C}_2 are given by the equations $x = 0$ and $y = 0$ correspondingly. The equation for the curve \mathcal{C} is $z = 0$ where $z = ax + by + \tilde{z}$ and $\tilde{z} \in \mathfrak{m}^2$. We have form $\widehat{\mathbf{B}}_p$ on the module \widehat{M}_p .

Now we forget about the curve and reformulate everything in purely algebraic terms. We have a ring $\mathbf{C}[[x, y]]$, a free module $\widehat{V} = V \otimes \mathbf{C}[[x, y]]$, and a map $\widehat{\mathbf{B}} : \widehat{V} \rightarrow \widehat{V}'$ over $\mathbf{C}[[x, y]]$. Moreover, we have two vectors, $\tilde{v}, \tilde{w} \in \widehat{V}$, such that modulo the maximal ideal $\mathfrak{m} \subset \mathbf{C}[[x, y]]$ they are equal to $v \in V = \widehat{V}/\mathfrak{m}\widehat{V}$ and $\mathbf{B}(\tilde{v}) \in (x)\widehat{V}'$, $\mathbf{B}(\tilde{w}) \in (y)\widehat{V}'$. We can write down the map \mathbf{B} as a Taylor series:

$$\mathbf{B} = \mathbf{B}_0 + x\mathbf{B}_{1,0} + y\mathbf{B}_{0,1} + O(\mathfrak{m}^2).$$

Also we can write

$$\tilde{v} = v + yv_{0,1} + xv_{1,0} + O(\mathfrak{m}^2) \quad \text{and}$$

$$\tilde{w} = v + yw_{0,1} + xw_{1,0} + O(\mathfrak{m}^2).$$

Then we have the following equalities:

$$\mathbf{B}_0(v) = 0, \quad \mathbf{B}_{0,1}(v) = \mathbf{B}_0(v_{0,1}), \quad \mathbf{B}_{1,0}(v) = \mathbf{B}_0(w_{1,0}).$$

We must show that we can find $u \in \widehat{V}$ such that $u = v \pmod{\mathfrak{m}}$ and $\mathbf{B}(u) = 0 \pmod{(z = ax + by + \tilde{z}, \mathfrak{m}^2)} = (ax + by, \mathfrak{m}^2)$. But this is obvious since we can solve the following equation:

$$x\mathbf{B}_{1,0}(v) + y\mathbf{B}_{0,1}(v) = -\mathbf{B}_0(xu_{1,0} + yu_{0,1}) \pmod{(ax + by, \mathfrak{m}^2)}.$$

Q.E.D.

5 Structure of submodules of Verma modules and Jantzen's filtration.

In this section we will state the main theorems.

Let us fix h and c . Then equation $\Phi_{k,l}(h, c) = 0$ defines in plane $\mathbf{C}^2(k, l)$ a quadruple of straight lines namely $pk + ql + m = 0$, where

$$c = \frac{(3p + 2q)(3q + 2p)}{pq}, \quad h = \frac{-m^2 - (p + q)^2}{4pq}.$$

Certainly p , q and m are not defined uniquely but nevertheless, the lines $pk + ql + m = 0$ in plane $\mathbf{C}^2(k, l)$ are correctly defined. It is obvious that the directions of these lines depend only on c . When $c \neq 1, 25$, these lines form a rhombus with the diagonals $k = \pm l$. If $c = 1$ (or $c = 25$) then this rhombus degenerates into a pair of lines parallel to the line $k = l$ (or $k = -l$) and symmetric with respect to this line. Moreover, if $c = 1$ and $h = 0$ (or $c = 25$ and $h = -1$) then these two lines become a single line $k = l$ (or $k = -l$). These lines are real if and only if $c \leq 1$ or $c \geq 25$. If $c \leq 1$ then all these lines have positive slope and when $c \geq 25$ all these lines have negative slope. These lines are never parallel to coordinate axis. Let us denote one of this lines by $l_{h,c}$.

5.1 Structure of submodules of Verma modules.

We shall distinguish the following cases.

Case I. The line $l_{h,c}$ contains no integral points.

Case II. The line $l_{h,c}$ contains exactly one integral point (k, l) . We have following subcases:

II₊. The product $kl > 0$.

II₀. The product $kl = 0$.

II₋. The product $kl < 0$.

Case III. The line $l_{h,c}$ contains infinitely many integral points. We will distinguish six subcases which can be divided in two groups.

Subcase $c \leq 1$. Let $(k_1, l_1), (k_2, l_2), (k_3, l_3), \dots$ be all integral points (k, l) on the line $l_{h,c}$ up to equivalence $(k, l) \sim (k', l')$ iff $kl = k'l'$ and such that $kl > 0$. We ordered them in such a way that $k_i l_i < k_{i+1} l_{i+1}$ for all $i \in \mathbf{N}$.

III₀₀. Line $l_{h,c}$ intersects both axes at integral points (see Figure 1).

III₀. Line $l_{h,c}$ intersects only one axis at integral point (see Figure 2).

III₋. Line $l_{h,c}$ intersects both axes at non-integral points. In this case we draw an auxiliary line $l'_{h,c}$ parallel to $l_{h,c}$ through the point $(k_1, -l_1)$. We denote its points $(k_2, l_2 - 2l_1), (k_3, l_3 - 2l_1), (k_4, l_4 -$

$2l_1), \dots$ by $(k'_1, l'_1), (k'_2, l'_2), (k'_3, l'_3), \dots$ (see Figure 3). It is easy to see that we have the following inequalities:

$$\begin{aligned} k_1l_1 &< k_2l_2 < k_1l_1 + k'_1l'_1 < k_1l_1 + k'_2l'_2 < k_3l_3 < k_4l_4 < \\ &< k_1l_1 + k'_3l'_3 < k_1l_1 + k'_4l'_4 < k_5l_5 < k_6l_6 < \dots \end{aligned}$$

Subcase $c \geq 25$. Let $\{(k_1, l_1), (k_2, l_2), \dots, (k_s, l_s)\}$ be all integral points (k, l) on the line $l_{h,c}$ up to equivalence $(k, l) \sim (k', l')$ iff $kl = k'l'$ and such that $kl > 0$. We ordered them in such a way that $k_i l_i < k_{i+1} l_{i+1}$ for all $i \in \{1, 2, \dots, s-1\}$.

III₊⁰⁰. Line $l_{h,c}$ intersects both axes at integral points (see Figure 4).

III₊⁰. Line $l_{h,c}$ intersects only one axis at integral point (see Figure 5).

III₊. Line $l_{h,c}$ intersects both axes at non-integral points. In this case we draw an auxiliary line $l'_{h,c}$ parallel to $l_{h,c}$ through the point $(k_1, -l_1)$. We denote its points $(k_2, l_2 - 2l_1), (k_3, l_3 - 2l_1), (k_4, l_4 - 2l_1), \dots$ by $(k'_1, l'_1), (k'_2, l'_2), (k'_3, l'_3), \dots$ (see Figure 6). It is easy to see that we have the following inequalities:

$$\begin{aligned} k_1l_1 &< k_2l_2 < k_1l_1 + k'_1l'_1 < k_1l_1 + k'_2l'_2 < k_3l_3 < k_4l_4 < \\ &< k_1l_1 + k'_3l'_3 < k_1l_1 + k'_4l'_4 < k_5l_5 < k_6l_6 < \dots \end{aligned}$$

Theorem A. ([Fe-Fu 1])

a) All submodules of Verma module are generated by singular vectors.

b) i) In cases **I**, **II₋** and **II₀** Verma module is irreducible.

ii) In case **II₊** Verma module $M_{h,c}$ has a unique submodule generated by the singular vector at level kl . This submodule is isomorphic to Verma module $M_{h-kl,c}$ which is irreducible (case **II₋**).

iii) In cases **III₋⁰⁰**, **III₋⁰** and **III₋** we have an infinite number of singular vectors. All singular vectors and relations between them are shown in the diagrams below. Singular vectors are denoted by points with their weights indicated. An arrow or a chain of arrows from one point to another means that the second singular vector vector lies in the submodule generated by the first one.

iv) In cases **III₊⁰⁰**, **III₊⁰** and **III₊** we have a finite number of singular vectors (maybe zero). All singular vectors and relations between them are

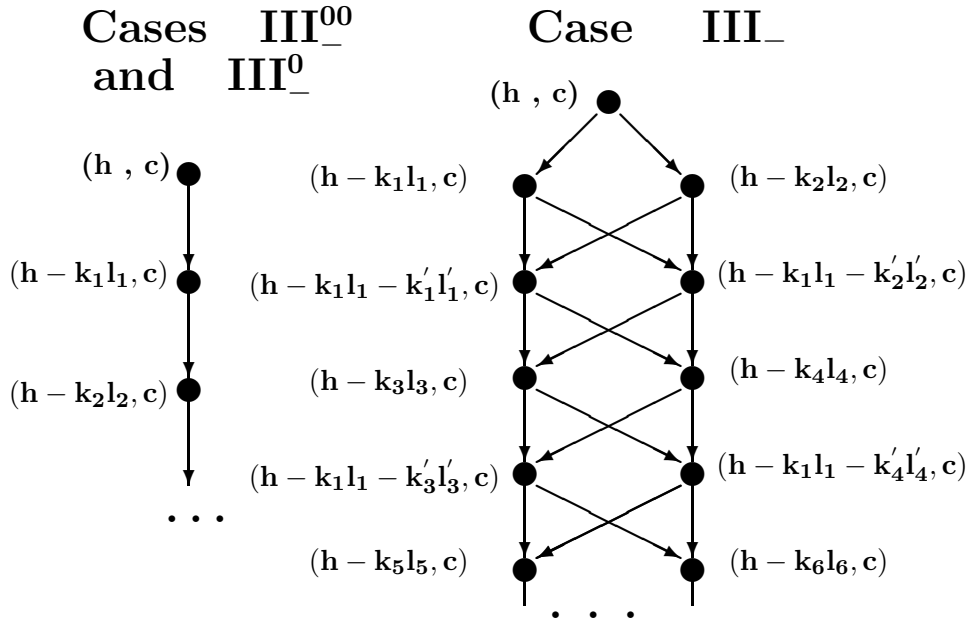

shown in the diagrams below. Singular vectors are denoted by points with their weights indicated. An arrow or a chain of arrows from one point to another means that the second singular vector lies in the submodule generated by the first one.

c) In case III_-^{00} (respectively III_-^0 , III_- , III_+^{00} , III_+^0 and III_+) any Verma submodule generated by a singular vector belongs to case III_-^{00} (respectively III_-^0 , III_- , III_+^{00} , III_+^0 and III_+).

5.2 Jantzen's filtration.

First of all, let us make some remarks about the curves $\mathcal{F}(k, l)$. Curves $\mathcal{F}(k, l)$ intersect each other only at real points. Curves $\mathcal{F}(k, k)$ are lines $h = \frac{k^2-1}{24}(1-c)$. All other curves $\mathcal{F}(k, l)$ for $k \neq l$ have two branches in real plane \mathbf{R}^2 . One of the branches of the curve $\mathcal{F}(k, l)$ lies in the region $c \leq h \leq \frac{(c-1)}{24}$ the other one lies in the region $c \geq 25$ $h \leq 0$. All curves $\mathcal{F}(k, l)$ for $k \neq l$ touch boundary lines $c = 1$, $h = \frac{(c-1)}{24}$ and $c = 25$.

We have a two parameter family of Verma modules $M_{h,c}$. Moreover, we

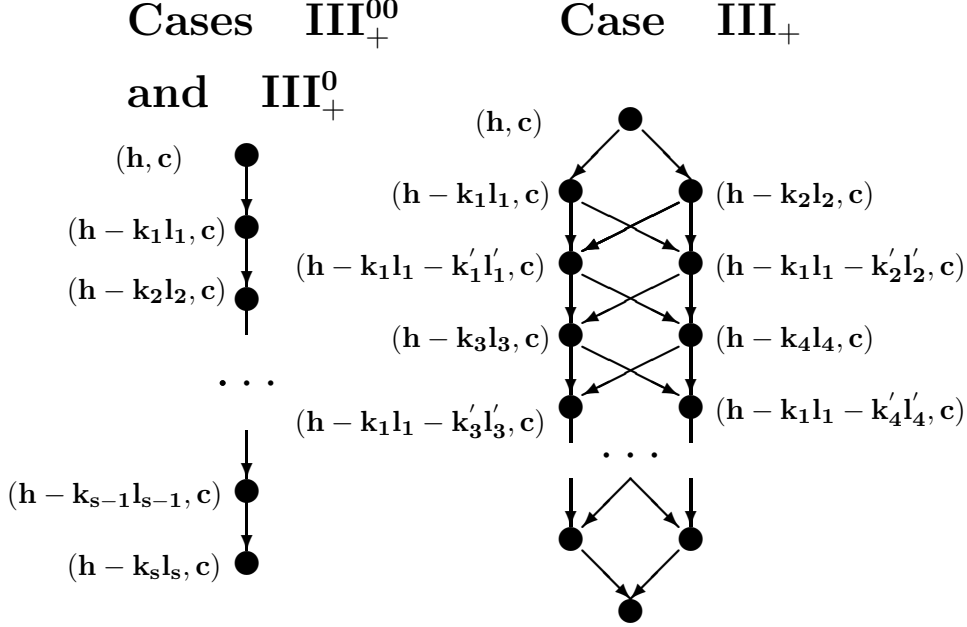

have a symmetric bilinear form $\mathbf{B}(h, c)$ on our Verma module $M_{h,c}$. We can restrict the form $\mathbf{B}(h, c)$ to $M_{h,c}^i$ where $i \in \mathbf{Z}_+$. We denote this restriction by $\mathbf{B}_i(h, c)$. One can look at this situation in the following way. We have a complex algebraic surface \mathbf{C}^2 and a trivial vector bundle \mathbf{M}_i with fibers which are canonically isomorphic to $M_{h,c}^i$ at point $(h, c) \in \mathbf{C}^2$. We have a symmetric bilinear form on the vector bundle \mathbf{M}_i which is non-degenerate at the generic point of \mathbf{C}^2 . The Kac determinant formula gives us expression for the determinant of this form in some basis.

Let us fix a point $(h, c) \in \mathbf{C}^2$. Let \mathcal{C} be any smooth curve which passes through this point (h, c) . Consider Jantzen's filtration on the fiber of the vector bundle \mathbf{M}_i at point (h, c) i.e., $M_{h,c}^i$ along this curve \mathcal{C} . From the properties of Jantzen's filtration (see section 4.) follow that the filtration is *Vir* invariant. Let us describe it. We assume here that the curve \mathcal{C} is not tangent to any curve $\mathcal{F}(k, l)$ at point (h, c) . We will keep the same notation as in Theorem A.

Theorem B.

- a) In cases \mathbf{I} , \mathbf{II}_0 and \mathbf{II}_- all $M_{h,c}^{(i)} = 0$ for $i \in \mathbf{N}$.
- b) In case \mathbf{II}_+ we have one point (k, l) on the line $l_{h,c}$ such that $kl > 0$. $M_{h,c}^{(1)}$ is generated by the singular vector at level kl and is isomorphic to

Verma module $M_{h-kl,c}$. $M_{h,c}^{(i)} = 0$ for $i > 1$, $i \in \mathbf{N}$.

c) In case \mathbf{III}_-^0 we have an infinite number of points (k_i, l_i) on the line $l_{h,c}$. Submodule $M_{h,c}^{(i)}$ is generated by the singular vector at level $k_i l_i$ and is isomorphic to Verma module $M_{h-k_i l_i, c}$.

d) In case \mathbf{III}_+^0 we have a finite number of points $(k_1, l_1), \dots, (k_s, l_s)$ on the line $l_{h,c}$. Submodule $M_{h,c}^{(i)}$ is generated by the singular vector at level $k_i l_i$ and is isomorphic to Verma module $M_{h-k_i l_i, c}$ for $i \leq s$. $M_{h,c}^{(i)} = 0$ for $i > s$.

e) In case \mathbf{III}_- we have an infinite number of points (k_i, l_i) on the line $l_{h,c}$ and points (k'_j, l'_j) on the additional line. Submodule $M_{h,c}^{(2i-1)}$ is generated by two singular vectors at levels $k_{2i-1} l_{2i-1}$ and $k_{2i} l_{2i}$ for $i \in \mathbf{N}$. Submodule $M_{h,c}^{(2i)}$ is generated by two singular vectors at levels $k_1 l_1 + k'_{2i-1} l'_{2i-1}$ and $k_1 l_1 + k'_{2i} l'_{2i}$ for $i \in \mathbf{N}$.

f) In case \mathbf{III}_+ we have a finite number of points $(k_1, l_1), \dots, (k_s, l_s)$ on the line $l_{h,c}$ and points $(k'_1, l'_1), \dots, (k'_{s-1}, l'_{s-1})$ on the additional line. Submodule $M_{h,c}^{(2i-1)}$ is generated by two singular vectors at levels $k_{2i-1} l_{2i-1}$ and $k_{2i} l_{2i}$ for $2i \leq s$. Submodule $M_{h,c}^{(2i)}$ is generated by two singular vectors at levels $k_1 l_1 + k'_{2i-1} l'_{2i-1}$ and $k_1 l_1 + k'_{2i} l'_{2i}$ for $2i < s$.

We have two case (which depend on s being even or odd):

s is even) Submodule $M_{h,c}^{(s)}$ is generated by the singular vector at level $k_1 l_1 + k'_{s-1} l'_{s-1}$ and is isomorphic to Verma module $M_{h-k_1 l_1 + k'_{s-1} l'_{s-1}, c}$. For all $i > s$ submodule $M_{h,c}^{(i)} = 0$.

s is odd) Submodule $M_{h,c}^{(s)}$ is generated by the singular vector at level $k_s l_s$ and is isomorphic to Verma module $M_{h-k_s l_s, c}$. For all $i > s$ submodule $M_{h,c}^{(i)} = 0$.

g) In case \mathbf{III}_-^{00} we have an infinite number of points (k_i, l_i) on the line $l_{h,c}$. We distinguish two cases:

$c = 1$ or $c = 24h + 1$) Submodule $M_{h,c}^{(i)}$ is generated by the singular vector at level $k_i l_i$ and is isomorphic to Verma module $M_{h-k_i l_i, c}$.

$c \neq 1$ and $c \neq 24h + 1$) Submodule $M_{h,c}^{(2i-1)} = M_{h,c}^{(2i)}$ is generated by the singular vector at level $k_i l_i$ and is isomorphic to Verma module $M_{h-k_i l_i, c}$.

h) In case \mathbf{III}_+^{00} we have a finite number of points $(k_1, l_1), \dots, (k_s, l_s)$ on the line $l_{h,c}$. We distinguish two cases:

$c = 25$) Submodule $M_{h,c}^{(i)}$ is generated by the singular vector at level

$k_i l_i$ and is isomorphic to Verma module $M_{h-k_i l_i, c}$ for $1 \leq i \leq s$. For all $i > s$ we have $M_{h,c}^{(i)} = 0$.

$c \neq 25$) Submodule $M_{h,c}^{(2i-1)} = M_{h,c}^{(2i)}$ is generated by the singular vector at level $k_i l_i$ and is isomorphic to Verma module $M_{h-k_i l_i, c}$ for $1 \leq i \leq s$. For all $i > 2s$ we have $M_{h,c}^{(i)} = 0$.

Now we will describe Jantzen's filtration in the case when $\mathcal{C} = \mathcal{F}(\bar{k}, \bar{l})$. We have a fixed point $(h, c) \in \mathbf{C}^2$ and we assume that $(h, c) \in \mathcal{C} = \mathcal{F}(\bar{k}, \bar{l})$. We will keep the same notation as in Theorem A.

Theorem C.

a) Cases **I**, **II₀** and **II₋** cannot occur.

b) In case **II₊** we have a point (k, l) on the line $l_{h,c}$ such that $kl > 0$ and $(\bar{k}, \bar{l}) = (k, l)$. Then $M_{h,c}^{(i)} = M_{h,c}^{(1)}$ is generated by the singular vector at level kl and is isomorphic to Verma module $M_{h-kl, c}$ for all $i \in \mathbf{N}$.

c) In case **III₀** we have an infinite number of points (k_i, l_i) on the line $l_{h,c}$ and for some $j \in \mathbf{N}$ $(k_j, l_j) = (\bar{k}, \bar{l})$. Submodule $M_{h,c}^{(i)}$ is generated by the singular vector at level $k_i l_i$ and is isomorphic to Verma module $M_{h-k_i l_i, c}$ for $i \leq j$. For $i > j$ $M_{h,c}^{(i)} = M_{h,c}^{(j)}$.

d) In case **III₊** we have a finite number of points $(k_1, l_1), \dots, (k_s, l_s)$ on the line $l_{h,c}$. For some $j \in \{1, \dots, s\}$ $(k_j, l_j) = (\bar{k}, \bar{l})$. Submodule $M_{h,c}^{(i)}$ is generated by the singular vector at level $k_i l_i$ and is isomorphic to Verma module $M_{h-k_i l_i, c}$ for $i \leq j$. $M_{h,c}^{(i)} = M_{h,c}^{(j)}$ for $i > j$.

e) Case **III₋**. There is an infinite number of points (k_j, l_j) on the line $l_{h,c}$. For some $j \in \mathbf{N}$ $(k_j, l_j) = (\bar{k}, \bar{l})$. Submodule $M_{h,c}^{(2i-1)}$ is generated by two singular vectors at levels $k_{2i-1} l_{2i-1}$ and $k_{2i} l_{2i}$ for $2i - 1 \leq j$. Submodule $M_{h,c}^{(2i)}$ is generated by two singular vectors at levels $k_1 l_1 + k'_{2i-1} l'_{2i-1}$ and $k_1 l_1 + k'_{2i} l'_{2i}$ for $2i < j$. Let's denote by $\tilde{j} = \begin{cases} j+1 & \text{if } j \text{ is odd} \\ j & \text{if } j \text{ is even} \end{cases}$. Then for any $i \geq \tilde{j}$ $M_{h,c}^{(i)}$ is generated by the singular vector at level $k_j l_j$ and is isomorphic to Verma module $M_{h-k_j l_j, c}$.

f) In case **III₊** we have a finite number of points $(k_1, l_1), \dots, (k_s, l_s)$ on the line $l_{h,c}$ and points $(k'_1, l'_1), \dots, (k'_{s-1}, l'_{s-1})$ on the additional line. For some $1 \leq j \leq s$ $(k_j, l_j) = (\bar{k}, \bar{l})$. Submodule $M_{h,c}^{(2i-1)}$ is generated by two singular vectors at levels $k_{2i-1} l_{2i-1}$ and $k_{2i} l_{2i}$ for $2i - 1 \leq j$. Submodule $M_{h,c}^{(2i)}$ is generated by two singular vectors at levels $k_1 l_1 + k'_{2i-1} l'_{2i-1}$ and $k_1 l_1 + k'_{2i} l'_{2i}$ for $2i < j$.

Let's denote by $\tilde{j} = \begin{cases} j+1 & \text{if } j \text{ is odd} \\ j & \text{if } j \text{ is even} \end{cases}$. Then for any $i \geq \tilde{j}$ $M_{h,c}^{(i)}$ is generated by the singular vector at level $k_j l_j$ and is isomorphic to Verma module $M_{h-k_j l_j, c}$.

g) In case **III₋⁰⁰** we have an infinite number of points (k_i, l_i) on the line $l_{h,c}$. There exists $j \in \mathbf{N}$ such that $k_j l_j = \overline{kl}$. Submodule $M_{h,c}^{(2i-1)} = M_{h,c}^{(2i)}$ is generated by the singular vector at level $k_i l_i$ and is isomorphic to Verma module $M_{h-k_i l_i, c}$ for $1 \leq i \leq j$. For any $i > 2j$ $M_{h,c}^{(i)} = M_{h,c}^{(2j)}$.

h) In case **III₊⁰⁰** we have a finite number of points $(k_1, l_1), \dots, (k_s, l_s)$ on the line $l_{h,c}$. There exists j , $1 \leq j \leq s$, such that $k_j l_j = \overline{kl}$. Submodule $M_{h,c}^{(2i-1)} = M_{h,c}^{(2i)}$ is generated by the singular vector at level $k_i l_i$ and is isomorphic to Verma module $M_{h-k_i l_i, c}$ for $1 \leq i \leq j$. For any $i > 2j$ $M_{h,c}^{(i)} = M_{h,c}^{(2j)}$.

5.3 Remarks.

1) We will prove these theorems in two steps. Step 1.) We prove sections **b)** (i), (ii) and (iii) of the theorem A and the section **a)** of theorem A in these cases. Alongside we prove sections a) through f) of theorem B. Then as a corollary we get that parts a) through f) of theorem C are true. Step 2.) We prove sections **b)** (iv) of theorem A and the section **a)** of theorem A in the above case. Alongside we prove sections g) and h) of theorem C. As a corollary we obtain that sections g) and h) of theorem B are true.

2) We prove everything by induction by level. Let us explain what it means. We say that some property is true up to level k if this property holds in

$$\bigoplus_{i=0}^k M_{h,c}^i.$$

For example, we say that some submodule V is generated by a vector v up to level k iff

$$\bigoplus_{i=0}^k M_{h,c}^i \cap V = \bigoplus_{i=0}^k M_{h,c}^i \cap W, \quad \text{where } W \text{ is a submodule generated by } v.$$

Another example. We say that part a) of theorem A holds up to level k meaning that any submodule of Verma module is generated by singular vectors up to level k .

3) It is easy to show (using the Kac determinant formula) that theorem B follows from theorem A and vice versa.

6 Proof of the structure theorem in simple cases.

In this section we will prove the structure theorem in the following cases: **I**, **II**, **III**₊⁰, **III**₋⁰, **III**₊ and **III**₋. Let us emphasize that in all these cases all curves $\mathcal{F}(k, l)$ which pass through point (h, c) intersect transversally at this point. First, let us notice that from the Kac determinant formula and corollary 3.2 immediately follows the existence of all the singular vectors and the diagrams of inclusions between the corresponding Verma modules as stated in the Theorem A. Also, it is easy to see that any Verma submodule generated by a singular vector (which we constructed) is of the same case as the original Verma module. Our goal is to show that the maximal submodule is generated by the singular vectors (or singular vector) at levels $k_1 l_1$ and $k_2 l_2$ (or level $k_1 l_1$) in the notation of theorem A.

Second, let us notice that cases **I**, **II**₋ and **II**₀ are trivial. They immediately follow from the Kac determinant formula (since in these cases determinant does not vanish).

Definition 6.1.

For any module $\mathbf{M} \in \mathcal{O}_c$ let us define its character

$$ch(\mathbf{M}) \stackrel{def}{=} \sum_{h \in \mathbf{C}} \dim(\mathbf{M}_h) q^h,$$

$$where \quad \mathbf{M} = \bigoplus_{h \in \mathbf{C}} \mathbf{M}_h.$$

Using property 3 of Jantzen's filtration (section 4) we can write an explicit formula for $\sum_{i=1}^{\infty} ch(M_{h,c}^{(i)})$. In cases **III**₋⁰ and **III**₋ we obtain the following formula:

$$\sum_{i=1}^{\infty} ch(M_{h,c}^{(i)}) = \sum_{i=1}^{\infty} ch(M_{h-k_i l_i, c}).$$

In cases **III**₊⁰ and **III**₊ we have only a finite number of marked points

$(k_1, l_1), \dots, (k_s, l_s)$ on the line $l_{h,c}$. So we obtain the following formula:

$$\sum_{i=1}^{\infty} ch(M_{h,c}^{(i)}) = \sum_{i=1}^s ch(M_{h-k_i l_i, c}).$$

In case \mathbf{II}_+ we get

$$\sum_{i=1}^{\infty} ch(M_{h,c}^{(i)}) = ch(M_{h-kl, c})$$

where (k, l) is the marked point on the line $l_{h,c}$.

Let us make the following important remark. Jantzen's filtration is a filtration by *Vir* submodules (this follows immediately from the second property of Jantzen's filtration). Therefore, for example, if we know some vector $w \in M_{h,c}^{(i)}$ then we see that the submodule generated by the vector w is contained in $M_{h,c}^{(i)}$.

Let us show that in case \mathbf{II}_+ Verma module $M_{h,c}$ has a unique submodule $M_{h-kl, c}$. Certainly, we know that such submodule exists (since we have a singular vector at level kl). From the Kac determinant formula follows that module $M_{h-kl, c}$ is irreducible. Since the kernel of the form is exactly the maximal submodule, it contains our submodule $M_{h-kl, c}$. From the property 1 of Jantzen's filtration follows that $M_{h-kl, c} \subset M_{h,c}^{(1)}$. Comparing formula

$$\sum_{i=1}^{\infty} ch(M_{h,c}^{(i)}) = ch(M_{h-kl, c})$$

with the fact that $ch(M_{h,c}^{(1)}) \geq ch(M_{h-kl, c})$ we obtain that $M_{h,c}^{(1)} = M_{h-kl, c}$ and $M_{h,c}^{(i)} = 0$ for all $i > 1$.

Now let us prove theorems A and B for case \mathbf{III}_- . The proof for other cases is the same with minor modifications. We will use the same notation as in theorems A and B. It is useful to look at figures 7 and 8 for a better understanding of the proof.

First of all, let us make the following remarks. Submodule generated by singular vectors at levels $k_1 l_1$ and $k_2 l_2$ is contained in $M_{h,c}^{(1)}$. The more important fact is that the module generated by the singular vectors at levels $k_1 l_1 + k'_1 l'_1$ and $k_1 l_1 + k'_2 l'_2$ is contained in $M_{h,c}^{(2)}$. This fact follows from property 5 of Jantzen's filtration, since each of these two singular vectors comes along the curves $\mathcal{F}(k_1, l_1)$ and $\mathcal{F}(k_2, l_2)$. This immediately implies (comparing these

Figure 7.

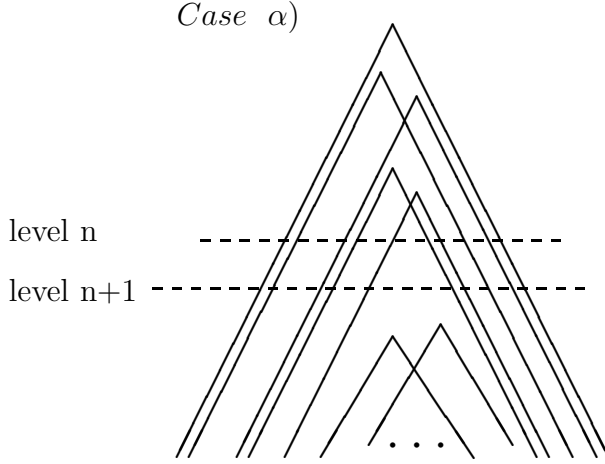

remarks with the formula for $\sum_{i=1}^{\infty} ch(M_{h,c}^{(i)})$ that the structure of submodules of Verma module $M_{h,c}$ is exactly as stated in theorems A and B up to level $\min(k_3l_3, k_4l_4) - 1$.

We will prove theorem A together with theorem B for this case (for all modules) by induction by level. Certainly, we have the base of induction. Assume that we proved those theorems up to level n . Let us prove them up to level $n + 1$ for module $M_{h,c}$.

Let us introduce two additional filtrations $\mathbf{F}^{(i)}$ and $\mathbf{G}^{(i)}$. $\mathbf{F}^{(2i-1)}$ is generated by the singular vectors at levels $k_{2i-1}l_{2i-1}$ and $k_{2i}l_{2i}$ and $\mathbf{F}^{(2i)}$ is generated by the singular vectors at levels $k_1l_1 + k'_{2i-1}l'_{2i-1}$ and $k_1l_1 + k'_{2i}l'_{2i}$. What we want to prove is that the filtration $\mathbf{F}^{(i)}$ coincides with the filtration $M_{h,c}^{(i)}$.

$\mathbf{G}^{(i)}$ is generated by the vectors $\mathbf{F}^{(i)} \cap \bigoplus_{j=1}^n M_{h,c}^j$. It is important to understand how the filtration $\mathbf{G}^{(i)}$ looks. In some sense it is a cutting of the filtration $\mathbf{F}^{(i)}$. We know that, up to level n , $\mathbf{G}^{(i)}$ coincides with $M_{h,c}^{(i)}$. Let us also notice the following properties:

$$\mathbf{G}^{(i)} \subset M_{h,c}^{(i)} \quad \text{and} \quad \mathbf{G}^{(i)} \subset \mathbf{F}^{(i)} \quad \text{for any } i \in \mathbf{N}.$$

We distinguish two cases.

Case α): $n + 1 \neq k_i l_i, k_1 l_1 + k'_i l'_i$ for all $i \in \mathbf{N}$. Then we see that the formulas for $\sum_{i=1}^{\infty} ch(M_{h,c}^{(i)})$ and $\sum_{i=1}^{\infty} ch(\mathbf{G}^{(i)})$ coincide up to level $n + 1$. Together with the fact that $\mathbf{F}^{(i)} = \mathbf{G}^{(i)}$ up to level $n + 1$ in this case (direct check) we

Figure 8.

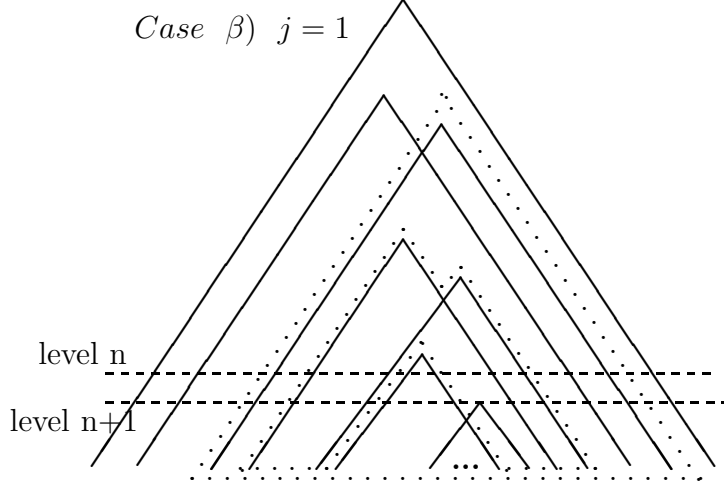

obtain that the filtration $\mathbf{F}^{(i)}$ coincides with the filtration $M_{h,c}^{(i)}$ up to level $n + 1$. This proves the statements of theorems A and B up to level $n + 1$ for $M_{h,c}$.

Case β): $n + 1 = k_i l_i$ or $k_1 l_1 + k'_i l'_i$ for some $i \in \mathbf{N}$. Then direct calculations (very easy) show that

$$\text{Res}_q(q^{-h+n}(\sum_{j=1}^{\infty} ch(M_{h,c}^{(j)}) - \sum_{j=1}^{\infty} ch(\mathbf{G}^{(j)}))dq) = 1.$$

Therefore, there exists $j \in \mathbf{N}$ such that $\dim((M_{h,c}^{(j)})^{n+1}/(\mathbf{G}^{(j)})^{n+1}) = 1$. We will use the following notation

$$\tilde{i} = \begin{cases} i - 1 & \text{if } n + 1 = k_i l_i \text{ and } i \text{ is odd} \\ i - 2 & \text{if } n + 1 = k_i l_i \text{ and } i \text{ is even} \\ i & \text{if } n + 1 = k_1 l_1 + k'_i l'_i \text{ and } i \text{ is odd} \\ i - 1 & \text{if } n + 1 = k_1 l_1 + k'_i l'_i \text{ and } i \text{ is even} \end{cases}.$$

We distinguish three cases: first $j = 1$, second $1 < j \leq \tilde{i}$ and third $j = \tilde{i} + 1$.

The third case is exactly the statement of theorem B. From the induction hypothesis one can see that $M_{h,c}^{(j)}$ is exactly as stated in the theorem (since everything is contained in $M_{h,c}^{(1)}$ and this “reduces” level). We know that

$$\text{Res}_q(q^{-h+n}(\sum_{j=1}^{\infty} ch(M_{h,c}^{(j)}) - \sum_{j=1}^{\infty} ch(\mathbf{G}^{(j)}))dq) = 1$$

$$\text{and } Res_q(q^{-h+s}(\sum_{j=1}^{\infty} ch(M_{h,c}^{(j)}) - \sum_{j=1}^{\infty} ch(\mathbf{G}^{(j)}))dq) = 0 \text{ for } s < n.$$

Therefore, the same argument as in the third case proves that the second case can not occur. (since everything is contained in $M_{h,c}^{(1)}$ and this “reduces” level).

Thus, we must show that only the first case can not occur. If $\tilde{i} = 1$ then everything follows from the remarks at the beginning of the proof. Thus, we can assume that $\tilde{i} > 1$. Since we assumed that $\dim((M_{h,c}^{(1)})^{n+1}/(\mathbf{G}^{(1)})^{n+1}) = 1$ we have $\mathbf{G}^{(s)} = M_{h,c}^{(s)}$ up to level $n+1$ for all $s > 1$. Therefore $V \stackrel{def}{=} M_{h,c}^{(\tilde{i})}/M_{h,c}^{(\tilde{i}+1)} = \mathbf{G}^{(\tilde{i})}/\mathbf{G}^{(\tilde{i}+1)}$ up to level $n+1$. From property 4 of Jantzen’s filtration we obtain a symmetric non-degenerate bilinear form on module V . We know that (in terms of module $M_{h,c}$) module V is generated by two singular vectors up to level $n+1$. So up to level $n+1$ this form is determined by its values on these two singular vectors. Let V_1 and V_2 be two submodules of V generated by the first and the second singular vectors respectively. By the induction hypothesis we know that these submodules intersect at level $n+1$ and the intersection (at this level) is one dimensional and is generated by the singular vector. Since V_1 and V_2 are quotients of Verma modules we see that the form on them must coincide with the standard form (up to a constant multiple). It is zero on their intersection (since form is zero on the maximal submodule). So we see (since $V = V_1 + V_2$ up to level $n+1$) that the singular vector at level $n+1$ lies in the kernel of the form. This contradicts the fact that the form is non-degenerate. We proved that case $j = 1$ is impossible.

Thus we proved the statements of theorems A and B for case **III**₋. Using similar arguments one can prove theorems A and B for cases **III**₊⁰, **III**₋⁰ and **III**₊.

In figures 7 and 8 we draw Verma modules as cones. One cone is contained in the other if the same is true for the corresponding Verma modules. By dotted lines we marked Verma module generated by the singular vector at level $k_2 l_2$ and the quotient $V \stackrel{def}{=} M_{h,c}^{(\tilde{i})}/M_{h,c}^{(\tilde{i}+1)} = \mathbf{G}^{(\tilde{i})}/\mathbf{G}^{(\tilde{i}+1)}$ assuming that $j = 1$. One can see the structure of this module in the figure, so it becomes clear that such situation is impossible.

7 Completion of the proof.

7.1 General remarks and the idea of the proof.

In this section we will prove theorems A, B and C for the remaining cases. Our proof is a minor modification of the proof of Feigin and Fuchs (see [Fe-Fu 1]). First of all, let us make the following remark. If theorem A is true up to level n then theorems B and C are also true up to level n . This is obvious, since we have an explicit formula for $\sum_{j=1}^{\infty} ch(M_{h,c}^{(j)})$ and we know the structure of submodules of Verma module up to level n . This shows that there is a unique possibility for Jantzen's filtration. Therefore, theorems B and C are true up to level n . The next remark is that in order to prove theorem A up to level $n+1$ (we assume that it is true up to level n) it is enough to show that in cases $\mathbf{III}_+^{\mathbf{00}}$ and $\mathbf{III}_-^{\mathbf{00}}$ the maximal submodule is generated by the singular vector at level $k_1 l_1$ up to level $n+1$. Indeed, all submodules are contained in the submodule generated by the singular vector at the level $k_1 l_1$ up to level $n+1$ *i.e.*, in Verma module $M_{h-k_1 l_1, c}$ up to level $n+1$ with respect to the original Verma module $M_{h,c}$ (in other words up to level $n+1-k_1 l_1$ with respect to $M_{h-k_1 l_1, c}$). Therefore, we can apply the induction hypothesis.

We will be proving theorems A, B and C by induction "up to level n ". Now we assume that they are true up to level n . From the previous remarks it is enough to show that in cases $\mathbf{III}_+^{\mathbf{00}}$ and $\mathbf{III}_-^{\mathbf{00}}$ the maximal submodule is generated by the singular vector at level $k_1 l_1$ up to level $n+1$. We distinguish two cases.

α) $n+1 \neq k_i l_i$ for all $i \in \mathbf{N}$ (or $1 \leq i \leq s$). Let us take some smooth curve through the point (h, c) which is not tangent to any curve $\mathcal{F}(k, l)$ at this point. An explicit formula for $\sum_{j=1}^{\infty} ch(M_{h,c}^{(j)})$ shows that theorem A is true up to level $n+1$ for the module $M_{h,c}$. Here it is. By I let us denote the set \mathbf{N} for case $\mathbf{III}_-^{\mathbf{00}}$ and the set $\{1, \dots, s\}$ for case $\mathbf{III}_+^{\mathbf{00}}$. Then we distinguish two cases:

a) $c \neq 1, 25, 24h+1$:

$$\sum_{j=1}^{\infty} ch(M_{h,c}^{(j)}) = 2 \left(\sum_{j \in I} ch(M_{h-k_i l_i, c}) \right).$$

b) $c = 1$ or 25 or $24h+1$:

$$\sum_{j=1}^{\infty} ch(M_{h,c}^{(j)}) = \sum_{j \in I} ch(M_{h-k_i l_i, c}).$$

These formulas follow immediately from the Kac determinant formula and property 3 of Jantzen's filtration.

$\beta)$ $n + 1 = k_j l_j$ for some $j \in \mathbf{N}$ (or $1 \leq j \leq s$). Then we take $\mathcal{C} = \mathcal{F}(k_j, l_j)$. This curve \mathcal{C} is given by the parametric equations $h = h(t)$, $c = c(t)$ (see the formulas in section 3). Corollary 3.2 shows that the module $M_{h(t), c(t)}$ has a singular vector at level $n + 1 = k_j l_j$ and this singular vector generates Verma submodule $M_{h(t)-n-1, c(t)}$. Let $L(t) \stackrel{def}{=} M_{h(t), c(t)} / M_{h(t)-n-1, c(t)}$. The contravariant form $\mathbf{B}: M_{h(t), c(t)} \rightarrow \overline{M}_{h(t), c(t)}$ vanishes on the submodule $M_{h(t)-n-1, c(t)}$ and since it is a symmetric bilinear form, it defines a form $\tilde{\mathbf{B}}: L(t) \rightarrow \overline{L}(t)$ with the same properties. So we can speak about Jantzen's filtration on $L(t)$ along this curve \mathcal{C} . Unfortunately, we do not know the determinant formula for module $L(t)$. Nevertheless, we can calculate the following sum:

$$\sum_{t \in \mathbf{C}} \sum_{i=1}^{\infty} q^{-h(t)} ch(L(t)^{(i)}).$$

This is going to be our first calculation.

The second calculation is described below. It is easy to see from the definition of Jantzen's filtration that if some submodule $N \subset M_{h(t_0), c(t_0)}^{(k)}$ then the image \overline{N} of N under projection $M_{h(t_0), c(t_0)} \rightarrow L(t_0)$ is contained in $L(t_0)^{(k)}$ i.e., $\overline{N} \subset L(t_0)^{(k)}$. Since theorems A, B and C are true up to level n we have some information about Jantzen's filtration. Exactly, we know that for $i < j$ Verma module generated by the singular vector at level $k_i l_i$ is contained in $M_{h(t_0), c(t_0)}^{(2i)}$ (i.e. $M_{h(t_0)-k_i l_i, c(t_0)} \subset M_{h(t_0), c(t_0)}^{(2i)}$). Therefore, its image $\overline{M}_{h(t_0)-k_i l_i, c(t_0)} \subset L(t_0)^{(2i)}$. This gives us a low boundary for $\sum_{i=1}^{\infty} q^{-h(t_0)} ch(L(t_0)^{(i)})$. Summing over all $t \in \mathbf{C}$ (using the fact that in all other cases except $\mathbf{III}_+^{\mathbf{00}}$ and $\mathbf{III}_-^{\mathbf{00}}$ we know Jantzen's filtration exactly) we obtain the estimate from below for $\sum_{t \in \mathbf{C}} \sum_{i=1}^{\infty} q^{-h(t)} ch(L(t)^{(i)})$. The remarkable fact is that these two calculations give us the same answer. Thus we know Jantzen's filtration on $L(t)$ along this curve \mathcal{C} for all $t \in \mathbf{C}$. We immediately see that the maximal submodule in $M_{h,c}$ is generated by the singular vector at level $k_1 l_1$ up to level $n + 1$. This finishes the proof.

7.2 First calculation.

This calculation is exactly the first calculation from the paper by Feigin and Fuchs ([**Fe-Fu 1**]). We present it here in greater details for the sake of

completeness.

Let us take the compactification of curve $\mathcal{F}(k_j, l_j)$ *i.e.* \mathbf{CP}^1 . Then we have a trivial vector bundle over it $M_{h(t), c(t)} = \mathbf{U}(\mathfrak{n}^-)$ which is a direct sum of trivial bundles $\mathbf{U}(\mathfrak{n}^-)_i$ for $i \in \mathbf{Z}_+$. We have subbundle $\mathbf{N}(t)$ which is generated by singular vector $\mathbf{S}_{k_j, l_j}(t)$ over Virasoro. Certainly, we have decompositions into the direct sums,

$$M_{h(t), c(t)} = \mathbf{U}(\mathfrak{n}^-) = \bigoplus_{i=0}^{\infty} \mathbf{U}(\mathfrak{n}^-)_i \quad \text{and}$$

$$\mathbf{N}(t) = \bigoplus_{i=k_j l_j}^{\infty} \mathbf{N}(t)_i.$$

Let us denote by η the line bundle $\mathbf{N}(t)_{n+1}$ (remember that $n+1 = k_j l_j$). It is easy to see that $\mathbf{N}(t)_i = p(i - k_j l_j) \eta$ for all $i \in \mathbf{Z}_+$, where $p(i)$ is a partition function (we set $p(i) = 0$ for $i < 0$).

$$L(t) = M_{h(t), c(t)} / \mathbf{N}(t), \quad \text{in particular}$$

$$L(t)_i = \mathbf{U}(\mathfrak{n}^-)_i / \mathbf{N}(t)_i.$$

$\det(\tilde{\mathbf{B}}_i)$ is a section of the following line bundle $(\Lambda^{\dim L(t)_i} L(t)_i)^{\otimes 2}$ ' (it is obvious that $\dim L(t)_i = p(i) - p(i - k_j l_j)$). This section is regular outside 0 and ∞ . Let us denote by $P_i(0)$ and $P_i(\infty)$ the orders of the poles of the section at zero and infinity respectively. We have the following formula

$$\sum_{t \in \mathbf{C}^{m=1}} \sum_{i=1}^{\infty} \dim(L(t)_i^{(m)}) = Eu((\Lambda^{\dim L(t)_i} L(t)_i)^{\otimes 2})' + P_i(0) + P_i(\infty),$$

where $Eu(\bullet)$ denotes the Euler number of the vector bundle. This formula follows from property 3 of Jantzen's filtration. Therefore, we must calculate the Euler number and the orders of the poles at zero and infinity of the corresponding vector bundle. Let us calculate the Euler number first.

Lemma 7.1. (see [Fe-Fu 1])

The Euler number, $Eu(\eta) = k_j + l_j - 2k_j l_j$.

Proof. From theorem 3.4. we see that line bundle η has section $\mathbf{S}_{k_j, l_j}(t)$ that has no zero and has two poles of orders $k_j(l_j - 1)$ and $l_j(k_j - 1)$.

Q.E.D.

To calculate $Eu((\Lambda^{\dim L(t)_i} L(t)_i)^{\otimes 2})'$ is the same as to calculate the first Chern class, \mathbf{c}_1 , of this vector bundle.

$$\begin{aligned} & \mathbf{c}_1((\Lambda^{\dim L(t)_i} L(t)_i)^{\otimes 2})' = \\ & = -2\mathbf{c}_1((\Lambda^{\dim L(t)_i} L(t)_i)) = -2\mathbf{c}_1(L(t)_i) = 2\mathbf{c}_1(\mathbf{N}(t)_i) = 2p(i - k_j l_j) \mathbf{c}_1(\eta). \end{aligned}$$

Lemma 7.2. (see [Fe-Fu 1])

The Euler number, $Eu((\Lambda^{\dim L(t)_i} L(t)_i)^{\otimes 2})' = 2p(i - k_j l_j)(k_j + l_j - 2k_j l_j)$

Proof. Obvious.

Q.E.D.

Now let us calculate the numbers $P_i(0)$ and $P_i(\infty)$. For example, near infinity we can calculate the determinant of the form \mathbf{B}_i as the determinant of the principal minor of the matrix of the contravariant form corresponding to the following part of the basis $L_{-i_r} L_{-i_{r-1}} \dots L_{-i_2} L_{-i_1} (L_{k_j})^s$ where $s < l_j$, $i_r \geq i_{r-1} \geq \dots \geq i_2 \geq i_1 \geq 1$ and $i_m \neq k_j$ for all m . For $t \rightarrow \infty$ we know that $h \sim \frac{1-k_j^2}{4}t$ and $c \sim 6t$. One can see that the degree in t of the determinant of this minor can be calculated as a sum of the degrees of its diagonal entries (other products have smaller degree). The computation of this sum is similar to the computations in section 3. We must take into account only that $L_i L_{-i} \mathbf{v}_{h(t), c(t)} = [-2ih(t) - (i^3 - i) 12c(t)] \mathbf{v}_{h(t), c(t)} \sim -i(i^2 - k_j^2) 2t \mathbf{v}_{h(t), c(t)}$ which has degree 1 in t if $i \neq k_j$ and that $(L_{k_j})^s (L_{-k_j})^s \mathbf{v}_{h(t), c(t)} \sim (-\frac{k}{12})^s \prod_{m=1}^s (k_j(13k_j - 12(l_j + 2s - 2m)) - 1) \neq 0$ has degree 0 in t . So $P_i(\infty)$ equals the number of all elements not equal to k_j of all partitions of i which contain k_j less than l_j times. A similar statement is true for $P_i(0)$. We must only replace k_j by l_j and vice versa. We obtain the following formulas:

$$\begin{aligned} \sum_{m=0}^{\infty} P_m(\infty) u^m &= p(u) (1 - u^{k_j l_j}) \left(s(u) - \frac{u^{k_j}}{1 - u^{k_j}} \right), \\ \sum_{m=0}^{\infty} P_m(0) u^m &= p(u) (1 - u^{k_j l_j}) \left(s(u) - \frac{u^{l_j}}{1 - u^{l_j}} \right), \end{aligned}$$

where $p(u) = \sum_{m=0}^{\infty} p(m) u^m$, $s(u) = \sum_{m=0}^{\infty} \sum_{s=0}^{\infty} u^{ms}$. Indeed, $p(u) \frac{u^m}{1 - u^m}$ is a generating function for the number of all elements equal to m of all partitions of positive integer. Thus we proved the following proposition.

Proposition 7.3. (see [Fe-Fu 1])

$$\sum_{t \in \mathbf{C}} \sum_{m=1}^{\infty} q^{h(t)} ch(L(t)^{(m)})(q^{-1}) = p(q)(1 - q^{k_j l_j}) \left(2s(q) - \frac{u^{k_j}}{1 - u^{k_j}} - \frac{u^{l_j}}{1 - u^{l_j}} \right) - (2k_j l_j - k_j - l_j) p(q) q^{k_j l_j}.$$

Remark. We have $n + 1 = k_j l_j$.

7.3 Second calculation.

This calculation is completely combinatorial and quite lengthy. It is a good exercise in combinatorics to do it by yourself. In any case, everyone who is interested in it can find it in [Fe-Fu] Chapter 2, paragraph 1, section 4. The result is the same as the right hand side in the proposition 7.3. .

7.4 Final remarks.

Comparison of these two calculations finishes the proof of theorems A, B and C.

One can see that in cases $\mathbf{III}_+^{\mathbf{00}}$ and $\mathbf{III}_-^{\mathbf{00}}$ the proof uses the asymptotics of the formulas for the singular vectors. It seems interesting to me to find another proof which does not use such kind of information.

8 On the structure of Verma modules over Neveu-Schwarz algebra.

8.1 Notation.

Neveu-Schwarz is a Lie superalgebra with the basis $L_i, L_{i+\frac{1}{2}}$ and C where $i \in \mathbf{Z}$ and the following commutators:

$$\begin{aligned} [L_i, C] &= 0, & [L_{i+\frac{1}{2}}, C] &= 0 \\ [L_i, L_j] &= (j - i)L_{i+j} + \delta_{-i,j} \frac{(j^3 - j)}{12} C, \end{aligned}$$

$$[L_{m+\frac{1}{2}}, L_{n+\frac{1}{2}}] = 2L_{n+m+1} + \delta_{0,m+n+1} \frac{(4n^2 - 1)}{12} C,$$

$$[L_{m+\frac{1}{2}}, L_n] = \left(\frac{n-1}{2} - m\right) L_{m+n+\frac{1}{2}}.$$

It is $\frac{1}{2}\mathbf{Z}$ -graded: $\deg L_i = i$, $\deg L_{i+\frac{1}{2}} = i+\frac{1}{2}$ and $\deg C = 0$. Let us denote by \mathfrak{h} the Lie algebra with the basis L_0 and C , by \mathfrak{n}^- the Lie algebra with the basis $\{L_{-\frac{i}{2}}, i \in \mathbf{N}\}$ and by \mathfrak{n}^+ the Lie algebra with the basis $\{L_{\frac{i}{2}}, i \in \mathbf{N}\}$. We also denote by \mathfrak{b}^+ the Lie algebra with the basis $\{L_{\frac{i}{2}} \text{ and } C, i \in \mathbf{Z}_+\}$. All these algebras \mathfrak{h} , \mathfrak{n}^- , \mathfrak{n}^+ and \mathfrak{b}^+ are subalgebras of \mathcal{NV} . We have a Cartan type decomposition of \mathcal{NV}

$$\mathcal{NV} = \mathfrak{n}^- \oplus \mathfrak{h} \oplus \mathfrak{n}^+$$

$$\mathcal{NV} = \mathfrak{n}^- \oplus \mathfrak{b}^+.$$

Let $h, c \in \mathbf{C}$. Let's consider one dimensional module $\mathbf{C}_{h,c}$ over \mathfrak{b}^+ such that \mathfrak{n}^+ acts by zero, L_0 is a multiplication by h and C is a multiplication by c . Verma module $M_{h,c}$ over Neveu-Schwarz is (by definition) the induced module from $\mathbf{C}_{h,c}$

$$M_{h,c} = \text{Ind}_{\mathfrak{b}^+}^{\mathcal{NV}} \mathbf{C}_{h,c}.$$

We have a natural inclusion of $\mathbf{C}_{h,c} \hookrightarrow M_{h,c}$. Therefore, we have a vector $\mathbf{v} \in M_{h,c}$ corresponding to $\mathbf{1} \in \mathbf{C}_{h,c}$. Sometimes we denote it by $\mathbf{v}_{h,c}$ to stress that this vector lies in $M_{h,c}$. Vector \mathbf{v} is called the vacuum vector.

Let us make some remarks about Verma modules. First, any Verma module $M_{h,c}$ is a free module over $\mathbf{U}(\mathfrak{n}^-)$. We have the following basis in $M_{h,c}$:

$$L_{-\frac{i_k}{2}} L_{-\frac{i_{k-1}}{2}} \dots L_{-\frac{i_2}{2}} L_{-\frac{i_1}{2}} \mathbf{v}_{h,c},$$

where $i_k \geq i_{k-1} \geq \dots \geq i_1 \geq 1$ and i_j is either odd or the multiple of 4 for any j .

The operator L_0 on $M_{h,c}$ is semisimple. We can consider the eigenspace decomposition of $M_{h,c}$,

$$M_{h,c} = \bigoplus_{i=0}^{\infty} M_{h,c}^{\frac{i}{2}},$$

where L_0 acts as a multiplication by $h - \frac{i}{2}$ on $M_{h,c}^{\frac{i}{2}}$. It is easy to see that this decomposition respects the grading on \mathcal{NV} . We say that a vector $\mathbf{w} \in M_{h,c}$ has level n if $\mathbf{w} \in M_{h,c}^n$.

We call vector \mathbf{w} singular if it has some level n ($n \in \frac{1}{2}\mathbf{Z}_+$) and \mathbf{n}^+ acts by zero on this vector. It is obvious that any singular vector generates a submodule isomorphic to Verma module. If a singular vector has level n then it generates $M_{h-n,c}$.

In the same way as for Virasoro one can define a contravariant Hermitian form $\mathbf{B}(h, c)$ on Verma module $M_{h,c}$. One can see that the spaces $M_{h,c}^{\frac{i}{2}}$, $i \in \mathbf{Z}_+$, are orthogonal for different i . We denote the restriction of the form $\mathbf{B}(h, c)$ to $M_{h,c}^{\frac{i}{2}}$ by $\mathbf{B}_{\frac{i}{2}}(h, c)$.

We have the following determinant formula (see [Kac-Wa]):

$$\det^2(\mathbf{B}_{\mathbf{n}}) = Const \prod_{\substack{k, l \in \mathbf{Z}_+ \\ kl \leq \mathbf{n} \\ k = l \pmod{2}}} \tilde{\Phi}_{k,l}(h, c)^{\frac{\tilde{p}(n-kl)}{2}}, \quad \text{where}$$

$$\begin{aligned} \tilde{\Phi}_{k,l}(h, c) &= \left(h + \frac{(k^2 - 1)c}{24} + \frac{5(1 - k^2) - 4(1 - kl)}{16} \right) \times \\ &\times \left(h + \frac{(l^2 - 1)c}{24} + \frac{5(1 - l^2) - 4(1 - kl)}{16} \right) + \frac{(k^2 - l^2)^2}{64}. \end{aligned}$$

The curve $\tilde{\Phi}_{k,l}(h, c) = 0$ can be given by the following formulas:

$$\begin{aligned} h &= \frac{1 - k^2}{8}t + \frac{1 - kl}{4} + \frac{1 - l^2}{8}t^{-1} \\ c &= 3t + \frac{15}{2} + 3t^{-1}, \quad \text{where } t \in \mathbf{C}^*. \end{aligned}$$

In order to formulate the main result, let us make the following substitution:

$$\begin{aligned} c &= 3 \frac{(2p + q)(2q + p)}{2pq}, \\ h &= \frac{(p + q)^2 - m^2}{8pq}. \end{aligned}$$

Then as in the case of Virasoro we have a quadruple of lines in the plane (k, l) :

$$m = pk + ql, \quad m = pl + qk, \quad 0 = m + pk + ql, \quad 0 = m + pl + qk.$$

Let us choose one of these lines, for example $0 = m + pk + ql$, and denote it by $l_{h,c}$.

8.2 On the structure of Verma Modules.

We shall distinguish the following cases.

Case I. The line $l_{h,c}$ contains no integral points.

Case II. The line $l_{h,c}$ contains exactly one integral point (k, l) . We have the following subcases:

II₋. The product $kl < 0$.

II₀. The product $kl = 0$.

II₊. We distinguish two cases:

a) $k = l \pmod{2}$.

b) $k \neq l \pmod{2}$.

Case III. The line $l_{h,c}$ contains infinitely many integral points. Let us consider two neighboring integral points on the line. Then the second point can be obtained by adding some vector \mathbf{v} to the first point. We can write the vector \mathbf{v} in coordinates (v_1, v_2) . Numbers v_1 and v_2 are integers and we are going to distinguish the following two cases (we denote them by A and B respectively)

A) v_1 and v_2 are both odd

B) one of v_1 and v_2 is odd and the other one is even

v_1 and v_2 can not be even at the same time since we took neighboring points.

Subcase $c \leq \frac{3}{2}$.

III₋⁰⁰. Line $l_{h,c}$ intersects both axes at integral points.

III₋⁰. Line $l_{h,c}$ intersects only one axis at integral point. Let $(k_1, l_1), (k_2, l_2), (k_3, l_3), \dots$ be all integral points (k, l) on the line $l_{h,c}$ up to equivalence $(k, l) \sim (k', l')$ iff $kl = k'l'$ and such that $kl > 0$. We ordered them in such a way that $k_i l_i < k_{i+1} l_{i+1}$ for all $i \in \mathbf{N}$.

A) v_1 and v_2 are both odd.

Then we distinguish two cases:

α) $k_1 \neq l_1 \pmod{2}$

β) $k_1 = l_1 \pmod{2}$

B) one of v_1 and v_2 is odd and the other one is even

We have four cases:

α) $k_1 = l_1$ and $k_2 = l_2 \pmod{2}$

β) $k_1 \neq l_1$ and $k_2 \neq l_2 \pmod{2}$ then $k_3 = l_3$ and $k_4 = l_4 \pmod{2}$

γ) $k_1 \neq l_1 \pmod{2}$, $k_2 = l_2$ and $k_3 = l_3 \pmod{2}$ then $k_4 \neq l_4 \pmod{2}$

δ) $k_1 = l_1$ and $k_4 = l_4 \pmod{2}$ then $k_2 \neq l_2$ and $k_3 \neq l_3 \pmod{2}$

III₋. Line $l_{h,c}$ intersects both axes at non-integral points. Let $(k_1, l_1), (k_2, l_2), (k_3, l_3), \dots$ be all integral points (k, l) on the line $l_{h,c}$ such that $k_i = l_i \pmod{2}$ for all $i \in \mathbf{N}$ up to equivalence $(k, l) \sim (k', l')$ iff $kl = k'l'$ and such that $kl > 0$. We ordered them in such a way that $k_i l_i < k_{i+1} l_{i+1}$ for all $i \in \mathbf{N}$. In this case we draw an auxiliary line, $l'_{h,c}$, parallel to $l_{h,c}$ through the point $(k_1, -l_1)$. Let $(k'_1, l'_1), (k'_2, l'_2), (k'_3, l'_3), \dots$ be all integral points (k, l) on the line $l'_{h,c}$ such that $k'_i = l'_i \pmod{2}$ for all $i \in \mathbf{N}$ up to equivalence $(k, l) \sim (k'', l'')$ iff $kl = k''l''$ and such that $kl > 0$. We ordered them in such a way that $k'_i l'_i < k'_{i+1} l'_{i+1}$ for all $i \in \mathbf{N}$. Then it is easy to see that we have the following inequalities:

$$\begin{aligned} k_1 l_1 &< k_2 l_2 < k_1 l_1 + k'_1 l'_1 < k_1 l_1 + k'_2 l'_2 < k_3 l_3 < k_4 l_4 < \\ &< k_1 l_1 + k'_3 l'_3 < k_1 l_1 + k'_4 l'_4 < k_5 l_5 < k_6 l_6 < \dots \end{aligned}$$

We distinguish two case:

A) v_1 and v_2 are both odd. Then either both sets $\{(k_1, l_1), (k_2, l_2), (k_3, l_3), \dots\}$ and $\{(k'_1, l'_1), (k'_2, l'_2), (k'_3, l'_3), \dots\}$ are empty (subcase α) or not (subcase β).

B) one of v_1 and v_2 is odd and the other one is even.

Subcase $c \geq \frac{27}{2}$.

III₊⁰⁰. Line $l_{h,c}$ intersects both axes at integral points.

III₊⁰. Line $l_{h,c}$ intersects only one axis at integral point. Let $\{(k_1, l_1), (k_2, l_2), \dots, (k_s, l_s)\}$ be all integral points (k, l) on the line $l_{h,c}$ up to equivalence $(k, l) \sim (k', l')$ iff $kl = k'l'$ and such that $kl > 0$. We ordered them in such a way that $k_i l_i < k_{i+1} l_{i+1}$ for all $i \in \{1, 2, \dots, s-1\}$.

A) v_1 and v_2 are both odd.

We distinguish two cases:

α) $k_1 \neq l_1 \pmod{2}$

β) $k_1 = l_1 \pmod{2}$

B) one of v_1 and v_2 is odd and the other one is even

Then we have four cases:

α) $k_1 = l_1$ and $k_2 = l_2 \pmod{2}$

β) $k_1 \neq l_1$ and $k_2 \neq l_2 \pmod{2}$ then $k_3 = l_3$ and $k_4 = l_4 \pmod{2}$

γ) $k_1 \neq l_1 \pmod{2}$, $k_2 = l_2$ and $k_3 = l_3 \pmod{2}$ then $k_4 \neq l_4 \pmod{2}$

δ) $k_1 = l_1$ and $k_4 = l_4 \pmod{2}$ then $k_2 \neq l_2$ and $k_3 \neq l_3 \pmod{2}$

III₊. Line $l_{h,c}$ intersects both axes at non-integral points. Let $\{(k_1, l_1), (k_2, l_2), \dots, (k_s, l_s)\}$ be all integral points (k, l) on the line $l_{h,c}$ such that $k_i = l_i \pmod{2}$ for all $i \in \{1, 2, \dots, s\}$ up to equivalence $(k, l) \sim (k', l')$ iff $kl = k'l'$ and such that $kl > 0$. We ordered them in such a way that $k_i l_i < k_{i+1} l_{i+1}$ for all $i \in \{1, 2, \dots, s-1\}$. In this case we draw an auxiliary line, $l'_{h,c}$, parallel to $l_{h,c}$ through the point $(k_1, -l_1)$. Let $(k'_1, l'_1), (k'_2, l'_2), \dots, (k'_s, l'_s)$ be all integral points (k, l) on the line $l'_{h,c}$ such that $k'_i = l'_i \pmod{2}$ for all $i \in \{1, 2, \dots, s-1\}$ up to equivalence $(k, l) \sim (k'', l'')$ iff $kl = k''l''$ and such that $kl > 0$. We ordered them in such a way that $k'_i l'_i < k'_{i+1} l'_{i+1}$ for $i \in \{1, 2, \dots, s-1\}$.

Then it is easy to see that we have the following inequalities:

$$\begin{aligned} k_1 l_1 < k_2 l_2 < k_1 l_1 + k'_1 l'_1 < k_1 l_1 + k'_2 l'_2 < k_3 l_3 < k_4 l_4 < \\ < k_1 l_1 + k'_3 l'_3 < k_1 l_1 + k'_4 l'_4 < k_5 l_5 < k_6 l_6 < \dots \end{aligned}$$

We distinguish two cases:

A) v_1 and v_2 are both odd. Then either both sets $\{(k_1, l_1), (k_2, l_2), (k_3, l_3), \dots\}$ and $\{(k'_1, l'_1), (k'_2, l'_2), (k'_3, l'_3), \dots\}$ are empty (subcase α) or not (subcase β).

B) one of v_1 and v_2 is odd and the other one is even.

Theorem D.

a) In cases **I, II, III₋, III⁰₋, III₊** and **III⁰₊** all submodules of Verma module are generated by singular vectors.

b) i) In cases **I, II₋, II₀, II₊.a)**, **III⁰₋.A)α)**, **III⁰₊.A)α)**, **III₋.A)α)** and **III₊.A)α)** Verma module is irreducible.

ii) In case **II₊.b)** Verma module $M_{h,c}$ has a unique submodule generated by the singular vector at level kl . This submodule is isomorphic to Verma module $M_{h-kl,c}$ which is irreducible (case **II₋**).

iii) In cases **III⁰₋.A)β)**, **III⁰₋.B)** and **III₋** we have an infinite number of singular vectors. All singular vectors and relations between them are shown on the diagrams below. Singular vectors are denoted by points with their weights indicated. An arrow or a chain of arrows from one point to another means that the second singular vector lies in the submodule generated by the first one.

iv) In cases **III⁰₊.A)β)**, **III⁰₊.B)** and **III₊** we have a finite number of singular vectors (maybe zero). All singular vectors and relations between them are shown on the diagrams below. Singular vectors are denoted by points with their weights indicated. An arrow or a chain of arrows from one point to another means that the second singular vector lies in the submodule generated by the first one.

8.3 Sketch of the proof.

Let $M_{h,c}$ be a Verma module with the central charge c and the highest weight h . Then the following theorem can be proved similarly to theorem 3.1..

Theorem 8.1. *At each level $n \in \frac{1}{2}\mathbf{Z}$ only one singular vector \mathbf{w} can exist. If the singular vector, \mathbf{w} , exists then it is given by the following formula*

$$\mathbf{w} = (L_{-\frac{1}{2}})^{2n} \mathbf{v}_{h,c} +$$

$$\begin{aligned}
& + \sum_{\substack{i_k + \dots + i_1 = 2n \\ i_k \geq i_{k-1} \geq \dots \geq i_1 \geq 1 \\ i_k \geq 3}} \mathbf{P}_{i_1, \dots, i_k}^{(n)}(h, c) L_{-\frac{i_k}{2}} L_{-\frac{i_{k-1}}{2}} \dots L_{-\frac{i_2}{2}} L_{-\frac{i_1}{2}} \mathbf{v}_{h,c} \\
& \text{where } i_j \text{ is either odd} \\
& \text{or a multiple of 4 for any } j
\end{aligned}$$

which defines \mathbf{w} up to multiplication by a constant. $\mathbf{P}_{i_1, \dots, i_k}^{(n)}(h, c)$ are polynomials in h and c .

One can see that the proof of the structure of Verma modules in the simple cases uses only the Kac determinant formula and theorem **3.1**. We have the analog of both *i.e.*, theorem **8.1**. and the determinant formula. Repeating the arguments which we used in the case of Virasoro (almost word for word with minor modifications) one can see that **Theorem D** is true.

Case $\text{III}_-^0.A)\beta)$

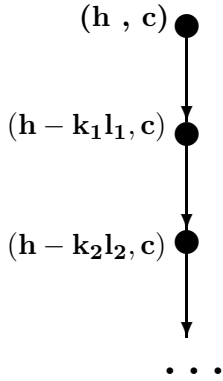

Case III_-

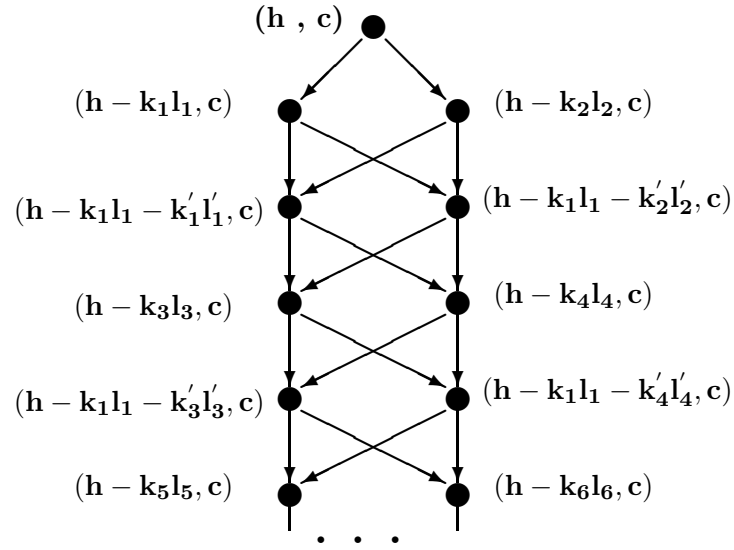

Case $\text{III}_+^0.A)\beta)$

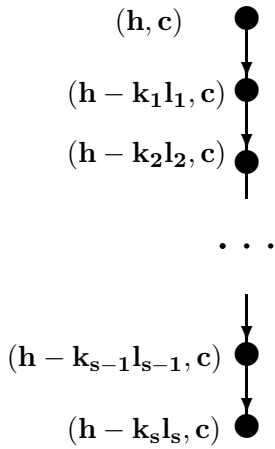

Case III_+

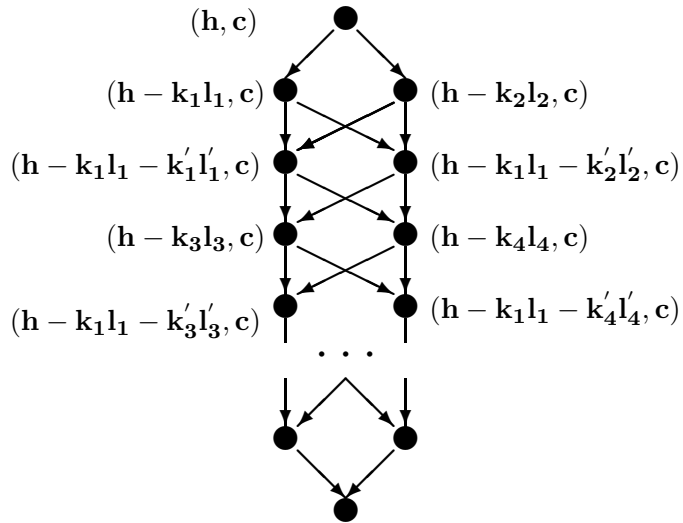

Case III⁰.B) β)

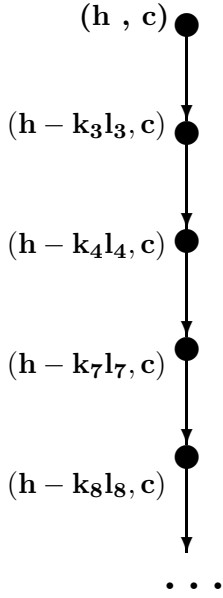

Case III⁰.B) α)

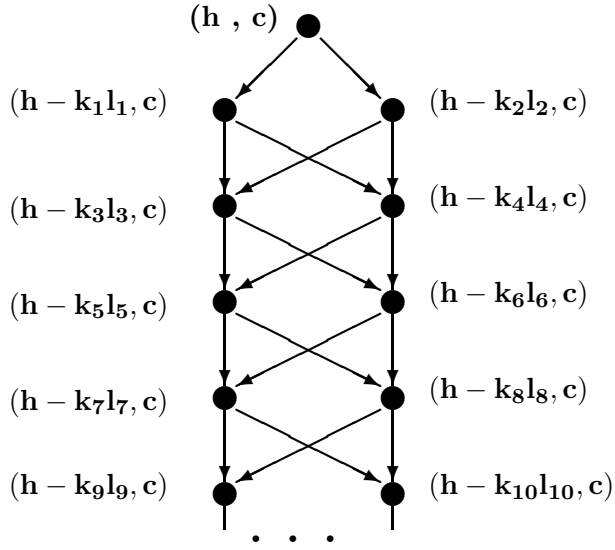

Case III⁰.B) δ)

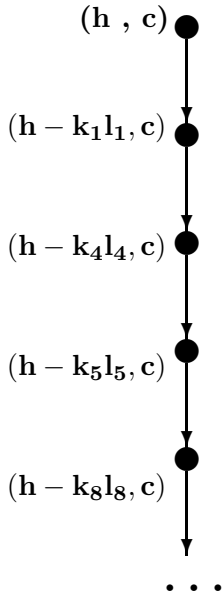

Case III⁰.B) γ)

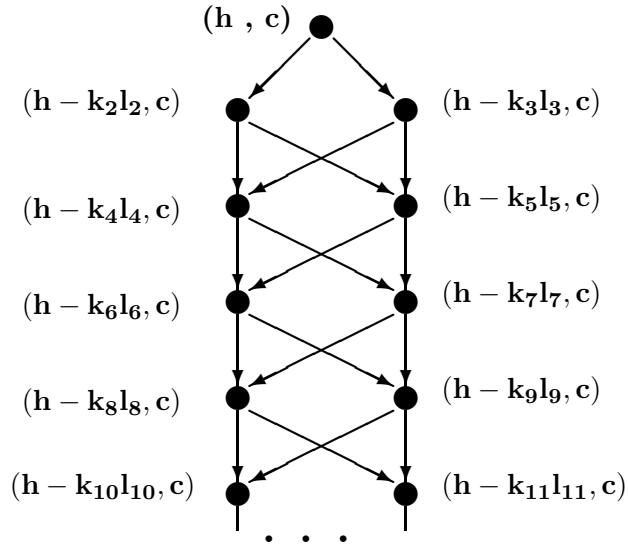

Case $\text{III}_+^0.B)\beta)$

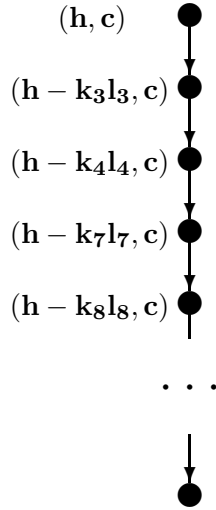

Case $\text{III}_+^0.B)\alpha)$

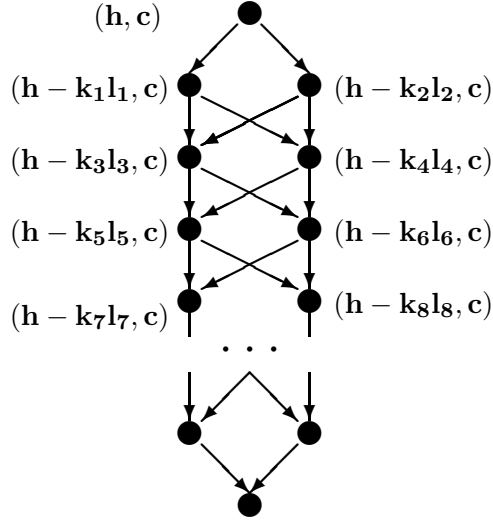

Case $\text{III}_+^0.B)\delta)$

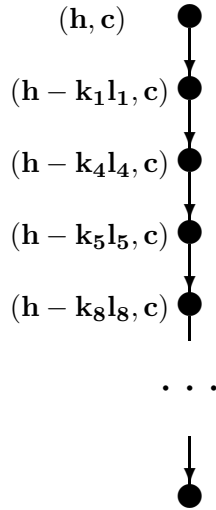

Case $\text{III}_+^0.B)\gamma)$

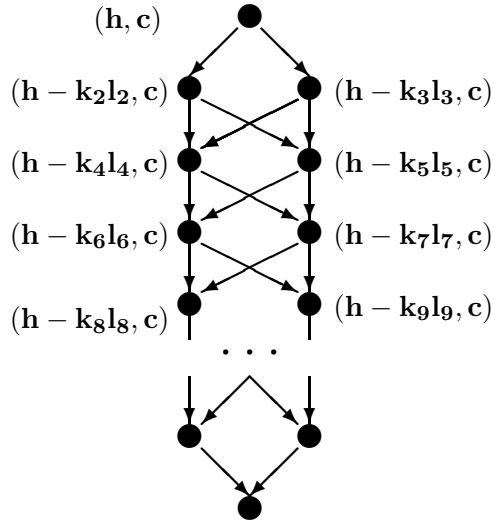

Figure 1.

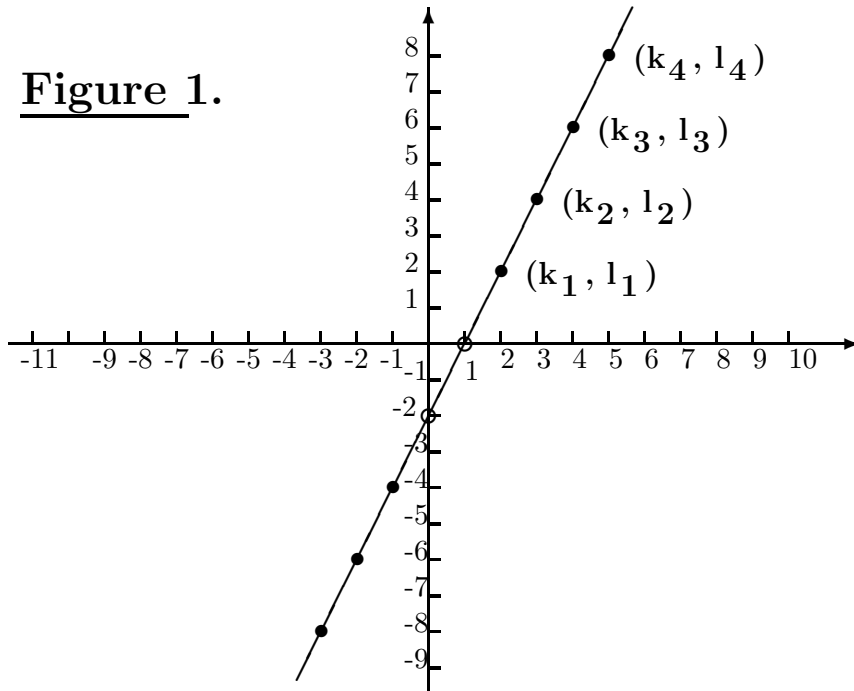

Figure 2.

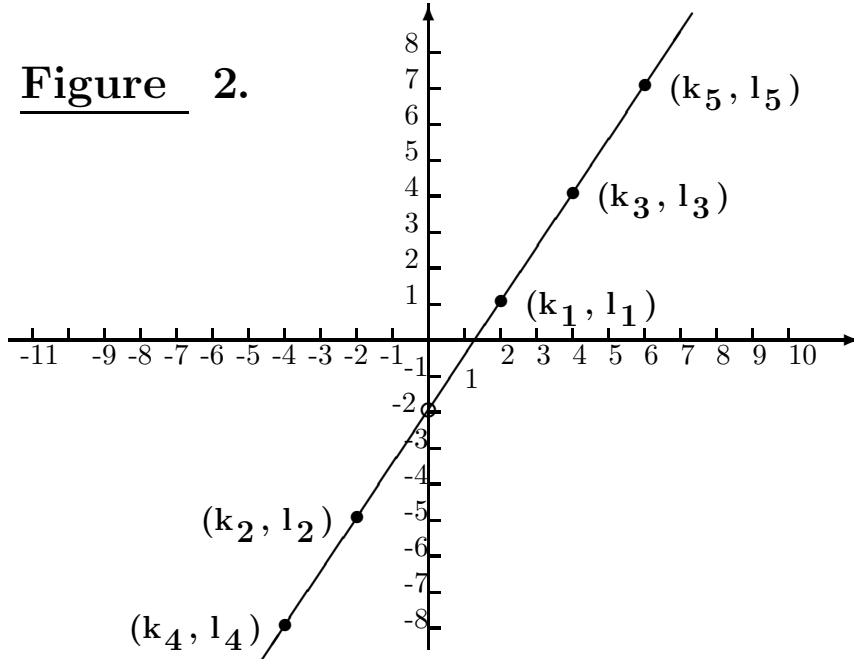

Figure 3.

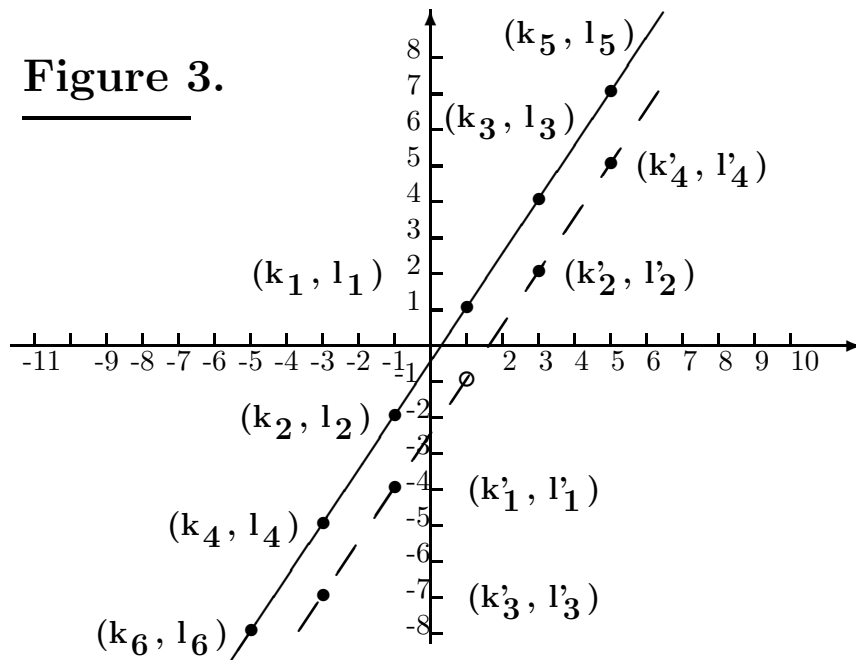

Figure 4.

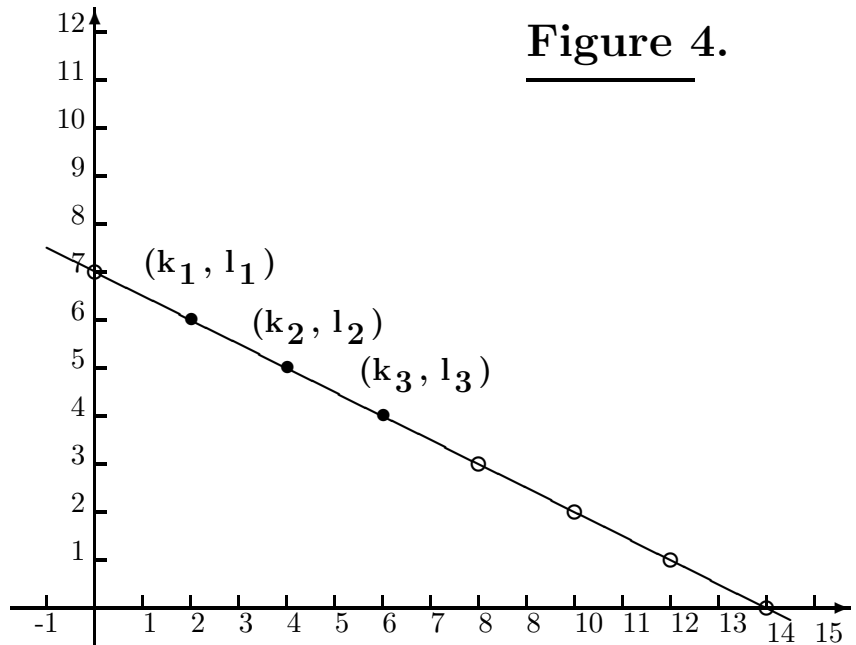

Figure 5.

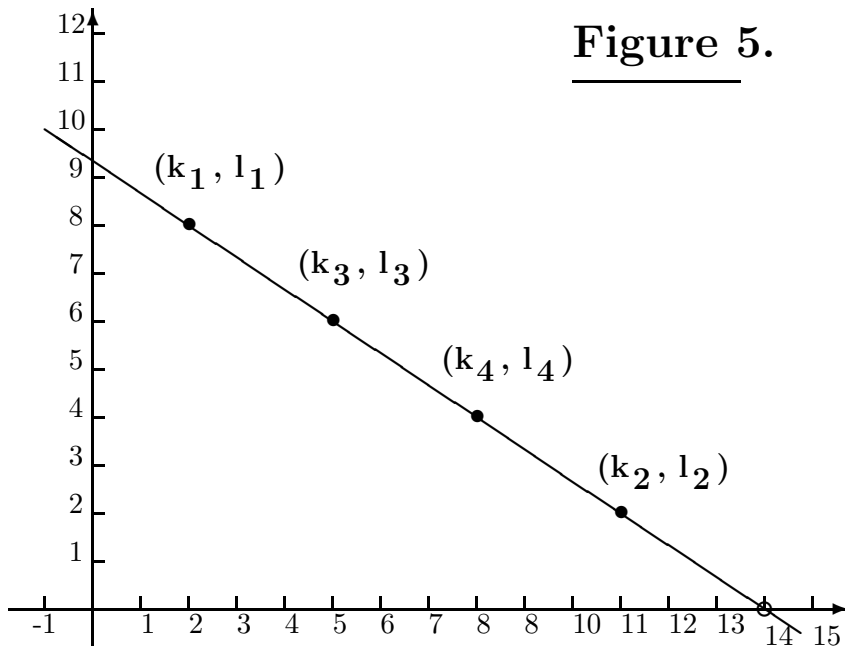
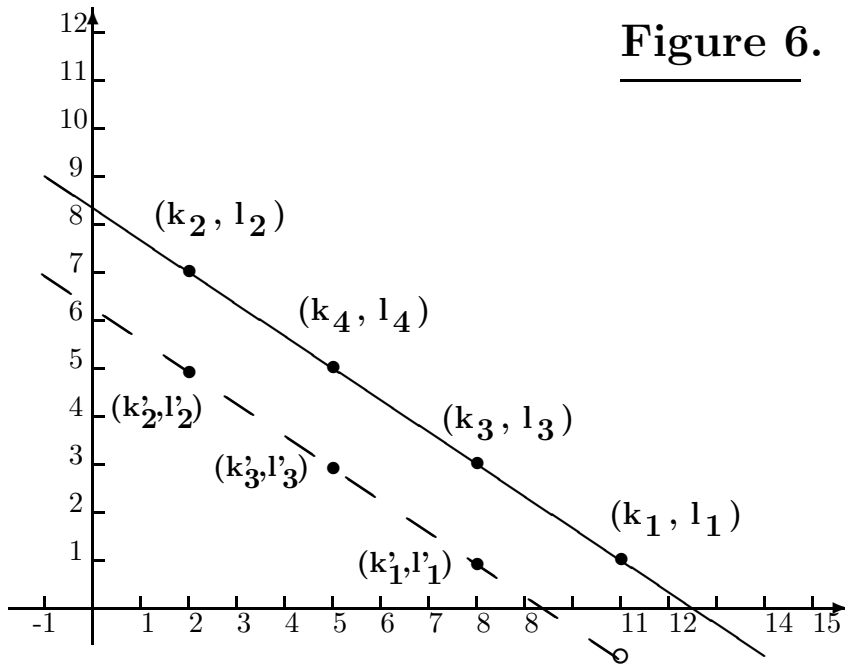

Figure 6.



References

- [**Ast-Fu**] A.B. Astashkevich, D.B. Fuchs “Asymptotic of singular vectors in Verma modules over the Virasoro Lie algebra.” to appear
- [**Fe-Fu 1**] B.L. Feigin, D.B. Fuchs “Representation of the Virasoro algebra.”, *Advanced Studies in Contemporary Mathematics*, 7; Gordon and Breach Science Publishers, N.Y. 1990, pp.465-554
- [**Fe-Fu 2**] B.L. Feigin, D.B. Fuchs “Skew-symmetric differential operator on the line and Verma modules over the Virasoro algebra.”, *Funct. Anal. and Appl.* (1982), 16, No. 2, pp. 47-63
- [**Fre**] E. Frenkel “Determinant formulars for the free field representations of the Virasoro and Kac-Moody algebras.”, *Physics Letters B* 286 (1992), pp. 71-77
- [**Fu 1**] D.B. Fuchs “Doctor’s thesis.” in Russian
- [**Fu 2**] D.B. Fuchs “Cogomology of infinite- dimensional Lie algebras.” New York, Consultants Bureau, 1988
- [**Ja**] Jantzen J.C. “Moduln mit einem hochsten a ewicht.” *Lecture notes in mathematics* 750, Springer-Verlag
- [**Kac 1**] V.G. Kac “Infinite-Dimensional Lie algebras.” Cambridge University Press, 1990
- [**Kac 2**] V.G. Kac “Contravariant form for infinite-dimensional Lie algebras and superalgebras.”, *Lect. Notes in Phys.* (1979), 94, pp. 441-445
- [**Kac-Kaz**] V.G. Kac, D.A. Kazhdan “Structure of representations with highest weight of infinite-dimensional Lie algebras.”, *Adv. Math.* (1979), 34, pp. 97-108

[**Kac-Ra**] V.G. Kac, A.K. Raina “Bombay lectures on highest weight representations of infinite dimensional Lie algebras.” World Sci., Singapore, 1987

[**Kac-Wa**] V.G. Kac, M. Wakimoto “Unitarizable highest weight representations of the Virasoro, Neveu-Schwartz and Ramond algebras.” in Proceedings of the Symposium on conformal groups and structures, Claustal, 1985, Lecture Notes in Physics 261, (1986), pp. 345-372