

Unoriented Open-Closed String Field Theory

Taichiro KUGO^{*)} and Tomohiko TAKAHASHI^{†,**)}

Department of Physics, Kyoto University, Kyoto 606-01

[†]*Department of Physics, University of Tokyo, Tokyo 113*

(Received November 14, 1997)

The string field theory for unoriented open-closed string mixed system is constructed up to quadratic order based on the joining-splitting type vertices. The gauge invariance with closed string transformation parameter is proved. The infinity cancellation mechanism between disk and projective plane amplitudes plays an essential role for the gauge invariance of the theory.

§1. Introduction

The discovery of D-branes¹⁾ has brought us with a quite new insight into string theories and various duality properties there, and actually triggered the recent rapid developments in the fields. Now the string theory seems no longer the theory of string alone, but the theory for a totality of branes with various dimensional extension.

The most remarkable one among the recent developments would be matrix theory formulations for such a ‘string theory’,^{2),3)} in which the various dimensional branes seems to be described unifiedly by a very simple looking system of matrix variables. It may also suggest a possibility for a quite new formulation for the ‘second-quantized theory’ of many body systems in place of the conventional field theory. There are, however, many subtle problems in the limiting procedure of $N \rightarrow \infty$ and it is still lacking some key idea for the matrix theory to become a truly powerful ‘second quantized theory’ by which the conventional field theory can be a replaced. We still have something to learn from the conventional field theory.

Despite these developments the dynamics of the D-branes does not seem fully made clear. At this stage it would be necessary to try various approaches to reveal the string dynamics, namely, of various branes. There already appears some trials for studying the string system with D-branes in terms of string field theories. One approach by Hashimoto and Hata⁴⁾ is to introduce the D-brane explicitly in the closed string field theory as a source term using the boundary state. Another approach by Zwiebach,⁵⁾ who worked in the non-polynomial string field theory framework, is based on oriented open-closed string field theory, in which D-branes were not directly introduced but it is described by the end points of the open string by performing the T-duality transformation.

The purpose of this paper is to construct the string field theory for unoriented open-closed string mixed system with joining-splitting type vertices and to reveal

^{*)} E-mail address: kugo@gauge.scphys.kyoto-u.ac.jp

^{**)} JSPS Research Fellow. E-mail address: tomo@hep-th.phys.s.u-tokyo.ac.jp

the gauge symmetry structure. This is of course in the hope to study the D-brane dynamics eventually. In open-closed string theories, the unoriented Type I theory with gauge group $SO(32)$ is the only known consistent one. Unless the gauge group is $SO(32)$, the anomaly does not cancel, and the infinities coming from the dilaton tadpole do appear so that the supersymmetric vacuum becomes unstable.^{6),7)} In bosonic case also, the infinities of the dilaton tadpole are known to be canceled if and only if the gauge group is $SO(2^{13} = 8192)$ in the unoriented theory.⁸⁾ Therefore, we can naturally expect that this infinity cancellation mechanism also work to guarantee the gauge invariance of the open-closed string field theory.

Since the bosonic string theories always suffer from the tachyon problem, we should ideally treat supersymmetric string theories. But, at the present stage, there are still difficult problems for constructing supersymmetric string field theories.^{9),10)} So we here have to content ourselves with the construction of bosonic string field theory for the unoriented open-closed mixed system with gauge group $SO(n)$. Moreover, in this open-closed mixed system, there is an anomaly for the gauge transformation with open-string field parameter, which is similar to more familiar Lorentz anomaly in the light-cone gauge string field theory.^{11),12),13)} Since we need a bit complicated loop amplitude calculations to treat it, we defer the discussion of the open-string parameter gauge transformation to the forthcoming paper.¹⁴⁾ In this paper, we treat only the gauge transformation with closed string field parameter restricting the action to the quadratic part in the string fields.

In the unoriented open-closed string field theory, there are three type of vertices for quadratic interactions as drawn in Fig. 1. One of them, U , corresponds to the transition from open to closed string, and vice versa. The others, V_α and V_∞ , are the vertices in which an open or closed string intersects itself and rearranges. So, we can write the quadratic part of the action in the form:

$$S = -\frac{1}{2}\Psi \cdot \tilde{Q}_B \Psi - \frac{1}{2}\Phi \cdot \tilde{Q}_B b_0^- \Phi + x_u g \Psi \cdot U \Phi + x_\alpha \frac{g^2}{2} \Psi \cdot V_\alpha \Psi + x_\infty \frac{g^2}{2} \Phi \cdot V_\infty \Phi, \quad (1.1)$$

where Ψ and Φ denote open and closed string field, respectively, and x_u , x_α and x_∞ are coupling constants (relative to the open 3-vertex coupling constant g) for the open-closed transition U , open intersection V_α and closed intersection V_∞ interactions, respectively. The details of the definition will be explained in the text.

We consider the following form of gauge transformation with a closed string field parameter Λ^c :

$$\begin{aligned} \delta(b_0^- \Phi) &= -\tilde{Q}_B b_0^- \Lambda^c + x_\infty g^2 V_\infty \Lambda^c, \\ \delta\Psi &= x_u g U \Lambda^c, \end{aligned} \quad (1.2)$$

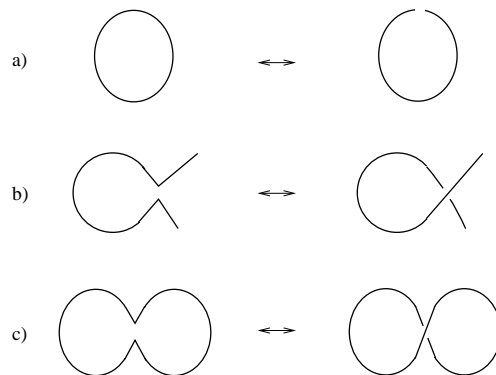

Fig. 1. Interaction vertices a) U , b) V_α and c) V_∞ .

where A^c denotes a functional of closed string coordinate. Under this transformation, the action of Eq. (1.1) is transformed, roughly writing, as

$$\begin{aligned} \delta S = & \Phi \cdot \tilde{Q}_B^2 b_0^- A^c + x_u g \Psi \cdot [\tilde{Q}_B, U] A^c + g^2 \Phi \cdot \left(x_u^2 UU - x_\infty \{\tilde{Q}_B, V_\infty\} \right) b_0^- A^c \\ & + x_u g^3 \Psi \cdot (-x_\infty UV_\infty + x_\infty V_\infty U) A^c - x_\infty g^4 \Phi \cdot V_\infty V_\infty A^c. \end{aligned} \quad (1.3)$$

In order to realize the gauge invariance, each term of Eq. (1.3) must vanish order by order. Moreover, in $O(g^2)$ terms in Eq. (1.3), the first UU term corresponds to a singular world sheet of a disk and the second $\{\tilde{Q}_B, V_\infty\}$ term to real projective (RP^2) plane, each with two external states. They both contain infinities due to the dilaton and tachyon contributions in the configuration drawn in Fig. 9 below. Thus, the unoriented open-closed string field theory can be gauge invariant if and only if the infinity cancellation occurs between the disk and RP^2 amplitudes. Conversely speaking, in the case of *oriented* open-closed string field theory, there is no RP^2 contribution since it comes from the V_∞ vertex characteristic to the unoriented string, and therefore it requires other novel infinity cancellation mechanism¹⁵⁾ in order for the oriented string theory to be gauge invariant. This point is also the problem for the Lorentz invariance in the light-cone gauge string field theory of oriented open-closed strings, which seems to have not been noticed by other authors up to now.^{11), 12), 13)}

This paper is organized as follows. In sect. 2, we fix our conventions and notations for string fields as well as string coordinates as conformal fields. In sects. 3 and 4, we give precise definitions for the above vertices and action. In sect. 5, we prove the gauge invariance of the quadratic action for unoriented open-closed string field theory and determine relations between various coupling constants to satisfy the gauge invariance. Then, in sect. 6, we calculate two closed tachyon amplitudes corresponding to the disk and RP^2 from string field theory action, and see that the infinity cancellation occurs if and only if the gauge invariance condition is met. Sect. 7 is devoted to the summary and some more discussions on the gauge symmetry. Appendix A is added for clarifying the relations between three different expressions for the vertices by LeClair, Peskin and Preitschopf (LPP),¹⁶⁾ Kunitomo and Suehiro (KS),¹⁷⁾ and Hata, Itoh, Kugo, Kunitomo and Ogawa (HIKKO),^{18), 19)} which is necessary for the gauge-invariance proof in Sect. 5. Appendix B gives the explicit formula for the Neumann coefficients of open-closed transition vertex.

§2. String Fields

Let us recall the mode expansion of string coordinates $\phi \equiv (X^\mu, c, b)$ and fix our convention. In a unit disk $|w_r| \leq 1$, the string coordinates are expanded as

$$\begin{aligned} X^\mu(w_r) &= x^\mu - i \alpha_0^\mu \ln w_r + i \sum_{n \neq 0} \frac{1}{n} \alpha_n^\mu w_r^{-n}, \\ c(w_r) &= \sum_n c_n w_r^{-n+1}, \quad b(w_r) = \sum_n b_n w_r^{-n-2}, \\ [x^\mu, \alpha_0^\nu] &= i \eta^{\mu\nu}, \quad \eta^{\mu\nu} = \text{diag}(-1, +1, \dots, +1), \end{aligned} \quad (2.1)$$

where r denotes r -th string and $l_s = \sqrt{2\alpha'}$ is set equal to 1. There is also an anti-holomorphic counterpart $\bar{\phi}(\bar{w}_r) = (\bar{X}^\mu(\bar{w}_r), \bar{c}(\bar{w}_r), \bar{b}(\bar{w}_r))$ for closed string, which lives in the unit disk with anti-holomorphic coordinate \bar{w}_r , $|\bar{w}_r| \leq 1$. For any conformal mapping $z \rightarrow z'$, the string coordinates $\phi(z)$ are mapped as follows according to their conformal weights $d_\phi = (0, -1, +2)$ for $\phi = X^\mu, c, b$:

$$\phi(z) \rightarrow \phi'(z') = \left(\frac{dz}{dz'} \right)^{d_\phi} \phi(z). \quad (2.2)$$

The unit disk can of course be mapped to a semi-infinite cylinder with more familiar world-sheet coordinate $\rho_r = \tau_r + i\sigma_r$, $\tau_r \leq 0$ by a conformal mapping $w_r = e^{\rho_r} = e^{\tau_r + i\sigma_r}$, and the string coordinates on the ρ_r plane are therefore given by

$$\begin{aligned} X^\mu(\rho_r) &= x^\mu - i\alpha_0^\mu \rho_r + i \sum_{n \neq 0} \frac{1}{n} \alpha_n^\mu e^{-n\rho_r}, \\ c(\rho_r) &= \sum_n c_n e^{-n\rho_r}, \quad b(\rho_r) = \sum_n b_n e^{-n\rho_r}. \end{aligned} \quad (2.3)$$

For open-string, the σ_r originally runs only over $0 \leq \sigma_r \leq \pi$, but it is extended in these equations to run over $0 \leq \sigma_r \leq 2\pi$ just as for the closed string. Because of 2π periodicity of σ_r , we shall conveniently take also the region $-\pi \leq \sigma_r \leq \pi$ as well as $0 \leq \sigma_r \leq 2\pi$ as the fundamental region of σ_r both for open and closed strings, depending on the situations. Note also that the real string coordinate $X^\mu(\sigma, \tau)$ is given by

$$X^\mu(\sigma, \tau) = \frac{1}{2} \left(X^\mu(\rho) + \bar{X}^\mu(\bar{\rho}) \right) \quad (2.4)$$

with the understanding that $\bar{X}^\mu = X^\mu$ for open string case.

The open string field Ψ and closed one Φ are denoted in our notation by

$$\begin{aligned} |\Psi\rangle &= |\phi\rangle + c_0 |\psi\rangle, \\ |\Phi\rangle &= c_0^- \left(|\phi\rangle + c_0^+ |\psi\rangle \right) + \left(|\chi\rangle + c_0^+ |\eta\rangle \right). \end{aligned} \quad (2.5)$$

It should be kept in mind that the open string field is $n \times n$ matrix valued; $|\Psi\rangle_{ij}$. As for the ghost zero-modes for the closed string, we use the notation:

$$\begin{aligned} c_0^+ &\equiv \frac{1}{2}(c_0 + \bar{c}_0), \quad c_0^- = c_0 - \bar{c}_0, \\ b_0^+ &\equiv b_0 + \bar{b}_0, \quad b_0^- \equiv \frac{1}{2}(b_0 - \bar{b}_0). \end{aligned} \quad (2.6)$$

The physical fields are contained in the $|\phi\rangle$ component. We take the $|\phi\rangle$ component to be Grassmann even, so that the closed string field $|\Phi\rangle$ is Grassmann *odd* while the open string field $|\Psi\rangle$ is *even*. We define the Fock vacuum $|1\rangle = (\langle 1|)^\dagger$ by

$$\begin{aligned} \alpha_n^\mu |1\rangle &= 0 \quad \text{for } n \geq 1, \\ c_n |1\rangle &= 0 \quad \text{for } n \geq 1, \\ b_n |1\rangle &= 0 \quad \text{for } n \geq 0, \end{aligned} \quad (2.7)$$

and we keep to use the coordinate (or momentum) representation for the zero modes p^μ , x^μ . $|1, 1\rangle = (\langle 1, 1|)^\dagger$ is the Fock vacuum for the closed string possessing the holomorphic and anti-holomorphic oscillator freedoms. Concerning the ghost mode part, in particular, the Fock vacuum is related with the conformal vacuum $|0\rangle$ by

$$|1\rangle = c_1 |0\rangle, \quad \langle 1| = \langle 0|c_{-1}, \quad \text{so that} \quad \langle 1|c_0 |1\rangle = \langle 0|c_{-1}c_0c_1 |0\rangle = 1. \quad (2.8)$$

The label 1 of the Fock vacuum $|1\rangle$, thus, implies the ghost number relative to the conformal vacuum. As for the order of the holomorphic and anti-holomorphic ghost zero-modes for the closed string case, we take a convention

$$\langle 1, 1|c_0^- c_0^+ |1, 1\rangle = \langle 1, 1|c_0 \bar{c}_0 |1, 1\rangle = 1. \quad (2.9)$$

We here define reflectors,²⁰⁾ which convert the ket representation to the bra representation, for the open and closed strings, respectively:

$$\begin{aligned} \langle R^o(1, 2)| &= \delta(1, 2) {}_1\langle 1|_2 \langle 1|(c_0^{(1)} + c_0^{(2)}) \exp(E_{12}^o), \\ \langle R^c(1^c, 2^c)| &= \delta(1, 2) {}_1\langle 1, 1|_2 \langle 1, 1|(c_0^{+(1)} + c_0^{+(2)})(c_0^{-(1)} + c_0^{-(2)}) \exp(E_{12}^c), \end{aligned} \quad (2.10)$$

with the exponents given by

$$\begin{aligned} E_{12}^o &= \sum_{n \geq 1} (-)^{n+1} \left(\frac{1}{n} \alpha_n^{\mu(1)} \alpha_{n\mu}^{(2)} + c_n^{(1)} b_n^{(2)} - b_n^{(1)} c_n^{(2)} \right), \\ E_{12}^c &= - \sum_{n \geq 1} \left(\frac{1}{n} \alpha_n^{\mu(1)} \alpha_{n\mu}^{(2)} + c_n^{(1)} b_n^{(2)} - b_n^{(1)} c_n^{(2)} \right) + \text{a.h.}, \end{aligned} \quad (2.11)$$

and the delta functions by

$$\delta(1, 2, \dots, n) = (2\pi)^d \delta^d \left(\sum_{r=1}^n p_r^\mu \right) \quad (2.12)$$

with $d = 26$. We understood that the delta function $\delta(1, 2)$ in $\langle R^o(1, 2)|$ case also implies the matrix reflection $\delta(i_1, j_1; i_2, j_2) \equiv \delta_{i_1, j_2} \delta_{i_2, j_1}$. We also define ket reflectors $|R^{o,c}\rangle$ as the inverse of the bra reflectors $\langle R^{o,c}|$ in the sense that

$$\begin{aligned} \langle R^o(1, 3)| |R^o(3, 2)\rangle | \Psi \rangle_1 &= | \Psi \rangle_2, \quad \text{for } \forall \Psi, \\ \langle R^c(1^c, 3^c)| |R^c(3^c, 2^c)\rangle | \Phi \rangle_{1^c} &= | \Phi \rangle_{2^c} \quad \text{for } \forall \Phi, \end{aligned} \quad (2.13)$$

where the inner-product of the bra and ket states implies, in addition to the usual product for oscillators, integration over the zero-modes, $\int d^d p / (2\pi)^d$ (as well as the trace operation over the matrix for the open string case). The ket reflectors are easily seen to be the minus of the hermitian conjugates of the bra reflectors:

$$|R^o(1, 2)\rangle = - (\langle R^o(2, 1)|)^\dagger, \quad |R^c(1^c, 2^c)\rangle = - (\langle R^c(2^c, 1^c)|)^\dagger. \quad (2.14)$$

We note the symmetry property of the reflectors:

$$\begin{aligned} \langle R^o(2, 1)| | \Psi \rangle_1 | \Psi' \rangle_2 &= - (-1)^{|\Psi||\Psi'|} \langle R^o(1, 2)| | \Psi' \rangle_2 | \Psi \rangle_1, \\ \langle R^c(2^c, 1^c)| | \Phi \rangle_1 | \Phi' \rangle_2 &= (-1)^{|\Phi||\Phi'|} \langle R^c(1^c, 2^c)| | \Phi' \rangle_2 | \Phi \rangle_1, \end{aligned} \quad (2.15)$$

where $|\Psi\rangle$ is 0 (1) if $|\Psi\rangle$ is Grassmann even (odd). The minus sign for the former comes from the interchange of the bra Fock vacua: ${}_2\langle 1|_1\langle 1| = -{}_1\langle 1|_2\langle 1|$, which effectively contains the ghost zero-mode integration $\int dc_0^{(2)} dc_0^{(1)} = -\int dc_0^{(1)} dc_0^{(2)}$.

In defining string vertices below, we assign string length α to each participating string. Basically we adopt in this paper the so-called $\alpha = p^+$ HIKKO theory,²⁰⁾ in which we identify the string length α as follows:

$$\alpha = \begin{cases} 2p^+ & \text{for open string} \\ p^+ & \text{for closed string.} \end{cases} \quad (2.16)$$

So the α parameter is not an independent freedom unlike in HIKKO theory. (The following discussion in this paper will, however, be equally valid even when we instead adopt the standpoint of ‘covaliantized light-cone string field theory’^{21), 22), 23), 24)} provided that we make a suitable re-interpretation like replacing the zero mode variable p^μ by an $\text{OSp}(d+2|2)$ vector.) Since only the ratio of the α parameters is relevant to the vertices, the string length parameter α can be fixed to be ± 2 for open and ± 1 for closed strings, respectively, in this paper where only the quadratic vertices are treated.

§3. Vertices

We construct BRS invariant vertices corresponding to three types of interactions following the method of LeClair, Peskin and Preitschopf (LPP).¹⁶⁾

To define BRS invariant vertices a la LPP, we have to specify the way how to connect the strings: a single ρ -plane is constructed by gluing the ρ_r -planes (or, unit disks w_r .) of individual strings. In the case of the open-closed transition vertex U , the coordinate ρ is identified region-wise with the coordinate of each string, as depicted in Fig. 2:

$$\rho = \tau + i\sigma = \begin{cases} \rho_1 = \tau_1 + i\sigma_1 & \text{for } \tau \leq 0, \quad 0 \leq \sigma \leq 2\pi : \text{region 1} \\ \bar{\rho}_1 = \tau_1 - i\sigma_1 & \text{for } \tau \leq 0, \quad -2\pi \leq \sigma \leq 0 : \text{region 1}^* \\ -2\rho_2 + 2\pi i & \text{for } \tau \geq 0, \quad -2\pi \leq \sigma \leq 2\pi : \text{region 2.} \end{cases} \quad (3.1)$$

Note that, as explained before, we have assigned string length parameter $\alpha_1 = 1$ for

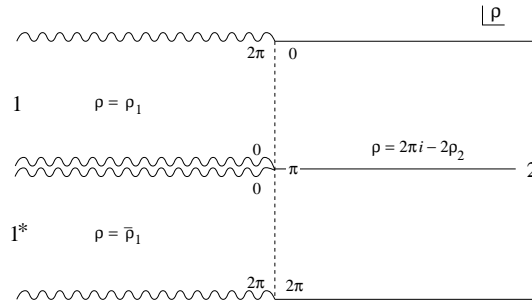

Fig. 2. The ρ plane representing the connection of open-closed transition vertex U .

incoming closed string 1 and $\alpha_2 = -2$ for outgoing open string 2. The regions 1 and 1* stand for the holomorphic and anti-holomorphic parts of the closed string 1, and the region 2 for the open string 2. With this gluing, a single holomorphic function $\phi(\rho)$ is defined on the ρ plane:

$$\phi(\rho) = \begin{cases} \phi^{(1)}(\rho) & \text{in region 1} \\ \bar{\phi}^{(1)}(\rho) & \text{in region 1*} \\ (-2)^{-d_\phi} \phi^{(2)}(-\rho/2 + \pi i) & \text{in region 2.} \end{cases} \quad (3.2)$$

Therefore, considering the overlapping line $\tau = 0$ and Eq. (3.2), we have the following connection equations on the LPP vertex for the open-closed transition, $\langle u(2, 1^c) |$:

$$\begin{aligned} \langle u(2, 1^c) | \left[\phi^{(1)}(i\sigma) - (-2)^{-d_\phi} \phi^{(2)}(i\pi - i\sigma/2) \right] &= 0, \\ \langle u(2, 1^c) | \left[\bar{\phi}^{(1)}(-i\sigma) - (-2)^{-d_\phi} \phi^{(2)}(i\pi + i\sigma/2) \right] &= 0, \end{aligned} \quad (3.3)$$

for $0 \leq \sigma \leq 2\pi$. Note that the real coordinate $X^\mu(\sigma, \tau)$ at $\tau = 0$ is given by $X^\mu(\sigma, 0) = \frac{1}{2}(X^\mu(i\sigma) + \bar{X}^\mu(-i\sigma))$. So $X^{(1)}(\sigma, 0) = X^{(2)}(\pi - \sigma/2, 0)$ is realized on the vertex $\langle u(2, 1^c) |$ as desired.

The ρ plane for the open intersection interaction V_∞ is a bit more complicated. Prepare the ρ plane first as follows:

$$\rho = \begin{cases} \rho_1 = \tau_1 + i\sigma_1 & \text{for } \tau \leq 0, \quad -\pi \leq \sigma \leq \pi : \text{region 1} \\ -\rho_2 + \pi i = -(\tau_2 + i\sigma_2) + \pi i & \text{for } \tau \geq 0, \quad -\pi \leq \sigma \leq \pi : \text{region 2.} \end{cases} \quad (3.4)$$

Then, as shown in Fig. 3, we make two cuts running from $\sigma = \sigma_1$ to $\sigma = \sigma_2$ and from $\sigma = -\sigma_2$ to $\sigma = -\sigma_1$ at $\tau = 0$. And the left hand side points on the one cut are identified with the right hand side points on the other cut; namely, the point $\sigma \in [\sigma_1, \sigma_2]$ at $\tau = 0$ in the region 1 (2) is identified with the point $\sigma - (\sigma_1 + \sigma_2) \in [-\sigma_2, -\sigma_1]$ in the region 2 (1). With this identification through the cuts, the desired ρ plane is defined, as drawn in Fig. 4. The single holomorphic field on the ρ plane is defined as usual by

$$\phi(\rho) = \begin{cases} \phi^{(1)}(\rho) & \text{in region 1} \\ (-1)^{-d_\phi} \phi^{(2)}(-\rho + \pi i) & \text{in region 2.} \end{cases} \quad (3.5)$$

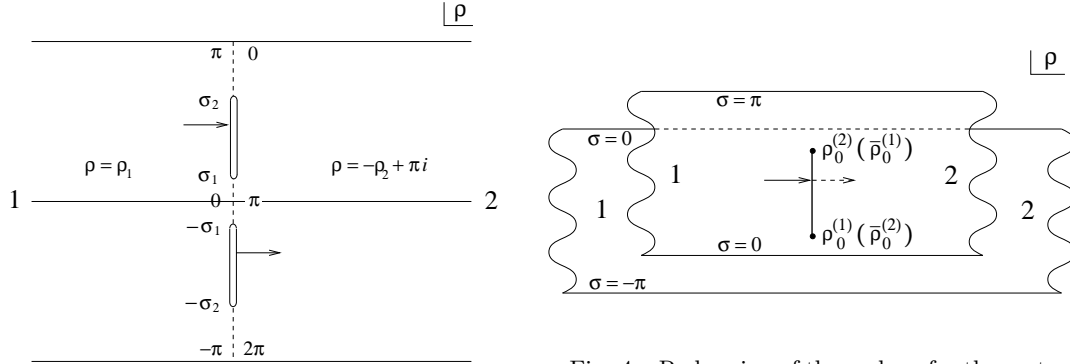

Fig. 3. The ρ plane for open intersection vertex V_∞ .

Fig. 4. Redrawing of the ρ plane for the vertex V_∞ with the cut overlapped. $(\rho_0^{(i)})$ denotes the branch points on the second sheet.

Considering the cut structure of the Riemann surface of ρ and Eq. (3.5), the open intersection vertex, $\langle v_\infty |$, satisfies the following connection condition for $0 \leq \sigma \leq \pi$,

$$\begin{aligned} \langle v_\infty(1, 2) | \left[\phi^{(1)}(i\sigma) - (-1)^{-d_\phi} \phi^{(2)}(i\pi - i\sigma) \right] &= 0 \quad (\sigma \leq \sigma_1, \quad \sigma \geq \sigma_2), \\ \langle v_\infty(1, 2) | \left[\phi^{(1)}(i\sigma) - (-1)^{-d_\phi} \phi^{(2)}(-i\sigma_1 - i\sigma_2 + i\sigma) \right] &= 0 \quad (\sigma_1 \leq \sigma \leq \sigma_2), \end{aligned} \quad (3.6)$$

and, for $-\pi \leq \sigma \leq 0$,

$$\begin{aligned} \langle v_\infty(1, 2) | \left[\phi^{(1)}(i\sigma) - (-1)^{-d_\phi} \phi^{(2)}(-i\pi - i\sigma) \right] &= 0 \quad (\sigma \geq -\sigma_1, \quad \sigma \leq -\sigma_2), \\ \langle v_\infty(1, 2) | \left[\phi^{(1)}(i\sigma) - (-1)^{-d_\phi} \phi^{(2)}(i\sigma_1 + i\sigma_2 + i\sigma) \right] &= 0 \quad (-\sigma_2 \leq \sigma \leq -\sigma_1). \end{aligned} \quad (3.7)$$

These conditions imply that a open string is twisted in the region of $\sigma_1 < |\sigma| < \sigma_2$.

In the case of the closed intersection vertex V_∞ , we first prepare two sheets of ρ planes, one for the holomorphic and another for the anti-holomorphic parts, separately:

first sheet

$$\rho = \begin{cases} \rho_1 = \tau_1 + i\sigma_1 & \text{for } \tau \leq 0, \quad -\pi \leq \sigma \leq \pi : \text{region 1} \\ -\rho_2 = -\tau_2 - i\sigma_2 & \text{for } \tau \geq 0, \quad -\pi \leq \sigma \leq \pi : \text{region 2,} \end{cases}$$

second sheet

$$\rho = \begin{cases} \bar{\rho}_1 = \tau_1 - i\sigma_1 & \text{for } \tau \leq 0, \quad -\pi \leq \sigma \leq \pi : \text{region 1}^* \\ -\bar{\rho}_2 = -\tau_2 + i\sigma_2 & \text{for } \tau \geq 0, \quad -\pi \leq \sigma \leq \pi : \text{region 2}^*. \end{cases} \quad (3.8)$$

Then, again two cuts are placed from $\sigma = -\sigma_0$ to $\sigma = +\sigma_0$ at $\tau = 0$ on the first sheet and on the second as shown in Fig. 5, and again the left hand side points on the one cut are identified with the right hand side points on the other cut. The resulting ρ plane is drawn in Fig. 6. The holomorphic fields are defined by

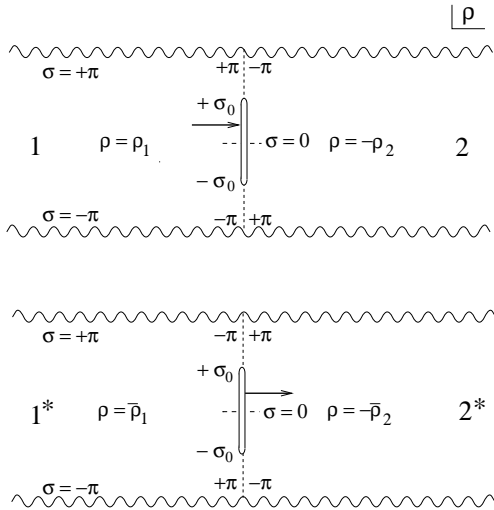

Fig. 5. Two sheets of ρ planes for vertex V_∞ .

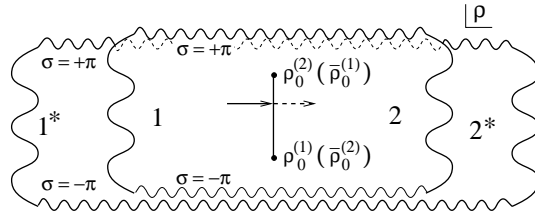

Fig. 6. The ρ plane for the closed intersection vertex V_∞ drawn in such a way that the cut is overlapped. Again $(\rho_0^{(i)})$ denotes the coordinates of the branch points on the second sheet.

$$\phi(\rho) = \begin{cases} \phi^{(1)}(\rho) & \text{in region 1} \\ \bar{\phi}^{(1)}(\rho) & \text{in region 1}^* \\ (-1)^{-d_\phi} \phi^{(2)}(-\rho) & \text{in region 2} \\ (-1)^{-d_\phi} \bar{\phi}^{(2)}(-\rho) & \text{in region 2}^*. \end{cases} \quad (3.9)$$

As in the above case, we obtain the connection equations on the closed intersection vertex $\langle v_\infty |$,

$$\begin{cases} \langle v_\infty(1, 2) | \left[\phi^{(1)}(i\sigma) - (-1)^{-d_\phi} \phi^{(2)}(-i\sigma) \right] = 0 \\ \langle v_\infty(1, 2) | \left[\bar{\phi}^{(1)}(-i\sigma) - (-1)^{-d_\phi} \bar{\phi}^{(2)}(+i\sigma) \right] = 0 \end{cases} \quad (|\sigma| \geq \sigma_0),$$

$$\begin{cases} \langle v_\infty(1, 2) | \left[\phi^{(1)}(i\sigma) - (-1)^{-d_\phi} \bar{\phi}^{(2)}(-i\sigma) \right] = 0 \\ \langle v_\infty(1, 2) | \left[\bar{\phi}^{(1)}(-i\sigma) - (-1)^{-d_\phi} \phi^{(2)}(i\sigma) \right] = 0 \end{cases} \quad (|\sigma| \leq \sigma_0), \quad (3.10)$$

which implies that twisting of a closed string is made in the region $|\sigma| < \sigma_0$.

With these conditions of gluing, the corresponding LPP vertices are uniquely specified including their normalization, and they satisfy the following BRS invariance:¹⁶⁾

$$\begin{aligned} \langle u(1, 1^c) | (Q_B^{(1)} + Q_B^{(1^c)}) &= 0, \\ \langle v_\infty(1, 2) | (Q_B^{(1)} + Q_B^{(2)}) &= 0, \\ \langle v_\infty(1^c, 2^c) | (Q_B^{(1^c)} + Q_B^{(2^c)}) &= 0. \end{aligned} \quad (3.11)$$

But they still do not give the final form of the desired vertices which reproduce the correct Polyakov amplitudes: firstly, for each closed string, we should multiply the projection operator \mathcal{P} , which projects only the $L_0 - \bar{L}_0 = 0$ modes out,

$$\mathcal{P} \equiv \int_0^{2\pi} \frac{d\theta}{2\pi} \exp i\theta(L_0 - \bar{L}_0), \quad (3.12)$$

and the corresponding antighost zero-mode factor $b_0^- = (b_0 - \bar{b}_0)/2$. Secondly, since the intersection vertices have moduli parameters σ_0, σ_1 and σ_2 , we must insert antighost factors associated with the quasi-conformal deformations of the Riemann surface corresponding to the changes of those moduli parameters.²⁵⁾ Finally, unoriented projection operators Π have to be multiplied:

$$\Pi = \frac{1}{2}(1 + \Omega), \quad (3.13)$$

where Ω denotes a twist operator:

$$\Omega\phi(\rho)\Omega^{-1} = \begin{cases} \phi(i\pi + \bar{\rho}) & \text{for open string} \\ \bar{\phi}(\bar{\rho}) & \text{for closed string.} \end{cases} \quad (3.14)$$

Let us understand that, for open string case, the twist operator Ω in Eq. (3.13) also implies to taking the transposition of the matrix index, so that the operator Π projects out the unoriented $O(n)$ type open string field satisfying $|\Psi\rangle^T = \Omega|\Psi\rangle$. As a result, we obtain the final forms of vertices for those three types of interactions:

1. open-closed transition vertex

$$\langle U(1, 2^c) | = \langle u(1, 2^c) | b_0^{-(2^c)} \mathcal{P}^{(2^c)} \prod_{r=1, 2^c} II^{(r)}, \quad (3.15)$$

2. open intersection vertex

$$\langle V_\infty(1, 2) | = \int_{0 \leq \sigma_1 \leq \sigma_2 \leq \pi} d\sigma_1 d\sigma_2 \langle v_\infty(1, 2; \sigma_1, \sigma_2) | b_{\sigma_1} b_{\sigma_2} \prod_{r=1, 2} II^{(r)}, \quad (3.16)$$

3. closed intersection vertex

$$\langle V_\infty(1^c, 2^c) | = \int_0^{\frac{\pi}{2}} d\sigma_0 \langle v_\infty(1^c, 2^c; \sigma_0) | b_{\sigma_0} \prod_{r=1^c, 2^c} b_0^{-(r)} \mathcal{P}^{(r)} II^{(r)}. \quad (3.17)$$

Note that the product of unoriented projections $\prod_r II^{(r)}$ in these three vertices may be replaced by a single II of either one of the two strings since the two II 's are the same on these vertices. As for the matrix index property, the vertex $\langle U(1, 2^c) |$ is proportional to the unit matrix $\mathbf{1}_{ij}$ for the matrix index i, j of the open string 1, and the vertex $\langle V_\infty(1, 2) |$ is proportional to $\delta(i_1, j_1; i_2, j_2) \equiv \delta_{i_1, j_2} \delta_{i_2, j_1}$ just like the open reflector. As a convention here and henceforth, the order of the ghost factors $b_0^{-(r)}$ in $\prod_{r=1^c, 2^c} b_0^{-(r)}$ is defined as the same as that appearing in the arguments of the vertex $\langle v_\infty(1^c, 2^c; \sigma_0) |$; so here $\prod_{r=1^c, 2^c} b_0^{-(r)} = b_0^{-(1^c)} b_0^{-(2^c)}$.

b_{σ_j} ($j = 0, 1, 2$) are the anti-ghost factors for the quasi-conformal deformations corresponding to the change of the moduli parameters σ_j . They are given by ^{25), 26), 27)}

$$\begin{aligned} b_{\sigma_j} &= \left(\frac{d\rho_0^{(j)}}{d\sigma_j} \right) b_{\rho_0^{(j)}}, \quad \text{for } j = 1, 2, \\ b_{\sigma_0} &= \left(\frac{d\rho_0^{(1)}}{d\sigma_0} \right) b_{\rho_0^{(1)}} + \left(\frac{d\rho_0^{(2)}}{d\sigma_0} \right) b_{\rho_0^{(2)}}, \\ b_{\rho_0^{(j)}} &= \oint_{C_j} \frac{d\rho}{2\pi i} b(\rho), \quad \text{for } j = 1, 2, \end{aligned} \quad (3.18)$$

where the contour C_j is a closed path depicted in Fig. 7 which goes around the interaction point $\rho_0^{(j)}$ on the first sheet and then around $\bar{\rho}_0^{(j)}$ on the second sheet of the ρ planes in Figs. 4 and 6.

A comment may be in order on the integration region for σ_0 in the closed intersection vertex V_∞ . At first sight it seems that the moduli parameter σ_0 should be integrated from 0 to π . However, since the configuration with $\pi/2 \leq \sigma_0 \leq \pi$ becomes the same as that with

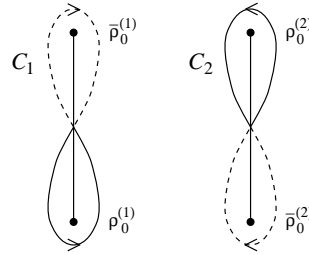

Fig. 7. The contours C_j in Eq. (3.18).

$0 \leq \sigma_0 \leq \pi/2$ if the twist operator Ω is acted on either one of the two strings 1 or 2, we have an identity for the LPP vertex:

$$\langle v_\infty(1^c, 2^c; \pi - \sigma_0) | \Omega^{(2)} \prod_{r=1^c, 2^c} \mathcal{P}^{(r)} = - \langle v_\infty(1^c, 2^c; \sigma_0) | \prod_{r=1^c, 2^c} \mathcal{P}^{(r)} \quad (0 \leq \sigma_0 \leq \pi/2). \quad (3.19)$$

But there is an unoriented projection Π acting on the vertex and $\Omega\Pi = \Pi$, the contribution of the configurations with $\pi/2 \leq \sigma_0 \leq \pi$ is actually the same as that with $\pi/2 \leq \sigma_0 \leq \pi$ in our final vertex. So we have restricted the integration region to $0 \leq \sigma_0 \leq \pi/2$ to correctly cover the moduli space only once. [The minus sign in Eq. (3.19) is important here and later. It should appear here since otherwise the integral $\int d\sigma_0 \langle v_\infty(1^c, 2^c; \sigma_0) | b_{\sigma_0}$, if extended over $0 \leq \sigma_0 \leq \pi$, would vanish because of the fact $b_{\sigma_0} = (d\rho_0/d\sigma_0)b_{\rho_0} = -b_{\pi-\sigma_0}$. More directly, as we shall see below, the LPP vertex $\langle v_\infty(1^c, 2^c; \sigma_0) |$ contains two ghost factors at the two interaction points $\sigma = \pi \pm \sigma_0$ if rewritten in terms of the HIKKO representation. The multiplication order of these two is opposite between the two configurations with σ_0 and $\pi - \sigma_0$, which yields the minus sign in Eq. (3.19).]

§4. Action

We shall see later that there appears a divergence owing to the tachyon at order g^2 and it is canceled by the shift of the zero intercept parameter in L_0 . Taking this into account in advance, we define here tilded (or, ‘bare’) BRS charges by shifting the zero intercept parameters in the usual (‘renormalized’) BRS charges Q_B^o and Q_B^c for open and closed strings, respectively, as follows:

$$\begin{aligned} \tilde{Q}_B^o &= Q_B^o + \lambda_o g^2 c_0, \\ \tilde{Q}_B^c &= Q_B^c + \lambda_c g^2 c_0^+, \end{aligned} \quad (4.1)$$

where $\lambda_o g^2$ and $\lambda_c g^2$ are the amounts of the zero intercept shift for open and closed strings, respectively, which will be determined later by the gauge invariance requirement.

We can now give the more precise form for the action Eq. (1.1) and the gauge transformation Eq. (1.2) using the bra-ket notation:

$$\begin{aligned} S &= -\frac{1}{2} \langle R^o(2, 1) | |\Psi\rangle_1 \tilde{Q}_B^{(2)} \Pi^{(2)} |\Psi\rangle_2 - \frac{1}{2} \langle R^c(2, 1) | |\Phi\rangle_1 \tilde{Q}_B^{(2)} b_0^{-(2)} (b_0^- \mathcal{P}\Pi)^{(2)} \\ &\quad + x_u g \langle U(2, 1) | |\Phi\rangle_1 |\Psi\rangle_2 + x_\infty \frac{1}{2} g^2 \langle V_\infty(2, 1) | |\Psi\rangle_1 |\Psi\rangle_2 \\ &\quad + x_\infty \frac{1}{2} g^2 \langle V_\infty(2, 1) | |\Phi\rangle_1 |\Phi\rangle_2, \end{aligned} \quad (4.2)$$

$$\begin{aligned} \delta (b_0^{-(1)} |\Phi\rangle_1) &= -\tilde{Q}_B^{(1)} (b_0^- \mathcal{P}\Pi)^{(1)} |A^c\rangle_1 + x_\infty g^2 \langle V_\infty(3, 2) | |R^c(1, 2)\rangle |A^c\rangle_3, \\ \delta |\Psi\rangle_1 &= x_u g \langle U(2, 1^c) | |R^o(1, 2)\rangle |A^c\rangle_{1^c}. \end{aligned} \quad (4.3)$$

where $(b_0^- \mathcal{P}\Pi)^{(r)}$ is a shorthand notation for $b_0^{-(r)} \mathcal{P}^{(r)} \Pi^{(r)}$. Since the gauge transformation δ is the usual derivation, the gauge transformation parameter $|A^c\rangle$ is Grass-

mann even. The change of the action under this gauge transformation is given by

$$\begin{aligned}
\delta S &= \delta S_1 + \delta S_2 + \delta S_3 + \delta S_4, \\
\delta S_1 &= x_u g \langle U(1, 1^c) | (\tilde{Q}_B^{(1)} + \tilde{Q}_B^{(1^c)}) | \Psi \rangle_1 | A^c \rangle_{1^c} \\
\delta S_2 &= +g^2 \left[x_u^2 \langle U(1, 1^c) | \langle U(2, 2^c) | | R^o(1, 2) \rangle \right. \\
&\quad - x_\infty \langle V_\infty(2^c, 1^c) | (\tilde{Q}_B^{(1^c)} + \tilde{Q}_B^{(2^c)}) \\
&\quad \left. + \lambda_c \langle R^c(2^c, 1^c) | \{ Q_B^{(1^c)}, c_0^{+(1^c)} \} b_0^{-(1^c)} \right] | \Phi \rangle_{1^c} | A^c \rangle_{2^c} \\
\delta S_3 &= +x_u g^3 \left[-x_\infty \langle \check{U}(1, 2^c) | \langle V_\infty(3^c, 1^c) | | R^c(2^c, 3^c) \rangle \right. \\
&\quad \left. + x_\infty \langle V_\infty(1, 2) | \langle U(3, 1^c) | | R^o(2, 3) \rangle \right] | \Psi \rangle_1 | A^c \rangle_{1^c} \\
\delta S_4 &= -x_\infty^2 g^4 \langle \check{V}_\infty(1^c, 3^c) | \langle V_\infty(4^c, 2^c) | | R^c(3^c, 4^c) \rangle | \Phi \rangle_{1^c} | A^c \rangle_{2^c}. \quad (4.4)
\end{aligned}$$

Here the checked vertices $\langle \check{U} |$ and $\langle \check{V}_\infty |$ are those with a factor b_0^- removed:

$$\langle U(1, 2^c) | = \langle \check{U}(1, 2^c) | b_0^{-(2^c)}, \quad \langle V_\infty(1, 2) | = \langle \check{V}_\infty(1, 2) | b_0^{-(2)}. \quad (4.5)$$

In this calculation, it is useful to remember the symmetry properties $\langle V_\infty(1, 2) | = \langle V_\infty(2, 1) |$ and $\langle V_\infty(1, 2) | = -\langle V_\infty(2, 1) |$, and also the following Grassmann even-odd properties of the vertices: the open-closed transition vertex $\langle U |$ and open reflector $\langle R^o |$ are *odd* and all the others $\langle R^c |$, $\langle V_\infty |$, $\langle V_\infty |$ are even. These properties can easily be seen from the form of each term in the action (which is even, of course) and the fact that $|\Psi\rangle$ is even and $|\Phi\rangle$ odd.

§5. Gauge invariance

In this section, we show that the parameters $\lambda_c, \lambda_o, x_u, x_\infty$ and x_∞ in the action (4.2) should satisfy

$$\begin{aligned}
\lambda_c &= 2\lambda_o = -\lim_{a \rightarrow \infty} \frac{2n x_u^2}{a^2}, \\
x_\infty &= n x_u^2, \\
x_\infty &= -4\pi i x_\infty, \quad (5.1)
\end{aligned}$$

in order for the theory to be gauge invariant. To show this, let us now examine each term in Eq. (4.4) order by order.

5.1. Order g invariance

It follows from the definition of the LPP vertex that

$$\langle U(1, 1^c) | (Q_B^{(1)} + Q_B^{(1^c)}) = 0, \quad (5.2)$$

which has been proven first in Ref. (28), (29). This finishes the proof of order g invariance. But the first term δS_1 in Eq. (4.4) contains also the order g^3 terms coming from the shift of the zero intercept parameter. They have to cancel out by

themselves since no other counterparts appear to cancel them. So we here consider the condition for them to cancel, although they are of order g^3 .

From the connection equation Eq. (3.3) for $\phi = c$, we have

$$\begin{aligned}\langle U(1, 1^c) | \left[c^{(1^c)}(\sigma) + 2c^{(1)}\left(\pi - \frac{\sigma}{2}\right) \right] &= 0, \\ \langle U(1, 1^c) | \left[\bar{c}^{(1^c)}(-\sigma) + 2c^{(1)}\left(\pi + \frac{\sigma}{2}\right) \right] &= 0.\end{aligned}\quad (5.3)$$

Summing these two and performing integration $\int_0^{2\pi} d\sigma/2\pi$, we find

$$\langle U(1, 1^c) | \left[c_0^{(1^c)} + \bar{c}_0^{(1^c)} + 4c_0^{(1)} \right] = \langle U(1, 1^c) | 2 \left[c_0^{+(1^c)} + 2c_0^{(1)} \right] = 0 \quad (5.4)$$

Therefore, if we take

$$\lambda_c = 2\lambda_o, \quad (5.5)$$

it follows that

$$\langle U(1, 1^c) | (\tilde{Q}_B^{(1)} + \tilde{Q}_B^{(1^c)}) = 0. \quad (5.6)$$

The requirement (5.5) is natural since the zeroth order zero intercepts α_0^o and α_0^c for open and closed strings also satisfy the relation $\alpha_0^c = 2\alpha_0^o = 2$. Hereafter, we accept the relation of Eq. (5.5) and then the ‘order g ’ gauge invariance $\delta S_1 = 0$ is realized.

5.2. Order g^2 invariance

In the order g^2 terms δS_2 in Eq. (4.4), the first UU and the second V_∞ terms are divergent for these correspond to singular configurations in moduli space, so that we need regularization for their evaluation. First, we rewrite the first terms as follows,

$$\begin{aligned}\langle U(1, 1^c) | \langle U(2, 2^c) | |R^o(1, 2)\rangle &= \lim_{T \rightarrow 0} \langle u(1, 1^c) | \langle u(2, 2^c) | e^{-(1/2)L_0^{(2)}T} | R^o(1, 2)\rangle \\ &\times e^{+(L^{(1)}+L^{(2)})T/2} \prod_{r=1^c, 2^c} (b_0^- \mathcal{P}\Pi)^{(r)},\end{aligned}\quad (5.7)$$

where $L \equiv L_0 + \bar{L}_0$ for closed string. Here the unoriented projection operators for the intermediate open strings 1 and 2 have been dropped since $\langle u(1, 1^c) | \Pi^{(1)} \mathcal{P}^{(1^c)} = \langle u(1, 1^c) | \Pi^{(1^c)} \mathcal{P}^{(1^c)}$. T is introduced as a regularization parameter and has the meaning of propagation time of the intermediate open string. The factor $1/2$ in $e^{-(1/2)L_0^{(2)}T}$ is the factor $1/\alpha_2$ of the string length parameter $\alpha_2 = 2$ for the intermediate open string 2. We can replace the operator $e^{-(1/2)L_0^{(2)}T}$ by a more symmetric one $e^{-(L_0^{(1)}+L_0^{(2)})T/4}$ if necessary since $L_0^{(1)} = L_0^{(2)}$ in front of the reflector $|R^o(1, 2)\rangle$. Note that we also have added the operator $e^{+(L^{(1)}+L^{(2)})T/2}$: this is because it almost cancels $e^{-(1/2)L_0^{(2)}T} = e^{-(L_0^{(1)}+L_0^{(2)})T/4}$ even for finite T since the energy momentum tensor $T(\rho)$ is continuous on the vertices $\langle u(r, r^c) |$ aside from the interaction point, although the right hand side in Eq. (5.7), in any case, reduces to the left hand side as $T \rightarrow 0$, formally. The part $\langle u(1, 1^c) | \langle u(2, 2^c) | e^{-(1/2)L_0^{(2)}T} | R^o(1, 2)\rangle$ can be evaluated

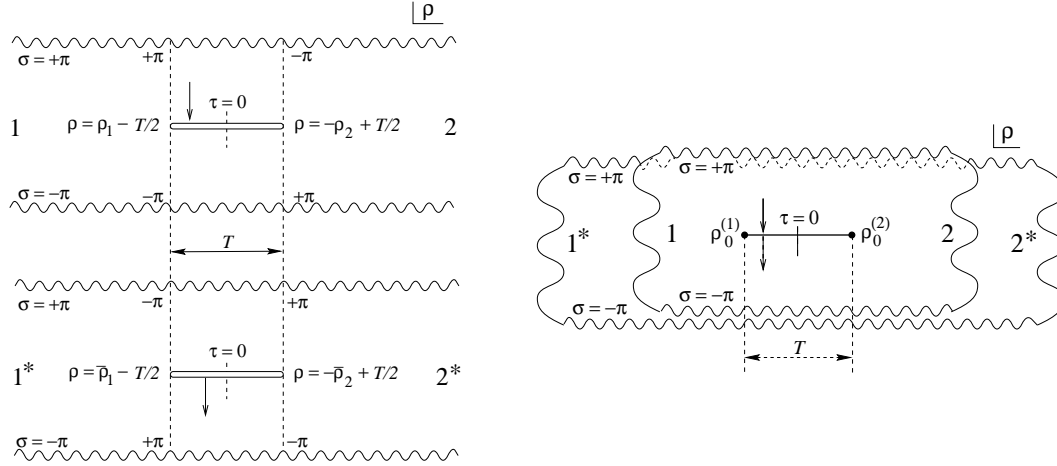
Fig. 8. The ρ plane for the vertex $\langle v_{D_2} |$.

according to the LPP's "Generalized gluing and resmoothing" (GGR) theorem,¹⁶⁾ and so we obtain

$$\begin{aligned} & \langle U(1, 1^c) | \langle U(2, 2^c) | | R^0(1, 2) \rangle \\ &= n \lim_{T \rightarrow 0} \langle v_{D_2}(1^c, 2^c; T) | e^{+(L^{(1^c)} + L^{(2^c)})T/2} \prod_{r=1^c, 2^c} (b_0^- \mathcal{P} \Pi)^{(r)}, \end{aligned} \quad (5.8)$$

where $\langle v_{D_2}(T) |$ is the LPP vertex, which we call D2 vertex, corresponding to the ρ plane represented in Fig. 8, and the factor n came from the trace of Chan-Paton factor of the intermediate open string.

The second term in the order g^2 terms δS_2 in Eq. (4.4) is rewritten as

$$\begin{aligned} \langle V_\infty(1^c, 2^c) | (\tilde{Q}_B^{(1^c)} + \tilde{Q}_B^{(2^c)}) &= \int_0^{\pi/2} d\sigma_0 \langle v_\infty(1^c, 2^c; \sigma_0) | \{Q_B, b_{\sigma_0}\} \prod_{r=1^c, 2^c} (b_0^- \mathcal{P} \Pi)^{(r)} \\ &+ \lambda_c \int_0^{\pi/2} d\sigma_0 \langle v_\infty(1^c, 2^c; \sigma_0) | b_{\sigma_0} (c_0^{+(1^c)} + c_0^{+(2^c)}) \prod_{r=1^c, 2^c} (b_0^- \mathcal{P} \Pi)^{(r)}. \end{aligned} \quad (5.9)$$

We now use the identity,^{25), 30), 27)}

$$\begin{aligned} \langle v_\infty(1^c, 2^c; \sigma_0) | \{Q_B, b_{\sigma_0}\} &= \langle v_\infty(1^c, 2^c; \sigma_0) | T_{\sigma_0} \\ &= \frac{d}{d\sigma_0} \left\{ \langle v_\infty(1^c, 2^c; \sigma_0) | \right\}, \end{aligned} \quad (5.10)$$

which follows from the fact that

$$T_{\sigma_0} = \{Q_B, b_{\sigma_0}\} = \left[\left(\frac{d\rho_0^{(1)}}{d\sigma_0} \right) \oint_{C_1} + \left(\frac{d\rho_0^{(2)}}{d\sigma_0} \right) \oint_{C_2} \right] \frac{d\rho}{2\pi i} T(\rho), \quad (5.11)$$

is the generator for the change of the moduli parameter σ_0 (since, generally, the contour integration of energy momentum tensor $\oint_{C_Z} (dz/2\pi i) T(z)$ along a closed

path C_Z encircling the point Z is known²⁶⁾ to give a generator for $\partial/\partial Z$. Then, the integral over σ_0 in the first term leaves only the surface terms:

$$\begin{aligned} \langle V_\infty(1^c, 2^c) | (\tilde{Q}_B^{(1^c)} + \tilde{Q}_B^{(2^c)}) \rangle &= - \lim_{\sigma_0 \rightarrow 0} \langle v_\infty(1^c, 2^c; \sigma_0) | \prod_{r=1^c, 2^c} (b_0^- \mathcal{P}II)^{(r)} \\ &+ \lambda_c \int_0^{\frac{\pi}{2}} d\sigma_0 \langle v_\infty(1^c, 2^c; \sigma_0) | b_{\rho_0}(c_0^{+(1^c)} + c_0^{+(2^c)}) \prod_{r=1^c, 2^c} (b_0^- \mathcal{P}II)^{(r)} \rangle, \end{aligned} \quad (5.12)$$

where the surface term at the other end point $\sigma_0 = \pi/2$ has dropped out since it vanishes by itself owing to the identity Eq. (3.19). We call this vertex $\langle v_\infty(\sigma_0) | P2$ vertex for short.

The quantities Eq. (5.8) for D2 vertex and the first term of Eq. (5.12) for P2 vertex correspond to a common configuration as depicted in the Fig. 9 in the limit $T, \sigma_0 \rightarrow 0$, and so have the well-known singularities owing to the tachyon and dilaton contributions. We want to evaluate this singularity in Eqs. (5.8) and (5.12) explicitly. For that purpose, it is convenient to map the ρ plane to the whole complex z plane. This map is constructed as follows: first, consider the former D2 case, corresponding to the diagram Fig. 8 with open string propagating as an intermediate state. By the usual Mandelstam mapping,

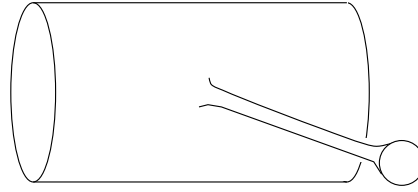

Fig. 9. The configuration yielding the singularities in the D2 and P2 vertices.

$$\rho = \ln(2 - \zeta) - \ln(\zeta + 2), \quad (5.13)$$

we can first map the ρ plane of Fig. 8 to the Riemann surface, ζ plane. The cut between $\rho_0^{(1)} = -T/2$ and $\rho_0^{(2)} = T/2$ on the ρ plane, which corresponds to the open string boundary, is mapped to the cut between $\zeta = -2a$ and $\zeta = 2a$ on ζ plane:

$$\frac{T}{2} = \ln \frac{1+a}{1-a} \Rightarrow a = \tanh \frac{T}{4}. \quad (5.14)$$

So a is a real positive number in $0 \leq a \leq 1$, corresponding the moduli $0 \leq T \leq \infty$. This ζ plane, having two sheets as ρ plane, is then mapped to the whole complex z plane by the Joukowski transformation:

$$\zeta = z + \frac{a^2}{z}. \quad (5.15)$$

The correspondence between the each string domain of the ρ plane and the z plane is represented in Fig. 10. Note that the z plane is now of a single sheet. The first sheet of ρ (or ζ) plane is mapped to the outer region of the circle with radius $|z| = a$ and the second sheet to the inner region. If z is a root of Eq. (5.15) for a given ζ (or ρ), so is a^2/z . When a point ρ on the first sheet is mapped to z in the outer region, $|z| \geq a$, $\bar{\rho}$ on the second sheet corresponds to a^2/\bar{z} in the inner region. Therefore, in

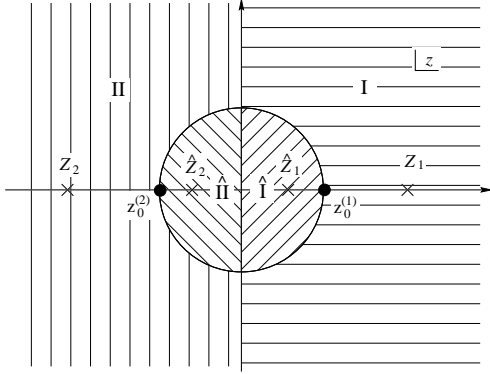

Fig. 10. The z plane of the D2 vertex. Regions I and II (\hat{I} and \hat{II}) correspond to the $\tau < 0$ and $\tau > 0$ regions on the first (second) sheet of the ρ plane in Fig. 8, respectively.

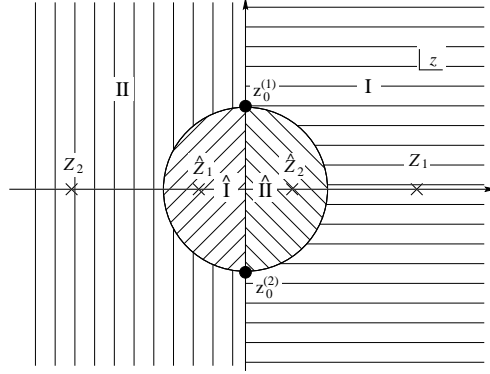

Fig. 11. The z plane of the P2 vertex. Regions I and II (\hat{I} and \hat{II}) correspond to the regions 1 and 2 (1^* and 2^*) on the first (second) sheet of the ρ plane in Fig. 6.

particular, we have the following correspondence for the real string coordinate:

$$X^{\mu(1)}(\sigma_1, \tau_1) = \frac{1}{2} \left(X^{\mu(1)}(\rho) + \bar{X}^{\mu(1)}(\bar{\rho}) \right) \Leftrightarrow \frac{1}{2} \left(X^\mu(z) + X^\mu\left(\frac{a^2}{\bar{z}}\right) \right). \quad (5.16)$$

Consider next the ρ plane of Fig. 6, for the P2 vertex V_∞ . We should notice that this plane differs from the previous ρ plane of Fig. 8, only by the cut structure which in this case corresponds to a cross cap instead of an open string boundary, and it is well-known that the mapping ρ to z in this case is given by the same one as above simply by changing the moduli from real a to imaginary ia . The resultant z plane is depicted in Fig. 11.

Therefore the evaluation of Eq. (5.8) and the first term of Eq. (5.12) can be carried out in a unified manner. The ρ planes are mapped to the z planes by the mapping

$$\rho = \ln \left(2 - \left(z + \frac{q^2}{z} \right) \right) - \ln \left(z + \frac{q^2}{z} + 2 \right), \quad (5.17)$$

with real $q = a$ or imaginary $q = ia$ for D2 and P2 vertex cases, respectively. It is important for later consideration that on the z plane in Fig. 10 or in 11, only one complex z plane is needed for our analysis, and all of the insertion points of strings are on the real axis, the situation which is very similar to purely open strings system.

The interaction points are given by

$$\frac{d\rho}{dz} = 0 \quad \Rightarrow \quad z_0^{(1)} = +q, \quad z_0^{(2)} = -q. \quad (5.18)$$

The point corresponding to the insertion of string fields are given by

$$Z_1 = 1 + \sqrt{1 - q^2}, \quad \hat{Z}_1 = 1 - \sqrt{1 - q^2}, \quad (5.19)$$

$$Z_2 = -1 - \sqrt{1 - q^2}, \quad \hat{Z}_2 = -1 + \sqrt{1 - q^2}. \quad (5.20)$$

To discuss the singularity of the D2 and P2 vertices, it is convenient to use the HIKKO's OSP symmetric expression for the vertex. In the Appendix A, we show the following expression for the LPP vertex a la HIKKO:

$$\langle v(1^c, 2^c; q) | = N(q) {}_2c\langle \tilde{1}, \tilde{1} | {}_1c\langle \tilde{1}, \tilde{1} | \left(\sum_r \frac{b_0^{(r)}}{\alpha_r} \right) \exp(E_H(1^c, 2^c)) c(\rho_0^{(1)}) c(\rho_0^{(2)}). \quad (5.21)$$

where the normalization factor $N(q)$ is given explicitly in Eq. (A.31) and the exponent E_H is the HIKKO's OSP invariant quadratic operator given by^{18), 19)}

$$E_H = \sum_{\substack{m, n \geq 0 \\ r, s = 1, \bar{1}, 2, \bar{2}}} \bar{N}_{mn}^{rs} \left(\frac{1}{2} \alpha_m^\mu{}^{(r)} \eta_{\mu\nu} \alpha_n^\nu{}^{(s)} + i \gamma_m{}^{(r)} \beta_n{}^{(s)} \right) \equiv \sum \bar{N}_{mn}^{rs} \frac{1}{2} a_m^{(r)} \cdot a_n^{(s)},$$

$$\gamma_n{}^{(r)} = i n \alpha_r c_n{}^{(r)}, \quad \beta_n{}^{(r)} = b_n{}^{(r)} / \alpha_r, \quad (5.22)$$

with the Fourier coefficients \bar{N}_{mn}^{rs} of the Neumann function for the X^μ operators. Here we have used the following notation for OSp($d, 2|2$) vector and invariant metric:

$$a_m^M = (\alpha_m^\mu, \gamma_m, \beta_m),$$

$$a \cdot b = a^M \eta_{MN} b^N, \quad \eta_{MN} = \begin{pmatrix} \eta_{\mu\nu} & & \\ & 0 & i \\ & -i & 0 \end{pmatrix}. \quad (5.23)$$

From Eqs. (5.17) and (5.18), we see that the two interaction points $\rho_0^{(1,2)}$ on the ρ plane are related with the parameter q as

$$\rho_0^{(2)} = -\rho_0^{(1)} = \ln \left(\frac{1+q}{1-q} \right). \quad (5.24)$$

$\rho_0^{(r)}$ is real if $q = a$ and purely imaginary if $q = ia$. For real $q = a$ (D2 vertex), the interaction points $\rho_0^{(1,2)}$ are on the open string boundary as in Fig. 8, so that the holomorphic and anti-holomorphic parts are equal to each other. Then we find

$$c(\rho_0^{(1)}) = c^{(1)}(\rho_0^{(1)} - T/2) = \frac{1}{2} \left(c^{(1)}(0) + \bar{c}^{(1)}(0) \right) = C^{(1)}(0),$$

$$c(\rho_0^{(2)}) = -c^{(2)}(-\rho_0^{(2)} + T/2) = -\frac{1}{2} \left(c^{(2)}(0) + \bar{c}^{(2)}(0) \right) = -C^{(2)}(0), \quad (5.25)$$

where we have defined

$$C(\rho) \equiv \frac{1}{2} \left(c(\rho) + \bar{c}(\rho) \right). \quad (5.26)$$

(Note that the argument of \bar{c} is not $\bar{\rho}$ but ρ here.) If $q = ia$ (imaginary), on the other hand, from the connection condition of Eq. (3.9), we have $c^{(1)}(i\sigma) = -\bar{c}^{(2)}(-i\sigma) = +\bar{c}^{(1)}(i\sigma)$ at both interaction points $i\sigma = \rho_0^{(1)} = -i\sigma_0$ and $i\sigma = \rho_0^{(2)} = +i\sigma_0$, so that

$$c(\rho_0^{(1)}) = \frac{1}{2} \left(c^{(1)}(-i\sigma_0) + \bar{c}^{(1)}(-i\sigma_0) \right) = C^{(1)}(\rho_0^{(1)}),$$

$$c(\rho_0^{(2)}) = -\frac{1}{2} \left(c^{(2)}(-i\sigma_0) + \bar{c}^{(2)}(-i\sigma_0) \right) = -C^{(2)}(\rho_0^{(1)}). \quad (5.27)$$

These ghost factors Eqs. (5·25) and Eq. (5·27) for D2 and P2 cases, respectively, look very different. We, however, note that, for the former D2 case, what should be evaluated is not the LPP vertex $\langle v_{D_2}(1^c, 2^c; T) |$ itself but that multiplied by the operator $e^{+(L^{(1^c)}+L^{(2^c)})T/2}$, as seen in Eq. (5·8). So, using Eqs. (5·21) and (5·25), we have

$$\begin{aligned} & \langle v(1^c, 2^c; q = a) | e^{+(L^{(1^c)}+L^{(2^c)})T/2} \\ & = N(q) {}_2c\langle \tilde{1}, \tilde{1} | {}_1c\langle \tilde{1}, \tilde{1} | \left(\sum_r \frac{b_0^{(r)}}{\alpha_r} \right) \exp(\hat{E}_H(1^c, 2^c)) \left(-\hat{C}^{(1)}(0)\hat{C}^{(2)}(0) \right), \end{aligned} \quad (5\cdot28)$$

with hatted operators denoting $\hat{\mathcal{O}} = e^{-(L^{(1^c)}+L^{(2^c)})T/2} \mathcal{O} e^{+(L^{(1^c)}+L^{(2^c)})T/2}$. This hat operation is equivalent to replacing all the oscillators by

$$(\hat{\alpha}_n^\mu, \hat{c}_n, \hat{b}_n) = (e^{nT/2} \alpha_n^\mu, e^{nT/2} c_n, e^{nT/2} b_n). \quad (5\cdot29)$$

So, now the ghost factors become

$$-\hat{C}^{(1)}(0)\hat{C}^{(2)}(0) = -C^{(1)}(-T/2)C^{(2)}(-T/2) = -C^{(1)}(\rho_0^{(1)})C^{(2)}(\rho_0^{(1)}), \quad (5\cdot30)$$

since $\rho_0^{(1)} = -T/2$ in this D2 case. Therefore the ghost factor $c(\rho_0^{(1)})c(\rho_0^{(2)})$ in Eq. (5·21) can now be written as $-C^{(1)}(\rho_0^{(1)})C^{(2)}(\rho_0^{(1)})$ commonly for the D2 and P2 cases.

The exponent $\hat{E}_H(1^c, 2^c)$ for D2 case is given by the same expression as $E_H(1^c, 2^c)$ in Eq. (5·22) with the replacement Eq. (5·29) done for all the oscillators, while no such is done for the P2 case. But we shall see shortly that this also helps to make the expressions common for both cases.

Since we want to know the singular structure of the LPP vertex in the limit $T, \sigma_0 \rightarrow 0$, we have only to know the behavior of the exponent E_H around $q \sim 0$, which is written in terms of the Neumann coefficients \bar{N}_{mn}^{rs} . We can do this task by expanding the Neumann function directly. The Neumann function on the z plane is given by^{*)}

$$\begin{aligned} N(z, z') &= \ln |z - z'| + \ln \left| 1 - \frac{q^2}{z\bar{z}'} \right| \\ &= \ln |z - z'| - \ln |z - \bar{z}'| + \ln \left| z + \frac{q^2}{z} - \bar{z}' - \frac{q^2}{\bar{z}'} \right|. \end{aligned} \quad (5\cdot32)$$

^{*)} This Neumann function is for the real coordinate $X^\mu = \frac{1}{2}(X^\mu(\rho) + \bar{X}^\mu(\bar{\rho}))$. The 2-point function for the holomorphic coordinate $X^\mu(z)$ is of course given by $\langle X^\mu(z) X^\nu(z') \rangle = -\eta^{\mu\nu} \ln(z - z')$. If we note the relation Eq. (5·16), we can derive the Neumann function $N(z, z')$ in Eq. (5·32) as follows: omitting the indices μ, ν , we have

$$\begin{aligned} - \left\langle \left(X(z) + X\left(\frac{q^2}{\bar{z}}\right) \right) \left(X(z') + X\left(\frac{q^2}{\bar{z}'}\right) \right) \right\rangle &= \ln(z - z') + \ln\left(z - \frac{q^2}{\bar{z}'}\right) + \ln\left(\frac{q^2}{\bar{z}} - z'\right) + \ln\left(\frac{q^2}{\bar{z}} - \frac{q^2}{\bar{z}'}\right) \\ &= 2N(z, z') + \ln\left(\frac{q^2 z z'}{\bar{z} \bar{z}'}\right). \end{aligned} \quad (5\cdot31)$$

The last term is irrelevant since it gives functions depending only on a single variable z or z' or \bar{z} or \bar{z}' .

Since \bar{N}_{mn}^{rs} appear as Fourier coefficients of the Neumann function Eq. (5.32), namely the coefficients of the terms $w_r^n w_s^m = e^{n(\tau_r + i\sigma_r)} e^{m(\tau'_s + i\sigma'_s)}$, we rewrite it by substituting

$$z = \alpha_r W_r + \sqrt{W_r^2 - q^2} = 2\alpha_r \left(W_r - \frac{q^2}{4W_r} \right) + O(q^4)$$

$$\text{with } W_r \equiv \frac{1 - w_r}{1 + w_r}, \quad \alpha_1 = +1, \quad \alpha_2 = -1, \quad (5.33)$$

which follows from the mapping of Eq. (5.17) and the relation $\rho = \alpha_r \rho_r = \alpha_r \ln w_r$ in the string region $r = 1$ and 2 .

Actually, however, the last relation $\rho = \alpha_r \rho_r = \alpha_r \ln w_r$ applies only to the P2 vertex case, and the correct one for the D2 vertex case is $\rho = \alpha_r (\rho_r - T/2) = \alpha_r \ln(w_r e^{-T/2})$. So the variable w_r in Eq. (5.33) should be understood as standing for $w_r e^{-T/2}$ for D2 case. This means that if we find the terms of the form $A_{mn}^{rs} w_r^n w_s^m$ by writing the Neumann function in terms of the variable w_r in Eq. (5.33), the true Neumann coefficients \bar{N}_{mn}^{rs} in D2 case is given by $\bar{N}_{mn}^{rs} = A_{mn}^{rs} e^{-nT/2} e^{-mT/2}$. But recall that what we need for the D2 case is not the exponent E_H but \hat{E}_H , for which, since the replacement Eq. (5.29) is done, the coefficients of the oscillators are given by $\bar{N}_{mn}^{rs} e^{nT/2} e^{mT/2}$ and just equal the coefficients A_{mn}^{rs} . So, for both D2 and P2 cases, we can unifiedly find the desired Neumann coefficients simply by using Eq. (5.33).

Now, substituting Eq. (5.33) into Eq. (5.32), we easily find

$$\begin{aligned} N(\rho_r, \rho'_s) &= \ln |w_r - w'_s| + \frac{q^2}{2} \sum_{m,n \geq 1} [(w_r^m - \bar{w}_r^m)(w_s'^n - \bar{w}_s'^n)] \\ &\quad + (\text{irrelevant terms}) \quad \text{for } (r, s) = (1, 1), (2, 2) \\ &= - \sum_{n \geq 1} \frac{1}{2n} (w_r^n w_s'^n + \bar{w}_r^n \bar{w}_s'^n) - \frac{q^2}{2} \sum_{m,n \geq 1} [(w_r^m - \bar{w}_r^m)(w_s'^n - \bar{w}_s'^n)] \\ &\quad + (\text{irrelevant terms}) \quad \text{for } (r, s) = (1, 2), (2, 1). \end{aligned} \quad (5.34)$$

The (irrelevant terms) stands for $2 \ln 2 - \ln |(1 + w_r)(1 + w'_s)|$ which yields functions of a single variable w_r or w'_s , not contributing to the exponent E_H in the presence of the momentum conservation. The exponent E_H can now be obtained from this by formally performing replacements $(w_r^m, \bar{w}_r^m, w_s'^n, \bar{w}_s'^n) \rightarrow (a_m^{(r)}, \bar{a}_m^{(r)}, a_n^{(s)}, \bar{a}_n^{(s)})$, discarding the free propagation term $\ln |w_r - w'_s|$ as well as irrelevant terms:

$$\begin{aligned} E_H(1^c, 2^c) &= E_{12}^c + \frac{q^2}{2} \sum_{m \geq 1} (a_m^{(1)} - \bar{a}_m^{(1)}) \cdot \sum_{n \geq 1} (a_n^{(1)} - \bar{a}_n^{(1)}) \\ &\quad + \frac{q^2}{2} \sum_{m \geq 1} (a_m^{(2)} - \bar{a}_m^{(2)}) \cdot \sum_{n \geq 1} (a_n^{(2)} - \bar{a}_n^{(2)}) \\ &\quad - q^2 \sum_{m \geq 1} (a_m^{(1)} - \bar{a}_m^{(1)}) \cdot \sum_{n \geq 1} (a_n^{(2)} - \bar{a}_n^{(2)}) + O(q^4), \end{aligned} \quad (5.35)$$

where E_{12}^c is the exponent of the closed reflector defined in Eq. (2·11), and we have used an OSp invariant notation $a_m^M = (\alpha_m^\mu, \gamma_m, \beta_m)$ and $a \cdot b = a^M \eta_{MN} b^N$ introduced in Eq. (5·23). The appearance of the reflector is natural since the configurations of D2 and P2 vertices both reduce to a mere connection of two closed strings when T, σ_0 go to zero. Substitute this expanded form for $E_H(1^c, 2^c)$ (which is in fact $\hat{E}_H(1^c, 2^c)$ for D2 case) into Eq. (5·21) (or Eq. (5·28) for D2 case) and multiply $b_0^{-(1)} b_0^{-(2)}$ to it. Then, noting

$$\begin{aligned} {}_{2^c} \langle \tilde{1}, \tilde{1} |_{1^c} \langle \tilde{1}, \tilde{1} | \left(\sum_r \frac{b_0^{(r)}}{\alpha_r} \right) b_0^{-(1)} b_0^{-(2)} \\ = - {}_{2^c} \langle 1, 1 |_{1^c} \langle 1, 1 | (c_0^{+(1)} + c_0^{+(2)}) (c_0^{-(1)} + c_0^{-(2)}) b_0^{-(1)}. \end{aligned} \quad (5.36)$$

we find

$$\begin{aligned} \langle v(1^c, 2^c; q) | b_0^{-(1)} b_0^{-(2)} = N(q) \langle R^c(1^c, 2^c) | C^{(1)}(\rho_0^{(1)}) C^{(2)}(\rho_0^{(1)}) \\ \times \left\{ 1 + q^2 \mathcal{D}^{(1)}(0) + O(q^4) \right\} b_0^{-(1)}, \end{aligned} \quad (5.37)$$

where we have defined

$$\mathcal{D}(\rho) = - : \left\{ \frac{1}{2} \left(\frac{dX}{d\rho}(\rho) - \frac{d\bar{X}}{d\bar{\rho}}(\bar{\rho}) \right)^2 + \left(\frac{dc}{d\rho}(\rho) - \frac{d\bar{c}}{d\bar{\rho}}(\bar{\rho}) \right) (b(\rho) - \bar{b}(\bar{\rho})) \right\} : . \quad (5.38)$$

Note that this $\mathcal{D}(0)$ is commutative with the ghost factor $C(\rho_0^{(1)})$ since $b(0) - \bar{b}(0)$ contained in the former anti-commutes with $C(\rho_0^{(1)}) = \frac{1}{2} (c(\rho_0^{(1)}) + \bar{c}(\rho_0^{(1)}))$. [This explains why we have rewritten the original ghost factor $c(\rho_0^{(1)})$ into $C(\rho_0^{(1)})$ as done in in Eqs. (5·25) and Eq. (5·27). If we had kept using $c(\rho_0^{(1)})$, we would have encountered a divergent expression like $b(0)c(\rho_0^{(1)}) \sim 1/\rho_0^{(1)}$ as $\rho_0^{(1)} \rightarrow 0$.] We replace $C^{(2)}(\rho_0^{(1)})$ by $-C^{(1)}(-\rho_0^{(1)})$ since they are equal on the reflector $\langle R^c(1^c, 2^c) |$, and expand the two ghost factors in powers of q using Eq. (5·24):

$$C^{(1)}(-\rho_0^{(1)}) C^{(1)}(\rho_0^{(1)}) = q C^{(1)} \frac{dC^{(1)}}{d\rho}(0) + q^3 \mathcal{A}(0) + O(q^5), \quad (5.39)$$

where \mathcal{A} is defined by

$$\mathcal{A}(\rho) = \frac{1}{3} C \frac{dC}{d\rho} - 2 \frac{dC}{d\rho} \frac{d^2 C}{d\rho^2} + \frac{2}{3} C \frac{d^3 C}{d\rho^3}. \quad (5.40)$$

Finally, substituting Eqs. (A·31) and (5·39) to Eq. (5·37), we obtain

$$\begin{aligned} \langle v(1^c, 2^c; q) | b_0^{-(1)} b_0^{-(2)} \\ = \langle R^c(1^c, 2^c) | \left\{ \frac{2}{q^2} C^{(1)} \frac{dC^{(1)}}{d\rho}(0) + \mathcal{B}^{(1)}(0) + O(q^2) \right\} b_0^{-(1)}, \end{aligned} \quad (5.41)$$

with

$$\mathcal{B}(\rho) = \frac{1}{2} \left(\mathcal{A} - 3C \frac{dC}{d\rho} + C \frac{dC}{d\rho} \mathcal{D} \right). \quad (5.42)$$

This Eq. (5.41) is a result which applies both to D2 and P2 vertices by putting $q = a$ and $q = ia$, respectively. In the limit $q \rightarrow 0$ (i.e., $T \rightarrow 0$ for D2 and $\sigma_0 \rightarrow 0$ for P2 cases), this has two contributions: the first divergent term $\propto 1/q^2$ corresponds to the tachyon contribution and the second to the dilaton, as anticipated. The powers of q in these are reduced by 1 since a power q^1 came from the product of two ghost factors $C^{(1)}(-\rho_0^{(1)})C^{(1)}(\rho_0^{(1)})$ at the interaction points which vanish at the coincident limit.

At last, we can determine the relation for the parameters of x_u , x_∞ and λ_c to make the action gauge invariant. Since the result Eq. (5.41) is common to D2 and P2 vertices, the $\mathcal{B}^{(1)}(0)$ term can be canceled between the first two terms in δS_2 in Eq. (4.4), if we take $nx_u^2 = x_\infty$:

$$\begin{aligned} & x_u^2 \langle U(1, 1^c) | \langle U(2, 2^c) | | R^o(1, 2) \rangle + x_\infty \langle V_\infty(1^c, 2^c) | (\tilde{Q}_B^{(1)} + \tilde{Q}_B^{(2)}) \\ &= \lim_{a \rightarrow 0} \frac{4nx_u^2}{a^2} \langle R^c(1^c, 2^c) | C^{(1)} \frac{dC^{(1)}}{d\rho}(0) b_0^{-(1)} \prod_{r=1^c, 2^c} (\mathcal{P}II)^{(r)} \\ &+ x_\infty \lambda_c \int_0^{\frac{\pi}{2}} d\sigma_0 \langle v_\infty(1^c, 2^c; \sigma_0) | b_{\sigma_0}(c_0^{+(1^c)} + c_0^{+(2^c)}) \prod_{r=1^c, 2^c} (b_0^- \mathcal{P}II)^{(r)}, \end{aligned} \quad (5.43)$$

where we have used $\langle V_\infty(2^c, 1^c) | = -\langle V_\infty(1^c, 2^c) |$, and note the minus sign in the first term in Eq. (5.12). The first singular term, due to the existence of the tachyon in bosonic strings, did not cancel but added up between the two since $q^2 = a^2$ for D2 and $q^2 = -a^2$ for P2. However, since it can be rewritten into the form of a BRS transform as

$$\begin{aligned} & \langle R^c(1^c, 2^c) | C^{(1)} \frac{dC^{(1)}}{d\rho}(0) b_0^{-(1)} \mathcal{P}^{(1)} \mathcal{P}^{(2)} \\ &= \langle R^c(1^c, 2^c) | \{ Q_B^{(1^c)}, \frac{1}{2} c_0^{+(1^c)} \} b_0^{-(1)} \mathcal{P}_1 \mathcal{P}_2, \end{aligned} \quad (5.44)$$

it turns out that it can be canceled by the third term in δS_2 in Eq. (4.4) if we set

$$\lambda_c = - \lim_{a \rightarrow 0} \frac{2nx_u^2}{a^2}. \quad (5.45)$$

This corresponds to an infinite renormalization of the zero intercept parameter as mentioned before, and explains the reason why we have had to define the ‘bare’ BRS charge \tilde{Q}_B by shifting the zero intercept parameter.

Finally, let us show that the remaining second term in Eq. (5.43) also vanishes. First we note that

$$\begin{aligned} \langle v_\infty(1^c, 2^c; \sigma_0) | b_{\sigma_0} &= \langle v_\infty(1^c, 2^c; \sigma_0) | \left(-i \oint_{C_1} + i \oint_{C_2} \right) \frac{d\rho}{2\pi i} b(\rho) \\ &= \langle v_\infty(1^c, 2^c; \sigma_0) | \left(-i \oint_{C_{z_0^{(1)}}} + i \oint_{C_{z_0^{(2)}}} \right) \frac{dz}{2\pi i} \left(\frac{dz}{d\rho} \right) b(\rho) \\ &= A(q) \langle v_\infty(1^c, 2^c; \sigma_0) | (b(z_0^{(1)}) + b(z_0^{(2)})), \end{aligned} \quad (5.46)$$

with $A(q) = iq(1 - q^2)/2$, where we have used Eq. (3.18) and $\rho_0^{(1)} = -\rho_0^{(2)} = -i\sigma_0$ for the definition of b_{σ_0} . The contour $C_1 - C_2$ on the ρ plane is deformed as drawn

in Fig. 12 a), and then mapped to $C_{z_0^{(1)}} - C_{z_0^{(2)}}$ on the z plane where $C_{z_0^{(i)}}$ are closed contours encircling the interaction points $z_0^{(i)}$ in Fig. 11. Eqs. (A-16), (5-18) and (5-20) have been used for the evaluation of the contour integration on the z plane. Next, the ghost zero-mode factor $(c_0^{+(1^c)} + c_0^{+(2^c)}) = \frac{1}{2}(c_0^{(1^c)} + \bar{c}_0^{(1^c)} + c_0^{(2^c)} + \bar{c}_0^{(2^c)})$ in the second term, which is first written as an integral over σ , can also be rewritten as an integral over z again going to the z plane. The integral contour can be deformed to the closed paths $C_{z_0^{(1)}} + C_{z_0^{(2)}}$ around the interaction points, and we find:

$$\begin{aligned} & \langle v_\infty(1^c, 2^c; \sigma_0) | b_{\sigma_0} (c_0^{+(1^c)} + c_0^{+(2^c)}) \\ &= \frac{1}{2} A(q) \langle v_\infty(1^c, 2^c; \sigma_0) | \left(\oint_{C_{z_0^{(1)}}} + \oint_{C_{z_0^{(2)}}} \right) \frac{dz}{2\pi i} \left(\frac{d\rho}{dz} \right)^2 (b(z_0^{(1)}) + b(z_0^{(2)})) c(z). \end{aligned} \quad (5.47)$$

But, although $\langle b(z_0^{(i)}) c(z) \rangle = 1/(z_0^{(i)} - z)$, since the factor $(d\rho/dz)^2$ contains double zero $(z_0^{(i)} - z)^2$, the integrand is regular around the interaction points and the contour integral vanishes. Thus we have finished the proof of the $O(g^2)$ gauge invariance $\delta S_2 = 0$ and found the first two relations in Eq. (5-1) for the parameters.

5.3. Order g^3 and g^4 invariance

Now we turn to the consideration of the order g^3 terms δS_3 in Eq. (4-4). Again, inserting a propagator of the intermediate state, we rewrite the first term of the two $O(g^3)$ terms into the form

$$\begin{aligned} & \langle \tilde{U}(1, 2^c) | \langle V_\infty(3^c, 1^c) | R^c(2^c, 3^c) \rangle \\ &= \lim_{\tau \rightarrow 0} \int_0^{\frac{\pi}{2}} d\sigma_0 \int_0^{2\pi} \frac{d\theta}{2\pi} \langle u(1, 2^c) | \langle v_\infty(3^c, 1^c; \sigma_0) | b_{\sigma_0} b_0^{-(3^c)} \\ & \quad \times e^{-\tau(L_0^{(3^c)} + \bar{L}_0^{(3^c)})} e^{i\theta(L_0^{(3^c)} - \bar{L}_0^{(3^c)})} | R^c(2^c, 3^c) \rangle (b_0^- \mathcal{P} \Pi)^{(1^c)} \\ &= \lim_{\tau \rightarrow 0} \int_0^{\frac{\pi}{2}} d\sigma_0 \int_0^{2\pi} \frac{d\theta}{2\pi} \langle v_1(1, 1^c; \sigma_0, \theta, \tau) | b_{\sigma_0} b_{C_\theta} (b_0^- \mathcal{P} \Pi)^{(1^c)}, \end{aligned} \quad (5.48)$$

where τ is the propagation time interval, the explicit expression for $\mathcal{P} = \int_0^{2\pi} (d\theta/2\pi) \exp(i\theta(L_0 - \bar{L}_0))$ was inserted for $\mathcal{P}^{(3)}$, and $\langle v_1(\sigma_0, \theta, \tau) |$ denotes the effective LPP vertex following from the GGR theorem, which corresponds to the string diagram depicted in Fig. 13. (We introduced τ for clarity for drawing the figure, although there occurs actually no singularity here even at $\tau = 0$.) $b_{C_\theta} \equiv (1/2) \oint_{C_\theta} d\rho / (2\pi i) b(\rho)$ is a rewriting of $b_0^{-(3^c)} = (1/2)(b_0 - \bar{b}_0)^{(3^c)}$ and the contour C_θ is the path traversing

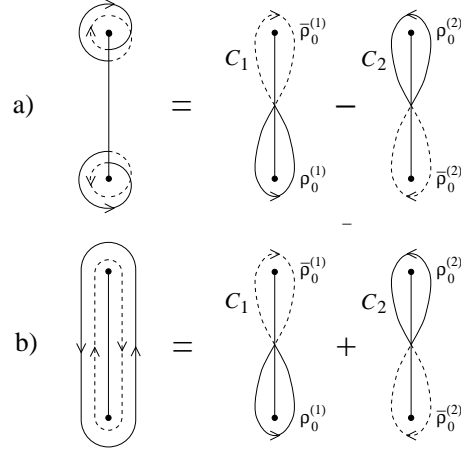

Fig. 12. Contour deformations a) and b) used in Eqs. (5-46) and (5-49), respectively.

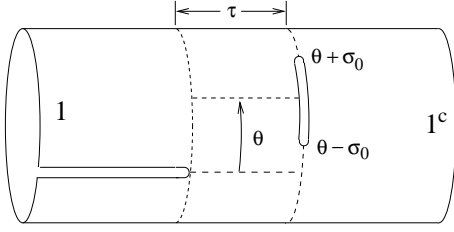

Fig. 13. The string diagram corresponding to the vertex $\langle v_1(\sigma_0, \theta, \tau) \rangle$.

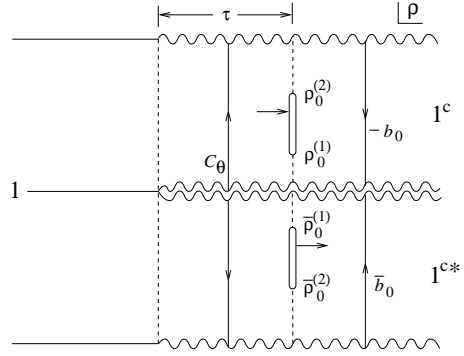

Fig. 14. The ρ plane of the vertex $\langle v_1(\sigma_0, \theta, \tau) \rangle$.

the intermediate closed string as drawn in Fig. 13.

Since $b_0^{-(1^c)}$ factor for the external closed string 1^c is also multiplied in Eq. (5.48), we can replace b_{C_θ} by $b_{C_\theta} - b_0^{-(1^c)}$, and the latter can be seen to reduce to the following expression by making a deformation of the integration contour as drawn in Fig. 12 b):

$$b_{C_\theta} - b_0^{-(1^c)} = -\frac{1}{2} \left(\oint_{C_1} + \oint_{C_2} \right) \frac{d\rho}{2\pi i} b(\rho) = -\frac{1}{2} (b_{\rho_0^{(1)}} + b_{\rho_0^{(2)}}), \quad (5.49)$$

where C_i ($i = 1, 2$) are the closed contours given before in Fig. 7. This expression can also be understood from the meaning of b_{C_θ} : it is originally the anti-ghost factor $b_0^{-(3)}$ corresponding to the quasi-conformal deformation for the change of θ , whereas the θ change is now equivalent to shifting the interaction points $\rho_0^{(1)} = \tau_0 + i(\theta - \sigma_0)$ and $\rho_0^{(2)} = \tau_0 + i(\theta + \sigma_0)$ simultaneously by a common amount, and $b_{\rho_0^{(i)}}$ are clearly the anti-ghost factors corresponding to the shift of $\rho_0^{(i)}$.

On the other hand, the other anti-ghost factor b_{σ_0} is

$$b_{\sigma_0} = -i(b_{\rho_0^{(1)}} - b_{\rho_0^{(2)}}) \quad (5.50)$$

by the definition Eq. (3.18). Substituting this and Eq. (5.49) into Eq. (5.48), we find

$$\begin{aligned} & \langle \check{U}(1, 2^c) | \langle V_\infty(3^c, 1^c) | | R^c(2^c, 3^c) \rangle \\ &= i \lim_{\tau \rightarrow 0} \int_0^{\frac{\pi}{2}} d\sigma_0 \int_0^{2\pi} \frac{d\theta}{2\pi} \langle v_1(1, 1^c; \sigma_0, \theta, \tau) | b_{\rho_0^{(1)}} b_{\rho_0^{(2)}} (b_0^- \mathcal{P} \Pi)^{1^c}. \end{aligned} \quad (5.51)$$

The second one of the two $O(g^3)$ terms δS_3 in Eq. (4.4) is rewritten as

$$\begin{aligned} & \langle V_\infty(1, 2) | \langle U(3, 1^c) | | R^o(2, 3) \rangle \\ &= - \lim_{\tau \rightarrow 0} \int_{0 \leq \sigma_1 \leq \sigma_2 \leq \pi} d\sigma_1 d\sigma_2 \langle v_\infty(1, 2; \sigma_1, \sigma_2) | \langle u(3, 1^c) | b_{\sigma_1} b_{\sigma_2} e^{-\tau L_0^{(3)}} | R^o(2, 3) \rangle (b_0^- \mathcal{P} \Pi)^{(1^c)} \\ &= +4 \lim_{\tau \rightarrow 0} \int_{0 \leq \sigma_1 \leq \sigma_2 \leq \pi} d\sigma_1 d\sigma_2 \langle v_2(1, 1^c; \sigma_1, \sigma_2, \tau) | b_{\rho_0^{(1)}} b_{\rho_0^{(2)}} (b_0^- \mathcal{P} \Pi)^{(1^c)}, \end{aligned} \quad (5.52)$$

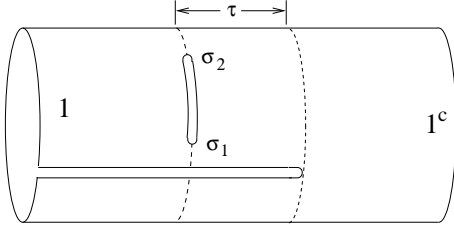

Fig. 15. The string diagram corresponding to the vertex $\langle v_2(\sigma_1, \sigma_2, \tau) \rangle$.

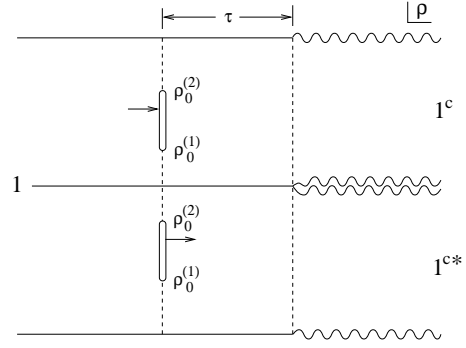

Fig. 16. The ρ plane of the vertex $\langle v_2(\sigma_1, \sigma_2, \tau) \rangle$.

where the minus in front comes from the order exchange of $b_0^{-(1^c)}$ and $|R^o(2, 3)\rangle$, and the factor -4 from $b_{\sigma_i} = (d\rho_0^{(i)}/d\sigma_i)b_{\rho_0^{(i)}} = 2ib_{\rho_0^{(i)}}$ since $\rho_0^{(i)} = \alpha_1(\tau_0 + i\sigma_i)$ and $\alpha_1 = 2$ (Note that the interaction points are now on the open string side). $\langle v_2(\sigma_1, \sigma_2, \tau) \rangle$ represents the effective LPP vertex corresponding to the string diagram depicted in Fig.15,

Since the two string diagrams Figs. 13 and 15 clearly reduce to the same configuration as $\tau \rightarrow 0$ and there are no singularities at $\tau = 0$, the corresponding effective LPP vertices must also become the same at $\tau = 0$:

$$\langle v_1(1, 1^c; \sigma_0, \theta, \tau = 0) \rangle = \langle v_2(1, 1^c; \sigma_1, \sigma_2, \tau = 0) \rangle. \quad (5.53)$$

Therefore, if

$$-ix_\infty \int_0^{\frac{\pi}{2}} d\sigma_0 \int_0^{2\pi} \frac{d\theta}{2\pi} + 4x_\infty \int_{0 \leq \sigma_1 \leq \sigma_2 \leq \pi} d\sigma_1 d\sigma_2 = 0, \quad (5.54)$$

holds for a common integrand, the two $O(g^3)$ terms in δS_3 in Eq. (4.4) cancel each other. Noting the relations $\alpha_1\sigma_1 = \theta - \sigma_0$, $\alpha_1\sigma_2 = \theta + \sigma_0$ with $\alpha_1 = 2$ and so $d\sigma_0 d\theta = 2d\sigma_1 d\sigma_2$, and confirming that the both terms cover the same integration region once, we obtain

$$x_\infty = -4\pi ix_\infty, \quad (5.55)$$

as a sufficient condition for the $O(g^3)$ gauge invariance.

Finally consider the $O(g^4)$ term δS_4 in Eq. (4.4). It is rewritten as

$$\begin{aligned} & \langle \check{V}_\infty(1^c, 3^c) | \langle V_\infty(4^c, 2^c) | | R^c(3^c, 4^c) \rangle \\ &= \lim_{\tau \rightarrow 0} \int_0^{\frac{\pi}{2}} d\sigma_0 \int_0^{\frac{\pi}{2}} d\tilde{\sigma}_0 \langle v_\infty(1^c, 3^c; \sigma_0) | \langle v_\infty(4^c, 2^c; \tilde{\sigma}_0) | b_{\sigma_0} b_{\tilde{\sigma}_0} b_0^{-(4)} \\ & \quad \times e^{-\tau(L_0^{(4^c)} + \bar{L}_0^{(4^c)})} e^{i\theta(L_0^{(4^c)} - \bar{L}_0^{(4^c)})} | R^c(3^c, 4^c) \rangle \prod_{r=1^c, 2^c} (b_0^- \mathcal{P} \Pi)^{(r)} \\ &= \lim_{\tau \rightarrow 0} \int_0^{\frac{\pi}{2}} d\sigma_0 \int_0^{\frac{\pi}{2}} d\tilde{\sigma}_0 \int_0^{2\pi} \frac{d\theta}{2\pi} \langle v_3(1^c, 2^c; \sigma_0, \tilde{\sigma}_0, \theta, \tau) | b_{C_\theta} b_{\sigma_0} b_{\tilde{\sigma}_0} \prod_{r=1^c, 2^c} (b_0^- \mathcal{P} \Pi)^{(r)}, \end{aligned} \quad (5.56)$$

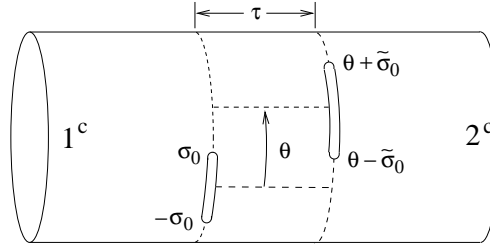

Fig. 17. The string diagram corresponding to the vertex $\langle v_3(\sigma_0, \tilde{\sigma}_0, \theta, \tau) |$.

where $\langle v_3(\sigma_0, \tilde{\sigma}_0, \theta, \tau) |$ is the effective LPP vertex corresponding to the string diagram depicted in Fig. 17. Again, there appears no singularity even at $\tau = 0$.

Consider string configurations corresponding to the LPP vertex $\langle v_3(\sigma_0, \tilde{\sigma}_0, \theta, \tau) |$. We note that, for each possible configuration at $\tau = 0$, there are always a pair of configurations with $\tau \neq 0$ which reduce to the same configuration at $\tau = 0$; they are clearly the two configurations with $(\sigma_0=x, \tilde{\sigma}_0=y, \theta=\phi)$ $(\sigma_0=y, \tilde{\sigma}_0=x, \theta=-\phi)$. Though the pair reduce to the same configuration, the anti-ghost factors $b_{\sigma_0} b_{\tilde{\sigma}_0}$ appear in the reverse order. Since anti-ghost factors anti-commute, the pair cancel each other and Eq. (5.56) becomes zero. We thus have proved that the order g^4 gauge invariance is realized.

§6. String 2-point Amplitudes

In this section, we calculate closed string 2-point amplitudes corresponding to a disk and a projective plane using the Feynman rule which follows from the gauge invariant action determined in the previous section.

We must fix the gauge first. From the gauge invariance under the transformation of Eq. (1.2), it is possible to impose the usual gauge fixing condition for the closed string field;

$$b_0^+ |\Phi\rangle = 0. \quad (6.1)$$

The present open-closed mixed system is naturally expected to possess also the gauge symmetry with an open string field parameter Λ° , although we have not discussed it. (Actually, it is violated at the tree level but is realized at the loop level, as we shall see in later publication.¹⁴) So here we simply assume that this is the case and we impose the same type of gauge condition also for the open string field:

$$b_0 |\Psi\rangle = 0. \quad (6.2)$$

Once the gauge is fixed, we can derive the gauge fixed action and the Feynman rules following by now the standard procedure: the gauge fixed action takes the same form as the above gauge invariant one (4.2), but here $|\Psi\rangle$ and $|\Phi\rangle$ are now subject to the gauge conditions (6.2) and (6.1) and contain only the $|\phi\rangle$ component defined in Eq. (2.5). (However, the $|\phi\rangle$ here in the gauge fixed action contains *much more* component fields than the original $|\phi\rangle$ (or even the whole fields $|\Psi\rangle$ and $|\Phi\rangle$) of the

gauge invariant action, since now in the gauge fixed action the restriction that the component fields carry vanishing ghost number is no longer imposed. The infinite tower of component fields carrying non-zero ghost number here correspond to the FP ghost fields, ghosts' ghost fields, and so on.) The Feynman propagators are given by

$$\begin{aligned} \overline{|\Psi\rangle}_1 |\Psi\rangle_2 &= \left(\frac{b_0}{L_0}\right)^{(1)} |R^o(1, 2)\rangle, \\ b_0^{-{(1)}} \overline{|\Phi\rangle}_1 b_0^{-{(2)}} |\Phi\rangle_2 &= \left(\frac{b_0 \bar{b}_0}{L_0 + \bar{L}_0}\right)^{(1)} |R^c(1, 2)\rangle. \end{aligned} \quad (6.3)$$

Note that these propagators indicate that only the $|\phi\rangle$ components are propagating. Therefore, in the Feynman diagrams, we can use the same form of vertices as appearing in the gauge invariant action Eq. (4.2). [Precisely speaking, we should put the projections $\mathcal{I}^{(1)}$ and $(\mathcal{P}\mathcal{I})^{(1)}$ for the open and closed propagators, respectively, since our fields are subject to the constraints $\mathcal{I}^{(1)}|\Psi\rangle = |\Psi\rangle$ and $(\mathcal{P}\mathcal{I})^{(1)}|\Phi\rangle = |\Phi\rangle$. But, since all the vertices are constructed to contain those projections, we can omit them from the propagators.]

Now, we consider the disk amplitude for the closed tachyon 2-point function which comes from using the open-closed transition vertex twice. Noting that normalized closed tachyon state is given by

$$\begin{aligned} |\Phi(p)\rangle &= \sqrt{2}c_0^- |\varphi(p)\rangle, \\ |\varphi(p)\rangle &= \left[c(w)\bar{c}(\bar{w}) \exp\left(ip \cdot \frac{1}{2}(X(w) + \bar{X}(\bar{w}))\right) \right]_{\substack{w=0 \\ \bar{w}=0}} |0\rangle, \end{aligned} \quad (6.4)$$

and satisfies $\mathcal{P}\mathcal{I}|\varphi(p)\rangle = |\varphi(p)\rangle$, we find the disk amplitude as follows:

$$\begin{aligned} &(2\pi)^d \delta^d(p_1 + p_2) \mathcal{A}_{D_2} \\ &= (x_u g)^2 \langle U(4, 2^c) | \Phi(p_2) \rangle_{2^c} \overline{|\Psi\rangle}_4 \langle U(3, 1^c) | \Phi(p_1) \rangle_{1^c} |\Psi\rangle_3 \\ &= 2x_u^2 g^2 \langle u(4, 2^c) | \langle u(3, 1^c) | \frac{b_0^{(4)}}{L_0^{(4)}} |R^o(3, 4)\rangle |\varphi(p_1)\rangle_{1^c} |\varphi(p_2)\rangle_{2^c} \\ &= 2x_u^2 g^2 \int_0^\infty d\tau \langle u(3, 1^c) | \langle u(4, 2^c) | \\ &\quad \times \oint_C \frac{d\rho}{2\pi i} \left(\frac{d\rho}{d\rho_4} \right) b(\rho) e^{-L_0^{(4)}\tau} |R^o(3, 4)\rangle |\varphi(p_1)\rangle_{1^c} |\varphi(p_2)\rangle_{2^c} \\ &= -4nx_u^2 g^2 \int_0^\infty d\tau \langle v_{D_2}(1^c, 2^c; T=2\tau) | \oint_C \frac{d\rho}{2\pi i} b(\rho) |\varphi(p_1)\rangle_{1^c} |\varphi(p_2)\rangle_{2^c} \quad (6.5) \end{aligned}$$

where $\langle v_{D_2}(1^c, 2^c; T=2\tau) |$ is the LPP vertex introduced in Eq. (5.8) corresponding to Fig. 8 and the contour C is the path traversing the intermediate open string strip (from bottom to top). Note that $d\rho/d\rho_4 = \alpha_4 = 2$ was used since string 4 is an open string. The front minus sign in the last expression comes from the exchange of the order of $b(\rho)$ and $|R^o(3, 4)\rangle$. By the definition of the LPP vertex and the mapping

(5.17), we can evaluate the amplitude as follows by the conformal field theory on the z plane in Fig. 10:

$$\begin{aligned}
&= -4n x_u^2 g^2 \delta^d(p_1 + p_2) \int_0^\infty d\tau \oint_{C'} \frac{dz}{2\pi i} \left(\frac{d\rho}{dz} \right)^{-1} \left\langle b(z)c(Z_1)c(\hat{Z}_1)c(Z_2)c(\hat{Z}_2) \right\rangle \\
&\quad \times \left\langle e^{ip_1 \cdot X(Z_1)/2} e^{ip_1 \cdot X(\hat{Z}_1)/2} e^{ip_2 \cdot X(Z_2)/2} e^{ip_2 \cdot X(\hat{Z}_2)/2} \right\rangle, \tag{6.6}
\end{aligned}$$

where $d = 26$ and the contour C' is the image of C on the z plane which is just the line from $i\infty$ to $-i\infty$ along the imaginary axis of the z plane in Fig. 10. The correlation function for the ghost part is calculated in Appendix A, and the matter part is easily evaluated by using $\langle X^\mu(z) X^\nu(\tilde{z}) \rangle = -\eta^{\mu\nu} \ln(z - \tilde{z})$ as

$$\begin{aligned}
&\left\langle e^{ip_1 \cdot X(Z_1)/2} e^{ip_1 \cdot X(\hat{Z}_1)/2} e^{ip_2 \cdot X(Z_2)/2} e^{ip_2 \cdot X(\hat{Z}_2)/2} \right\rangle \\
&= \prod_{\substack{r \neq s \\ r,s=1,2,\hat{1},\hat{2}}} (Z_r - Z_s)^{p_r \cdot p_s / 4} = \frac{(1 - q^2)^2}{2^4 q^4}, \tag{6.7}
\end{aligned}$$

where we have used the momentum conservation and the on-shell condition $p_1^2 = p_2^2 = 8$ together with Eq. (5.20). Thus, using Eqs. (A.8) and (A.16) in the Appendix A, we find the disk amplitude as follows,

$$\begin{aligned}
\mathcal{A}_{D_2} &= -4n x_u^2 g^2 \int_0^\infty d\tau \oint_{C'} \frac{dz}{2\pi i} \frac{\prod_{r=1,\hat{1},2,\hat{2}} (z - Z_r)}{4(z - z_0^{(1)})(z - z_0^{(2)})} \frac{2^6 q^2 (1 - q^2)}{\prod_{r=1,\hat{1},2,\hat{2}} (z - Z_r)} \frac{(1 - q^2)^2}{2^4 q^4} \\
&= -4n x_u^2 g^2 \int_0^\infty d\tau \frac{(1 - q^2)^3}{2q^3} = -4n x_u^2 g^2 \int_0^1 dq \frac{1}{q^3} (1 - q^2)^2, \tag{6.8}
\end{aligned}$$

where we have evaluated the $\oint_{C'} dz/2\pi i$ integration simply by evaluating the residue at $z_0^{(1)}$ ($= q$), and then used $d\tau = d(T/2) = (2/(1 - q^2))dq$ which follows from Eq. (5.14).

Similarly, we can calculate the projective plane amplitude for the tachyon 2-point function, which comes from the closed intersection vertex as follows:

$$\begin{aligned}
&(2\pi)^d \delta^d(p_1 + p_2) \mathcal{A}_{P_2} \\
&= -x_\infty g^2 \langle V_\infty(1^c, 2^c) | \sqrt{2} c_0^{-(1^c)} | \varphi(p_1) \rangle_{1^c} \sqrt{2} c_0^{-(2^c)} | \varphi(p_2) \rangle_{2^c} \\
&= -x_\infty g^2 \int_0^{\pi/2} d\sigma_0 \langle v_\infty(1^c, 2^c; \sigma_0) | b_{\sigma_0} \sqrt{2} | \varphi(p_1) \rangle_{1^c} \sqrt{2} | \varphi(p_2) \rangle_{2^c} \\
&= -2x_\infty g^2 \delta^d(p_1 + p_2) \int_0^{\pi/2} d\sigma_0 \left(-i \oint_{C_{z_0^{(1)}}} + i \oint_{C_{z_0^{(2)}}} \right) \frac{dz}{2\pi i} \left(\frac{d\rho}{dz} \right)^{-1} \\
&\quad \times \left\langle b(z)c(Z_1)c(\hat{Z}_1)c(Z_2)c(\hat{Z}_2) \right\rangle \\
&\quad \times \left\langle e^{ip_1 \cdot X(Z_1)/2} e^{ip_1 \cdot X(\hat{Z}_1)/2} e^{ip_2 \cdot X(Z_2)/2} e^{ip_2 \cdot X(\hat{Z}_2)/2} \right\rangle \tag{6.9}
\end{aligned}$$

so that

$$\mathcal{A}_{P_2} = -2x_\infty g^2 \int_0^{\pi/2} d\sigma_0 \left(-i \oint_{C_{z_0^{(1)}}} + i \oint_{C_{z_0^{(2)}}} \right) \frac{dz}{2\pi i} \frac{1}{(z - z_0^{(1)})(z - z_0^{(2)})} \frac{(1 - q^2)^3}{q^2}$$

$$\begin{aligned}
&= -2x_\infty g^2 \int_0^{\pi/2} d\sigma_0 \left(-i\frac{1}{2q} + i\frac{1}{-2q} \right) \frac{(1-q^2)^3}{q^2} \\
&= +2x_\infty g^2 \int_0^{\pi/2} id\sigma_0 \frac{1}{q^3} (1-q^2)^3 = +2x_\infty g^2 \int_0^{+i} dq \frac{2}{q^3} (1-q^2)^2 \\
&= -4x_\infty g^2 \int_0^1 dq \frac{1}{q^3} (1+q^2)^2. \tag{6.10}
\end{aligned}$$

where use has been made of $i\sigma_0 = \ln[(1+q)/(1-q)]$ and $d(i\sigma_0) = (2/(1-q^2))dq$, and, at the final step, we have changed the variable, $q \rightarrow iq$ so that the new q takes real values in $[0, 1]$ as in the preceding case.

The amplitudes of Eqs. (6.8) and (6.9) are singular at the point $q = 0$, and so we introduce a cut-off parameter a :

$$\begin{aligned}
\mathcal{A}_{D_2} &= -4g^2 \begin{pmatrix} nx_u^2 \\ x_\infty \end{pmatrix} \lim_{a \rightarrow 0} \int_a^1 dq \frac{1}{q^3} (1 \mp q^2)^2 \\
&= -4g^2 \begin{pmatrix} nx_u^2 \\ x_\infty \end{pmatrix} \lim_{a \rightarrow 0} \left(\frac{1}{2a^2} \pm 2 \ln a \right). \tag{6.11}
\end{aligned}$$

The quadratic divergences correspond to an emission of the closed tachyon to the vacuum, and the logarithmic divergence to the dilaton. The two dilaton divergences are combined to cancel each other if $x_\infty = nx_u^2$, which is the same condition as required by the gauge invariance in the previous section. So we are left with

$$\mathcal{A}_{D_2} + \mathcal{A}_{P_2} = - \lim_{a \rightarrow 0} \frac{4nx_u^2}{a^2} g^2. \tag{6.12}$$

We still have another amplitude contribution to the same order, coming from the counter term which was introduced as a renormalization of the intercept. The counterterm is contained in $\tilde{Q}_B^c = Q_B^c + \lambda_c g^2 c_0^+$, and hence contributes to the tachyon amplitude as

$$\begin{aligned}
&(2\pi)^d \delta^d(p_1 + p_2) \mathcal{A}_{\text{count}} \\
&= -\langle R^c(2^c, 1^c) | \sqrt{2} c_0^{-(1^c)} |\varphi(p_1)\rangle_{1^c} \lambda_c g^2 c_0^{+(2^c)} b_0^{-(2^c)} \sqrt{2} c_0^{-(2^c)} |\varphi(p_2)\rangle_{2^c} \\
&= -2\lambda_c g^2 \langle R^c(2^c, 1^c) | c_0^{-(1^c)} |\varphi(p_1)\rangle_{1^c} c_0^{+(2^c)} |\varphi(p_2)\rangle_{2^c}. \tag{6.13}
\end{aligned}$$

This is easily evaluated using the oscillator expression directly and yield

$$\mathcal{A}_{\text{count}} = -2\lambda_c g^2 = + \lim_{a \rightarrow 0} \frac{4nx_u^2}{a^2} g^2. \tag{6.14}$$

The cut-off parameter a here is the one introduced in the previous section and has obviously the same physical meaning as that introduced in Eq. (6.11), and so we can identify these parameters. Comparing Eq. (6.12) and (6.14), it turns out that also the divergences originated in the tachyon cancel after summation of the three amplitudes if the action has the gauge symmetry, and we conclude that the net tachyon amplitude vanishes in this order:

$$\mathcal{A}_{D_2} + \mathcal{A}_{P_2} + \mathcal{A}_{\text{count}} = 0. \tag{6.15}$$

§7. Summary and discussion

In this paper we have considered the mixed system of open and closed strings and constructed the string field theory action explicitly up to the terms quadratic in the fields. We have proved in detail the invariance of the action under the gauge transformation with closed string field parameter A^c .

It is not difficult, in principle, to construct the full action which is invariant under both type gauge transformations with open and closed string field parameters A^o and A^c . But, to do this, we need to consider one-loop amplitudes with open-string external states. This is because of anomaly: the gauge invariance under the open string transformation parameter A^o is violated at one-loop diagrams for open string 2-point function constructed with 3-open-string-vertex twice. And those violations can be canceled by the tree diagrams with the open-closed transition interaction U twice and with open intersection interaction V_∞ once. [As for the orientable diagram parts, this anomaly is essentially the same as the situation for the Lorentz invariance known already in the light-cone gauge string field theory.^{11), 12), 13)}] The string diagrams between which these cancellations occur for non-orientable diagram parts are locally the same as the D2 and P2 diagrams in Figs. 8 and 6 considered in this paper, and the only difference is that there the external states are also open strings (so D2 becomes a one-loop diagram). It is there that the relation between the coupling constants x_∞ and x_u is fixed and the condition

$$n = 2^{26/2} = 8192 \quad (7.1)$$

is required. Because of the complications due to loop-amplitude calculation, we deferred these discussions to the forthcoming paper in which we shall present the full gauge invariant action.

The main motive for this work is to develop the string field theory which can describe the D-branes. Since T-dual transformation of the usual open string gives the open string with Dirichlet boundary, the D-brane dynamics can be studied in detail in our string field theory for open-closed mixed system. But, to do this fully we have to wait for the completion of the full gauge invariant action. Even at this stage, however, we can see some connection of our string field theory and the Dirac-Born-Infeld action for D-branes. Let us explain this here briefly.

We consider the gauge transformations for some massless fields. If the T-duality transformation is done, the unoriented closed string is known to look like an oriented closed string apart from the orientifold plane,³¹⁾ and so it becomes to contain an anti-symmetric tensor field $B_{\mu\nu}(x)$ in the form

$$\begin{aligned} b_0^- |\Phi\rangle &= \frac{1}{2} B_{\mu\nu}(x) (\alpha_{-1}^\mu \bar{\alpha}_{-1}^\nu - \alpha_{-1}^\nu \bar{\alpha}_{-1}^\mu) |1, 1\rangle + \cdots \\ &= -\frac{1}{2} B_{\mu\nu}(x) [c\partial X^\mu(w) \bar{c}\bar{\partial} \bar{X}^\nu(\bar{w}) - (\mu \leftrightarrow \nu)] \Big|_{\substack{w=0 \\ \bar{w}=0}} |0\rangle + \cdots \end{aligned} \quad (7.2)$$

The transformation parameter A^c has the following mode:

$$\begin{aligned} b_0^- |A^c\rangle &= -2i\zeta_\mu(x) (b_{-1} \bar{\alpha}_{-1}^\mu - \bar{b}_{-1} \alpha_{-1}^\mu) |1, 1\rangle + \cdots \\ &= 2\zeta_\mu(x) [c\partial X^\mu(w) + \bar{c}\bar{\partial} \bar{X}^\mu(\bar{w})] \Big|_{\substack{w=0 \\ \bar{w}=0}} |0\rangle + \cdots \end{aligned} \quad (7.3)$$

Noting that the last expression can also be written as

$$2 \left[\zeta_\mu \left(\frac{1}{2} (X(w) + \bar{X}(\bar{w})) \right) (c\partial X^\mu(w) + \bar{c}\bar{\partial} \bar{X}^\mu(\bar{w})) \right]_{\substack{w=0 \\ \bar{w}=0}} |0\rangle \quad (7.4)$$

(with normal ordering implied) and that $[Q_B, X] = c\partial X$ and $[Q_B, \bar{X}] = \bar{c}\bar{\partial} \bar{X}$, we find the BRS transform of this as

$$\begin{aligned} -Q_B b_0^- |A^c\rangle &= -\frac{1}{2} (\partial_\mu \zeta_\nu(x) - \partial_\nu \zeta_\mu(x)) \\ &\quad \times [c\partial X^\mu(w) \bar{c}\bar{\partial} \bar{X}^\nu(\bar{w}) - (\mu \leftrightarrow \nu)]_{\substack{w=0 \\ \bar{w}=0}} |0\rangle + \dots \end{aligned} \quad (7.5)$$

Then the anti-symmetric tensor field is transformed under the gauge transformation of Eq. (1.2) at the leading order as follows,

$$\delta B_{\mu\nu} = \partial_\mu \zeta_\nu - \partial_\nu \zeta_\mu. \quad (7.6)$$

Next consider the gauge transformation for an open string massless gauge mode generated by the same parameter of Eq. (7.3). The massless gauge field A_μ is contained in the open string field as

$$\begin{aligned} |\Psi\rangle &= -iA_\mu(x) \alpha_{-1}^\mu |1\rangle + \dots \\ &= A_\mu(x) [c\partial X^\mu(w)]_{w=0} |0\rangle + \dots \end{aligned} \quad (7.7)$$

From this equation, we can find the gauge transformation for the massless mode by

$$\delta A^\mu = i \langle 1 | c_0 \alpha_1^\mu (\delta |\Psi\rangle). \quad (7.8)$$

On a (group) symmetric background, only the trace part of the open string field gets transformed under the gauge transformation Eq. (4.3). The gauge modes belong to the adjoint representation, which is anti-symmetric and has no trace part in the present $O(n)$ case, and hence receives no transformation under the closed parameter gauge transformation. But, if a non-trivial Wilson line background appears (which gives rise to the coordinates of the D-branes), then, the gauge field components corresponding to the Cartan subalgebra become to receive the same form of gauge transformation as in Eq. (4.3) without taking trace.* Assuming this, the gauge transformation of a Cartan subalgebra component of the gauge field is given by

$$\delta A^\mu \propto {}_1\langle 1 | c_0^{(1)} \alpha_1^{\mu(1)} \langle U(2, 1^c) | |R^o(1, 2)\rangle |A^c\rangle_{1^c}, \quad (7.9)$$

with the understanding that $\langle U(2, 1^c) | |R^o(1, 2)\rangle$ now does not imply taking the trace.

*) Indeed, if A_μ develops a VEV $\langle A_\mu \rangle = \theta$ with θ taking a value in the Cartan subalgebra, the open-open-closed string interaction term will induce an open-closed transition vertex with the present $\langle U |$ replaced by $\langle U | \theta$. So the gauge transformation Eq. (4.3) get additional contribution of the form $\delta |\Psi\rangle_1 \propto \langle U(2, 1^c) | \theta | R^o(1, 2)\rangle |A^c\rangle_{1^c}$, which contains the transformation for the gauge field components of the Cartan subalgebra.

In order to evaluate this, it is convenient to map the ρ plane in Fig. 2 of the open-closed transition vertex to the z plane in Fig. 18 by the following Mandelstam mapping:

$$\rho = \ln(z - ib) + \ln(z + ib). \quad (7.10)$$

On the z plane, the real axis corresponds to the open string boundary. $Z_1 = +ib$ and $\hat{Z}_1 = -ib$ correspond to the closed string insertion points, and $Z_2 = \infty$ to the open string insertion point. We can evaluate the gauge transformation as follows:*) Substituting Eq. (7.3) into Eq. (7.9), and going to the z plane, we find

$$\begin{aligned} \delta A^\mu &\propto \frac{1}{2} \left\langle \zeta_\nu \left(\frac{1}{2} (X(Z_1) + X(\hat{Z}_1)) \right) \left(c\partial X^\nu(Z_1) + c\partial X^\nu(\hat{Z}_1) \right) c\partial c\partial X^\mu(Z_2) \right\rangle \\ &= -\zeta^\mu(x). \end{aligned} \quad (7.11)$$

The gauge transformations (7.6) and (7.11) are of the same form as those in the Dirac-Born-Infeld action, and so the open-closed string field theory possesses the symmetry of the Dirac-Born-Infeld action as a part of its gauge symmetry.

Acknowledgements

The authors would like to express their sincere thanks to K. Hashimoto, H. Hata, Y. Imamura, K. Kikkawa, H. Kunitomo, M. Maeno, S. Sawada, K. Suehiro and S. Yahikozawa for the valuable and helpful discussions. They also acknowledge the hospitality in the Summer Institute Kashikojima '96, in which this work was motivated, and Kyoto '97, where it was completed. T. K. is supported in part by the Grant-in-Aid for Scientific Research (#08640367) and T. T. by the Grant-in-Aid (#6844) from the Ministry of Education, Science, Sports and Culture.

Appendix A

— Relation between the LPP, KS and HIKKO vertices —

We prove Eq. (5.21) in this appendix. So the discussion is performed on the concrete case of two closed string vertices, but it will also clarify general relations between the three apparently different expressions for the vertices given by LPP, KS and HIKKO.

*) It can be evaluated also by using the oscillator representation, but we need the Neumann coefficients and very bored calculation. In Appendix B, we give the explicit Neumann coefficients for the open-closed transition vertex. They were partially given in Ref. 32), and completely in Refs. 33) and 28). The latter authors' derivations are more complicated than ours.

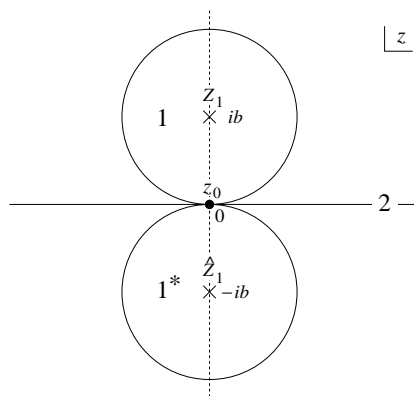

Fig. 18. z plane of the open-closed transition vertex $\langle U(2, 1^c) \rangle$.

Let us denote the LPP's D2 vertex $\langle v_{D_2}(1^c, 2^c; T) |$ and P2 vertex $\langle V_\infty(1^c, 2^c; \sigma_0) |$ unifiedly by

$$\langle v(1^c, 2^c; q) |. \quad (\text{A}\cdot 1)$$

Namely, this corresponds to the configuration Fig. 8 for real $q = a$ and Fig. 6 for imaginary $q = ia$, respectively. These ρ planes are mapped to the z planes in Fig. 10 and Fig. 11, respectively, via the mapping Eq. (5.17).

By the definition of the LPP vertex, we have

$$\begin{aligned} \langle v(1^c, 2^c; q) | \mathcal{O}(z) \cdots |1, 1\rangle_{1^c} |1, 1\rangle_{2^c} &= \left(\frac{dZ_1}{dw_1} \right)^{-1} \left(\frac{d\hat{Z}_1}{d\bar{w}_1} \right)^{-1} \left(\frac{dZ_2}{dw_2} \right)^{-1} \left(\frac{d\hat{Z}_2}{d\bar{w}_2} \right)^{-1} \\ &\times \left\langle \mathcal{O}(z) \cdots c(Z_1)c(\hat{Z}_1)c(Z_2)c(\hat{Z}_2) \right\rangle, \end{aligned} \quad (\text{A}\cdot 2)$$

for any operators $\mathcal{O}(z) \cdots$, where $\langle \rangle$ denotes the correlation function of the conformal field theory on the z plane and the factors

$$\left(\frac{dZ_r}{dw_r} \right)^{-1} = \lim_{z \rightarrow Z_r} \left(\frac{dz}{dw_r} \right)^{-1}, \quad \left(\begin{array}{l} Z_r = Z_1, \hat{Z}_1, Z_2, \hat{Z}_2 \\ w_r = w_1, \bar{w}_1, w_2, \bar{w}_2 \end{array} \right), \quad (\text{A}\cdot 3)$$

appear from the conformal mapping of the ghost factors contained in the Fock vacuum; $|1, 1\rangle = c(w=0)\bar{c}(\bar{w}=0)|0, 0\rangle$. Henceforth, we use the notation $|\mathbf{1}\rangle_{1^c, 2^c}$ to denote $|1, 1\rangle_{1^c} |1, 1\rangle_{2^c}$, for brevity.

On the other hand, Kunitomo and Suehiro have defined in Ref. 17) the vertex by the condition:

$$\begin{aligned} \langle V_{\text{KS}}(1^c, 2^c; z_0^{(s)}) | c(z)b(\tilde{z}) | \mathbf{1}\rangle_{1^c, 2^c} &= \frac{\langle b(z_0^{(s)})c(z)b(\tilde{z})c(Z_1)c(\hat{Z}_1)c(Z_2)c(\hat{Z}_2) \rangle}{\langle b(z_0^{(s)})c(Z_1)c(\hat{Z}_1)c(Z_2)c(\hat{Z}_2) \rangle} \\ &= \frac{1}{z - \tilde{z}} \frac{\tilde{z} - z_0^{(s)}}{z - z_0^{(s)}} \prod_{r=1, \hat{1}, 2, \hat{2}} \frac{z - Z_r}{\tilde{z} - Z_r}, \end{aligned} \quad (\text{A}\cdot 4)$$

where $z_0^{(s)}$ denotes one of the two interaction points $z_0^{(1)}$ and $z_0^{(2)}$ on the z plane, on which the KS vertex depends. The KS vertex satisfies the normalization condition $\langle V_{\text{KS}}(1^c, 2^c; z_0^{(s)}) | \mathbf{1}\rangle_{1^c, 2^c} = 1$ by this definition. It is important that, as KS noted, the information of the two point function of this type is enough to determine the vertex.

If we take $b(z_0^{(s)})c(z)b(\tilde{z})$ for $\mathcal{O}(z) \cdots$ in Eq. (A.2), we have

$$\begin{aligned} \langle v(1^c, 2^c; q) | b(z_0^{(s)})c(z)b(\tilde{z}) | \mathbf{1}\rangle_{1^c, 2^c} \\ = \left(\frac{dZ_1}{dw_1} \frac{d\hat{Z}_1}{d\bar{w}_1} \frac{dZ_2}{dw_2} \frac{d\hat{Z}_2}{d\bar{w}_2} \right)^{-1} \left\langle b(z_0^{(s)})c(z)b(\tilde{z})c(Z_1)c(\hat{Z}_1)c(Z_2)c(\hat{Z}_2) \right\rangle. \end{aligned} \quad (\text{A}\cdot 5)$$

Comparing this with Eq. (A.4), we see that the KS vertex $\langle V_{\text{KS}}(1^c, 2^c; z_0^{(s)}) |$ coincides with $\langle v(1^c, 2^c; q) | b(z_0^{(s)})$ up to a proportional factor depending on the moduli q :

$$\langle v(1^c, 2^c; q) | b(z_0^{(s)}) = \mathcal{N}(q) \langle V_{\text{KS}}(1^c, 2^c; z_0^{(s)}) |, \quad (\text{A}\cdot 6)$$

where $\mathcal{N}(q)$ can be found by multiplying $|\mathbf{1}\rangle_{1^c, 2^c}$ on both sides of this as

$$\begin{aligned} \mathcal{N}(q) &= \langle v(1^c, 2^c; q) | b(z_0^{(s)}) | \mathbf{1}\rangle_{1^c, 2^c} \\ &= \left(\frac{dZ_1}{dw_1} \frac{d\hat{Z}_1}{d\bar{w}_1} \frac{dZ_2}{dw_2} \frac{d\hat{Z}_2}{d\bar{w}_2} \right)^{-1} \left\langle b(z_0^{(s)}) c(Z_1) c(\hat{Z}_1) c(Z_2) c(\hat{Z}_2) \right\rangle. \end{aligned} \quad (\text{A}\cdot 7)$$

Each factor of this can be calculated as follows: using

$$\begin{aligned} \langle (b(z) c(Z_1) c(Z_2) c(Z_3) c(Z_4)) \rangle &= \det \begin{pmatrix} \frac{1}{z - Z_1} & \frac{1}{z - Z_2} & \frac{1}{z - Z_3} & \frac{1}{z - Z_4} \\ Z_1^2 & Z_2^2 & Z_3^2 & Z_4^2 \\ Z_1 & Z_2 & Z_3 & Z_4 \\ 1 & 1 & 1 & 1 \end{pmatrix} \\ &= - \frac{\prod_{1 \leq i < j \leq 4} (Z_i - Z_j)}{\prod_{r=1}^4 (z - Z_r)} \end{aligned} \quad (\text{A}\cdot 8)$$

and Eqs. (5-18) and (5-20) for $z_0^{(s)}$ and $Z_1, \hat{Z}_1, Z_2, \hat{Z}_2$, we find

$$\left\langle (b(z_0^{(s)}) c(Z_1) c(\hat{Z}_1) c(Z_2) c(\hat{Z}_2)) \right\rangle = - \frac{-2^6 q^2 (1 - q^2)}{2^2 q^2 (q^2 - 1)} = -2^4. \quad (\text{A}\cdot 9)$$

From Eq. (5-17) and $\rho = \alpha_r \ln w_r$ with $\alpha_r = +1$ (-1) for $r = 1, \hat{1}$ ($2, \hat{2}$), we have

$$\frac{dw_r}{dz} = \frac{-4\alpha_r z^2}{(z^2 + 2\alpha_r z + q^2)^2} \left(1 - \frac{q^2}{z^2} \right). \quad (\text{A}\cdot 10)$$

Putting $z = Z_1, \hat{Z}_1, Z_2, \hat{Z}_2$ and using (5-20), we find

$$\left(\frac{dZ_1}{dw_1} \frac{d\hat{Z}_1}{d\bar{w}_1} \frac{dZ_2}{dw_2} \frac{d\hat{Z}_2}{d\bar{w}_2} \right)^{-1} = \frac{1}{4^4} \prod_{r=1, \hat{1}, 2, \hat{2}} \left(1 - \frac{q^2}{Z_r^2} \right) = \frac{(1 - q^2)^2}{2^4 q^4}. \quad (\text{A}\cdot 11)$$

So we obtain

$$\mathcal{N}(q) = - \frac{(1 - q^2)^2}{q^4}. \quad (\text{A}\cdot 12)$$

Now that the relation between the LPP and KS vertices is established, we can next clarify the relation between the KS and HIKKO vertices. Guided by the $\text{OSP}(d, 2|2)$ symmetry, HIKKO defined the following ghost fields on the z plane in their papers 18), 19):

$$c_{\text{H}}(z) = \left(\frac{dz}{d\rho} \right)^{-1} c(z), \quad b_{\text{H}}(z) = \left(\frac{dz}{d\rho} \right) b(z), \quad (\text{A}\cdot 13)$$

or equivalently, in terms of the original fields on the ρ plane, by

$$c_{\text{H}}(z) = c(\rho), \quad b_{\text{H}}(z) = \left(\frac{d\rho}{dz} \right) b(\rho). \quad (\text{A}\cdot 14)$$

Namely, HIKKO treated the ghost fields as if c and b carry the weights 0 and +1, respectively, with which they could obtain OSp symmetric expression for the vertex.

We first note that the KS vertex realizes the following 2-point function for the HIKKO's ghost fields:

$$\begin{aligned}
& \langle V_{\text{KS}}(1^c, 2^c; z_0^{(1)}) | T c_{\text{H}}(z) b_{\text{H}}(\tilde{z}) | \mathbf{1} \rangle_{1^c, 2^c} \\
&= \langle V_{\text{KS}}(1^c, 2^c; z_0^{(1)}) | T c(z) b(\tilde{z}) | \mathbf{1} \rangle_{1^c, 2^c} \left(\frac{dz}{d\rho} \right)^{-1} \left(\frac{d\tilde{z}}{d\bar{\rho}} \right) \\
&= \frac{1}{z - \tilde{z}} \frac{z - z_0^{(2)}}{\tilde{z} - z_0^{(2)}}, \tag{A.15}
\end{aligned}$$

as well as the same form of equation with the two interaction points $z_0^{(1)}$ and $z_0^{(2)}$ being interchanged, where use has been made of the definitions of KS vertex and HIKKO's field, Eqs. (A.4) and (A.13), and the relation:

$$\frac{d\rho}{dz} = \frac{4(z - z_0^{(1)})(z - z_0^{(2)})}{\prod_{r=1, \hat{1}, 2, \hat{2}} (z - Z_r)}. \tag{A.16}$$

Looking at this 2-point function in Eq. (A.15), we can guess that the KS vertex is given in the form:

$$\langle V_{\text{KS}}(1^c, 2^c; z_0^{(1)}) | = {}_{2^c, 1^c} \langle \tilde{\mathbf{1}} | \left(\sum_{r=1, \hat{1}, 2, \hat{2}} \frac{b_0^{(r)}}{\alpha_r} \right) \exp(E_{\text{H}}(1^c, 2^c)) c_{\text{H}}(z_0^{(2)}) \tag{A.17}$$

(and the same form equation with $z_0^{(1)}$ and $z_0^{(2)}$ interchanged), where E_{H} is the HIKKO's OSp symmetric quadratic operator written by annihilation operators alone, the explicit form of which will be given later in Eq. (5.22). The vacuum ${}_{2^c, 1^c} \langle \tilde{\mathbf{1}} |$ here is the abbreviation for ${}_{2^c} \langle \tilde{\mathbf{1}}, \tilde{\mathbf{1}} | {}_{1^c} \langle \tilde{\mathbf{1}}, \tilde{\mathbf{1}} |$, and the bra vacuum $\langle \tilde{\mathbf{1}}, \tilde{\mathbf{1}} |$ denotes $\langle \tilde{\mathbf{1}}, \tilde{\mathbf{1}} | = \langle 1, 1 | c_0 \bar{c}_0$ conjugate to the ket Fock vacuum $|1, 1\rangle$: $\langle \tilde{\mathbf{1}}, \tilde{\mathbf{1}} | 1, 1\rangle = 1$. Since the bra vacuum $\langle \tilde{\mathbf{1}}, \tilde{\mathbf{1}} |$ is annihilated by c_0 and \bar{c}_0 and the ket vacuum $|1, 1\rangle$ by b_0 and \bar{b}_0 , so we call c_0, \bar{c}_0 creation operators and b_0, \bar{b}_0 annihilation operators, henceforth.

From now on we prove Eq. (A.17); namely, the right-hand side of (A.17) also realizes the same 2-point function as in Eq. (A.15).

Noting that E_{H} is a quadratic form of annihilation operators alone, we have the following equation generally for operators \mathcal{O} linear in the creation and annihilation operators:

$$e^{E_{\text{H}}} \{ \mathcal{O}_1 \mathcal{O}_2 \cdots \} = \left\{ (\mathcal{O}_1 + [E_{\text{H}}, \mathcal{O}_1]) (\mathcal{O}_2 + [E_{\text{H}}, \mathcal{O}_1]) \cdots \right\} e^{E_{\text{H}}}. \tag{A.18}$$

Now introduce the following notations,

$$\begin{aligned}
\hat{\mathcal{O}} &\equiv \mathcal{O} + [E_{\text{H}}, \mathcal{O}] = \hat{\mathcal{O}}^{(-)} + \hat{\mathcal{O}}^{(+)}, \\
\hat{\mathcal{O}}^{(-)} &\equiv \mathcal{O}^{(-)}, \quad \hat{\mathcal{O}}^{(+)} \equiv \mathcal{O}^{(+)} + [E_{\text{H}}, \mathcal{O}^{(-)}], \tag{A.19}
\end{aligned}$$

where superscripts $(-)$ and $(+)$ denote the creation and annihilation operator parts, respectively. The hatted operators are also linear in the creation and annihilation operators. Applying the Wick theorem to the hatted operators $\hat{\mathcal{O}}$, we have

$$\begin{aligned} e^{E_H} \text{T}(\mathcal{O}_1 \mathcal{O}_2 \mathcal{O}_3 \cdots) &= \text{T}(\hat{\mathcal{O}}_1 \hat{\mathcal{O}}_2 \hat{\mathcal{O}}_3 \cdots) e^{E_H} \\ &= \left(: \hat{\mathcal{O}}_1 \hat{\mathcal{O}}_2 \hat{\mathcal{O}}_3 \cdots : + : \overline{\hat{\mathcal{O}}_1 \hat{\mathcal{O}}_2} \hat{\mathcal{O}}_3 \cdots : + \cdots \right) e^{E_H}, \end{aligned} \quad (\text{A}\cdot 20)$$

with the contraction of the $\hat{\mathcal{O}}$ operators given by

$$\overline{\hat{\mathcal{O}}_1 \hat{\mathcal{O}}_2} = {}_{2^c, 1^c} \langle \tilde{\mathbf{1}} | \text{T} \hat{\mathcal{O}}_1 \hat{\mathcal{O}}_2 | \mathbf{1} \rangle_{1^c, 2^c} = \overline{\hat{\mathcal{O}}_1 \hat{\mathcal{O}}_2} + [E_H, \mathcal{O}_1^{(-)}, \mathcal{O}_2^{(-)}]. \quad (\text{A}\cdot 21)$$

This contraction of the hatted operators is of just the same form as defined by HIKKO. Then, we obtain

$$\begin{aligned} {}_{2^c, 1^c} \langle \tilde{\mathbf{1}} | \left(\sum_r \frac{b_0^{(r)}}{\alpha_r} \right) e^{E_H} \text{T} c_H(z_0^{(2)}) c_H(z) b_H(\tilde{z}) \\ = {}_{2^c, 1^c} \langle \tilde{\mathbf{1}} | \left(\sum_r \frac{b_0^{(r)}}{\alpha_r} \right) \left[\overline{\hat{c}_H(z_0^{(2)}) \hat{c}_H(z) \hat{b}_H(\tilde{z})} + \hat{c}_H(z_0^{(2)}) \overline{\hat{c}_H(z) \hat{b}_H(\tilde{z})} \right. \\ \left. + : \hat{c}_H(z_0^{(2)}) \hat{c}_H(z) \hat{b}_H(\tilde{z}) : \right] e^{E_H}. \end{aligned} \quad (\text{A}\cdot 22)$$

If E_H is such a quadratic form that it realizes

$$\overline{\hat{c}_H(z) \hat{b}_H(\tilde{z})} = \frac{1}{z - \tilde{z}}, \quad (\text{A}\cdot 23)$$

then, with the help of the formula (A·20), Eq. (A·22) becomes

$$= {}_{2^c, 1^c} \langle \tilde{\mathbf{1}} | \left(\sum_r \frac{b_0^{(r)}}{\alpha_r} \right) \left[-\frac{1}{z_0^{(2)} - \tilde{z}} \hat{c}_H(z) + \frac{1}{z - \tilde{z}} \hat{c}_H(z_0^{(2)}) + : \hat{c}_H(z_0^{(2)}) \hat{c}_H(z) \hat{b}_H(\tilde{z}) : \right] e^{E_H}.$$

Acting the Fock vacuum $|\mathbf{1}\rangle_{1^c, 2^c}$ on this equation, we have

$$\begin{aligned} {}_{2^c, 1^c} \langle \tilde{\mathbf{1}} | \left(\sum_r \frac{b_0^{(r)}}{\alpha_r} \right) e^{E_H} c_H(z_0^{(2)}) \text{T} c_H(z) b_H(\tilde{z}) | \mathbf{1} \rangle_{1^c, 2^c} \\ = {}_{2^c, 1^c} \langle \tilde{\mathbf{1}} | \left(\sum_r \frac{b_0^{(r)}}{\alpha_r} \right) \left[-\frac{1}{z_0^{(2)} - \tilde{z}} \hat{c}_H(z) + \frac{1}{z - \tilde{z}} \hat{c}_H(z_0^{(2)}) \right] | \mathbf{1} \rangle_{1^c, 2^c}. \end{aligned} \quad (\text{A}\cdot 24)$$

Since $b_0^{(r)}$ are the annihilation operators, only the c_0 mode part in $\hat{c}_H(z)$ and $\hat{c}_H(z_0^{(2)})$ can survive the VEV in the the right hand side. Noting

$$c_H(z) = \alpha_r \sum_n c_n^{(r)} e^{in\rho r} = \alpha_r c_0^{(r)} + (\text{non-zero modes}), \quad (\text{A}\cdot 25)$$

we have

$${}_{2^c, 1^c} \langle \tilde{\mathbf{1}} | \left(\sum_r \frac{b_0^{(r)}}{\alpha_r} \right) \hat{c}_H(z) | \mathbf{1} \rangle_{1^c, 2^c} = {}_{2^c, 1^c} \langle \tilde{\mathbf{1}} | \left(\sum_r \frac{b_0^{(r)}}{\alpha_r} \right) \hat{c}_H(z_0^{(2)}) | \mathbf{1} \rangle_{1^c, 2^c} = 1, \quad (\text{A}\cdot 26)$$

so that Eq. (A·24) finally becomes

$$= -\frac{1}{z_0^{(2)} - \tilde{z}} + \frac{1}{z - \tilde{z}} = \frac{1}{z - \tilde{z}} \frac{z - z_0^{(2)}}{\tilde{z} - z_0^{(2)}}. \quad (\text{A}\cdot 27)$$

This is just equal to the right hand side of Eq. (A·15) and therefore, the Eq. (A·17) is proved. E_H is determined by the requirement of

$$\overline{c_H(z) b_H(\tilde{z})} + [E_H, c_H(z)], b_H(\tilde{z}) = \frac{1}{z - \tilde{z}}. \quad (\text{A}\cdot 28)$$

But HIKKO already showed that such E_H is just given by the OSp invariant quadratic form given in Eq. (5·22).^{18), 19)}

Combining Eqs. (A·17) and (A·6), we find a direct relation between the LPP and HIKKO vertices:

$$\langle v(1^c, 2^c; q) | b(z_0^{(1)}) = \mathcal{N}(q) {}_{2^c, 1^c} \langle \tilde{\mathbf{1}} | \left(\sum_{r=1, \hat{1}, 2, \hat{2}} \frac{b_0^{(r)}}{\alpha_r} \right) \exp(E_H(1^c, 2^c)) c_H(z_0^{(2)}). \quad (\text{A}\cdot 29)$$

The same form equation with $z_0^{(1)}$ and $z_0^{(2)}$ interchanged also holds. To convert this into the desired Eq. (5·21), we note that

$$\begin{aligned} \langle v(1^c, 2^c; q) | b(z_0^{(1)}) c_H(z_0^{(1)}) &= \lim_{z \rightarrow z_0^{(1)}} \langle v(1^c, 2^c; q) | b(z_0^{(1)}) c(z) \left(\frac{dz}{d\rho} \right)^{-1} \\ &= \lim_{z \rightarrow z_0^{(1)}} \langle v(1^c, 2^c; q) | \left(\frac{1}{z_0^{(1)} - z} + : b(z_0^{(1)}) c(z) : \right) \frac{4(z - z_0^{(1)})(z - z_0^{(2)})}{\prod_{r=1, \hat{1}, 2, \hat{2}} (z - Z_r)} \\ &= \frac{2}{q(1 - q^2)} \cdot \langle v(1^c, 2^c; q) |, \end{aligned} \quad (\text{A}\cdot 30)$$

where we have used Eq. (A·16), and Eqs. (5·18) and (5·20) for $z_0^{(s)}$ and $Z_1, \hat{Z}_1, Z_2, \hat{Z}_2$. Thus, multiplying both sides of Eq. (A·29) by $-c_H(z_0^{(1)})$, we can really obtain the desired expression Eq. (5·21) with the coefficient

$$N(q) = -\frac{(1 - q^2)^2}{q^4} \times \frac{q(1 - q^2)}{2} \times (-1) = \frac{(1 - q^2)^3}{2q^3}. \quad (\text{A}\cdot 31)$$

Appendix B

— Neumann coefficients for the open-closed transition vertex —

The ρ plane of Eq. (3.1) can be mapped to the whole z plane by the Mandelstam mapping (7.10). The interaction point is given by

$$\frac{d\rho}{dz} = 0 \implies \tau_0 = \ln b^2 \quad (z_0 = 0). \quad (\text{B}\cdot 1)$$

The Neumann function on the z plane is given by

$$N(\rho, \rho') = \ln |z - z'| + \ln |z - z'^*|. \quad (\text{B}\cdot 2)$$

To define the Neumann coefficients, we need to know some boundary conditions for the Neumann function. From the Mandelstam mapping (7.10), we have

$$\begin{aligned} \frac{\partial}{\partial \tau} N(\rho, \rho') &= \left(\sum_{r=1,1^*} \frac{1}{z - Z_r} \right)^{-1} \frac{1}{2} \left[\frac{1}{z - z'} + \frac{1}{z - z'^*} \right] \\ &\quad + \left(\sum_{r=1,1^*} \frac{1}{z^* - Z_r^*} \right)^{-1} \frac{1}{2} \left[\frac{1}{z^* - z'^*} + \frac{1}{z^* - z'} \right], \quad (\text{B}\cdot 3) \end{aligned}$$

from which we find the following boundary conditions:

$$\frac{\partial}{\partial \tau} N(\rho, \rho') \longrightarrow \begin{cases} 0 & (z \longrightarrow Z_1, \hat{Z}_1) \\ -\frac{2}{\alpha_2} & (z \longrightarrow Z_2 = \infty) \\ \infty & (z \longrightarrow z_0) \end{cases}, \quad (\text{B}\cdot 4)$$

where and hereafter we take $\alpha_1 = \alpha_{1^*} = 1$ and $\alpha_2 = -2$. Taking these boundary conditions into account, we can define the Neumann coefficients using the Fourier expansion in the ρ coordinates as follows:

$$\begin{aligned} N(\rho_r, \rho'_s) &= - \sum_{n \geq 1} \frac{1}{n} e^{-n|\tau_1 - \tau'_1|} \cos[n(\sigma_1 - \sigma'_1)] + \max(\tau_1, \tau'_1) \\ &\quad + \frac{1}{2} \sum_{n, m \geq 0} e^{n\tau_1 + m\tau'_1} \left(\bar{N}_{nm}^{11} e^{i(n\sigma_1 + m\sigma'_1)} + \bar{N}_{nm}^{11^*} e^{i(n\sigma_1 - m\sigma'_1)} + \bar{N}_{nm}^{1^*1} e^{i(-n\sigma_1 + m\sigma'_1)} \right. \\ &\quad \left. + \bar{N}_{nm}^{1^*1^*} e^{i(-n\sigma_1 - m\sigma'_1)} \right) \quad (r = 1, s = 1) \\ &= - \sum_{n \geq 1} \frac{2}{n} e^{-n|\tau_2 - \tau'_2|} \cos(n\sigma_2) \cos(n\sigma'_2) + 2 \max(\tau_2, \tau'_2) \\ &\quad - 2 \sum_{n, m \geq 0} \bar{N}_{nm}^{22} e^{n\tau_2 + m\tau'_2} \cos(n\sigma_2) \cos(m\sigma'_2) - 2\tau_2 - 2\tau'_2 \quad (r = 2, s = 2) \\ &= \sum_{n, m \geq 0} e^{n\tau_1 + m\tau'_2} \left(\bar{N}_{nm}^{12} e^{in\sigma_1} + \bar{N}_{nm}^{1^*2} e^{-in\sigma_1} \right) \cos(n\sigma'_2) - 2\tau'_2 \quad (r = 1, s = 2) \\ &= \sum_{n, m \geq 0} e^{n\tau_2 + m\tau'_1} \left(\bar{N}_{nm}^{21} e^{in\sigma'_1} + \bar{N}_{nm}^{21^*} e^{-in\sigma'_1} \right) \cos(n\sigma_2) - 2\tau_2 \quad (r = 2, s = 1). \quad (\text{B}\cdot 5) \end{aligned}$$

Now, introduce a function,³²⁾

$$M(\rho, \rho') = \left(\frac{\partial}{\partial \tau} + \frac{\partial}{\partial \tau'} \right) N(\rho, \rho'). \quad (\text{B}\cdot 6)$$

From (B\cdot 3), this function is rewritten as

$$M(\rho, \rho') = \frac{1}{4\alpha_1} \left[-b^2 \left(\frac{1}{z} + \frac{1}{z^*} \right) \left(\frac{1}{z'} + \frac{1}{z'^*} \right) + 4 \right]. \quad (\text{B}\cdot 7)$$

Using the Mandelstam mapping Eq. (7\cdot 10), we can expand z by the ρ -plane coordinates:

$$\begin{aligned} \frac{b}{2} \left(\frac{1}{z} + \frac{1}{z^*} \right) &= \sum_{n \geq 1} \frac{(2n-1)!!}{(2n)!!} e^{n\tau_1} \sin n\sigma_1 \\ &= \sum_{n \geq 0} \frac{(2n-1)!!}{(2n)!!} e^{(2n+1)\tau_2} \cos[(2n+1)\sigma_2], \end{aligned} \quad (\text{B}\cdot 8)$$

where use has been made of the formula

$$(1-x)^{-\frac{1}{2}} = \sum_{n=0}^{\infty} \frac{(2n-1)!!}{(2n)!!} x^n, \quad (|x| < 1). \quad (\text{B}\cdot 9)$$

Substituting this into Eq. (B\cdot 7), we obtain

$$\begin{aligned} M(\rho, \rho') &= \frac{1}{\alpha_1} + \sum_{n, m \geq 0} e^{n\tau_1 + m\tau'_1} \frac{1}{4\alpha_1} \frac{(2n-1)!!}{(2n)!!} \frac{(2m-1)!!}{(2m)!!} \left(e^{i(n\sigma_1 + m\sigma'_1)} - e^{i(n\sigma_1 - m\sigma'_1)} \right. \\ &\quad \left. - e^{i(-n\sigma_1 + m\sigma'_1)} + e^{i(-n\sigma_1 - m\sigma'_1)} \right) \quad (r=1, s=1) \\ &= -\frac{2}{\alpha_2} + \sum_{n, m \geq 0} \frac{2}{\alpha_2} \frac{(2n-1)!!}{(2n)!!} \frac{(2m-1)!!}{(2m)!!} e^{(2n+1)\tau_2 + (2m+1)\tau'_2} \\ &\quad \times \cos[(2n+1)\sigma_2] \cos[(2m+1)\sigma'_2] \quad (r=2, s=2) \\ &= -\frac{2}{\alpha_2} + \sum_{n, m \geq 0} e^{n\tau_1 + (2m+1)\tau'_2} \frac{i}{2\alpha_1} \frac{(2n-1)!!}{(2n)!!} \frac{(2m-1)!!}{(2m)!!} \\ &\quad \times \left(e^{in\sigma_1} - e^{-in\sigma_1} \right) \cos[(2m+1)\sigma'_2] \quad (r=1, s=2) \\ &= -\frac{2}{\alpha_2} + \sum_{n, m \geq 0} e^{(2n+1)\tau_2 + m\tau'_1} \frac{i}{2\alpha_1} \frac{(2n-1)!!}{(2n)!!} \frac{(2m-1)!!}{(2m)!!} \\ &\quad \times \left(e^{im\sigma'_1} - e^{-im\sigma'_1} \right) \cos[(2n+1)\sigma_2] \quad (r=2, s=1). \end{aligned} \quad (\text{B}\cdot 10)$$

From Eqs. (B\cdot 5), (B\cdot 6) and (B\cdot 10), we find the Neumann coefficients of the open-closed vertex as follows:

$$\begin{aligned} \bar{N}_{nm}^{11} &= \bar{N}_{nm}^{1^*1^*} = \frac{1}{2(n+m)} \frac{(2n-1)!!}{(2n)!!} \frac{(2m-1)!!}{(2m)!!}, \\ \bar{N}_{nm}^{11^*} &= \bar{N}_{nm}^{1^*1} = -\frac{1}{2(n+m)} \frac{(2n-1)!!}{(2n)!!} \frac{(2m-1)!!}{(2m)!!}, \end{aligned}$$

$$\begin{aligned}
\bar{N}_{2n+1,2m+1}^{22} &= \frac{1}{2(n+m+1)} \frac{(2n-1)!!}{(2n)!!} \frac{(2m-1)!!}{(2m)!!}, \\
\bar{N}_{n,2m+1}^{12} &= \bar{N}_{2m+1,n}^{21} = \frac{i}{2n-2m-1} \frac{(2n-1)!!}{(2n)!!} \frac{(2m-1)!!}{(2m)!!}, \\
\bar{N}_{n,2m+1}^{1*2} &= \bar{N}_{2m+1,n}^{21*} = -\frac{i}{2n-2m-1} \frac{(2n-1)!!}{(2n)!!} \frac{(2m-1)!!}{(2m)!!}, \\
\bar{N}_{2n,2m}^{22} &= 0.
\end{aligned} \tag{B·11}$$

This derivation of the Neumann coefficients up to here is more or less a review of Ref. 32). Note, however, that the components $\bar{N}_{n,2n}^{12}$ are not yet determined in this derivation, since they cannot appear in $M(\rho, \rho')$:

$$\left(\frac{\partial}{\partial \tau} + \frac{\partial}{\partial \tau'} \right) e^{n(\tau_1+2\tau_2)} = \frac{1}{\alpha_1} \left(\frac{\partial}{\partial \tau_1} - \frac{1}{2} \frac{\partial}{\partial \tau_2} \right) e^{n(\tau_1+2\tau_2)} = 0. \tag{B·12}$$

Substituting the above Neumann coefficients into Eq. (B·11), we can write the Neumann function with ρ and ρ' on the strings 1 and 2, respectively, as

$$\begin{aligned}
N(\rho, \rho') &= \sum_{n,m \geq 0} e^{n\tau_1+(2m+1)\tau_2} \left(\bar{N}_{n,2m+1}^{12} e^{in\sigma_1} + \bar{N}_{n,2m+1}^{1*2} e^{-in\sigma_1} \right) \cos[(2m+1)\sigma_2] \\
&\quad + \sum_{n \geq 1} e^{n(\tau_1+2\tau_2')} \left(\bar{N}_{n,2n}^{12} e^{in\sigma_1} + \bar{N}_{n,2n}^{1*2} e^{-in\sigma_1} \right) \cos(2n\sigma_2) - 2\tau_2.
\end{aligned} \tag{B·13}$$

Considering the Mandelstam mapping Eq. (7·10) and the reflection symmetry with respect to the imaginary axis of the z -plane, we find that the transformation $z' \rightarrow -z'^*$ corresponds to the transformation $\sigma_2 \rightarrow \pi - \sigma_2$. Then, it follows that

$$\begin{aligned}
\tilde{N}(\rho, \rho') &\equiv \ln |z + z'| + \ln |z + z'^*| \\
&= - \sum_{n,m \geq 0} e^{n\tau_1+(2m+1)\tau_2} \left(\bar{N}_{n,2m+1}^{12} e^{in\sigma_1} + \bar{N}_{n,2m+1}^{1*2} e^{-in\sigma_1} \right) \cos[(2m+1)\sigma_2] \\
&\quad + \sum_{n \geq 1} e^{n(\tau_1+2\tau_2')} \left(\bar{N}_{n,2n}^{12} e^{in\sigma_1} + \bar{N}_{n,2n}^{1*2} e^{-in\sigma_1} \right) \cos(2n\sigma_2) - 2\tau_2.
\end{aligned} \tag{B·14}$$

Combining Eqs. (B·13) and (B·14), we find

$$\begin{aligned}
N(\rho, \rho') + \tilde{N}(\rho, \rho') &= 2 \sum_{n \geq 1} e^{n(\tau_1+2\tau_2')} \left(\bar{N}_{n,2n}^{12} e^{in\sigma_1} + \bar{N}_{n,2n}^{1*2} e^{-in\sigma_1} \right) \cos(2n\sigma_2) - 4\tau_2.
\end{aligned} \tag{B·15}$$

On the other hand, we have another expression for this:

$$\begin{aligned}
N(\rho, \rho') + \tilde{N}(\rho, \rho') &= \ln |z^2 - z'^2| + \ln |z^2 - z'^2| \\
&= \ln \left| e^{\rho_1 + \frac{\tau_0}{\alpha_1}} - e^{-2\rho_2 + \frac{\tau_0}{\alpha_1}} \right| + \ln \left| e^{\rho_1 + \frac{\tau_0}{\alpha_1}} - e^{-2\rho_2^* + \frac{\tau_0}{\alpha_1}} \right| \\
&= -2 \sum_{n \geq 1} \frac{1}{n} e^{n(\tau_1+2\tau_2')} \cos(n\sigma_1) \cos(2n\sigma_2) + 2 \ln b^2 - 4\tau_2.
\end{aligned} \tag{B·16}$$

Comparing these two expressions, we find the remaining Neumann coefficients as follows,²⁸⁾

$$\bar{N}_{n,2n}^{12} = \bar{N}_{n,2n}^{1^*2} = -\frac{1}{2n}, \quad \bar{N}_{00}^{12} + \bar{N}_{00}^{1^*2} = 2 \ln b. \quad (\text{B}\cdot 17)$$

Finally, let us consider the components of $n = m = 0$. From Eq. (7·10) and (3·1), we find

$$\begin{aligned} \tau_1 &= \ln |z - Z_1| + \ln |z - Z_1^*| - \ln b^2, \\ \tau_2 &= -\frac{1}{2} \ln |z - Z_1| - \frac{1}{2} \ln |z - Z_1^*| + \frac{1}{2} \ln b^2. \end{aligned} \quad (\text{B}\cdot 18)$$

Substituting this into Eq. (B·5) and taking the limit $z, z' \rightarrow Z_r, Z_s$, we obtain

$$\bar{N}_{00}^{rs} = \ln b, \quad (r, s = 1, 1^*, 2). \quad (\text{B}\cdot 19)$$

They, however, do not appear and are actually irrelevant to the open-closed transition vertex because of the momentum conservation.

References

- [1] For a review, J. Polchinski, ‘‘Tasi Lectures on D-Branes’’, [hep-th/9611050](#).
- [2] T. Banks, W. Fischler, S.H. Shenker and L. Susskind, Phys. Rev. **D55** (1997), 5112.
- [3] N. Ishibashi, H. Kawai, Y. Kitazawa and A. Tsuchiya, Nucl. Phys. **B498** (1997), 467.
- [4] K. Hashimoto and H. Hata, Phys. Rev. **D56** (1997), 5179.
- [5] B. Zwiebach, ‘‘Oriented Open-Closed String Theory Revisited’’, [hep-th/9705241](#).
- [6] M.B. Green and J.H. Schwarz, Phys. Lett. **151B** (1985), 21.
- [7] H. Itoyama and P. Moxhay, Nucl. Phys. **B293** (1987), 685.
- [8] M.R. Douglas and B. Grinstein, Phys. Lett. **183B** (1987), 52.
- [9] C. Wendt, Nucl. Phys. **B314** (1989), 209.
- [10] T. Kugo and H. Terao, Phys. Lett. **208B** (1988), 416.
- [11] Y. Saitoh and Y. Tanii, Nucl. Phys. **B325** (1989), 161.
- [12] Y. Saitoh and Y. Tanii, Nucl. Phys. **B331** (1990), 744.
- [13] K. Kikkawa and S. Sawada, Nucl. Phys. **B335** (1990), 677.
- [14] T. Kugo and T. Takahashi, in preparation.
- [15] C.G. Callan, C. Lovelace, C.R. Nappi and S.A. Yost, Nucl. Phys. **B288** (1987), 525.
- [16] A. LeClair, M.E. Peskin and C.R. Preitschopf, Nucl. Phys. **B317** (1989), 411.
- [17] H. Kunitomo and K. Suehiro, Nucl. Phys. **B289** (1987), 157.
- [18] H. Hata, K. Itoh, T. Kugo, H. Kunitomo and K. Ogawa Phys. Rev. **D34** (1986), 2360.
- [19] H. Hata, K. Itoh, T. Kugo, H. Kunitomo and K. Ogawa Phys. Rev. **D35** (1987), 1318.
- [20] T. Kugo and B. Zwiebach, Prog. Theor. Phys. **87** (1992), 801.
- [21] W. Siegel, Phys. Lett. **142B** (1984), 276.
- [22] A. Neveu and P.C. West, Nucl. Phys. **B293** (1987), 266.
- [23] S. Uehara, Phys. Lett. **190B** (1987), 76.
- [24] T. Kugo, in Quantum Mechanics of Fundamental Systems 2, ed. by C. Teitelboim and J. Zanelli (Plenum Publishing Corporation, 1989).
- [25] L. Alvarez-Gaumé, C. Gomez, G. Moore and C. Vafa, Nucl. Phys. **B303** (1988), 411.
- [26] S.B. Giddings and E. Martinec, Nucl. Phys. **B278** (1986), 91.
- [27] T. Kugo and K. Suehiro, Nucl. Phys. **B337** (1990), 434.
- [28] J.A. Shapiro and C.B. Thorn, Phys. Rev. **D36** (1987), 432.
- [29] H. Hata and M.M. Nojori, Phys. Rev. **D36** (1987), 1193.
- [30] D. Friedam, E. Martinec and S. Shenker, Nucl. Phys. **B271** (1986), 93.
- [31] J. Dai, R.G. Leigh and J. Polchinski, Mod. Phys. Lett. **A4** (1989), 2073.
- [32] M. Kaku and K. Kikkawa, Phys. Rev. **D10** (1974), 1823.
- [33] M.B. Green and J.H. Schwarz, Nucl. Phys. **B243** (1984), 475.