

Aspects of ALE Matrix Models and Twisted Matrix Strings

David Berenstein, Richard Corrado, and Jacques Distler *

*Theory Group, Department of Physics
University of Texas at Austin
Austin TX 78712 USA*

Email: david@zippy.ph.utexas.edu
Email: rcorrado@zippy.ph.utexas.edu
Email: distler@golem.ph.utexas.edu

Abstract

We examine several aspects of the formulation of M(atr ix)-Theory on ALE spaces. We argue for the existence of massless vector multiplets in the resolved A_{n-1} spaces, as required by enhanced gauge symmetry in M-Theory, and that these states might have the correct gravitational interactions. We propose a matrix model which describes M-Theory on an ALE space in the presence of wrapped membranes. We also consider orbifold descriptions of matrix string theories, as well as more exotic orbifolds of these models, and present a classification of twisted matrix string theories according to Reid's exact sequences of surface quotient singularities.

*Research supported in part by the Robert A. Welch Foundation and NSF Grant PHY 9511632.

1. Introduction

Over the last year, a great deal of evidence supporting the M(atr ix)-Theory [1] description of M-Theory has been accumulated (*c.f.*, [2] and references therein). An area which seems more or less well understood is toroidal compactification, at least for tori of small dimension. The SYM on the dual torus [1, 3–5] description works well for T^d , $d \leq 3$, where the SYM is renormalizable. For T^4 and beyond, the resulting SYM is non-renormalizable, so a sensible definition must be given for the theory. Matrix descriptions of M-Theory compactified on T^4 and T^5 have been described [6–8] in terms of the interacting six-dimensional theories with $(0, 2)$ supersymmetry [9, 10] and attempts have been made to formulate similar models for T^6 [11–14]. These issues have recently been reviewed in [15, 16].

The study of M(atr ix)-Theory on curved manifolds is also extremely important. One particular case is “compactification” on an ALE space, which captures many of the interesting features of K3 compactifications of M-Theory. In the spirit of the original M(atr ix) conjecture, this theory appears to be described by the theory of D0-brane partons moving on the ALE space [17–20].

The aim of this paper is to provide more evidence for the consistency of the description of ALE compactifications of M-theory via ALE matrix models. These models are very different in spirit from the matrix model for compactification on $K3 \times S^1$ that was proposed in [21, 22]. In particular, in the case of the ALE models, the curved space is represented by the moduli space of flat directions in the target space, whereas in the $(0, 2)$ model of [21, 22], the K3 forms the base space of the theory. As yet, there is not much in the way of a connection between these two descriptions.

The outline of the paper is as follows. In section 2, we review the definition of ALE matrix models, considering the case of the A_{n-1} series in some detail. We then go on in section 3 to examine the realization of enhanced gauge symmetry within the matrix models and provide evidence in the A_{n-1} matrix model for the existence of the spacetime vector multiplets which remain massless in the blow-up, which are required for consistency with M-Theory.

In section 4, we discuss the existence and properties of wrapped membranes in the ALE matrix model, following Douglas [17]. We claim that the physics of the wrapped membranes is described by a quiver gauge theory that corresponds to a particular pattern of gauge symmetry breaking in the standard ALE matrix model. As evidence for our proposal, we show that states exist which are supersymmetric vacua of the interacting (internal) part of the theory, but that the ground state energy of the decoupled $U(1)$ part of the theory (which corresponds to the motion of the center of mass in the five transverse flat dimensions) is

non-zero. The dependence of the ground state energy on the D-term coefficients is that required for a BPS-saturated (massive) wrapped membrane state and the 16-fold degeneracy of the (non-supersymmetric) ground state yields the states of the seven-dimensional vector multiplet. We also find the expected Coulomb potential between membranes and antimembranes.

Further evidence for the existence of the massless vector multiplet states is provided in section 5, where we consider orbifold realizations of the ALE matrix quantum mechanics and matrix string theories. We also discuss these orbifold realizations in the context of Witten’s “new” gauge theories [23] and, in section 6, we find that the types of matrix models that one can produce by orbifolding occur according to Reid’s classification of exact sequences of surface quotient singularities. In section 7, we consider the dynamics of the massless vectors and argue that it is plausible that they have the correct gravitational interactions.

2. M(atr ix)-Theory on ALE Spaces

The construction of ALE matrix models is based on the hyperkähler quotient construction of supersymmetric sigma models with ALE target spaces [24, 25], as applied to D-brane effective worldvolume theories [26–28].

These models have their field content summarized by a quiver diagram representing the extended Dynkin diagram of one of the A - D - E Lie algebras. To each vertex is associated the group $U(Nk_i)$, where k_i is the Dynkin label of the i th vertex. In the field theory, the vertices are associated with six-dimensional vector multiplets, each of which transforms as the adjoint of the gauge group associated to the vertex, and as a singlet under the other groups. The edges of the quiver describe six-dimensional hypermultiplets that transform in the fundamental–anti-fundamental representations of the neighboring gauge groups, and as singlets of the other groups.

Matrix models are obtained from these gauge theories by a dimensional reduction of these theories to $0 + 1$ dimensions. The large N limit of the quantum mechanics should describe the infinite momentum frame limit of M-Theory on the ALE space, while the finite N QM is conjectured to describe the discrete light-cone quantization (DLCQ) of M-theory [29]. In a similar fashion, the dimensional reduction of the quantum mechanics to the $1 + 1$ -dimensional theory with base $S^1 \times \mathbb{R}$ [3] describes IIA string theory at finite coupling [30–32], as required by M-Theory–IIA duality [33, 9].

2.1. The A_{n-1} Series

Let us consider the explicit construction of the A_{n-1} series. The quiver diagram is shown in Figure 1. Since the $k_i = 1$, for each of the n vertices there is a $U(N)$ gauge group and a vector multiplet, V_i , transforming in the $(1, \dots, 1, \text{ad}(U(Nk_i)), 1, \dots, 1)$, whose bosonic content will be written as $(A_{\mu i}, a_i)$. For each edge, we have a hypermultiplet $H_{i,i+1}$ in the $(1, \dots, 1, Nk_i, \overline{Nk_{i+1}}, 1, \dots, 1)$ representation, whose chiral components have the bosonic content $(x_{i,i+1}, y_{i,i+1})$.

From this field content, we write down the most general action with flat Kähler metric and common gauge couplings. The allowed deformations of the theory are the addition to the lagrangian of F and D-terms for the diagonal $U(1)$ gauge fields,

$$\begin{aligned} D_i &= |x_{i-1,i}|^2 + |y_{i,i+1}|^2 - |x_{i,i+1}|^2 - |y_{i-1,i}|^2 + d_i \\ F_i &= x_{i-1,i}y_{i-1,i} - y_{i,i+1}x_{i,i+1} + f_i, \end{aligned} \tag{2.1}$$

where $\sum f_i = \sum d_i = 0$. In higher-dimensional field theories, in particular those obtained by further toroidal compactification, the addition of theta terms are also allowed. The hyperkähler quotient consists of projecting onto field configurations which are gauge invariant under the diagonal $U(1)$ s, such that the F and D-terms vanish. The gauge invariant complex coordinates are given by

$$\begin{aligned} u &= \prod x_{i,i+1} \\ v &= \prod y_{i,i+1} \\ w &= w_i = x_{i,i+1}y_{i,i+1}, \end{aligned} \tag{2.2}$$

where, from the vanishing of the F-terms in (2.1), all of the w_i are the same, modulo constant

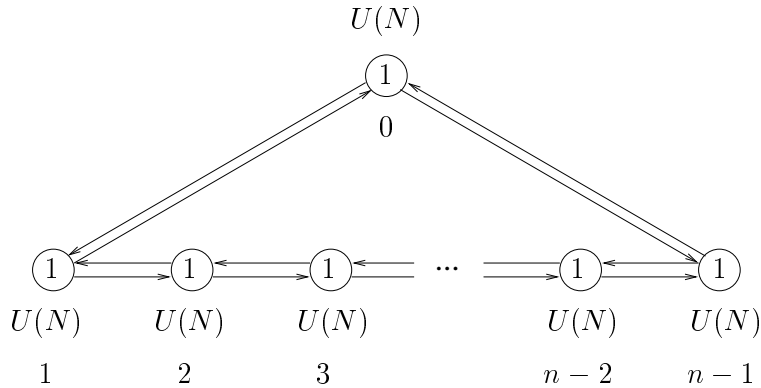

Figure 1: The A_{n-1} quiver diagram.

shifts on the moduli space of flat directions. It follows that u , v , and w satisfy

$$uv = P(w), \tag{2.3}$$

where $P(w)$ is a monic polynomial of degree n . We see that deformations by the D and F-terms in (2.1) correspond to the blowing up of the A_{n-1} singularity. As is conventional, we denote the ALE space by $\mathcal{M}_{\vec{\zeta}}$, where the $\vec{\zeta}$ are the blow-up parameters.

The low energy physics is described by quantum mechanics on the moduli space of flat directions. The Higgs branch corresponds to [17]

$$(\mathbb{R}^5 \times \mathcal{M}_{\vec{\zeta}})^N / S_N \tag{2.4}$$

where the \mathbb{R}^5 corresponds to the flat directions given by the global $U(1)$ under which none of the hypermultiplets transform. This describes the motion of N D0-branes on $\mathbb{R}^7 \times \mathcal{M}_{\vec{\zeta}}$, and by the M(atric) conjecture describes M-theory on $\mathbb{R}^7 \times \mathcal{M}_{\vec{\zeta}}$ in the infinite momentum frame. If we compactify one of the transverse coordinates to S^1 , we obtain a 1 + 1 dimensional field theory with

$$(\mathbb{R}^4 \times S^1 \times \mathcal{M}_{\vec{\zeta}})^N / S_N \tag{2.5}$$

as its Higgs branch, which describes the IIA string theory on the ALE space.

3. Massless Vector Multiplets in the Blow-up

Various issues concerning the ALE models are at hand. First, it is necessary to provide the full massless spectrum from the quantum mechanics of the blown-up space, as this must agree with the degrees of freedom expected from supergravity considerations. On the other hand, new massless states are expected to appear when the singularity is blown-down. These states are visible from the viewpoint of the ALE space as a description close to the singular point of the degeneration limit of a large K3 surface [34]. M[K3] is dual to Het[T^3] [9] and the degeneration limit we are considering is a point in the moduli space with enhanced gauge symmetry (see [35] and references therein). The blow-up modes correspond to Higgsing away these enhanced gauge groups, and so they form part of a vector multiplet in 7-dimensional physics.

For the case of the compact K3, these states all arise from 2-branes wrapped around the 22 homology 2-cycles of the K3. When a 2-cycle shrinks to zero-size, the corresponding state becomes massless and the gauge symmetry is enhanced. In the case of the ALE spaces, the non-compactness of the space modifies the analysis slightly. For example, in the case

of the A_{n-1} singularity, the contribution from homology generates $n(n-1)$ states in the root lattice of the enhanced gauge group. These states form 7-dimensional vector multiplets and become massive when the singularity is blown-up. They may be identified with bound states of 2-branes wrapping the \mathbb{P}^1 s of the blow-up. There are an additional $n-1$ states in the Cartan subalgebra which are localized at the singularity and remain massless in the blow-up. Additionally, there is a massless singlet state arising from the self-dual cohomology of the ALE. Since the SD form does not have compact support, the wavefunction of this state is not normalizable. The Cartan and singlet modes form massless 7-dimensional vector multiplets, so the enhanced symmetry group is $U(n)$.

All of these states should appear in the quantum mechanics [17, 18, 36]. In the following, we will use a localization argument to show that the states in the Cartan subalgebra exist and are localized near the singularity. We provide further evidence that these states are normalizable ground states of the quantum mechanics, and that there are exactly n of them for a single D0-brane moving on an A_{n-1} ALE space.

The number of massless vacua can be calculated in the following manner. We begin by removing the decoupled $U(1)$ and consider the case of a single D0-brane. Now, we can deform the theory by adding hypermultiplet mass terms. Without loss of generality, we can give the same mass to all of the hypermultiplets¹. This preserves $\mathcal{N} = 1$ supersymmetry and lifts the moduli space of vacua to a discrete set of points that solve the constraints in (2.1). The remaining F-terms for the diagonal $U(1)$ which are required to vanish are

$$\begin{aligned} x_{i,i+1}(a_i - a_{i+1} + m) &= 0 \\ y_{i,i+1}(a_i - a_{i+1} + m) &= 0. \end{aligned} \tag{3.1}$$

The constraints (3.1) require that the different $U(1)$ chiral multiplets in the blown-up ALE space acquire expectation values related to the mass perturbation. Only $n-1$ of these F-terms can be set to zero in this manner for generic values of the d_i and f_i . This constrains the last chiral field to be set to zero, which is the special point $u = v = 0$ in the moduli space of flat directions. Since there are exactly n roots of the polynomial $P(w) = 0$, there are n vacua. In the presence of the mass deformations, these vacua are normalizable, as there are no non-compact flat directions.

From the M-Theory considerations discussed previously, one expects that $n-1$ of these vacua should survive as normalizable states when the mass perturbation is set to zero. While it would certainly be advantageous to directly compute the Witten index in the non-compact

¹Any other combination of mass terms can be put into this form by shifting the values of the $U(1)$ chiral multiplets by a constant.

ALE space via similar methods as those in [37,38], this is bound to be a complicated process, as it must be done in terms of the projected coordinates, for which the action is quite non-linear.

In order to consider the normalizability of these bound states as the mass deformations are turned off, we will turn to the dual picture of the ALE matrix model as the strong-coupling limit of n D6-branes in the IIA theory [13]. In that system, there are indeed n states arising from the Cartan subalgebra of $U(n)$, but one of these states corresponds to center-of-mass motion. We do not expect this state to be normalizable, but the remaining $n - 1$ states which describe the relative motion of the D6-branes are. Therefore, as $m \rightarrow 0$ in the ALE matrix model, $n - 1$ normalizable states survive and there is one non-normalizable state, which corresponds to the non-normalizable singlet in the M-Theory picture that we discussed above.

The above counting of $n - 1$ normalizable states agrees with the familiar connection between supersymmetric quantum mechanics and differential topology [39]. As the supersymmetry algebra has a representation in terms of the deRham cohomology on the space of fields, we obtain $n - 1$ massless states from the $n - 1$ anti-self-dual forms on the A_{n-1} ALE space. These forms have compact support, so that the corresponding states are normalizable. We also obtain a single non-normalizable state from the self-dual form. Similar considerations for the D and E series quantum mechanics would indicate that they should also possess the same states as in the M-Theory construction. However, our mass deformation argument fails for the D and E series. In those cases, one can always change the values of the trace part of each of the a_i to compensate for the mass term. The F-terms (3.1) will not force us onto any special points in the moduli space of flat directions and we do not obtain any information on the counting of ground states. Without some version of an index theorem, we must be cautious about drawing conclusions with regard to the D and E series.

We note that the same deformations can be made in the $1 + 1$ matrix SYM. As the spatial circle is compact, the higher oscillator modes don't contribute to the index, so that a calculation of the index will again return the same number of ground states.

Now, for the normalizable vacuum states we found for the A_{n-1} series, the decoupled quantum mechanics (corresponding to the center-of-mass motion that we removed above) has 8 fermionic zero modes, where four act as creation operators and four act as destruction operators, giving a 2^4 degeneracy of states. These are exactly the states that form a massless vector multiplet in seven dimensions. Also, the different spaces that one obtains for higher-dimensional field theories will have the appropriate number of moduli. One obtains 3 from the D and F-terms (as corresponds to a 7-dimensional vector multiplet), and when the matrix

theory is further compactified on a d -torus, there are an additional d theta angles [5],

$$\theta_i^a \int F_{0i}^a, \quad (3.2)$$

where $\sum_a \theta_i^a = 0$.

On the other hand, the spectrum of states is continuous for the non-compact directions which are transverse to the ALE. These states are non-normalizable and are acted on by supersymmetry, giving 8 extra fermionic zero modes. In the spacetime picture, these states have a 2^8 degeneracy, so that they are identified as gravitons that propagate in the ALE spacetime. This is expected from supergravity considerations, since asymptotically the space is flat. The supersymmetry breaking occurs locally around the singularity, but far away from the origin, the SUSY is effectively restored.

As we see, the spectrum of low energy states for a single D0-brane already contains all of the states expected from supergravity considerations. This also agrees with the following argument in the 1+1 dynamics. In the far IR limit, the gauge coupling flows off to infinity and we recover a SCFT on the moduli space of flat directions, namely matrix string theory [32] on the ALE space. The twisted sector long strings are interpreted as bound states of once-wound strings. In the conformal field theory limit these sectors are decoupled. Moreover, the central charge of the SCFT in each long string is 12, as is expected for the light-cone degrees of freedom of the type IIA string. Hence, the model already has all of the infrared massless fields that are allowed. In particular, the blow-up modes of the ALE space must already exist in the SCFT. By construction, the projected variables that we are using in the field theory are gauge invariant, so the twisted sectors of the SCFT orbifold should already exist as states in the model and the blowing up of the singularity is manifest in these variables. This also suggests that the above argument of $n - 1$ normalizable vacua is also correct, as there are $n - 1$ twisted sectors in the free string limit. Moreover, it is reasonable to assume that one has bound states of N of these strings that are stable even when one relaxes the infrared limit, as these are identified with the S_N twisted sectors of the model. These long strings can attach themselves to the center of the ALE space, as argued previously, so it is reasonable to assume that these bound states exist in the full theory, *i.e.*, these states can carry arbitrary longitudinal momentum.

4. Wrapped Membrane States

Douglas [17] has proposed that the states corresponding to wrapped membranes in the matrix model are the “fractional branes” in the IIA description of D-branes at the orbifold point

of an ALE space. Some of the features of these states were discussed in [18, 40]. We would like to further investigate these wrapped membrane states in the matrix model. As we shall see, the gauge theory describing a wrapped membrane is a modification of the usual ALE matrix model. This gives a systematic prescription for performing calculations with wrapped membranes in the ALE matrix models.

Given the Kronheimer construction of the ALE space, one expects that a membrane wrapped around a \mathbb{P}^1 is associated with the corresponding root of the extended Dynkin diagram. One can also have bound states of membranes wrapped around different \mathbb{P}^1 , subject to the constraint that the the sum of all of the \mathbb{P}^1 s, weighted by the Dynkin indices, k_i , of the corresponding nodes of the extended Dynkin diagram, is homologically trivial. (The A_1 ALE space is a slightly degenerate case of this, as the two nodes of the Dynkin diagram correspond to the *same* \mathbb{P}^1 with opposite orientation. There are no bound states of wrapped membranes in this case.)

Instead of the standard ALE matrix model with a $U(Nk_i)$ gauge group associated to each node of the extended Dynkin diagram, we consider a more general quiver gauge theory with a $U(N_i) = U(Nk_i + r_i)$ gauge group at each vertex, and hypermultiplets in the (N_i, \bar{N}_j) associated to each link $\langle i, j \rangle$. As we shall see, this gauge theory describes N D0-branes propagating on a ALE space with r_i membranes wrapped around the i th \mathbb{P}^1 . After examining some of the features of this quiver gauge theory, we will see how it can be embedded in the standard ALE matrix model.

As a first check, we see that, if all of the $r_i = nk_i$ for some integer n , the membranes are wrapped around a homologically trivial cycle and hence can be unwrapped. The configuration decays to D0- branes and, indeed, from the point of view of the gauge theory, is equivalent to shifting the number of D0 branes, $N \rightarrow N + n$.

Still, in the gauge theory with $N_i = Nk_i$, even though there are no BPS-saturated configurations corresponding to wrapped membranes, there may be excited states of the gauge theory corresponding to asymptotically-separated membrane-antimembrane pairs. Indeed, this was the approach of Douglas *et. al.* [17, 18, 40].

More generally, when $\sum_i r_i \alpha_i$ is a root, we expect to find a (16-fold degenerate) ground state of the quantum mechanics, corresponding to the bound state of the corresponding collection of wrapped membranes. For other values of (r_0, \dots, r_r) (modulo (k_0, \dots, k_r)), we expect to find flat directions corresponding to the fact that the wrapped membranes can be separated.

The simplest case, which we consider in detail below, is that of the wrapped membrane in the A_1 theory (which is not expected to form bound states). Consider the matrix model

for a single wrapped membrane (one of the $r_i = 1$, the rest equal to zero). The Hamiltonian for this model still has a decoupled $U(1)$ which, as usual, has flat directions corresponding to the motion of the center of mass in the five transverse flat dimensions. As we shall see, the ground state energy in this decoupled $U(1)$ theory is nonzero (for nonzero D and F-terms), fermionic zero modes still give rise to the same 16-fold degeneracy of the ground state, as in the standard ALE matrix model. Though the ground state is not supersymmetric, the $U(1)$ theory is free – no fields are charged under the diagonal $U(1)$ – and hence we can compute the ground state energy reliably. As we shall see, its dependence on the D-term coefficients is just what is needed for a BPS-saturated (massive) wrapped membrane state.

A massive vector multiplet in 7 dimensions, like the massless one, has 16 propagating degrees of freedom. This degeneracy is already accounted for by the degeneracy of the (non-supersymmetric) ground state of the decoupled $U(1)$ theory. So the state in the internal part of the theory must a supersymmetric ground state, annihilated by all of the supercharges.

To be slightly more general, let us consider the A_1 model with gauge group $U(N) \times U(N + w)$, corresponding to w wrapped membranes. We assume that $F = 0$, so that only the D-terms, $D_{1,2}$, are non-zero. We can obtain a bound on the energy of the wrapped membrane state by rewriting the Hamiltonian in terms of the linear combinations of the above D-terms corresponding to the diagonal and internal $U(1)$ s. After computing traces, the relevant part of the Hamiltonian is

$$\begin{aligned} H_D &= ND_1^2 + (N + w)D_2^2 + N\zeta D_1 - (N + w)\zeta D_2 \\ &= \tilde{D}_1^2 + \tilde{D}_2^2 + \sqrt{N}\zeta\tilde{D}_1 - \sqrt{N + w}\zeta\tilde{D}_2, \end{aligned} \tag{4.1}$$

where we have defined normalized variables $\tilde{D}_1 = \sqrt{N} D_1$, $\tilde{D}_2 = \sqrt{N + w} D_2$. Since the decoupled $U(1)$ is the sum of the $U(1)$ s at each vertex, the corresponding D-term, $D_{\text{dec.}}$, is associated to the sum $D_1 + D_2$, we have the orthonormal pair

$$\begin{aligned} D_{\text{dec.}} &= \frac{1}{\sqrt{2N + w}} \left(\sqrt{N} \tilde{D}_1 + \sqrt{N + w} \tilde{D}_2 \right) \\ D_{\text{int.}} &= \frac{1}{\sqrt{2N + w}} \left(\sqrt{N + w} \tilde{D}_1 - \sqrt{N} \tilde{D}_2 \right), \end{aligned} \tag{4.2}$$

where $D_{\text{int.}}$ is the D-term for the “internal” (difference) $U(1)$. Now the component of the Hamiltonian which depends on $D_{\text{dec.}}$ is

$$H_{\text{dec.}} = D_{\text{dec.}} \left(D_{\text{dec.}} - \frac{w\zeta}{\sqrt{2N + w}} \right), \tag{4.3}$$

which gives a bound

$$E \geq \frac{w^2\zeta^2}{4(2N + w)} \tag{4.4}$$

on the Hamiltonian. Up to numerical factors, this is precisely what one expects for the energy of a membrane which is wrapped w times around a sphere and has longitudinal momentum $N + w/2$. The mass of the membrane depends linearly on the blow-up parameter, ζ , and is therefore proportional to the area of the sphere, as required.

Now, in the case of the singly-wrapped membrane, $w = 1$, let us show that the internal part of the theory is in a supersymmetric ground state and that there is a mass gap. Let the hypermultiplets be (x_{12}, y_{12}) and (x_{21}, y_{21}) , where x_{12}, y_{21} are $N \times (N + 1)$ and x_{21}, y_{12} are $(N + 1) \times N_1$ complex matrices. We would like to minimize the Hamiltonian. We can keep $F = 0$ by taking $x_{21} = y_{12} = 0$, then we must minimize

$$\frac{1}{4} \text{tr} [(x_{12}\bar{x}_{12} + y_{21}\bar{y}_{21} - \zeta)^2 + (\bar{x}_{12}x_{12} + \bar{y}_{21}y_{21} - \zeta)^2]. \quad (4.5)$$

As the matrix operators $x_{12}\bar{x}_{12}$ and $\bar{x}_{12}x_{12}$ are positive, isospectral, and hermitian, we will take them to be diagonal and with ordered eigenvalues. The operator $\bar{x}_{12}x_{12}$ has one zero eigenvalue. Similarly, $y_{21}\bar{y}_{21}$ and $\bar{y}_{21}y_{21}$ are isospectral. Solution of the D-terms of the interacting piece will require that the sums

$$\begin{aligned} x_{12}\bar{x}_{12} + y_{21}\bar{y}_{21} &= A \cdot \mathbf{1}_N \\ \bar{x}_{12}x_{12} + \bar{y}_{21}y_{21} &= B \cdot \mathbf{1}_{N+1}, \end{aligned} \quad (4.6)$$

are proportional to the identity. Since the traces of these operators are equal, we must have $NA = (N + 1)B$, so that (4.5) becomes

$$\frac{1}{4} \left[\frac{N(2N + 1)}{N + 1} A^2 - 4N\zeta A + (2N + 1)\zeta^2 \right]. \quad (4.7)$$

This is minimized by

$$A = \frac{2\zeta(N + 1)}{2N + 1} \quad (4.8)$$

and the bound obtained is

$$E = \frac{\zeta^2}{4(2N + 1)}, \quad (4.9)$$

which agrees with our earlier result (4.4).

By again examining the trace of the sums in (4.6), we find that the eigenvalues of $x_{12}\bar{x}_{12}$ and $y_{21}\bar{y}_{21}$ are in arithmetic progression,

$$x_{12}\bar{x}_{12} = \text{diag} \left(\frac{NA}{N + 1}, \frac{(N - 1)A}{N + 1}, \dots, \frac{A}{N + 1} \right), \quad (4.10)$$

while the eigenvalues of $y_{21}\bar{y}_{21}$ are in the opposite order. Similarly,

$$\bar{x}_{12}x_{12} = \text{diag} \left(\frac{NA}{N+1}, \frac{(N-1)A}{N+1}, \dots, \frac{A}{N+1}, 0 \right), \quad (4.11)$$

with $\bar{y}_{21}y_{21}$ in the opposite ordering. This configuration breaks the interacting gauge group completely, so the states in the (gauge theory) vector multiplets are massive. Similarly, as the hypermultiplet appear squared in the non-vanishing D-terms, the hypermultiplets are also massive. Hence, the system has a mass gap, as expected.

Now, the above scheme for constructing a solution can fail for wrapping number $w = 2$ and N odd (so that we cannot construct a pair of branes separated from one another to satisfy the bound). In that case, the ranks of the matrices $x_{12}\bar{x}_{12}$ and $\bar{x}_{12}x_{12}$ will differ by 2 and they will both have an odd number of entries. Since $\bar{x}_{12}x_{12}$ now has two zero eigenvalues, we must find that all eigenvalues come in pairs. As the total number of eigenvalues is odd, the matrices on the left-hand side of (4.6) can no longer both be proportional to the identity. This should be taken as evidence that two wrapped membranes do not form a bound state. The results of [37,38] show that the $\mathcal{N} = 2$, $U(N)$ vector multiplet quantum mechanics does not have a bound state. One is therefore led to conjecture that the only bound states in our system will be those corresponding to the massive states in the adjoint of the enhanced gauge group, with an arbitrary number of D0-branes attached.

Now that we have seen some of the features of the wrapped membrane matrix model, let us see how it can be recovered from a particular limit of the standard ALE matrix model. Consider a limit of the standard matrix model in which the $U(Nk_i)$ gauge symmetry at the i^{th} node is broken to $(U(N_1k_i + 1) \times U(N_2k_i - 1))$, with $N_1 + N_2 = N$. This corresponds to having a wrapped membrane and an anti-wrapped membrane around the i^{th} \mathbb{P}^1 . Far out on the Coulomb branch, the membrane and anti-wrapped membrane are far apart in spacetime. The quantum corrections to the potential, obtained by integrating out the heavy strings which connect the membranes, vanish for large separation. So, in the limit in which the wrapped membrane and anti-wrapped membrane are infinitely far apart, the Hamiltonian splits into two pieces, each of which is of precisely the form of the matrix model we have proposed. More general gauge symmetry breaking patterns correspond to more complicated configurations of wrapped and anti-wrapped membranes around various \mathbb{P}^1 s.

We will now use this formalism to compute the interaction between a membrane and an anti-wrapped membrane. For the A_1 case, consider the standard $U(N) \times U(N)$ quiver gauge theory, with the gauge symmetry broken to

$$(U(N_1) \times U(N_2)) \times (U(N_1 + 1) \times U(N_2 - 1)), \quad (4.12)$$

where $N_1 + N_2 = N$. Our notation is such that the $U(N)$ of each vertex in the quiver diagram is broken to one of the factors in parentheses. While the membrane states that we have considered to this point have been associated with the $U(N_1) \times U(N_1 + 1)$ component of the gauge group (4.12), the anti-wrapped membranes are associated with the $U(N_2) \times U(N_2 - 1)$ component. The crucial distinction is the difference in the VEVs taken in the $U(1)$ s at the different vertices. The membrane–anti-wrapped membrane solution occurs when all of the hypermultiplets vanish and has mass squared proportional to $(M_P^{(7)})^4 r^2 - \zeta$, where r is the separation between the membranes. Integrating out the hypermultiplets in the quantum theory will induce a potential

$$\begin{aligned}
& 4\sqrt{(M_P^{(7)})^4 r^2 + \zeta} + 4\sqrt{(M_P^{(7)})^4 r^2 - \zeta} - 8(M_P^{(7)})^2 r \\
& \sim -\frac{2\zeta^2}{(M_P^{(7)})^6 r^3} + rO((\zeta/r^2)^3).
\end{aligned} \tag{4.13}$$

This is the Coulomb potential expected for BPS objects whose mass and charge are proportional to ζ .

The results that we have presented above show that these states can carry an arbitrary amount of longitudinal momentum and seem to have the right properties for an interpretation as wrapped membrane states. The study of these states in more detail, as well as the massless states lying in the Cartan algebra that we discussed in section 3, seems very promising. In particular, the ground states describing the wrapped membranes seem to exhibit a very interesting structure that should be exploited to extract more information about the structure of the ALE matrix models.

5. Considerations from M(atrix) Orbifolds

When one considers \mathbb{C}^2/Γ orbifold string theories, the orbifolding procedure introduces new twisted sectors which serve to restore the modular invariance of the partition function. Furthermore, for $\Gamma = \mathbb{Z}_n$, there arises a quantum \mathbb{Z}_n symmetry of the twisted fields. Orbifolding with respect to this quantum symmetry reproduces the original unorbifolded theory.

As the blow-up parameters transform non-trivially under the quantum symmetry, blowing up the singularity explicitly breaks the quantum symmetry. We can describe the blow-ups via the hyperkähler quotient construction of the A_{n-1} ALE spaces. The quantum symmetry is always generated by the outer automorphisms of the Lie algebra. For the A_{n-1} case at hand, these permute the roots in a fashion which is represented by clock-shifts on the extended Dynkin diagram in Figure 1. In terms of the ALE matrix model, this corresponds

to a clock-shift on the vectors and hypermultiplets,

$$\begin{aligned} V_i &\rightarrow V_{i+k} \\ H_{i,i+1} &\rightarrow H_{i+k,i+k+1}, \end{aligned} \tag{5.1}$$

which leaves the action invariant. In this manner, the quantum symmetry also acts on the F and D-terms by the same clock-shifts.

Now the clock-shifts in (5.1) correspond to the representations of \mathbb{Z}_n on the fields. The vacua we found also transform into one another, via

$$|\phi_i \rangle \rightarrow |\phi_{i+k} \rangle, \tag{5.2}$$

as each corresponds to which pair $(x_{i,i+1}, y_{i,i+1}) = 0$. We note that there is one state that transforms invariantly under the transformation, namely $\sum_i |\phi_i \rangle$. This is the singlet state discussed in section 3. This correspondence provides further evidence that the states that we have constructed are indeed the ones corresponding to the Cartan subalgebra of $U(n)$.

We note again that these considerations are independent of whether we are working within the quantum mechanics or in the 1+1 field theory. We therefore obtain consistent descriptions of both M-Theory and the IIA string on the ALE space.

Recently, Witten [23] examined the new physics which arises in certain exotic orbifolds of M-Theory, as well as a matrix model description of a class of such models. Witten considers M-theory on $(\mathbb{C}^2 \times S^1)/\Gamma$, for which it turns out that one can obtain a gauge group in six dimensions whenever there exists an exact sequence

$$0 \longrightarrow \Gamma' \longrightarrow \Gamma \longrightarrow \mathbb{Z}_n \longrightarrow 0, \tag{5.3}$$

for $\Gamma' \subset \Gamma$ a finite subgroup of $SU(2)$ and some cyclic group \mathbb{Z}_n . A classification of such exact sequences can be found in Reid [41]. As Γ acts transitively on S^1 via the \mathbb{Z}_n action, one obtains a circle of Γ' singularities with \mathbb{Z}_n monodromies. The monodromies act by outer automorphisms of Γ' which breaks the A - D - E group associated to Γ' to the visible gauge group. The spacetime singularity is \mathbb{C}^2/Γ' .

It is interesting to consider similar types of constructions of matrix theories. In particular, the various ways that one can twist the boundary conditions will lead to different physics in the orbifold limit.

Let us consider the standard 1 + 1-dimensional matrix theory. When going around the S^1 of the matrix model base space, we can twist the hypermultiplet by a m th root of unity, ω , and leave the vector multiplet alone,

$$\begin{aligned} V(\sigma + 2\pi) &= V(\sigma) \\ H(\sigma + 2\pi) &= \omega H(\sigma). \end{aligned} \tag{5.4}$$

The resulting boundary conditions on the hypermultiplet break half of the supersymmetry and splits it into a pair of chiral multiplets.

In the IR limit, we obtain some version of matrix string theory. As the eigenvalues for the hypermultiplets must also satisfy the \mathbb{Z}_m identification in (5.4), the moduli space for the particles is

$$\mathbb{R}^4 \times (\mathbb{C}^2/\mathbb{Z}_m).$$

So this is matrix string theory on an A_{m-1} space. When gluing fields together to make long strings, we find m different twisted sectors classified by the length of the string modulo m . In particular, for all strings of length $k = 1, \dots, m-1 \pmod m$, the hypermultiplets are not periodic and cannot have a zero-mode, so they are stuck to the zero locus for a supersymmetric vacuum. On the other hand, for the strings whose length is a multiple of m , the hypermultiplets acquire a zero-mode, so that there is a Higgs branch for these sectors.

The above counting of states indicates that the ground states of the different length strings yield $m-1$ six-dimensional vector multiplets. Ignoring the circle, these states are localized at the origin of $\mathbb{C}^2/\mathbb{Z}_m$. By our mass deformation arguments in section 3, we are also led to believe that there is an extra bound state developed in the last sector. If this is true, then when one extracts the weakly coupled IIA theory by taking the radius of the circle to zero size, the spectrum of states is precisely that required to have an A_{m-1} ALE singularity. The fractional strings become the twisted sectors of the SCFT. It is rather important to notice that the splitting and joining of long strings occurs according to the fusion rules of the orbifold SCFT.

This construction should correspond to M-Theory on $(\mathbb{C}^2 \times S^1)/\mathbb{Z}_m$, where the \mathbb{Z}_m acts transitively on S^1 . In terms of the exact sequence (5.3), Γ' is trivial and there is no enhanced gauge symmetry in the six-dimensional physics.

For the A_{n-1} matrix models we can also twist one of the hypermultiplets by an m th root of unity. In particular, the gauge-invariant coordinates transform as

$$\begin{aligned} u &\rightarrow \omega u \\ v &\rightarrow \omega^{-1}v \\ w &\rightarrow w. \end{aligned} \tag{5.5}$$

The origin, $u = v = 0$ is the only point left fixed by this transformation, so the supersymmetric ground states are those for which one of the hypermultiplets is set to zero. Since one can change which of the hypermultiplets is shifted by large gauge transformations, there are n such states, which are again vectors in six-dimensions. Long strings are now classified by their congruence modulo m , so that, in total, we find nm vectors. This is expected from

an analysis of the CFT limit, as it corresponds to the IIA string on the $\mathbb{C}^2/\mathbb{Z}_{nm}$ orbifold. As seen from the M-Theory perspective, the orbifold group is acting by \mathbb{Z}_m actions on the shrunken circle.

For the D and E series, this extra twisting can always be removed by a large gauge transformation. Therefore, no new physics will arise by such an orbifolding of the theory.

Now, in Witten's matrix model [23], the twisting is done via the outer automorphisms of the Lie algebra, by clock-shifts of size p . When one examines the moduli space of flat directions, one sees that it parameterizes $\mathbb{C}^2/\mathbb{Z}_k$, where $k = \text{gcd}(n, p)$. This model describes M-Theory compactified on $(\mathbb{C}^2 \times S^1)/\mathbb{Z}_n$, where \mathbb{Z}_n acts by $\mathbb{Z}_{n/k}$ actions on the S^1 . Corresponding to the exact sequence

$$0 \longrightarrow \mathbb{Z}_k \longrightarrow \mathbb{Z}_n \longrightarrow \mathbb{Z}_{n/k} \longrightarrow 0, \quad (5.6)$$

we have a circle of $\mathbb{C}^2/\mathbb{Z}_k$ singularities with a trivial $\mathbb{Z}_{n/k}$ monodromy, so the spacetime gauge group is $U(k)$. On the other hand, we started with the A_{n-1} matrix model, so we should think of the end product as a circle of \mathbb{Z}_n singularities with a $\mathbb{Z}_{n/k}$ monodromy which generates n/k images for each shrunken \mathbb{P}^1 .

Now, we see that there are several twisted models which yield $U(n)$ gauge groups. We have summarized the four models, as well as their, at least tentative, M-Theory interpretation in Table 1. According to Witten [23], the feature which should distinguish the vector theories

Matrix Model	Type of Twist	M-Theory Interpretation
standard	\mathbb{Z}_n phase on hypermultiplet	$(\mathbb{C}^2 \times S^1)/\mathbb{Z}_n$
A_{n-1}	none	$\mathbb{C}^2/\mathbb{Z}_n \times S^1$
$A_{n/m-1}$	\mathbb{Z}_m phase on hypermultiplet	$(\mathbb{C}^2/\mathbb{Z}_{n/m} \times S^1)/\mathbb{Z}_m$
A_{mn-1}	\mathbb{Z}_m clockshift	$(\mathbb{C}^2/\mathbb{Z}_{mn} \times S^1)/\mathbb{Z}_m$ with monodromies

Table 1: The four types of twisted matrix models with $U(n)$ gauge group and their suggested M-Theory interpretations.

at the singularity given by these models is the theta angle in the six-dimensional gauge theory. For example, the A_{n-1} model has $\theta = 0$, while the $A_{n/m-1}$ model twisted by a \mathbb{Z}_m phase on hypermultiplet and the A_{mn-1} model twisted by \mathbb{Z}_m clockshifts both have $\theta \neq 0$.

Finally, we note that we can allow more general types of twisted models by combining the two types of twisting.

6. Classification of Twisted Matrix Models

In the previous section, we considered Witten’s matrix model, which amounted to orbifolding the A_{n-1} matrix models by elements of their quantum symmetry group. This is, in fact, one particular case of a general construction of twisted matrix models based on Reid’s exact sequences (5.3). In case (1) of Table 2², the models based on $\Gamma' = \Gamma(A_{n-1})$ and $\Gamma = \Gamma(A_{rn-1})$ are the second and fourth entries, respectively, in Table 1. This is a degenerate case, however,

Case	$0 \longrightarrow \Gamma' \longrightarrow \Gamma \longrightarrow \mathbb{Z}_n \longrightarrow 0$
(1)	$0 \longrightarrow \Gamma(A_{n-1}) \longrightarrow \Gamma(A_{rn-1}) \longrightarrow \mathbb{Z}_r \longrightarrow 0$
(2)	$0 \longrightarrow \Gamma(A_{2n}) \longrightarrow \Gamma(D_{2n+3}) \longrightarrow \mathbb{Z}_4 \longrightarrow 0$
(3)	$0 \longrightarrow \Gamma(A_{2n-1}) \longrightarrow \Gamma(D_{n+2}) \longrightarrow \mathbb{Z}_2 \longrightarrow 0$
(4)	$0 \longrightarrow \Gamma(D_4) \longrightarrow \Gamma(E_6) \longrightarrow \mathbb{Z}_3 \longrightarrow 0$
(5)	$0 \longrightarrow \Gamma(D_{n+1}) \longrightarrow \Gamma(D_{2n}) \longrightarrow \mathbb{Z}_2 \longrightarrow 0$
(6)	$0 \longrightarrow \Gamma(E_6) \longrightarrow \Gamma(E_7) \longrightarrow \mathbb{Z}_2 \longrightarrow 0$

Table 2: Reid’s six classes of surface quotient singularities.

because the \mathbb{Z}_r action on $\Gamma(A_{n-1})$ is trivial, so the “twisted” theory based on Γ' is just the A_{n-1} ALE matrix model. On the other hand, \mathbb{Z}_r acts by clockshifts on $\Gamma(A_{rn-1})$, which yields Witten’s twisted model.

The generalization of this amounts to considering all possible twistings by the symmetry groups of the A - D - E extended Dynkin diagram of an ALE matrix model. Since we are discussing twists when going around a circle, we must restrict ourselves to orbifolding by cyclic symmetries of the extended Dynkin diagrams. In this section, we show that the most general twists that are allowed and which lead to gauge groups are the twisting of Γ' and Γ by the cyclic groups \mathbb{Z}_n appearing in Reid’s classification. The orbifolds generated lead to new matrix models and, hopefully, new physics.

6.1. Models with $Sp(n)$ Gauge Group

Let us consider Reid’s case (3). Here $\Gamma' = \Gamma(A_{2n-1})$ contains an even number of vertices, so that the \mathbb{Z}_2 reflection on A_{2n-1} in Figure 2 yields a diagram which resembles the extended Dynkin diagram for C_n .

²As referenced in Witten [23], D. Morrison has pointed out that there is a typo in case (2) on page 376 of [41]. D_{2n+1} should read D_{2n+3} , as appears correctly in Table 2.

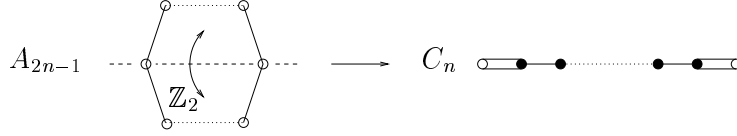

Figure 2: The \mathbb{Z}_2 twist on the A_{2n-1} model that generates a C_n model.

The fields at the fixed vertex, call it the i th, must transform as

$$\begin{aligned}
 V_i &\rightarrow V_i \\
 x_{i-1,i} &\rightarrow y_{i,i+1} \\
 y_{i-1,i} &\rightarrow -x_{i,i+1},
 \end{aligned} \tag{6.1}$$

so that the F-term is preserved, $F_i \rightarrow F_i$. However, this seems to break half of the supersymmetry, since the chiral fields (x, y) no longer form a hypermultiplet. In particular, the gauge-invariant coordinates transform as

$$\begin{aligned}
 u &\rightarrow v \\
 v &\rightarrow u \\
 w &\rightarrow -w,
 \end{aligned} \tag{6.2}$$

which is a \mathbb{Z}_2 action.

However, since there are an even number of vertices for the A_{2n-1} diagram, we can place the hypermultiplets in the $(1, \dots, 1, Nk_i, Nk_{i+1}, 1, \dots, 1)$ representations. In this case, one can easily see that these assignments actually preserve all of the supersymmetry. The new assignments result in different F and D-terms than appeared in (2.1). Here we have

$$\begin{aligned}
 D_i &= |x_{i-1,i}|^2 - |y_{i,i+1}|^2 + |x_{i,i+1}|^2 - |y_{i-1,i}|^2 \\
 F_i &= x_{i-1,i}y_{i-1,i} + y_{i,i+1}x_{i,i+1}.
 \end{aligned} \tag{6.3}$$

In particular, when orbifolding by symmetries of the extended Dynkin diagram, the fields will transform as

$$\begin{aligned}
 V_i &\rightarrow V_{i'} \\
 (x_{i-1,i}, y_{i-1,i}) &\rightarrow (x_{i'-1,i'}, y_{i'-1,i'}) \\
 D_i, F_i &\rightarrow D_{i'}, F_{i'},
 \end{aligned} \tag{6.4}$$

thereby preserving all of the supersymmetry.

Now let us consider $\Gamma = \Gamma(D_{n+2})$. As the D and E series are described by open quivers, we can place the hypermultiplets in the fundamental–fundamental representations, as we did

for A_{2n-1} above. We can therefore also preserve all of the supersymmetry in the twisted D and E models. From the exact sequence

$$0 \longrightarrow \Gamma(A_{2n-1}) \longrightarrow \Gamma(D_{n+2}) \longrightarrow \mathbb{Z}_2 \longrightarrow 0, \quad (6.5)$$

we can tell which \mathbb{Z}_2 action on the D_{n+2} that the reflection in Figure 2 induces³; it is the identification found in Figure 3.

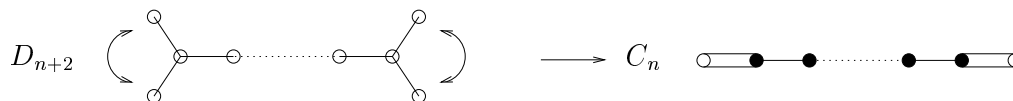

Figure 3: The \mathbb{Z}_2 action on the D_{2n} diagram induced by the reflection of Figure 2.

To complete the identification of the new diagram obtained in Figure 2 with the C_n extended Dynkin diagram, we need to define a consistent set of rules for obtaining the new roots from the old roots. To determine these rules, we consider the M-Theory interpretation of these models. Each root of the extended Dynkin diagram is associated with a \mathbb{P}^1 that can be blown-up in the ALE space, and these \mathbb{P}^1 s are further associated to the wrapped membrane states. The roots, α_i , are not linearly independent, but satisfy the relationship

$$\sum_i k_i \alpha_i = 0, \quad (6.6)$$

where the k_i denote the Dynkin labels⁴ of the extended algebra. In terms of the \mathbb{P}^1 s, (6.6) implies that the topological sum of the \mathbb{P}^1 s is trivial in integral homology.

Now, when we consider taking the \mathbb{Z}_n quotient of our A - D - E matrix model, it is clear that we must require that the weighted sum of the \mathbb{P}^1 s of the quotient is trivial in the integral \mathbb{Z}_n -equivariant homology. Therefore, our rules for determining the new roots, $\tilde{\alpha}_i$ and the metric on them for the twisted models must obtain the condition (6.6)

$$\sum_i \tilde{k}_i \tilde{\alpha}_i = 0, \quad (6.7)$$

where \tilde{k}_i are the marks of the quotient diagram.

Figure 4 gives a labeling of the roots for the A_{2n-1} , D_{n+2} , and C_n models. For C_n , the vanishing condition (6.7) is the sum over the roots weighted by the marks,

$$\tilde{\alpha}_0 + 2 \sum_{i=1}^{n-1} \tilde{\alpha}_i + \tilde{\alpha}_n = 0. \quad (6.8)$$

³The induced actions for Reid's cases (3)-(6) follow from the discussion of induced representations found in Appendix III of [42].

⁴Or marks, if the group is not simply-laced.

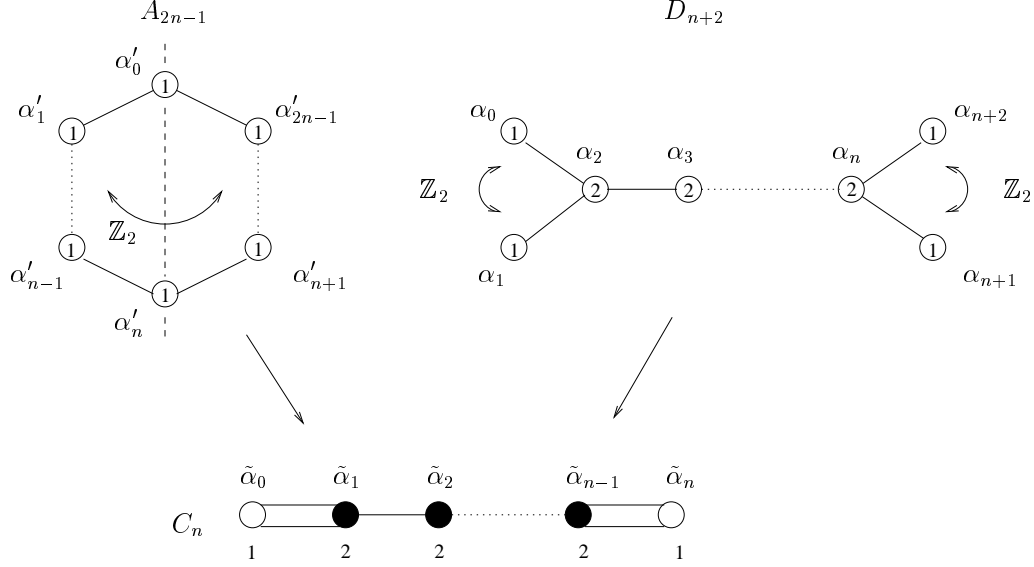

Figure 4: The labeling of roots and Dynkin labels (marks) for A_{2n-1} , D_{n+2} , and C_n .

This requires that we obtain new roots from the \mathbb{Z}_2 quotient of $\Gamma(A_{2n-1})$ according to

$$\begin{aligned}
 \tilde{\alpha}_0 &= \alpha'_0 \\
 \tilde{\alpha}_i &= \frac{1}{2} (\alpha'_i + \alpha'_{2n-i}), \quad i = 1, \dots, n-1 \\
 \tilde{\alpha}_n &= \alpha'_n.
 \end{aligned} \tag{6.9}$$

Now consider the new roots obtained after the \mathbb{Z}_2 action on $\Gamma(D_{n+2})$. in order for the new roots obtained from the \mathbb{Z}_2 action on $\Gamma(D_{n+2})$ to satisfy (6.8), they must be given as

$$\begin{aligned}
 \tilde{\alpha}_0 &= \alpha_0 + \alpha_1 \\
 \tilde{\alpha}_i &= \alpha_{i+1}, \quad i = 1, \dots, n-1 \\
 \tilde{\alpha}_n &= \alpha_{n+1} + \alpha_{n+2}.
 \end{aligned} \tag{6.10}$$

According to this prescription, these \mathbb{Z}_2 orbifolds of the A_{2n-1} and D_{n+2} ALE matrix models yield twisted matrix string theories whose six-dimensional physics has an $Sp(n)$ gauge symmetry.

We find that, in general, when twisting the Γ' and Γ models, we must ensure that the sum of \mathbb{P}^1 s in the quotient forms an integral class (and not a multiple of one) and that at least one of the old roots with Dynkin label $k_i = 1$ appear with coefficient one in the expression for the new roots. We normalize the metric so that the longest root has $(\text{length})^2 = 2$. The rules we must use to obtain the new roots and metric on them are the following:

1. The new roots are determined from the old roots according to the formula

$$\tilde{\alpha}_i = \frac{\min(n_i, n_e)}{n_i} \sum_{A_i} \alpha_{A_i}. \quad (6.11)$$

In this formula, n_i denotes the number of old roots which are pre-images of the new root $\tilde{\alpha}_i$, A_i is the index set which labels these pre-images, and $n_e = \min\{n_i | k_i = 1\}$.

2. The metric on the new roots is proportional to the induced metric

$$\tilde{g}_{ij} = \frac{1}{n_e} \tilde{\alpha}_i \cdot \tilde{\alpha}_j. \quad (6.12)$$

We note that in the case of the Γ' diagrams, the symmetry we quotient by is present in the case of the *unextended* Dynkin diagram, so that the extended root may be left fixed. In that case $n_e = 1$ and the rules 1 and 2 reduce to the prescription described by Aspinwall and Gross [43] in their consideration of symmetries of the unextended Dynkin diagrams, namely

$$\Gamma' : \begin{cases} \tilde{\alpha}_i = \frac{1}{\# \text{ of pre-images}} \sum(\text{pre-images}) \\ \tilde{g}_{ij} = \tilde{\alpha}_i \cdot \tilde{\alpha}_j. \end{cases} \quad (6.13)$$

In the case of the Γ diagrams, the symmetry always acts on the extended root, so that $n_e = \text{ord}(g)$, where g is the generator of the symmetry group, and

$$\Gamma : \begin{cases} \tilde{\alpha}_i = \sum(\text{pre-images}) \\ \tilde{g}_{ij} = \frac{1}{\text{ord}(g)} \tilde{\alpha}_i \cdot \tilde{\alpha}_j. \end{cases} \quad (6.14)$$

With a set of twisting rules in hand, let us revisit Reid's case (1), which contains Witten's matrix model. For $\Gamma' = \Gamma(A_{n-1})$, the \mathbb{Z}_r action is trivial, so the new roots are exactly the same as the old roots. For $\Gamma = \Gamma(A_{rn-1})$, \mathbb{Z}_r acts by a clockshift which yields an A_{n-1} diagram under identification of vertices. Using the rules (6.11) and (6.12), we find

$$\tilde{\alpha}_i = \sum_{j=1}^r \alpha_{i+(r-j)n}, \quad (6.15)$$

so that

$$\tilde{\alpha}_i^2 = \frac{1}{r} \sum_{k=1}^r \sum_{l=1}^r \alpha_{i+(r-k)n} \cdot \alpha_{i+(r-l)n} = 2 \quad (6.16)$$

and $\sum_i \tilde{\alpha}_i = 0$.

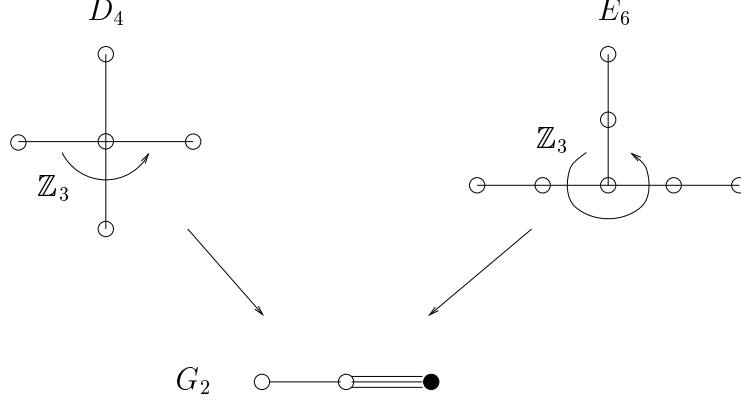

Figure 5: The \mathbb{Z}_3 -twisted $\Gamma(D_4)$ and $\Gamma(E_6)$ models with G_2 gauge group.

6.2. Models with G_2 , $SO(2n - 1)$, and F_4 Gauge Symmetry

For Reid's case (4) in Figure 5, we again find a pair of models which, after twisting according to the appropriate set of rules, lead to a theory with a G_2 gauge group.

Case (5) in Figure 6 also yields a pair of models, this time with $SO(2n - 1)$ gauge group, while case (6) in Figure 7 yields a pair of models with F_4 gauge group.

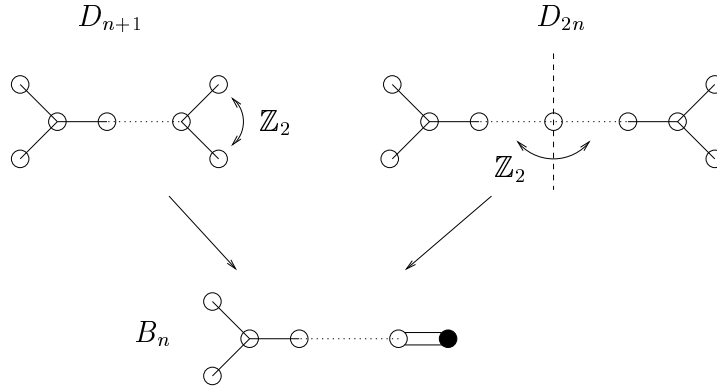

Figure 6: The \mathbb{Z}_2 -twisted $\Gamma(D_{n+1})$ and $\Gamma(D_{2n})$ models with $SO(2n - 1)$ gauge group.

Finally, we can also consider case (2),

$$0 \longrightarrow \Gamma(A_{2n}) \longrightarrow \Gamma(D_{2n+3}) \longrightarrow \mathbb{Z}_4 \longrightarrow 0. \quad (6.17)$$

In this case, we see that, on both sides, one of the edges of the diagram gets identified with itself with the opposite orientation. This means that one destroys the corresponding Cartan generator and, moreover, one breaks half of the supersymmetry in the process. These theories

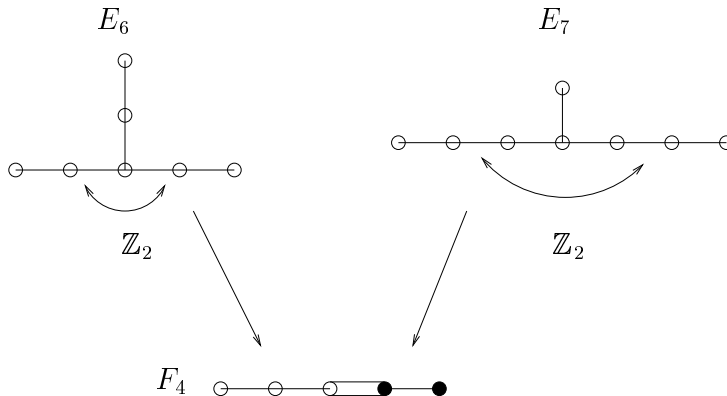

Figure 7: The \mathbb{Z}_2 -twisted $\Gamma(E_6)$ and $\Gamma(E_7)$ models with F_4 gauge group.

do not have $(1, 1)$ supersymmetry in six dimensions and we do not obtain new matrix models from them.

The correspondence with the classification of surface quotient singularities seems to explain why we get a pair of matrix models for each gauge group. However, several questions remain unanswered.

The twisted Γ and Γ' models equivalent both appear to have an interpretation as M-Theory on $(\mathbb{C}^2 \times S^1)/\mathbb{Z}_n$, but it would be interesting to see if the six-dimensional gauge theories have the same or different value of θ . Witten's analysis in the (degenerate) case (1) would tend to suggest that the value of θ is what distinguishes the pair of models.

Though we presented a reasonable argument for why we find different rules for extracting the new roots and metric in the twisted Γ and Γ' models, it would be nice to have a better understanding. Heuristically, the wrapped membrane states in these models are associated with the \mathbb{Z}_n -equivariant homology of the ALE spaces. An application of the wrapped membrane model discussed in section 4 to these orbifolded theories, as well as a construction of the Cartan generators for the D and E series, could be used to make this relationship more precise.

7. Some Dynamical Considerations

The ALE space matrix theories have the equivalent of $\mathcal{N} = 2$ supersymmetry in four dimensions. In general, this means that there are potential one-loop corrections to the metric on their Coulomb branches, but the standard non-renormalization theorem should protect against any higher-loop corrections. It is therefore possible that an F^2/r^{4-d} potential is generated at one-loop between two D0- branes which are ground states of the ALE model.

This would represent an interaction between the massless particles that is proportional to the square of their relative velocity, which is forbidden if the matrix description is to properly reproduce the results of supergravity at low energies.

The beta function for these theories vanishes, however, as can be seen from the following argument for the A_{n-1} series. The hyperkähler quotient leaves over n vector multiplets in the adjoint of the diagonal subgroup $U(N)_{\text{diag.}} \subset \times_{i=1}^n U(k_i N)$. Furthermore, under this subgroup, $(1, \dots, 1, Nk_i, \overline{Nk_{i+1}}, 1, \dots, 1) \sim 1 + \text{ad}(U(N)_{\text{diag.}})$, so there are also n charged hypermultiplets in the adjoint. Since the contribution to the beta function of a vector multiplet will cancel that of a adjoint hypermultiplet of the same mass, the beta function will be zero if the vector and hypermultiplet masses are paired accordingly. In the A_1 blow-up, it is easy to check that, when both states are either in the same or different vacua, the mass terms do indeed match and the beta function vanishes accordingly.

The next leading contribution is the F^4 interaction, which is generated at one-loop. In the case of additional compactification on a d -torus, the hyperkähler construction goes through unmodified. There is an integration over the modes of the torus, as well as over the compact zero-mode of the gauge field, yielding a potential which is proportional to v^4/r^{7-d} , as expected from the exchange of gravitons in the infinite momentum frame [44]. It is unclear how the degrees of freedom associated to wrapped membranes might modify this result.

Now in section 5, we also gave a definition for certain orbifolds, $M(\text{atrix})[\mathcal{M}_{\zeta=0} \times S^1/\mathbb{Z}_n]$. We also find mass matching in this case. Here, the vector and the hypermultiplet will both have zero mass, but their momenta are quantized in integer and fractional units respectively, so there might be an overall non-zero result. However, integrating over the zero-mode of the gauge field changes the mass terms in the integral so that both contributions exactly agree. Once again the beta function vanishes and there are no v^2 interactions. We similarly obtain an interaction which is proportional to v^4/r^6 .

We note that, as in the standard matrix SYM, renormalizability will limit the number of dimensions one can toroidally compactify within the SYM paradigm. Here, since there are abelian fields coupled to charged particles, there is sick UV behavior in four or more dimensions. To provide a sensible definition of the four-dimensional matrix ALE theory, new degrees of freedom must be added. The simplest field-theoretic solution is to restore some broken non-abelian gauge symmetry at some cutoff energy, so that the result is consistent. In any case, the SYM description is only valid up to $M[\mathcal{M}_{\zeta=0} \times T^2]$, which is still short of four flat transverse dimensions.

8. Conclusions

The description of massless vectors in the ALE matrix models provides more evidence that they capture important ingredients of M-Theory on an ALE space. We have provided evidence that these vectors exist as normalizable ground states of the Hamiltonian and that they actually can carry an arbitrary amount of longitudinal momentum by establishing their description within matrix string theory.

We also gave a quantitative prescription for studying wrapped membrane states in the ALE matrix theories. Certain properties, such as the membrane mass and the membrane-antimembrane Coulomb interaction, emerge straightforwardly in our description in the case of the A_1 singularity. The application of these methods to the rest of the A - D - E cases and more complicated configurations than we have considered would yield quite a bit of useful information about the ALE matrix models. The masses of these states can be computed in a straightforward fashion and they don't receive any corrections, as expected from the BPS nature of these states. Of even more interest is the structure of the bound states in these quantum mechanical systems and the dynamical information that may be extracted from them, particularly in the large N limit.

We have also given, within this framework, an explicit construction that suggests how orbifolds can be constructed via twists in the $1 + 1$ -dimensional matrix models. We saw that there were pairs of twisted matrix models that led to the same gauge groups, yet the rules which led to their construction were very different. We provided a connection between these pairs of models via Reid's exact sequences. These twisted matrix models may be the matrix theory realization of the M-Theory orbifolds on $(\mathbb{C}^2 \times S^1)/\Gamma$, recently described by Witten [23].

Acknowledgements

We would like to acknowledge fruitful discussions with Ofer Aharony, Philip Candelas, Willy Fischler, and Moshe Rozali. We would also like to thank Edward Witten for a useful correspondence.

We thank Michael Douglas for raising some critical issues regarding the discussion of wrapped membrane states and the finite N matrix models that appeared in an earlier version of this paper. While we were in the process of writing up our revisions to section 4 on wrapped membranes, [45] appeared, which also gives a quantitative prescription for the study of wrapped membranes in the ALE matrix models.

References

- [1] T. Banks, W. Fischler, S. H. Shenker, and L. Susskind, “M Theory as a matrix model: A conjecture,” *Phys. Rev.* **D55** (1997) 5112–5128, [hep-th/9610043](#).
- [2] T. Banks, “Matrix theory,” [hep-th/9710231](#).
- [3] W. Taylor, “D-brane field theory on compact spaces,” *Phys. Lett.* **B394** (1997) 283–287, [hep-th/9611042](#).
- [4] O. J. Ganor, S. Ramgoolam, and W. Taylor, “Branes, fluxes and duality in M(atrrix)-theory,” *Nuc. Phys.* **B492** (1997) 191–204, [hep-th/9611202](#).
- [5] D. Berenstein, R. Corrado, and J. Distler, “On the moduli spaces of M(atrrix)-theory compactifications,” *Nucl. Phys.* **B503** (1997) 239–255, [hep-th/9704087](#).
- [6] M. Rozali, “Matrix theory and U-duality in seven dimensions,” *Phys. Lett.* **B400** (1997) 260–264, [hep-th/9702136](#).
- [7] M. Berkooz, M. Rozali, and N. Seiberg, “Matrix description of M Theory on T^4 and T^5 ,” *Phys. Lett.* **B408** (1997) 105–110, [hep-th/9704089](#).
- [8] N. Seiberg, “New theories in six-dimensions and matrix description of M Theory on T^5 and T^5/\mathbb{Z}_2 ,” *Phys. Lett.* **B408** (1997) 98–104, [hep-th/9705221](#).
- [9] E. Witten, “String theory dynamics in various dimensions,” *Nucl. Phys.* **B443** (1995) 85–126, [hep-th/9503124](#).
- [10] A. Strominger, “Open p -branes,” *Phys. Lett.* **B383** (1996) 44–47, [hep-th/9512059](#).
- [11] A. Losev, G. Moore, and S. L. Shatashvili, “M & m’s,” [hep-th/9707250](#).
- [12] I. Brunner and A. Karch, “Matrix description of M theory on T^6 ,” [hep-th/9707259](#).
- [13] A. Hanany and G. Lifschytz, “M(atrrix) theory on T^6 and a M(atrrix) theory description of KK monopoles,” [hep-th/9708037](#).
- [14] O. J. Ganor, “On the M(atrrix) model for M theory on T^6 ,” [hep-th/9709139](#).
- [15] A. Sen, “D0-branes on T^n and matrix theory,” [hep-th/9709220](#).
- [16] N. Seiberg, “Why is the matrix model correct?,” [hep-th/9710009](#).
- [17] M. R. Douglas, “Enhanced gauge symmetry in M(atrrix) theory,” [hep-th/9612126](#).
- [18] M. R. Douglas, H. Ooguri, and S. H. Shenker, “Issues in M(atrrix) theory compactification,” *Phys. Lett.* **B402** (1997) 36–42, [hep-th/9702203](#).
- [19] W. Fischler and A. Rajaraman, “M(atrrix) string theory on K3,” *Phys. Lett.* **B411** (1997) 53–58, [hep-th/9704123](#).

- [20] M. R. Douglas, “D branes and matrix theory in curved space,” in *STRINGS '97*, (Amsterdam, June 16-21, 1997). [hep-th/9707228](#).
- [21] S. Govindarajan, “A note on M(atrrix) theory in seven-dimensions with eight supercharges,” *Phys. Rev.* **D56** (1997) 5276–5278, [hep-th/9705113](#).
- [22] M. Berkooz and M. Rozali, “String dualities from matrix theory,” [hep-th/9705175](#).
- [23] E. Witten, “New ‘gauge’ theories in six dimensions,” [hep-th/9710065](#).
- [24] N. J. Hitchin, A. Karlhede, U. Lindstrom, and M. Rocek, “Hyperkähler metrics and supersymmetry,” *Commun. Math. Phys.* **108** (1987) 535.
- [25] P. B. Kronheimer, “The construction of ALE spaces as hyper-kähler quotients,” *J. Diff. Geom.* **19** (1989) 665–683.
- [26] M. R. Douglas and G. Moore, “D-branes, quivers, and ALE instantons,” [hep-th/9603167](#).
- [27] J. Polchinski, “Tensors from K3 orientifolds,” *Phys. Rev.* **D55** (1997) 6423–6428, [hep-th/9606165](#).
- [28] C. V. Johnson and R. C. Myers, “Aspects of type IIB theory on ALE spaces,” *Phys. Rev.* **D55** (1997) 6382–6393, [hep-th/9610140](#).
- [29] L. Susskind, “Another conjecture about M(atrrix) theory,” [hep-th/9704080](#).
- [30] L. Motl, “Proposals on nonperturbative superstring interactions,” [hep-th/9701025](#).
- [31] T. Banks and N. Seiberg, “Strings from matrices,” *Nucl. Phys.* **B497** (1997) 41–55, [hep-th/9702187](#).
- [32] R. Dijkgraaf, E. Verlinde, and H. Verlinde, “Matrix string theory,” *Nucl. Phys.* **B500** (1997) 43–61, [hep-th/9703030](#).
- [33] P. K. Townsend, “The eleven-dimensional supermembrane revisited,” *Phys. Lett.* **B350** (1995) 184–187, [hep-th/9501068](#).
- [34] E. Witten, “Some comments on string dynamics,” in *Future Perspectives in String Theory: STRINGS '95*, I. Bars *et. al.*, eds., (Los Angeles, CA, March 13–18, 1995). World Scientific, 1996. [hep-th/9507121](#).
- [35] P. S. Aspinwall, “K3 surfaces and string duality,” in *TASI 96: Fields, Strings, and Duality*, C. Efthimiou and B. Greene, eds., (Boulder, CO, June 2–28, 1996). World Scientific, 1997. [hep-th/9611137](#).
- [36] D.-E. Diaconescu and J. Gomis, “Duality in matrix theory and three-dimensional mirror symmetry,” [hep-th/9707019](#).
- [37] S. Sethi and M. Stern, “D-brane bound states redux,” [hep-th/9705046](#).

- [38] M. Porrati and A. Rozenberg, “Bound states at threshold in supersymmetric quantum mechanics,” [hep-th/9708119](#).
- [39] E. Witten, “Supersymmetry and Morse theory,” *J. Diff. Geom.* **17** (1982) 324–328.
- [40] M. R. Douglas and H. Ooguri, “Why matrix theory is hard,” [hep-th/9710178](#).
- [41] M. Reid, “Young person’s guide to canonical singularities,” in *Algebraic Geometry*, S. J. Bloch, ed., vol. 46 of Proc. Symp. Pure Math., (Bowdoin College, Brunswick, Maine, July 8-26, 1985). 1987.
- [42] P. Slodowy, *Simple Singularities and Simple Algebraic Groups*. No. 815 in Lecture Notes in Mathematics. Springer-Verlag, Berlin, 1980.
- [43] P. S. Aspinwall and M. Gross, “The $SO(32)$ heterotic string on a K3 surface,” *Phys. Lett.* **B387** (1996) 735–742, [hep-th/9605131](#).
- [44] D. Berenstein and R. Corrado, “M(atrix)-theory in various dimensions,” *Phys. Lett.* **B406** (1997) 37–43, [hep-th/9702108](#).
- [45] D.-E. Diaconescu, M. R. Douglas, and J. Gomis, “Fractional branes and wrapped branes,” [hep-th/9712230](#).