

Quantum Topology Change in $(2 + 1)d$

A.P. Balachandran¹, E. Batista², I.P. Costa e Silva³ and P. Teotonio-Sobrinho³

¹*Department of Physics, Syracuse University
Syracuse, NY 13244-1130, USA*

²*Universidade Federal de Santa Catarina, Centro de Física e Matemática,
Dep. MTM, CEP 88.010-970, Florianópolis, SC, Brazil*

³*Universidade de São Paulo, Instituto de Física-DFMA
Caixa Postal 66318, 05315-970, São Paulo, SP, Brazil*

Abstract

The topology of orientable $(2 + 1)$ spacetimes can be captured by certain lumps of non-trivial topology called topological geons. They are the topological analogues of conventional solitons. We give a description of topological geons where the degrees of freedom related to topology are separated from the complete theory that contain metric (dynamical) degrees of freedom. The formalism also allows us to investigate processes of quantum topology change. They correspond to creation and annihilation of quantum geons. Selection rules for such processes are derived.

1 Introduction

It is very common to make the reasonable assumption that the topology of space-time is fixed. We assume that space-time is a manifold of the form $\Sigma \times \mathbb{R}$, and that for each time t , we have a space-like surface that is always homeomorphic to a given Σ . However, when (quantum) gravity is taken into account, the very geometry of space becomes a degree of freedom, and one can conceive the possibility that Σ changes in the course of time [1]. Such a process is called topology change. Creation of baby universes, production of topological defects (cosmic strings, domain walls), and changes in genus (production of wormholes and topological geons) are examples of topology change. Each of them have received some attention in the literature. Several authors have investigated topology change within the context of both classical and quantum gravity [2]. It is interesting to notice that in the usual canonical approach to gravity, only the metric of the spatial manifold Σ appears as a degree of freedom and receives a quantum treatment. The topology of Σ in its turn is implicitly treated as a classical entity. There are, of course, other approaches to quantum gravity such as string theory [7] and Euclidean quantum gravity [8] where topology may appear as an entity of a quantum nature via a sum over topologies.

It would be desirable to have a formalism where topology can in a certain sense be canonically quantized and if possible separated from degrees of freedom coming from metric and other fields. In spite of the fact that topology change has been inspired by quantum gravity, it has been demonstrated in [9] that it can happen in ordinary quantum mechanics. In this approach, metric is not dynamical, but degrees of freedom related to topology are quantized. The notion of a space with a well defined topology appears only as a classical limit. (See also [10] for related ideas). The views we would like to present in this paper are similar, to a certain extent, to the ones in [9]. In our approach, variables related to topology are separated from other degrees of freedom and then quantized.

The topology of space is well captured by soliton-like excitations of Σ called topological geons. They can be thought of as lumps of nontrivial topology. For example, in $(2+1)d$, the topology of an orientable, closed surface Σ is determined by the number of connected components of Σ and by the number of handles on each connected component. Each handle corresponds to a topological geon, i.e., a localized lump of nontrivial topology. It is well known that these solitons have particle like properties such as spin and statistics. However unlike ordinary particles they can violate the spin-statistics relation [4, 11]. It has been suggested [11, 13, 12] that the standard spin-statistics relation can be recovered if one considers processes where geons are (possibly pairwise) created and annihilated, but this necessarily implies a change of the topology of Σ . In other words, one may have to consider topology change in order to have a spin-statistics theorem for geons [13, 12].

The Euclidean path integral approach can in some sense be carried out in low dimensions [14], but it represents a formidable task in the case of a $(3+1)d$ theory. It would be nice to stay closer to a “canonical” quantization, even though topology change and the canonical approach appear to be incompatible. One may search for alternative descrip-

tions of topological properties using algebraic tools, very much in the spirit of quantum invariants of knot theory. The polynomial invariants of knots can be obtained by both field theoretic and algebraic methods. In the field theoretical approach, it is well known that Jones polynomials are obtained by means of functional integrals of Chern-Simons theory [15]. In the algebraic approach, one obtains invariants by representations of the braid group [16, 17], or via Hopf algebras [18, 19]. We will try in this paper to give an algebraic description of quantum geons, rather than a field theoretical one. We will present a theory of quantized topological geons where topology change is a quantum transition. We will only analyze the case of orientable geons in $(2 + 1)d$ where handles are the only possible “particles”. A generalization to include nonorientable geons will be presented elsewhere.

Let us consider a manifold M and some generic field theory (possibly with gauge and Higgs fields) interacting with gravity. It is reasonable to expect that if we could quantize such a complex theory, its observables would give us information on the geometry and topology of M . The main point is that one does not need to consider the full theory to get some topological information. It is possible that, in a certain low energy (large distance) limit, there would be a certain set of observables encoding the topological data. We know examples where this is precisely the case. In general, the low energy (large distance) limit of a field theory is not able to probe details of the short distance physics, but it can isolate degrees of freedom related to topology. We may give as an example the low energy limit of $N = 2$ Super Yang-Mills, known as the Seiberg-Witten theory [20]. We also have examples of more drastic reduction where a field theory in the vacuum state becomes purely topological [21]. Inspired by these facts we will identify the degrees of freedom, or the algebra $\mathcal{A}^{(n)}$ of “observables”, capable of describing n topological geons in $(2 + 1)d$. Actually, we will argue later in this paper that the operators in this algebra are not really observables in the strict sense. Rather, it is what is called [6] a *field algebra*. We say that $\mathcal{A}^{(1)}$ describes a single geon in the same way that the algebra of angular momentum describes a single spinning particle. In this framework what we mean by quantizing the system is nothing but finding irreducible representations of $\mathcal{A}^{(1)}$. As in the case of the algebra of angular momentum, different irreducible representations have to be thought of as different *particles*. For the moment, we will not be concerned with dynamical aspects. We would like to concentrate on the quantization itself and leave the dynamics to be fixed by the particular model one wants to consider.

An intuitive way of understanding the algebra $\mathcal{A}^{(1)}$ for a topological geon comes from considering a gauge theory with gauge group G in two space dimensions spontaneously broken to a discrete group H . For simplicity we will assume that H is finite. As an immediate consequence it follows that the gauge connection (at far distances) is locally flat. In other words, homotopic loops γ and γ' produce the same parallel transport (holonomy). The set of independent holonomies are therefore parametrized by elements $[\gamma]$ in the fundamental group $\pi_1(\Sigma)$. It is quite clear that such quantities are enough to detect the presence of a handle. The phase space we are interested in contains only topological degrees of freedom. Therefore such holonomies can be thought of as playing

the role of position variables. We also have to take into account the diffeomorphisms that are able to change $[\gamma]$. They will be somewhat the analogues of translations. It is clear that the connected component of the group of diffeomorphisms, the so-called small diffeos, cannot change the homotopy class of γ . To change the homotopy class of a curve γ one needs to act with the so-called large diffeomorphisms. Therefore the analogues of translations have to be parametrized by the large diffeos modulo the small diffeos. This is exactly the mapping class group M_Σ . Also, we must take into account an action of the group H , changing the holonomies by a conjugation. This action, as we will discuss later, corresponds physically to “encircling flux sources at infinity”. These three sets of quantities will comprise our algebra $\mathcal{A}^{(1)}$. Contrary to what happens in field theory or even in quantum mechanics, we find that $\mathcal{A}^{(1)}$ is finite dimensional. This will be important to avoid technical problems of various kinds. The algebra $\mathcal{A}^{(1)}$ contains the analogue of positions and translations and can be thought of as a discrete Weyl algebra. There seems to be no great obstacle to generalize our results also to the case where H is a Lie group [22].

Our algebraic description of geons is analogous to what has been developed for $2d$ non-abelian vortices by the Amsterdam group [23]. These ideas have been further developed by some of us and coworkers and applied to rings in $(3+1)d$. Their results will not be discussed here since a complete account will be reported in [24].

The algebra encountered by [23] was a special type of Hopf algebra, namely the Drin’feld double of a discrete group [18]. In our case, however, the algebra $\mathcal{A}^{(1)}$ is not Hopf, but it has a Drin’feld double as a subalgebra. For a pair of geons we find that the corresponding algebra $\mathcal{A}^{(2)}$ is closely related to the tensor product $\mathcal{A}^{(1)} \otimes \mathcal{A}^{(1)}$ of single geon algebras. This fact allows us to determine the appropriate algebra $\mathcal{A}^{(n)}$ for an arbitrary number n of geons.

The main result of our analysis is that it gives us some information on topology change at the quantum level. This is true for geons as well as for particles on the plane [24]. Our algebra $\mathcal{A}^{(1)}$ has to do with large distance observations. In other words, we can only probe low energy aspects of the theory. We will argue in Section 6 that geons, i.e. handles in the plane, can be created and annihilated in a quantum fashion as a consequence of the scale of observations. We would like to mention that other types of topology change, like creation of baby universes, do not fit naturally in our framework and will not be considered here.

One advantage of the algebraic approach is that we can do this analysis without going into the details of the “complete” underlying field theory. We can determine the spectrum $\hat{\mathcal{A}}^{(1)}$ of the geons, i.e., the set of possible irreducible representations of $\mathcal{A}^{(1)}$, but a particular field theory may restrict the available possibilities in $\hat{\mathcal{A}}^{(1)}$. The determination of these possibilities requires the study of particular examples of the underlying field theories. That may be a very difficult task. In this paper our intention is to use the simplified algebraic “field” theory and see what it can teach us. It is remarkable that such a simple framework can reveal important features of quantum geons such as a constraint

involving spin and statistics as well as rules for quantum topology change. The former connection is investigated in another paper [3].

An approach similar to ours is explored in reference [25]. Its author views the geon as a vortex-antivortex pair, in which case the algebra describing it *is* a quantum double. This description does not consider the internal diffeomorphisms of the geon, as it aims to describe vortices on a two-dimensional surface with handles. Accordingly, in [25], the setting is a two-dimensional surface $\Sigma_{g,n}$ of *genus g and n punctures*, whereas in this work we consider a 2-surface $\Sigma_{g,0}$ of *genus g without punctures*. Our approach is also different inasmuch as we are interested in considering “large diffeomorphisms”, i.e., elements of the mapping class group of $\Sigma_{g,0}$. More specifically, in [25], the topology of this surface is a passive background where a theory of pointlike vortices is defined, and its author only deals with diffeomorphisms moving particles (punctures) around or through handles. To us, the geons (handles) themselves, *including their internal structure*, are the entities of interest. The diffeomorphisms moving these handles are the “large diffeomorphisms” we mentioned above. As an illustration of the above mentioned differences, in a typical process considered in [25], one can make a test vortex go through or around a handle, whereas in our case one can conceive of “test geons” going through other handles. Our procedure allows a natural generalization towards quantum gravity, which is the issue of another paper [3].

We recall the notion of topological geons in Section 2. A special emphasis is given to orientable geons in $(2 + 1)d$. The field algebra is described in Section 3. Section 4 gives the effective description of a geon as seen from a large distance. The relevant subalgebra $\mathcal{D} \subset \mathcal{A}^{(1)}$ is the same as for a point particle. The representations of \mathcal{D} will play an important role when we discuss topology. Quantization of the system is given in Section 5. In this section we are able to classify the irreducible representations for a class of algebras $\tilde{\mathcal{A}}$ that includes our algebra of interest as a particular example. It is worthwhile to point out that the field algebras for vortices in $(2 + 1)d$ and for rings in $(3 + 1)d$ considered in [24] are also examples of $\tilde{\mathcal{A}}$. Section 6 describes how topology can change in this quantum theory, as a consequence of the scale of observation. We end with some concluding remarks and prospects of future work.

2 Topological Geons

The term *geon* was used for the first time by J.A. Wheeler [26] to designate a lump of electromagnetic energy held together by its own gravitational field, forming a spatial region of non-zero curvature, typically very small. In the context of this paper, however, this term will have a wholly different meaning, namely it will signify a *topological* geon, a soliton-like excitation in topology first discussed by Friedman and Sorkin [5], and whose properties were further elaborated by many authors [27, 28, 29, 30]. In this section, we

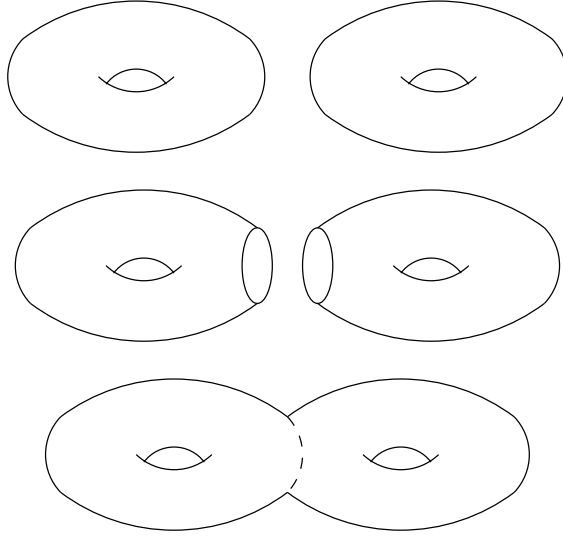

Fig. 2.1: The connected sum of two tori \mathbf{T}^2 . One first removes a disc from each torus and then glues them along the new boundaries.

review the definition and basic properties of topological geons, and refer the reader to the literature for further details.

We start with some basic preliminary definitions. Let M_1, M_2 be connected n -dimensional topological manifolds, possibly with boundaries. We define their connected sum, $M_1 \# M_2$, as follows: take n -balls B_i^n in the interiors of M_i ($i = 1, 2$) and remove their interiors. We thereby add spheres \mathbf{S}^{n-1} to the boundaries of M_1 and M_2 . Now identify the points of these spheres via a homeomorphism. The resulting manifold is $M_1 \# M_2$. If M_1 and M_2 are oriented, we further require that this homeomorphism be orientation reversing so that $M_1 \# M_2$ is also oriented. It follows trivially from the definition that $M \# \mathbf{S}^n$ is homeomorphic to M itself. The connected sum of two tori is shown on Fig. 2.1.

In this paper we shall be interested in a decomposition of spacetime by spacelike hypersurfaces (spatial manifolds). In dealing with gravity, one is usually interested in spacetime metrics which induce an asymptotically flat (or asymptotically conical, in the $(2+1)d$ case) Riemannian metric on each hypersurface. For a certain “frozen time” t , the hypersurface S_t should therefore be topologically a manifold with one *asymptotic region*, i.e., there exists a compact region $R_t \subset S_t$ whose complement in S_t is homeomorphic to $\mathbb{R}^n \setminus B^n$, where $(n+1)$ is the dimension of spacetime and B^n is the standard n -ball in \mathbb{R}^n . In Fig. 2.2 one can see $(2+1)d$ oriented geons (which are nothing but handles on a plane, see below) on a 2-dimensional spatial slice. This motivates the following definition: an n -manifold is said to have one asymptotic region iff it is homeomorphic to $R^n \# M$, where M is a closed (i.e., compact and boundaryless), connected n -manifold. Typical cases of interest are 2 and 3 manifolds with one asymptotic region, which are to be thought as spatial slices of $(2+1)$ - and $(3+1)$ -dimensional spacetimes respectively.

In 2 and 3 dimensions it is known [31, 32] that there exists a class of closed connected

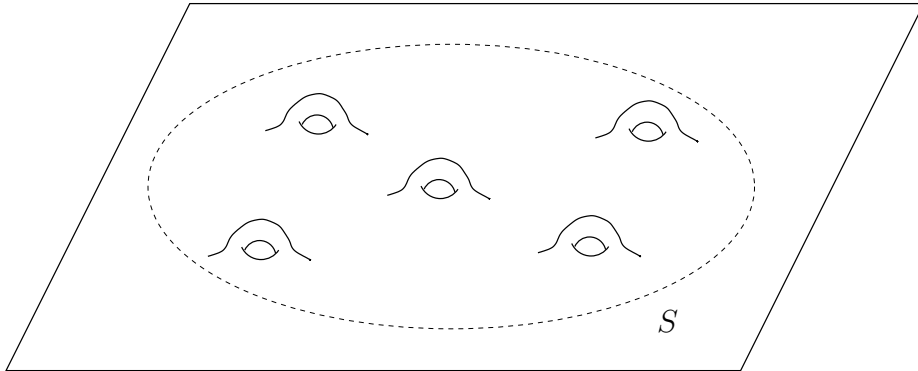

Fig. 2.2: A plane with a finite number of geons (handles) is an example of a manifold with one asymptotic region. Note that all topological complexity can be localized within a circumference S , and the geons can be isolated from each other. Outside S , one has simply a flat plane.

manifolds \mathcal{P}_i called *prime* manifolds. An n -manifold M is said to be prime iff $M = M_1 \# M_2$ implies that one of M_1, M_2 is an n -sphere. One can prove that given any compact n -manifold ($n = 2, 3$) M , there exists a unique decomposition

$$M = \mathcal{P}_1 \# \dots \# \mathcal{P}_N, \quad (2.1)$$

where $\mathcal{P}_i \neq \mathbf{S}^n$. Uniqueness means (apart from some technicalities - see ref. [32]) that given another decomposition $\mathcal{P}'_1 \# \dots \# \mathcal{P}'_{N'}$, we have $N = N'$ and (after possible reordering) \mathcal{P}_i is homeomorphic to \mathcal{P}'_i . Each prime component of M is called a topological geon.

In 2 dimensions, ignoring \mathbf{S}^2 from consideration, the only prime manifolds are \mathbf{T}^2 , which is orientable, and the “cross cap” \mathbf{RP}^2 , which is non-orientable [31]. In this paper we will consider only orientable geons, therefore we will have to deal only with \mathbf{T}^2 . Connected sums with \mathbf{S}^2 are clearly immaterial. In 3 dimensions there are infinitely many prime manifolds, only partially classified. As examples we can give the 3-torus \mathbf{T}^3 and the “handle” $\mathbf{S}^2 \times \mathbf{S}^1$.

From the aforementioned prime decomposition it is clear that any n -manifold M ($n = 2, 3$) with an asymptotic region can be decomposed as

$$M = \mathbb{R}^n \# \mathcal{P}_1 \# \dots \# \mathcal{P}_N. \quad (2.2)$$

Now consider $\mathbb{R}^n \# \mathcal{P}_i$. One can always find an $n - 1$ sphere in $\mathbb{R}^n \# \mathcal{P}_i$ whose interior contains \mathcal{P}_i . By a suitable choice of the metric this region can be thought of to be as small as one pleases, i.e., the topological complexity can be localized (for details see ref. [28]). In 2 spatial dimensions this means that one is allowed to put the handle inside of a circle and suppose the radius of the circle to be very small. Then one has a very small handle surrounded by a vast flat plane. It is in this sense that we refer to the geon as “soliton like” at the beginning of this section: just as a soliton corresponds to a localized excitation of some field, outside of which one has the vacuum, the geon is

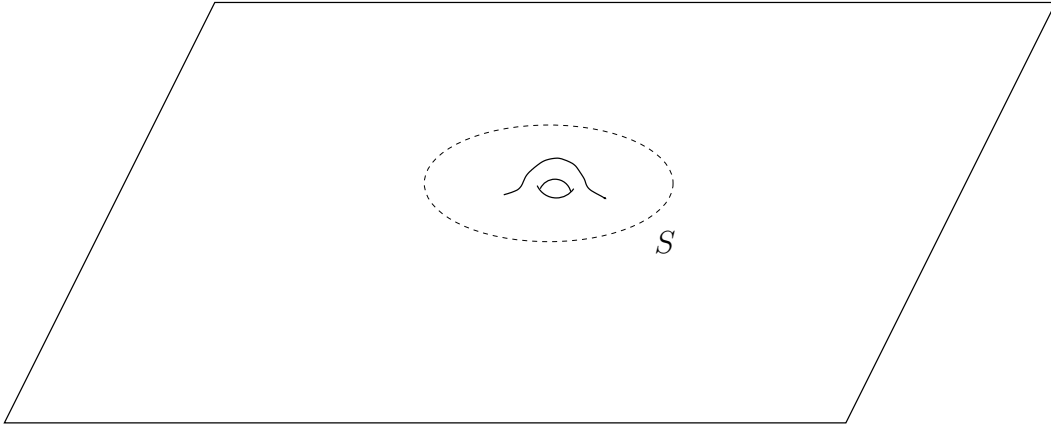

Fig. 2.3: A “solitary” geon can be seen as a localized excitation, or “soliton”, of topology. From a distance it looks like a point particle.

a localized excitation of the topology itself, the “vacuum” in this case being the flat space (see Fig. 2.3). In general, since \mathcal{P}_i is prime, one may say that it represents an elementary topological excitation. We therefore say that $\mathbb{R}^n \# \mathcal{P}_i$ is a space with one geon. The manifold $\mathbb{R}^n \# \mathcal{P}_1 \# \dots \# \mathcal{P}_N$ is therefore seen as a space with N geons. These prime manifolds attached to \mathbb{R}^n can be isolated from one another in the same way as we localized one single geon [28], and for many purposes one can think of geons as particles. Again, in 2 spatial dimensions one can have many isolated small handles.

The importance of geons to us lies in the fact that, as long as we preserve connectivity and consider a space manifold with one asymptotic region, *topology change amounts to creation and annihilation of geons*. Henceforth we restrain our attention to the case when the space is 2 dimensional, connected and oriented, with one asymptotic region. We assume, furthermore, that connectivity and orientability are preserved during topology change. Although somewhat restrictive, this case is still of much interest. Our assumptions imply, on the other hand, that the geons of interest will be those associated to copies of \mathbf{T}^2 , i.e., topology changing processes will mean creation and annihilation of handles on a plane. As we will see below, creation and annihilation will have for us a meaning different from the usual geometrical one. Instead they will be related to what a “distant” observer will be able to measure from a quantum theoretical standpoint.

3 The Field Algebra for $(2 + 1)d$ Topological Geons

Our aim in this section is to define some “observables” which describe the topological character of a geon. However, the term “algebra of observables” to designate the algebra describing geons would actually be a misnomer, for as we will see shortly, this

algebra includes operators which cannot be observables. To describe geons, we will use the low-energy limit of a field theory in their presence. In this limit, the theory becomes topological, and therefore provides us with quantities capable of probing the topological features of the background, and hence the geons. The kind of algebra which we will encounter is composed by a part related to the fields, via their holonomies around non-contractible paths, and to physical operations (some of them not observable locally) which may change these holonomies. This algebra is what is known in the literature as a *field algebra* (for a detailed definition, see for instance [6]).

We will follow an approach inspired by the work of the Amsterdam group, which is reported in ref. [23]. In this work, the group investigates the properties of topological solutions of a $(2+1)d$ gauge field theory in Minkowski spacetime where the gauge symmetry of a Lie group G is spontaneously broken to a finite group H by a non-vanishing expectation value of a Higgs field Φ . We shall briefly review their discussion, referring the reader to [23] for details. The Lagrangian is given by

$$\mathcal{L} = \frac{1}{4} F_{\mu\nu}^a F_a^{\mu\nu} + Tr[(D_\mu \Phi)^* \cdot (D^\mu \Phi)] - V(\Phi), \quad (3.1)$$

where $\mu, \nu = 0, 1, 2$, and a is a Lie algebra index. For simplicity, we assume that G is connected and simply connected. The fields $F_{\mu\nu}^a$ are the components of the field strength of the Yang-Mills potential A_μ^a and D_μ denotes the covariant derivative determined by this potential. The Higgs field Φ is in the adjoint representation and can be expanded in terms of generators T^a of the Lie algebra of G , and $V(\Phi)$ is a G -invariant potential. In this paper we shall be concerned with the low energy, or equivalently, the long range behavior of this theory, in the temporal gauge $A_0^a = 0$. This is obtained by minimizing the three terms in the energy density separately. Minimizing the term corresponding to the energy density of the Yang-Mills field, we obtain the condition $F_{\mu\nu}^a = 0$, from which we conclude that we are dealing only with flat connections. The minimum of the potential restricts the values of the Higgs field to the vacuum manifold, which is invariant by H . Finally, the condition $D\Phi = 0$, required for minimizing the energy density from the second term, tells us that the holonomies

$$\tau(\gamma) = P \exp\left\{ \int_\gamma A_i^a T_a ds^i \right\}; \quad i \in \{1, 2\}, \quad (3.2)$$

take values in the finite group H .

Here and in what follows we will fix a base point P for loops, so that all loops will begin and end at P .

This gauge theory may have topologically non-trivial, static solutions such as vortices. It is very well known that the core radii of these vortices are inversely proportional to the mass of the Higgs boson, and therefore they may be viewed as point-like in the low-energy regime of the theory. Hence, according to a standard argument, to describe the N -vortex solutions we may consider solutions for the vortex equations

$$F_{ij}^a = 0;$$

$$\begin{aligned} D_i \Phi &= 0; \\ V(\Phi) &= 0, \end{aligned} \tag{3.3}$$

on a spacetime of the form $\Sigma \times \mathbb{R}$, where Σ is the plane with N punctures, playing the role of the vortices. Now, take a solution (A, Φ) for the vortex equations (3.3). By fixing a point $P \in \Sigma$, the holonomy of A around any closed path γ based at P depends only on its homotopy class, since A is flat. It takes values into a subgroup H of G , which preserves the vacuum manifold, in view of the equations for Φ [23]. Therefore, any solution of the vortex equations determines a homomorphism τ ,

$$\tau : \pi_1(\Sigma) \rightarrow H, \tag{3.4}$$

between the fundamental group $\pi_1(\Sigma)$ and the group H . Conversely, given such a homomorphism τ we can define a solution for eqs.(3.3) in the following way. Take the universal covering space $\tilde{\Sigma}$ of Σ . It is the total space of a principal bundle over Σ with structure group $\pi_1(\Sigma)$. Via the homomorphism τ we can construct an associated principal H -bundle over Σ , which is a subbundle of the original G -bundle. Since H is finite, this bundle has a unique flat connection A_i^a , which can be viewed as a reducible connection on the G -bundle. We now find a Φ . By fixing some Φ_0 in the vacuum manifold, we have that, since Φ must be covariantly constant, we define $\Phi(P) = \Phi_0$ and its value can be obtained for each $x \in \Sigma$ by parallel transporting Φ_0 along some path from P to x in Σ :

$$\Phi(x) = P \exp\left\{\int_P^x A_i^a T_a ds^i\right\} \Phi_0. \tag{3.5}$$

The pair (A_i^a, Φ) thus constructed is obviously a solution of the vortex equations. Therefore the space of solutions for the vortex eqs. (3.3) is essentially parametrized by homomorphisms $\tau : \pi_1(\Sigma) \rightarrow H$. Each such homomorphism is then a vortex configuration.

Let us take the example of a single point-like vortex on the plane. The non-contractible loop γ that encircles the singularity has holonomy $\tau(\gamma)$ equal to the flux carried by the vortex. In trying to capture only topological information, one is not concerned with the position of the vortex, but only with its flux, characterized by some group element $h \in H$. In other words, the ‘‘configuration space’’ T for the vortex is labeled by elements of H . Hence, the algebra $\mathcal{F}(H)$ of complex-valued functions on H with pointwise multiplication plays the role of ‘‘position observables’’. Let us denote by $P_h \in \mathcal{F}(H)$, the characteristic function supported at $h \in H$. Then

$$P_h P_{h'} = \delta_{hh'} P_h. \tag{3.6}$$

In terms of homomorphisms, we have not yet exploited all the degrees of freedom the system has. Indeed, we have that H can act by conjugating all holonomies based at P by an element of H . Hence, a flux σ transforms under H as

$$\sigma \mapsto h \sigma h^{-1}, \tag{3.7}$$

In other words, we have an action of H by conjugation of the fluxes. We shall simply refer to this action as the H -transformations. The group elements $h \in H$ can be regarded as operators, also denoted by h , acting on the functions $f \in \mathcal{F}(H)$ via (3.7). In other words,

$$hP_\sigma h^{-1} = P_{h\sigma h^{-1}}. \quad (3.8)$$

The multiplication of two H -transformations is the same as the group multiplication. Therefore the algebra of such operators turns out to be the group algebra $\mathbb{C}(H)$.

As for the physical interpretation of the H -transformations we note that the mathematical action depicted in (3.7) is entirely equivalent, from a physical standpoint, to what occurs when one makes a vortex of flux σ encircle a source of flux h at infinity. Since such operation is non-local, one must conclude that the H -transformations cannot be considered local in the theory, i.e., cannot be implemented by local operators.

The field algebra is then the semi-direct product $D(H) = \mathbb{C}(H) \ltimes \mathcal{F}(H)$, the so-called Drin'feld double. It has the structure of a quasi-triangular Hopf algebra. The Hopf structure [18] means in particular the existence of a co-product, i.e., a map

$$\Delta : D(H) \longrightarrow D(H) \otimes D(H) ,$$

which is a homomorphism of algebras (and with further properties to be discussed in Section 4). In [23] the fluxes are seen as particles in $(2+1)d$ and are then first quantized: the (internal) Hilbert space \mathcal{H} is constructed, and the elements of the algebra $D(H)$ act as operators on this Hilbert space. \mathcal{H} decomposes into irreducible representations of $D(H)$, corresponding to the different particle sectors of the quantum theory. The existence of a co-product allows one to understand fusing processes between particles. The quasi-triangularity implies the existence of the R -matrix, $R \in D(H) \otimes D(H)$, responsible for all braiding processes between particles. For further details see [23].

How is the topology of Σ taken into account in this approach? First of all, we have seen that the physically distinct vortex configurations are in one-to-one correspondence to the space of conjugacy classes of homomorphisms of $\pi_1(\Sigma)$ into H . Moreover, it is well known that for a finite group H the latter space is in one-to-one correspondence with equivalence classes of principal H -bundles over Σ [39]. Therefore the only degree of freedom in this theory is the topology of these bundles [37, 38]. Second, a configuration for which the holonomy is trivial around some puncture is indistinguishable, from the standpoint of the low-energy theory, to another in which that particular puncture is absent. Therefore the low-energy theory somehow actually allows for “topology fluctuations” of Σ as long as we stay within its limits, and as far as “creation and annihilation” of punctures is concerned.

In order to determine the field algebra for a topological geon, we will try to follow a method similar to the one used for vortices in the plane, respecting carefully the differences between the two systems. We will first try to find the analogues of the “position observables” for a geon. Now, Σ is the plane with one or more handles, and for simplicity we shall assume throughout that there are no vortices, i.e., we work in the zero vortex number sector of the low-energy limit of the theory given by the Lagrangian in (3.1).

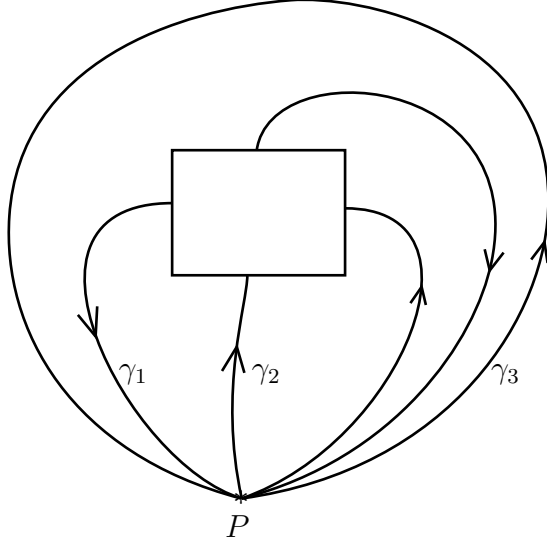

Fig. 3.1: The figure shows the loops γ_i ($1 \leq i \leq 3$). The homotopy classes $[\gamma_1]$ and $[\gamma_2]$ generate the fundamental group. The class $[\gamma_3]$ is not independent of $[\gamma_1]$ and $[\gamma_2]$.

This is in contrast with [25], where vortices are the central interest. There, the vortices determine the state of a handle, whereas in the present work all non-trivial configurations will be related solely to holonomies around and through the handles. In other words, the geons are our main concern, and the background field theory merely defines their states.

Let us start by taking Σ to be the plane with a handle. On all figures, a geon will be thought of as a square hole on the plane, with the opposite sides identified. One can show that $\pi_1(\Sigma)$ has two generators $[\gamma_1]$ and $[\gamma_2]$, shown by Fig. 3.1. It can be shown that

$$[\gamma_3] = [\gamma_1][\gamma_2][\gamma_1]^{-1}[\gamma_2]^{-1}.$$

Actually, $\pi_1(\Sigma)$ is freely generated by $[\gamma_1]$ and $[\gamma_2]$. Let $g = W([\gamma_1], [\gamma_2]) \in \pi_1(\Sigma)$, be a word in $[\gamma_1]$, $[\gamma_2]$ and their inverses. Then τ maps g to $W(a, b) \in H$ where $a = \tau(\gamma_1)$ and $b = \tau(\gamma_2)$. Therefore the map $\tau : \pi_1(\Sigma) \rightarrow H$ is completely characterized by the fluxes $\tau(\gamma_1) = a$ and $\tau(\gamma_2) = b$. Since there is no relation between a and b , the set T of all maps is labeled by $H \times H$.

Definition: Let H be a finite group and Σ the plane with one geon, i.e., a two dimensional manifold given by

$$M = \mathbf{R}^2 \# \mathbf{T}^2.$$

Let γ_1 and γ_2 denote representative loops whose classes generate $\pi_1(\Sigma)$. We define a classical configuration $\tau_{(a,b)} \in T$ of a geon as the homomorphism defined by

$$\tau_{(a,b)}(\gamma_1) = a, \text{ and } \tau_{(a,b)}(\gamma_2) = b. \quad (3.9)$$

It is important to bear in mind that $T \cong H \times H$ and therefore that it is a finite discrete set. For simplicity of notation, a geon configuration will be denoted simply by a

pair (a, b) of fluxes. Note that we are not explicitly identifying those configurations which differ by an H -transformation. This is because wave functions need only be “covariant” under the symmetries of the problem, and only its modulus squared and other observable quantities, like Aharonov-Bohm phases, must be invariant. In our approach, this will happen naturally, just as in [23].

With $T \cong H \times H$ being the configuration space for a geon, the corresponding algebra of “position observables” is $\mathcal{F}(T)$. Instead of working with the abstract algebra, we specify a representation. Let V be the (finite-dimensional) complex vector space generated by the vectors $|a, b\rangle, a, b \in H$. We will call the representation on V , to be defined below, the defining representation. The algebra $\mathcal{F}(T)$ is generated by projectors on V denoted by $Q_{(a,b)}$. They are defined by

$$Q_{(a,b)} |c, d\rangle = \delta_{a,c} \delta_{b,d} |c, d\rangle . \quad (3.10)$$

The operator $Q_{(a,b)}$ represents a “delta function” supported at (a, b) , i.e., it gives 1 when evaluated on (a, b) , and zero everywhere else. Indeed, from (3.10) one finds that

$$Q_{(a,b)} Q_{(c,d)} = \delta_{a,c} \delta_{b,d} Q_{(c,d)} , \quad (3.11)$$

Besides the projectors $Q_{(a,b)}$, which play the role of position operators in ordinary quantum mechanics, we have also some operators capable of changing (a, b) . They are somewhat analogous to momentum operators. For example, like in the case of vortices, H -transformations act on the configurations. It turns out that for a geon there are additional operators besides H -transformations. They correspond to the action of the group $Diff^\infty(\Sigma)$ of diffeomorphisms of Σ that keeps infinity invariant.

We will start by first examining the H -transformations.

The group H acts on T simply by conjugating both fluxes in (a, b) . This will induce an operator $\hat{\delta}_g$ for each $g \in H$, acting on the defining representation V by

$$\hat{\delta}_g |a, b\rangle = |gag^{-1}, gbg^{-1}\rangle . \quad (3.12)$$

From (3.12) one sees that the multiplication of operators $\hat{\delta}_g$ is given by

$$\hat{\delta}_g \hat{\delta}_h = \hat{\delta}_{gh} . \quad (3.13)$$

The corresponding algebra generated by $\hat{\delta}_g$ is the group algebra $\mathbb{C}(H)$. The relation between $\mathcal{F}(H \times H)$ and $\mathbb{C}(H)$ can be derived from (3.10) and (3.12). One sees immediately that

$$\hat{\delta}_g Q_{(a,b)} \hat{\delta}_g^{-1} = Q_{(gag^{-1}, gbg^{-1})} . \quad (3.14)$$

In other words, the algebra $\mathbb{C}(H)$ acts on $\mathcal{F}(H \times H)$.

Besides H -transformations, fluxes (a, b) can change under the action of the group $Diff^\infty(\Sigma)$. It is clear that elements belonging to the subgroup $Diff_0^\infty(\Sigma)$, the component

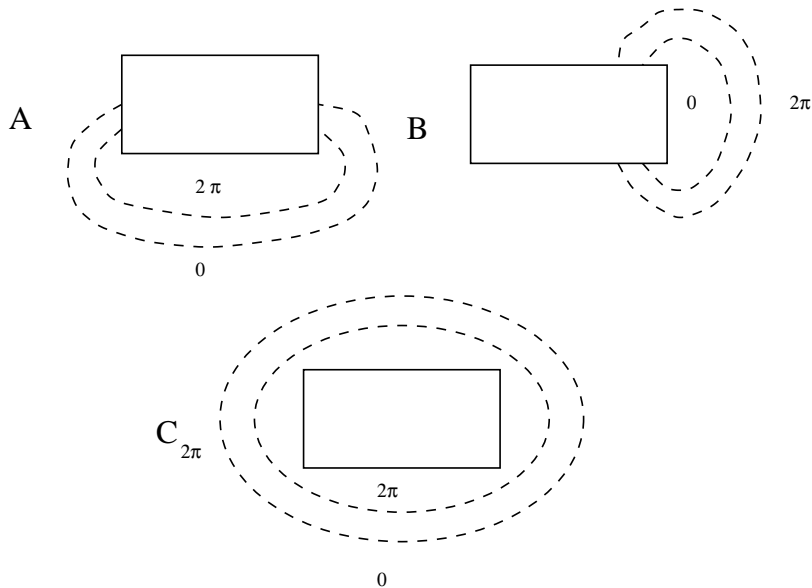

Fig. 3.2: Dehn twists corresponding to diffeomorphisms of the mapping class group. The annuli enclose loops, which we have omitted in the figure. Rotations are counterclockwise by convention.

connected to identity, act trivially on $\pi_1(\Sigma)$ ¹ and hence on (a, b) . Therefore what matters is the action of the so-called mapping class group M_Σ [33, 34], defined as

$$M_\Sigma = \frac{Diff^\infty(\Sigma)}{Diff_0^\infty(\Sigma)}. \quad (3.15)$$

For the present case, Σ is the plane with a single geon and the mapping class group is isomorphic to the central extension of the group $SL(2, \mathbf{Z})$, denoted by $St(2, \mathbf{Z})$ and called the Steinberg group. This is the same as the mapping class group of a torus minus one point [28]. We denote generators of $M_\Sigma = St(2, \mathbf{Z})$ by A and B . They correspond to (isotopy classes of) diffeomorphisms² called Dehn twists. A Dehn twist is realized as follows. Take a loop in Σ . Then draw an annulus enclosing the loop and introduce radial coordinates $r \in [0, 1]$, with $r = 0$ and $r = 1$ corresponding to the boundaries of the annulus, see Fig. 3.2. Then rotate the points of the annulus in such a way that the angle of rotation $\theta(r)$ is zero for $r = 0$ and gradually increases, becoming 2π at $r = 1$. Figure 3.2 shows how to produce Dehn twists, and in Fig. 3.3, we show how the Dehn twist B deforms the loop γ_1 . There is also the Dehn twist along a loop enclosing the geon, which can be interpreted as the 2π -rotation of the geon [4, 5, 28]. This Dehn twist will be important when we discuss the notion of spin of a topological geon. The corresponding

¹For simplicity, we take P to be at infinity. Even if we do not, the holonomies will be invariant under the action of $Diff_0^\infty(\Sigma)$.

²One can see from (3.14) that the mapping class group consists of isotopy classes of diffeomorphisms. Throughout this paper we shall loosely use a representative in a class as the class itself.

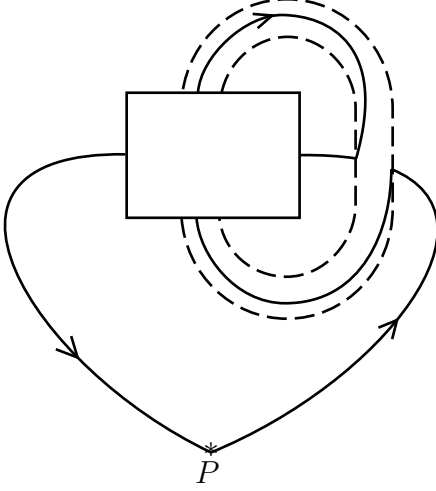

Fig. 3.3: Dehn twist B and its action on γ_1 .

annulus is denoted by $C_{2\pi}$ in Fig. 3.2. However, $C_{2\pi}$ is not independent of A and B . One can show that [28]

$$C_{2\pi} = (AB^{-1}A)^4. \quad (3.16)$$

The group M_Σ is generated by A and B , with the relation that $C_{2\pi}$ commutes with A and B . It is useful to think of the elements of M_Σ as words $W(A, B)$ in A , B and their inverses.

The action of A and B on $[\gamma_i] \in \pi_1(\Sigma)$ induces an action on $(a, b) \in T$, and therefore induces operators \hat{A} and \hat{B} in the defining representation acting on V . Let us take as an example the action of B on γ_1 , as given by Fig. 3.3. One sees that $[\gamma_1] \rightarrow [\gamma_1][\gamma_2]$, and therefore $a \rightarrow ab$. On the other hand, B keeps $[\gamma_2]$ invariant. One can verify that A and B induce the following operators:

$$\begin{aligned} \hat{A} | a, b \rangle &= | a, ba \rangle, \\ \hat{B} | a, b \rangle &= | ab, b \rangle. \end{aligned} \quad (3.17)$$

For an arbitrary word $W(A, B)$, the corresponding operator is $W(\hat{A}, \hat{B})$, i.e., the same word but with A and B replaced by \hat{A} and \hat{B} . For example, the Dehn twist $C_{2\pi}$ of Fig. 3.2 is written as $(AB^{-1}A)^4$ and the corresponding operator $\hat{C}_{2\pi}$ can be immediately computed to be

$$\hat{C}_{2\pi} | a, b \rangle = | \mathbf{c}^{-1}ac, \mathbf{c}^{-1}bc \rangle, \quad (3.18)$$

where $\mathbf{c} = aba^{-1}b^{-1}$.

It is also possible to perform rotations of the geon by integer multiples of the angle $\frac{\pi}{2}$ using $C_{\frac{\pi}{2}} = AB^{-1}A$. The corresponding operator is given by

$$\hat{C}_{\frac{\pi}{2}} | a, b \rangle = | b^{-1}, bab^{-1} \rangle. \quad (3.19)$$

The group \mathcal{M} generated by \hat{A} and \hat{B} defined by (3.17) is the one relevant for defining the field algebra. Contrary to the mapping class group, \mathcal{M} is a finite group. It turns out that an infinite number of words $W(\hat{A}, \hat{B})$ is equal to the identity operator and that \mathcal{M} can be naturally identified with M_Σ divided by a certain normal subgroup.

Let M_0 be a subgroup of $St(2, \mathbf{Z})$ defined as

$$M_0 = \{h \in St(2, \mathbf{Z}) \mid \hat{h} \mid a, b\rangle = \mid a, b\rangle, \forall a, b \in H\} .$$

It is easy to see that M_0 is a normal subgroup. In fact, given any word $W \in St(2, \mathbf{Z})$, such that

$$W(\hat{A}, \hat{B}) \mid a, b\rangle = \mid a', b'\rangle ,$$

we have the relation

$$\begin{aligned} W^{-1}(\hat{A}, \hat{B}) \hat{h} W(\hat{A}, \hat{B}) \mid a, b\rangle &= W^{-1}(\hat{A}, \hat{B}) \hat{h} \mid a', b'\rangle = W^{-1}(\hat{A}, \hat{B}) \mid a', b'\rangle = \\ &= \mid a, b\rangle . \end{aligned}$$

We define the *effective* mapping class group \mathcal{M} acting on the defining representation V as the quotient

$$\mathcal{M} = St(2, \mathbf{Z})/M_0 .$$

We now show that \mathcal{M} is finite. Let n be the order of H and $a_i, i = 1 \dots n$ its elements. We construct a basis for V as

$$\mathcal{B} = \{\mid a_i, a_j\rangle, i, j = 1 \dots n\} .$$

The group \mathcal{M} acts as a subgroup of the permutation group of the elements in \mathcal{B} , thus the order of \mathcal{M} is at most equal to $n^2!$.

The algebra generated by the operators \hat{A} and \hat{B} is the group algebra $\mathbb{C}(\mathcal{M})$. Together with $\mathbb{C}(H)$ and $\mathcal{F}(H \times H)$ it gives us the total field algebra $\mathcal{A}^{(1)}$ for a single topological geon. From the definitions (3.10), (3.12) and (3.17) one sees that

$$\begin{aligned} \hat{\delta}_g \hat{A} &= \hat{A} \hat{\delta}_g, \quad \hat{\delta}_g \hat{B} = \hat{B} \hat{\delta}_g, \\ \hat{\delta}_g Q_{(a,b)} \hat{\delta}_g^{-1} &= Q_{(gag^{-1}, gbg^{-1})}, \\ \hat{C}_{2\pi} \hat{A} &= \hat{A} \hat{C}_{2\pi}, \quad \hat{C}_{2\pi} \hat{B} = \hat{B} \hat{C}_{2\pi}, \\ \hat{A} Q_{(a,b)} \hat{A}^{-1} &= Q_{(a,ba)}, \quad \hat{B} Q_{(a,b)} \hat{B}^{-1} = Q_{(ab,b)}. \end{aligned} \tag{3.20}$$

Therefore, both algebras $\mathbb{C}(H)$ and $\mathbb{C}(\mathcal{M})$ act on $\mathcal{F}(H \times H)$. The action of a generic word $W(\hat{A}, \hat{B})$ on $Q_{(a,b)}$ will be denoted by

$$W(\hat{A}, \hat{B}) Q_{(a,b)} W^{-1}(\hat{A}, \hat{B}) = Q_{(w^{(a)}, w^{(b)})}. \tag{3.21}$$

where $(w^{(a)}, w^{(b)})$ is a pair of words in a and b and their inverses, representing the action of $W(A, B)$ on (a, b) .

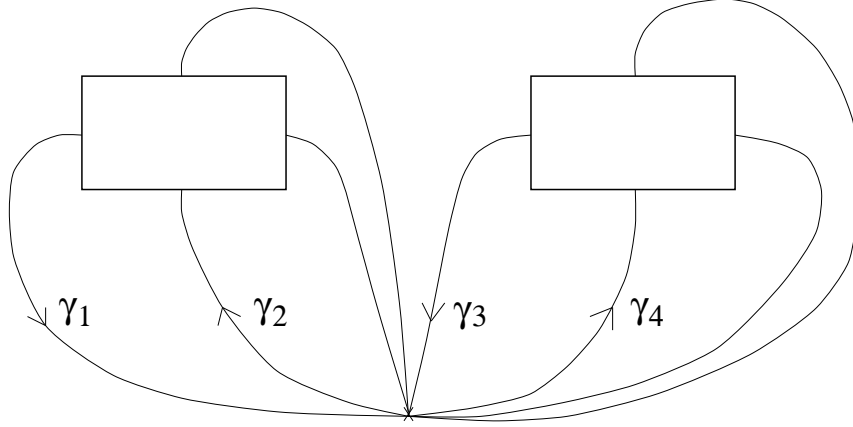

Fig. 3.4: The homotopy classes $[\gamma_i]$ ($1 \leq i \leq 4$) relative to the loops shown in the figure generate the fundamental group of plane with two geons.

There are two equivalent ways of presenting $\mathcal{A}^{(1)}$. One is by using the defining representation of (3.10), (3.12) and (3.17). Another way is to define $\mathcal{A}^{(1)}$ as the algebra generated by $Q_{(a,b)}$, $\hat{\delta}_g$, \hat{A} and \hat{B} with the relations (3.20). In any case, we have that

$$\mathcal{A}^{(1)} = \mathbb{C}(H \times \mathcal{M}) \ltimes \mathcal{F}(H \times H). \quad (3.22)$$

We shall now introduce the field algebra for two topological geons following exactly the same ideas as for a single topological geon. We recall that for a single geon, $\mathcal{A}^{(1)}$ consists of three sub-algebras, namely the “position observables” $\mathcal{F}(T)$, the H -transformations $\mathbb{C}(H)$, and the “translations”, i.e., a realization \mathcal{M} of the mapping class group M_Σ . The algebra $\mathcal{A}^{(2)}$ for two geons will consist of the same three distinct parts, with $T = H \times H \times H \times H \equiv H^4$ and Σ replaced by a plane with two handles.

We shall start by examining the fundamental group

$$\pi_1(\Sigma) = \pi_1(\mathbf{R}^2 \# \mathbf{T}^2 \# \mathbf{T}^2).$$

Let γ_i , $i = 1, 2, 3, 4$ be the loops shown by Fig. 3.4. One can show that $\pi_1(\Sigma)$ is the free group generated by $[\gamma_i]$. A “configuration” τ of two topological geons is given by a homomorphism $\tau : \pi_1(\Sigma) \rightarrow H$. Therefore τ is completely characterized by the holonomies $\tau(\gamma_i) \in H$ along the loops γ_i . Since there are no relations among $[\gamma_i]$ ’s, the holonomies $\tau(\gamma_1), \tau(\gamma_2), \tau(\gamma_3)$ and $\tau(\gamma_4)$ are four arbitrary elements of H . In other words, the set $T^{(2)}$ of configurations τ can be identified with $T^{(1)} \times T^{(1)} = (H \times H) \times (H \times H)$, where $T^{(1)}$ is the configuration space for a single geon. The corresponding algebra $\mathcal{F}(H^4)$ is thus the direct product of the algebra of single geons, i.e.,

$$\mathcal{F}(H^4) \cong \mathcal{F}(H \times H) \otimes \mathcal{F}(H \times H).$$

It is natural to work with the defining representation on $V \otimes V$ spanned by vectors of the form

$$|a_1, b_1\rangle \otimes |a_2, b_2\rangle,$$

where the subscripts denote the respective geons. The ‘‘position observables’’ are generated by projectors $Q_{(a_1, b_1)} \otimes Q_{(a_2, b_2)}$ acting on $V \otimes V$ in the obvious way, i.e.,

$$Q_{(a_1, b_1)} \otimes Q_{(a_2, b_2)} |a'_1, b'_1\rangle \otimes |a'_2, b'_2\rangle = \delta_{a_1, a'_1} \delta_{b_1, b'_1} \delta_{a_2, a'_2} \delta_{b_2, b'_2} |a_1, b_1\rangle \otimes |a_2, b_2\rangle. \quad (3.23)$$

Therefore, the ‘‘position’’ operators belong to $\mathcal{A}^{(1)} \otimes \mathcal{A}^{(1)}$.

The action of H -transformation $g \in H$ on the fluxes (a_1, b_1, a_2, b_2) is by a global conjugation. This induces the action

$$|a_1, b_1\rangle \otimes |a_2, b_2\rangle \rightarrow |ga_1g^{-1}, gb_1g^{-1}\rangle \otimes |ga_2g^{-1}, gb_2g^{-1}\rangle \quad (3.24)$$

on $V \otimes V$. The corresponding operator is obviously identified with $\hat{\delta}_g \otimes \hat{\delta}_g \in \mathbf{C}(H) \otimes \mathbf{C}(H)$, since

$$\hat{\delta}_g \otimes \hat{\delta}_g |a_1, b_1\rangle \otimes |a_2, b_2\rangle = |ga_1g^{-1}, gb_1g^{-1}\rangle \otimes |ga_2g^{-1}, gb_2g^{-1}\rangle. \quad (3.25)$$

Hence, H -transformation operators also belong to $\mathcal{A}^{(1)} \otimes \mathcal{A}^{(1)}$.

We now start to consider the action of the mapping class group M_Σ . For two or more geons, M_Σ is much more complicated than for a single geon [33]. The mapping class group is generated by Dehn twists of the type A and B (see Fig. 3.2) for each individual geon together with diffeomorphisms involving pairs of geons.

Let $A_i, B_i, i = 1, 2$ be the generators of the ‘‘internal diffeos’’ for each individual geon. The corresponding operators acting on $V \otimes V$ are clearly given by

$$\begin{aligned} \hat{A}_1 &= \hat{A} \otimes \mathbb{I}, & \hat{A}_2 &= \mathbb{I} \otimes \hat{A} \\ \hat{B}_1 &= \hat{B} \otimes \mathbb{I}, & \hat{B}_2 &= \mathbb{I} \otimes \hat{B} \end{aligned} \quad (3.26)$$

where \mathbb{I} is the identity operator on V .

There are two additional classes of transformations besides the internal diffeos. The first one, called exchange, is the analogue of the elementary braiding of two particles. The second, called handle slide, has no analogue for particles, since it makes use of the internal structure of the geon.

So far, all operators in the algebra for $\mathcal{A}^{(2)}$ were of the form $x \otimes y \in \mathcal{A}^{(1)} \otimes \mathcal{A}^{(1)}$. It turns out that this is not the case for exchanges and handle slides. They correspond somewhat to interactions and cannot be written strictly in terms of operators in $\mathcal{A}^{(1)} \otimes \mathcal{A}^{(1)}$. In order to describe interactions between geons, we need to define a pair of flip automorphisms of $V \otimes V$. They are necessary in the construction of the exchange and handle slide operators.

Definition: Given a two geon state

$$|a_1, b_1\rangle \otimes |a_2, b_2\rangle \in V \otimes V,$$

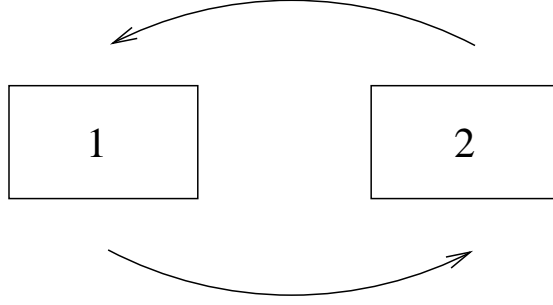

Fig. 3.5 Geon exchange.

the flip automorphisms σ and γ are defined by:

$$\begin{aligned}\sigma |a_1, b_1\rangle \otimes |a_2, b_2\rangle &:= |a_2, b_2\rangle \otimes |a_1, b_1\rangle, \\ \gamma |a_1, b_1\rangle \otimes |a_2, b_2\rangle &:= |a_1, b_2\rangle \otimes |a_2, b_1\rangle.\end{aligned}$$

Both are not given geometrically as morphisms of the mapping class group, but unless one introduces these operators, the algebra of two geons cannot be related directly to the algebras for a single geon. We will show that the algebra $\mathcal{A}^{(2)}$ can be obtained from the tensor product $\mathcal{A}^{(1)} \otimes \mathcal{A}^{(1)}$ when we add σ and γ .

In the exchange process, two geons permute their positions. In our convention, the geon on the right (left) moves counterclockwise to the position of the left(right) (see Fig. 3.5). The effect of a geon exchange on the states is of the form

$$\mathcal{R} |a_1, b_1\rangle \otimes |a_2, b_2\rangle = |c_1^{-1}a_2c_1, c_1^{-1}b_2c_1\rangle \otimes |a_1, b_1\rangle, \quad (3.27)$$

where $c_1 = a_1b_1a_1^{-1}b_1^{-1}$. This operator is equivalent to braiding operators for particles and also satisfy the Yang-Baxter equation,

$$(\mathcal{R} \otimes \mathbb{I})(\mathbb{I} \otimes \mathcal{R})(\mathcal{R} \otimes \mathbb{I}) = (\mathbb{I} \otimes \mathcal{R})(\mathcal{R} \otimes \mathbb{I})(\mathbb{I} \otimes \mathcal{R}). \quad (3.28)$$

One can verify that the exchange operator (3.27) may be written as the product

$$\mathcal{R} = \sigma R \quad (3.29)$$

where $R \in \mathcal{A}^{(1)} \otimes \mathcal{A}^{(1)}$ is the analogue of the universal R -matrix for a quasi-triangular Hopf algebra. In our case R is given by

$$R = \sum_{a,b} Q_{(a,b)} \otimes \hat{\delta}_{aba^{-1}b^{-1}}^{-1}. \quad (3.30)$$

The handle slide is shown in Fig. 3.6. In (a), the geon is viewed as a rectangular box on the plane. In (b), we have identified two edges of the rectangle and the geon is

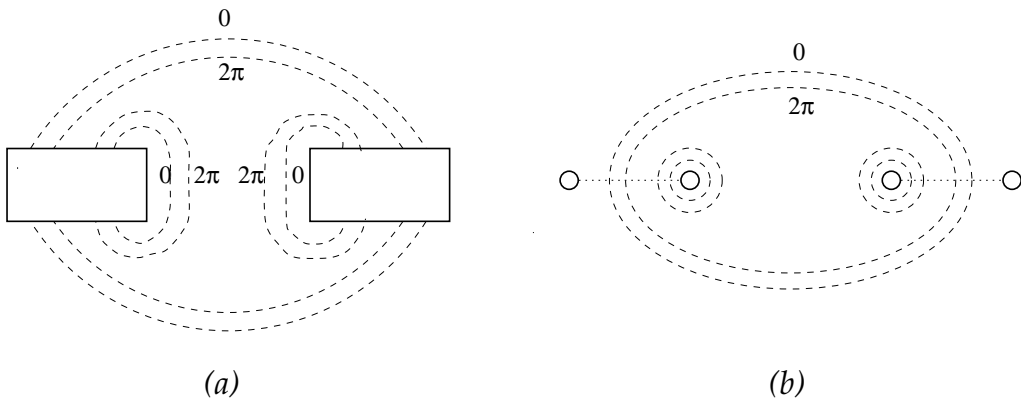

Fig. 3.6: The handle slide is interpreted geometrically as the full monodromy of two handles followed by a rotation of 2π of each handle. The figure shows two equivalent representations for the handle slide: In (a), the geon is viewed as a rectangular box on the plane. In (b), we have identified two edges of the rectangle and the geon is represented as two circles on the plane.

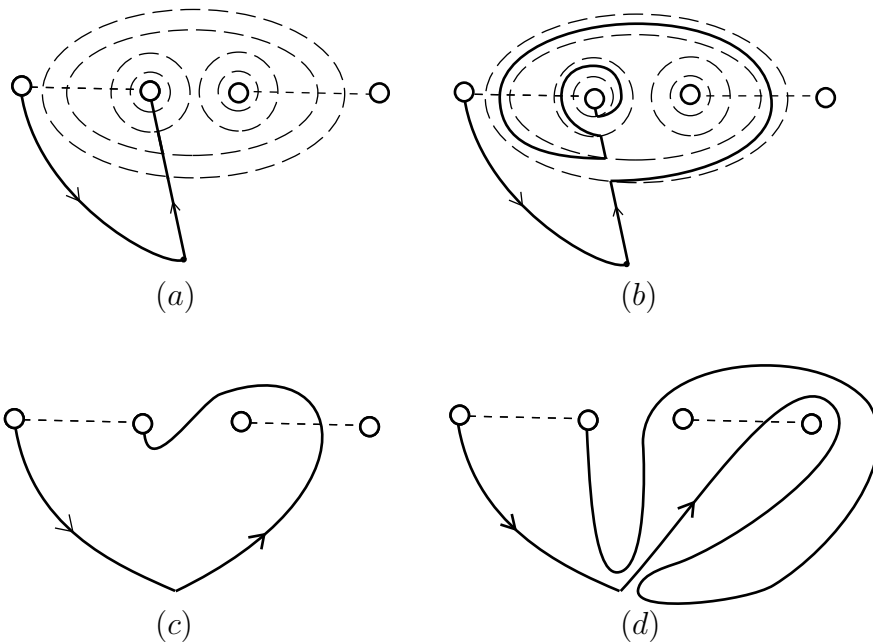

Fig. 3.7: Figure (a) shows the loop γ_1 defined on Fig. 3.4. The transformed loop $\tilde{\gamma}_1$ is indicated in (b). Figures (c) and (d) are two steps in the deformation of $\tilde{\gamma}_1$.

represented as two circles on the plane connected by dotted lines. The handle slide is defined as the operation that performs a double counterclockwise exchange of the 2nd and 3rd circles followed by a clockwise 2π -rotation of each one of them. As expected, this Dehn twist acts on the generators $[\gamma_i]$ of $\pi_1(\Sigma)$ given in Fig. 3.4, and therefore on the holonomies. Under the action of the transformation indicated in Fig. 3.6, the loops $[\gamma_i]$ will be mapped into new loops $[\tilde{\gamma}_i]$. As an example let us show how the handle slide acts on γ_1 . The loop γ_1 is shown in Fig. 3.7 (a). After the action of the diffeo, γ_1 is mapped to $\tilde{\gamma}_1$, indicated in Fig. 3.7 (b). We need to express $\tilde{\gamma}_1$ in terms of the generators $[\gamma_i]$. It is easy to see that $\tilde{\gamma}_1$ can be deformed to $\gamma_1\alpha\gamma_4$, where α is the loop enclosing the second geon. The sequence of deformations is indicated by Fig. 3.7 (b), (c) and (d). As α measures the total flux $a_2b_2a_2^{-1}b_2^{-1}$, it is easy to see that $\tilde{\gamma}_1$ will measure the flux $a_1(a_2b_2a_2^{-1})$. One can repeat the same procedure for the other loops and show that the action on the loops induces an action on $V \otimes V$ given by the following handle slide operator \mathcal{S} :

$$\begin{aligned} \mathcal{S} | a_1, b_1 \rangle \otimes | a_2, b_2 \rangle &= \\ &= | a_1(a_2b_2a_2^{-1}), (a_2b_2a_2^{-1})^{-1}b_1(a_2b_2a_2^{-1}) \rangle \otimes | (a_2b_2a_2^{-1})^{-1}b_1(a_2b_2a_2^{-1})a_2, b_2 \rangle. \end{aligned} \quad (3.31)$$

This is a very complicated action on states, but there is a way to write \mathcal{S} as a product of elements of $\mathcal{A}^{(1)} \otimes \mathcal{A}^{(1)}$ with flip automorphisms in the same way as the operator \mathcal{R} . The result is

$$\begin{aligned} \mathcal{S} &= \gamma \left(\mathbb{I} \otimes \sum_{g,h} Q_{(g,h)} \hat{\delta}_g \right) (\mathbb{I} \otimes B) \gamma \cdot \\ &\cdot \left(\mathbb{I} \otimes C_{\frac{\pi}{2}} \right) \gamma \left(\mathbb{I} \otimes \sum_{g,h} Q_{(h,g)} \hat{\delta}_{g^{-1}} \right) \gamma \cdot \\ &\cdot \gamma \left(\mathbb{I} \otimes C_{\frac{\pi}{2}} \right) \gamma \left(B^{-1} \otimes \mathbb{I} \right) \gamma \left(\mathbb{I} \otimes C_{-\pi} \right). \end{aligned} \quad (3.32)$$

This completes the description of $\mathcal{A}^{(2)}$. The algebra for two geons is generated by the elements of $\mathcal{A}^{(1)} \otimes \mathcal{A}^{(1)}$, \mathcal{R} and \mathcal{S} .

These constructions can be easily generalized to write down the algebra $\mathcal{A}^{(n)}$ for n geons. It is clear that

$$\underbrace{\mathcal{A}^{(1)} \otimes \dots \otimes \mathcal{A}^{(1)}}_n \subset \mathcal{A}^{(n)}.$$

The complete algebra $\mathcal{A}^{(n)}$ can be obtained by adding the operators \mathcal{R}_{ij} and \mathcal{S}_{ij} of exchange and handle slide between the i -th and the j -th geons. They can be easily constructed by using operators analogous to (3.29) and (3.32), acting on the i -th and j -th entries of $V \otimes \dots \otimes V$.

It is clear that the elements A_i , B_i , \mathcal{R}_{ij} and \mathcal{S}_{ij} of $\mathcal{A}^{(n)}$ generate, under multiplication, a group \mathcal{M}_n that is homomorphic to the mapping class group M_Σ for n geons. Besides

the relations proper to M_Σ , however, we will have extra relations so that \mathcal{M}_n becomes effectively finite.

4 The Geon as a Single Particle

We have seen up to now that a geon is a topological object with internal structure. In quantum theory, it can be described by the algebra $\mathcal{A}^{(1)}$. However, for a large distance observation, we may disregard the operators that probe its internal structure and describe it by a subalgebra $\mathcal{A}_L^{(1)}$. In this approximation, a topological geon seems to be no different from a particle on the plane, or a vortex in $(2+1)d$. We may guess that the large distance field algebra $\mathcal{A}_L^{(1)}$ is an algebra equivalent to $D(H)$, the quantum double introduced in Section 3. Actually this is not exactly true. We will see that $\mathcal{A}_L^{(1)}$ for a single geon has extra elements besides the ones corresponding to $D(H)$.

Long distance observables should not see the internal structure of the geon. For instance, in performing Aharonov-Bohm-type experiments in this long-distance scale, one should expect to see only the effects of the total flux, or the holonomy of the large loop $\gamma_{\mathbf{3}}$. Therefore, the only detectable projector in this scale is the one with support at the total flux c of a single geon. It is naturally defined as

$$Q_c^{(1)} := \sum_{a,b} \delta_{aba^{-1}b^{-1},c} Q_{(a,b)} . \quad (4.1)$$

The index (1) in $Q_c^{(1)}$ is to remind us that this large distance projector is an element of $\mathcal{A}^{(1)}$, the algebra of a single geon.

The algebra of operators $Q_c^{(1)}$ can easily be obtained from the algebra (3.11), resulting in

$$Q_{c_1}^{(1)} Q_{c_2}^{(1)} = \delta_{c_1, c_2} Q_{c_1}^{(1)} . \quad (4.2)$$

Hence, the algebra generated by $Q_c^{(1)}$ is isomorphic to $\mathcal{F}(H)$.

The H -transformation operators $\hat{\delta}_g \in \mathbb{C}(H)$ act on $Q_c^{(1)} \in \mathcal{F}(H)$. From (3.20) and (4.1), one can verify that

$$\hat{\delta}_g Q_c^{(1)} \hat{\delta}_g^{-1} = Q_{g c g^{-1}}^{(1)} . \quad (4.3)$$

Therefore $\hat{\delta}_g$ has to be regarded as a large distance operation. To make the notation uniform, we define

$$\hat{\delta}_g^{(1)} := \hat{\delta}_g . \quad (4.4)$$

The operators $Q_c^{(1)}$ should commute with local operators in $\mathcal{A}^{(1)}$, namely the diffeos \hat{A} and \hat{B} . This must be true since the action of the mapping class group cannot change

[γ_3]. That is because one can make γ_3 very large, such that the Dehn twists A and B do not act on γ_3 . See Fig. 3.1 and Fig. 3.2. In fact, one can verify that

$$\hat{A}Q_c^{(1)}\hat{A}^{-1} = \hat{B}Q_c^{(1)}\hat{B}^{-1} = Q_c^{(1)}. \quad (4.5)$$

Let us call $\mathcal{D}^{(1)} \subset \mathcal{A}^{(1)}$ the algebra generated by $Q_c^{(1)}$ and $\hat{\delta}_g^{(1)}$. It is clear that $\mathcal{D}^{(1)}$ is isomorphic to the Drin'feld quantum double $D(H) \cong \mathcal{F}(H) \otimes \mathbb{C}(H)$. As a consequence, $\mathcal{D}^{(1)}$ has the structure of a quasi-triangular Hopf algebra [18]. In this paper we will be interested mostly in two properties of a quasi-triangular Hopf algebra, namely the existence of a co-product and the universal R matrix.

A co-product on $\mathcal{D}^{(1)}$ is a linear map

$$\Delta : \mathcal{D}^{(1)} \longrightarrow \mathcal{D}^{(1)} \otimes \mathcal{D}^{(1)},$$

which is co-associative,

$$(\Delta \otimes Id) \circ \Delta = (Id \otimes \Delta) \circ \Delta,$$

and a morphism of algebras,

$$\Delta(a \cdot b) = \Delta(a) \cdot \Delta(b).$$

For the quantum double, the co-product has the expressions

$$\Delta(Q_c^{(1)}) = \sum_g Q_g^{(1)} \otimes Q_{g^{-1}c}^{(1)}. \quad (4.6)$$

and

$$\Delta(\hat{\delta}_g^{(1)}) = \hat{\delta}_g^{(1)} \otimes \hat{\delta}_g^{(1)}. \quad (4.7)$$

The quasi-triangularity of the quantum double implies the existence of an R -matrix, which is responsible for the exchange processes. The R -matrix for the quantum double can be written as

$$\mathcal{R}^{(1)} = \sigma \sum_{g \in H} Q_g^{(1)} \otimes \hat{\delta}_{g^{-1}}^{(1)}. \quad (4.8)$$

We recall that the full algebra $\mathcal{A}^{(1)}$ also has an R -matrix given by (3.29). One should ask whether the R -matrix (4.8) for the subalgebra $\mathcal{D}^{(1)} \subset \mathcal{A}^{(1)}$ is compatible with (3.29). It is a simple matter to show that they are actually identical.

We may think of the R -matrix for $\mathcal{A}^{(1)}$ as a trivial extension of the R -matrix of $\mathcal{D}^{(1)}$. An important question is whether it is also possible to extend the co-product to the entire algebra $\mathcal{A}^{(1)}$. We have reasons to believe that Δ cannot be extended. One reason is that the co-product is related to fusion of particles at the quantum level, which is physically reasonable. However, it is harder to imagine that two handles put together could be seen as a single handle.

Another large distance element in $A_L^{(1)}$ is the operator $C^{(1)}$ responsible for the Dehn twist on a cycle that encloses the entire geon. In other words, $C^{(1)}$ is the 2π -rotation of the geon:

$$C^{(1)} \equiv C_{2\pi}. \quad (4.9)$$

Note that $C^{(1)}$ commutes with all elements of $\mathcal{D}^{(1)}$. Since $C_{2\pi}^N = \mathbb{I}$ for some N , it generates a group algebra isomorphic to $\mathbb{C}(\mathbb{Z}_N)$.

Summarizing, the long distance algebra $\mathcal{A}_L^{(1)}$ is isomorphic to $D(H) \otimes \mathbb{C}(\mathbb{Z}_N)$. In other words, on a large distance scale, a geon is equivalent to a particle with a frame.

Consider next the two-geon configuration and its corresponding algebra $\mathcal{A}^{(2)}$. The associated long distance algebra can be visualized as follows. Let the two geons shrink to localized objects and at the same time approach each other. At the end a point-like object will remain and we should look for the operators that still make sense in the limit. It is clear that such operators will be a) the total flux projector $Q_c^{(2)}$ of the two geons; b) the H -transformations and c) the Dehn twist around a cycle enclosing both geons.

The projection operator for the total flux of the system is given by

$$Q_c^{(2)} := \sum_{a,b,a',b'} \delta_{aba^{-1}b^{-1}a'b'a'^{-1}b'^{-1},c} Q_{(a,b)} \otimes Q_{(a',b')}. \quad (4.10)$$

The index (2) indicates that $Q_c^{(2)}$ is an element of $\mathcal{A}^{(2)}$. One can write this expression in a more transparent way as follows:

$$Q_c^{(2)} = \sum_g Q_g^{(1)} \otimes Q_{g^{-1}c}^{(1)}. \quad (4.11)$$

Similarly, the H -transformation is given by

$$\hat{\delta}_g^{(2)} := \hat{\delta}_g^{(1)} \otimes \hat{\delta}_g^{(1)}. \quad (4.12)$$

If we compare the last two equations with the definition (4.6)-(4.7), we see that

$$Q_c^{(2)} = \Delta(Q_c^{(1)}), \quad (4.13)$$

$$\hat{\delta}_g^{(2)} = \Delta(\hat{\delta}_g^{(1)}). \quad (4.14)$$

Let us denote by $\mathcal{D}^{(2)}$ the algebra generated by $Q_c^{(2)}$ and $\hat{\delta}_g^{(2)}$. From (4.13) and (4.14) it follows that $\mathcal{D}^{(2)}$ is homomorphic to $\mathcal{D}^{(1)}$. Actually, it is a simple matter verify that they are isomorphic.

As in the previous case, the long distance algebra $\mathcal{A}_L^{(2)}$ has an extra generator given by the Dehn twist $C^{(2)}$ on a cycle enclosing both geons, with

$$C^{(2)} = \mathcal{R}^2. \quad (4.15)$$

As one would expect, the algebra $\mathcal{A}_L^{(2)}$ is isomorphic to $D(H) \otimes \mathbb{C}(\mathbb{Z}_N)$ and therefore also describes a particle with a frame.

It is clear now what is the long distance algebra $\mathcal{A}_L^{(n)}$ for n geons. It is generated by the Dehn twist $C^{(n)}$ on a cycle enclosing the n geons, together with elements $Q_c^{(n)}, \hat{\delta}_g^{(n)} \in \mathcal{A}^{(1)} \otimes \dots \otimes \mathcal{A}^{(1)}$ given by the iterative application of the co-product. For example, for $n = 3$,

$$Q_c^{(3)} = (Id \otimes \Delta) \otimes \Delta(Q_c^{(1)}), \quad (4.16)$$

$$\hat{\delta}_g^{(3)} = (Id \otimes \Delta) \otimes \Delta(\hat{\delta}_g^{(1)}). \quad (4.17)$$

Notice that because of the co-associativity property, we could have written $(\Delta \otimes Id) \otimes \Delta$ instead of $(Id \otimes \Delta) \otimes \Delta$ in the last two formulae.

5 Quantization

The algebra $\mathcal{A}^{(1)}$ describes the topological degrees of freedom for a single geon on the plane. To quantize the system we need to find an irreducible representation of $\mathcal{A}^{(1)}$ on a Hilbert space \mathcal{H} . However, this Hilbert space will branch into irreducible representations of the field algebra:

$$\mathcal{H} = \oplus_r \mathcal{H}_r, \quad (5.1)$$

where \mathcal{H}_r denotes a particular irreducible representation describing a certain geon type. The algebra is finite dimensional, and therefore there will be a finite number of irreducible representations of $\mathcal{A}^{(1)}$. Furthermore, the Hilbert spaces \mathcal{H} are all finite dimensional. Each representation gives us a possible one-geon sector of the theory.

In the case of quantum doubles, the irreducible representations are fully classified. See for instance ref. [35]. For the case of geons, the algebra is more complicated because of the existence of internal structure. Nevertheless, the representations of $\mathcal{A}^{(1)}$ are quite similar to the ones of the quantum double of a finite group. This is not totally surprising, since in a certain limit, as discussed in the previous section, we recover the quantum double $\mathcal{D}^{(1)} \cong D(H)$. Actually, we can define a class of algebras \mathcal{A} that can have its representations classified and that are generic enough to contain the quantum double and the algebra $\mathcal{A}^{(1)}$ as particular cases. In the spirit of [35], one can then get all representations of \mathcal{A} .

Definition: Let X be a finite set and G a finite group acting on X . In other words, there is a map $\alpha_g : X \rightarrow X$ for each $g \in G$. As usual, we denote by $\mathcal{F}(X)$ the algebra of functions on X and by $\mathbb{C}(G)$ the group algebra of G . We define the algebra \mathcal{A} as the vector space

$$\mathcal{A} := \mathcal{F}(X) \otimes \mathbb{C}(G)$$

with basis elements denoted by (Q_x, g) , $Q_x \in \mathcal{F}(X)$ and $g \in \mathbb{C}(G)$, and the multiplication

$$(Q_x, g) \cdot (Q_y, h) := (Q_x Q_{\alpha_g(y)}, gh). \quad (5.2)$$

Here, Q_x is the characteristic function supported at $x \in X$. Let x_0 be an element of X . We denote by $K_{x_0} \subset G$ the stability subgroup with respect to x_0 , i.e.,

$$K_{x_0} = \{g \in G \mid \alpha_g(x_0) = x_0\} . \quad (5.3)$$

The stability subgroup K_{x_0} divides the group G into equivalence classes of left cosets. Let N be the number of equivalence classes and let us choose a representative $\xi_i \in G$, $i = 1 \dots N$ for each class, with the convention that $\xi_1 = e$. We can write the following partition of G into left cosets:

$$G = \xi_1 K_{x_0} \cup \xi_2 K_{x_0} \cup \dots \cup \xi_N K_{x_0} . \quad (5.4)$$

Let us point out that $\mathbb{C}(G)$ seen as a vector space carries a left representation of G , the action of G being by left product. All irreducible representations of G can be obtained by reducing this representation. In particular, any vector space carrying an irreducible representation (IRR) of K_{x_0} can be viewed as a subspace of $\mathbb{C}(G)$.

Note that $\mathcal{F}(X)$ plays a dual role: it is an algebra, but it is itself a vector space which is acted upon by the group G , according to $gQ_x := Q_{\alpha_g(x)}$. This can be extended to an action of $\mathbb{C}(G)$ in the obvious way. Also, it acts upon itself by left (pointwise) product. In what follows we shall denote the elements Q_x by $|x\rangle$ whenever we want to view it as a vector belonging to the representation of $\mathbb{C}(G)$ on $\mathcal{F}(X)$ just defined. In this ‘‘passive’’ role it is acted upon, instead of acting on some representation of the algebra of functions.

We can now state the following result.

Theorem Let $|j\rangle_\rho$, $j = 1 \dots n$ be a basis of a subspace V_ρ of $\mathbb{C}(G)$ carrying an IRR ρ of K_{x_0} . Then, for (a fixed) $x_0 \in X$, elements $\xi_i \in G$, $i = 1 \dots N$ and $|j\rangle_\rho \in \mathbb{C}(G)$, $j = 1 \dots n$ as stated above, the vectors

$$\xi_i |x_0\rangle \otimes |j\rangle_\rho := |\alpha_{\xi_i}(x_0)\rangle \otimes |j\rangle_\rho ,$$

form a basis for an IRR of the algebra \mathcal{A} , given by

$$(Q_x, g) |\alpha_{\xi_i}(x_0)\rangle \otimes |j\rangle_\rho := \delta_{x, \alpha_{\xi_{i'}}(x_0)} |\alpha_{\xi_{i'}}(x_0)\rangle \otimes \Gamma^{(\rho)}(\beta)_{kj} |k\rangle_\rho ,$$

where $\xi_{i'}$ and β are uniquely determined by the equation

$$g\xi_i = \xi_{i'}\beta ,$$

and $\Gamma^{(\rho)}$ is the matrix for the representation ρ .

This result follows from a standard construction in induced representation theory (cf. discussion of the Poincaré group in [36]).

The quantum double $D(H)$ and the algebra $\mathcal{A}^{(1)}$ are particular cases of \mathcal{A} . The quantum double is obtained by taking $X = H$, $G = H$, with the action $\alpha_g(h) = ghg^{-1}$. As for the algebra of a single geon, one takes

$$X = H \times H$$

and for the group G the product $H \times \mathcal{M}$. The actions of $\hat{\delta}_g \in H$ and $W \in \mathcal{M}$ commute and are given by

$$\alpha_g(a, b) = (gag^{-1}, bgb^{-1}), \quad g \in H$$

and

$$\alpha_W(a, b) = (w^{(a)}, w^{(b)}), \quad W \in \mathcal{M},$$

where we have used the notation of (3.21). The IRR's for the algebra (3.22) can be constructed given an element $(a, b) \in H \times H$. The stability subgroup $K_{(a,b)} \subset H \times H$ is defined by

$$K_{(a,b)} = \left\{ (g, W) \in H \times \mathcal{M} \mid \alpha_g \alpha_W(a, b) := (gw^{(a)}g^{-1}, gw^{(b)}g^{-1}) = (a, b) \right\}. \quad (5.5)$$

Then, after choosing representatives ξ_1, \dots, ξ_N for the cosets, the partition of $H \times \mathcal{M}$ can be written as

$$H \times \mathcal{M} = \xi_1 K_{(a,b)} \cup \xi_2 K_{(a,b)} \cup \dots \cup \xi_N K_{(a,b)}. \quad (5.6)$$

Let $|1\rangle, \dots, |n\rangle \in \mathbf{C}(H \times \mathcal{M})$ be a basis of an IRR of $K_{(a,b)}$. Then, according to the theorem, the vectors

$$|\alpha_{\xi_i}(a, b)\rangle \otimes |j\rangle_\rho, \quad (5.7)$$

with $i = 1 \dots N, j = 1 \dots n$, form a basis of an IRR of the algebra $\mathcal{A}^{(1)}$.

Let us express the representations of $\mathcal{A}^{(1)}$ in a more compact notation. The action of $H \times \mathcal{M}$ on $X = H \times H$ divides X into orbits. We denote by $[a, b]$ the orbit containing the element $(a, b) \in H \times H$. We will collectively call ρ the quantum numbers labeling the IRR's of $K_{(a,b)}$. One can see from (5.7) that an IRR r is characterized by a pair $r = ([a, b], \rho)$. A basis for an IRR r of $\mathcal{A}^{(1)}$ will therefore be written as vectors $|i, j\rangle_r^{(a,b)}$, $i = 1, \dots, N; j = 1, \dots, n$ defined by

$$|i, j\rangle_r^{(a,b)} := \xi_i |a, b\rangle \otimes |j\rangle_\rho \quad (5.8)$$

where $|a, b\rangle$ is a state in the defining representation, ξ_i are the same as in (5.6) and $|j\rangle_\rho$ are base elements in the irreducible representations ρ of $K_{(a,b)}$. Of course, the set of vectors thus defined depend on the pair (a, b) we choose. We fix an a and a b , and henceforth omit the superscript.

The action of $Q_{(a', b')}$ is given by

$$Q_{(a', b')} |i, j\rangle_r = Q_{(a', b')} \xi_i |a, b\rangle \otimes |j\rangle_\rho = Q_{(a', b')} |a_i, b_i\rangle \otimes |j\rangle_\rho = \delta_{a', a_i} \delta_{b', b_i} |i, j\rangle_r. \quad (5.9)$$

Let $\hat{\delta}_g W$ be a generic element of $H \times \mathcal{M}$. The equation

$$\hat{\delta}_g W \xi_i = \xi_{i'} \beta \quad (5.10)$$

defines uniquely a new class $\xi_{i'}$, together with an element of the stability group $\beta \in K_{(a,b)}$. The action of $\hat{\delta}_g W \in \mathcal{A}^{(1)}$ on $|i, j\rangle_r$ is determined by (5.10) and it reads

$$\begin{aligned} \hat{\delta}_g W |i, j\rangle_r &= \xi_{i'} |a, b\rangle \otimes \beta |j\rangle_\rho = \\ &= \sum_k \Gamma^{(\rho)}(\beta)_{kj} |i', k\rangle_r \end{aligned} \quad (5.11)$$

where $\Gamma^{(\rho)}$ is the matrix representation of $K_{(a,b)}$.

Each IRR $r = ([a, b], \rho)$ describes a distinct quantum geon. The corresponding vector spaces \mathcal{H}_r generated by states $|i, j\rangle_r$, are all finite dimensional. Therefore we can easily make it into a Hilbert space by introducing the scalar product

$$\langle i', j' | i, j \rangle_r = \delta_{ii'} \delta_{jj'}. \quad (5.12)$$

Since the algebras $\mathcal{A}^{(1)}$ are not the same for different choices of the discrete group H , we cannot say in general what is the spectrum of a geon. First, we need to fix a group H and then compute the spectrum for the corresponding $\mathcal{A}^{(1)}$.

Consider now two geons described by representations r_1 and r_2 . The associated Hilbert space of states is simply

$$\mathcal{H}^{(12)} := \mathcal{H}_{r_1} \otimes \mathcal{H}_{r_2}. \quad (5.13)$$

As explained in Section 3, the field algebra consists of $\mathcal{A}^{(1)} \otimes \mathcal{A}^{(1)}$ together with \mathcal{R} and \mathcal{S} . The elements of $\mathcal{A}^{(1)} \otimes \mathcal{A}^{(1)}$ act naturally on (5.13). It remains to be said what is the action of \mathcal{R} and \mathcal{S} on states in $\mathcal{H}_{r_1} \otimes \mathcal{H}_{r_2}$.

The action of \mathcal{R} is completely determined by the formula (3.29):

$$\mathcal{R} = \sigma \sum_{a,b} Q_{(a,b)} \otimes \hat{\delta}_{aba^{-1}b^{-1}}^{-1}.$$

In other words

$$\mathcal{R} |i, j\rangle_{r_1} \otimes |k, l\rangle_{r_2} = \sum_{a,b} \hat{\delta}_{aba^{-1}b^{-1}}^{-1} |k, l\rangle_{r_2} \otimes Q_{(a,b)} |i, j\rangle_{r_1}. \quad (5.14)$$

The generalization for n geons is straightforward.

We may think of \mathcal{R} and \mathcal{S} as scattering matrices for a pair of geons. The \mathcal{R} -matrix represents an ‘‘elastic’’ interaction in the sense that two incoming geons of quantum numbers r_1 and r_2 are scattered into two objects carrying the same quantum numbers r_1 and r_2 . The handle slide \mathcal{S} on the contrary is a nontrivial scattering, each one of the two outgoing geons being a superposition of many geons in the spectrum.

6 Quantum Topology Change

In this paper we have considered $(2 + 1)d$ manifolds such that any spatial slice consists of a plane with a certain number n of handles. In other words, for each fixed time, the configuration consists of n geons. If the number of geons is not fixed, we say that topology can change. Creation of baby universes is also a topology-changing process, but we will not consider it here for reasons that should become clear in what follows.

Our system is described by a certain field algebra $\mathcal{A}^{(n)}$, and its quantization is given by a representation of $\mathcal{A}^{(n)}$. A change in the number of geons means necessarily a change in the field algebra. Let us see how that can be accomplished. Let us suppose that a geon, represented by a square with opposite sides identified, has a typical size l that can vary with time. Intuitively, a geon can disappear if l becomes too small. In this case, a geon will resemble a point-like object. Let us consider the limiting case $l \rightarrow 0$. It is clear that the holonomies associated with loops γ_1 and γ_2 of Fig. 3.1 do not make sense in this limit. The only flux observable available in this limit is the holonomy of γ_3 , responsible for measuring the total flux. The algebra describing the limiting situation is the one-particle approximation $\mathcal{A}_L^{(1)} \subset \mathcal{A}^{(1)}$ introduced in Section 4. Actually, we do not need to consider the limit $l \rightarrow 0$, since our description is supposed to be an effective theory that is not valid beyond a certain scale of energy (distance). We may say that after the geon has become very small, the operators associated with individual fluxes no longer belong to the low energy (large distance) description.

The structure of the field algebra tells us that a geon can turn into a point-like object, but it cannot disappear. However, this is only a semi-classical description.

The quantum theory is described by states belonging to an IRR r of $\mathcal{A}^{(1)}$. From the inclusion

$$i^{(1)} : \mathcal{A}_L^{(1)} \hookrightarrow \mathcal{A}^{(1)}, \quad (6.1)$$

it follows that r is also a (in general reducible) representation of $\mathcal{A}_L^{(1)}$. Let \mathcal{H}_r be the vector space carrying the representation r . In general, \mathcal{H}_r is decomposable as a direct sum

$$\mathcal{H}_r = \bigoplus_{\sigma} N_{\sigma}^r V_{\sigma}, \quad N_{\sigma}^r \in \mathbb{N} \quad (6.2)$$

where V_{σ} carries the IRR σ of $\mathcal{A}_L^{(1)}$. The long distance observer does not see operators mixing different IRR's.

Therefore, a long distance observer interprets (6.2) as saying that a geon carrying a representation r can decay into different *particles* carrying representations σ . It could happen that the trivial representation $\sigma = 0$ of $\mathcal{A}_L^{(1)}$ occurs in (6.2). In this case, for an observer working only with $\mathcal{A}_L^{(1)}$, *there will be a non-zero probability of seeing the vacuum*.

As an example, let us next characterize the vacuum representation and discuss vacuum decay.

The IRR's of $\mathcal{A}_L^{(1)}$ are classified in a similar way as for $\mathcal{A}^{(1)}$. The trivial IRR on V_0 in the decomposition (6.2) is generated by any state $|\text{VAC}\rangle \in \mathcal{H}_r$ satisfying

$$Q_c^{(1)} |\text{VAC}\rangle = \delta_{e,c} |\text{VAC}\rangle, \quad (6.3)$$

$$\hat{\delta}_g^{(1)} |\text{VAC}\rangle = |\text{VAC}\rangle, \quad (6.4)$$

$$C^{(1)} |\text{VAC}\rangle = |\text{VAC}\rangle. \quad (6.5)$$

We will call such state vacuum. It is not difficult to show that a representation

$r = ([a, b], \rho)$ contains states satisfying (6.3) if and only if $aba^{-1}b^{-1}$ is the identity. Furthermore, under the condition

$$aba^{-1}b^{-1} = e,$$

all states of \mathcal{H}_r , $r = ([a, b], \rho)$, fulfill equation (6.3). We are thus left with the conditions (6.4) and (6.5) for defining the vacuum state. They simply mean that $|VAC\rangle$ is an identity representation of the group $H \times \mathbf{Z}_N$, where \mathbf{Z}_N is generated by $C^{(1)} = \hat{C}_{2\pi}$.

Note that vacuum decay occurs naturally, for example, in all IRR's of $\mathcal{A}^{(1)}$ of the form $r = ([a, b], \epsilon)$, where a and b are in the center of H and ϵ is the trivial representation of the stability subgroup of (a, b) , which in this case is the whole of $H \times \mathcal{M}$. The vectors in this representation clearly satisfy all conditions and therefore will decay into vacuum states.

The vector space \mathcal{H}_r may contain more than one copy of the identity representation of $H \times \mathbf{Z}_N$. We will denote the set of corresponding orthonormal vectors by

$$|VAC; l\rangle, \quad l = 1, 2, \dots, N_0^r.$$

Finding all $|VAC; l\rangle$ in a given decomposition of each \mathcal{H}_r is a group theoretical problem that can be solved for specific choices of the discrete group H . We shall not attempt this here.

The probability $P(\psi)$ of a normalized state $|\psi\rangle \in \mathcal{H}_r$ to decay into the vacuum is then given by

$$P(\psi) = \begin{cases} \sum_l |\langle VAC; l | \psi \rangle|^2 \neq 0 & \text{if } N_0^r \neq 0, \\ = 0 & \text{if } N_0^r = 0. \end{cases} \quad (6.6)$$

If $N_0^r = 0$, a single geon described by r cannot decay into the vacuum. However, two geons colored by r and r' may annihilate each other. The two geons can shrink to localized objects and at the same time approach each other. The process can also be interpreted as a change in the scale of observations to long distances. At the end a point-like object will remain and should be described by the algebra $\mathcal{A}_L^{(2)}$ introduced in Section 4. From the inclusion

$$i^{(2)} : \mathcal{A}_L^{(2)} \hookrightarrow \mathcal{A}^{(2)} \quad (6.7)$$

follows that the space of states $\mathcal{H}_r \otimes \mathcal{H}_{r'}$ of the two geons is a (reducible) representation of $\mathcal{A}_L^{(2)}$. Let σ denote as before the IRR's of $\mathcal{A}_L^{(2)}$, with corresponding vector spaces V_σ . Then

$$\mathcal{H}_r \otimes \mathcal{H}_{r'} = \bigoplus_{\sigma} N_{\sigma}^{(r,r')} V_{\sigma}, \quad N_{\sigma}^{(r,r')} \in \mathbb{N}. \quad (6.8)$$

Therefore, the operators of $\mathcal{A}_L^{(2)}$ can see the vacuum if $N_0^{(r,r')}$ is not zero. The vacuum representation and the vacuum probability decay are given by formulae analogous to (6.3)-(6.6).

It is clear now how to describe the decay into the vacuum of an arbitrary number of geons. Consider n geons described by representations r_1, \dots, r_n . The space of states

$\mathcal{H}_{r_1} \otimes \dots \otimes \mathcal{H}_{r_2}$ is a representation of the long distance algebra $\mathcal{A}_L^{(n)} \subset \mathcal{A}^{(n)}$ described in Section 4. The system may decay into the vacuum if this representation contains the trivial representation of $\mathcal{A}_L^{(n)}$.

7 Concluding Remarks

In this work we have developed an algebraic model for topological geons which describes topology change as a purely quantum phenomenon rather than the usual classical sense of cobordisms between two non-homeomorphic spatial manifolds Σ and Σ' . Instead, our formalism revealed what an observer, probing the topology of space by using only quantum operators and quantum states, would be able to see.

The key point was that in resorting to a field theory to infer the underlying spatial topology, one could only take into account those operators which were compatible with the scale of observations, since no other operator would have a sensible physical meaning in the theory. The passage from a larger scale of observations to a smaller one was represented, on a more technical level, by selecting a subalgebra of the original algebra describing the system in the quantum theory. The quantum states of the system, which in the case of geons give a direct information on the spatial topology, could now decay into the vacuum, leading the would-be observer to conclude that a topology change has occurred.

There is another, perhaps more intuitive view of the sort of topology change we have envisaged in this paper. As pointed out in Section 3 for the case of vortices, those classical configurations for which holonomies are trivial around some “topological blob”, be it a vortex or a geon, are indistinguishable from those in which this “blob” is absent, or “vacuum” configurations. If we view quantum states as wave functions, it is clear that their role is to assign a probability to each classical configuration. A quantum transition to states which are very sharply peaked, or localized at the aforementioned “vacuum” configurations will be interpreted by an observer as a quantum topology change. Such states correspond to the vacuum states of Section 6.

We have restricted ourselves to a simple theory, where complications arising from local degrees of freedom were absent (the theory we considered is topological in the limit of very low energies), and we could concentrate on the topological aspects more unobtrusively.

Of independent value is the algebra describing the topological geons. The finite group H can be generalized to a Lie group G . Of special interest is the case $G = SO(2,1)$, which describes geons in the presence of gravity. A suitable generalization of our formalism promptly discloses a whole spectrum of geon types in quantum gravity, and many interesting properties of these entities can be explored, as for instance spin-statistics connection. Although this issue has been extensively studied in the literature, our formalism may shed new light on some points. This subject will be investigated in a forthcoming

paper [3].

Acknowledgments

We would like to thank J.C.A. Barata, B.G.C. da Cunha, A. Momen and S. Vaidya for many helpful discussions. The work of A.P. Balachandran was supported by the Department of Energy, U.S.A., under contract number DE-FG02-85ERR40231. The work of E. Batista, I.P. Costa e Silva and P. Teotonio-Sobrinho was supported by FAPESP, CAPES and CNPq respectively. A.P.B. acknowledges the wonderful hospitality of Denjoe O'Connor and support of CINVESTAV at Mexico, D.F. while this work was being completed.

References

- [1] J. Wheeler: *Ann. Phys.* **2** (1957) 604.
- [2] See for example: R.P. Geroch, *J. Math. Phys.* **8** (1967) 782;
F.J. Tipler, *Ann. of Phys.* **108** (1977) 1;
S.W. Hawking, *Nucl. Phys.* **B144** (1978) 349;
R. Sorkin, *Phys. Rev.* **D33** (1986) 978;
A. Anderson and B. DeWitt, *Found. Phys.* **16** (1986) 91;
C.A. Manogue, E. Copeland and T. Dray, *Parmana* **30** (1988) 279;
G. Horowitz, *Class. Quant. Grav.* **8** (1991) 587.
- [3] A.P. Balachandran, E. Batista, I.P. Costa e Silva and P. Teotonio-Sobrinho: “The Spin-Statistics Connection in Quantum Gravity”, hep-th/9906174 and *Nucl. Phys.* (in press).
- [4] R. Sorkin: “Introduction to Topological Geons”, in *Topological Properties and Global Structure of Spacetime*, edited by P.G. Bergmann and V. de Sabbata, Plenum, New York (1986).
- [5] J.L. Friedman and R.D. Sorkin: *Phys. Rev. Lett.* **44** (1980) 1100;
J.L. Friedman and R.D. Sorkin: *Gen. Rel. Grav.* **14** (1982) 615.
- [6] J.E. Roberts: “Lectures on Algebraic Quantum Field Theory”, in *The Algebraic Theory of Superselection Sectors. Introduction and Recent Results*, edited by D. Kastler, World Scientific, Singapore (1990).
- [7] P.S. Aspinwall, B.R. Greene and D.R. Morrison: *J. Math. Phys.* **35** (1994) 5321.
- [8] G.W. Gibbons and S.W. Hawking: “Euclidean Quantum Gravity”, World Scientific (1993).
- [9] A.P. Balachandran, G. Bimonte, G. Marmo, A. Simoni: *Nucl. Phys.* **B446** (1995) 299-314, gr-qc/9503046.

- [10] D. Marolf: Phys.Lett. **B392**(1997)287-290, gr-qc/960203.
- [11] A.P. Balachandran, A. Daughton, Z.C. Gu, G. Marmo, R.D. Sorkin and A.M. Srivastava: Int. J. Mod. Phys. **A8** (1993) 2993.
- [12] H.F. Dowker and R.D. Sorkin: Class. Quant. Grav. **15** (1998) 1153, gr-qc/9609064.
- [13] R.D. Sorkin and S. Surya: “Geon Statistics and UIRs of the Mapping Class Group”, hep-th/9704081.
- [14] M. Kriele: Class. and Quantum Grav. **9** (1992) 1863; S. Carlip: Class. Quant. Grav. **10** (1993) 207, hep-th/9206103, and “Lectures on (2+1) Dimensional Gravity”, gr-qc/9503024.
- [15] E. Witten: Comm. Math. Phys. **121** (1989) 351.
- [16] V.F.R. Jones: Bull. of Amer. Math. Soc. **12** (1985) 103.
- [17] L.H. Kauffman: “Knots and Physics”, World Scientific (1991).
- [18] C. Kassel: “Quantum Groups”, Springer-Verlag (1995).
- [19] N. Reshetikhin and V.G. Turaev: Invent. Math. **103** (1991) 547.
- [20] N. Seiberg and E. Witten: Nucl. Phys. **B426** (1994) 19.
- [21] A.P. Balachandran and P. Teotonio-Sobrinho: Int. Jour. Mod. Phys. **A8**(1993) 723-752, hep-th/9205116.
- [22] T.H. Koornwinder and N.M. Muller: J. Lie Theory **7** (1997), 33-52;
T.H. Koornwinder, F.A. Bais and N.M. Muller: Commun. Math. Phys. **198** (1998) 157, q-alg/9712042.
- [23] M.D.F. de Wild Propitius and F.A. Bais: *Discrete Gauge Theories* Proc. CRM-CAP Summer School “Particles and Fields 94”, Banff, Springer Verlag (1996), hep-th/9511201
M.D.F. de Wild Propitius: *Topological Interactions in Broken Gauge Theories*, PhD. thesis University of Amsterdam, 1995, hep-th/9511195.
- [24] A.P. Balachandran, A. Momen, P. Teotonio-Sobrinho and S. Vaidya: “Topological Quantization and Quantum Groups”, to appear.
- [25] K.M. Lee: Phys. Rev. **D49** (1994) 2030.
- [26] J.A. Wheeler: Phys. Rev. **97** (1955) 511-536, “Geometrodynamics”, Academic Press, New York and London, 1962.
- [27] J.L. Friedman and D.M. Witt: Phys. Lett. B **120** (1983) 324;
D.M. Witt: J. Math. Phys. **27** (1986) 573.

- [28] C. Aneziris, A.P. Balachandran, M. Bourdeau, S. Jo, T.R. Ramadas and R.D. Sorkin: *Mod. Phys. Lett.* **A4** (1989) 331;
C. Aneziris, A.P. Balachandran, M. Boureau, S. Jo, R.D. Sorkin and T.R. Ramadas: *Int. Jour. Mod. Phys.* **A4** (1989) 5459.
- [29] R.D. Sorkin and Sumati Surya: *Int. J. Mod. Phys.* **A13** (1998) 3749, gr-qc/9605050.
- [30] J. Samuel: *Phys. Rev. Lett.* **71** (1993) 215.
- [31] See for example J. Stillwell: “Classical Topology and Combinatorial Group Theory”, Springer-Verlag, New York, 1980.
- [32] J. Hempel: “3-Manifolds”, Princeton University Press and University of Tokyo Press, Princeton, New Jersey (1976).
- [33] J.S. Birman: “Braids, Links and Mapping Class Groups”, Princeton University Press (1972).
- [34] A.P. Balachandran,, G. Marmo, B.S. Skagerstam and A. Stern: “Classical Topology and Quantum States”, World Scientific (1991).
- [35] K. Szlachányi and P. Vecsernyés: “Quantum Symmetry and Braid Group Statistics in G -Spin Models”, *Comm. Math. Phys.* **156** (1993) 127.
- [36] A.P. Balachandran and C.G. Trahern: “Lectures on Group Theory for Physicists”, *Monographs and Textbooks in Physical Science 3*, Bibliopolis, Napoli (1985).
- [37] R. Dijkgraaf and E. Witten: *Commun. Math. Phys.* **129** (1990) 393.
- [38] D.S. Freed and F. Quinn: *Commun. Math. Phys.* **156** (1993) 435.
- [39] N. Steenrod: “The Topology of Fibre Bundles”, Princeton University Press, Princeton (1951).