

Ribbon-moves of 2-links preserve the μ -invariant of 2-links

Eiji Ogasa

ogasa@ms.u-tokyo.ac.jp

Department of Physics, University of Tokyo
Hongo, Tokyo 113, JAPAN

Abstract. We introduce ribbon-moves of 2-knots, which are operations to make 2-knots into new 2-knots by local operations in B^4 . (We do not assume the new knots is not equivalent to the old ones.)

Let L_1 and L_2 be 2-links. Then the following hold.

(1) If L_1 is ribbon-move equivalent to L_2 , then we have

$$\mu(L_1) = \mu(L_2)$$

(2) Suppose that L_1 is ribbon-move equivalent to L_2 . Let W_i be arbitrary Seifert hypersurfaces for L_i . Then the torsion part of $H_1(W_1) \oplus H_1(W_2)$ is congruent to $G \oplus G$ for a finite abelian group G .

(3) Not all 2-knots are ribbon-move equivalent to the trivial 2-knot.

(4) The inverse of (1) is not true.

(5) The inverse of (2) is not true.

Let $L = (L_1, L_2)$ be a sublink of homology boundary link. Then we have:

(i) L is ribbon-move equivalent to a boundary link. (ii) $\mu(L) = \mu(L_1) + \mu(L_2)$.

We would point out the following facts by analogy of the discussions of finite type invariants of 1-knots although they are very easy observations. By the above result (1), we have: the μ -invariant of 2-links is an order zero finite type invariant associated with ribbon-moves and there is a 2-knot whose μ -invariant is not zero. The mod 2 alinking number of (S^2, T^2) -links is an order one finite type invariant associated with the ribbon-moves and there is an (S^2, T^2) -link whose mod 2 alinking number is not zero.

§1. Introduction

In this paper we discuss ribbon-moves.

An (*oriented*) (*ordered*) m -component 2-(*dimensional*) *link* is a smooth, oriented submanifold $L = \{K_1, \dots, K_m\}$ of S^4 , which is the ordered disjoint union of m manifolds, each diffeomorphic to the 2-sphere. If $m = 1$, then L is called a *2-knot*. We say that 2-links L_1 and L_2 are *equivalent* if there exists an orientation preserving diffeomorphism $f : S^4 \rightarrow S^4$ such that $f(L_1) = L_2$ and that $f|_{L_1} : L_1 \rightarrow L_2$ is an order and orientation preserving diffeomorphism. Let $id : S^4 \rightarrow S^4$ be the identity. We say that 2-links L_1 and L_2 are *identical* if $id(L_1) = L_2$ and that $id|_{L_1} : L_1 \rightarrow L_2$ is an order and orientation preserving diffeomorphism.

We define ribbon-moves of 2-links.

Definition 1.1. Let $L_1 = (K_{1,1} \dots K_{1,m})$ and $L_2 = (K_{2,1} \dots K_{2,m})$ be 2-knots in S^4 . We say that L_2 is obtained from L_1 by one *ribbon-move* if there is a 4-ball B of S^4 with the following properties.

(1) $L_1 - (B \cap L_1) = L_2 - (B \cap L_2)$.

$K_{1,j} - (B \cap K_{1,j}) = K_{2,j} - (B \cap K_{2,j})$

These diffeomorphism maps are orientation preserving.

(2) $B \cap L_1$ is drawn as in Figure 1.1. $B \cap L_2$ is drawn as in Figure 1.2.

We regard B as $(\text{a close 2-disc}) \times [0, 1] \times \{t \mid -1 \leq t \leq 1\}$. We put $B_t = (\text{a close 2-disc}) \times [0, 1] \times \{t\}$. Then $B = \cup B_t$. In Figure 1.1 and 1.2, we draw $B_{-0.5}, B_0, B_{0.5} \subset B$. We draw L_1 and L_2 by the bold line. The fine line denotes ∂B_t .

$B \cap L_1$ (resp. $B \cap L_2$) is diffeomorphic to $D^2 \amalg (S^1 \times [0, 1])$.

$B \cap L_1$ has the following properties: $B_t \cap L_1$ is empty for $-1 \leq t < 0$ and $0.5 < t \leq 1$. $B_0 \cap L_1$ is diffeomorphic to $D^2 \amalg (S^1 \times [0, 0.3]) \amalg (S^1 \times [0.7, 1])$. $B_{0.5} \cap L_1$ is diffeomorphic to $(S^1 \times [0.3, 0.7])$. $B_t \cap L_1$ is diffeomorphic to $S^1 \amalg S^1$ for $0 < t < 0.5$.

$B \cap L_2$ has the following properties: $B_t \cap L_2$ is empty for $-1 \leq t < -0.5$ and $0 < t \leq 1$. $B_0 \cap L_2$ is diffeomorphic to $D^2 \amalg (S^1 \times [0, 0.3]) \amalg (S^1 \times [0.7, 1])$. $B_{-0.5} \cap L_2$ is diffeomorphic to $(S^1 \times [0.3, 0.7])$. $B_t \cap L_2$ is diffeomorphic to $S^1 \amalg S^1$ for $-0.5 < t < 0$.

We do not assume which the orientation of $B \cap L_1$ (resp. $B \cap L_2$) is.

Figure 1.1.

Figure 1.2.

Suppose that L_2 is obtained from L_1 by one ribbon-move and that L'_2 is equivalent to L_2 . Then we also say that L'_2 is obtained from L_1 by one *ribbon-move*. If L_1 is obtained from L_2 by one ribbon-move, then we also say that L_2 is obtained from L_1 by one *ribbon-move*.

Definition 1.2. 2-knots L_1 and L_2 are said to be *ribbon-move equivalent* if there are 2-knots $L_1 = \bar{L}_1, \bar{L}_2, \dots, \bar{L}_{p-1}, \bar{L}_p = L_2$ ($p \in \mathbf{N}, p \geq 2$) such that \bar{L}_i is obtained from \bar{L}_{i-1} ($1 < i \leq p$) by one ribbon-move.

In this paper we discuss the following problems.

Problem 1.3. Let L_1 and L_2 be 2-links. Consider a necessary (resp. sufficient, necessary and sufficient) condition that L_1 and L_2 are ribbon-move equivalent. In particular, is there a 2-knot which is not ribbon-move equivalent to the trivial 2-knot?

Note. (1) Of course all m -component ribbon 2-links are ribbon-move equivalent

to the trivial m -component link. See Appendix for the definition of ribbon 2-links.

(2) By using §4 of [1], it is easy to prove that there is a nonribbon 2-knot which is ribbon-move equivalent to the trivial 2-knot.

Our motivation is as follows. We hope to investigate ‘link space’ $E = \{f|f : S^2 \amalg \dots \amalg S^2 \hookrightarrow S^4 \text{ embeddings}\}$. In the case of 1-dimensional knots and links, we know that it is useful to investigate the space of immersions of circles in order to help investigate the space of embeddings. To discuss the space of immersions and that of embeddings is to discuss local moves (or knotting operations). In the case of 1-dimensional knots and links, we find many relations among ‘link space,’ local moves, invariants of links, and QFT. (See [2] [3] [4] [5] etc.) In 1-dimensional case, it is easy to find an unknotting operation. But high dimensional case, our first task is to define what kind of local moves we use. In this paper we discuss ribbon-moves as one of such moves.

This article is based on [6]. After [6], the author discusses relations between ribbon-moves of 2-knots and the Levine-Farber pairing and the Atiyah-Patodi-Singer-Casson-Gordon-Ruberman $\tilde{\eta}$ -invariants of 2-knots (see [7]). In [8] the author discussed relations between local moves of n -knots and some invariants of n -knots.

§2. Main results

Theorem 2.1 *Let L_1 and L_2 be 2-links in S^4 . Suppose that L_1 is obtained from L_2 by one ribbon-move. Then there are Seifert hypersurfaces V_1 for L_1 and V_2 for L_2 such that (V_1, σ_1) is spin preserving diffeomorphic to (V_2, σ_2) , where σ_i is a spin structure induced from the unique one on S^4 .*

By using Theorem 2.1, we prove Theorem 2.2 and 2.3.

Theorem 2.2. *If 2-links L and L' are ribbon-move equivalent, then $\mu(L)=\mu(L')$.*

In §3 we define the μ -invariant of 2-links.

Theorem 2.3. *Let L_1 and L_2 be 2-links in S^4 . Suppose that L_1 are ribbon-move equivalent to L_2 . Let W_i be arbitrary Seifert hypersurfaces for L_i . Then the torsion part of $H_1(W_1) \oplus H_1(W_2)$ is congruent to $G \oplus G$ for a finite abelian group G .*

By using Theorem 2.2 we prove Corollary 2.4. By using Theorem 2.3 we also prove Corollary 2.4.

Corollary 2.4. *Not all 2-knots are ribbon-move equivalent to the trivial 2-knot.*

By using Theorem 2.3 we prove Corollary 2.5.

Corollary 2.5. *There is a 2-knot K such that $\mu(K) = 0$ and that K is not ribbon-move equivalent to the trivial 2-knot.*

By using Theorem 2.2, we prove Corollary 2.6.

Corollary 2.6. *The inverse of Theorem 2.3 is not true.*

In §3-7 we prove the above results.

In §8 we prove that: Let $L = (L_1, L_2)$ be a sublink of homology boundary link. Then the following hold. (1) L is ribbon-move equivalent to a boundary link. (2) $\mu(L) = \mu(L_1) + \mu(L_2)$.

In §9 we would point out the following facts by analogy of the discussions of finite type invariants of 1-knots although they are very easy observations. By Theorem 2.2, we have: the μ -invariant of 2-links is an order zero finite type invariant associated with ribbon-moves and there is a 2-knot whose μ -invariant is not zero. The mod 2 alinking number of (S^2, T^2) -links is an order one finite type invariant associated with the ribbon-moves and there is an (S^2, T^2) -link whose mod 2 alinking number is not zero.

§3. The μ -invariant of 2-links

See §IV of [9] for the spin structures and the μ -invariant of closed spin 3-manifolds.

Definition. Let $L = (K_1, \dots, K_m)$ be a 2-link. Let V be a Seifert hypersurface for L . Note that V is oriented so that the orientation is compatible with that on L . A spin structure σ on V is induced from the unique spin structure on S^4 . Attach m 3-dimensional 3-handles to V along each component of the boundary. Then we obtain the closed oriented 3-manifold \hat{V} . The spin structure σ extends over \hat{V} uniquely. Call it $\hat{\sigma}$. We define the μ -invariant $\mu(L)$ of the 2-link L to be the μ -invariant $\mu((\hat{V}, \hat{\sigma})) \in \mathbf{Z}_{16}$ of the closed spin 3-manifold $(\hat{V}, \hat{\sigma})$.

Claim. Under the above conditions $\mu(L)$ is independent of the choice of V .

Proof. P.580 of [10] proved the above Claim when L is a knot.

[11] says:

Fact 3.1. ([11]) Let V and V' be Seifert hypersurfaces for L . Then we have: there are Seifert hypersurfaces $V = V_1, V_2, \dots, V_{p-1}, V_p$ for L with the following properties.

(1) The embedding map of V_p is isotopic to that of V' , where we do not fix the boundary of the image. (Note. $[V \cup V']$ is not zero in general in $H_3(S^4 - L; \mathbf{Z})$. But we can set $[V_1 \cup V_p] = 0 \in H_3(S^4 - L; \mathbf{Z})$.)

(2) For V_i and V_{i+1} ($i = 1, \dots, p-1$), there is a compact oriented 4-manifold W_i embedded in S^4 which has a handle decomposition

$$W_i = (V_i \times [0, 1]) \cup (\text{one } q\text{-handle}) \cup (V_{i+1} \times [0, 1]) \quad (q \in \{1, 2, 3\}).$$

We give W_i a spin structure induced from the unique one on S^4 .

The following two spin structures on V_1 coincide one another. Call it σ_1 .

- (i) The spin structure induced from the unique one on S^4
- (ii) The spin structure induced from the one on W_1 .

The following two spin structures on V_p coincide one another. Call it σ_p .

- (i) The spin structure induced from the unique one on S^4
- (ii) The spin structure induced from the one on W_{p-1} .

The following three spin structures on V_i coincide each other ($i = 2, \dots, p-1$). Call it σ_i .

- (i) The spin structure induced from the unique one on S^4 .
- (ii) The spin structure induced from the one on W_i .
- (iii) The spin structure induced from the one on W_{i+1} .

The 3-dimensional closed oriented spin 3-manifolds $(\hat{V}_i, \hat{\sigma}_i)$ are defined from (V_i, σ_i) as in the above Definition ($i = 1, \dots, p$). (See §IV of [9] for the way to induce spin structures on manifolds from those on others.)

Let x, y be arbitrary elements of $H_2(W_i; \mathbf{Z})/\text{Tor}$. Let $x \cdot y$ be the intersection product.

We prove: $x \cdot y = 0$.

There is an oriented closed surface F embedded in W_i which represents x . Since F is embedded in S^4 , $[F] \cdot [F] = 0$. Hence $x \cdot x = 0$ for any element $x \in H_2(W_i; \mathbf{Z})/\text{Tor}$. Hence $x \cdot y = 0$ for arbitrary elements $x, y \in H_2(W_i; \mathbf{Z})/\text{Tor}$. Hence the signature of the intersection form

$$H_2(W_i; \mathbf{Z})/\text{Tor} \times H_2(W_i; \mathbf{Z})/\text{Tor} \rightarrow \mathbf{Z} \quad (x, y) \mapsto x \cdot y$$

is the zero map. Hence $\sigma(W_i) = 0$.

Therefore $\mu((\hat{V}_i, \hat{\sigma}_i)) - \mu(-(\hat{V}_{i+1}, \hat{\sigma}_{i+1})) = \mu((V_i, \sigma_i) \cup (-(V_{i+1}, \sigma_{i+1}))) = \{\text{mod } 16 \sigma(W_i)\} = 0$. Hence $\mu((\hat{V}_i, \hat{\sigma}_i)) = \mu(\hat{V}_{i+1}, \hat{\sigma}_{i+1})$. ($i = 1, \dots, p-1$.)

Therefore $\mu((\hat{V}_1, \hat{\sigma}_1)) = \mu((\hat{V}_2, \hat{\sigma}_2)) = \dots = \mu((\hat{V}_{p-1}, \hat{\sigma}_{p-1})) = \mu(\hat{V}_p, \hat{\sigma}_p)$.

This completes the proof.

§4. Proof of Theorem 2.1

In order to prove Theorem 2.1, we introduce (1,2)-pass-moves of 2-links.

Definition 4.1. Let $L_1 = (K_{1,1} \dots K_{1,m})$ and $L_2 = (K_{2,1} \dots K_{2,m})$ be 2-knots in S^4 . We say that L_2 is obtained from L_1 by one (1,2)-pass-move if there is a 4-ball $B \subset S^4$ with the following properties. We draw B as in Definition 1.1.

(1) $L_1 - (B \cap L_1) = L_2 - (B \cap L_2)$.

$$K_{1,j} - (B \cap K_{1,j}) = K_{2,j} - (B \cap K_{2,j})$$

These diffeomorphism maps are orientation preserving.

(2) $B \cap L_1$ is drawn as in Figure 4.1. $B \cap L_2$ is drawn as in Figure 4.2.

Figure 4.1.

Figure 4.2.

The orientation of the two discs in the Figure 4.1 (resp. Figure 4.2) is compatible with the orientation which is naturally determined by the (x, y) -arrows in the Figure. We do not assume which the orientations of the annuli in the Figures are.

Suppose that L_2 is obtained from L_1 by one (1,2)-pass-move and that L'_2 is equivalent to L_2 . Then we also say that L'_2 is obtained from L_1 by one (1,2)-pass-move .

If L_1 is obtained from L_2 by one (1,2)-pass-move, then we also say that L_2 is obtained from L_1 by one (1,2)-pass-move .

2-knots L_1 and L_2 are said to be (1,2)-pass-move equivalent if there are 2-knots $\bar{L}_1 = \bar{L}_1, \bar{L}_2, \dots, \bar{L}_{p-1}, \bar{L}_p = L_2$ ($p \in \mathbf{N}, p \geq 2$) such that \bar{L}_i is obtained from \bar{L}_{i-1} ($1 < i \leq p$) by one (1,2)-pass-move.

Proposition 4.2. Let L and L' be 2-links. Then the following conditions (1) and (2) are equivalent.

(1) L is (1,2)-pass-move equivalent to L' .

(2) L is ribbon-move equivalent to L' .

It is obvious that Proposition 4.2 follows from Proposition 4.3.

Proposition 4.3. Let L and L' be 2-links. Then the following hold.

(1) If L is obtained from L' by one ribbon-move, then L' is obtained from L by one (1,2)-pass-move.

(2) If L is obtained from L' by one (1,2)-pass-move, then L' is obtained from L by two ribbon-move.

Proposition 4.3.(2) is obvious.

Proposition 4.3.(1) follows from Proposition 4.4 because: The pair of a manifold and a submanifold, (the 4-ball, (the 2-link) \cap (the 4-ball)), in Figure 4.1 is included in the pair (the 4-ball, (the 2-link) \cap (the 4-ball)) in Figure 4.4.

Proposition 4.4. *Let $L_1 = (K_{1,1}, \dots, K_{1,m})$ and $L_2 = (K_{2,1}, \dots, K_{2,m})$ be 2-links in S^4 . Then the following two conditions (I) and (II) are equivalent.*

(I) L_1 is equivalent to L_2 .

(II) *There is a 4-ball $B \subset S^4$ with the following properties. We draw B as in Definition 1.1.*

(1) $L_1 - (B \cap L_1) = L_2 - (B \cap L_2)$.

$K_{1,i} - (B \cap K_{1,i}) = K_{2,i} - (B \cap K_{2,i})$ for each i .

These diffeomorphism maps are orientation preserving.

(2) $B \cap L_1$ is drawn as in Figure 4.3. $B \cap L_2$ is drawn as in Figure 4.4.

Figure 4.3.

Figure 4.4.

The orientation of $B \cap L_2$ is compatible with the orientation which is naturally determined by the (x, y) -arrows in the Figure 4.4.

It is obvious that Proposition 4.4 follows from Proposition 4.5.

Proposition 4.5. *Let $L_1 = (K_{1,1}, \dots, K_{1,m})$ and $L_2 = (K_{2,1}, \dots, K_{2,m})$ be 2-links in S^4 . Then the following two conditions (I) and (II) are equivalent.*

(I) L_1 is equivalent to L_2 .

(II) *There is a 4-ball $B \subset S^4$ with the following properties. We draw B as in Definition 1.1.*

(1) $L_1 - (B \cap L_1) = L_2 - (B \cap L_2)$.

$K_{1,i} - (B \cap K_{1,i}) = K_{2,i} - (B \cap K_{2,i})$ for each i .

These diffeomorphism maps are orientation preserving.

(2) $B \cap L_1$ is drawn as in Figure 4.5. $B \cap L_2$ is drawn as in Figure 4.6.

Figure 4.5.

Figure 4.6.

We do not assume which the orientation of $B \cap L_1$ (resp. $B \cap L_2$) is.

Proposition 4.5 follows from Proposition 4.6 because: The pair of a manifold and a submanifold, (the 4-ball, (the 2-link) \cap (the 4-ball)), in Figure 4.5 (resp. Figure 4.6) is made from the pair (the 4-ball, (the 2-link) \cap (the 4-ball)) in Figure 4.7 (resp. Figure 4.8) by a rotation through 90° around an appropriate plane in the 4-ball in Figure 4.5 (resp. Figure 4.6) and by isotopy.

Proposition 4.6. *Let $L_1 = (K_{1,1}, \dots, K_{1,m})$ and $L_2 = (K_{2,1}, \dots, K_{2,m})$ be 2-links in S^4 . Then the following two conditions (I) and (II) are equivalent.*

(I) L_1 is equivalent to L_2 .

(II) *There is a 4-ball $B \subset S^4$ with the following properties. We draw B as in Definition 1.1.*

(1) $L_1 - (B \cap L_1) = L_2 - (B \cap L_2)$.

$K_{1,i} - (B \cap K_{1,i}) = K_{2,i} - (B \cap K_{2,i})$ for each i .

These diffeomorphism maps are orientation preserving.

(2) $B \cap L_1$ is drawn as in Figure 4.7. $B \cap L_2$ is drawn as in Figure 4.8.

Figure 4.7.

Figure 4.8.

We do not assume which the orientation of $B \cap L_1$ (resp. $B \cap L_2$) is.

Proof of Proposition 4.6. We obtain L_2 from L_1 by an explicit isotopy, Figure 4.7 \rightarrow Figure 4.9 \rightarrow Figure 4.8. Note that the following Proposition 4.7 holds by an explicit isotopy. This completes the proof of Proposition 4.2-4.6.

Figure 4.9.

Proposition 4.7. Let $L_1 = (K_{1,1}, \dots, K_{1,m})$ and $L_2 = (K_{2,1}, \dots, K_{2,m})$ be 2-links in S^4 . Then the following two conditions (I) and (II) are equivalent.

(I) L_1 is equivalent to L_2 .

(II) There is a 4-ball $B \subset S^4$ with the following properties. We draw B as in Definition 1.1.

(1) $L_1 - (B \cap L_1) = L_2 - (B \cap L_2)$.

$K_{1,i} - (B \cap K_{1,i}) = K_{2,i} - (B \cap K_{2,i})$ for each i .

These diffeomorphism maps are orientation preserving.

(2) $B \cap L_1$ is drawn as in Figure 4.10. $B \cap L_2$ is drawn as in Figure 4.11.

Figure 4.10.

Figure 4.11.

We do not assume which the orientation of $B \cap L_1$ (resp. $B \cap L_2$) is.

Note. Regard the operation,

‘ $t=0$ of Figure 4.7 $\rightarrow t=0$ of Figure 4.8 $\rightarrow t=0$ of Figure 4.9,’

as an isotopy of (a part of) 1-knot. Then this operation is essentially same as the operation in the figure in the proof of Lemma 5.5 of [12].

Proof of Theorem 2.1. By Proposition 4.3.(1), L_1 is obtained from L_2 by one (1,2)-pass-move in a 4-ball B .

Claim 4.8. There are Seifert hypersurfaces V_1 for K_1 and V_2 for K_2 such that:

(1) $V_1 - (B \cap V_1) = V_2 - (B \cap V_2)$.

These diffeomorphism maps are orientation preserving.

(2) $B \cap V_1$ is drawn as in Figure 4.12. $B \cap V_2$ is drawn as in Figure 4.13.

Note. We draw B as in Definition 1.1. We draw V_1 and V_2 by the bold line. The fine line means ∂B .

$B \cap V_1$ (resp. $B \cap V_2$) is diffeomorphic to $(D^2 \times [2, 3]) \amalg (D^2 \times [0, 1])$. We can regard $(D^2 \times [0, 1])$ as a 3-dimensional 1-handle which is attached to ∂B . We can regard $(D^2 \times [2, 3])$ as a 3-dimensional 2-handle which is attached to ∂B .

$B \cap V_1$ has the following properties: $B_t \cap V_1$ is empty for $-1 \leq t < 0$ and $0.5 < t \leq 1$. $B_0 \cap V_1$ is diffeomorphic to $(D^2 \times [2, 3]) \amalg (D^2 \times [0, 0.3]) \amalg (D^2 \times [0.7, 1])$. $B_{0.5} \cap V_1$ is diffeomorphic to $(D^2 \times [0.3, 0.7])$. $B_t \cap V_1$ is diffeomorphic to $D^2 \amalg D^2$ for $0 < t < 0.5$.

$B \cap V_2$ has the following properties: $B_t \cap V_2$ is empty for $-1 \leq t < -0.5$ and $0 < t \leq 1$. $B_0 \cap V_2$ is diffeomorphic to $(D^2 \times [2, 3]) \amalg (D^2 \times [0, 0.3]) \amalg (D^2 \times [0.7, 1])$. $B_{-0.5} \cap V_2$ is diffeomorphic to $(D^2 \times [0.3, 0.7])$. $B_t \cap V_2$ is diffeomorphic to $D^2 \amalg D^2$ for $-0.5 < t < 0$.

Figure 4.12

Figure 4.13.

Proof of Claim. Put $P = (\text{the 3-manifolds in Figure 4.12}) \cap (\partial B)$. Note $P = (\text{the 3-manifolds in Figure 4.13}) \cap (\partial B)$. Put $Q = L_1 \cap (S^4 - \text{Int}B^4)$. Note $Q = L_2 \cap (S^4 - \text{Int}B^4)$. By applying the following Proposition to $(P \cup Q)$ and $(S^4 - \text{Int}B^4)$, Claim 4.8 holds.

The following Proposition is proved by using the obstruction theory. We give a proof although it is folklore.

Proposition. *Let X be an oriented compact $(m + 2)$ -dimensional manifold. Let $\partial X \neq \emptyset$. Let M be an oriented closed m -dimensional manifold which is embedded in X . Let $M \cap \partial X \neq \emptyset$. Let $[M] = 0 \in H_m(X; \mathbf{Z})$. Then there is an oriented compact $(m + 1)$ -dimensional manifold P such that P is embedded in X and that $\partial P = \partial X$.*

Proof. Let ν be the normal bundle of M in X . By Theorem 2 in P.49 of [9] ν is a product bundle. By using ν and the collar neighborhood of ∂X in X , we can take a compact oriented $(m + 2)$ -manifold $N \subset X$ with the following properties.

- (1) $N \cong M \times D^2$. (Hence $\partial N = M \times S^1$.)
- (2) $N \cap \partial X = (\partial N) \cap (\partial X) = M \cap \partial X$. (Hence $(\text{Int}N) \cap \partial X = \emptyset$.)

Take $X - (\text{Int}N)$. (Note $X - (\text{Int}N) \supset \partial X$.) There is a cell decomposition:
 $X - (\text{Int}N)$

$$= (\partial N) \cup (\partial X) \cup (1\text{-cells } e^1) \cup (2\text{-cells } e^2) \cup (3\text{-cells } e^3) \cup (\text{one } 4\text{-cell } e^4).$$

We can suppose that this decomposition has only one 0-cell e^0 which is in $(\partial N) \cap (\partial X)$.

There is a continuous map $s_0 : (\partial N) \cup (\partial X) \rightarrow S^1$ with the following properties, where p is a point in S^1 .

- (1) $s_0(\partial X) = p$. (Hence $s_0((\partial N) \cap (\partial X)) = p$ and $s_0(e^0) = p$.)
- (2) $s_0|_{\partial N} : M \times S^1 \rightarrow S^1$ is a projection map $(x, y) \mapsto y$.

Let S_F^1 be a fiber of the S^1 -fiber bundle $\partial N = M \times S^1$. Since $[M] = 0 \in H_m(X; \mathbf{Z})$, $[S_F^1]$ generates $\mathbf{Z} \subset H_1(X - \text{Int}N, \partial X; \mathbf{Z})$. (We can prove as in the proof of Theorem 3 in P.50 of [9])

Let $f : H_1(X - \text{Int}N, \partial X; \mathbf{Z}) \rightarrow H_1(X - \text{Int}N, \partial X; \mathbf{Z})/\text{Tor}$ be the natural projection map. Let $\{f([S_F^1]), u_1, \dots, u_k\}$ be a set of basis of $H_1(X - \text{Int}N, \partial X; \mathbf{Z})/\text{Tor}$. Take a continuous map

$$s_1 : (\partial N) \cup (\partial X) \cup (1\text{-cells } e^1) \rightarrow S^1$$

with the following properties.

- (1) $s_1|_{(\partial N) \cup (\partial X)} = s_0$
- (2) $s_1|_{e^0 \cup e^1} : e^0 \cup e^1 \rightarrow S^1$ satisfies the following condition: If $f([e^0 \cup e^1]) = n_0 \cdot f([S_F^1]) + \sum_{j=1}^k n_j \cdot u_j \in H_1(X - \text{Int}N, \partial X; \mathbf{Z})/\text{Tor}$ ($n_* \in \mathbf{Z}$), then $\deg(s_1|_{e^0 \cup e^1}) = n_0$.

Note that, if a circle C is nul-homologous in $(\partial N) \cup (\partial X) \cup (1\text{-cells } e^1)$, then $\deg(s_1|_C) = 0$.

Claim. *There is a continuous map*

$$s_2 : (\partial N) \cup (\partial X) \cup (1\text{-cells } e^1) \cup (2\text{-cells } e^2) \rightarrow S^1$$

such that $s_2|_{(\partial N) \cup (\partial X) \cup (1\text{-cells } e^1)} = s_1$.

Proof. It is trivial that $[\partial e^2] = 0 \in H_1((\partial N) \cup (\partial X) \cup (1\text{-cells } e^1); \mathbf{Z})$. Hence $\deg(s_1|_{\partial e^2}) = 0$. Hence $s_1|_{\partial e^2}$ extends to e^2 . Hence the above Claim holds.

The map s_2 extends to a continuous map $s : X - (\text{Int}N) \rightarrow S^1$ since $\pi_l(S^1) = 0$ ($l \geq 2$). We can suppose s is a smooth map.

Let $q \neq p$. Let q be a regular value. Hence $s^{-1}(q)$ be an oriented compact manifold. $\partial\{s^{-1}(q)\} \subset \{(\partial N) \cup \partial X\}$. Since $q \neq p$, $s^{-1}(q) \cap \partial X = \emptyset$. Hence

$\partial\{s^{-1}(q)\} \subset \partial N$. Furthermore we have $s^{-1}(q) \cap \partial N = \partial\{s^{-1}(q)\} = M \times \{r\}$, where r is a point in S^1 . By using N and $s^{-1}(q)$, Proposition holds.

By Claim 4.8, there is a smooth transverse immersion $F : V \times [1, 2] \rightarrow S^4$ such that $F|_{V \times \{1\}}(V \times \{1\}) = V_1$ and $F|_{V \times \{2\}}(V \times \{2\}) = V_2$. Give a spin structure α on $V \times [1, 2]$ by using F . Then the following two spin structures on V_i coincide one another. Call it τ_i .

- (i) the spin structure induced from the unique spin structure S^4
- (ii) the spin structure induced from α on $V \times [1, 2]$.

By using F , it holds that V_1 and V_2 are spin preserving diffeomorphism. This completes the proof of Theorem 2.1.

§5. Proof of Theorem 2.2

By Proposition 4.2, L and L' are (1,2)-pass-move equivalent. Take 2-links $L = \bar{L}_1, \bar{L}_2, \dots, \bar{L}_{p-1}, \bar{L}_p = L'$ as in Definition 4.1. Obviously, it suffices to prove that $\mu(\bar{L}_i) = \mu(\bar{L}_{i+1})$ for each i ($1 \leq i < p$). By Theorem 2.1 we have: There are Seifert hypersurfaces, $V_{i,i+1}$ for \bar{L}_i and $V_{i+1,i}$ for \bar{L}_{i+1} , such that $V_{i,i+1}$ and $V_{i+1,i}$ are spin preserving diffeomorphism. Hence $\mu(\bar{L}_i) = \mu(\bar{L}_{i+1})$.

§6. The proof of Theorem 2.3

The following Fact 6.1 is an elementary fact.

Fact6.1. (Known) *Let A, B, C, X and Y be a finite abelian group. Suppose $A \oplus B \cong X \oplus X$ and $B \oplus C \cong Y \oplus Y$. Then $A \oplus C \cong P \oplus P$ for a finite abelian group P .*

It is obvious that Theorem 2.3 follows from Theorem 2.1, Fact 6.1, and Proposition 6.2.

Proposition 6.2. *Let V and V' be Seifert hypersurfaces for a 2-link L . Then the torsion part of $H_1(V; \mathbf{Z}) \oplus H_1(V'; \mathbf{Z})$ is congruent to $G \oplus G$ for a finite group G .*

Proof. Take V_1, \dots, V_p and W_1, \dots, W_p as in Fact 3.1 and its proof. By using the Meyer-Vietoris sequence, we have $\text{Tor } H_1(\partial W_i; \mathbf{Z}) \cong \text{Tor } \{H_1(V_i; \mathbf{Z}) \oplus H_1(V_{i+1}; \mathbf{Z})\}$ ($i = 1, \dots, p-1$). The manifold ∂W_i is a closed oriented 3-manifold embedded in S^4 . Hence

$$\text{Tor } H_1(\partial W_i; \mathbf{Z}) \cong G_i \oplus G_i \text{ ---} (*)$$

for a finite abelian group G_i . (See e.g. [13] [14]. We give a proof in the following paragraph.) Hence $\text{Tor } \{H_1(V_i; \mathbf{Z}) \oplus H_1(V_{i+1}; \mathbf{Z})\} \cong G_i \oplus G_i$.

We give a proof for the above congruence (*): By using the Meyer-Vietoris sequence $H_i(\partial W_i; \mathbf{Z}) \rightarrow H_i(\overline{W_i}; \mathbf{Z}) \oplus H_i(\overline{S^4 - W_i}; \mathbf{Z}) \rightarrow H_i(S^4; \mathbf{Z})$, $\text{Tor } H_1(\partial W_i; \mathbf{Z}) \cong \text{Tor } \{H_1(W_i; \mathbf{Z}) \oplus H_1(\overline{S^4 - W_i}; \mathbf{Z})\}$. By using the Meyer-Vietoris sequence $H_i(W_i; \mathbf{Z}) \rightarrow H_i(S^4; \mathbf{Z}) \rightarrow H_i(\overline{S^4 - W_i}; \mathbf{Z})$, $H_1(W_i; \mathbf{Z}) \cong H_2(S^4, W_i; \mathbf{Z})$. By the excision, $H_2(S^4, W_i; \mathbf{Z}) \cong H_2(\overline{S^4 - W_i}, \partial W_i; \mathbf{Z})$. By the Poincaré duality, $H_2(\overline{S^4 - W_i}, \partial W_i; \mathbf{Z}) \cong H^2(\overline{S^4 - W_i}; \mathbf{Z})$. By the universal coefficient theorem, $\text{Tor } H_1(\overline{S^4 - W_i}; \mathbf{Z}) \cong \text{Tor } H^2(\overline{S^4 - W_i}; \mathbf{Z})$. Hence $\text{Tor } H_1(\overline{S^4 - W_i}; \mathbf{Z}) \cong \text{Tor } H_1(W_i; \mathbf{Z})$. Hence $\text{Tor } H_1(\partial W_i; \mathbf{Z}) \cong \text{Tor } H_1(\overline{S^4 - W_i}; \mathbf{Z}) \oplus \text{Tor } H_1(\overline{S^4 - W_i}; \mathbf{Z})$. Hence the congruence (*) holds.

By Fact 6.1, $\text{Tor } \{H_1(V_1; \mathbf{Z}) \oplus H_1(V_p; \mathbf{Z})\} = G \oplus G$ for a finite abelian group G . Hence $\text{Tor } \{H_1(V; \mathbf{Z}) \oplus H_1(V'; \mathbf{Z})\} = G \oplus G$.

§7. The proof of Corollary 2.4, 2.5 and 2.6

Let K be the 2-twist spun knot of a 1-knot A . Let M be the 2-fold branched cyclic covering space of S^3 along A . By [15], $\overline{M - B^3}$ is a Seifert hypersurface for K . Let S be a Seifert matrix of K . By Lemma 12.1, Theorem 12.2, and Theorem 12.6 in Chapter XII of [12], there is a compact oriented 4-manifold X with the following properties. (i) $M = \partial X$. (ii) $H_1(X; \mathbf{Z}) \cong 0$ (iii) $H_3(X; \mathbf{Z}) \cong 0$ (iv) The intersection form $H_2(X; \mathbf{Z}) \times H_2(X; \mathbf{Z}) \rightarrow \mathbf{Z}$ is represented by $S + {}^t S$. (Note: By using the Poincaré duality, the universal coefficient theorem, and the above conditions (ii) (iii), it holds that $H_2(X; \mathbf{Z})$ is torsion free.)

By the above fact (iv), the intersection form is even. By this fact, the above (ii), and P.27 of [9], it holds that X is a spin manifold. Hence, for a spin structure α on M , $\mu(M, \alpha) = \text{mod } 16 \sigma(S + {}^t S)$. (Note that there is a spin 3-manifold whose spin structure is more than one.)

(1) Let A be the trefoil knot. Let S be $\begin{pmatrix} 1 & 1 \\ 0 & 1 \end{pmatrix}$. Then the intersection form of X is represented by $\begin{pmatrix} 2 & 1 \\ 1 & 2 \end{pmatrix}$.

Hence we have:

$$(1.1) H_1(\overline{M - B^3}; \mathbf{Z}) \cong \mathbf{Z}_3.$$

Hence $H_1(\overline{M - B^3}; \mathbf{Z}_2) \cong 0$. Hence $\overline{M - B^3}$ has only one spin structure.

Hence $\mu(K) = \mu(M) = \text{mod } 16 (\sigma \begin{pmatrix} 2 & 1 \\ 1 & 2 \end{pmatrix})$. Hence we have:

$$(1.2) \mu(K) = 2.$$

(2) Let A be the figure eight knot. Let S be $\begin{pmatrix} 1 & 1 \\ 0 & -1 \end{pmatrix}$. Then the intersection form of X is represented by $\begin{pmatrix} 2 & 1 \\ 1 & -2 \end{pmatrix}$.

Then we have:

$$(2.1) H_1(\overline{M - B^3}; \mathbf{Z}) \cong \mathbf{Z}_5.$$

Hence $H_1(\overline{M - B^3}; \mathbf{Z}_2) \cong 0$. Hence M has only one spin structure. Hence

$\mu(K) = \mu(M) = \text{mod } 16 (\sigma \begin{pmatrix} 2 & 1 \\ 1 & -2 \end{pmatrix})$. Hence we have:

$$(2.2) \mu(K) = 0.$$

(3) Let K be the 5-twist spun knot of the trefoil knot. Let M be the Poincaré homology sphere. Then we have:

(3.1) There is a Seifert hypersurface for K which is diffeomorphic to $\overline{M - B^3}$. (See §65 of [16].)

$$(3.2) \mu(K) = \mu(M) = 8. \text{ (See e.g. P.15 and P.67 of [9].)}$$

The above (1.2) and Theorem 2.2 imply Corollary 2.4.

The above (1.1) (or (2.1)) and Theorem 2.3 imply Corollary 2.4.

The above (2.1), (2.2) and Theorem 2.3 imply Corollary 2.5.

The above (3.1), (3.2) and Theorem 2.2 imply Corollary 2.6.

§8. Any SHB link is ribbon-move equivalent to a boundary link

See P.640 of [17] and P.536 of [18] etc. for sublinks of homology boundary links (i.e. SHB links), homology boundary links and boundary links.

Theorem 8.1. *Let $L = (K_1, K_2)$ be a 2-link. Let L be a sublink of a homology boundary link. Then L is ribbon-move equivalent to a boundary link.*

To prove Theorem 8.1, we need lemmas. By the definition of SHB links (in P.536 of [18]) the following holds.

Lemma 8.1.1. *Let $L = (K_1, K_2)$ be the 2-link in Theorem 8.1. There is a connected Seifert hypersurface V_i for K_i ($i = 1, 2$) such that $V_1 \cap V_2$ is diffeomorphic to a disjoint union of 2-spheres S_1^2, \dots, S_ν^2 .*

We prove:

Lemma 8.1.2. *Let $L = (K_1, K_2)$ be the 2-link in Theorem 8.1. Then there is a 2-link $L' = (K'_1, K'_2)$ which is equivalent to L satisfying the following condition: there is a Seifert hypersurface V'_i for K'_i ($i = 1, 2$) such that $V'_1 \cap V'_2$ is one 2-sphere S_0^2 .*

Proof of Lemma 8.1.2. Take V_1 and V_2 in Lemma 8.1.1. If $\nu = 0$, then Theorem 8.1 holds. If $\nu = 1$, then Lemma 8.1.2 holds. Suppose $\nu \geq 2$.

We can suppose that S_1^2 and S_2^2 satisfy the following: There is a point $p_1 \in S_1^2$, a point $p_2 \in S_2^2$, and a path $l \subset V_1$ such that (1) $\partial l = p_1 \amalg p_2$ (2) $l \cap (S_1^2 \amalg \dots \amalg S_\nu^2) = p_1 \amalg p_2$ (3) $l \cap K_1 = \phi$.

Take a 4-dimensional 1-handle $h^1 \subset S^4$ whose core is l such that h^1 is attached to V_2 along $p_1 \amalg p_2$. Then $h^1 \cap V_1$ is a 3-dimensional 1-handle which is attached to $S_1^2 \amalg S_2^2$ along $p_1 \amalg p_2$. We carry out surgery on V_2 by using h^1 . The new manifold is called V_2^{\natural} . Then V_2^{\natural} is a connected Seifert hypersurface for K_2 . When we carry out the surgery on V_2 , we carry out surgery on $S_1^2 \amalg S_2^2$ by using the 3-dimensional 1-handle $h^1 \cap V_1$. Then the result is a 2-sphere. Then $V_1 \cap V_2^{\natural}$ is $(\nu - 1)$ 2-spheres. By the induction on ν , Lemma 8.1.2 holds.

Lemma 8.1.3. *Let $L = (K_1, K_2)$ be the 2-link in Theorem 8.1. Then there is a 2-link $L'' = (K''_1, K''_2)$ which is equivalent to L satisfying the following condition: there is a connected Seifert hypersurface V''_i for K''_i ($i = 1, 2$) such that $V''_1 \cap V''_2$ is one 2-disc D_0^2 .*

Proof of Lemma 8.1.3. Take V'_1 and V'_2 in Lemma 8.1.2. Take a point $p \subset K'_1 = \partial V'_1$. Take a point $q \subset S_0^2 = V'_1 \cap V'_2$. Take a path $l \subset V'_1$ such that (1) $\partial l = p \amalg q$. (2) $l \cap S_0^2 = q$ (3) $l \cap K'_1 = p$.

Let N be a tubular neighborhood of l in V'_1 , Then N is a 3-ball. Note that $N \cap K_1$ is a 2-disc, which is a tubular neighborhood of p in K_1 . Note that $q \subset \text{Int } N$. Note that $\text{Int } (N \cap S_0^2)$ is in $\text{Int } N$. Then the following hold. (1) $\overline{V'_1 - N} \cap V'_2$ is a 2-disc. (2) $\partial(\overline{V'_1 - N})$ is equivalent to K_1 . (3) $(\partial(\overline{V'_1 - N}), K_2)$ is equivalent to L' and hence to L . $(\partial(\overline{V'_1 - N}), K_2)$ is called $L'' = (K''_1, K''_2)$. This completes the proof of Lemma 8.1.3.

Proof of Theorem 8.1. Take V''_1 and V''_2 in Lemma 8.1.3. We can suppose that $\partial D_0^2 \subset K''_1$ and that $D^2 \subset \text{Int } V''_2$. Take a 3-ball $P \subset V''_2$ such that $P \cap K''_2$ is a 2-disc and that $D^2 \subset \text{Int } P$. Then $V''_1 \cap \partial(\overline{V''_2 - P}) = \phi$. Let L^{\natural} be a 2-link $(K''_1, \partial(\overline{V''_2 - P}))$. Then L^{\natural} is a boundary link. Furthermore L^{\natural} is obtained from L'' by an operation that we fix K''_1 and that we move K''_2 to $\partial(\overline{V''_2 - P})$ so that we fix $K''_2 \cap \partial(\overline{V''_2 - P})$. This operation on L^{\natural} is essentially same as a ribbon move. This completes the proof of Theorem 8.1. 3

Theorem 8.2 *Let $L = (K_1, K_2)$ be an SHB 2-link. Then $\mu(L) = \mu(K_1) + \mu(K_2)$.*

Proof. By Theorem 8.1, L is ribbon-move equivalent to a boundary 2-link $\bar{L} = (\bar{K}_1, \bar{K}_2)$. Let \bar{V}_i be a Seifert hypersurface for \bar{K}_i such that $\bar{V}_1 \cap \bar{V}_2 = \phi$. Then $\mu(\bar{L}) = \mu(\bar{V}_1 \cup h^3) + \mu(\bar{V}_2 \cup h^3)$, where h^3 is a 3-dimensional 3-handle which is attached to \bar{V}_i along the 2-sphere $\partial\bar{V}_i$. Hence $\mu(\bar{L}) = \mu(\bar{K}_1) + \mu(\bar{K}_2)$. By Theorem 2.2, $\mu(L) = \mu(\bar{L})$ and $\mu(K_i) = \mu(\bar{K}_i)$. Hence $\mu(L) = \mu(K_1) + \mu(K_2)$.

Problem 8.3.

- (1) Let $L = (K_1, K_2)$ be a 2-link. Then does $\mu(L) = \mu(K_1) + \mu(K_2)$ hold?
- (2) Is there an n -link which is not an SHB link ($n \geq 2$)?

§9. Discussions

We would point out the following facts by analogy of the discussions of finite type invariants of 1-knots (e.g. [19]) although they are very easy observations.

By using Theorem 2.2 we have: The μ -invariant of 2-links is an order zero finite type invariant if we define ‘order of invariants’ by using ribbon-moves (e.g. as follows), and there is a 2-knot whose μ -invariant is not zero.

We define order, for example, as follows. Let I_n be the set of immersed m 2-spheres with the conditions: (1) The set of singular points consists of double points. (2) Each component of the set of singular points is as in Figure 9.3. (3) The components of the set of singular points are n . Then I_0 is the set of m -component 2-links. Let $v_i(\) \in G$ be an invariant of elements of I_i , where G is a group. Let X_0 be an element of I_{i+1} . Let X_+ and X_- be elements of I_i . Suppose that X_0, X_+ and X_- coincide in $S^4 - B^4$. Suppose that $X_0 \cap B$ is drawn as in Figure 9.3, $X_+ \cap B$ is drawn as in Figure 9.1, and $X_- \cap B$ is drawn as in Figure 9.2. In Figure 9.1, 9.2, 9.3, we do not assume the orientation of $X_* \cap B$ and that of B . If we have $\{v_{i+1}(X)\}^2 = \{v_i(X_+) - v_i(X_-)\}^2$ and v_i is zero for $i > p$, then we call $v_*(\)$ is an order p invariant of 2-links.

We define a link-type invariant $v(\)$ of (S^2, T^2) -links. (See [20] for detail. See (S^2, T^2) -links for [21].) We call it the alinking number of (S^2, T^2) -links. Let $L = (L_S, L_T)$ be a (S^2, T^2) -link. Let ι be the map $H^1(S^4 - L_S; \mathbf{Z}) \rightarrow H^1(L_T; \mathbf{Z})$ induced by the inclusion.

Define

$$v(L) = \begin{cases} n & \text{if } H^1(L_T; \mathbf{Z})/\text{Im}\iota \cong \mathbf{Z} \oplus (\mathbf{Z}/(n \cdot \mathbf{Z})) \ (n \geq 2, n \in \mathbf{N}) \\ 1 & \text{if } H^1(L_T; \mathbf{Z})/\text{Im}\iota \cong \mathbf{Z} \\ 0 & \text{if } H^1(L_T; \mathbf{Z})/\text{Im}\iota \cong \mathbf{Z} \oplus \mathbf{Z}. \end{cases}$$

Then the mod 2 alinking number of (S^2, T^2) -links is an order one finite type invariant if we define ‘order of invariants’ by using ribbon-moves (e.g. as above), and there is an (S^2, T^2) -link whose mod 2 alinking number is not zero. (The proof is similar to the proof that the linking number of 2-component 1-links is an order one finite type invariant. See [19].)

Note. [22] and [23] etc. try to make a high-dimensional version of works on 1-links by Jones, Witten, Kontsevich, Vassiliev, etc. (in [2] [3] [4] [5] etc.)

References

- [1] T. D. Cochran: Ribbon knots in S^4 *J. London Math. Soc.*, 28, 563-576, 1983.
- [2] V. F. R. Jones: Hecke Algebra representations of braid groups and link *Ann. of Math.* 126, 335-388, 1987
- [3] M. Kontsevich: Vassiliev’s knot invariants *Adv. in Soviet Math.* 16, 137-150, 1993

- [4] V. A. Vassiliev: Complements of Discriminants of smooth maps: Topology and Applications *Translations of Mathematical Monographs, American Mathematical Society* 98, 1994
- [5] E. Witten: Quantum field theory and the Jones polynomial *Comm. Math. Phys.* 121, 351-399, 1989
- [6] E. Ogasa: Ribbon moves of 2-links preserve the μ -invariants of 2-links *University of Tokyo Preprint series, UTMS 97-35* 1997
- [7] E. Ogasa: Ribbon-moves of 2-knots: the Farber-Levine pairing and the Atiyah-Patodi-Singer- Casson-Gordon-Ruberman $\tilde{\eta}$ -invariants of 2-knots
- [8] E. Ogasa: Intersectional pair of n -knots, local moves of n -knots, and their associated invariants of n -knots *Mathematical Research Letters* 5 577-582, 1998,
- [9] R. Kirby: The topology of 4-manifolds *Lecture Notes in Mathematics 1374, Springer Verlag*, 1374, 1989.
- [10] D. Ruberman: Doubly slice knots and the Casson-Gordon invariants *Trans. Amer. Math. Soc.*, 279, 569-588, 1983.
- [11] A.Kawauchi: On the fundamental class of an infinite cyclic covering *Preprint*
- [12] L. Kauffman: On knots *Ann of math studies*, 115, 1987
- [13] P.M.Gilmer and C.Livingston: On embedding 3-manifolds in 4-space *Topology* , 22, 241-252, 1983.
- [14] W.Hantzsch: Einlagerung von Mannigfaltigkeiten in Euklidische Räume *Math.Z.*, 43, 38-58, 1938.
- [15] E. Zeeman: Twisting spun knots *Trans. AMS* , 115, 471-495, 1965
- [16] H.Seifert and W.Trellfoil: Lehrbuch der Topologie *Teubner, Leipzig*, 1934
- [17] T. D. Cochran: Link concordance invariants and homotopy theory *Invent.Math.*, 90, 635-645, 1987.
- [18] T.D.Cochran and K. E. Orr: Not all links are concordant to boundary links *Ann. of Math.*, 138, 519-554, 1993.
- [19] J. S. Birman and X. S. Lin: Knot polynomials and Vassiliev's invariants *Invent. Math.*, 111, 225-270, 1993.
- [20] N. Sato: Cobordisms of semi-boundary links *Topology Appl.*, 18, 225-234, 1984.
- [21] E. Ogasa: The intersection of three spheres in a sphere and a new application of the Sato-Levine invariants *Proc. Amer. Math. Soc.* 126, 3109-3116, 1998
- [22] J. C. Baez: 4-dimensional BF theory as a Topological Quantum Field Theory *Lett.Math.Phys.*, 37, 3684-3703, 1996.
- [23] A. S. Cattaneo, P. Cotta-Ramusino, J. Froehlich, and M. Martellini: Topological BF Theories in 3 and 4 Dimensions *J. Math. Phys.*, 36, 6137-6160, 1995.

Acknowledgment. The author would like to thank Dr. Kazuo Habiro for the valuable discussions on (1,2)-pass-moves. The author would like to thank Prof. Daniel. Ruberman for the valuable discussions on [10]. The author would like to thank Prof. Akio Kawauchi for the valuable discussions on $\text{Tor } H(\ ; \mathbf{Z})$ of Seifert hypersurfaces. The author would like to thank Prof. Masahico Saito for his checking the figures. The author would like to thank Prof. Kent Orr for the valuable discussions on Problem 8.3.

Appendix

A *ribbon 2-link* is a 2-link $L = (K_1, \dots, K_m)$ with the following properties. There is a self-transverse immersion $f : D_1^3 \amalg \dots \amalg D_m^3 \rightarrow S^4$ such that: (a) $f(\partial D_i^3)$ coincides with K_i . (b) The singular point set X consists of double points. (c) For each connected component X_i of X , $f^{-1}(X_i)$ is diffeomorphic to the two 2-discs. (d) Put $\partial\{f^{-1}(X_i)\} = P \amalg Q$. One of $P \amalg Q$ is included in the boundary of D_i^3 and another of $P \amalg Q$ is included in the interior of D_j^3 for integers i, j . (We do not assume $i \neq j$ nor $i = j$.)

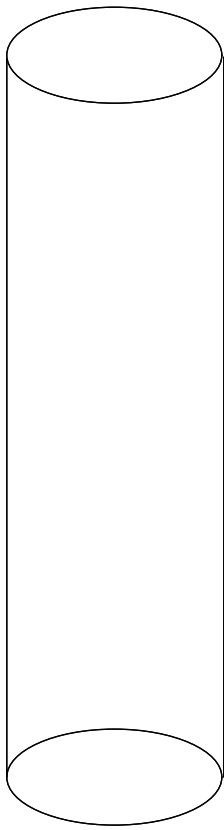

$t=-0.5$

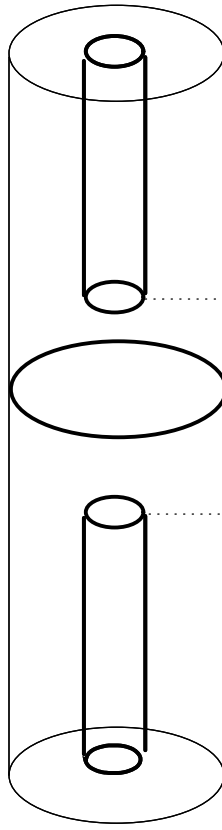

$t=0$

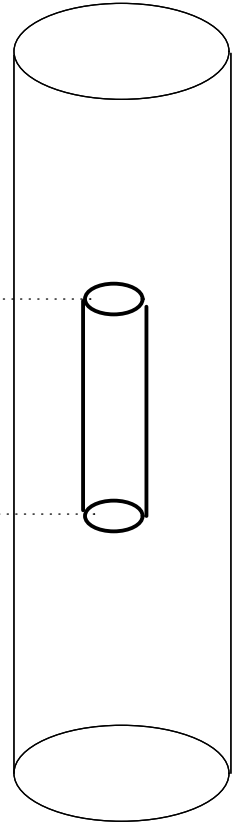

$t=0.5$

Figure 1.1

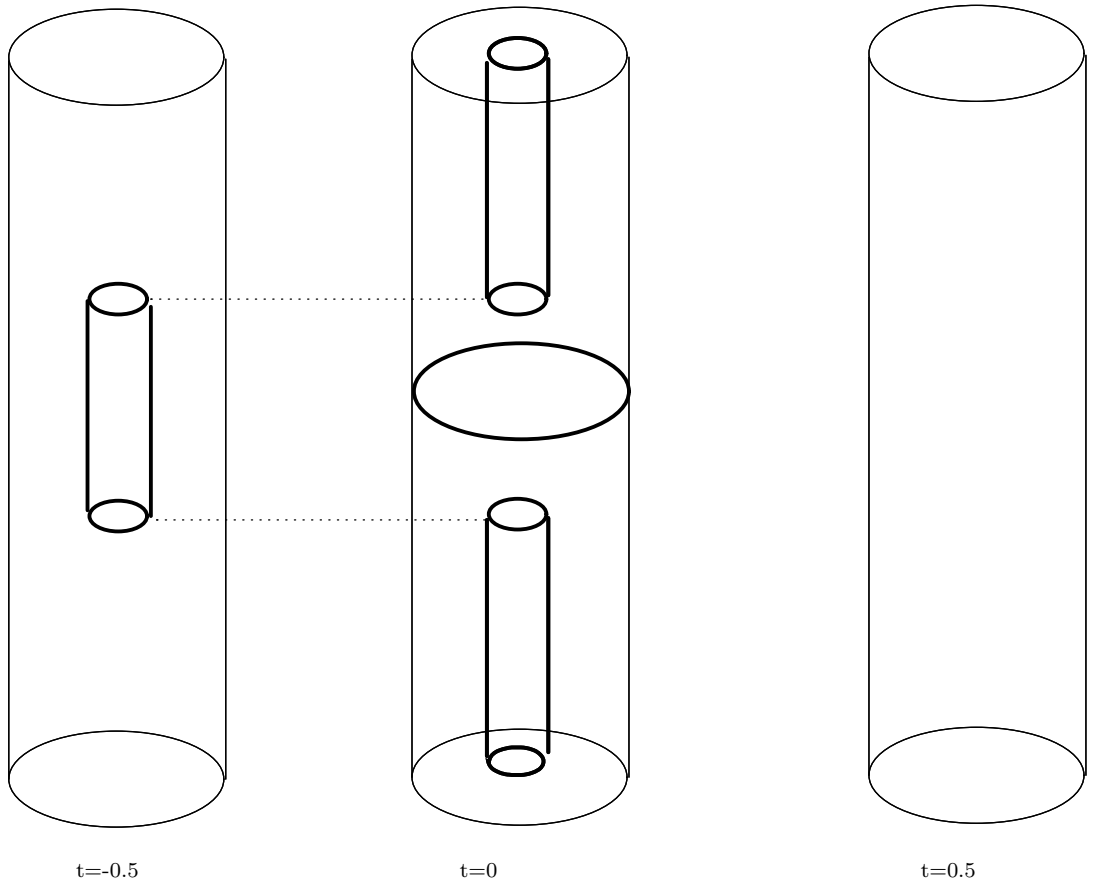
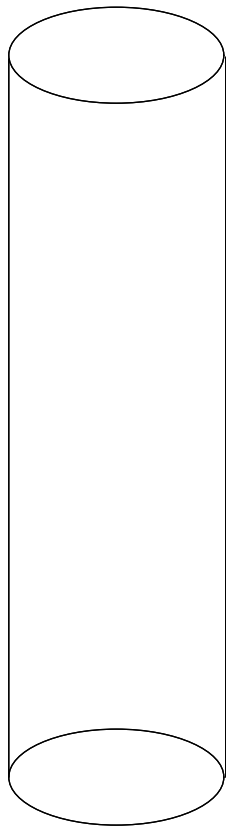
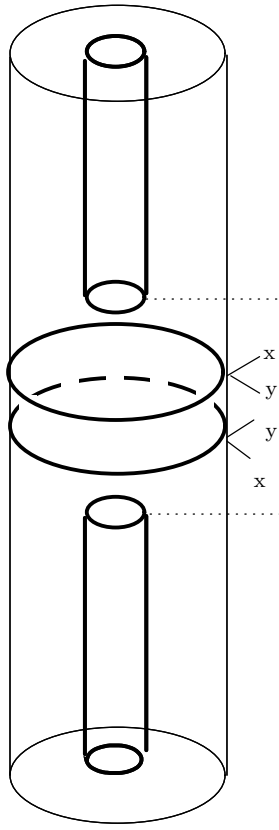

Figure 1.2



$t=-0.5$



$t=0$

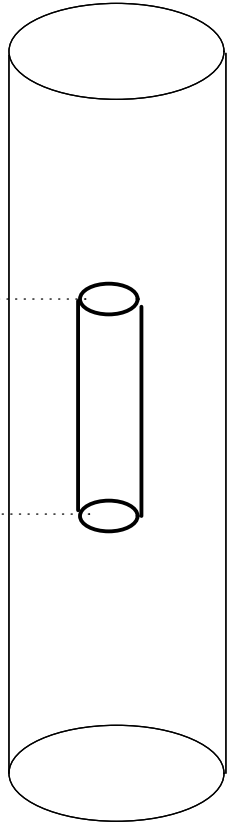

$t=0.5$

Figure 4.1

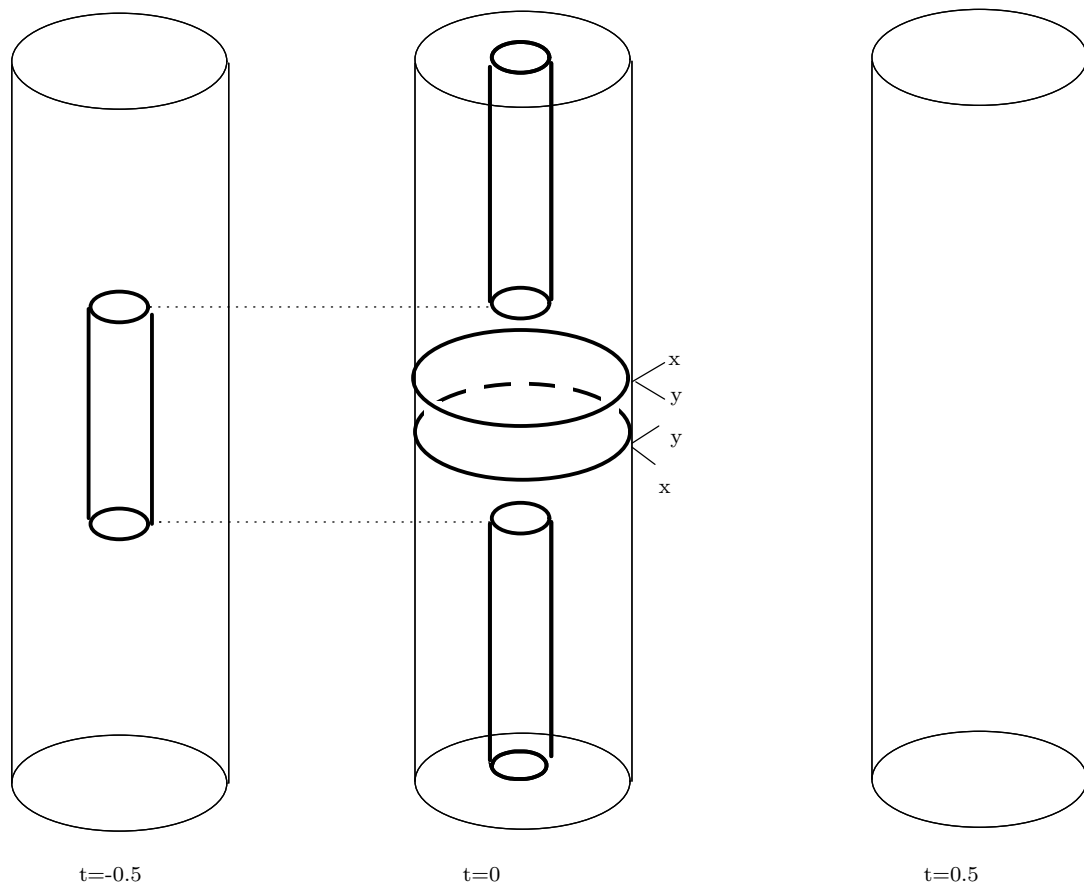

Figure 4.2

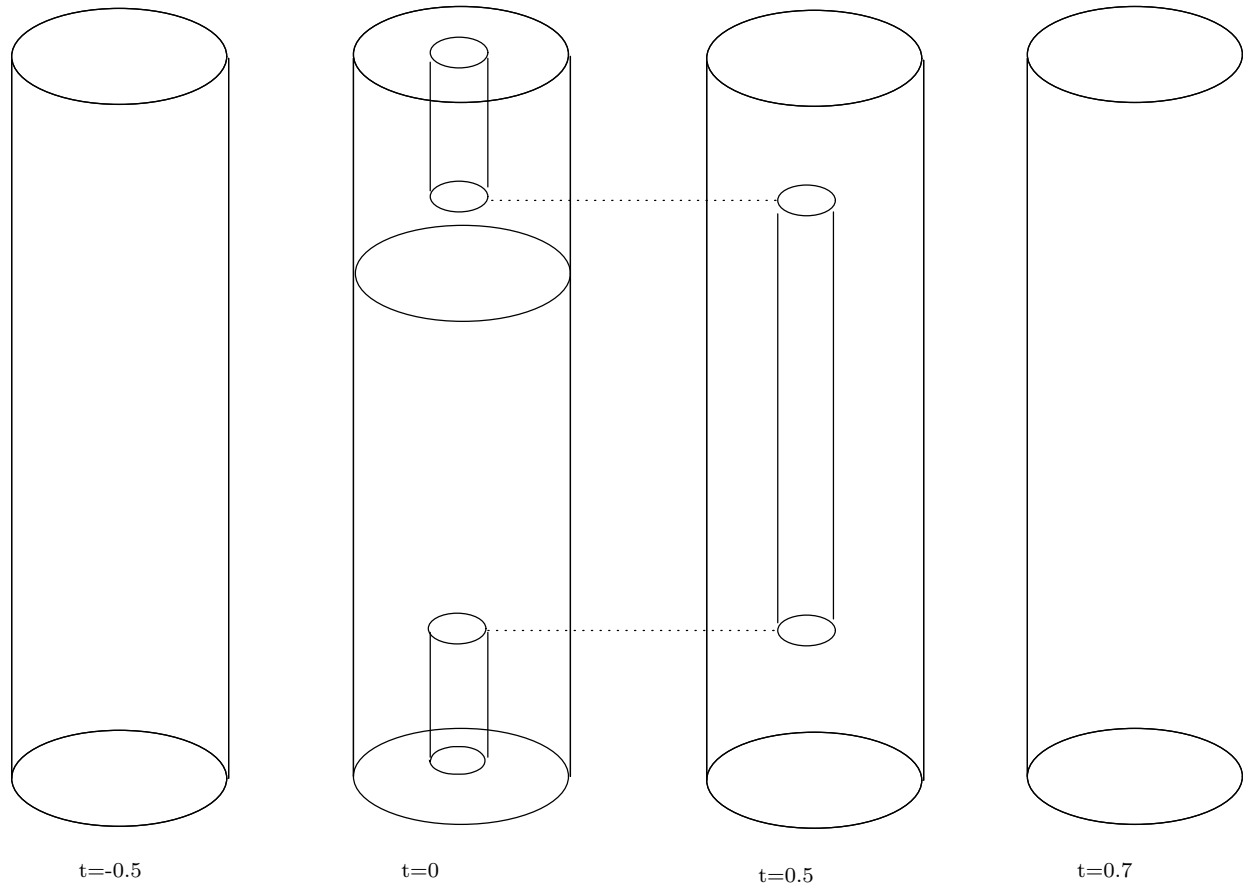

Figure 4.3

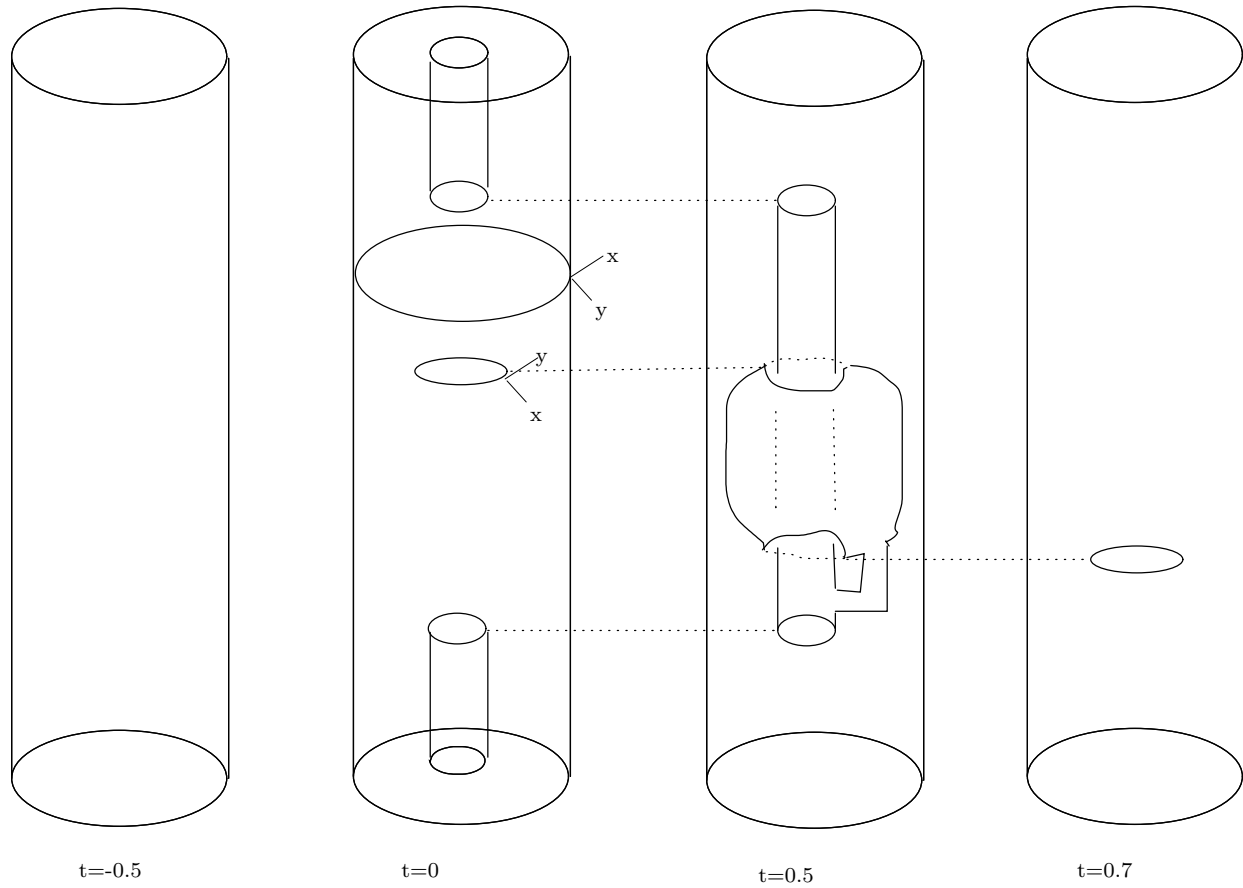
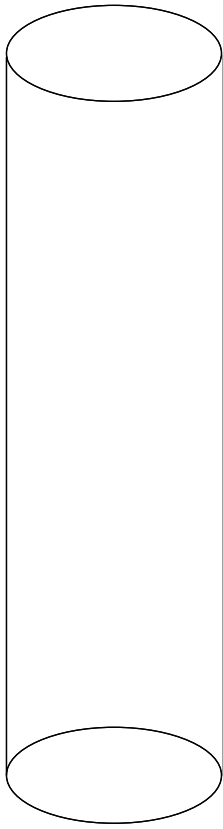
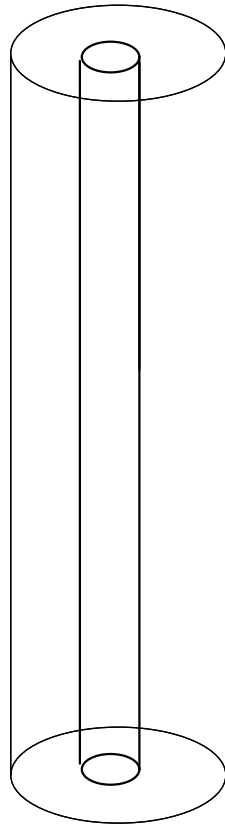

Figure 4.4



$t=-0.5$



$t=0$

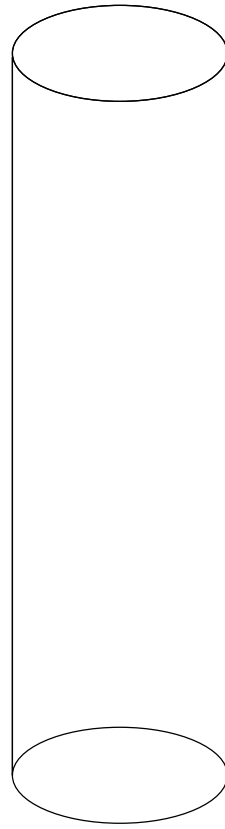

$t=0.5$

Figure 4.5

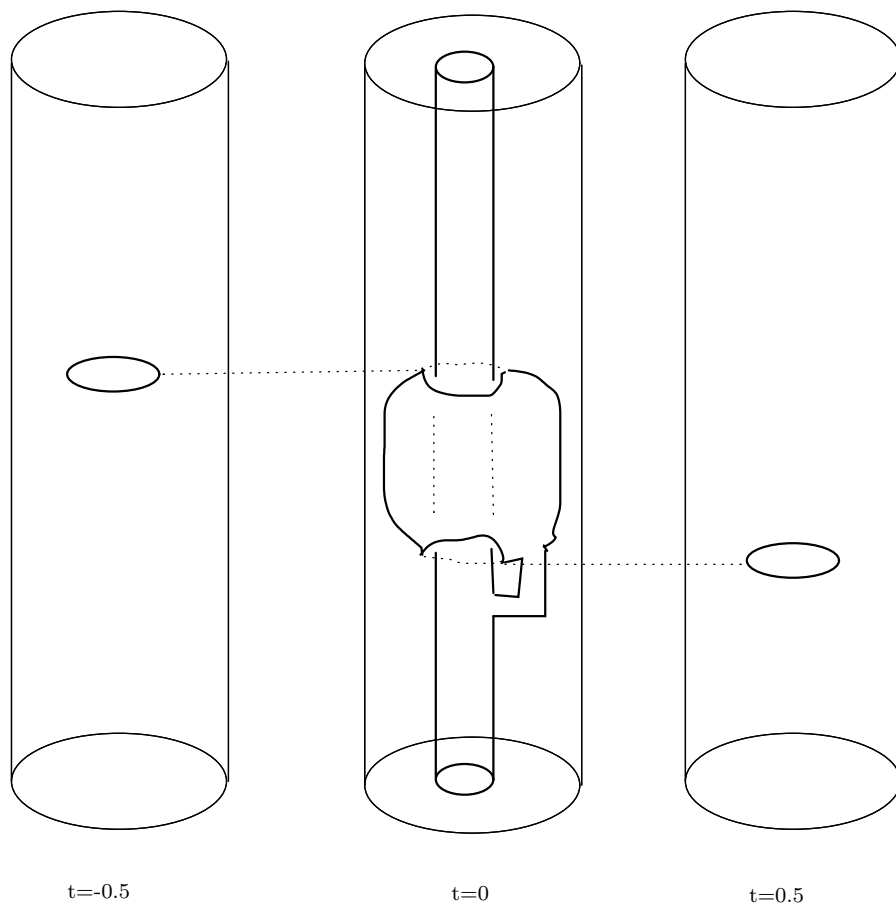
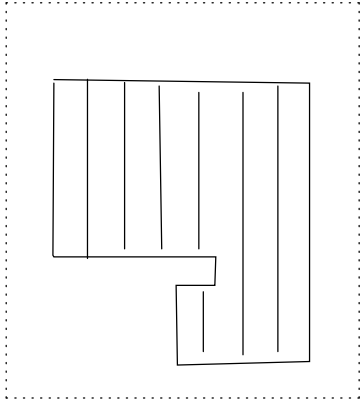
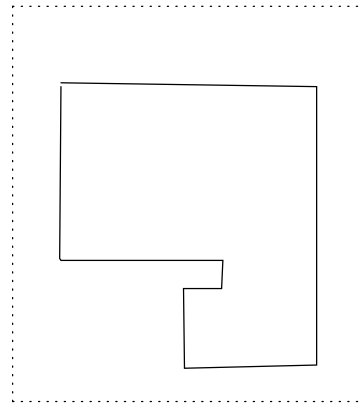

Figure 4.6



$t=-0.6$



$t=-0.4$

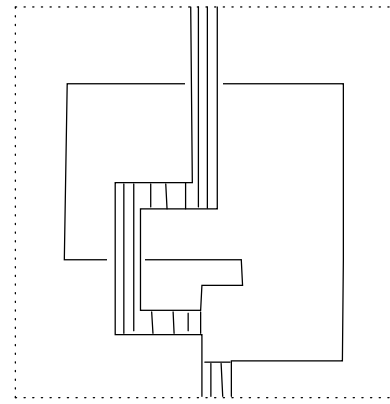

$t=-0.2$

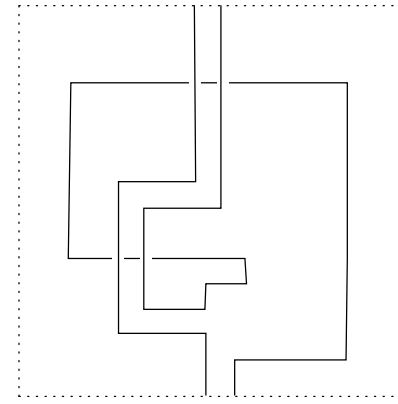

$t=0$

Figure4.7.(1)

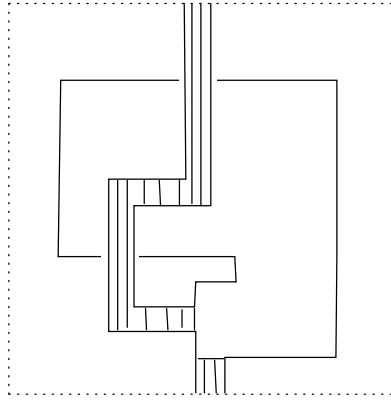

t=0.2

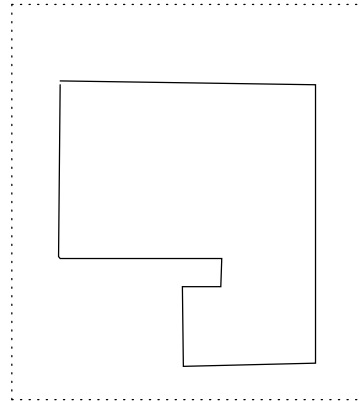

t=0.4

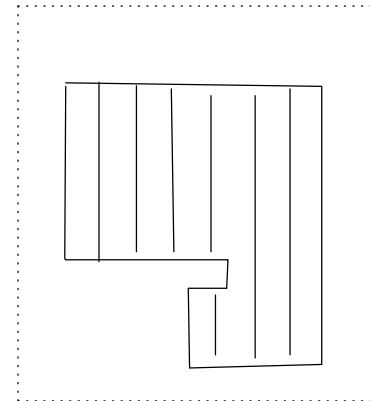

t=0.6

Figure 4.7.(2)

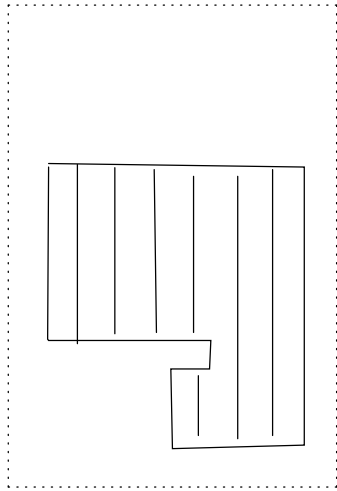

$t=-0.6$

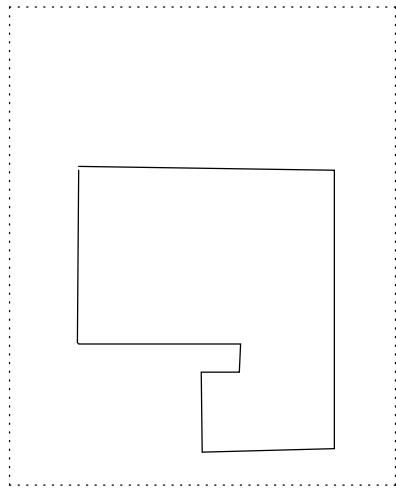

$t=-0.4$

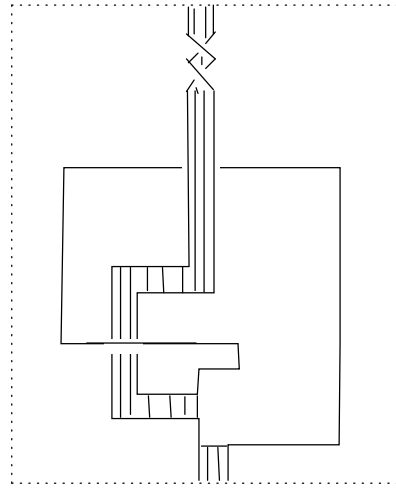

$t=-0.2$

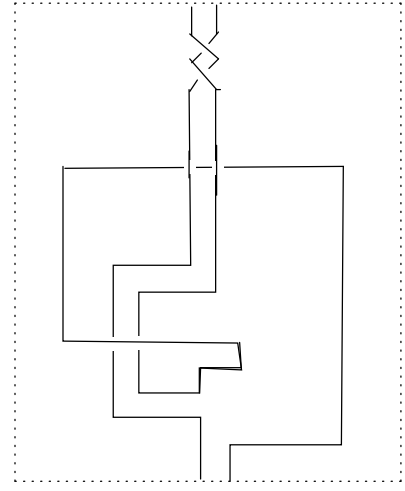

$t=0$

Figure 4.8.(1)

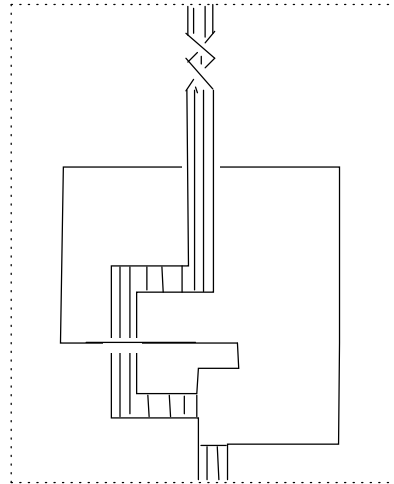

t=0.2

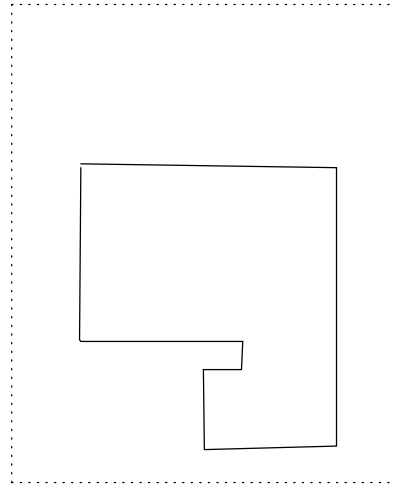

t=0.4

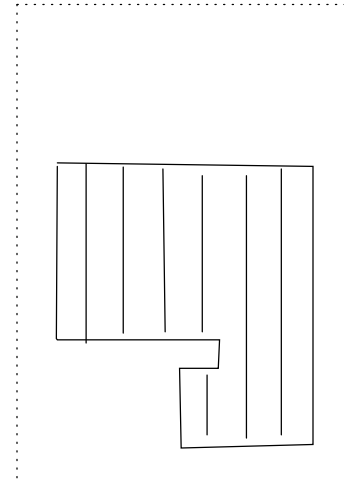

t=0.6

Figure 4.8.(2)

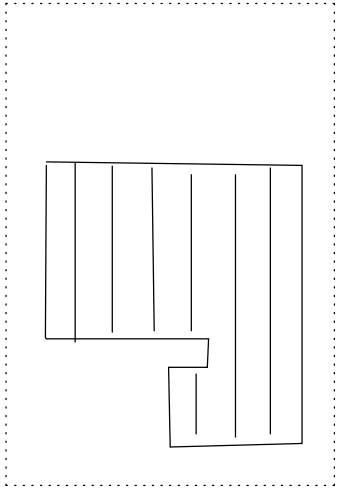

$t=-0.6$

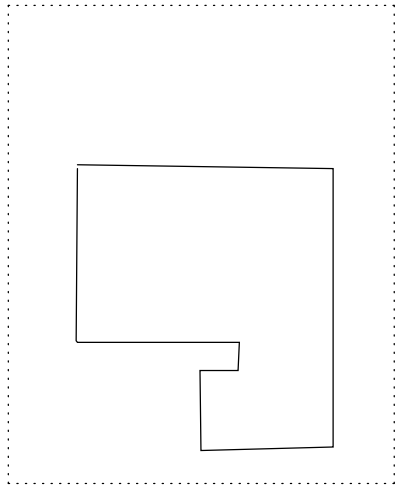

$t=-0.4$

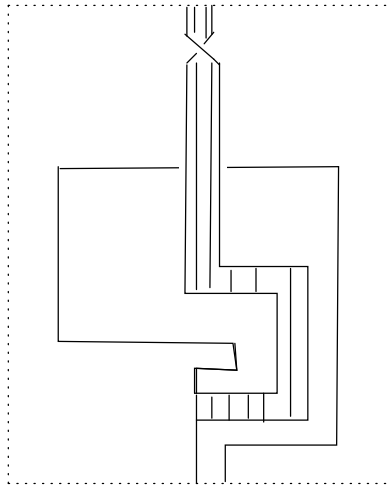

$t=-0.2$

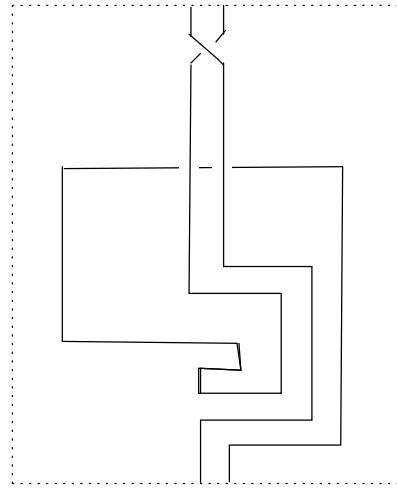

$t=0$

Figure 4.9.(1)

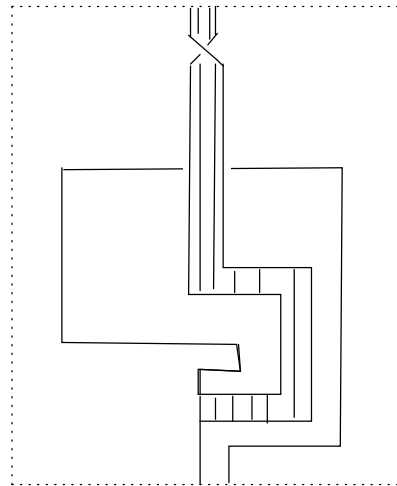

t=0.2

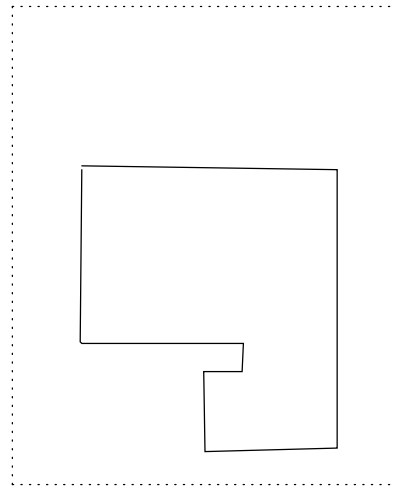

t=0.4

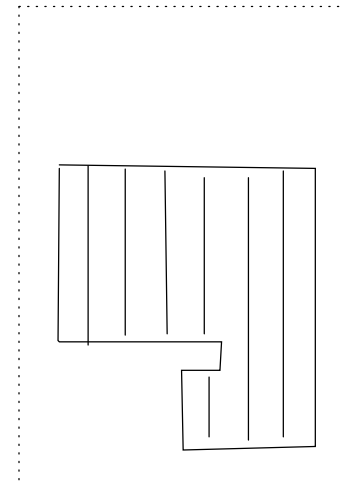

t=0.6

Figure 4.9.(2)

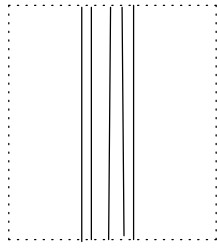

$t=-0.5$

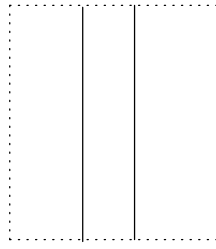

$t=0$

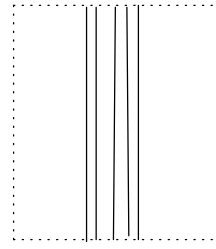

$t=0.5$

Figure 4.10

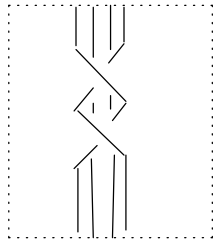

$t=-0.5$

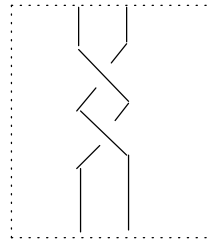

$t=0$

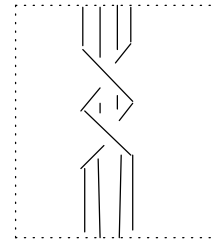

$t=0.5$

Figure 4.11

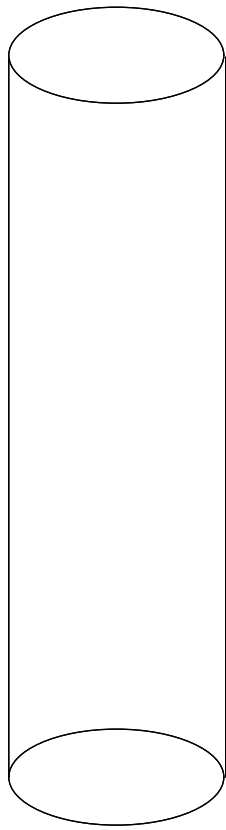

$t=-0.5$

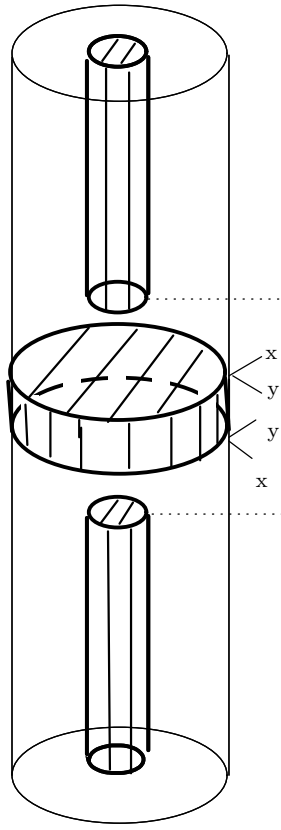

$t=0$

Figure 4.12

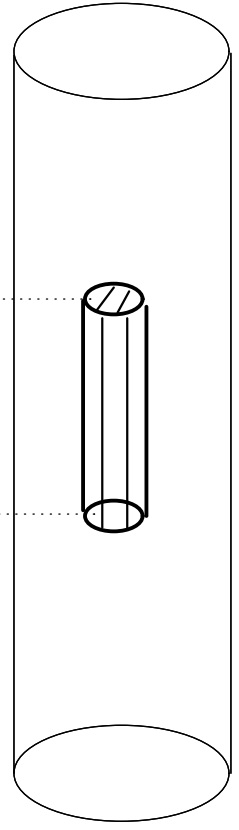

$t=0.5$

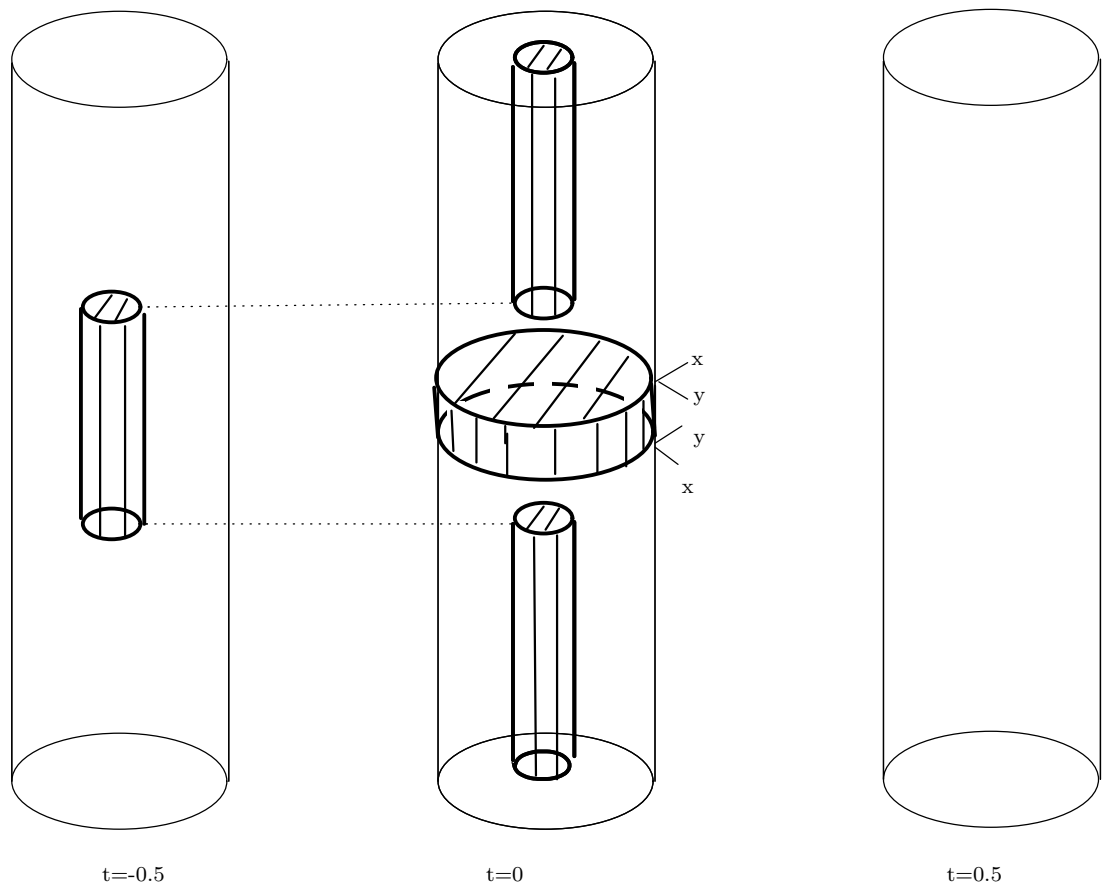
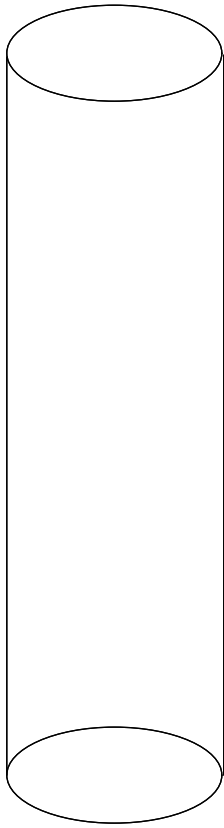
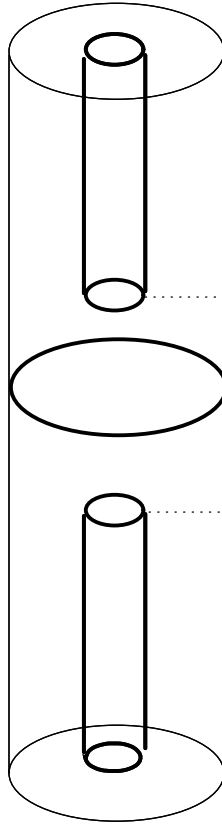

Figure 4.13



$t = -0.5$



$t = 0$

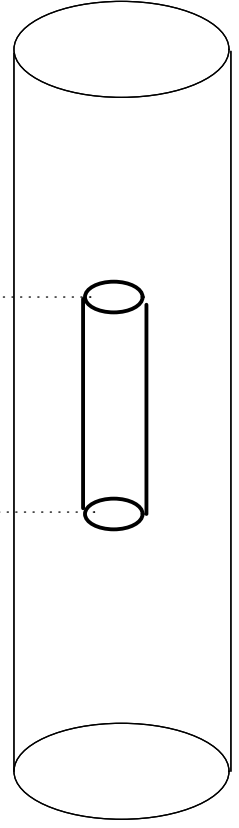

$t = 0.5$

Figure 9.1

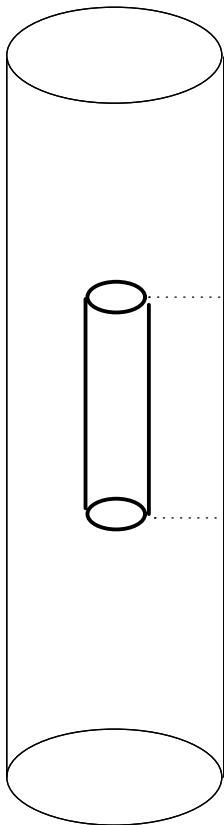

$t=-0.5$

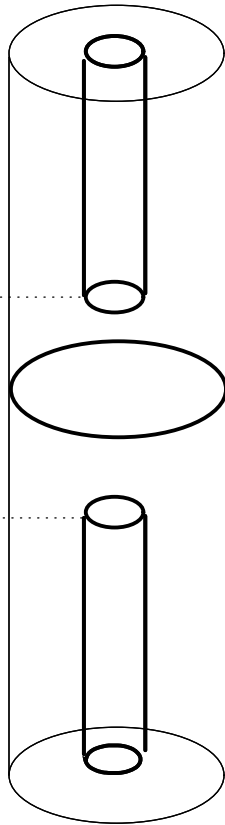

$t=0$

Figure 9.2

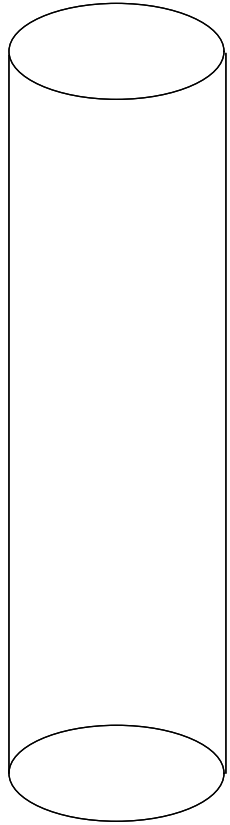

$t=0.5$

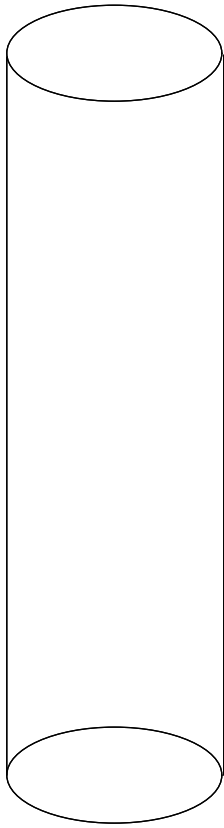

$t = -0.5$

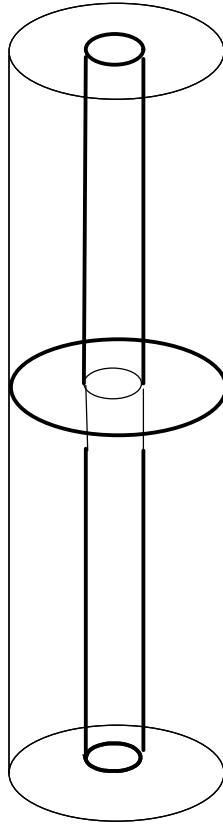

$t = 0$

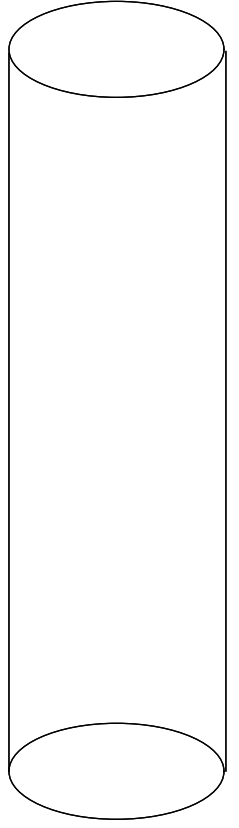

$t = 0.5$

Figure 9.3