

# Braid presentation of virtual knots and welded knots

Seiichi Kamada \*

Department of Mathematics, Osaka City University,  
Sumiyoshi-ku, Osaka 558-8585, Japan

November 15, 2021

## Abstract

Virtual knots were first introduced by L. Kauffman, which are a generalization of classical knots and links. They lead us to the notion of virtual braids, which are closely related with welded braids of R. Fenn, R. Rimányi and C. Rourke. It is proved that any virtual knot is uniquely described as the closure of a virtual braid modulo certain basic moves. This is analogous to the Alexander and Markov theorem for classical knots and braids. A similar result is proved for welded knots and braids

*Mathematics Subject Classification:* Primary 57M25.

*Key words and phrases:* virtual knot, braid, welded braid, Alexander and Markov theorem, exchange move.

## 1. Introduction

In 1996, L. Kauffman introduced the notion of a virtual knot, which is motivated by study of knots in a thickened surface and abstract Gauss codes, cf. [23, 24]. According to M. Goussarov, M. Polyak and O. Viro [16], two classical knot diagrams represent the same knot type if and only if they represent the same virtual knot type. Thus, the notion of a virtual knot is a generalization of a classical knot in 3-space. Some properties and applications of virtual knots are found in [12, 16, 19, 20, 24, 26, 30, 31, 32, 33, 34, 35], etc.

Using the basic moves appearing in the definition of a virtual knot, we obtain the notion of a virtual braid (cf. [24]). It is closely related with the welded braid

---

\*Supported by a Fellowship from the Japan Society for the Promotion of Science.

group  $WB_m$  and the braid-permutation group  $BP_m$ . R. Fenn, R. Rimányi and C. Rourke [13] defined the groups  $WB_m$  and  $BP_m$  and proved that they are isomorphic. There is a canonical epimorphism from the virtual braid group  $VB_m$  to the welded braid group  $WB_m$ , and the group  $VB_m$  contains the braid group  $B_m$  and the symmetric group  $S_m$  as subsets in a natural way.

Braid theory plays an important role in classical knot theory. The two theories are related by Alexander's and Markov's theorems which state that every knot (or link) type is represented by the closure of a braid and such a braid presentation is unique up to conjugations and stabilizations (cf. [1, 3, 4, 5, 6, 7, 8, 9, 10, 27, 36, 37, 39, 40]). There is a one-to-one correspondence between links and braids modulo these operations. Analogously, virtual braid theory is expected to be so in virtual knot theory. It is quite easy to prove the Alexander theorem for virtual knots; that is, every virtual link type is represented by the closure of a virtual braid. In fact, this is obvious from the relationship between virtual links and Gauss diagrams, or Gauss codes given in [16, 24]. In [25], Kauffman asked whether there is a generalization of the Markov theorem for virtual knots. Our main result is the following, which is an answer to his question and ensures a relationship between virtual braid theory and virtual knot theory.

**Theorem 3.2** *Two virtual braids (or virtual braid diagrams) have equivalent closures as virtual links if and only if they are related by a finite sequence of the following moves (VM1) – (VM3) (or (VM0) – (VM3)):*

- (VM0) *a braid move (which is a move corresponding to a defining relation of the virtual braid group),*
- (VM1) *a conjugation (in the virtual braid group),*
- (VM2) *a right stabilization of positive, negative or virtual type, and its inverse operation,*
- (VM3) *a right/left virtual exchange move.*

VM0-, VM1- and VM2-moves correspond to classical Markov moves. The last move (VM3-move) is an analogue of an exchange move (cf. [4, 8]). In the category of classical braids, an exchange move is a consequence of Markov moves. However its analogy does not hold in the category of virtual braids (Proposition 3.3). Thus VM3-moves are essential. By Theorem 3.2, a left stabilization of any type (defined in § 3) is realized by VM0-, VM1-, VM2- and VM3-moves. If the left stabilization is of virtual type, then it can be realized without VM3-moves (Proposition 3.4). This is analogous to a fact that a left stabilization of positive/negative type for classical braids is realized by Markov moves. It is rather surprising that a left stabilization of positive/negative type for virtual braids is not realized by VM0-, VM1- and VM2-moves (Proposition 3.5).

Most of known virtual knot invariants, as groups, quandles, Alexander polynomials, and f-polynomials (Jones polynomials, normalized bracket polynomi-

als), are considered and calculated easily via virtual braids (see [24, 34] for these invariants): Group presentations and quandle presentations are obtained from virtual braids by a method which is completely analogous to that in classical knot theory (although upper presentation and lower presentation yield different groups and quandles in general, [16, 24]). The Burau representation is easily defined for virtual braids and it brings Alexander polynomials. The notion of Temperley-Lieb algebra is generalized to virtual ones and its basis is much simpler than the classical one, [26]. Using the virtual Temperley-Lieb algebra, one can obtain the f-polynomials via braids. Very recently, D. Silver and S. Williams [35] found a new group invariant for a virtual link (with  $\mu$  components) and a  $(\mu + 1)$ -variable polynomial invariant derived from it. J. Sawollek [32] also found a similar invariant. Their invariants are so powerful as to distinguish the trivial knot and Kauffman's example [24, 25] of a virtual knot which cannot be distinguished by all of the above invariants. (J. S. Carter proved this fact independently by an argument in [11]). D. Silver informed the author that their invariant in [35] was motivated by the Burau representation and it is natural to consider via virtual braids. Related topics to these invariants from a point of view of virtual braids will be discussed elsewhere.

Welded braid theory due to Fenn, Rimányi and Rourke [13] yields the notion of welded knots and links, which are also known as virtual knots and links in the weak sense ([25, 31]). We prove Alexander's and Markov's theorems for welded knots and links.

**Theorem 7.2** *Two welded braids (or welded braid diagrams) have equivalent closures as welded links if and only if they are related by a finite sequence of the following moves (WM1) – (WM2) (or (WM0) – (WM2)):*

- (WM0) *a welded braid move (which is a move corresponding to a defining relation of the welded braid group),*
- (WM1) *a conjugation in the welded braid group,*
- (WM2) *a right stabilization of positive, negative or virtual type, and its inverse operation.*

The author wishes to thank J. S. Carter, N. Kamada, L. H. Kauffman, D. S. Silver, X.-S. Lin and O. Dasbach for many stimulating conversations. He also thanks to Department of Mathematics and Statistics, University of South Alabama for hospitality.

## 2. Virtual braids

Let  $m$  be a positive integer and  $Q_m$  a set of  $m$  interior points of the interval  $[0, 1]$ . We denote by  $E$  the 2-disk  $[0, 1] \times [0, 1]$  and by  $p_2 : E \rightarrow [0, 1]$  the second factor projection.

**Definition 2.1** A *virtual braid diagram of degree  $m$*  is an immersed 1-manifold  $b = a_1 \cup \dots \cup a_m$  in  $E$  such that

- (1)  $\partial b = Q_m \times \{0, 1\} \subset E$ ,
- (2) for each  $i \in \{1, \dots, m\}$ ,  $p_2|_{a_i} : a_i \rightarrow [0, 1]$  is a homeomorphism,
- (3) the singularity (the multiple point set)  $V(b)$  consists of transverse double points,
- (4)  $p_2|_{V(b)} : V(b) \rightarrow [0, 1]$  is injective,
- (5) each point of  $V(b)$  is assigned information of *positive*, *negative* or *virtual crossing* as in Figure 1 (where the labels  $1, \dots, 4$  are used later).

The arcs  $a_1, \dots, a_m$  are assumed to be oriented from the top ( $[0, 1] \times \{1\}$ ) to the bottom ( $[0, 1] \times \{0\}$ ) of  $E$  and two virtual braid diagrams are identified if they are transformed into each other continuously keeping the above conditions.

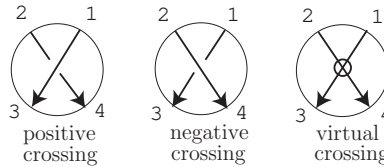

Figure 1: Crossings

The set of virtual braid diagrams of degree  $m$  (with the concatenation product) forms a monoid which is generated by  $\sigma_i, \sigma_i^{-1}, \tau_i$  ( $i = 1, \dots, m - 1$ ) as in Figure 2. The trivial element is  $Q_m \times [0, 1] \subset E$ .

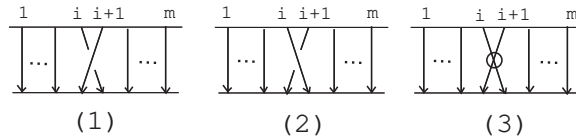

Figure 2: Standard generators

**Definition 2.2** The *virtual braid group  $VB_m$  of degree  $m$*  is the group obtained from the monoid of virtual braid diagrams of degree  $m$  by introducing the

following relations:

$$\begin{aligned}
& \text{(Trivial relations)} \quad \sigma_i \sigma_i^{-1} = \sigma_i^{-1} \sigma_i = 1 \\
& \text{(Braid relations)} \quad \begin{cases} \sigma_i \sigma_j = \sigma_j \sigma_i, & |i - j| > 1 \\ \sigma_i \sigma_{i+1} \sigma_i = \sigma_{i+1} \sigma_i \sigma_{i+1} \end{cases} \\
& \text{(Permutation group relations)} \quad \begin{cases} \tau_i^2 = 1 \\ \tau_i \tau_j = \tau_j \tau_i, & |i - j| > 1 \\ \tau_i \tau_{i+1} \tau_i = \tau_{i+1} \tau_i \tau_{i+1} \end{cases} \\
& \text{(Mixed relations)} \quad \begin{cases} \sigma_i \tau_j = \tau_j \sigma_i, & |i - j| > 1 \\ \sigma_i \tau_{i+1} \tau_i = \tau_{i+1} \tau_i \sigma_{i+1}. \end{cases}
\end{aligned}$$

A *virtual braid of degree  $m$*  is an element of  $VB_m$ . We denote it by the same symbol  $b$  as its representative (a virtual braid diagram)  $b$  unless it makes confusion.

The welded braid group  $WB_m$  (defined in [13]) is obtained from  $VB_m$  by introducing additional relations  $\tau_i \sigma_{i+1} \sigma_i = \sigma_{i+1} \sigma_i \tau_{i+1}$  ( $i = 1, \dots, m-2$ ). There is a canonical epimorphism  $VB_m \rightarrow WB_m$ . In particular, we see that the subgroup of  $VB_m$  generated by  $\sigma_i$  ( $i = 1, \dots, m$ ) is isomorphic to the braid group  $B_m$  and the subgroup generated by  $\tau_i$  ( $i = 1, \dots, m$ ) is isomorphic to the symmetric group  $S_m$ , cf. [13].

### 3. Braid Presentation of Virtual Knots

A *virtual link diagram* is a closed oriented 1-manifold  $K$  immersed in  $\mathbf{R}^2$  such that the singularity set  $V(K)$  consists of transverse double points each of which is assigned information of positive, negative or virtual crossing as in Figure 1. Positive and negative crossings are also called *real crossings*. Virtual link diagrams are considered up to isotopy of  $\mathbf{R}^2$ . *Virtual Reidemeister moves* are the local moves illustrated in Figure 3. Notice that the moves indicated by (b) are obtained from the moves indicated by (a) by use of RII-moves or VII-moves. Two virtual link diagrams are *equivalent* (as virtual links) if they are related by a finite sequence of virtual Reidemeister moves. A *virtual link* (or a *virtual link type*) is the equivalence class of a virtual link diagram, [16, 23, 24].

For a virtual braid diagram  $b$ , the *closure* of  $b$  is a virtual link diagram constructed as in Figure 4. If  $b$  and  $b'$  are equivalent as virtual braids, then their closures are equivalent as virtual links. Thus in virtual knot theory the closure makes sense for a virtual braid.

**Proposition 3.1** *Every virtual link type is represented by the closure of a virtual braid diagram.*

For virtual braids  $b_1, b_2 \in VB_m$ , we say that  $b_2^{-1} b_1 b_2$  is obtained from  $b_1$  by

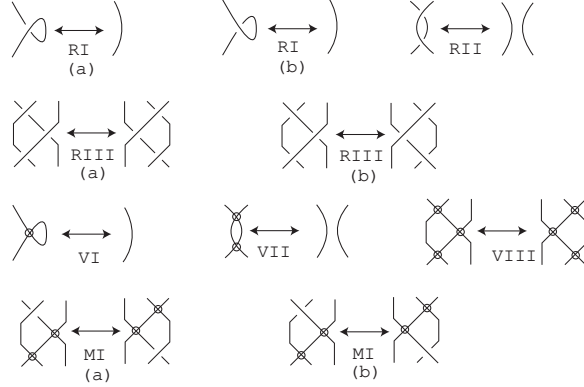

Figure 3: Virtual Reidemeister moves

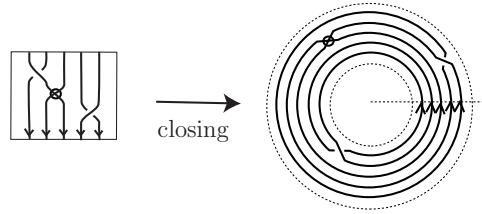

Figure 4: Closure

a *conjugation*.

For a virtual braid (diagram)  $b$  of degree  $m$ , we denote by  $\iota_s^t(b)$  the virtual braid (diagram) of degree  $m + s + t$  obtained from  $b$  by adding  $s$  trivial arcs to the left of  $b$  and  $t$  trivial arcs to the right. This defines a monomorphism  $\iota_s^t : VB_m \rightarrow VB_{m+s+t}$ .

A *right stabilization* of *positive*, *negative* or *virtual type* is a replacement of  $b \in VB_m$  by  $\iota_0^1(b)\sigma_m$ ,  $\iota_0^1(b)\sigma_m^{-1}$  or  $\iota_0^1(b)\tau_m \in VB_{m+1}$ , respectively. See Figure 5. Similarly, a *left stabilization* is a replacement of  $b \in VB_m$  by  $\iota_1^0(b)\sigma_1$ ,  $\iota_1^0(b)\sigma_1^{-1}$  or  $\iota_1^0(b)\tau_1$ .

A *right virtual exchange move* is a replacement

$$\iota_0^1(b_1)\sigma_m^{-1}\iota_0^1(b_2)\sigma_m \leftrightarrow \iota_0^1(b_1)\tau_m\iota_0^1(b_2)\tau_m \in VB_{m+1}$$

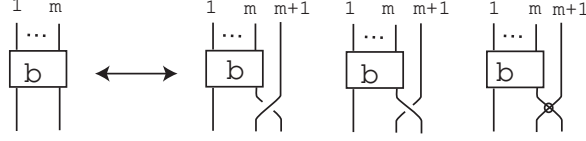

Figure 5: Right stabilizations

and a *left virtual exchange move* is a replacement

$$\iota_1^0(b_1)\sigma_1^{-1}\iota_1^0(b_2)\sigma_1 \leftrightarrow \iota_1^0(b_1)\tau_1\iota_1^0(b_2)\tau_1 \in VB_{m+1}$$

where  $b, b' \in VB_m$ , see Figure 6.

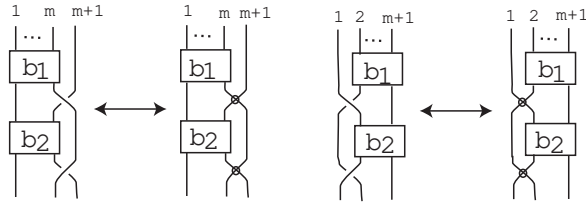

Figure 6: Right/left virtual exchange moves

**Theorem 3.2** *Two virtual braids (or virtual braid diagrams) have equivalent closures as virtual links if and only if they are related by a finite sequence of the following moves (VM1) – (VM3) (or (VM0) – (VM3)):*

- (VM0) *a braid move (which is a move corresponding to a defining relation of the virtual braid group),*
- (VM1) *a conjugation (in the virtual braid group),*
- (VM2) *a right stabilization of positive, negative or virtual type, and its inverse operation,*
- (VM3) *a right/left virtual exchange move.*

A replacement

$$\iota_0^1(b_1)\sigma_m^{-1}\iota_0^1(b_2)\sigma_m \leftrightarrow \iota_0^1(b_1)\sigma_m\iota_0^1(b_2)\sigma_m^{-1} \in B_{m+1},$$

where  $b_1, b_2 \in B_m$ , is called an *exchange move*, cf. [4, 8]. A VM3-move is an analogue of this move. In classical braid theory, an exchange move is a

consequence of braid moves, conjugations and right stabilizations. However, in virtual braid theory, a virtual exchange move is independent of these moves.

**Proposition 3.3** *A VM3-move is not a consequence of VM0-, VM1- and VM2-moves; namely, there is a pair of virtual braids which are related by a VM3-move and never related by a sequence of VM0-, VM1- and VM2-moves.*

By Theorem 3.2, a left stabilization of any type for virtual braids is a consequence of VM0-, VM1-, VM2- and VM3-moves. If it is of virtual type, then we do not need VM3-moves.

**Proposition 3.4** *A left stabilization of virtual type is a consequence of a VM2-move and some VM0- and VM1-moves.*

This is analogous to a fact that a left stabilization (of positive/negative type) for classical braids is a consequence of a right stabilization and some braid moves and conjugations. If the left stabilization for virtual braids is of positive/negative type, then we need VM3-moves in general.

**Proposition 3.5** *A left stabilization of positive/negative type for virtual braids is not a consequence of VM0-, VM1- and VM2-moves; namely, there is a pair of virtual braids which are related by a left stabilization of positive/negative type and never related by a sequence of VM0-, VM1- and VM2-moves.*

## 4. Braiding Process

For a virtual link diagram  $K$ , we denote by  $V_R(K)$  the set of real crossings and by  $S(K) : V_R(K) \rightarrow \{+1, -1\}$  the map assigning the real crossings their signs. For a real crossing  $v \in V_R(K)$ , let  $N(v)$  be a regular neighborhood of  $v$  as in Figure 1. We denote by  $v^{(1)}, v^{(2)}, v^{(3)}, v^{(4)}$  the four points of  $\partial N(v) \cap K$  ordered as in the figure. Put  $W = W(K) = \text{Cl}(\mathbf{R}^2 - \cup_{v \in V_R(K)} N(v))$  and  $V_R^\partial(K) = \{v^{(j)} | v \in V_R(K), j \in \{1, 2, 3, 4\}\}$ , where Cl means the closure. The restriction of  $K$  to  $W$ , denoted by  $K|_W$ , is the union of some oriented arcs and loops immersed in  $W$  such that the singularities are virtual crossings of  $K$  and the boundaries of the arcs are the set  $V_R^\partial(K)$ .

Define a subset  $G(K) \subset V_R^\partial(K) \times V_R^\partial(K)$  such that  $(a, b) \in G(K)$  if and only if  $K|_W$  has an arc starting from  $a$  and terminating at  $b$ . We denote by  $\mu(K)$  the number of components of  $K$ . For example, for a virtual link diagram illustrated in Figure 7,

$$\begin{aligned} V_R(K) &= \{v_1, v_2, v_3\}, \\ S(K) &: v_1 \mapsto +1, \quad v_2 \mapsto +1, \quad v_3 \mapsto -1, \\ G(K) &= \{(v_3^{(3)}, v_1^{(1)}), (v_1^{(3)}, v_2^{(2)}), (v_2^{(4)}, v_3^{(2)}), (v_3^{(4)}, v_2^{(1)}), (v_2^{(3)}, v_1^{(2)}), (v_1^{(4)}, v_3^{(1)})\}, \\ \mu(K) &= 2. \end{aligned}$$



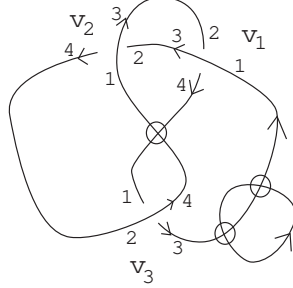

Figure 7: A virtual link diagram

The *Gauss data* of  $K$  is the quadruple  $(V_R(K), S(K), G(K), \mu(K))$ . We say that two virtual link diagrams  $K$  and  $K'$  have the *same Gauss data* if  $\mu(K) = \mu(K')$  and if there is a bijection  $g : V_R(K) \rightarrow V_R(K')$  such that  $g$  preserves the signs of the crossing points and that  $(a, b) \in G(K)$  implies  $(g(a), g(b)) \in G(K')$ , where  $g : V_R^\partial(K) \rightarrow V_R^\partial(K')$  is the bijection induced from  $g : V_R(K) \rightarrow V_R(K')$ . This condition is equivalent to that  $K$  and  $K'$  have the same Gauss diagram in the sense of [16] or the same Gauss code in the sense of [24].

Let  $K$  be a virtual link diagram and  $W = W(K) = \text{Cl}(\mathbf{R}^2 - \cup_{v \in V_R(K)} N(v))$  as before. Suppose that  $K'$  is a virtual link diagram with the same Gauss data as  $K$ . Then we can deform  $K'$  by an isotopy of  $\mathbf{R}^2$  such that

- (1)  $K$  and  $K'$  are identical in  $N(v)$  for every  $v \in V_R(K)$ ,
- (2)  $K'$  has no real crossings in  $W$ , and
- (3) there is a one-to-one correspondence between the arcs/loops of  $K|_W$  and those of  $K'|_W$  with respect to the end points of the arcs.

In this situation, we say that  $K'$  is obtained from  $K$  by *replacing*  $K|_W$ .

**Lemma 4.1** ([16, 23, 24]) *If two virtual link diagrams  $K$  and  $K'$  have the same Gauss data, then  $K$  is equivalent to  $K'$ . Moreover, such an equivalence can be realized by VI-, VII-, VIII- and MI-moves.*

*Proof.* Without loss of generality we may assume that  $K'$  is obtained from  $K$  by replacing  $K|_W$ . Let  $a_1, a_2, \dots, a_s$  be the arcs/loops of  $K|_W$ , and let  $a'_1, a'_2, \dots, a'_s$  be corresponding ones for  $K'|_W$ . We may assume that  $a'_1$  intersects  $a_2, \dots, a_s$  transversely. The arc or loop  $a_1$  is homotopic to  $a'_1$  in  $\mathbf{R}^2$  (relative to the boundary of  $a_1$  if  $a_1$  is an arc). Taking the homotopy generically with respect to the arcs/loops  $a_2, \dots, a_s$  and the 2-disks  $N_1, \dots, N_n$ , we see that the arc/loop  $a_1$  is transformed into  $a'_1$  by a finite sequence of moves as in Figure 8

up to isotopy of  $\mathbf{R}^2$ . Each move is a VI-, VII-, VIII-, or MI-move. Inductively, every  $a_i$  is transformed into  $a'_i$  by such moves.  $\square$



Figure 8: Moves on immersed curves

Let  $O$  be the origin of  $\mathbf{R}^2$ . Identify  $\mathbf{R}^2 - \{O\}$  with  $\mathbf{R}_+ \times S^1$  by the polar coordinate and let  $\pi : \mathbf{R}^2 - \{O\} = \mathbf{R}_+ \times S^1 \rightarrow S^1$  be the projection, where  $\mathbf{R}_+$  is the half-line consisting of positive numbers. A *braided virtual link diagram* (of degree  $m$ ) is a virtual link diagram  $K$  such that

- (1) it is contained in  $\mathbf{R}^2 - \{O\}$ ,
- (2) for an underlying immersion  $k : \amalg S^1 \rightarrow \mathbf{R}^2 - \{O\}$  of  $K$ , the composition  $\pi \circ k : \amalg S^1 \rightarrow S^1$  is an orientation preserving covering map of degree  $m$  (where  $\amalg S^1$  is the disjoint union of  $\mu(K)$  circles), and
- (3)  $\pi|_{V(K)} : V(K) \rightarrow S^1$  is injective.

A point  $\theta$  of  $S^1$  is called a *regular value* if  $V(K) \cap \pi^{-1}(\theta) = \emptyset$ . By cutting  $K$  along the half-line  $\pi^{-1}(\theta)$  for a regular value  $\theta$ , we obtain a virtual braid diagram whose closure is  $K$ . Such a virtual braid is unique up to conjugation.

**Braiding Process** (Proof of Proposition 3.1). Let  $K$  be a virtual link diagram and let  $N_1, \dots, N_n$  be regular neighborhoods of the real crossings of  $K$ . By an isotopy of  $\mathbf{R}^2$ , we may assume that all  $N_i$  ( $i = 1, \dots, n$ ) are in  $\mathbf{R}^2 - O$ ,  $\pi(N_i) \cap \pi(N_j) = \emptyset$  for  $i \neq j$  and the restriction of  $K$  to  $N_i$  satisfies the condition of a braided virtual link diagram. Replace the remainder  $K|_{W(K)}$  arbitrarily such that the result is a braided virtual link diagram. By Lemma 4.1,  $K$  is equivalent to this diagram.

## 5. Proof of Theorem 3.2 and Proposition 3.4

The terminologies “braid moves”, “right stabilizations” and “right/left virtual exchange moves” are also used for braided virtual link diagrams. (Conjugations are just braid moves.) These moves and their inverse moves are also called VM0-, VM2- and VM3-moves. For example, the moves illustrated in Figure 9 are right stabilizations (VM2-moves) for braided virtual link diagrams. If two braided virtual link diagrams are related by a finite sequence of VM0- and VM2-moves, then we say that they are *virtually Markov equivalent in the strict sense*. If they are related by a finite sequence of VM0-, VM2- and VM3-moves, then we say that they are *virtually Markov equivalent*.

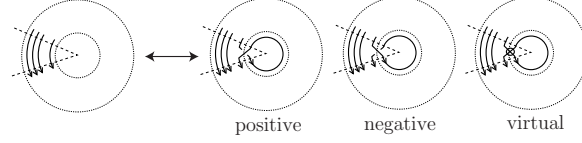

Figure 9: Right stabilizations (VM2-moves)

**Lemma 5.1** *Let  $K$  and  $K'$  be braided virtual link diagrams (possibly of distinct degrees) such that  $K'$  is obtained from  $K$  by replacing  $K|_{W(K)}$ . Then  $K$  and  $K'$  are virtually Markov equivalent in the strict sense.*

*Proof.* Let  $N_1, \dots, N_n$  be regular neighborhoods of the real crossings of  $K$  (and  $K'$ ) and  $W = W(K) = \text{Cl}(\mathbf{R}^2 - \cup_{i=1}^n N_i)$ . Take a common regular value  $\theta_0 \in S^1$  for  $K$  and  $K'$  such that  $\theta_0$  is not in  $\pi(\cup_{i=1}^n N_i)$ . Assume that there exists an arc/loop  $a_i$  of  $K|_W$  and the corresponding one  $a'_i$  of  $K'|_W$  such that  $\sharp(a_i \cap \pi^{-1}(\theta_0)) \neq \sharp(a'_i \cap \pi^{-1}(\theta_0))$ . Move a small part of  $a_i$  or  $a'_i$  toward the origin by a series of VM0-moves corresponding to  $\tau_i^2 = 1$  and apply some VM2-moves of virtual type so that  $\sharp(a_i \cap \pi^{-1}(\theta_0)) = \sharp(a'_i \cap \pi^{-1}(\theta_0))$ . Thus we may assume that  $\sharp(a_i \cap \pi^{-1}(\theta_0)) = \sharp(a'_i \cap \pi^{-1}(\theta_0))$  for every arc/loop  $a_i$  of  $K|_W$ . Let  $k$  and  $k'$  be underlying immersions  $\mathbb{H}S^1 \rightarrow \mathbf{R}^2 - \{O\}$  of  $K$  and  $K'$  such that they are identical near the preimages of the real crossings. Let  $I_1, \dots, I_s$  be intervals or circles in  $\mathbb{H}S^1$  with  $k(I_i) = a_i$  for  $i = 1, \dots, s$ , and put  $k_i = k|_{I_i}$ . Let  $k'_1, \dots, k'_s$  be such immersions obtained from  $K'$ . Note that  $\pi \circ k_i : I_i \rightarrow S^1$  and  $\pi \circ k'_i : I_i \rightarrow S^1$  are orientation preserving immersions and  $\pi \circ k_i|_{\partial I_i} = \pi \circ k'_i|_{\partial I_i}$ . Since  $a_i$  and  $a'_i$  have the same degree with respect to  $\theta_0$ , we have a homotopy  $\{k_i^s : I_i \rightarrow \mathbf{R}^2 - \{O\}\}_{s \in [0,1]}$  between  $k_i = k_i^0$  and  $k'_i = k_i^1$  relative to the boundary  $\partial I_i$  such that for each  $s \in [0,1]$ ,  $\pi \circ k_i^s : I_i \rightarrow S^1$  is an immersion. Taking such a homotopy generically with respect to the other arcs/loops of  $K|_W$  (and  $K'|_W$ ) and the 2-disks  $N_1, \dots, N_n$ , we have a finite sequence of VM0-moves transforming  $a_i$  to  $a'_i$  (recall the proof of Lemma 4.1). Applying this procedure inductively, we see that  $K$  is transformed into  $K'$  by VM0-moves.  $\square$

Applying the above argument, we obtain Proposition 3.4.

*Proof of Proposition 3.4.* In Figure 10, we show a process that  $b \in VB_m$  is transformed into  $\iota_1^0(b)\tau_1 \in VB_{m+1}$  (the figure is for the case of  $m = 3$ ). The step (2)  $\rightarrow$  (3) is a VM2-move, up to VM1-moves. The other steps are VM0-moves and VM1-moves.  $\square$

**Lemma 5.2** *Two braided virtual link diagrams with the same Gauss data are virtually Markov equivalent in the strict sense.*

*Proof.* Let  $K$  and  $K'$  be braided virtual link diagrams with the same Gauss

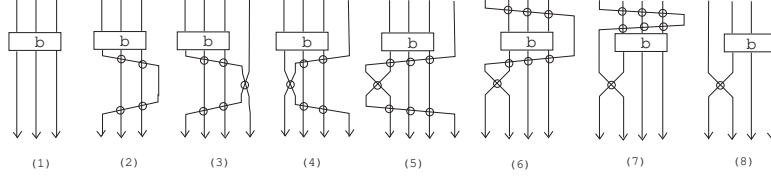

Figure 10:

data. Let  $N_1, \dots, N_n$  be regular neighborhoods (as in Figure 1) of the real crossings  $v_1, \dots, v_n$  of  $K$ , and  $N'_1, \dots, N'_n$  be regular neighborhoods of the corresponding real crossings  $v'_1, \dots, v'_n$  of  $K'$ .

(Case 1) Suppose that  $\pi(N_1), \dots, \pi(N_n)$  and  $\pi(N'_1), \dots, \pi(N'_n)$  appear in  $S^1$  in the same (cyclic) order. By an isotopy of  $\mathbf{R}^2$ , deform  $K$  keeping the condition of a braided virtual link diagram such that  $N_1 = N'_1, \dots, N_n = N'_n$  and the restrictions of  $K$  and  $K'$  to these disks are identical. By Lemma 5.1,  $K$  and  $K'$  are virtually Markov equivalent in the strict sense.

(Case 2) Suppose that  $\pi(N_1), \dots, \pi(N_n)$  and  $\pi(N'_1), \dots, \pi(N'_n)$  do not appear in  $S^1$  in the same (cyclic) order. It is sufficient to consider a special case that  $\pi(N_1), \dots, \pi(N_n)$  and  $\pi(N'_1), \dots, \pi(N'_n)$  appear in  $S^1$  in the same order except a pair, say  $\pi(N_1)$  and  $\pi(N_2)$ . Applying VM0-moves, we may assume that  $K$  is the closure of a virtual braid diagram which looks like the left one of Figure 11, where  $b_1$  is a virtual braid diagram without real crossings and  $b_2$  is a virtual braid diagram. The middle of the figure is obtained from the left by VM0- and VM2-moves. The right one is obtained from the middle by VM0-moves. By Case 1, the right one and  $K'$  are virtually Markov equivalent in the strict sense. Thus  $K$  and  $K'$  are virtually Markov equivalent in the strict sense.  $\square$

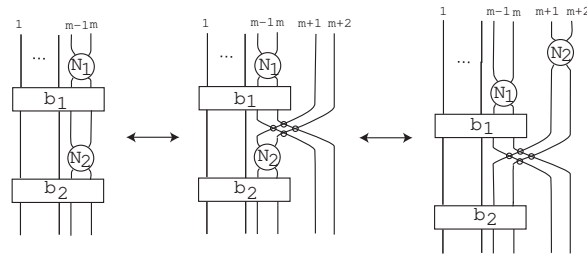

Figure 11:

Since the braiding process (given in § 4) does not change the Gauss data of a virtual link diagram, we have the following.

**Corollary 5.3** *For a virtual link diagram  $K$ , a braided virtual link diagram obtained by the braiding process is unique up to virtual Markov equivalence in the strict sense.*

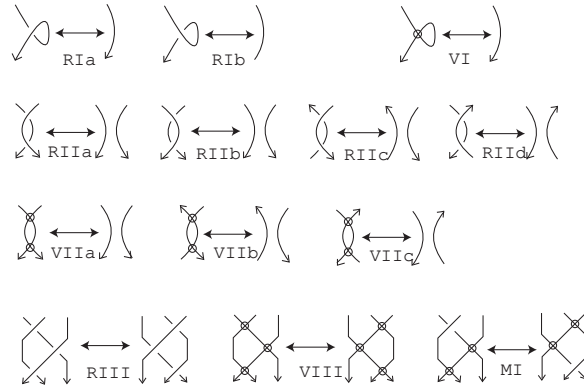

Figure 12: Oriented Reidemeister moves

*Proof of Theorem 3.2.* The if part is obvious. We prove the only if part. Let  $K$  and  $K'$  be braided virtual link diagrams which are equivalent as virtual links. There is a finite sequence of virtual link diagrams from  $K$  to  $K'$  each step of which is one of the moves in Figure 12. (For RI-moves and VI-moves, there are other cases of orientations of the arcs. These cases are obtained from the moves in the figure by RII- and VII-moves. This is called *the Whitney trick*. For RIII-, VIII- and MI-moves, there are other cases of orientations on the arcs. These cases are also obtained from the moves in the figure by RII- and VII-moves.) By use of VII-moves, an RIIc-move and an RIId-move are obtained from an Xa-move and an Xb-move in Figure 13, respectively. Therefore, there is a finite sequence of virtual link diagrams  $K = K_0, K_1, \dots, K_s = K'$  such that each  $K_i$  is obtained from  $K_{i-1}$  by an RIa-, RIb-, VI-, RIIa-, RIIb-, Xa-, Xb-, VIIa-, VIIb-, VIIc-, RIII-, VIII- or MI-move.

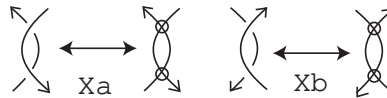

Figure 13:

Apply the braiding process to each  $K_i$  and let  $\widetilde{K}_i$  be a braided virtual link diagram with the same Gauss data as  $K_i$ . Note that  $\widetilde{K}_i$  is uniquely determined up to virtual Markov equivalence in the strict sense (Lemma 5.2). We assume that  $\widetilde{K}_0 = K_0 = K$  and  $\widetilde{K}_s = K_s = K'$ . Then it is sufficient to prove that for each  $i$  ( $i = 1, \dots, s$ ),  $\widetilde{K}_i$  and  $\widetilde{K}_{i-1}$  are virtually Markov equivalent.

If  $K_i$  is obtained from  $K_{i-1}$  by a VI-, VIIa-, VIIb-, VIIc-, VIII- or MI-move, then  $K_i$  and  $K_{i-1}$  have the same Gauss data and so do  $\widetilde{K}_i$  and  $\widetilde{K}_{i-1}$ . By Lemma 5.2,  $\widetilde{K}_i$  and  $\widetilde{K}_{i-1}$  are virtually Markov equivalent.

Suppose that  $K_i$  is obtained from  $K_{i-1}$  by an RIa-, RIb-, RIIa-, RIIb-, Xa-, Xb-, or RIII-move. Let  $\Delta$  be a 2-disk in  $\mathbf{R}^2$  where the move is applied, and let  $\Delta^c$  be the complement of  $\Delta$  in  $\mathbf{R}^2$  so that  $K_i \cap \Delta^c = K_{i-1} \cap \Delta^c$ .

If the move is not an Xb-move, then we can deform  $K_i$  and  $K_{i-1}$  by an isotopy of  $\mathbf{R}^2$  such that  $K_i \cap \Delta$  and  $K_{i-1} \cap \Delta$  satisfy the condition of a braided virtual link diagram. Apply the braiding process to the remainder  $K_i \cap \Delta^c = K_{i-1} \cap \Delta^c$ , and we have braided virtual link diagrams, say  $\widetilde{K}'_i$  and  $\widetilde{K}'_{i-1}$  such that  $\widetilde{K}'_i \cap \Delta = K_i \cap \Delta$ ,  $\widetilde{K}'_{i-1} \cap \Delta = K_{i-1} \cap \Delta$ , and  $\widetilde{K}'_i \cap \Delta^c = \widetilde{K}'_{i-1} \cap \Delta^c$ . If the move is an RIa-, RIb-, or Xa-move, then  $\Delta$  contains the origin  $O$  of  $\mathbf{R}^2$  and  $\widetilde{K}'_i$  and  $\widetilde{K}'_{i-1}$  are related by a right stabilization of positive/negative type or a right virtual exchange move. If the move is an RIIa-, RIIb-, or RIII-move, then  $\Delta$  is disjoint from  $O$  and  $\widetilde{K}'_i$  and  $\widetilde{K}'_{i-1}$  are related by a VM0-move. Since  $\widetilde{K}'_i$  has the same Gauss data as  $K_i$ , it is virtually Markov equivalent to  $\widetilde{K}_i$  by Lemma 5.2. Similarly  $\widetilde{K}'_{i-1}$  is virtually Markov equivalent to  $\widetilde{K}_{i-1}$ . Therefore  $\widetilde{K}_i$  and  $\widetilde{K}_{i-1}$  are virtually Markov equivalent.

If the move is an Xb-move, then deform  $K_i$  and  $K_{i-1}$  by an isotopy of  $\mathbf{R}^2$  such that they are the closures of the (virtual) tangles depicted as (A1) and (B1) in Figure 14, say  $K'_i$  and  $K'_{i-1}$ , where  $b_1$  and  $b_2$  are virtual braid diagrams. (First deform  $K_i \cap \Delta$  and  $K_{i-1} \cap \Delta$  such that they are as in the thick boxes of (A1) and (B1). Then apply the braiding process to the remainder.) Let  $\widetilde{K}'_i$  and  $\widetilde{K}'_{i-1}$  be the closures of the virtual braid diagrams depicted as (A2) and (B2) in the figure. Note that  $\widetilde{K}'_i$  has the same Gauss data as  $K'_i$  and hence as  $K_i$ . Thus  $\widetilde{K}'_i$  is virtually Markov equivalent to  $\widetilde{K}_i$  (Lemma 5.2). Similarly  $\widetilde{K}'_{i-1}$  is virtually Markov equivalent to  $\widetilde{K}_{i-1}$ . On the other hand,  $\widetilde{K}'_i$  and  $\widetilde{K}'_{i-1}$  are related by a left virtual exchange move. Therefore  $\widetilde{K}_i$  and  $\widetilde{K}_{i-1}$  are virtually Markov equivalent.  $\square$

## 6. Proof of Propositions 3.3 and 3.5

We fix a positive integer  $N$  and an integer  $\alpha$ . Let  $K$  be a virtual link diagram and let  $N_1, \dots, N_n$  be regular neighborhoods of the real crossings of  $K$ . Let

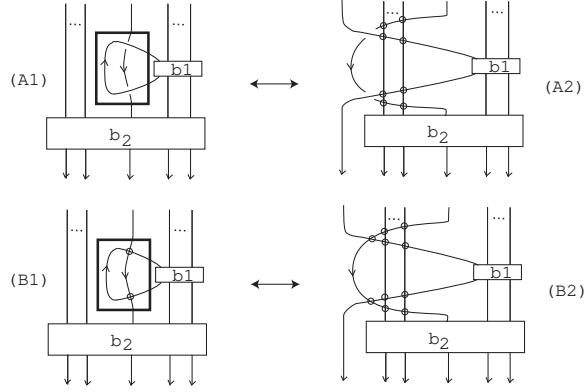

Figure 14:

$a_1, \dots, a_s$  be the arcs/loops of  $K|_{W(K)}$  as before. A *state*  $S$  is assignment of elements of  $\{1, 2, \dots, N\}$  to the arcs/loops  $a_1, \dots, a_s$ . A state  $S$  is *admissible* if at each crossing  $v$  of  $K$  the labels around  $v$  are one of Figure 15. Then we give  $v$  an element of  $\mathbf{Z}[q, q^{-1}]$  indicated in the figure, which is denoted by  $g(K, S; v)$ . For an admissible state  $S$  of  $K$ , let

$$G(K, S) = \prod_{v \in V(K)} g(K, S; v).$$

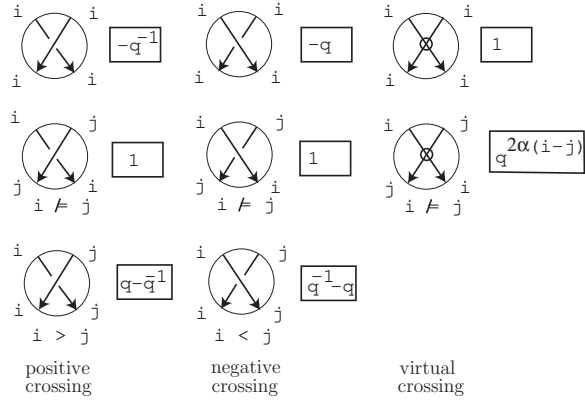

Figure 15:

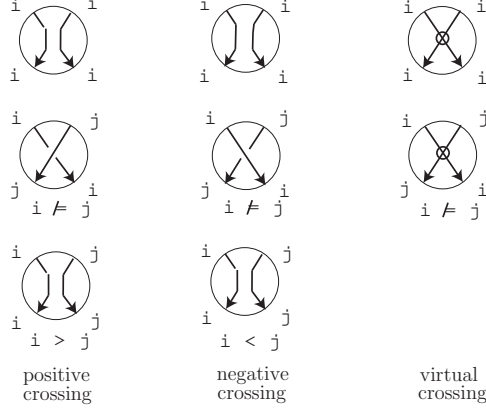

Figure 16:

For an admissible state  $S$  of  $K$ , let  $K^S$  be the virtual link diagram obtained from  $K$  by changing the crossing points of  $K$  as in Figure 16. Then each component, say  $c$ , of  $K^S$  inherits a unique element of  $\{1, 2, \dots, N\}$  from the state  $S$ , which we denote by  $S(c)$ . Let

$$H(K, S) = \prod_c q^{2S(c)-N-1},$$

where  $c$  runs over all components of  $K^S$ .

We denote by  $w(K)$  the number of positive crossings minus the number of negative crossings of  $K$ . For a virtual link diagram  $K$ , we define  $Q_{N,\alpha}(K)$  by

$$Q_{N,\alpha}(K) = (-q^N)^{w(K)} \sum_S G(K, S) H(K, S) \in \mathbf{Z}[q, q^{-1}],$$

where  $S$  runs over all admissible states of  $K$ . For a virtual braid diagram  $b$ , we define  $Q_{N,\alpha}(b)$  by  $Q_{N,\alpha}(\text{closure of } b)$ .

**Lemma 6.1** *If virtual braid diagrams  $b$  and  $b'$  are related by VM0-, VM1- and VM2-moves, then  $Q_{N,\alpha}(b) = Q_{N,\alpha}(b')$ . (If braided virtual link diagrams  $K$  and  $K'$  are virtually Markov equivalent in the strict sense, then  $Q_{N,\alpha}(K) = Q_{N,\alpha}(K')$ .)*

*Proof.* By a standard argument of state models (cf. [17, 18, 21, 22, 38]), it is directly checked that  $Q_{N,\alpha}$  does not change under each move. Details are left to the reader.  $\square$

*Remark.* The function  $Q_{N,\alpha}$  is a modification of the state model of the braid invariant  $T_S(b)$  given by V. Turaev [38].  $G(K, S)$  and  $H(K, S)$  correspond to



$\prod(f)$  and  $\int_D f$  in [38]. We changed  $\int_D f$  into  $H(K, S)$  so that the function does not change under a VI-move in Figure 12. This yields loss of invariability under RIIC-, RIID-moves, that helps us to prove Propositions 3.3 and 3.5.

*Proof of Proposition 3.3.* Let  $b_1 = \tau_1\sigma_1^{-1}\tau_2\tau_1\sigma_1\tau_2$  and  $b_2 = \tau_1\sigma_1^{-1}\sigma_2^{-1}\tau_1\sigma_1\sigma_2 \in VB_3$ . They are related by a right virtual exchange move. By a direct calculation, we have  $Q_{2,0}(b_1) = 0$  and  $Q_{2,0}(b_2) = q^{-3} - q^{-1} - q + q^3$ . Therefore, a right virtual exchange move is not a consequence of VM0-, VM1- and VM2-moves. Let  $b_3 = \sigma_2^{-1}\tau_1\sigma_2^{-1}\tau_1 \in VB_3$  and  $b_4 = \sigma_2^{-1}\sigma_1^{-1}\sigma_2^{-1}\sigma_1 \in VB_3$ . Then  $Q_{2,0}(b_3) = q^{-7} - q^{-5} - q^{-3} + 2q^{-1} + q$  and  $Q_{2,0}(b_4) = q^{-1} + q$ . Therefore, a left virtual exchange move is not a consequence of VM0-, VM1- and VM2-moves.  $\square$

*Proof of Proposition 3.5.* By a direct calculation, we have  $Q_{2,0}(\tau_1\sigma_1^{-1} \in VB_2) = 1 - q^{-2}$ ,  $Q_{2,0}(\tau_2\sigma_2^{-1}\sigma_1 \in VB_3) = -1 + q^2$ , and  $Q_{2,0}(\tau_2\sigma_2^{-1}\sigma_1^{-1} \in VB_3) = 1 + q^{-6} - 2q^{-4}$ . Therefore, we have the result.  $\square$

## 7. Welded Knots and Their Braid Presentation

In this section a virtual link diagram is referred to as a *welded link diagram*. We call the local move illustrated in the left hand side of Figure 17 a *W-move*. Two welded link diagrams are *equivalent as welded links* if they are related by a finite sequence of virtual Reidemeister moves and W-moves. The equivalence class is called a *welded link* or a *welded link type*. It is easily verified that the oriented W-move illustrated in the right of Figure 17 is sufficient to realize all possible orientations for a W-move up to oriented moves in Figure 12.

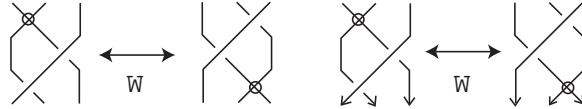

Figure 17: W-move

We refer to a virtual braid diagram as a *welded braid diagram*. Recall that the welded braid group  $WB_m$  is the quotient of  $VB_m$  by adding the relations  $\tau_i\sigma_{i+1}\sigma_i = \sigma_{i+1}\sigma_i\tau_{i+1}$  ( $i = 1, \dots, m - 2$ ) corresponding to W-moves.

**Proposition 7.1** *Every welded link type is represented by the closure of a welded braid diagram.*

*Proof.* This is a direct consequence of Proposition 3.1.  $\square$

**Theorem 7.2** *Two welded braids (or welded braid diagrams) have equivalent closures as welded links if and only if they are related by a finite sequence of the*

following moves (WM1) – (WM2) (or (WM0) – (WM2)):

- (WM0) a welded braid move (which is a move corresponding to a defining relation of the welded braid group),
- (WM1) a conjugation in the welded braid group,
- (WM2) a right stabilization of positive, negative or virtual type, and its inverse operation.

**Lemma 7.3** *A left stabilization of positive, negative or virtual type is a consequence of WM0-, WM1- and WM2-moves.*

*Proof.* If it is of virtual type, then it follows from Proposition 3.4. If it is of positive/negative type, then replace the virtual crossings of (2) in Figure 10 with real crossings so that the step (4)  $\rightarrow$  (5) is allowed in the welded braid group.  $\square$

**Lemma 7.4** *A right/left virtual exchange move is a consequence of WM0-, WM1- and WM2-moves.*

*Proof.* A right virtual exchange move is realized by WM0-, WM1- and WM2-moves as follows:

$$\begin{aligned}
b_1\sigma_m^{-1}b_2\sigma_m &= b_1\sigma_m^{-1}\tau_m\tau_m b_2\sigma_m \in WB_{m+1} \\
&\leftrightarrow b_1\sigma_m^{-1}\tau_m\tau_{m+1}\tau_m b_2\sigma_m \in WB_{m+2} \quad (\text{WM1} + \text{WM2}) \\
&= b_1\sigma_m^{-1}\tau_{m+1}\tau_m\tau_{m+1} b_2\sigma_m \in WB_{m+2} \\
&= b_1\tau_{m+1}\tau_m\sigma_{m+1}^{-1}\tau_{m+1} b_2\sigma_m \in WB_{m+2} \\
&= \tau_{m+1}b_1\tau_m b_2\sigma_{m+1}^{-1}\tau_{m+1}\sigma_m \in WB_{m+2} \\
&\leftrightarrow b_1\tau_m b_2\sigma_{m+1}^{-1}\tau_{m+1}\sigma_m\tau_{m+1} \in WB_{m+2} \quad (\text{WM1}) \\
&= b_1\tau_m b_2\sigma_{m+1}^{-1}\tau_m\sigma_{m+1}\tau_m \in WB_{m+2} \\
&= b_1\tau_m b_2\sigma_m\tau_{m+1}\sigma_m^{-1}\tau_m \in WB_{m+2} \\
&\leftrightarrow b_1\tau_m b_2\sigma_m\sigma_m^{-1}\tau_m \in WB_{m+1} \quad (\text{WM1} + \text{WM2}) \\
&= b_1\tau_m b_2\tau_m \in WB_{m+1},
\end{aligned}$$

where  $b_1, b_2 \in WB_m$  (and we also denote by  $b_i$  ( $i = 1, 2$ ) the natural images  $\iota_0^1(b_i) \in WB_{m+1}$  and  $\iota_0^2(b_i) \in WB_{m+2}$ ). Similarly, a left virtual exchange move is realized by WM0-, WM1-moves and left stabilizations. By Lemma 7.3, we have the result.  $\square$

We call a braided virtual link diagram a *braided welded link diagram*. Two braided welded link diagrams are *welded Markov equivalent* if they are related by WM0- and WM2-moves. (WM1-moves are regarded as WM0-moves.) By Lemma 7.4, if two braided welded link diagrams are virtually Markov equivalent, then they are welded Markov equivalent.

*Proof of Theorem 7.2.* The if part is obvious. We prove the only if part. Let  $K$  and  $K'$  be braided welded link diagrams which are equivalent as welded links. There is a finite sequence of welded link diagrams  $K = K_0, K_1, \dots, K_s = K'$

such that each  $K_i$  is obtained from  $K_{i-1}$  by an RIa-, RIb-, VI-, RIIa-, RIIb-, Xa-, Xb-, VIIa-, VIIb-, VIIc-, RIII-, VIII-, MI- or W-move (in Figures 12, 13 and 17). Apply the braiding process to each  $K_i$  and let  $\tilde{K}_i$  be a braided welded link diagram with the same Gauss data as  $K_i$ . By Lemma 5.2 (and Lemma 7.4),  $\tilde{K}_i$  is uniquely determined up to welded Markov equivalence. We assume that  $\tilde{K}_0 = K_0 = K$  and  $\tilde{K}_s = K_s = K'$ . It is sufficient to prove that for each  $i$  ( $i = 1, \dots, s$ ),  $\tilde{K}_i$  and  $\tilde{K}_{i-1}$  are welded Markov equivalent. In the proof of Theorem 3.2, we have already seen that  $\tilde{K}_i$  and  $\tilde{K}_{i-1}$  are welded Markov equivalent, except the case that  $K_i$  is obtained from  $K_{i-1}$  by a W-move. Suppose that  $K_i$  is obtained from  $K_{i-1}$  by a W-move. Let  $\Delta$  be a 2-disk in  $\mathbf{R}^2$  where the W-move is applied, and let  $\Delta^c$  be the complement of  $\Delta$  so that  $K_i \cap \Delta^c = K_{i-1} \cap \Delta^c$ . Deform  $K_i$  and  $K_{i-1}$  by an isotopy of  $\mathbf{R}^2$  such that  $K_i \cap \Delta$  and  $K_{i-1} \cap \Delta$  satisfy the condition of a braided virtual (welded) link diagram. Apply the braiding process to the remainder  $K_i \cap \Delta^c = K_{i-1} \cap \Delta^c$ , and we have braided welded link diagrams, say  $\tilde{K}'_i$  and  $\tilde{K}'_{i-1}$  such that  $\tilde{K}'_i \cap \Delta = K_i \cap \Delta$ ,  $\tilde{K}'_{i-1} \cap \Delta = K_{i-1} \cap \Delta$ , and  $\tilde{K}'_i \cap \Delta^c = \tilde{K}'_{i-1} \cap \Delta^c$ .  $\tilde{K}'_i$  and  $\tilde{K}'_{i-1}$  are related by a WM0-move corresponding to  $\tau_k \sigma_{k+1} \sigma_k = \sigma_{k+1} \sigma_k \tau_{k+1}$ . Since  $\tilde{K}'_i$  has the same Gauss data as  $K_i$ , it is welded Markov equivalent to  $\tilde{K}_i$ . Similarly  $\tilde{K}'_{i-1}$  is welded Markov equivalent to  $\tilde{K}_{i-1}$ . Therefore  $\tilde{K}_i$  and  $\tilde{K}_{i-1}$  are welded Markov equivalent.  $\square$

*Remark.* (1) S. Satoh [31] showed that welded links are related with ribbon surfaces in 4-space whose components are tori. From the point of view of [31], welded braids are related with the motion group of a trivial link in 3-space (cf. [14, 15, 28]).

(2) When we use a move illustrated in Figure 18, called a  $W^*$ -move, instead of a W-move, we have another notion which is similar to a welded link. Define a group  $WB_m^*$  by the quotient of  $VB_m$  by the relations  $\tau_i \sigma_{i+1}^{-1} \sigma_i^{-1} = \sigma_{i+1}^{-1} \sigma_i^{-1} \tau_{i+1}$  ( $i = 1, \dots, m-2$ ), instead of  $\tau_i \sigma_{i+1} \sigma_i = \sigma_{i+1} \sigma_i \tau_{i+1}$ . Then we have results similar to those in this section. It should be noticed that we cannot use both of W-moves and  $W^*$ -moves simultaneously. If we use both moves, every virtual (or welded) knot diagram changes into the unknot, [16, 20, 30].

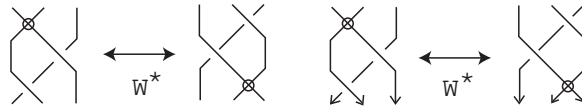

Figure 18:  $W^*$ -move

## References

- [1] J. W. Alexander, *A lemma on systems of knotted curves*, Proc. Nat. Acad. Sci. USA **9** (1923), 93–95.
- [2] E. Artin, *Theory of braids*, Ann. of Math. **48** (1947), 101–126.
- [3] J. S. Birman, “Braids, links, and mapping class groups”, Ann. Math. Studies **82** (1974), Princeton Univ. Press, Princeton, N.J..
- [4] J. S. Birman, *Studying links via closed braids*, Lecture Notes on the Ninth KAIST Mathematical Workshop **1** (1994), 1–67.
- [5] J. S. Birman and W. Menasco, *Studying links via closed braids IV: Composite links and split links*, Invent. Math. **102** (1990), 115–139.
- [6] J. S. Birman and W. Menasco, *Studying links via closed braids II: On a theorem of Bennequin*, Topology Appl. **40** (1991), 71–82.
- [7] J. S. Birman and W. Menasco, *Studying links via closed braids I: A finiteness theorem*, Pacific J. Math. **154** (1992), 17–36.
- [8] J. S. Birman and W. Menasco, *Studying links via closed braids V: The unlink*, Trans. Amer. Math. Soc. **329** (1992), 585–606.
- [9] J. S. Birman and W. Menasco, *Studying links via closed braids VI: A non-finiteness theorem*, Pacific J. Math. **156** (1992), 265–285.
- [10] J. S. Birman and W. Menasco, *Studying links via closed braids III: Classifying links which are closed 3-braids*, Pacific J. Math. **161** (1993), 25–113.
- [11] J. S. Carter, *Closed curves that never extend to proper maps of disks*, Proc. Amer. Math. Soc. **113** (1991), 879–888.
- [12] J. S. Carter, D. Jelsovsky, S. Kamada and M. Saito, *Quandle homology groups, their Betti numbers, and virtual knots*, J. Pure Appl. Algebra, to appear (math.GT/9909161).
- [13] R. Fenn, R. Rimányi, C. Rourke, *The braid-permutation group*, Topology **36** (1997), 123–135.
- [14] D. L. Goldsmith, *The theory of motion groups*, Michigan Math. J. **28** (1981), 3–17.
- [15] D. L. Goldsmith, *Motion of links in the 3-sphere*, Math. Scand. **50** (1982), 167–205.
- [16] M. Goussarov, M. Polyak and O. Viro, *Finite type invariants of classical and virtual knots*, preprint (math.GT/98100073).

- [17] F. Jaeger, *Composition products and models for the homfly polynomial*, Enseign. Math. **35** (1989), 323–361.
- [18] F. Jaeger, L. H. Kauffman and H. Saleur, *The Conway polynomial in  $R^3$  and in thickened surfaces: A new determinant formulation*, J. Combin. Theory Ser. B **61** (1994), 237–259.
- [19] N. Kamada and S. Kamada, *Abstract link diagrams and virtual knots*, J. Knot Theory Ramifications **9** (2000), 93–106.
- [20] T. Kanenobu, *Forbidden moves unknot a virtual knot*, preprint.
- [21] L. H. Kauffman, *State models for link polynomials*, Enseign. Math. **36** (1990), 1–37.
- [22] L. H. Kauffman, “Knots and physics”, Series on Knots and Everything, **1** (1991) World Scientific Publ.
- [23] L. H. Kauffman, *Virtual knots*, talks at MSRI Meeting in January 1997 and AMS Meeting at University of Maryland, College Park in March 1997.
- [24] L. H. Kauffman, *Virtual Knot Theory*, European J. Combin **20** (1999), 663–690.
- [25] L. H. Kauffman, *Virtual Knot Theory*, a talk at AMS Meeting, Washington D.C. in January 2000.
- [26] D. A. Krebes, D. S. Silver and S. G. Williams, *Persistent invariants of tangles*, J. Knot Theory Ramifications **9** (2000), 471–474.
- [27] A. A. Markov, *Über die freie Äquivalenz der geschlossener Zöpfe*, Rec. Soc. Math. Moscou **1** (1935), 73–78.
- [28] Y. Marumoto, Y. Uchida, and T. Yasuda, *Motions of trivial links and its ribbon knots*, Michigan Math. J. **42** (1995), 463–477.
- [29] H. R. Morton, *Threading knot diagrams*, Math. Proc. Cambridge Philos. Soc. **99** (1986), 247–260.
- [30] S. Nelson, *Unknotting virtual knots with Gauss diagram forbidden moves*, preprint (math.GT/0007015).
- [31] S. Satoh, *Virtual knot presentation of ribbon torus-knots*, J. Knot Theory Ramifications **9** (2000) 531–542.
- [32] J. Sawollek, *On Alexander-Conway polynomials for virtual knots and links*, preprint (math.GT/9912173).
- [33] D. S. Silver and S. G. Williams, *Virtual tangles and a theorem of Krebes*, J. Knot Theory Ramifications **8** (1999), 941–945.

- [34] D. S. Silver and S. G. Williams, *Virtual knot groups*, preprint.
- [35] D. S. Silver and S. G. Williams, *Alexander groups and virtual links*, preprint.
- [36] R. K. Skora, *Closed braids in 3-manifolds*, Math. Z. **211** (1992), 173-187.
- [37] P. Traczyk, *A new proof of Markov's braid theorem*, in "Knot theory" (Warsaw, 1995), Banach Center Publ., 42, Polish Acad. Sci., Warsaw (1998), 409-419.
- [38] V. G. Turaev, *The Yang-Baxter equation and invariants of links*, Invent. Math. **92** (1988), 527-553.
- [39] P. Vogel, *Representation of links by braids: A new algorithm*, Comment. Math. Helv. **65** (1990), 104-113.
- [40] S. Yamada, *The minimal number of Seifert circles equals the braid index of a link*, Invent. Math. **89** (1987), 347-356.

*Address:* Department of Mathematics, Osaka City University, Sumiyoshi-ku, Osaka 558-8585, Japan

*Current address* (until September 30, 2000): Department of Mathematics and Statistics, University of South Alabama, Mobile, AL 36688, USA