

ON THE KAUFFMAN SKEIN MODULES

JIANYUAN K. ZHONG AND BIN LU

ABSTRACT. Let k be a subring of the field of rational functions in α, s which contains $\alpha^{\pm 1}, s^{\pm 1}$. Let M be a compact oriented 3-manifold, and let $K(M)$ denote the Kauffman skein module of M over k . Then $K(M)$ is the free k -module generated by isotopy classes of framed links in M modulo the Kauffman skein relations. In the case of $k = \mathbb{Q}(\alpha, s)$, the field of rational functions in α, s , we give a basis for the Kauffman skein module of the solid torus and a basis for the relative Kauffman skein module of the solid torus with two points on the boundary. We then show that $K(S^1 \times S^2)$ is generated by the empty link, i.e., $K(S^1 \times S^2) \cong k$.

1. INTRODUCTION

In a previous paper [4], Gilmer and the first author investigate the Homflypt skein module of $S^1 \times S^2$. Here we follow similar approaches in studying the Kauffman skein modules. The Homflypt skein and Kauffman skein are closely related. The relative Homflypt skein module of a cylinder with $2n$ framed points (n input points and n output points) is a geometric realization of the n th Hecke algebra H_n of type A, and the relative Kauffman skein module of a cylinder with $2n$ points is a geometric realization of the Birman-Murakami-Wenzl algebra K_n . Over $\mathbb{Q}(\alpha, s)$, the field of rational functions in α, s , Beliakava and Blanchet [2] have given a canonical projection $\pi_n : K_n \rightarrow H_n$ and a multiplicative homomorphism $s_n : H_n \rightarrow K_n$. Their work reveals close connection between H_n and K_n . Our work on Kauffman skein modules is motivated by Gilmer and Zhong's previous work [4] on Homflypt skein modules and Beliakava and Blanchet's work on the Birman-Murakami-Wenzl algebra K_n [2].

Let k be an integral domain containing the invertible elements α and s . We assume that $s - s^{-1}$ is invertible in k .

Date: July 25, 2001.

Key words and phrases. Kauffman skein modules, Homflypt skein modules, relative Kauffman skein modules.

By a *framed oriented link* we mean a link equipped with a string orientation together with a nonzero normal vector field up to homotopy. By a *framed link* we mean an unoriented framed link. The links described by figures in this paper will be assigned the vertical framing which points towards the reader.

Let M be a smooth, compact and oriented 3-manifold.

Definition 1. The Homflypt skein module of M , denoted by $S(M)$, is the k -module freely generated by isotopy classes of framed oriented links in M including the empty link modulo the Homflypt skein relations given in the following figure:

$$\begin{aligned} \begin{array}{c} \diagdown \\ \diagup \end{array} - \begin{array}{c} \diagup \\ \diagdown \end{array} &= (s - s^{-1}) \begin{array}{c} \diagdown \\ \diagup \end{array} \begin{array}{c} \diagup \\ \diagdown \end{array}, \\ \begin{array}{c} \diagdown \\ \diagup \end{array} \begin{array}{c} \diagup \\ \diagdown \end{array} &= \alpha \begin{array}{c} \diagdown \\ \diagup \end{array}, \\ L \sqcup \begin{array}{c} \circlearrowleft \end{array} &= \frac{\alpha - \alpha^{-1}}{s - s^{-1}} L. \end{aligned}$$

The last relation follows from the first two if L is nonempty.

Remark: The definition here with variables α , s is a version of the original definition with three variables x , v and s in [4] by taking $x = 1$, $v = \alpha^{-1}$ and using the same s . The previous results on Homflypt skein modules will be carried over under this specialization.

Definition 2. The relative Homflypt skein module.

Let $X = \{x_1, x_2, \dots, x_n\}$ be a finite set of framed points oriented negatively (called *input points*) in the boundary ∂M , and let $Y = \{y_1, y_2, \dots, y_n\}$ be a finite set of framed points oriented positively (called *output points*) in ∂M . Define the relative skein module $S(M, X, Y)$ to be the k -module generated by relative framed oriented links in $(M, \partial M)$ such that $L \cap \partial M = \partial L = \{x_i, y_i\}$ with the induced framing and orientation, considered up to an ambient isotopy fixing ∂M , and quotiented by the Homflypt skein relations.

In the cylinder $D^2 \times I$, let X_n be a set of n distinct input framed points on a diameter $D^2 \times \{1\}$ and Y_n be a set of n distinct output framed points on a diameter $D^2 \times \{0\}$, it is a well-known result [1] that the relative Homflypt skein module $K(D^2 \times I, X_n \amalg Y_n)$ is isomorphic to the n th Hecke algebra H_n , which is the quotient of the braid group algebra $k[B_n]$ by the Homflypt skein relations. In section 4, we will also use the work by Gilmer and Zhong [4] on $S(S^1 \times D^2, A, B)$, which is the relative Homflypt skein module of the solid torus with A an input point and B an output point on the boundary of $S^1 \times D^2$.

Definition 3. The Kauffman skein module of M , denoted by $K(M)$, is the k -module freely generated by isotopy classes of framed links in M including the empty link modulo the Kauffman skein relations given in the following figure:

$$\begin{aligned} \begin{array}{c} \diagdown \\ \diagup \end{array} - \begin{array}{c} \diagup \\ \diagdown \end{array} &= (s - s^{-1}) \left(\begin{array}{c} \diagdown \\ \diagdown \end{array} \right) \left(- \begin{array}{c} \diagup \\ \diagup \end{array} \right) , \\ \text{link} &= \alpha \text{ / } , \\ L \sqcup \bigcirc &= \left(\frac{\alpha - \alpha^{-1}}{s - s^{-1}} + 1 \right) L . \end{aligned}$$

The last relation follows from the first two when L is nonempty.

Similarly, we give the definition of the relative Kauffman skein module as the following.

Definition 4. The relative Kauffman skein module.

Let $X = \{x_1, x_2, \dots, x_n, y_1, y_2, \dots, y_n\}$ be a finite set of $2n$ framed points in the boundary ∂M . Define the relative skein module $K(M, X)$ to be the k -module generated by relative framed links in $(M, \partial M)$ such that $L \cap \partial M = \partial L = \{x_i, y_i\}$ with the induced framing, considered up to an ambient isotopy fixing ∂M modulo the Kauffman skein relations.

In particular, we will study the relative Kauffman skein module of the solid torus with two points A and B on the boundary. By a slight abuse of notation, we denote this module by $K(S^1 \times D^2, AB)$. Note that $K(S^1 \times D^2, AB) \cong K(S^1 \times D^2, BA)$ as framed links are not oriented.

We state our main results as the following three theorems.

Theorem 1. When $k = \mathbb{Q}(\alpha, s)$, $K(S^1 \times D^2, AB)$ has a countable infinite basis given by the collection of elements of $\{Q'_{\lambda,c}, Q''_{\lambda,c}\}$, where λ varies over all nonempty Young diagrams and c varies over all extreme cells of λ ,

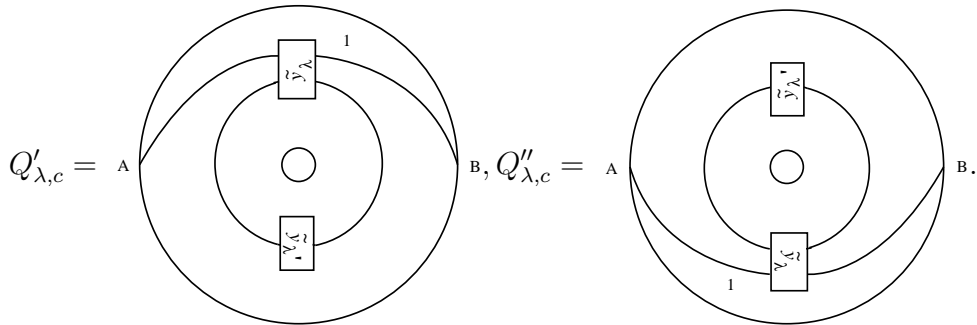

Here the Young diagram λ' is obtained from the Young diagram λ by removing the extreme cell c . An *extreme cell* is a cell such that if we remove it, we obtain a legitimate Young diagram. We draw one single string in the picture to indicate many parallel strings as to be understood in the context. A box labelled by y_λ represents a certain linear combination of braid diagrams associated to λ [1] [3]. Here the box labelled by \tilde{y}_λ is a homomorphic image of y_λ , which will be defined in section 2.

Theorem 2. *When $k = \mathbb{Q}(\alpha, s)$, the collection of all the elements $\{\widehat{y}_\lambda : \lambda \text{ is any Young diagram}\}$ forms a basis for the Kauffman skein module of the solid torus $S^1 \times D^2$, which is denoted by $K(S^1 \times D^2)$,*

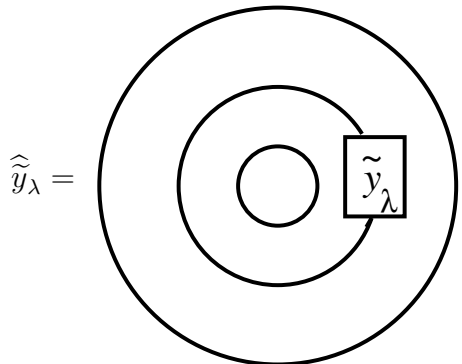

Theorem 3. *When $k = \mathbb{Q}(\alpha, s)$, $K(S^1 \times S^2)$ is generated by the empty link, i.e., $K(S^1 \times S^2) = \langle \phi \rangle$.*

In section 2, we summarize the work of Beliakava and Blanchet [2] on the Birman-Murakami-Wenzl category and the Birman-Murakami-Wenzl algebra K_n . In section 3 we compute $K(S^1 \times D^2)$ and prove Theorem 2. In section 4, we study the relative Kauffman skein module $K(S^1 \times D^2, AB)$ and prove Theorem 1. We use $K(S^1 \times D^2, AB)$ to compute $K(S^1 \times S^2)$ and prove Theorem 3 in section 5.

2. THE BIRMAN-MURAKAMI-WENZL CATEGORY AND THE BIRMAN-MURAKAMI-WENZL ALGEBRA K_n

This section is mainly a summary of the related work of Beliakova and Blanchet. Details, further references to the origin of some of these ideas, and related results of others can be found in [2]. We provide some figures to illustrate the ideas.

2.1. The Birman-Murakami-Wenzl category and the Birman-Murakami-Wenzl algebra K_n . *The Birman-Murakami-Wenzl category K is defined as: an object in K is a disc D^2 equipped with a finite*

set of points and a nonzero vector at each point; if $\beta = (D^2, l_0)$ and $\gamma = (D^2, l_1)$ are objects, the module $Hom_K(\beta, \gamma)$ is $K(D^2 \times [0, 1], l_0 \times 0 \amalg l_1 \times 1)$. For a Young diagram λ , we denote by \square_λ the object of the category K formed with one point for each cell of λ . We will use the notation $K(\beta, \gamma)$ for $Hom_K(\beta, \gamma)$. For composition of f and g , it's done by stacking f on the top of g .

$$K(\beta, \gamma) \times K(\gamma, \delta) \rightarrow K(\beta, \delta),$$

$$(f, g) \rightarrow fg.$$

Note that Beliakova and Blanchet choose to stack the second one on the top of the first. Here we follow the convention as in [4] [1].

As a special case, in the cylinder $D^2 \times I$, let X_n be a set of n distinct framed points on a diameter $D^2 \times \{1\}$ and Y_n be a set of n distinct framed points on a diameter $D^2 \times \{0\}$, then the relative Kauffman skein module $K(D^2 \times I, X_n \amalg Y_n)$ is isomorphic to the *Birman-Murakami-Wenzl algebra* K_n , which is the quotient of the braid group algebra $k[B_n]$ by the Kauffman skein relations.

The Birman-Murakami-Wenzl algebra K_n is generated by the identity $\mathbf{1}_n$, positive transpositions e_1, e_2, \dots, e_{n-1} and hooks h_1, h_2, \dots, h_{n-1} as the following:

$$e_i = \left| \cdots \right| \begin{array}{c} i \quad i+1 \\ \diagdown \quad \diagup \\ \diagup \quad \diagdown \end{array} \left| \cdots \right|$$

$$h_i = \left| \cdots \right| \begin{array}{c} i \quad i+1 \\ \frown \\ \smile \end{array} \left| \cdots \right|$$

for $1 \leq i \leq n-1$.

Then K_n is the braid group algebra $k[B_n]$ quotient by the following relations:

$$\begin{aligned} (B_1) \quad & e_i e_{i+1} e_i = e_{i+1} e_i e_{i+1}, \\ (B_2) \quad & e_i e_j = e_j e_i, \quad |i-j| \geq 2, \\ (R_1) \quad & h_i e_i = \alpha^{-1} h_i, \\ (R_2) \quad & h_i e_{i-1}^{\pm 1} h_i = \alpha^{\pm 1} h_i, \\ (K) \quad & e_i - e_i^{-1} = (s - s^{-1})(\mathbf{1}_n - h_i). \end{aligned}$$

The quotient of K_n by the ideal I_n generated by h_{n-1} is isomorphic to the n th Hecke algebra H_n . Note that $I_n = \{(a \otimes \mathbf{1}_1) h_{n-1} (b \otimes \mathbf{1}_1) : a, b \in K_{n-1}\}$. We denote the canonical projection map by π_n :

$$\pi_n : K_n \rightarrow H_n.$$

Theorem 4. *There exists a multiplicative homomorphism $s_n : H_n \rightarrow K_n$, such that*

$$\begin{aligned} \pi_n \circ s_n &= id_{H_n}, \\ s_n(x)y &= ys_n(x) = 0, \quad \forall x \in H_n, \forall y \in I_n. \end{aligned}$$

See details of the proof in [2].

Corollary 1. $K_n \cong H_n \oplus I_n$.

2.2. A basis for the Birman-Murakami-Wenzl algebra K_n . A sequence $\Lambda = (\Lambda_1, \dots, \Lambda_n)$ of Young diagrams will be called an up and down tableau of length n and shape Λ_n if two consecutive Young diagrams Λ_i and Λ_{i+1} differ by exactly one cell. We observe that in an up and down tableau $\Lambda = (\Lambda_1, \dots, \Lambda_n)$ of length n , the size of Λ_n is either n or less than n by an even number.

For an up and down tableau Λ of length n , we denote by Λ' the tableau of length $n - 1$ obtained by removing the last Young diagram in the sequence Λ . We define $a_\Lambda \in K(n, \square_\Lambda)$ and $b_\Lambda \in K(\square_\Lambda, n)$ by

$$a_1 = b_1 = \mathbf{1}_1.$$

If $|\Lambda_n| = |\Lambda_{n-1}| + 1$, then

$$\begin{aligned} a_\Lambda &= (a_{\Lambda'} \otimes \mathbf{1}_1) \tilde{y}_{\Lambda_n}, \\ b_\Lambda &= \tilde{y}_{\Lambda_n} (b_{\Lambda'} \otimes \mathbf{1}_1); \end{aligned}$$

if $|\Lambda_n| = |\Lambda_{n-1}| - 1$, then

$$\begin{aligned} a_\Lambda &= \frac{\langle \Lambda_n \rangle}{\langle \Lambda_{n-1} \rangle} (a_{\Lambda'} \otimes \mathbf{1}_1) (\tilde{y}_{\Lambda_n} \otimes \cup), \\ b_\Lambda &= (\tilde{y}_{\Lambda_n} \otimes \cap) (b_{\Lambda'} \otimes \mathbf{1}_1). \end{aligned}$$

Here $\langle \lambda \rangle$ is the quantum dimension [?] associated with λ , which is the Kauffman polynomial of \hat{y}_λ in S^3 . $\langle \lambda \rangle$ is invertible in $\mathbb{Q}(\alpha, s)$ [2].

In each case, the figures are drawn below.

(1) If $|\Lambda_n| = |\Lambda_{n-1}| + 1$, then

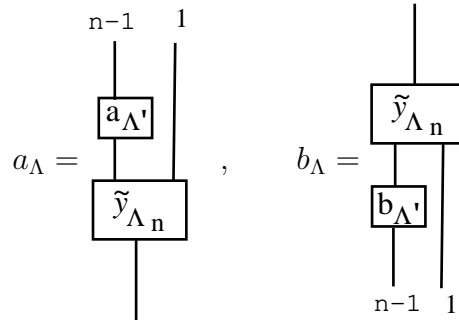

(2) If $|\Lambda_n| = |\Lambda_{n-1}| - 1$, then

$$a_\Lambda = \frac{\langle \Lambda_n \rangle}{\langle \Lambda_{n-1} \rangle} \quad , \quad b_\Lambda =$$

Theorem 5. *The family $a_\Lambda b_\Gamma$ for all up and down tableaux Λ, Γ of length n , such that $\Lambda_n = \Gamma_n$ forms a basis for K_n .*

See details of the proof in [2].

Let $\Lambda = (\Lambda_1, \dots, \Lambda_n)$, $\Gamma = (\Gamma_1, \dots, \Gamma_n)$ be two up and down tableaux of length n . If $\Lambda = \Gamma$, i.e. $\Lambda_i = \Gamma_i$ for $1 \leq i \leq n$, then $b_\Gamma a_\Lambda = \tilde{y}_{\Lambda_n}$; otherwise $b_\Lambda a_\Gamma = 0$. This follows from the corresponding properties in the Hecke category [3]. We will use these properties in the following sections.

3. THE KAUFFMAN SKEIN MODULE OF THE SOLID TORUS $S^1 \times D^2$

Let λ be a Young diagram of size n , in the Hecke category H_{\square_λ} , we have a Young idempotent y_λ , whose definition and properties are in [4, Chapter 3] [3]. Let y_λ^* be the flattened version of y_λ , then $y_\lambda^* \in H_n$. Let $\tilde{y}_\lambda = s_n(y_\lambda^*)$ in K_n .

The natural wiring of the cylinder $D^2 \times I$ into the solid torus $S^1 \times D^2$ induces a homomorphism: $K(D^2 \times I, X_n \amalg Y_n) \rightarrow K(S^1 \times D^2)$. We denote the image of K_n under the wiring by \widehat{K}_n ,

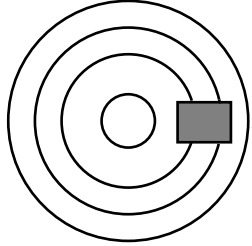

Restatement of Theorem 2. Over $\mathbb{Q}(\alpha, s)$, the field of rational functions in α, s , the collection of all the elements $\{\widehat{y}_\lambda : \lambda \text{ is any Young diagram}\}$ forms a basis for $K(S^1 \times D^2)$.

Proof. Let L be a framed link in $S^1 \times D^2$, up to a scalar multiple, L is the closure of an n -strand braid for some integer $n \geq 0$ [6][6.5 Alexander's

Braiding Theorem]; the braid modulo the Kauffman skein relations is an element in K_n . Therefore $L \in \widehat{K}_n$ in $K(S^1 \times D^2)$. This shows any element in $K(S^1 \times D^2)$ lies in $\bigcup_{n \geq 0} \widehat{K}_n$, i.e. $K(S^1 \times D^2) \subseteq \bigcup_{n \geq 0} \widehat{K}_n$, hence $K(S^1 \times D^2) = \bigcup_{n \geq 0} \widehat{K}_n$. So we need only to show that the set $\{\widehat{y}_\lambda : \lambda \text{ is a Young diagram}\}$ forms a basis for $\bigcup_{n \geq 0} \widehat{K}_n$.

(1) We first prove that $\widehat{K}_n \subseteq K(S^1 \times D^2)$ has a basis given by the collection $\{\widehat{y}_{\Lambda_n} : |\Lambda_n| \text{ is either } n \text{ or less than } n \text{ by an even number}\}$. It follows that the set $\{\widetilde{y}_\lambda : 0 \leq |\lambda| \leq n\}$ forms a basis for $\bigcup_{0 \leq i \leq n} \widehat{K}_i$.

By Theorem 5 in the previous section, K_n has a basis given by the family $a_\Lambda b_\Gamma$, so \widehat{K}_n is generated by the family $\widehat{a_\Lambda b_\Gamma}$. Since $\widehat{a_\Lambda b_\Gamma} = \widehat{b_\Gamma a_\Lambda} = \delta_{\Lambda\Gamma} \widehat{b_\Lambda a_\Lambda} = \delta_{\Lambda\Gamma} \widehat{y}_{\Lambda_n}$, where Λ_n is a Young diagram of size either n or less than n by an even number. so \widehat{K}_n is generated by the collection $\{\widehat{y}_{\Lambda_n} : |\Lambda_n| \text{ is either } n \text{ or less than } n \text{ by an even number}\}$.

Now we want to prove the above generating set is linearly independent. We show this by comparing the dimension.

From Corollary 1, we have $K_n \cong H_n \oplus I_n$, so $\widehat{K}_n \cong \widehat{H}_n + \widehat{I}_n$. Recall that $I_n = \{(a \otimes \mathbf{1}_1)h_{n-1}(b \otimes \mathbf{1}_1) : a, b \in K_{n-1}\}$. A typical element in \widehat{I}_n looks like the following:

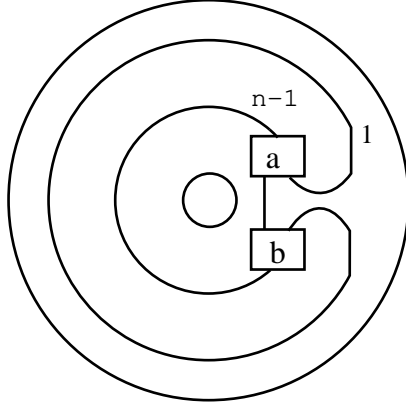

where $a, b \in K_{n-1}$. We can see that the above element is in \widehat{K}_{n-2} . On the other hand, we observe that $\widehat{K}_{n-2} \subseteq \widehat{I}_n$, therefore $\widehat{I}_n = \widehat{K}_{n-2}$. i.e. $\widehat{K}_n \cong \widehat{H}_n + \widehat{K}_{n-2}$.

Repeating the process for \widehat{K}_{n-2} , we conclude that

$$\widehat{K}_n \cong \begin{cases} \widehat{H}_1 + \widehat{H}_3 + \cdots + \widehat{H}_n, & \text{if } n \text{ is odd;} \\ \langle \phi \rangle + \widehat{H}_2 + \widehat{H}_4 + \cdots + \widehat{H}_n, & \text{if } n \text{ is even;} \end{cases}$$

where ϕ denotes the empty link.

Since $\widehat{H}_i \cap \widehat{H}_j = 0$ whenever $i \neq j$ in the Homflypt skein module of the solid torus, (note $\widehat{H}_n = C_n$ in $S(S^1 \times D^2)$ [4]), the above decomposition is a direct sum.

$$\widehat{K}_n \cong \begin{cases} \widehat{H}_1 \oplus \widehat{H}_3 \oplus \cdots \oplus \widehat{H}_n, & \text{if } n \text{ is odd;} \\ \langle \phi \rangle \oplus \widehat{H}_2 \oplus \widehat{H}_4 \oplus \cdots \oplus \widehat{H}_n, & \text{if } n \text{ is even.} \end{cases}$$

Therefore we have the following equality for the dimensions.

$$\dim(\widehat{K}_n) = \begin{cases} \dim(\widehat{H}_1) + \dim(\widehat{H}_3) + \cdots + \dim(\widehat{H}_n), & \text{if } n \text{ is odd;} \\ 1 + \dim(\widehat{H}_2) + \dim(\widehat{H}_4) + \cdots + \dim(\widehat{H}_n), & \text{if } n \text{ is even.} \end{cases}$$

As we know from [1] that the dimension of $\widehat{H}_n = C_n$ in $S(S^1 \times D^2)$ is equal to the number of Young diagrams of size n . Therefore the number of generators in the set $\{\tilde{y}_{\Lambda_n} : |\Lambda_n| \text{ is either } n \text{ or less than } n \text{ by an even number}\}$ is equal to the dimension of \widehat{K}_n , therefore it forms a basis for \widehat{K}_n .

(2) The collection of all the elements $\{\widehat{y}_\lambda : \lambda \text{ is any Young diagram}\}$ forms a basis for $K(S^1 \times D^2)$. As we have $K(S^1 \times D^2) = \bigcup_{n \geq 0} \widehat{K}_n$. The result follows by induction on m for $\bigcup_{0 \leq n \leq m} \widehat{K}_n$. \square

4. THE RELATIVE KAUFFMAN SKEIN MODULE $K(S^1 \times D^2, AB)$

Restatement of Theorem 1. When $k = \mathbb{Q}(\alpha, s)$, $K(S^1 \times D^2, AB)$ has a countable infinite basis given by the collection of elements of $\{Q'_{\lambda,c}, Q''_{\lambda,c}\}$, where λ varies over all nonempty Young diagrams and c varies over all extreme cells of λ .

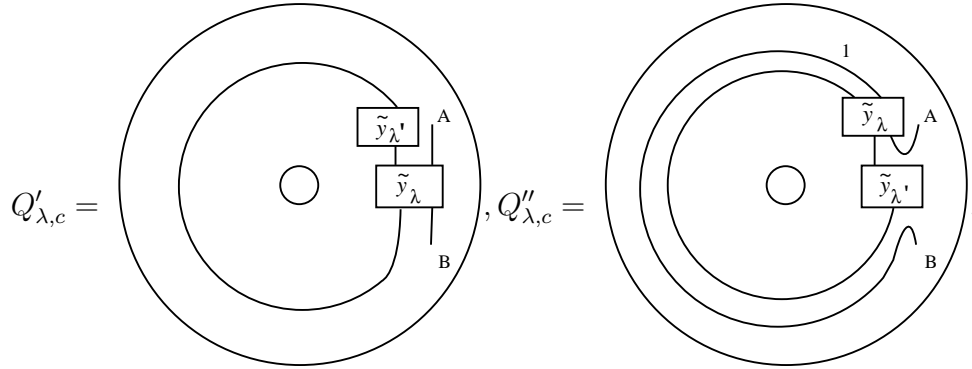

Here we change the figures of $Q'_{\lambda,c}, Q''_{\lambda,c}$ through an obvious homeomorphism of $S^1 \times D^2$.

Proof. (1) $K(S^1 \times D^2, AB)$ is generated by the collection $\{Q'_{\lambda,c}, Q''_{\lambda,c}\}$.

As we know, $K(S^1 \times D^2, AB)$ is generated by isotopy classes of framed links in $S^1 \times D^2$ with boundary the two points A and B . Such links consist of a collection of framed closed curves and a framed arc joining the two points A and B . Each framed link in $S^1 \times D^2$ with boundary A and B is isotopic to one of the two wiring images of an n -strand braid for some $n \geq 1$, which depends on the two ways the last end points of the top and bottom braid related to A and B . The two types of wirings of the braid group B_n into $K(S^1 \times D^2, AB)$ are given by the following:

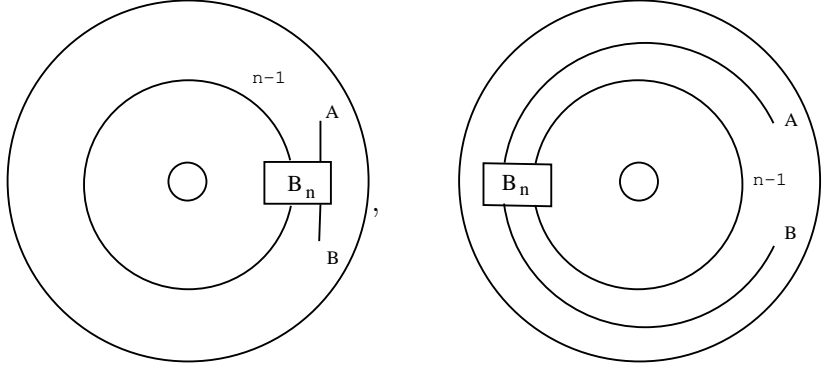

By modulo over the Kauffman skein relations, these elements are linear combinations of elements in the wiring image of

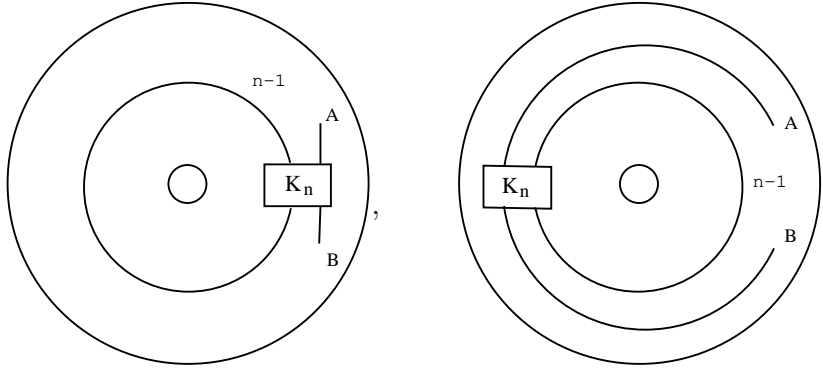

We call the wiring on the left as the first wiring and the wiring on the right as the second wiring. We denote the images of K_n under the first and second wirings by \widetilde{K}_n and \overline{K}_n , respectively. It is easy to see that $\widetilde{K}_n = \overline{K}_n$, since $K(S^1 \times D^2, AB) = K(S^1 \times D^2, BA)$, which can be seen by arranging the points A and B symmetrically on the boundary of $S^1 \times D^2$. Therefore it is sufficient to consider one of the wiring image. (We will choose the first wiring for convenience.)

In section 2 Theorem 5, K_n has a basis given by the $a_\Lambda b_\Gamma$ s, therefore the image of any element of K_n under the first wiring is a linear combination of the wiring images of $a_\Lambda b_\Gamma$ s given by the following diagrams according to the two cases that Λ_n related to Λ_{n-1} ($|\Lambda_{n-1}| = |\Lambda_n| \pm 1$).

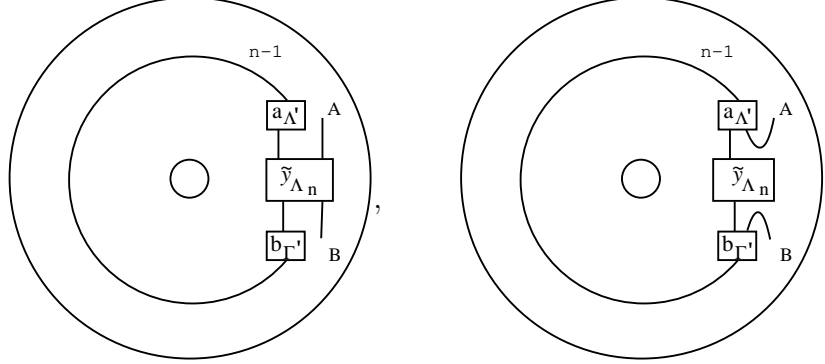

Since $b_{\Gamma'} a_{\Lambda'} = 0$ whenever $\Gamma' \neq \Lambda'$, by induction, in the linear combination, the only nonzero elements are the $b_\Gamma a_\Lambda$ s with $\Gamma = \Lambda$, i.e. $\Gamma_i = \Lambda_i$. Therefore the linear combination will contain only elements as:

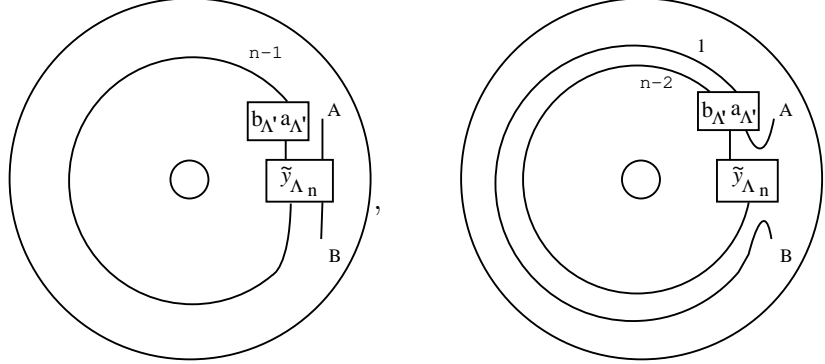

Since $b_{\Lambda'} a_{\Lambda'} = \tilde{y}_{\Lambda_{n-1}}$, and $|\Lambda_{n-1}| = |\Lambda_n| \pm 1$, we introduce $\lambda = \Lambda_n$ and $\lambda' = \Lambda_{n-1}$ if $|\Lambda_{n-1}| = |\Lambda_n| - 1$, and introduce $\lambda = \Lambda_{n-1}$ and $\lambda' = \Lambda_n$ if $|\Lambda_{n-1}| = |\Lambda_n| + 1$; therefore the generators have the forms

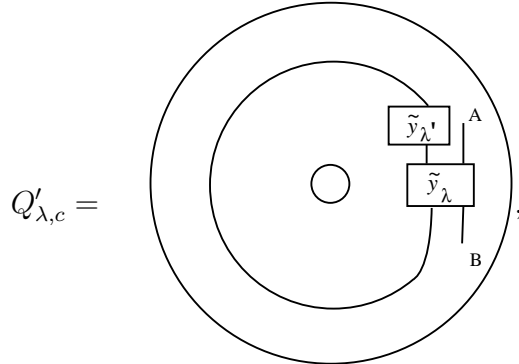

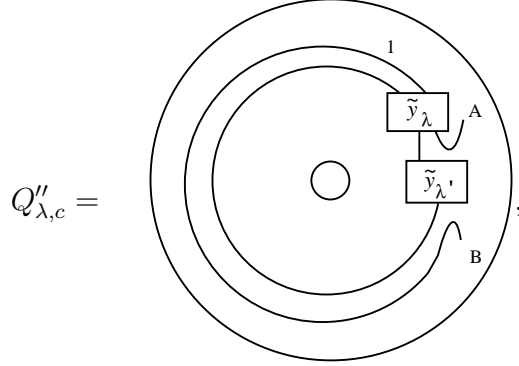

where λ' is a Young diagram obtained from λ by deleting an extreme cell. We conclude that \widetilde{K}_n is generated by the set $\{Q'_{\lambda,c}, Q''_{\mu,c}\}$ where $|\lambda| \geq 1$, $|\mu| \geq 1$ and $|\lambda|$ is equal to n or less than n by an even number and $|\mu|$ is equal to $n - 1$ or less than $n - 1$ by an even number.

As $K(S^1 \times D^2, AB) = \bigcup_{n \geq 1} \widetilde{K}_n$, the argument above shows that the given collection generates $K(S^1 \times D^2, AB)$.

(2) We now prove that the given collection of generators are linearly independent. From part (1), we observe that $\bigcup_{i=1}^n \widetilde{K}_i$ is generated by the set $\{Q'_{\lambda,c}, Q''_{\mu,c} : 1 \leq |\lambda| \leq n, 1 \leq |\mu| \leq (n - 1)\}$. We claim it is sufficient to show that the set $\{Q'_{\lambda,c}, Q''_{\mu,c} : 1 \leq |\lambda| \leq n, 1 \leq |\mu| \leq (n - 1)\}$ forms a basis for $\bigcup_{i=1}^n \widetilde{K}_i$. This is because $K(S^1 \times D^2, AB) = \bigcup_{n \geq 1} \widetilde{K}_n$ and by induction on m for $\bigcup_{1 \leq n \leq m} \widetilde{K}_n$, the result follows.

We introduce two types of wirings of \widetilde{H}_n into $S(S^1 \times D^2, A, B)$ and denote them by \widetilde{H}_n and \overline{H}_n , respectively, where $S(S^1 \times D^2, A, B)$ is the relative Homflypt skein modules of $S^1 \times D^2$ with A an input point and B an output point on the boundary [4][Chapters 2 & 4].

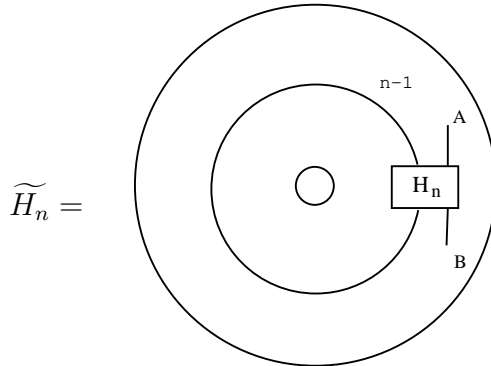

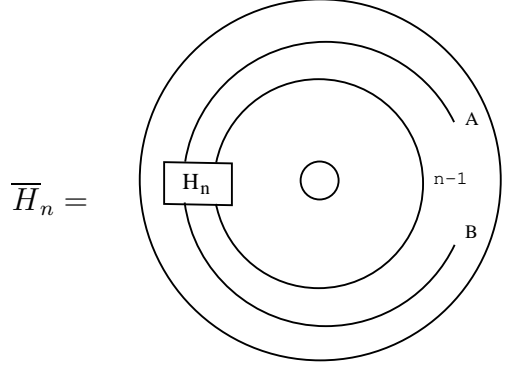

From Corollary 1 in section 2, we have $K_n \cong H_n \oplus I_n$, hence $\widetilde{K}_n \cong \widetilde{H}_n + \widetilde{I}_n$, where \widetilde{I}_n is the wiring image of I_n as a submodule of K_n . Now by a similar argument as in the proof of Theorem 1, $\widetilde{I}_n = \overline{K}_{n-1}$, therefore $\widetilde{K}_n \cong \widetilde{H}_n + \overline{K}_{n-1}$, repeating the process for \overline{K}_{n-1} , we have

$$\widetilde{K}_n \cong \widetilde{H}_n + \overline{H}_{n-1} + \cdots$$

Eventually, we have

$$\bigcup_{i=1}^n \widetilde{K}_i \cong \bigcup_{i=1}^n \widetilde{H}_i + \bigcup_{i=1}^{n-1} \overline{H}_i.$$

By the properties of \widetilde{H}_i and \overline{H}_i in the Homflypt skein module, the above is a direct sum,

$$\bigcup_{i=1}^n \widetilde{K}_i \cong \bigcup_{i=1}^n \widetilde{H}_i \oplus \bigcup_{i=1}^{n-1} \overline{H}_i.$$

Therefore, we have the following equality of the dimensions,

$$\dim\left(\bigcup_{i=1}^n \widetilde{H}_i\right) + \dim\left(\bigcup_{i=1}^{n-1} \overline{H}_i\right) = \dim\left(\bigcup_{i=1}^n \widetilde{K}_i\right)$$

Note that \widetilde{H}_i is the subspace C'_i [4, Chapter 4] in the relative Homflypt skein module $S(S^1 \times D^2, A, B)$. A basis of C'_i was given in [4,

Chapter 4] as $\{Q_{H'_{\lambda,c}} : |\lambda| = i\}$,

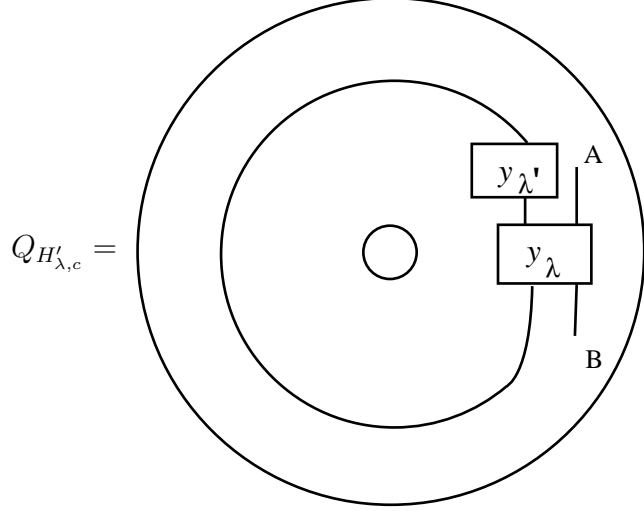

Similarly, a basis of $\overline{H}_i = C'_{-i}$ was given in [4, Chapter 4] as $\{Q_{H''_{\lambda,c}} : |\lambda| = i\}$.

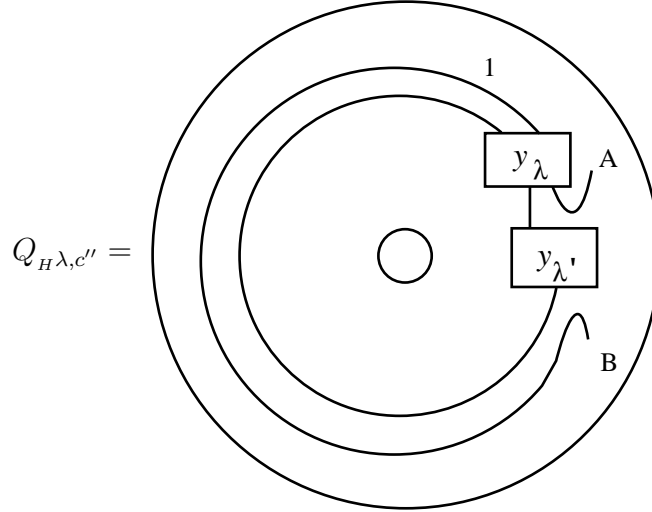

Therefore the set $\{Q_{H'_{\lambda,c}}, Q_{H''_{\mu,c}} : 1 \leq |\lambda| \leq n, 1 \leq |\mu| \leq (n-1)\}$ forms a basis for $\bigcup_{i=1}^n \widetilde{H}_i \oplus \bigcup_{i=1}^{n-1} \overline{H}_i$. Hence the cardinality of the above set is $\dim(\bigcup_{i=1}^n \widetilde{H}_i) + \dim(\bigcup_{i=1}^{n-1} \overline{H}_i)$.

On the other hand, since $\bigcup_{i=1}^n \widetilde{K}_i$ is generated by the set $\{Q'_{\lambda,c}, Q''_{\mu,c} : 1 \leq |\lambda| \leq n, 1 \leq |\mu| \leq (n-1)\}$. As this set has the same cardinality as the set $\{Q_{H'_{\lambda,c}}, Q_{H''_{\mu,c}} : 1 \leq |\lambda| \leq n, 1 \leq |\mu| \leq (n-1)\}$, with

$$\dim\left(\bigcup_{i=1}^n \widetilde{H}_i\right) + \dim\left(\bigcup_{i=1}^{n-1} \overline{H}_i\right) = \dim\left(\bigcup_{i=1}^n \widetilde{K}_i\right)$$

from above, we conclude that the set $\{Q'_{\lambda,c}, Q''_{\mu,c} : 1 \leq |\lambda| \leq n, 1 \leq |\mu| \leq (n-1)\}$ must be a basis for $\bigcup_{i=1}^n \widetilde{K}_i$. □

5. THE KAUFFMAN SKEIN MODULE $K(S^1 \times S^2)$

The space $S^1 \times S^2$ can be obtained from the solid torus $S^1 \times D^2$ by first attaching a 2-handle along the meridian γ and then attaching a 3-handle. As it is well-known, adding a 3-handle induces isomorphism between skein modules; while adding a 2-handle to $S^1 \times D^2$ adds relations to the module $K(S^1 \times D^2)$. The natural inclusion $i: S^1 \times D^2 \rightarrow S^1 \times S^2$ induces an epimorphism $i_*: K(S^1 \times D^2) \rightarrow K(S^1 \times S^2)$. Following Masbaum's work in the case of the Kauffman bracket skein module [5], we will use the following method to parametrize the relations arising from sliding over the 2-handle. Pick two points A, B on γ , which decompose γ into two intervals γ' and γ'' .

By Corollary 2 in [4, Chapter 2], we have

$$K(S^1 \times S^2) \cong K(S^1 \times D^2)/R.$$

Here $R = \{\Phi'(z) - \Phi''(z) \mid z \in K(S^1 \times D^2, AB)\}$, z is any element in the relative skein module $K(S^1 \times D^2, AB)$, and $\Phi'(z)$ and $\Phi''(z)$ are given by capping off z with γ' and γ'' , respectively, and pushing the resulting links back into $S^1 \times D^2$.

In the previous section we give a basis for the relative skein module $K(S^1 \times D^2, AB)$. We now compute $K(S^1 \times S^2)$.

Theorem 6. *The following is a complete set of relations:*

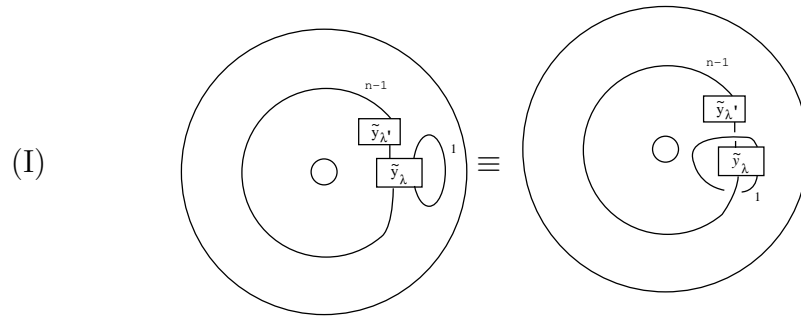

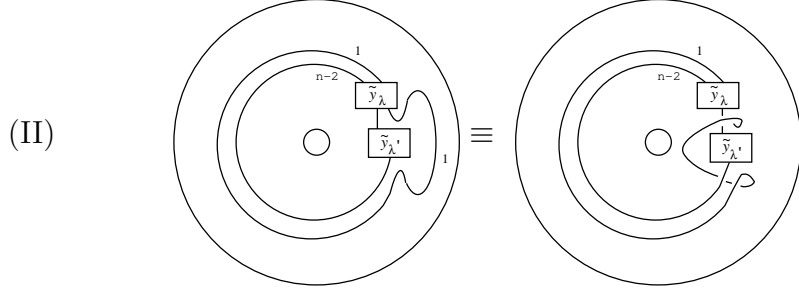

Proof. This follows from $\Phi'(z) \equiv \Phi''(z)$ by taking z to be every basis element in $K(S^1 \times D^2, AB)$, which gives a generating set for the submodule $R \subset K(S^1 \times D^2)$. \square

Restatement of Theorem 3. Over $k = \mathbb{Q}(\alpha, s)$, $K(S^1 \times S^2) = \langle \phi \rangle$.

Proof. We show that every basis element \widehat{y}_λ of $K(S^1 \times D^2)$ with λ being nonempty is 0 in $K(S^1 \times S^2)$. We will use the complete set of relations given in the previous theorem to compute R .

(1) We simplify equation (I) in Theorem 6. The left hand side is equal to a scalar multiple of $\widehat{y}_{\lambda'}$, by embedding it into S^3 , the scalar is $\frac{\langle \lambda' \rangle}{\langle \lambda \rangle}$. Here $\langle \lambda \rangle$ is the Kauffman polynomial of \widehat{y}_λ in S^3 . We can simplify the right hand side of (I) by using the following skein relation [2, Prop. 6.1]:

where $cn(c)$ is the content of the extreme cell c of λ to be removed to obtain λ' .

The right hand side of (I) is also a scalar multiple of $\widehat{y}_{\lambda'}$, by embedding it into S^3 and using the skein relation above, the scalar is equal to $s^{2cn(c)} \frac{\langle \lambda' \rangle}{\langle \lambda \rangle}$. Therefore, equation (I) gives the equivalence relation: $\frac{\langle \lambda' \rangle}{\langle \lambda \rangle} \widehat{y}_{\lambda'} \equiv s^{2cn(c)} \frac{\langle \lambda' \rangle}{\langle \lambda \rangle} \widehat{y}_{\lambda'}$, i.e. $\frac{\langle \lambda' \rangle}{\langle \lambda \rangle} (1 - s^{2cn(c)}) \widehat{y}_{\lambda'} \equiv 0$ in $K(S^1 \times S^2)$.

Since both $\frac{\langle \lambda' \rangle}{\langle \lambda \rangle}$ and $(1 - s^{2cn(c)})$ are invertible, we get $\widehat{y}_{\lambda'} \equiv 0$ in $K(S^1 \times S^2)$ when λ' is not empty.

(2) Now we simplify equation (II) in Theorem 6. The left hand side is equal to \widehat{y}_{λ} by the absorbing property. The right hand side is equal to $\alpha^{-2} s^{2cn(c)} \widehat{y}_{\lambda}$ by the skein relation above. So equation (II) gives $(1 - \alpha^{-2} s^{2cn(c)}) \widehat{y}_{\lambda} \equiv 0$, which also implies that $\widehat{y}_{\lambda} \equiv 0$ over $\mathbf{Q}(\alpha, s)$, so equation (II) gives no new information.

Therefore all $\widehat{y}_{\lambda} \equiv 0$ in $K(S^1 \times S^2)$ when λ is nonempty.

(3) As no relation involves the empty link ϕ , it survives. Therefore,

$$K(S^1 \times S^2) = \langle \phi \rangle .$$

□

REFERENCES

- [1] A. K. Aiston and H. R. Morton, *Idempotents of Hecke algebras of type A*, J. of Knot Theory and Ram. 7 No 4 (1998), 463-487.
- [2] A. Beliakava and C. Blanchet, *Skein construction of Idempotents in Birman-Murakami-Wenzl algebras*.
- [3] C. Blanchet, *Hecke algebras, modular categories and 3-manifolds quantum invariants*, Topology (39) 1 (2000), 193-223.
- [4] P. Gilmer and J. K. Zhong, *The Homflypt skein module of $S^1 \times S^2$* , Math Zeit., vol 237, pp 769-814 (2001).
- [5] G. Masbaum, *The spin refined Kauffman bracket skein module of $S^1 \times S^2$ and lens spaces*, Manuscripta Math. 91 no. 4, (1996), 495-509.
- [6] V. V. Prasolov and A. B. Sossinsky, *Knots, Links, Braids and 3-Manifolds*, American Mathematical Society, QA612.14.P73, 1997.

DEPARTMENT OF MATHEMATICS & STATISTICS, LOUISIANA TECH UNIVERSITY, RUSTON, LA 71272

E-mail address: zhong@coes.latech.edu

DEPARTMENT OF MATHEMATICS, UNIVERSITY OF ARIZONA, TUCSON, AZ 85721

E-mail address: binlu@math.arizona.edu