

# COHOMOLOGY OF $AUT(F_n)$

A Dissertation

Presented to the Faculty of the Graduate School

of Cornell University

in Partial Fulfillment of the Requirements for the Degree of

Doctor of Philosophy

by

Craig A. Jensen

August 1998

© Craig A. Jensen 1998

ALL RIGHTS RESERVED

## COHOMOLOGY OF $AUT(F_n)$

Craig A. Jensen, Ph.D.

Cornell University 1998

For odd primes  $p$ , we examine the Farrell cohomology  $\hat{H}^*(Aut(F_{2(p-1)}); \mathbb{Z}_{(p)})$  of the group of automorphisms of a free group  $F_{2(p-1)}$  on  $2(p-1)$  generators, with coefficients in the integers localized at the prime  $(p) \subset \mathbb{Z}$ . This extends results in [12] by Glover and Mislin, whose calculations yield  $\hat{H}^*(Aut(F_n); \mathbb{Z}_{(p)})$  for  $n \in \{p-1, p\}$  and is concurrent with work by Chen in [9] where he calculates  $\hat{H}^*(Aut(F_n); \mathbb{Z}_{(p)})$  for  $n \in \{p+1, p+2\}$ . The main tools used are Ken Brown's "Normalizer spectral sequence" from [7], a modification of Krstic and Vogtmann's proof of the contractibility of fixed point sets for outer space in [19], and a modification of the Degree Theorem of Hatcher and Vogtmann in [15].

Other cohomological calculations in the paper yield that  $H^5(Q_m; \mathbb{Z})$  never stabilizes as  $m \rightarrow \infty$ , where  $Q_m$  is the quotient of the spine  $X_m$  of "outer space" introduced in [15] by Hatcher and Vogtmann. This contrasts with the theorems in [15] where various stability results are shown for  $H^n(Aut(F_m); \mathbb{Z})$ ,  $H^n(Aut(F_m); \mathbb{Q})$ , and  $H^n(Q_m; \mathbb{Q})$ .

# Biographical Sketch

Born in Davis, California, in 1969, Craig has lived in Davis; Livermore, California; Malvern, Pennsylvania; Los Alamos, New Mexico; Logan, Utah; Madison, Wisconsin; and Ithaca, New York. He graduated Summa Cum Laude from Utah State University in 1992 with a B.S. in both Mathematics and Philosophy. Following this, he attended the University of Wisconsin–Madison and received an M.A. in Mathematics in 1994. His graduate education was completed by earning a Ph.D. in Mathematics from Cornell University in 1998.

Craig is an avid reader of books, and has read (perhaps to the detriment of his mathematical education!) at least three fiction books every week since he was 11 years old. His other hobbies include philosophy (in which he was sufficiently interested in as a hobby to obtain a degree), poetry (alas, he is better at reading it than writing it), games (all types), and computers (a reasonable hobby for someone in a technical discipline.) Overall, he has enjoyed his time spent obtaining a Ph.D. in Mathematics, but is glad finally to have completed this facet of his education. He looks forward to his future position as a Zassenhaus Assistant Professor at Ohio State University.

Dedicated with love to my mother

*JOANNE REID JENSEN*

for helping me and being a great friend

– and –

In loving memory of my father

*CARL A JENSEN*

wishing that we had had more time

# Acknowledgements

First, I would like to thank Karen Vogtmann, my thesis advisor, for all that she has done. This dissertation would not have been possible without her help and advice. She has done all of the things that a good thesis advisor could do, including offering advice about possible avenues of research, suggesting references where I could find information, giving encouragement where necessary, commenting on the things I have written, and sitting through hours of what must have been fairly tiresome presentations of mine. In short, Prof. Vogtmann has helped me by doing various things which are difficult, if not impossible, for a graduate student to do on his own. It has been a pleasure to know her, and I am grateful for her aid and assistance.

Second, I would like to thank the other members of my special committee, Allen Hatcher and Marshall Cohen. Professor Hatcher, who at one time was chair of my committee, was of immense help to me throughout my time at Cornell. He has frequently offered advice, suggested refinements to proofs, helped me locate articles, and also listened to a good number of presentations that I have done. Professor Cohen has been very kind and encouraging to me while I have attended Cornell. I am glad to have known him.

Next I would like to thank two other people who have helped me complete the process of obtaining a dissertation and completing graduate school, Ken Brown and Alejandro Adem. Both of them have kindly answered questions (which I seem, like clockwork, to have posed to each of them once every two months) about topics that have come up in the cohomology of groups. Their answers have contained invaluable information, such as references, summaries of topics, and guesses about how difficult or complex they felt the subjects were. Ken Brown, in particular, deserves the award for “most helpful person at Cornell who is not officially on my committee”, as he has both written letters of recommendation for me and served as a proxy member of my committee.

While attending graduate school, I have had the honor of being a Hertz Fellow and have been supported by a Hertz Fellowship. The fellowship has been of constant help for me, by allowing me to devote more time and effort to studying and researching mathematics. I would like to thank the Fannie and John Hertz Foundation for awarding me the fellowship and funding me. In particular, I would like to thank Wilson Talley and Lowell Wood for interviewing me and recommending me for the fellowship.

Although I always wanted to be some sort of scientist, it is because of my high school math teacher, Carletta Elich, that I specifically became a mathematician. In addition to posing interesting problems and ideas to me, she was genuinely kind to me as a person and concerned about my education. I am happy to call her a friend.

Finally, I would like to thank my family. My mother, Joanne, has always encouraged me to pursue the goal of earning a Ph.D. in the sciences. Throughout

the past ten years of university education, she has bestowed priceless love, support, and counsel. Although it goes without saying that I would not have finished this process without her assistance, it still needs to be said that she has consistently been there for me when I needed love and friendship the most. I would also like to thank my sister, JanLee, for being such a good friend and someone whose abilities I have always admired. Last of all, I would like to thank my brother, Doug, for all the fun times we have had and for being my best friend ever.



# Table of Contents

<b>I</b>	<b>Cohomological calculations</b>	<b>1</b>
1	The equivariant spectral sequence and the spine of “outer space”	2
2	The normalizer spectral sequence	12
3	Normalizers of $p$ -subgroups of $Aut(F_n)$	20
4	The normalizers, their fixed point sets, and related fixed point sets	41
5	The cohomology of the normalizers	54
6	Cohomology of $Aut(F_n)$	75
7	Notes about the usual cohomology of $Aut(F_{2(p-1)})$	83
8	The Farrell cohomology of $Aut(F_l)$ for $l < 2(p-1)$	87
<b>II</b>	<b>Modified degree theorem</b>	<b>90</b>
9	The modified degree theorem	91
10	Using the modified degree theorem	98
<b>III</b>	<b>Contractibility of fixed point sets</b>	<b>114</b>
11	Preliminaries	115
12	The contractibility lemmas	139

<b>IV</b>	<b>Cohomology of moduli spaces of graphs</b>	<b>157</b>
13	Symmetry groups of graphs	158
14	The integral cohomology of the quotient never stabilizes	176
15	Graphs without basepoints	182
A	On the prime $p = 3$	185
	Bibliography	190

# List of Figures

1.1	Some graphs with $p$ -symmetry . . . . .	9
9.1	Canonical splittings . . . . .	94
9.2	Some examples of codimensions concerning $\circ$ . . . . .	95
9.3	Complexity examples with $\circ$ . . . . .	97
10.1	The 2-sphere in $\tilde{Q}_{p-1,2}$ . . . . .	106
10.2	One of 6 3-simplices making up the sample cube. . . . .	108
10.3	A sample cube in $\tilde{Q}_{p-1,3}$ . . . . .	109
10.4	Graphs giving 2-simplices . . . . .	111
11.1	The Whitehead move $(\gamma, c)$ . . . . .	137
13.1	Some graphs with $D_{2p}$ -symmetry . . . . .	160
13.2	Some graphs with (cohomologically) $\Sigma_p$ -symmetry . . . . .	162
13.3	Graphs whose symmetry groups are exactly $\mathbb{Z}/p$ . . . . .	170
13.4	Some simplices with at most dihedral symmetry . . . . .	173
13.5	Simplices with exactly $\mathbb{Z}/p$ symmetry . . . . .	173
A.1	Graphs giving some 3-simplices . . . . .	188

# Preface

Let  $F_n$  denote the free group on  $n$  letters and let  $Aut(F_n)$  and  $Out(F_n)$  denote the automorphism group and outer automorphism group, respectively, of  $F_n$ . In [10] Culler and Vogtmann defined a space on which  $Out(F_n)$  acts nicely called “outer space”. By studying the action of  $Out(F_n)$  on this space, various people have been able to calculate the cohomology of  $Out(F_n)$  in specific cases. More recently, Hatcher in [14] and Hatcher and Vogtmann in [15] have defined a space on which  $Aut(F_n)$  acts nicely called “auter space” and have used this to calculate the cohomology of  $Aut(F_n)$  in specific cases.

Recall (see [20]) that  $Out(F_1) = \mathbb{Z}/2$  and  $Out(F_2) = GL_2(\mathbb{Z})$ ; in general, for all  $n \geq 1$  the map  $Out(F_n) \rightarrow GL_n(\mathbb{Z})$  has a torsion free kernel. In [6], Tom Brady calculated the integral cohomology of  $Out(F_3)$ . This remains even today the only complete (nontrivial) calculation of the integral cohomology of  $Out(F_n)$  or  $Aut(F_n)$ .

Hatcher shows in [14] that the integral cohomology of the infinite symmetric group  $\Sigma_\infty$  is a direct summand of the integral cohomology of  $Aut(F_\infty)$ . It is unknown whether or not the cohomology of  $\Sigma_\infty$  equals the cohomology of  $Aut(F_\infty)$ . In [14] he also derives quadratic stability ranges for the integral cohomology of  $Aut(F_n)$  or  $Out(F_n)$ .

A ‘‘Degree Theorem’’ is introduced by Hatcher and Vogtmann in [15] which is a very useful tool for simplifying cohomological calculations concerning  $Aut(F_n)$ . For example, they are able to derive linear stability ranges for the integral cohomology of  $Aut(F_n)$ .

Using the degree theorem and computer calculations, progress toward calculating the rational cohomology of  $Aut(F_n)$  is made by Hatcher and Vogtmann in [16] where they show that for  $1 \leq t \leq 6$  and all  $n \geq 1$ ,

$$H_t(Aut(F_n); \mathbb{Q}) = \begin{cases} \mathbb{Q} & \text{if } t = n = 4 \\ 0 & \text{otherwise} \end{cases}$$

Glover and Mislin [12] calculated the cohomology with coefficients in  $\mathbb{Z}_{(p)}$  of  $Out(F_n)$  for  $n = p - 1, p, p + 1$ . In addition, Chen [8] calculates the integral cohomology of  $Out(F_n)$  for  $n = p + 2$  and  $Aut(F_n)$  for  $n = p + 1, p + 2$ . In each of the above cases, the maximal  $p$ -subgroups of  $Out(F_n)$  or  $Aut(F_n)$  had  $p$ -rank one. The case of  $Aut(F_{2(p-1)})$  is the first one where the maximal  $p$ -subgroups can have a higher  $p$ -rank, and it is this case which we calculate here.

In this paper we show that for odd primes  $p$ , and  $n = 2(p-1)$ , that  $\hat{H}^t(Aut(F_n); \mathbb{Z}_{(p)})$

$$\cong \begin{cases} \mathbb{Z}/p^2 \oplus p(\mathbb{Z}/p) & t = 0 \\ (p + [\frac{3k}{2}] - 1)\mathbb{Z}/p & |t| = kn \neq 0 \\ \mathbb{Z}/p & t = 1 \\ 0 & t = kn + 1 > 1 \\ ([\frac{3k}{2}] - 1)\mathbb{Z}/p & t = -kn + 1 < 0 \\ H^{n-1}(\tilde{Q}_{p-1}; \mathbb{Z}/p) \oplus ([\frac{3k}{2}] - 1)\mathbb{Z}/p & t = kn - 1 > 0 \\ H^{n-1}(\tilde{Q}_{p-1}; \mathbb{Z}/p) & t = -kn - 1 < 0 \\ H^r(Q_p^\omega; \mathbb{Z}/p) \oplus \sum_{i=0}^{p-1} H^r(\tilde{Q}_i \times Q_{p-1-i}; \mathbb{Z}/p) & t = kn + r, 2 \leq r \leq n - 2 \end{cases}$$

or alternatively that  $\hat{H}^t(\text{Aut}(F_n); \mathbb{Z}_{(p)}) =$

$$\cong \left\{ \begin{array}{ll} \mathbb{Z}/p^2 \oplus p(\mathbb{Z}/p) & t = 0 \\ (p + [\frac{3k}{2}] - 1)\mathbb{Z}/p & |t| = kn \neq 0 \\ \mathbb{Z}/p & t = 1 \\ 0 & t = kn + 1 > 1 \\ ([\frac{3k}{2}] - 1)\mathbb{Z}/p & t = -kn + 1 < 0 \\ ([\frac{3k}{2}] - 1)\mathbb{Z}/p & t = kn - 1 > 0 \\ \oplus H^{n-1}(F_{p-1} \rtimes \text{Aut}(F_{p-1}); \mathbb{Z}/p) & \\ H^{n-1}(F_{p-1} \rtimes \text{Aut}(F_{p-1}); \mathbb{Z}/p) & t = -kn - 1 < 0 \\ H^r((F_{p-2} \times F_{p-2}) \times (\mathbb{Z}/2 \times \text{Aut}(F_{p-2})); \mathbb{Z}/p) \oplus & t = kn + r, \\ \sum_{i=0}^{p-1} H^r((F_i \times \text{Aut}(F_i)) \times \text{Aut}(F_{p-1-i}); \mathbb{Z}/p) & 2 \leq r \leq n - 2 \end{array} \right.$$

where  $Q_k$ ,  $\tilde{Q}_k$ , and  $Q_p^\omega$  are cellular complexes of dimensions  $2k - 2$ ,  $2k - 1$ , and  $2p - 4$ , respectively (provided  $k \neq 0$ ; both  $Q_0$  and  $\tilde{Q}_0$  can be taken to be points); they are quotient complexes of various contractible complexes by various groups and will be defined later in this paper. Although the second formulation of

$$\hat{H}^*(\text{Aut}(F_{2(p-1)}); \mathbb{Z}_{(p)})$$

above might seem more useful as it does not involve the above quotient complexes (that is,  $Q_k$ ,  $\tilde{Q}_k$ , and  $Q_p^\omega$ ), it (arguably) contains less information than the first formulation.

A quick note about our notation is appropriate here. In general, groups without any additional structure will be written using multiplicative notation (e.g.,  $\mathbb{Z}/p \times \mathbb{Z}/p \cong (\mathbb{Z}/p)^2$ ) but modules like cohomology groups will be written using additive notation (e.g.,  $\mathbb{Z}/p \oplus \mathbb{Z}/p \cong 2(\mathbb{Z}/p)$ .) Hence the case  $t = 0$  of our main result above should be read as stating that

$$\hat{H}^0(\text{Aut}(F_{2(p-1)}); \mathbb{Z}_{(p)}) \cong \mathbb{Z}/p^2 \oplus (\mathbb{Z}/p \oplus \cdots \oplus \mathbb{Z}/p)$$

where there are  $p$  copies of  $\mathbb{Z}/p$  in  $(\mathbb{Z}/p \oplus \cdots \oplus \mathbb{Z}/p)$ .

For the case of the prime  $p = 3$ , the cohomology groups of all of the relevant quotient spaces are calculated in Appendix A of this paper. This allows us to state concisely what the above result gives us in the case  $p = 3$ . This calculation was also (independently) done by Glover and Henn for both  $\text{Out}(F_4)$  and  $\text{Aut}(F_4)$ . In the appendix, we show that our main result simplifies to the following in the case  $p = 3$ :

$$\hat{H}^t(\text{Aut}(F_4); \mathbb{Z}_{(3)}) = \begin{cases} \mathbb{Z}/9 \oplus 3(\mathbb{Z}/3) & t = 0 \\ ([\frac{3k}{2}] + 2)\mathbb{Z}/3 & |t| = 4k \neq 0 \\ \mathbb{Z}/3 & t = 1 \\ 0 & |t| \equiv 1, 2 \pmod{4} \text{ and } t \neq 1 \\ ([\frac{3k}{2}] - 1)\mathbb{Z}/3 & |t| = 4k - 1 \end{cases}$$

A couple more remarks about the statement of our main result are in order. First, you will note that all calculations were done with  $\mathbb{Z}_{(p)}$ , the integers localized at the prime ideal  $(p)$ , as the coefficient ring. This was done for two reasons. One is that taking coefficients in  $\mathbb{Z}_{(p)}$  is like taking coefficients in  $\mathbb{Z}/p$  in that it allows us (most of the time) just to look at simplices with “ $p$ -symmetry” in the various spectral sequences that we will use to calculate the cohomology groups. In this way, calculations are simplified. Another reason is that by taking coefficients in  $\mathbb{Z}_{(p)}$  – rather than  $\mathbb{Z}/p$  – we are still able to distinguish torsion from non-torsion in the cohomology. Although this is irrelevant when looking at Farrell cohomology (as all Farrell cohomology groups are torsion), it will still have some technical advantages (over taking  $\mathbb{Z}/p$  coefficients) when we make statements about the usual cohomology of  $Aut(F_n)$  in chapter 7 and for the calculations about moduli spaces of graphs in part IV.

Second, Glover and Mislin used the standard spectral sequence for equivariant cohomology covered by Brown in [7] on page 173 or 282. It seems difficult to use that spectral sequence to calculate  $\hat{H}^*(Aut(F_{2(p-1)}); \mathbb{Z}_{(p)})$  and so instead we used the “normalizer spectral sequence” discussed by Brown in [7] on page 293. The normalizer spectral sequence is also discussed by Henn in [17], where in addition work giving a “centralizer spectral sequence” is done.

There are equivariant cohomology spectral sequences for both the usual cohomology and the Farrell cohomology of a group acting on a space. Unfortunately, the normalizer spectral sequence only applies to Farrell cohomology. Hence our results are stated in terms of Farrell cohomology. In chapter 7 we state what our results



imply about the usual cohomology of  $Aut(F_n)$ . In general, it is a more difficult problem to calculate the usual cohomology of a group than to calculate its Farrell cohomology. For example, although the results of Glover and Mislin about  $Out(F_p)$  can be used quickly to derive the Farrell cohomology of  $Aut(F_p)$ , the usual cohomology of  $Aut(F_p)$  has yet to be calculated “precisely”. This problem still arises in Chen’s calculations with  $Aut(F_{p+1})$  and  $Aut(F_{p+2})$ .

For the convenience of the reader, we now state these previous (or concurrent, in the case of Chen’s work) calculations concerning the cohomology of  $Aut(F_n)$ . From the work of Glover and Mislin in [12], it can be seen that for odd primes  $p$ ,

$$H^t(Aut(F_{p-1}); \mathbb{Z}_{(p)}) = \begin{cases} H^t(\Sigma_p; \mathbb{Z}_{(p)}) & t > 2p - 4 \\ H^t(Q_{p-1}; \mathbb{Z}_{(p)}) & t \leq 2p - 4 \end{cases}$$

where  $Q_m$  is the quotient of the spine  $X_m$  of outer space and  $\Sigma_p$  is the symmetric group on  $p$  letters.

Restating this in terms of Farrell cohomology, we find that for all  $t$ ,

$$\hat{H}^t(Aut(F_{p-1}); \mathbb{Z}_{(p)}) = \hat{H}^t(\Sigma_p; \mathbb{Z}_{(p)}).$$

Similarly, it is clear from Glover and Mislin’s work that

$$\hat{H}^t(Aut(F_p); \mathbb{Z}_{(p)}) = 3\hat{H}^t(\Sigma_p; \mathbb{Z}_{(p)}),$$

and Chen in [9] shows that if  $p \geq 5$  then

$$\hat{H}^t(Aut(F_{p+1}); \mathbb{Z}_{(p)}) = 4\hat{H}^t(\Sigma_p; \mathbb{Z}_{(p)})$$

and that

$$\hat{H}^t(Aut(F_{p+2}); \mathbb{Z}_{(p)}) = 5\hat{H}^t(\Sigma_p; \mathbb{Z}_{(p)}) \oplus \hat{H}^{t-4}(\Sigma_p; \mathbb{Z}_{(p)}).$$

As a final note, it is easy to check that  $\hat{H}^t(\Sigma_p; \mathbb{Z}_{(p)})$  is periodic with period  $2(p-1)$  and that

$$\hat{H}^t(\Sigma_p; \mathbb{Z}_{(p)}) = \begin{cases} \mathbb{Z}/p & t = 2(p-1)k \\ 0 & \text{otherwise} \end{cases}$$

# Part I

## Cohomological calculations

# Chapter 1

## The equivariant spectral sequence and the spine of “auter space”

Let  $G$  be a group acting cellularly on a finite dimensional CW-complex  $X$  such that the stabilizer  $stab_G(\delta)$  of every cell  $\delta$  is finite and such that the quotient of  $X$  by  $G$  is finite. Further suppose that for every cell  $\delta$  of  $X$ , the group  $stab_G(\delta)$  fixes  $\delta$  pointwise. Let  $M$  be a  $G$ -module. Recall (see [7]) that the equivariant cohomology groups of the  $G$ -complex  $X$  with coefficients in  $M$  are defined by

$$H_G^*(X; M) = H^*(G; C^*(X; M))$$

and that if in addition  $X$  is contractible (which will usually, but not always, be the case in this paper) then

$$H_G^*(X; M) = H^*(G; M).$$

In [7] a spectral sequence

$$(1.1) \quad \tilde{E}_1^{r,s} = \prod_{[\delta] \in \Delta_n^r} H^s(\text{stab}(\delta); M) \Rightarrow H_G^{r+s}(X; M)$$

is defined, where  $[\delta]$  ranges over the set  $\Delta_n^r$  of orbits of  $r$ -simplices  $\delta$  in  $X$ .

If  $M$  is  $\mathbb{Z}/p$  or  $\mathbb{Z}_{(p)}$  then a nice property should be noted about the spectral sequence 1.1. This property will greatly reduce the calculations we need to go through, and in general will make concrete computations possible. Since each group  $\text{stab}(\delta)$  is finite, a standard restriction-transfer argument in group cohomology yields that  $|\text{stab}(\delta)|$  annihilates  $H^s(\text{stab}(\delta); M)$  for all  $s > 0$ . (For examples of these sorts of arguments see [1] or [7].) Since all primes not equal to  $p$  are divisible in  $\mathbb{Z}/p$  or  $\mathbb{Z}_{(p)}$ , this in turn shows that the  $p$ -part of  $|\text{stab}(\delta)|$  annihilates  $H^s(\text{stab}(\delta); M)$  for  $s > 0$ . In particular, if  $p$  does not divide some  $|\text{stab}(\delta)|$ , then this  $[\delta]$  does not contribute anything to the spectral sequence 1.1 except in the horizontal row  $s = 0$ . It follows that if our coefficients are  $\mathbb{Z}/p$  or  $\mathbb{Z}_{(p)}$  then we are mainly just concerned with the simplices  $\delta$  which have “ $p$ -symmetry”.

If  $G$  is a group with finite virtual cohomological dimension (vcd) and  $M$  is a  $G$ -module, then Farrell cohomology groups

$$\hat{H}^*(G; M)$$

are defined in [11] and [7]. For the basics about Farrell cohomology, along with several useful properties, see [7] or [11]. Briefly, if  $M$  is one of the standard coefficient rings like  $\mathbb{Z}$ ,  $\mathbb{Q}$ ,  $\mathbb{Z}/p$ , or  $\mathbb{Z}_{(p)}$  then these cohomology groups have the property that:

$$\hat{H}^t(G; M) = H^*(G; M) \text{ if } t > \text{vcd}(G)$$

and

$$\hat{H}^*(G; M) = 0 \text{ if } G \text{ is torsion free.}$$

Moreover, unlike the usual cohomology groups, they tend to be nonzero for negative indices  $t < 0$  as well as for positive indices.

As before, suppose  $G$  acts cellularly on a finite dimensional CW-complex  $X$  such that the stabilizer  $stab_G(\delta)$  of every cell  $\delta$  is finite and such that the quotient of  $X$  by  $G$  is finite. Further suppose that for every cell  $\delta$  of  $X$ , the group  $stab_G(\delta)$  fixes  $\delta$  pointwise. Just as in the usual case, the equivariant Farrell cohomology groups of the  $G$ -complex  $X$  with coefficients in  $M$  are defined (see [7] for details) by

$$\hat{H}_G^*(X; M) = \hat{H}^*(G; C^*(X; M))$$

and if in addition  $X$  is contractible then

$$\hat{H}_G^*(X; M) = \hat{H}^*(G; M).$$

For Farrell cohomology, Brown defines in [7] an equivariant cohomology spectral sequence which is analogous to 1.1. It is given by

$$(1.2) \quad E_1^{r,s} = \prod_{[\delta] \in \Delta_n^r} \hat{H}^s(stab(\delta); M) \Rightarrow \hat{H}_G^{r+s}(X; M).$$

If  $M$  is  $\mathbb{Z}/p$  or  $\mathbb{Z}_{(p)}$  then as before only the simplices with “ $p$ -symmetry” are relevant. That is, we know that  $|stab(\delta)|$  annihilates  $\hat{H}^s(stab(\delta); \mathbb{Z}_{(p)})$  for all  $s$  (not just for  $s > 0$  as before.) Since all primes not equal to  $p$  are divisible in  $M$ , this shows that the  $p$ -part of  $|stab(\delta)|$  annihilates  $\hat{H}^s(stab(\delta); M)$  for all  $s$ . Accordingly, if  $p$  does not divide some  $|stab(\delta)|$ , then this  $[\delta]$  does not contribute anything to the spectral sequence 1.2.

We now specialize to the case where  $G = \text{Aut}(F_n)$  and  $X$  is the spine  $X_n$  of “auter space.” First, we review some basic properties and definitions of  $\text{Aut}(F_n)$  and auter space. Most of these can be found in [10], [15], [23], and [24]. Consider the automorphism group  $\text{Aut}(F_n)$  of a free group  $F_n$  of rank  $n$  (where  $n = 2(p-1)$  for our work.) Let  $(R_n, v_0)$  be the  $n$ -leafed rose, a wedge of  $n$  circles. We say a basepointed graph  $(G, x_0)$  is *admissible* if it has no free edges, all vertices except the basepoint have valence at least three, and there is a basepoint-preserving continuous map  $\phi: R_n \rightarrow G$  which induces an isomorphism on  $\pi_1$ . The triple  $(\phi, G, x_0)$  is called a *marked graph*. Two marked graphs  $(\phi_i, G_i, x_i)$  for  $i = 0, 1$  are *equivalent* if there is a homeomorphism  $\alpha: (G_0, x_0) \rightarrow (G_1, x_1)$  such that  $(\alpha \circ \phi_0)_\# = (\phi_1)_\# : \pi_1(R_n, v_0) \rightarrow \pi_1(G_1, x_1)$ . Define a partial order on the set of all equivalence classes of marked graphs by setting  $(\phi_0, G_0, x_0) \leq (\phi_1, G_1, x_1)$  if  $G_1$  contains a *forest* (a disjoint union of trees in  $G_1$  which contains all of the vertices of  $G_1$ ) such that collapsing each tree in the forest to a point yields  $G_0$ , where the collapse is compatible with the maps  $\phi_0$  and  $\phi_1$ .

From [14] and [15] we have that  $\text{Aut}(F_n)$  acts with finite stabilizers on a contractible space  $X_n$ . The space  $X_n$  is the geometric realization of the poset of marked graphs that we defined above. Let  $Q_n$  be the quotient of  $X_n$  by  $\text{Aut}(F_n)$ . Note that the CW-complex  $Q_n$  is not necessarily a simplicial complex. Since  $\text{Aut}(F_n)$  has a torsion free subgroup of finite index [14] and it acts on the contractible, finite dimensional space  $X_n$  with finite stabilizers and finite quotient,  $\text{Aut}(F_n)$  has finite vcd. Thus it makes sense to talk about its Farrell cohomology, and to apply spectral sequences like 1.2 to calculate that cohomology. For  $n = 0$ , we set

$X_0 = Q_0 = \{\text{a point}\}$  as a notational convenience.

Let  $p$  be an odd prime number, and let  $\mathbb{Z}_{(p)}$  be the localization of  $\mathbb{Z}$  at the prime ideal  $(p)$ . Then we can apply the spectral sequences 1.1 and 1.2 to get

$$(1.3) \quad \tilde{E}_1^{r,s} = \prod_{[\delta] \in \Delta_n^r} H^s(\text{stab}(\delta); \mathbb{Z}_{(p)}) \Rightarrow H^{r+s}(\text{Aut}(F_n); \mathbb{Z}_{(p)})$$

and

$$(1.4) \quad E_1^{r,s} = \prod_{[\delta] \in \Delta_n^r} \hat{H}^s(\text{stab}(\delta); \mathbb{Z}_{(p)}) \Rightarrow \hat{H}^{r+s}(\text{Aut}(F_n); \mathbb{Z}_{(p)})$$

where  $[\delta]$  ranges over the set  $\Delta_n^r$  of orbits of  $r$ -simplices  $\delta$  in  $X_n$ .

The spectral sequences 1.3 and 1.4 requires as input the stabilizers  $\text{stab}_{\text{Aut}(F_n)}(\delta)$  of simplices  $\delta$  in  $X_n$ . Smillie and Vogtmann [23] examined the structure of these stabilizers in detail, and we list their results here. Consider a given  $r$ -simplex

$$(\phi_r, G_r, x_r) > \cdots > (\phi_1, G_1, x_1) > (\phi_0, G_0, x_0)$$

with corresponding forest collapses

$$(H_r \subseteq G_r), \dots, (H_2 \subseteq G_2), (H_1 \subseteq G_1).$$

For each  $i \in 0, 1, \dots, r$ , let  $F_i$  be the inverse image under the map

$$G_r \rightarrow \cdots \rightarrow G_{i+1} \rightarrow G_i$$

of forest collapses, of the forest  $H_i$ . That is, we have

$$F_r \subseteq \cdots \subseteq F_2 \subseteq F_1 \subseteq G_r.$$

It is shown in [23] that the stabilizer of the simplex under consideration is isomorphic to the group  $\text{Aut}(G_r, F_1, \dots, F_r, x_r)$  of basepointed automorphisms of the graph  $G_r$



that respect each of the forests  $F_i$ . For example, the stabilizer of a point  $(\phi, G, x_0)$  in  $X_n$  is isomorphic to  $Aut(G, x_0)$ .

To sum things up, suppose we wanted to use the spectral sequences 1.3 or 1.4 to compute the cohomology of  $Aut(F_n)$ . Since our coefficient ring is  $\mathbb{Z}/(p)$ , we have already remarked that for the terms in the spectral sequence above the horizontal axis, we are concerned only with simplices whose stabilizers are divisible by  $p$ . In addition, the stabilizer of a simplex consists of graph automorphisms that respect the forest collapses in the simplex. Let us investigate what simplices arise in the case  $n = 2(p - 1)$ . In other words, we want to calculate which graphs  $G$  with a  $\mathbb{Z}/p$  action on them have  $\pi_1(G) \cong F_n$ . To simplify our calculations, we will consider only reduced  $\mathbb{Z}/p$ -graphs, where a  $\mathbb{Z}/p$ -graph  $G$  is *reduced* if it contains no  $\mathbb{Z}/p$ -invariant subforests.

The spectral sequence 1.3 is the one used by Glover and Mislin in [12] for their calculations of the cohomology of  $Out(F_n)$  for  $n = p - 1, p, p + 1$ . We are interested, however, in the cohomology of  $Aut(F_n)$  for  $n = 2(p - 1)$ . The step of finding which simplices in  $X_{2(p-1)}$  have  $p$ -symmetry would be a necessary one if we actually intended to use the spectral sequence 1.3 to calculate the cohomology of  $Aut(F_{2(p-1)})$ . Unfortunately, it seems that the spectral sequence 1.3 becomes too cluttered and difficult to compute with in our case, and so we will not be using it to calculate our cohomology groups. Instead, we will use Ken Brown's "normalizer spectral sequence" [7] which will be introduced in chapter 2. Nevertheless, it will still prove instructive and useful to examine which simplices in  $X_{2(p-1)}$  have  $p$ -symmetry.

Some preliminary definitions of a few common graphs are in order. Let  $\Theta_{p-1}$  be

the graph with two vertices and  $p$  edges, each of which goes from one vertex to the other (see Figure 1.1.) Say the “leftmost vertex” of  $\Theta_{p-1}$  is the basepoint. Hence when we write  $\Theta_{p-1} \vee R_{p-1}$  then we are stipulating that the rose  $R_{p-1}$  is attached to the non-basepointed vertex of  $\Theta_{p-1}$ , while when we write  $R_{p-1} \vee \Theta_{p-1}$  then we are saying that the rose is attached to the basepoint of  $\Theta_{p-1}$ . Let  $\Phi_{2(p-1)}$  be a graph with  $3p$  edges  $a_1, \dots, a_p, b_1, \dots, b_p, c_1, \dots, c_p$ , and  $p+3$  vertices  $v_1, \dots, v_p, x, y, z$ . The basepoint is  $x$  and each of the edges  $a_i$  begin at  $x$  and end at  $v_i$ . The edges  $b_i$  and  $c_i$  begin at  $y$  and  $z$ , respectively, and end at  $v_i$ . Note that there are obvious actions of  $\mathbb{Z}/p$  on  $\Theta_{p-1}$  and  $\Phi_{2(p-1)}$ , given by rotation, and that these actions are unique up to conjugacy. Let  $\Psi_{2(p-1)}$  be the graph obtained from  $\Phi_{2(p-1)}$  by collapsing all of the edges  $a_i$  to a point. Let  $\Omega_{2(p-1)}$  be the graph obtained from  $\Phi_{2(p-1)}$  by collapsing either the edges  $b_i$  or the edges  $c_i$  (the resulting graphs are isomorphic) to a point. Note that the only difference between  $\Psi_{2(p-1)}$  and  $\Omega_{2(p-1)}$  is where the basepoint is located.

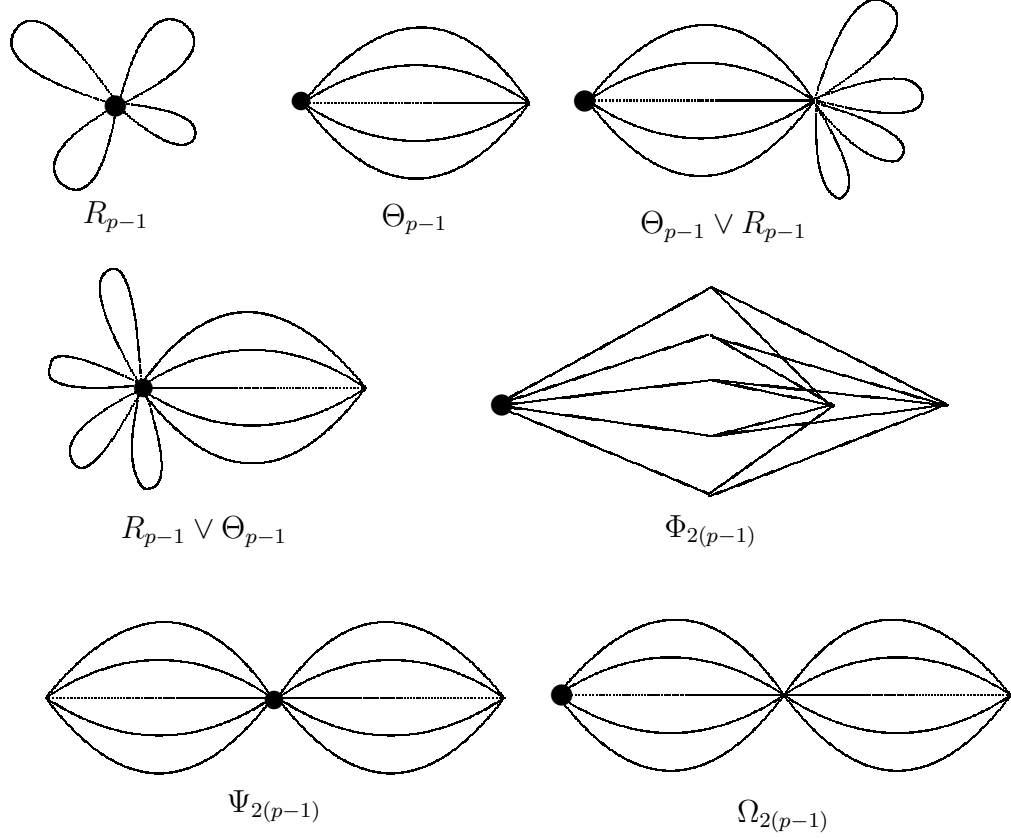

Figure 1.1: Some graphs with  $p$ -symmetry

**Lemma 1.5** *Let  $p$  be an odd prime and  $n = 2(p - 1)$ , and let  $\Gamma$  be a reduced (basepointed) graph with a nontrivial  $\mathbb{Z}/p$ -action, where  $\pi_1(\Gamma) \cong F_n$ . Let  $e$  be an edge of  $\Gamma$  which is moved by the  $\mathbb{Z}/p$  action. Then the orbit of the edge  $e$  forms either a rose  $R_p$  or a  $\Theta$ -graph  $\Theta_{p-1}$ .*

**Proof.** Say  $e_1, e_2, \dots, e_p$  is the orbit of the edge  $e$  under the  $\mathbb{Z}/p$ -action. (By an edge here we mean an unoriented one; that is, a 1-cell in the 1-dimensional CW-complex  $\Gamma$ .)

Since  $\Gamma$  is reduced, the edges  $e_i$  have some endpoints in common, else they form an invariant subforest. Similarly, they cannot have just one endpoint in common, or we could collapse the star that they would form. Finally, they also cannot form a  $p$ -gon, else we could take a minimal path from  $e_1$  to the basepoint, consider its orbit under  $\mathbb{Z}/p$ , and find in those edges a star of  $p$  edges that could be collapsed. So either all of the endpoints of the  $e_i$  are the same and they form a rose, or there are two distinct endpoints and they form a  $\Theta$ -graph.  $\square$

**Proposition 1.6** *Let  $p$  be an odd prime and  $n = 2(p - 1)$ . The only reduced (basepointed) graphs  $\Gamma$  with a nontrivial  $\mathbb{Z}/p$ -action and  $\pi_1(\Gamma) \cong F_n$  are  $R_n$ ,  $R_k \vee \Theta_{p-1} \vee R_{p-1-k}$ ,  $\Psi_n$ , and  $\Omega_n$ .*

**Proof.** First, suppose that  $\Gamma$  has only one nontrivial  $\mathbb{Z}/p$ -orbit of edges

$$e_1, e_2, \dots, e_p.$$

From the lemma, the  $e_i$  either form a rose  $R_p$  or a  $\Theta$ -graph  $\Theta_{p-1}$ . In the first case,  $\Gamma$  must be  $R_{2(p-1)}$  with  $\mathbb{Z}/p$  rotating  $p$  of the leaves and leaving the other  $p - 2$  fixed. In the second case,  $\Gamma$  must be of the form  $R_k \vee \Theta_{p-1} \vee R_{p-1-k}$  where  $\mathbb{Z}/p$  rotates the edges of the  $\Theta$ -graphs and leaves the roses at either end of the  $\Theta$ -graph fixed.

Second, we examine the case where  $\Gamma$  has more than one nontrivial  $\mathbb{Z}/p$ -orbit of unoriented edges. Take two distinct orbits  $e_1, e_2, \dots, e_p$  and  $f_1, f_2, \dots, f_p$ . As in the previous paragraph, we can use the fact that  $\Gamma$  is reduced and Lemma 1.5 to get that the  $e_i$  and  $f_i$  either form roses or  $\Theta$ -graphs. If either one of them is a rose, then the rank of  $\pi_1(\Gamma)$  is at least  $2p - 1$ , which is a contradiction. So both form

$\Theta$ -graphs. Since  $\pi_1(\Gamma) \cong F_{2(p-1)}$ ,  $\Gamma$  doesn't have any other edges aside from the  $e_i$  and  $f_i$ . It follows that  $\Gamma$  is either  $\Psi_n$  or  $\Omega_n$ , depending upon where the basepoint is.  $\square$

## Chapter 2

# The normalizer spectral sequence

Ken Brown [7] introduces another spectral sequence that can be used to calculate  $\hat{H}^*(Aut(F_n); \mathbb{Z}_{(p)})$ . It involves normalizers of elementary abelian  $p$ -subgroups of the group under consideration ( $Aut(F_n)$  in our case) and hence will be called the “normalizer spectral sequence.” This is not the only alternative available to the standard spectral sequence for equivariant cohomology, as Hans-Werner Henn [17] has created a “centralizer spectral sequence” that involves centralizers of elementary abelian  $p$ -subgroups; however, Brown’s spectral sequence appears to be the easiest to apply in our situation.

Let  $p$  be a prime,  $G$  be a group with finite virtual cohomological dimension,  $M$  be a  $G$ -module, and  $\mathcal{A}$  be the poset of nontrivial elementary abelian  $p$ -subgroups of  $G$ . Let  $G$  act on  $\mathcal{A}$  by conjugation, so that the simplicial realization  $|\mathcal{A}|$  is a  $G$ -complex. Finally, denote by  $\hat{H}^*(G; M)_p$  the  $p$ -primary part of  $\hat{H}^*(G; M)$ . Brown

shows that there is an isomorphism

$$(2.1) \quad \hat{H}^*(G; M)_p \approx \hat{H}_G^*(\mathcal{A}; M)_p.$$

Now let the coefficient module  $M$  be either  $\mathbb{Z}/p$  or  $\mathbb{Z}_{(p)}$  so that 2.1 becomes just

$$\hat{H}^*(G; M) \approx \hat{H}_G^*(\mathcal{A}; M).$$

Then use the equivariant spectral sequence 1.2 to compute  $\hat{H}_G^*(\mathcal{A}; M)$ . This spectral sequence involves stabilizers of simplices of  $|\mathcal{A}|$ . If

$$(A_0 \subset \cdots \subset A_r)$$

is an  $r$ -simplex of  $|\mathcal{A}|$  then its stabilizer is the intersection of normalizers

$$\bigcap_{i=0}^r N_G(A_i)$$

because  $G$  acts on  $\mathcal{A}$  by conjugation. Hence the equivariant spectral sequence used to calculate  $\hat{H}_G^*(\mathcal{A}; M)$  becomes the following “normalizer spectral sequence”:

$$(2.2) \quad E_1^{r,s} = \prod_{(A_0 \subset \cdots \subset A_r) \in |\mathcal{B}|_r} \hat{H}^s\left(\bigcap_{i=0}^r N_G(A_i); M\right) \Rightarrow \hat{H}^{r+s}(G; M)$$

where  $\mathcal{B}$  denotes the poset of conjugacy classes of nontrivial elementary abelian  $p$ -subgroups of  $G$ , and  $|\mathcal{B}|_r$  is the set of  $r$ -simplices in the realization  $|\mathcal{B}|$ .

For our case (i.e., the case  $G = \text{Aut}(F_n)$ ), we set  $M = \mathbb{Z}_{(p)}$  and note that from [14] we know that  $\text{Aut}(F_n)$  has finite vcd. So we can apply 2.2 to obtain

$$(2.3) \quad E_1^{r,s} = \prod_{(A_0 \subset \cdots \subset A_r) \in |\mathcal{B}|_r} \hat{H}^s\left(\bigcap_{i=0}^r N_{\text{Aut}(F_n)}(A_i); \mathbb{Z}_{(p)}\right) \Rightarrow \hat{H}^{r+s}(\text{Aut}(F_n); \mathbb{Z}_{(p)})$$

where  $\mathcal{B}$  denotes the poset of conjugacy classes of nontrivial elementary abelian  $p$ -subgroups of  $\text{Aut}(F_n)$ , and  $|\mathcal{B}|_r$  is the set of  $r$ -simplices in the realization  $|\mathcal{B}|$ .

It is important to note, however, that although we will not be using a spectral sequence for equivariant cohomology directly to compute the cohomology of  $\text{Aut}(F_n)$ , we will be computing the cohomology groups of normalizers of elementary abelian  $p$ -subgroups using spectral sequences for equivariant cohomology. The output of these spectral sequences will then be entered in as input into the  $E_1$ -page of the normalizer spectral sequence 2.3.

In this chapter, we will compute the elementary abelian  $p$ -subgroups of  $\text{Aut}(F_n)$ . In the next chapter, we will adapt methods of Krstic to compute the normalizers of these subgroups, in the chapter after that we will define certain contractible subcomplexes of outer space that these normalizers act on, and in the following chapter we will use the equivariant cohomology spectral sequence associated to the action of the normalizers on these contractible subcomplexes to compute the cohomology of the normalizers.

From [3] and [21], we see that  $p^2$  is an upper bound for the order of any  $p$ -subgroup of  $\text{Aut}(F_n)$ . (Recall that we set  $n = 2(p - 1)$  earlier.) Every nontrivial  $p$ -subgroup of  $\text{Aut}(F_n)$  is isomorphic to either  $\mathbb{Z}/p$  or  $\mathbb{Z}/p \times \mathbb{Z}/p$  (see, for example, Smillie and Vogtmann in [24].)

A subgroup  $G$  of  $\text{Aut}(F_n)$  is said to be *realized* by a specific marked graph  $\eta : R_n \rightarrow \Gamma$  if it is contained in the stabilizer of that marked graph. Since (from [23]) the stabilizer of  $\eta : R_n \rightarrow \Gamma$  is isomorphic to the group  $\text{Aut}(\Gamma, *)$  of basepoint-preserving graph automorphisms of  $\Gamma$ , this means that we can think of  $\Gamma$  as a graph



with an action of  $G$  on it. If two subgroups  $G_1$  and  $G_2$  are realized by marked graphs  $\eta_1 : R_n \rightarrow \Gamma$  and  $\eta_2 : R_n \rightarrow \Gamma$ , respectively, and if both  $G_1$  and  $G_2$  give the same action on the graph  $\Gamma$ , then  $G_1$  and  $G_2$  are conjugate.

We want to find all conjugacy classes of (elementary abelian)  $p$ -subgroups of  $Aut(F_n)$ . We can do this by analyzing marked graphs with  $p$ -symmetry, so that the stabilizers of these marked graphs have elements of order  $p$ . Since we are only interested in conjugacy classes of subgroups, we will just examine the underlying graphs of the marked graphs.

We now define several  $p$ -subgroups  $A$ ,  $B_k$ ,  $C$ ,  $D$ , and  $E$  of  $Aut(F_n)$ . Our goal is to show that these are a complete listing of the distinct conjugacy classes of  $p$ -subgroups of  $Aut(F_n)$ .

- There is an action of  $\mathbb{Z}/p$  on the rose  $R_{2(p-1)}$  given by rotating the first  $p$  leaves of the rose. By looking at the stabilizer of a marked graph with underlying graph  $R_{2(p-1)}$ , this action gives us a subgroup  $A \cong \mathbb{Z}/p$  of  $Aut(F_{2(p-1)})$ . This subgroup is a maximal  $p$ -subgroup, in the sense that no other  $p$ -subgroup properly contains it.
- For each  $k \in \{0, \dots, p-1\}$ , there is an action of  $\mathbb{Z}/p$  on  $R_k \vee \Theta_{p-1} \vee R_{p-1-k}$  given by rotating the edges in  $\Theta_{p-1}$ . This action gives us a subgroup  $B_k \cong \mathbb{Z}/p$  of  $Aut(F_{2(p-1)})$ . If  $k \in \{1, \dots, p-2\}$ , then  $B_k$  is a maximal  $p$ -subgroup.
- There is an action of  $\mathbb{Z}/p$  on  $\Phi_{2(p-1)}$  which gives us a (non-maximal)  $p$ -subgroup  $C \cong \mathbb{Z}/p$  of  $Aut(F_{2(p-1)})$ .
- There is an action of  $\mathbb{Z}/p \times \mathbb{Z}/p$  on  $\Omega_{2(p-1)}$  given by having the first  $\mathbb{Z}/p$  rotate

one of the  $\Theta$ -graphs in  $\Omega_{2(p-1)}$  and having the second  $\mathbb{Z}/p$  rotate the other  $\Theta$ -graph. This action gives us a subgroup  $D \cong \mathbb{Z}/p \times \mathbb{Z}/p$  of  $\text{Aut}(F_{2(p-1)})$ . This subgroup is maximal among  $p$ -subgroups, and it contains  $B_0$ ,  $B_{p-1}$ , and  $C$ .

- There is an action of  $\mathbb{Z}/p \times \mathbb{Z}/p$  on  $\Psi_{2(p-1)}$  given by having the first  $\mathbb{Z}/p$  rotate one of the  $\Theta$ -graphs in  $\Psi_{2(p-1)}$  and having the second  $\mathbb{Z}/p$  rotate the other  $\Theta$ -graph. This action gives us a subgroup  $E \cong \mathbb{Z}/p \times \mathbb{Z}/p$  of  $\text{Aut}(F_{2(p-1)})$ . This subgroup is maximal among  $p$ -subgroups, and it contains  $B_{p-1}$  and  $C$ .

**Proposition 2.4** *Every  $p$ -subgroup of  $\text{Aut}(F_{2(p-1)})$  is conjugate to one of*

$$A, B_0, \dots, B_{p-1}, C, D, \text{ or } E.$$

**Proof.** As we asserted earlier, every nontrivial  $p$ -subgroup  $P$  is either  $\mathbb{Z}/p$  or  $\mathbb{Z}/p \times \mathbb{Z}/p$ . From Culler, this subgroup is realized by an action on a basepointed marked graph  $(\eta, \Gamma, *)$ . Since we are only trying to calculate conjugacy classes of elementary abelian  $p$ -subgroups, we need only think of  $P$  as acting on the underlying basepointed graph  $\Gamma$ . In addition, we might as well collapse invariant forests to get an action of  $P$  on a reduced graph  $\Gamma$ .

If  $P = \mathbb{Z}/p$ , then Proposition 1.6 gives us that  $\Gamma$  is one of  $R_n$ ,  $R_k \vee \Theta_{p-1} \vee R_{p-1-k}$ ,  $\Psi_n$ , or  $\Omega_n$ . If  $\Gamma$  is  $R_n$  then  $P$  is conjugate to  $A$ . If  $\Gamma$  is  $R_k \vee \Theta_{p-1} \vee R_{p-1-k}$  then  $P$  is conjugate to  $B_k$ . Finally, note that by collapsing different invariant forests the action of  $\mathbb{Z}/p$  on  $\Phi_n$  gives a diagonal action of  $\mathbb{Z}/p$  on both  $\Psi_n$  and  $\Omega_n$ . Hence if  $\Gamma$  is either  $\Psi_n$  or  $\Omega_n$  then  $P$  is conjugate to  $C$ .

Next, suppose  $P = \mathbb{Z}/p \times \mathbb{Z}/p = (\alpha) \times (\beta)$ . The first cyclic summand must rotate  $p$  edges  $e_1, e_2, \dots, e_p$  of  $\Gamma$ . Without loss of generality, we may assume  $(\beta)$  fixes these edges (by replacing  $\beta$  with  $\beta - \alpha^j$  for some  $j$  if necessary.) Now  $\beta$  must rotate  $p$  other edges  $f_1, f_2, \dots, f_p$ . Again, we can also assume without loss of generality that  $\alpha$  fixes the edges  $f_i$ . From Lemma 1.5, the  $e_i$  and  $f_i$  must form either roses or  $\Theta$ -graphs. Neither can form a rose or the rank of  $\pi_1(\Gamma)$  is at least  $2p - 1$ . So both form  $\Theta$ -graphs. Hence  $\Gamma$  is either  $\Psi_n$  or  $\Omega_n$ . In the former case  $P$  is conjugate to  $E$  while in the latter case it is conjugate to  $D$ .  $\square$

In order to determine whether or not two different graphs give us the same elementary abelian  $p$ -subgroup, we need to use work of Krstic in [18] involving *Nielsen transformations*. More will be said on this in the next chapter, but for now we briefly recall Krstic's definition of Nielsen transformations and state the result of Krstic that we need.

**Definition 2.5 (Nielsen transformation)** *Let  $G$  be a finite subgroup of  $\text{Aut}(F_n)$ , which is realized by an action of  $G$  on a reduced, basepointed graph  $\Gamma$ . Let  $V$  and  $E$  be the vertex and oriented edge sets, respectively, of  $\Gamma$ . Finally, let  $\iota, \tau : E \rightarrow V$  be maps which give the initial and terminal points, respectively, of oriented edges. If there are two edges  $e$  and  $f$  of  $\Gamma$  such that:*

- $e$  and  $f$  are in different orbits (i.e.,  $f \notin Ge \cup G\bar{e}$ ),
- $\tau e = \tau f$ , and
- $\text{stab}(e) \subseteq \text{stab}(f)$ .

then there is an admissible Nielsen transformation  $\langle e, f \rangle$  from  $\Gamma$  to a new graph  $\langle e, f \rangle \Gamma$ . The graph  $\Gamma' = \langle e, f \rangle \Gamma$  has the same vertex and edge sets  $V$  and  $E$  as  $\Gamma$ ; however, the map  $\tau' : E \rightarrow V$  which gives the terminal point of an edge is changed as follows. For edges  $h$  not in the orbit of  $e$ , set  $\tau'h = \tau h$ ; but set  $\tau'ge = \iota gf$  for  $g \in G$ .

If a sequence of Nielsen transformations can change a  $G$ -graph  $\Gamma_1$  into a  $G$ -graph  $\Gamma_2$ , then  $\Gamma_1$  is said to be *Nielsen equivalent* to  $\Gamma_2$ .

We need the following theorem of Krstic, Theorem 2 from [18]:

**Theorem 2.6 (Krstic)** *Let  $\Gamma_1$  and  $\Gamma_2$  realize the same subgroup  $G$  of  $\text{Aut}(F_n)$ . If  $\Gamma_1$  and  $\Gamma_2$  are reduced as  $G$ -graphs then they are Nielsen equivalent, up to an equivariant isomorphism (a basepoint preserving isomorphism.)*

**Proposition 2.7** *The subgroups  $A, B_0, \dots, B_{p-1}, C, D, E$  are in distinct conjugacy classes. The diagram of subgroups up to conjugacy is*

$$(2.8) \quad \begin{array}{ccc} & B_0 & \\ & \downarrow & \\ & D & \\ & \nearrow \quad \nwarrow & \\ B_{p-1} & & C \\ & \searrow \quad \swarrow & \\ & E & \end{array}$$

**Proof.** We apply Theorem 2.6. Any two reduced graphs realized by the same subgroup of  $\text{Aut}(F_n)$  can be connected up by a sequence of Nielsen transformations.

It is easy to see that the only case in which this could occur for two different graphs listed in Proposition 1.6 is when  $P = \mathbb{Z}/p$  and the two graphs are  $\Psi_n$  and  $\Omega_n$ . We already know, however, that in this case  $P$  is conjugate to the subgroup  $C$  of  $Aut(F_n)$ .  $\square$

# Chapter 3

## Normalizers of $p$ -subgroups of

### $Aut(F_n)$

The structure of centralizers of finite subgroups of  $Aut(F_n)$  is given by Krstic in [18] in some detail. He shows that, for a finite subgroup  $G$  of  $Aut(F_n)$ , an element of the centralizer  $C_{Aut(F_n)}(G)$  is a product of Nielsen transformations followed by a centralizing graph isomorphism. Moreover, one of the main propositions of his paper can be used to yield information about the structure of normalizers of finite subgroups, which is what we are interested in here.

We now recall some definitions and theorems from Krstic [18].

**Definition 3.1 (Nielsen isomorphism)** *Let  $\langle e, f \rangle$  be a Nielsen transformation from  $\Gamma$  to  $\Gamma'$  (see Definition 2.5.) A Nielsen isomorphism is the isomorphism between fundamental groupoids:*

$$\langle e, f \rangle: \Pi(\Gamma) \rightarrow \Pi(\Gamma')$$

given by  $\langle e, f \rangle h = h$  if  $h$  is not in the orbit of  $e$  and  $\langle e, f \rangle ge = gef$  for  $g \in G$ .

Sometimes this notation is abused and we say Nielsen transformation when we mean Nielsen isomorphism. This abuse will tend to happen when we are implicitly dealing with maps between fundamental groupoids even though we only state things on the level of deforming graphs by applying Nielsen transformations to them.

The following is Proposition 4' from [18]:

**Proposition 3.2 (Krstic)** *If  $\Gamma_1$  and  $\Gamma_2$  are finite basepointed, reduced  $G$ -graphs and*

$$F : \Pi(\Gamma_1) \rightarrow \Pi(\Gamma_2)$$

*is an equivariant groupoid isomorphism which preserves the base vertex, then there exists a product  $T$  of Nielsen transformations and an equivariant isomorphism of basepointed graphs*

$$H : T\Gamma_1 \rightarrow \Gamma_2$$

*such that  $F = HT$ .*

Recall that  $\pi_1(\Gamma_i)$  is a sub-groupoid of  $\Pi(\Gamma_i)$ . Krstic uses the above theorem to get information about maps between fundamental groups. He shows the following, which is Corollary 1' in [18]:

**Corollary 3.3 (Krstic)** *Let  $\Gamma_1$  and  $\Gamma_2$  be reduced pointed  $G$ -graphs of rank  $\geq 2$ . Then every equivariant isomorphism*

$$\pi_1(\Gamma_1, *) \rightarrow \pi_1(\Gamma_2, *)$$

is the restriction of an equivariant isomorphism

$$\Pi(\Gamma_1) \rightarrow \Pi(\Gamma_2).$$

For a  $G$ -graph  $\Gamma$  and an automorphism  $\phi : G \rightarrow G$ , let  $\phi(\Gamma)$  be the  $G$ -graph with underlying graph  $\Gamma$  and  $G$ -action given by  $gx := \phi(g)x$  where  $g \in P$ ,  $x \in V(\Gamma) \cup E(\Gamma)$ , and the latter multiplication is given by the standard action on  $\Gamma$ . In other words,  $\phi(\Gamma)$  is just the graph  $\Gamma$  with the  $G$ -action “twisted” by  $\phi$ .

Realize the finite subgroup  $G$  of  $Aut(F_n)$  by a marked graph  $\eta : R_n \rightarrow \Gamma$  where the induced action of  $G$  on  $\Gamma$  is reduced.

**Proposition 3.4** *Every element  $\alpha$  of  $N_{Aut(F_n)}(G)$  is realized by a  $G$ -equivariant isomorphism*

$$\pi_1(\Gamma, *) \rightarrow \pi_1(\phi(\Gamma), *)$$

for some automorphism  $\phi$  of  $G$ .

Note that the automorphism  $\phi$  can change as we consider different elements of  $N_{Aut(F_n)}(G)$ .

**Proof.** Define  $N'_{Aut(F_n)}(G)$  to be the set of all equivalence classes of pairs  $(\phi, \psi)$  where  $\phi \in Aut(G)$  and  $\psi : \Gamma \rightarrow \Gamma$  is a basepoint preserving, continuous surjection of graphs such that

$$\psi_{\#} : \pi_1(\Gamma, *) \rightarrow \pi_1(\phi(\Gamma), *)$$

is a  $G$ -equivariant group isomorphism. Two such pairs  $(\phi_1, \psi_1)$  and  $(\phi_2, \psi_2)$  are equivalent if  $\phi_1 = \phi_2$  and

$$(\psi_1)_{\#} = (\psi_2)_{\#} : \pi_1(\Gamma, *) \rightarrow \pi_1(\phi(\Gamma), *)$$



on the level of fundamental groups.

Define a group operation *composition* in  $N'_{Aut(F_n)}(G)$  in the obvious way by letting

$$(\phi_2, \psi_2) \circ (\phi_1, \psi_1) = (\phi_2 \circ \phi_1, \psi_2 \circ \psi_1).$$

To prove the proposition, it suffices to show that there is a group isomorphism

$$\xi : N_{Aut(F_n)}(G) \rightarrow N'_{Aut(F_n)}(G).$$

Choose a fixed homotopy inverse  $\bar{\eta} : \Gamma \rightarrow R_n$ ; i.e., a map such that

$$(\eta\bar{\eta})_{\#} = 1 \in Aut(\pi_1(\Gamma))$$

and

$$(\bar{\eta}\eta)_{\#} = 1 \in Aut(\pi_1(R_n)).$$

1. In this step, we define the map  $\xi$  and show that it is a well defined map between sets. (We delay showing that is a well defined map between groups, i.e. a homomorphism, until step 3.)

If  $\alpha \in N_{Aut(F_n)}(G)$ , then  $\alpha$  induces an automorphism  $\phi$  of  $G$  via conjugation:  $\phi(g) = \alpha g \alpha^{-1}$ . In addition, since  $\alpha \in Aut(F_n)$  it corresponds to a map  $\tilde{\alpha} : R_n \rightarrow R_n$  which gives a marked graph  $\alpha\eta$  by precomposition:

$$R_n \xrightarrow{\tilde{\alpha}} R_n \xrightarrow{\eta} \Gamma.$$

Similarly,  $\alpha$  induces a map  $\psi = \eta\tilde{\alpha}\bar{\eta}$ :

$$\Gamma \xrightarrow{\bar{\eta}} R_n \xrightarrow{\tilde{\alpha}} R_n \xrightarrow{\eta} \Gamma$$

which in turn gives a map

$$\psi_{\#} : \pi_1(\Gamma, *) \rightarrow \pi_1(\Gamma, *).$$

It remains to show that  $\psi_{\#}$  is an equivariant map in the suitable sense. Now for any  $x \in \pi_1(\Gamma, *)$  and  $g \in G$ ,

$$\begin{aligned} \psi_{\#}(gx) &= (\psi_{\#}g\psi_{\#}^{-1})\psi_{\#}(x) \\ &= (\eta\tilde{\alpha}g\tilde{\alpha}^{-1}\bar{\eta})_{\#}\psi_{\#}(x) \\ &= (\eta\phi(g)\bar{\eta})_{\#}\psi_{\#}(x) \\ &= \phi(g)\psi_{\#}(x). \end{aligned}$$

At the risk of being overly pedantic, we explain the above equalities in detail. Both the first and third equalities are trivial. For the second equality, one can reason as follows. As  $\Gamma$  is a  $G$ -graph, one at first thinks of  $g$  as a map from  $\Gamma$  to  $\Gamma$ . If one wants to translate this to thinking of  $g$  as an element of  $Aut(F_n)$  realized on the rose, one forms

$$R_n \xrightarrow{\eta} \Gamma \xrightarrow{g} \Gamma \xrightarrow{\bar{\eta}} R_n.$$

We know that this is the correct way to think of  $g$  as realized on the rose, because if we precompose the marked graph  $(\eta, \Gamma)$  with the above element then we get  $(\eta g \bar{\eta})(\eta) = \eta g$ , or the result of the graph automorphism  $g$  acting on the marked graph. So

$$\begin{aligned} (\psi_{\#}g\psi_{\#}^{-1}) &= (\psi g \psi^{-1})_{\#} \\ &= (\eta\tilde{\alpha}\bar{\eta}g\eta\tilde{\alpha}^{-1}\bar{\eta})_{\#} \\ &= (\eta\tilde{\alpha}g\tilde{\alpha}^{-1}\bar{\eta})_{\#}. \end{aligned}$$

This justifies the second equality.

For the fourth equality, note that

$$R_n \xrightarrow{\phi(g)} R_n \xrightarrow{\eta} \Gamma$$

is the same as

$$R_n \xrightarrow{\eta} \Gamma \xrightarrow{\phi(g)} \Gamma$$

where in the first case  $\phi(g) \in G$  is thought of as an element of  $\text{Aut}(F_n)$  realized on the rose and in the second case  $\phi(g) \in G$  is thought of as giving a graph automorphism of the  $G$ -graph  $\Gamma$ .

Thus we have shown that if we think of the map  $\psi_{\#}$  as

$$\psi_{\#} : \pi_1(\Gamma, *) \rightarrow \pi_1(\Gamma, *)$$

then  $\psi_{\#}(gx) = \phi(g)\psi_{\#}(x)$ . So if instead we think of  $\psi_{\#}$  as a map

$$\psi_{\#} : \pi_1(\Gamma, *) \rightarrow \pi_1(\phi(\Gamma), *)$$

then it is  $G$ -equivariant.

2. In this step, we define a set-theoretic inverse map

$$\xi^{-1} : N'_{\text{Aut}(F_n)}(G) \rightarrow N_{\text{Aut}(F_n)}(G).$$

Now suppose we are given a pair  $(\phi, \psi)$ . Then  $\psi$  gives us an element  $\tilde{\alpha} : R_n \rightarrow R_n$  via  $\bar{\eta}\psi\eta$ :

$$R_n \xrightarrow{\eta} \Gamma \xrightarrow{\psi} \Gamma \xrightarrow{\bar{\eta}} R_n.$$

The element  $\tilde{\alpha}$  induces a map  $\alpha \in \text{Aut}(F_n)$ .

Recall that the the map

$$\psi_{\#} : \pi_1(\Gamma, *) \rightarrow \pi_1(\phi(\Gamma), *)$$

is  $G$ -equivariant. If we instead think of it as a map

$$\psi_{\#} : \pi_1(\Gamma, *) \rightarrow \pi_1(\Gamma, *)$$

then

$$\psi_{\#}(gx) = \phi(g)\psi_{\#}(x)$$

for all  $g \in G$  and  $x \in \pi_1(\Gamma, *)$ . So

$$gx = \psi_{\#}^{-1}\phi(g)\psi_{\#}(x)$$

for all  $x \in \pi_1(\Gamma, *)$ . Now similar arguments to those used in 1. yield that  $g = \alpha^{-1}\phi(g)\alpha$ . Consequently

$$\alpha g \alpha^{-1} = \phi(g) \in G$$

for all  $g \in G$ . This implies that  $\alpha \in N_{\text{Aut}(F_n)}(G)$ .

That the map we are calling  $\xi^{-1}$  actually is a set-theoretic inverse to  $\xi$  can easily be verified by looking at their definitions. For example, if  $(\phi, \psi) \in N'_{\text{Aut}(F_n)}(G)$  then

$$\begin{aligned} \xi(\xi^{-1}(\phi, \psi)) &= \xi((\bar{\eta}\psi\eta)_{\#}) \\ &= (g \mapsto (\bar{\eta}\psi\eta)_{\#}g(\bar{\eta}\psi\eta)_{\#}^{-1}, \eta(\bar{\eta}\psi\eta)\bar{\eta}) \\ &= (g \mapsto \phi(g), \psi). \end{aligned}$$

Hence  $\xi\xi^{-1} = 1$ . The equality  $\xi^{-1}\xi = 1$  can be shown similarly.

3. Finally, note that  $\xi$  as defined is clearly a group homomorphism because

$$\begin{aligned}\xi(\alpha_2) \circ \xi(\alpha_1) &= (g \mapsto \alpha_2 g \alpha_2^{-1}, \eta \tilde{\alpha}_2 \bar{\eta}) \circ (g \mapsto \alpha_1 g \alpha_1^{-1}, \eta \tilde{\alpha}_1 \bar{\eta}) \\ &= (g \mapsto (\alpha_2 \circ \alpha_1) g (\alpha_2 \circ \alpha_1)^{-1}, \eta \tilde{\alpha}_2 \circ \tilde{\alpha}_1 \bar{\eta}) \\ &= \xi(\alpha_2 \circ \alpha_1). \square\end{aligned}$$

As a result of Proposition 3.4, we obtain the following:

**Proposition 3.5** *An element of  $N_{Aut(F_n)}(G)$  is a product of Nielsen transformations followed by a normalizing graph isomorphism.*

**Proof.** Any element  $(\phi, \psi)$  of  $N'_{Aut(F_n)}(G)$  induces a  $G$ -equivariant map

$$\pi_1(\Gamma, *) \xrightarrow{\psi_{\#}} \pi_1(\phi(\Gamma), *).$$

From Corollary 3.3,  $\psi_{\#}$  is the restriction of a  $G$ -equivariant map  $F$  between fundamental groupoids:

$$\Pi(\Gamma) \xrightarrow{F} \Pi(\phi(\Gamma)).$$

Now from Proposition 3.2 we know that there exists a product  $T$  of Nielsen transformations starting with the graph  $\Gamma$ , and a basepoint preserving graph isomorphism  $H : T\Gamma \rightarrow \phi(\Gamma)$  such that  $F$  is the map induced by  $HT$ :

$$F : \Pi(\Gamma) \xrightarrow{T} \Pi(T\Gamma) \xrightarrow{H} \Pi(\phi(\Gamma)).$$

By restricting the above map of fundamental groupoids to one of fundamental groups, we have that  $\psi_{\#}$  is also the map induced by  $HT$ :

$$\psi_{\#} : \pi_1(\Gamma, *) \xrightarrow{T} \pi_1(T\Gamma, *) \xrightarrow{H} \pi_1(\phi(\Gamma), *).$$

It is in the above sense that we mean an element of  $N_{Aut(F_n)}(G)$  is a product of Nielsen transformations followed by a normalizing graph isomorphism.  $\square$

We now use Proposition 3.5 to calculate the normalizers of the subgroups  $A$ ,  $B_0, \dots, B_{p-1}$ ,  $D$ , and  $E$  listed in Proposition 2.7. We do this so that their cohomology groups will be easier to calculate in a later chapter. We will not need to calculate the normalizer of  $C$  in this explicit manner, and later will find its cohomology through more geometric means.

**Lemma 3.6**

$$N_{Aut(F_n)}(A) \cong N_{\Sigma_p}(\mathbb{Z}/p) \times ((F_{p-2} \times F_{p-2}) \rtimes (\mathbb{Z}/2 \times Aut(F_{p-2})))$$

where  $\mathbb{Z}/2$  acts by exchanging the two copies of  $F_{p-2}$  and  $Aut(F_{p-2})$  acts diagonally on the two copies of  $F_{p-2}$ .

**Proof.** Recall that  $A$  comes from the action of  $\mathbb{Z}/p$  on the first  $p$  petals of the rose  $R_{2(p-1)}$ . From Proposition 3.5 any element of  $N_{Aut(F_n)}(A)$  is induced by a product of Nielsen transformations  $T$  followed by a graph isomorphism

$$H : TR_{2(p-1)} \rightarrow \phi(R_{2(p-1)})$$

for some  $\phi \in Aut(A)$ . The only types of Nielsen transformations that are possible are

- Nielsen transformations obtained by pulling either the front ends or the back ends of the first  $p$  petals of the rose uniformly around paths in the last  $p - 2$  petals. This subgroup is isomorphic to  $F_{p-2} \times F_{p-2}$ . The first copy of  $F_{p-2}$

comes from pulling the front ends of the first  $p$  petals, and the second copy comes from pulling the back ends of the first  $p$  petals.

- Nielsen transformations involving just the last  $p-2$  petals of the rose. In other words, Nielsen transformations contained entirely in the copy of  $Aut(F_{p-2})$  corresponding to graph automorphisms and Nielsen transformations involving the last  $p-2$  petals.

Note that for a single Nielsen transformation  $T$  in either of the above cases, the  $A$ -graph  $TR_{2(p-1)}$  is exactly the same as the  $A$ -graph  $R_{2(p-1)}$ . It follows that for any product of Nielsen transformations  $T$  the  $A$ -graph  $TR_{2(p-1)}$  is exactly the same as the  $A$ -graph  $R_{2(p-1)}$  (although, of course, the product of Nielsen isomorphisms induced by the product of Nielsen transformations will probably not be trivial.) Hence from Proposition 3.5, we know that any element of  $N_{Aut(F_n)}(A)$  is induced by a product of Nielsen transformations  $T$  followed by a graph isomorphism

$$H : TR_{2(p-1)} = R_{2(p-1)} \rightarrow \phi(R_{2(p-1)})$$

for some  $\phi \in Aut(A)$ . Thus the only “normalizing graph isomorphisms” that we need to consider are ones which go from  $R_{2(p-1)}$  to  $\phi(R_{2(p-1)})$  for some  $\phi \in Aut(A)$ . In other words, we need only examine automorphisms of one particular graph  $R_{2(p-1)}$  and see which are in the normalizer  $N_{Aut(F_n)}(A)$ .

The normalizing graph automorphisms are:

- Those involving just the last  $p-2$  petals of the rose. As the action of  $A$  on these petals is trivial, the normalizer of  $A$  contains any graph automorphism

involving just those last  $p - 2$  petals. All of these graph automorphisms are contained in the copy of  $Aut(F_{p-2})$  obtained from graph automorphisms and Nielsen transformations involving the last  $p - 2$  petals.

- Normalizing graph automorphisms of the first  $p$  petals of the rose. This gives a subgroup of  $N_{Aut(F_n)}(A)$  that is isomorphic to  $(\mathbb{Z}/p \rtimes \mathbb{Z}/(p-1)) \times \mathbb{Z}/2$  where the  $\mathbb{Z}/2$  comes from inverting all of the  $p$ -petals at the same time, and

$$(\mathbb{Z}/p \rtimes \mathbb{Z}/(p-1)) \cong N_{\Sigma_p}(\mathbb{Z}/p) = N_{\Sigma_p}((12 \dots p)).$$

In other words, the generator of  $\mathbb{Z}/(p-1)$  acts on the generator of  $\mathbb{Z}/p$  by conjugating it to its  $s$ -th power for some generator  $s$  of  $\mathbb{F}_p^\times$  and

$$N_{\Sigma_p}(\mathbb{Z}/p) \cong \langle g, h | g^p = 1, h^{p-1} = 1, hgh^{-1} = g^s \rangle$$

where  $s$  is a primitive root modulo  $p$ .

We can verify in a very concrete “nuts and bolts” manner that the normalizing graph automorphisms of the first  $p$  petals of the rose take the above form. We do this now for the sake of providing at least one concrete example.

The full automorphism group of the first  $p$  petals is

$$(\mathbb{Z}/2)^p \rtimes \Sigma_p$$

where  $\Sigma_p$  acts on  $(\mathbb{Z}/2)^p$  by permuting the  $p$  copies of  $\mathbb{Z}/2$ . Each of the  $p$  copies of  $\mathbb{Z}/2$  corresponds to flipping one of the first  $p$  petals of the rose. The  $\Sigma_p$  corresponds to permuting the first  $p$  petals of the rose among themselves. The subgroup  $A$  corresponds to the subgroup generated by the permutation



$(12 \dots p)$  in  $\Sigma_p$  and rotates the first  $p$  petals sequentially. We must see which elements of

$$(\mathbb{Z}/2)^p \rtimes \Sigma_p$$

are in the normalizer of  $A$ . Say that the element

$$(a_1, \dots, a_p) \cdot b$$

is in the normalizer, where  $(a_1, \dots, a_p) \in (\mathbb{Z}/2)^p$  and  $b \in \Sigma_p$ . Then

$$(a_1, \dots, a_p) \cdot b \cdot (12 \dots p) \cdot b^{-1} \cdot (a_1, \dots, a_p) = (12 \dots p)^r$$

for some  $r \in \{0, 1, \dots, p-1\}$ . Now

$$b \cdot (12 \dots p) \cdot b^{-1}$$

is a permutation of order  $p$  in  $\Sigma_p$  and so has the form

$$(c_1 c_2 \dots c_p)$$

where the integers  $c_i$  are all distinct. Accordingly,

$$(a_1, \dots, a_p) \cdot (c_1 c_2 \dots c_p) \cdot (a_1, \dots, a_p) = (12 \dots p)^r.$$

Recall that each  $a_i \in \mathbb{Z}/2$ . We want to show that if some  $a_j = 1$  then all of the  $a_i$  are 1. Now if  $a_j = 1$ , the graph automorphism

$$(a_1, \dots, a_p) \cdot (c_1 c_2 \dots c_p) \cdot (a_1, \dots, a_p)$$

first flips the  $j$ th petal, then sends that flipped petal to the  $(c_1 c_2 \dots c_p)j$  petal, and then finally flips that last petal back. It must end by flipping

the  $(c_1c_2 \dots c_p)j$  petal back because the graph automorphism  $(12 \dots p)^r$  does not flip any petals. So  $a_{(c_1c_2 \dots c_p)j}$  is also equal to 1. We then iterate the above reasoning to get that  $a_{(c_1c_2 \dots c_p)^2j}$  equals 1, etc. Hence if some  $a_j = 1$  then all of the  $a_i$  are 1. In other words,

$$a_1 = a_2 = \dots = a_p.$$

It now follows that

$$(a_1, \dots, a_p) \cdot (c_1c_2 \dots c_p) \cdot (a_1, \dots, a_p) = (c_1c_2 \dots c_p)$$

and so

$$b \cdot (12 \dots p) \cdot b^{-1} = (12 \dots p)^r.$$

Thus  $b$  is in  $N_{\Sigma_p}((12 \dots p))$  which is (see, for example, [4] page 68)

$$\langle g, h | g^p = 1, h^{p-1} = 1, hgh^{-1} = g^s \rangle.$$

Hence the normalizing graph automorphisms of the first  $p$  petals form a subgroup of  $N_{Aut(F_n)}(A)$  which is isomorphic to

$$(\mathbb{Z}/p \times \mathbb{Z}/(p-1)) \times \mathbb{Z}/2$$

as we claimed.

Putting all of this together, we see that

$$N_{Aut(F_n)}(A) \cong N_{\Sigma_p}(\mathbb{Z}/p) \times ((F_{p-2} \times F_{p-2}) \rtimes (\mathbb{Z}/2 \times Aut(F_{p-2})))$$

where  $\mathbb{Z}/2$  acts by exchanging the two copies of  $F_{p-2}$  and  $Aut(F_{p-2})$  acts diagonally on the two copies of  $F_{p-2}$ . The  $(F_{p-2} \times F_{p-2})$  corresponds to Nielsen transformations

obtained by pulling the front or back ends of the first  $p$  petals uniformly around some path in the last  $p - 2$  petals; the  $\mathbb{Z}/2$  corresponds to flipping all of the first  $p$  petals over at the same time; and the  $Aut(F_{p-2})$  corresponds to Nielsen transformations and graph automorphisms involving the last  $p - 2$  petals. We leave it as an exercise for the reader to show that the various subgroups of  $N_{Aut(F_n)}(A)$  fit together as described above.  $\square$

A final remark about the structure of the subgroup  $N_{Aut(F_n)}(A)$ , described above in the proof of Lemma 3.6, is appropriate here:

**Remark 3.7** *Consider a subgroup  $\langle \omega \rangle \cong \mathbb{Z}/2$  of  $Aut(F_p)$  corresponding to the action of  $\mathbb{Z}/2$  on  $R_p$  given by switching the just the first two petals of the rose. Note that*

$$N_{Aut(F_p)}(\omega) = C_{Aut(F_p)}(\omega) = \mathbb{Z}/2 \times ((F_{p-2} \times F_{p-2}) \rtimes (\mathbb{Z}/2 \times Aut(F_{p-2})))$$

where the action of  $\mathbb{Z}/2 \times Aut(F_{p-2})$  on  $F_{p-2} \times F_{p-2}$  in the semidirect product is the same as before (that is, as in  $N_{Aut(F_n)}(A)$ .) Consequently, we see that

$$N_{\Sigma_p}(\mathbb{Z}/p) \times N_{Aut(F_p)}(\omega) \cong \mathbb{Z}/2 \times N_{Aut(F_n)}(A)$$

and hence

$$\hat{H}^*(N_{\Sigma_p}(\mathbb{Z}/p) \times N_{Aut(F_p)}(\omega); \mathbb{Z}_{(p)}) = \hat{H}^*(N_{Aut(F_n)}(A); \mathbb{Z}_{(p)})$$

because  $p \geq 3$  and so the first summand  $\mathbb{Z}/2$  in  $\mathbb{Z}/2 \times N_{Aut(F_n)}(A)$  can be ignored when taking Farrell cohomology with  $\mathbb{Z}_{(p)}$  coefficients.

**Lemma 3.8**

$$N_{Aut(F_n)}(B_k) \cong N_{\Sigma_p}(\mathbb{Z}/p) \times (F_k \rtimes Aut(F_k)) \times Aut(F_{p-1-k})$$

**Proof.** Recall that  $B_k$  comes from the action of  $\mathbb{Z}/p$  on the  $\Theta$ -graph in  $R_k \vee \Theta_{p-1} \vee R_{p-1-k}$ . For just this proof, denote the middle  $p$  edges of the  $\Theta$  graph by  $e_1, \dots, e_p$ , the  $k$  petals of the rose  $R_k$  by  $f_1, \dots, f_k$ , and the  $p-1-k$  petals of the rose  $R_{p-1-k}$  by  $g_1, \dots, g_{p-1-k}$ . Say that the edges  $e_i$  are oriented such that they go from the rose  $R_{p-1-k}$  to the rose  $R_k$ . Also, just for this proof, let  $\Gamma$  denote the  $B_k$ -graph  $R_k \vee \Theta_{p-1} \vee R_{p-1-k}$ .

The normalizer  $N_{Aut(F_n)}(B_k)$  contains four types of Nielsen transformations:

- Ones obtained from Nielsen transformations involving just the  $k$  petals of the rose  $R_k$ . As the action of  $B_k$  on this rose is trivial, any Nielsen transformation of those petals is admissible. These are all contained in a subgroup  $Aut(F_k)$  of the normalizer obtained from taking graph automorphisms and Nielsen transformations of the rose  $R_k$ .
- Ones obtained from Nielsen transformations involving just the  $p-1-k$  petals of the rose  $R_{p-1-k}$ . The action of  $B_k$  on this rose is trivial. These Nielsen transformations are all contained in a subgroup  $Aut(F_{p-1-k})$  of the normalizer obtained from taking graph automorphisms and Nielsen transformations of the rose  $R_{p-1-k}$ .
- Nielsen transformations obtained by pulling the back edges of the  $\Theta$ -graph uniformly around the  $p-1-k$  petals of the rose  $R_{p-1-k}$  on the right. Note

that the Nielsen transformations around the last  $p - 1 - k$  petals induce maps that are similar to conjugation maps of the last  $p - 1 - k$  petals of the rose, on the level of fundamental groups

$$\pi_1(R_k \vee \Theta_{p-1} \vee R_{p-1-k}, *) \rightarrow \pi_1(R_k \vee \Theta_{p-1} \vee R_{p-1-k}, *).$$

That is, if we pull the back ends of all of the  $e_i$  uniformly around some  $g_j$ , then on fundamental groups the result is:

1. The loops  $\bar{e}_{i_1}e_{i_2}$  are all sent back to themselves, for  $i_1, i_2 \in \{1, \dots, p\}$ .

This is because  $\bar{e}_{i_1}e_{i_2}$  is sent to the loop  $(\bar{e}_{i_1}g_j)(\bar{g}_je_{i_2}) = \bar{e}_{i_1}e_{i_2}$ .

2. The loops  $f_i$  are all sent back to themselves.

3. The loops  $\bar{e}_r g_i e_s$  are sent to  $\bar{e}_r g_j g_i \bar{g}_j e_s$  for all  $r, s \in \{1, \dots, p\}$ ,  $i \in \{1, \dots, p - 1 - k\}$ . In other words, paths in the rose  $R_{p-1-k}$  are “conjugated” by  $g_j$ , where the word conjugated is in quotes because we have first to get to the path in the rose  $R_{p-1-k}$  by travelling along some  $\bar{e}_r$  and we have to leave the the path in the rose by travelling back along some  $e_s$ .

We can thus disregard these Nielsen transformations as they are already included in the Nielsen transformations involving just the rose  $R_{p-1-k}$ , which was covered in the previous case.

- Nielsen transformations obtained by pulling the front edges of the  $\Theta$ -graph uniformly around the  $k$  petals of the rose  $R_k$  on the left. Say we perform the Nielsen transformation given by pulling the front ends of all of the  $e_i$  around

the edge  $f_j$ . Then the resulting graph is the same as the one we started with, but the Nielsen isomorphism on fundamental groupoids sends

$$\begin{aligned} e_i &\mapsto e_i f_j && \text{for } i \in \{1, \dots, p\} \\ f_i &\mapsto f_i && \text{for } i \in \{1, \dots, k\} \\ g_i &\mapsto g_i && \text{for } i \in \{1, \dots, p-1-k\} \end{aligned}$$

On the level of fundamental groups, this has the result of conjugating paths that start with some  $\bar{e}_{i_1}$  and end with some  $e_{i_2}$ , by the letter  $f_j$ . Direct examination reveals that none of the Nielsen transformations covered in the previous cases do this. We could also take the inverse  $\langle e_1, \bar{f}_j \rangle$  of the above Nielsen transformation, namely pull the edges  $e_i$  uniformly around some edge  $\bar{f}_j$ . This would have the result of conjugating paths that start with some  $\bar{e}_{i_1}$  and end with some  $e_{i_2}$ , by the letter  $\bar{f}_j$ . Hence all of these Nielsen transformations form a subgroup of the normalizer that is isomorphic to  $F_k$ , where the  $j$ th generator of the free group  $F_k$  corresponds to the Nielsen transformation  $\langle e_1, f_j \rangle$ . Moreover, this subgroup  $F_k$  is acted upon by the subgroup  $Aut(F_k)$  of  $N_{Aut(F_n)}(B_k)$  corresponding to graph automorphisms and Nielsen transformations of the first  $k$  petals. You can see this by noting how the subgroup  $Aut(F_k)$  affects the above conjugation maps. Also note that the subgroup  $Aut(F_{p-1-k})$  of  $N_{Aut(F_n)}(B_k)$ , corresponding to graph automorphisms and Nielsen transformations of the last  $p-1-k$  petals, commutes with the above Nielsen transformations.

As was the case for Lemma 3.6 above, for any product  $T$  of any of the above types of Nielsen transformations, the  $B_k$ -graph  $T\Gamma$  is exactly the same as the  $B_k$ -

graph  $\Gamma$  (although, again, the product of Nielsen isomorphisms induced by the product of Nielsen transformations will probably not be trivial.) From Proposition 3.5, we know that any element of  $N_{Aut(F_n)}(B_k)$  is induced by a product of Nielsen transformations  $T$  followed by a graph isomorphism

$$H : T\Gamma = \Gamma \rightarrow \phi(\Gamma)$$

for some  $\phi \in Aut(B_k)$ . The only “normalizing graph isomorphisms” that we need to consider are ones which go from  $\Gamma$  to  $\phi(\Gamma)$  for some  $\phi \in Aut(B_k)$ .

The normalizing graph automorphisms take one of three forms:

- Those automorphisms involved only with the petals of the rose  $R_k$ . These are contained in the subgroup  $Aut(F_k)$  obtained from graph automorphisms and Nielsen transformations involving just the rose  $R_k$ .
- Those automorphisms involved only with the petals of the rose  $R_{p-1-k}$ . These are contained in the subgroup  $Aut(F_{p-1-k})$  obtained from graph automorphisms and Nielsen transformations involving just the rose  $R_{p-1-k}$ .
- Normalizing graph automorphisms of the  $p$  edges  $e_i$  in  $\Theta_{p-1}$ . A graph automorphism can only permute the edges  $e_i$  among themselves (and can not, of course, flip them over because of where the basepoint is located.) Hence we can identify the graph automorphisms which move the edges  $e_i$  with the symmetric group  $\Sigma_p$ . The group  $B_k$  corresponds to the subgroup of  $\Sigma_p$  generated by the permutation  $(12\dots p)$ . In addition, the graph automorphisms of  $\Sigma_p$  which are normalizing are exactly those which are in the normalizer of the

subgroup generated by  $(12 \dots p)$ . This gives a subgroup of  $N_{Aut(F_n)}(B_k)$  that is isomorphic to

$$(\mathbb{Z}/p \rtimes \mathbb{Z}/(p-1)) \cong N_{\Sigma_p}(\mathbb{Z}/p).$$

Putting all of this together, it is not a difficult exercise for the reader to verify that

$$N_{Aut(F_n)}(B_k) \cong N_{\Sigma_p}(\mathbb{Z}/p) \times (F_k \rtimes Aut(F_k)) \times Aut(F_{p-1-k}).$$

We have already remarked that  $Aut(F_k)$  acts on  $F_k$  as described and that  $Aut(F_{p-1-k})$  commutes with  $F_k$ . Moreover, the subgroup  $Aut(F_k)$  commutes with  $Aut(F_{p-1-k})$  as the relevant Nielsen transformations and graph automorphisms of the two groups have nothing to do with each other. Finally, the subgroup

$$(F_k \rtimes Aut(F_k)) \times Aut(F_{p-1-k})$$

commutes with  $N_{\Sigma_p}(\mathbb{Z}/p)$  for two reasons. First, all of the Nielsen transformations in

$$(F_k \rtimes Aut(F_k)) \times Aut(F_{p-1-k})$$

commute with  $N_{\Sigma_p}(\mathbb{Z}/p)$  because if any one of these Nielsen transformations moved some edge  $e_j$  then it did this by pulling all of the edges  $e_i$  (which are what the subgroup  $N_{\Sigma_p}(\mathbb{Z}/p)$  permutes) uniformly together around some path. Second, it is clear that graph automorphisms of the  $\Theta$  graph in the middle of  $\Gamma$  commute with graph automorphisms of either rose in  $\Gamma$ .  $\square$

**Lemma 3.9**

$$N_{Aut(F_n)}(D) = N_{\Sigma_p}(\mathbb{Z}/p) \times N_{\Sigma_p}(\mathbb{Z}/p).$$



$$N_{\text{Aut}(F_n)}(E) = (N_{\Sigma_p}(\mathbb{Z}/p) \times N_{\Sigma_p}(\mathbb{Z}/p)) \rtimes \mathbb{Z}/2.$$

**Proof.** The groups  $N_{\text{Aut}(F_n)}(D)$  and  $N_{\text{Aut}(F_n)}(E)$  are the easiest to calculate of all of the normalizers. There are no admissible Nielsen transformations of the reduced  $(\mathbb{Z}/p \times \mathbb{Z}/p)$ -graphs  $\Omega_n$  or  $\Psi_n$ . It follows that  $N_{\text{Aut}(F_n)}(D)$  and  $N_{\text{Aut}(F_n)}(E)$  are just finite groups consisting of normalizing graph automorphisms of  $\Omega_n$  and  $\Psi_n$ , respectively. So we need only examine the graphs  $\Omega_n$  or  $\Psi_n$  and see which graph automorphisms are in the normalizers of the respective  $(\mathbb{Z}/p \times \mathbb{Z}/p)$ -actions.

We will do this for  $E \cong \mathbb{Z}/p \times \mathbb{Z}/p$  acting on  $\Psi_n$ . (The argument for  $D$  acting on  $\Omega_n$  is similar.) The automorphism group of the graph  $\Psi_n$  is

$$(\Sigma_p \times \Sigma_p) \rtimes \mathbb{Z}/2$$

where the first  $\Sigma_p$  corresponds to permuting the edges of first  $\Theta$ -graph in  $\Psi_n$ , the second  $\Sigma_p$  corresponds to permuting the edges of the second  $\Theta$ -graph, and the  $\mathbb{Z}/2$  corresponds to flipping the graph over and thus exchanging the two  $\Theta$ -graphs. Now  $E \cong \mathbb{Z}/p \times \mathbb{Z}/p$  and the  $E$ -action on the graph is given by the first  $\mathbb{Z}/p$  rotating the  $p$  edges of the first  $\Theta$ -graph while the latter  $\mathbb{Z}/p$  rotates the  $p$ -edges of the latter  $\Theta$ -graph. Hence we need only compute the normalizer of

$$\mathbb{Z}/p \times \mathbb{Z}/p \subset (\Sigma_p \times \Sigma_p) \rtimes \mathbb{Z}/2.$$

The subgroup

$$N_{\Sigma_p}(\mathbb{Z}/p) \times N_{\Sigma_p}(\mathbb{Z}/p)$$

is clearly in the normalizer.

Moreover, the flip  $\mathbb{Z}/2$  is also in the normalizer because if

$$(a, b) \in \mathbb{Z}/p \times \mathbb{Z}/p \cong E$$

and  $c$  is the flip in  $\mathbb{Z}/2$  then

$$c \cdot (a, b) \cdot c^{-1} = (b, a) \in \mathbb{Z}/p \times \mathbb{Z}/p \cong E.$$

Further examination reveals that these are the only normalizing graph automorphisms, so that

$$N_{Aut(F_n)}(E) = (N_{\Sigma_p}(\mathbb{Z}/p) \times N_{\Sigma_p}(\mathbb{Z}/p)) \rtimes \mathbb{Z}/2. \square$$

## Chapter 4

# The normalizers, their fixed point sets, and related fixed point sets

Let  $G$  be a finite subgroup of  $Aut(F_n)$ , realized by a reduced graph  $\Gamma$  as in the previous chapter. Define the *fixed point subcomplex*  $X_n^G$  of  $G$  in the spine  $X_n$  of outer space by

$$X_n^G = \{x \in X_n : xg = x \text{ for all } g \in G\}.$$

The normalizer  $N_{Aut(F_n)}(G)$  acts on the fixed point set  $X_n^G$  since if  $n \in N_{Aut(F_n)}(G)$  and  $x \in X_n^G$  then for all  $g \in G$ ,

$$(xn)g = (xngn^{-1})n = xn.$$

We will delay proving some of the more difficult results that we need in this chapter until Part III. For now, we will just state the results that we need as facts.

**Fact 4.1** *The space  $X_n^G$  is a contractible, finite-dimensional complex and*

*$N_{Aut(F_n)}(G)$  acts on it with finite quotient and finite stabilizers.*

Note that the poset structure on  $X_n$  is such that a simplex  $\delta$  in  $X_n$  is fixed by  $G$  if and only if it is fixed pointwise. The space  $X_n^G$  is finite dimensional since  $X_n$  is finite dimensional by [14]. That the normalizer acts on the space with finite quotient and finite stabilizers follows from work by Krstic and Vogtmann in [19]. Theorem 12.1 in Part III proves that  $X_n^G$  is contractible.

A few spaces related to fixed point subcomplexes will come up so frequently in our work that we will give them special names,  $X_p^\omega$ ,  $Q_p^\omega$ ,  $\tilde{X}_m$ , and  $\tilde{Q}_m$ . We now define these spaces.

Recall from Krstic and Vogtmann [19] that an edge of a reduced  $G$ -graph  $\Gamma$  is *inessential* if it is contained in every maximal  $G$ -invariant forest in  $\Gamma$ , and that there is an  $N_{Aut(F_p)}(G)$ -equivariant deformation retract of  $X_n^G$  obtained by collapsing all inessential edges of marked graphs in  $X_n^G$ .

**Definition 4.2** ( $X_p^\omega$  and  $Q_p^\omega$ ) *Let  $\omega$  be the automorphism of  $F_p$  defined by interchanging the first two basis elements of  $F_p$  (cf. Remark 3.7), and let  $X_p^{(\omega)}$  be the subcomplex of  $X_p$  fixed by the subgroup  $\langle \omega \rangle \cong \mathbb{Z}/2$ . Define  $X_p^\omega$  to be the associated  $N_{Aut(F_p)}(\omega)$ -equivariant deformation retract of  $X_p^{(\omega)}$  and let  $Q_p^\omega$  be the quotient of  $X_p^\omega$  by the action of  $N_{Aut(F_p)}(\omega)$ .*

In Part III of this paper we will show (Remark 12.16) that

$$\dim(X_p^\omega) = \dim(Q_p^\omega) = 2p - 4.$$

We will use  $X_p^\omega$  to study the cohomology of the normalizer of  $A$ . In order to do this, we need to define an action of  $N_{Aut(F_n)}(A)$  on  $X_p^\omega$ . Recall from Remark 3.7

that

$$N_{\Sigma_p}(\mathbb{Z}/p) \times N_{\text{Aut}(F_p)}(\omega) \cong \langle \omega \rangle \times N_{\text{Aut}(F_n)}(A).$$

The rest of this chapter will be devoted to defining the space  $\tilde{X}_m$ , finding an alternative characterization of this space, and explaining how the space relates to the normalizer  $N_{\text{Aut}(F_n)}(B_m)$ .

**Definition 4.3** ( $\tilde{X}_m$  and  $\tilde{Q}_m$ ) *Let  $m$  be a positive integer. Let  $\alpha$  be the automorphism of  $F_{m+2}$  defined by:*

$$\begin{cases} x_i \mapsto x_i \text{ for } i \leq m, \\ x_{m+1} \mapsto x_{m+2} \\ x_{m+2} \mapsto x_{m+2}^{-1}x_{m+1}^{-1}. \end{cases}$$

*The subgroup  $\mathcal{Q}$  generated by  $\alpha$  has order 3, and is realized on the graph  $R_m \vee \Theta_2$  by rotating the edges of  $\Theta_2$  cyclically. Define  $\tilde{X}_m$  to be the fixed point set  $X_{m+2}^{\mathcal{Q}}$ , and let  $\tilde{Q}_m$  be the quotient of  $\tilde{X}_m$  by  $N_{\text{Aut}(F_{m+2})}(\mathcal{Q})$ .*

*For  $m = 0$ , we set  $\tilde{X}_0 = \tilde{Q}_0 = \{a \text{ point}\}$  as a notational convenience.*

Let  $\tilde{\Gamma}$  be the graph  $R_m \vee \Theta_2$ , where the basepoint of the resulting graph  $\tilde{\Gamma}$  is the center of the rose  $R_m$ . Label the 3 edges of the  $\Theta$ -graph in  $\tilde{\Gamma}$  as  $e_1, e_2, e_3$  and orient them so that they begin at the basepoint of  $\tilde{\Gamma}$ . Construct a specific marked graph

$$\tilde{\eta} : R_{m+2} = R_m \vee R_2 \rightarrow R_m \vee \Theta_{p-1}$$

by sending the first rose  $R_m$  in  $R_m \vee R_2$  to  $R_m$  in  $R_m \vee \Theta_2$  via the identity map. Then send the second rose  $R_2$  in  $R_m \vee R_2$  to  $\Theta_2$  in  $R_m \vee \Theta_2$  by sending the  $i$ th petal to  $e_i * \bar{e}_{i+1}$ . As noted above in Definition 4.3, the subgroup  $\mathcal{Q}$  acts on this marked graph by rotating the edges of  $\Theta_2$  cyclically.

We will now study the structure of  $\tilde{X}_m$  and  $\tilde{Q}_m$  in some detail. Recall from Lemma 3.8 that

$$N_{Aut(F_n)}(B_k) \cong N_{\Sigma_p}(\mathbb{Z}/p) \times (F_k \rtimes Aut(F_k)) \times Aut(F_{p-1-k}).$$

In a similar way, we could use Proposition 3.5 just as Lemma 3.8 did to get that

$$N_{Aut(F_{m+2})}(\mathcal{Q}) \cong \Sigma_3 \times (F_m \rtimes Aut(F_m)).$$

The  $\Sigma_3 \cong N_{\Sigma_3}(\mathbb{Z}/3)$  comes from normalizing graph automorphisms of the  $\Theta_2$ , the  $F_m$  comes from Nielsen moves done by pulling the back ends of all of the edges  $e_i$  uniformly around some loop in the rose  $R_m$ , and the  $Aut(F_m)$  comes from Nielsen transformations and graph automorphisms concerning just the petals of the rose  $R_m$ .

Let us examine the Nielsen transformations corresponding to the  $F_m$  in a little more detail. Say the petals of the rose are  $r_1, \dots, r_m$ . The group  $F_m$  is generated by the  $m$  Nielsen moves  $a_k := \langle \bar{e}_1, \bar{r}_k \rangle$  where  $\langle \bar{e}_1, \bar{r}_k \rangle$  fixes the rose and sends  $e_j$  to  $r_k * e_j$  for all  $j \in \{1, 2, 3\}$ . What effect does this move have on the marked graph  $\tilde{\eta}$ ? First, observe that the new marked graph sends  $R_m$  identically to  $R_m$  as before. However, the  $i$ th petal of the second rose is now sent to  $r_k * e_i * \bar{e}_{i+1} * \bar{r}_k$ . Hence some word

$$w = a_{k_1}, \dots, a_{k_s} \in F_m \subset N_{Aut(F_{m+2})}(\mathcal{Q})$$

in the letters  $a_1, \dots, a_m$  acts on the marked graph  $\tilde{\eta}$  as follows. The first rose  $R_m$  in  $R_m \vee R_2$  is still sent identically to the rose  $R_m$  in  $R_m \vee \Theta_2$ . On the other

hand, the second rose  $R_2$  now has its  $i$ th petal sent to (recalling that the action of  $N_{Aut(F_{m+2})}(\mathcal{Q})$  on marked graphs is a right action)

$$r_{k_1} * \cdots * r_{k_s} * e_i * \bar{e}_{i+1} * \bar{r}_{k_s} * \cdots * \bar{r}_{k_1}.$$

In other words, the entire second rose  $R_2$  in  $R_m \vee R_2$  is mapped to  $R_m \vee \Theta_2$  by conjugating the old way it was mapped by the path  $r_{k_1} * \cdots * r_{k_s}$  representing  $w$ .

**Proposition 4.4** *The fixed point space  $\tilde{X}_m$  can be characterized as the realization of the poset of equivalence classes of pairs  $(\alpha, f)$ , where  $\alpha : R_m \rightarrow \Gamma_m$  is a basepointed marked graph whose underlying graph  $\Gamma_m$  has a special (possibly valence 2) vertex which is designated as  $\circ$ ,  $\circ$  may equal the basepoint  $*$  of  $\Gamma_m$ , and  $f : I \rightarrow \Gamma_m$  is a homotopy class (rel endpoints) of maps from  $*$  to  $\circ$  in  $\Gamma_m$ .*

**Proof.** By definition,  $\tilde{X}_m$  consists of simplices in the spine  $X_{m+2}$  that are fixed by  $\mathcal{Q}$ . It is the subcomplex generated by marked graphs (i.e., vertices of  $X_{m+2}$ ) which realize the finite subgroup  $\mathcal{Q} \subset Aut(F_{m+2})$ . From Theorem 2.6, any two vertices in  $\tilde{X}_m$  corresponding to reduced marked graphs, are connected to each other by Nielsen moves. In other words, they are connected to each other by Nielsen moves that can be represented by elements of

$$N_{Aut(F_{m+2})}(\mathcal{Q}) \cong \Sigma_3 \times (F_m \rtimes Aut(F_m)),$$

since the normalizer contains all of the relevant Nielsen transformations. In particular, the Nielsen moves come from  $\langle a_1, \dots, a_m \rangle \cong F_m$  and the Nielsen moves in  $Aut(F_m)$  involving only the petals of the rose  $R_m$  in  $R_m \vee \Theta_2$ .

Hence the reduced marked graphs representing vertices of  $\tilde{X}_m$  are of the form

$$\psi = \alpha \vee \beta : R_m \vee R_2 \rightarrow R_m \vee \Theta_2$$

where  $\alpha : R_m \rightarrow R_m$  corresponds to any reduced marked graph representing a vertex of  $X_m$  and  $\beta : R_2 \rightarrow R_m \vee \Theta_2$  sends the  $i$ th petal to

$$r_{k,1} * \cdots * r_{k,m} * e_i * \bar{e}_{i+1} * \bar{r}_{k,m} * \cdots * \bar{r}_{k,1},$$

for some path  $r_{k_1} * \cdots * r_{k_s}$  corresponding to a word in  $F_m$ . We could thus represent the reduced marked graph  $\psi$  more compactly as a pair  $(\alpha, f)$  where  $\alpha : R_m \rightarrow R_m$  is any reduced marked graph and  $f : I = [0, 1] \rightarrow R_m$  is a homotopy class (rel the endpoints  $f(0) = f(1) = *$ ) of maps representing a path  $r_{k_1} * \cdots * r_{k_s}$  in the rose  $R_m$ .

Now that we have a characterization of reduced marked graphs representing vertices of  $\tilde{X}_m$ , we will obtain a characterization of all marked graphs representing vertices of  $\tilde{X}_m$ . We can do this by considering the stars, in  $\tilde{X}_m$ , of reduced marked graphs  $(\alpha, f) : R_{m+2} \rightarrow R_m \vee \Theta_2$ . Recall that  $\mathcal{Q}$  rotates the edges of  $\Theta_2$  and leaves everything else fixed.

**Definition 4.5** *Let  $G$  be a finite subgroup of  $\text{Aut}(F_r)$  for some integer  $r$ . A marked graph*

$$\eta^1 : R_r \rightarrow \Gamma^1$$

*is a  $G$ -equivariant blowup in the fixed point space  $X_r^G$  of a marked graph*

$$\eta^2 : R_r \rightarrow \Gamma^2$$



if there is a 1-simplex  $\eta^1 > \eta^2$  in  $X_r^G$ . In other words, this happens exactly when we can collapse a  $G$ -invariant forest in  $\Gamma^1$  to obtain  $\Gamma^2$ . We often abbreviate this and just say that  $\eta_1$  is a blowup of  $\eta_2$  or that  $\eta_2$  can be blown up to get  $\eta_1$ . If the forest that we collapsed was just a tree, we say that we blew up the corresponding vertex of  $\eta_2$  to get  $\eta_1$ .

**Claim 4.6** *Any equivariant blowup of  $\Gamma$  is a blowup of  $R_m$ , with  $\Theta_2$  attached at a point.*

**Proof.** Suppose  $\Gamma$  is obtained from  $\Gamma'$  by collapsing an invariant forest  $F$ . It suffices to show that  $F$  is fixed by the action of  $\mathcal{Q}$ , since then the initial (resp. terminal) vertices of the edges mapping to  $e_i$  must be the same.

Suppose  $F$  is not fixed by  $\mathcal{Q}$ , and let  $F_0$  be the union of edges of  $F$  with non-trivial orbits. Let  $v$  be a terminal vertex of  $F_0$ , and let  $e$  and  $f$  be edges of  $\Gamma'$  terminating at  $v$  which are not in  $F_0$ . If  $e$  or  $f$  is fixed by  $\mathcal{Q}$ , then  $v$  is fixed; in particular, if  $e$  or  $f$  is in  $F - F_0$ , then  $v$  is fixed by  $\mathcal{Q}$ . If  $e$  and  $f$  are not fixed, then since they are not in  $F$ , they must map to edges  $e_i$  and  $e_j$  of  $\Gamma$ , with  $i \neq j$ . Since the map is equivariant, some element of  $\mathcal{Q}$  takes  $e$  to  $f$ . But this element must then fix their common vertex,  $v$ , so in all cases  $v$  must be fixed by  $\mathcal{Q}$ . Since all terminal vertices of  $F_0$  are fixed,  $F_0$  must be fixed, contradicting the definition of  $F_0$ .  $\square$

Hence the only way to blow up  $(\alpha, f)$  is by blowing up the  $R_m$  part of  $R_m \vee \Theta_2$ . When you do this, you can think of the resulting marked graph as some  $(\hat{\alpha}, \hat{f})$  where

$$\hat{\alpha} : R_m \rightarrow \Gamma_m$$

is any marked graph, except that the underlying graph  $\Gamma_m$  has one extra distinguished vertex, which we will call  $\circ$  and which might have valence 2, aside from the basepoint  $*$ , and where

$$\hat{f} : I \rightarrow \Gamma_m$$

is a homotopy class of paths from  $*$  to  $\circ$  in  $\Gamma_m$ . We allow the possibility that  $\circ$  might just be  $*$ . The pair  $(\hat{\alpha}, \hat{f})$  is really representing a marked graph  $R_{m+2} \rightarrow \Gamma_m \vee \Theta_2$  as follows. The wedge  $\vee$  connects the point  $\circ$  of  $\Gamma_m$  to the left hand vertex of  $\Theta_2$ . The basepoint of the resulting graph  $\Gamma_m \vee \Theta_2$  is whatever the old basepoint  $*$  of  $\Gamma_m$  was. The first  $m$  petals of  $R_{m+2}$  map to  $\Gamma_m$  via  $\hat{\alpha}$  and the  $(m+i)$ -th petal of  $R_{m+2}$  first goes around the image of  $\hat{f}$  from  $*$  to  $\circ$ , then goes around  $e_i * \bar{e}_{i+1}$  of the  $\Theta$ -graph, and then finally goes back around the image of  $\hat{f}$  in reverse from  $\circ$  to  $*$ .

For  $(\hat{\alpha}, \hat{f})$  to be in the star of  $(\alpha, f)$  it has to be the case that when the graph  $\Gamma_m \vee \Theta_2$  is collapsed to  $R_m \vee \Theta_2$  the marking  $\hat{\alpha}$  collapses to  $\alpha$  and the homotopy class (rel endpoints) of maps  $\hat{f}$  collapses to  $f$ . This concludes the proof of Proposition 4.4.  $\square$

As in [10], there is an obvious definition of when two of the marked graphs described in Proposition 4.4 are equivalent.

**Definition 4.7** *Marked graphs  $(\alpha^1, f^1)$  and  $(\alpha^2, f^2)$  are equivalent if there is a homeomorphism  $h$  from  $\Gamma_m^1$  to  $\Gamma_m^2$  which sends  $*$  to  $*$ ,  $\circ$  to  $\circ$ , such that*

$$(h\alpha^1)_\# = (\alpha^2)_\# : \pi_1(R_m, *) \rightarrow \pi_1(\Gamma_m^2)$$

*and such that the paths*

$$hf_1, f_2 : I \rightarrow \Gamma_m^2$$

are homotopic rel endpoints.

We are now in a position to observe how  $N_{Aut(F_{m+2})}(\mathcal{Q})$  acts on a marked graph in  $\tilde{X}_{p-1}$ . Namely,

**Proposition 4.8** *The group*

$$N_{Aut(F_{m+2})}(\mathcal{Q}) \cong \Sigma_3 \times (F_m \rtimes Aut(F_m))$$

*acts on a marked graph*

$$(\alpha, f) : R_m \amalg I \rightarrow \Gamma_m$$

*in  $\tilde{X}_m$  as follows. The subgroup  $\Sigma_3$  permutes the edges of the  $\Theta$  graph attached at  $\circ$ , giving a marked graph which is equivalent to the original one. An element  $a_{k_1} a_{k_2} \dots a_{k_s}$  in  $F_m = \langle a_1, \dots, a_m \rangle$  doesn't change  $\alpha$  at all, but sends the path  $f$  to the path*

$$\alpha(r_{k_1}) * \alpha(r_{k_2}) * \dots * \alpha(r_{k_s}) * f$$

*where  $r_i$  is the  $i$ th petal of the rose  $R_m$  in the domain of  $\alpha$ . Lastly, an element  $\phi \in Aut(F_m)$  does not change  $f$  at all and acts on  $\alpha : R_m \rightarrow \Gamma_m$  by precomposition:*

$$(\alpha, f) \cdot \phi = (\alpha \circ \phi, f).$$

**Proof.** This follows in a direct manner from recalling that we know how

$N_{Aut(F_{m+2})}(\mathcal{Q})$  acts on reduced marked graphs and just looking at  $(\alpha, f)$  as being a marked graph

$$R_{m+2} \rightarrow \Gamma_m \vee \Theta_2$$

in the star of some reduced marked graph

$$R_{m+2} \rightarrow R_m \vee \Theta_2. \quad \square$$

Just as Proposition 4.4 gives us a simple characterization of  $\tilde{X}_m$ , the following remark provides a nice characterization of  $\tilde{Q}_m$ :

**Remark 4.9** *The quotient space  $\tilde{Q}_m$  of  $\tilde{X}_m$  by  $N_{Aut(F_{m+2})}(\mathcal{Q})$  can be characterized as the realization of the poset of equivalence classes of basepointed graphs  $\Gamma_m$  which have a special (possibly valence 2) vertex designated as  $\circ$ , which may equal the basepoint  $*$ . Two such graphs  $\Gamma_m^1$  and  $\Gamma_m^2$  are equivalent if there is a homeomorphism*

$$h : \Gamma_m^1 \rightarrow \Gamma_m^2$$

*such that  $h(*) = *$  and  $h(\circ) = \circ$ . Define the poset structure on these graphs by forest collapses. That is,  $\Gamma_m^1 > \Gamma_m^2$  if there is a simplicial map  $g : \Gamma_m^1 \rightarrow \Gamma_m^2$  such that  $g(*) = *$ ,  $g(\circ) = \circ$ , and  $g^{-1}(\text{vertices of } \Gamma_m^2)$  is a subforest of  $\Gamma_m^1$ .*

Note that if we are concerned with the quotient  $\tilde{Q}_m$  of  $\tilde{X}_m$  by  $N_{Aut(F_{m+2})}(\mathcal{Q})$  then the situation simplifies even further from that of Proposition 4.4. When you forget the marking of  $(\alpha, f)$  on  $\Gamma_m \vee \Theta_m$ , it becomes irrelevant where  $\alpha$  sends the rose  $R_m$  and where  $f$  sends the interval  $I$ . In other words, all that matters is the graph  $\Gamma_m$  with two distinguished points,  $*$  and  $\circ$ . In this manner, the quotient  $\tilde{Q}_m$  is just the “moduli space of unmarked graphs  $\Gamma_m$  with  $\pi_1(\Gamma_m) \cong F_m$  and where  $\Gamma_m$  has two distinguished points.”

Recall from [15] that the spine  $X_m$  of outer space is a deformation retraction of outer space  $\mathbb{A}_m$ . Similarly, we can construct a space  $\tilde{\mathbb{A}}_m$  which deformation retracts to  $\tilde{X}_m$ . We can then think of  $\tilde{X}_m$  as being the “spine” of  $\tilde{\mathbb{A}}_m$ .

**Definition 4.10** ( $\tilde{\mathbb{A}}_m$ ) *Construct an analog  $\tilde{\mathbb{A}}_m$  of outer space for  $N_{\text{Aut}(F_{m+2})}(\mathcal{Q})$  by considering markings*

$$(\alpha, f) : R_m \amalg I \rightarrow \Gamma_m$$

where the edges of  $\Gamma_m$  are assigned lengths which must sum to 1. Just as in [10], the space  $\tilde{\mathbb{A}}_m$  deformation retracts to its spine  $\tilde{X}_m$ .

Now from [15] we have  $\dim(X_m) = \dim(Q_m) = 2m - 2$  and  $\dim(\mathbb{A}_m) = 3m - 3$ . As the graph  $\Gamma_m$  in a particular marked graph has possibly one extra vertex  $\circ$  of valence 2, we see that  $\dim(\tilde{X}_m) = \dim(\tilde{Q}_m) = 2m - 1$  and  $\dim(\tilde{\mathbb{A}}_m) = 3m - 2$ .

Now that we are more familiar with the structure of our spaces  $\tilde{X}_m$  and  $\tilde{Q}_m$ , we can proceed with describing how they are related to the normalizers  $N_{\text{Aut}(F_n)}(B_k)$ .

**Definition 4.11 (Action of  $N_{\text{Aut}(F_n)}(B_k)$  on  $\tilde{X}_k$ )** *For  $k \in \{0, \dots, p-1\}$ , the map from*

$$N_{\text{Aut}(F_n)}(B_k) \cong N_{\Sigma_p}(\mathbb{Z}/p) \times (F_k \rtimes \text{Aut}(F_k)) \times \text{Aut}(F_{p-1-k})$$

to

$$N_{\text{Aut}(F_{m+2})}(\mathcal{Q}) \cong \Sigma_3 \times (F_m \rtimes \text{Aut}(F_m))$$

given by projection to the second factor followed by inclusion induces an action of  $N_{\text{Aut}(F_n)}(B_k)$  on  $\tilde{X}_k$ . Since  $N_{\Sigma_p}(\mathbb{Z}/p) \subset N_{\text{Aut}(F_n)}(B_k)$  acts trivially, the quotient of this action is  $\tilde{Q}_k$ .

We can also define an action of  $N_{\text{Aut}(F_n)}(B_k)$  on  $X_{p-1-k}$ :

**Definition 4.12 (Action of  $N_{Aut(F_n)}(B_k)$  on  $X_{p-1-k}$ )** For  $k \in \{0, \dots, p-1\}$ , the map from

$$N_{Aut(F_n)}(B_k) \cong N_{\Sigma_p}(\mathbb{Z}/p) \times (F_k \rtimes Aut(F_k)) \times Aut(F_{p-1-k})$$

to

$$Aut(F_{p-1-k})$$

given by projection on the third factor induces an action of  $N_{Aut(F_n)}(B_k)$  on  $X_{p-1-k}$ , with quotient  $Q_{p-1-k}$ .

From Definition 4.11 and Definition 4.12, there is an induced action of  $N_{Aut(F_n)}(B_k)$  on  $\tilde{X}_k \times X_{p-1-k}$ . Note that the space  $\tilde{X}_k \times X_{p-1-k}$  is a product of posets and can be given a poset structure by saying that the pair of marked graphs

$$(\alpha^1, f^1) \times \beta^1$$

is greater than or equal to the pair

$$(\alpha^2, f^2) \times \beta^2$$

if both

$$(\alpha^1, f^1) \geq (\alpha^2, f^2)$$

and

$$\beta^1 \geq \beta^2.$$

This gives  $\tilde{X}_k \times X_{p-1-k}$  a simplicial structure. Often we will not use this simplicial structure, however, and just use the cellular structure that comes from products of simplices in  $\tilde{X}_k$  and in  $X_{p-1-k}$ .

**Theorem 4.13** *The above induced action of  $N_{Aut(F_n)}(B_k)$  on the contractible space  $\tilde{X}_k \times X_{p-1-k}$  has finite stabilizers and quotient  $\tilde{Q}_k \times Q_{p-1-k}$ .*

**Proof.** The space  $\tilde{X}_k$  is contractible from Fact 4.1. The space  $X_{p-1-k}$  is contractible by Hatcher and Vogtmann in [15]. It follows from the assertions in Definition 4.11 and Definition 4.12 that the quotient of  $\tilde{X}_k \times X_{p-1-k}$  by  $N_{Aut(F_n)}(B_k)$  is  $\tilde{Q}_k \times Q_{p-1-k}$ .

Consider the product of simplices

$$\delta_1 \times \delta_2 \subset \tilde{X}_k \times X_{p-1-k}$$

where  $\delta_1$  and  $\delta_2$  are simplices of  $\tilde{X}_k$  and  $X_{p-1-k}$ , respectively. Let

$$(\alpha, f) : R_k \coprod I \rightarrow \Gamma_k^1$$

be the top marked graph in the simplex  $\delta_1$  and let

$$\beta : R_{p-1-k} \rightarrow \Gamma_{p-1-k}^2$$

be the top marked graph in the simplex  $\delta_2$ . Then the stabilizer of  $\delta_1 \times \delta_2$  under the action of

$$N_{Aut(F_n)}(B_k) \cong N_{\Sigma_p}(\mathbb{Z}/p) \times (F_k \rtimes Aut(F_k)) \times Aut(F_{p-1-k})$$

is a subgroup of

$$N_{\Sigma_p}(\mathbb{Z}/p) \times Aut(\Gamma_k^1) \times Aut(\Gamma_{p-1-k}^2),$$

which is a finite group. Hence the action of  $N_{Aut(F_n)}(B_k)$  on  $\tilde{X}_k \times X_{p-1-k}$  has finite stabilizers.  $\square$

It is interesting to note that the space  $\tilde{X}_k \times X_{p-1-k}$  is in fact homeomorphic to the fixed point subcomplex  $X_n^{B_k}$ . We leave this as a straightforward exercise for the reader, as this fact will not be used in this dissertation.

# Chapter 5

## The cohomology of the normalizers

In this chapter, we will compute the cohomology of the normalizers of the subgroups

$$A, B_k, C, D, \text{ and } E$$

listed in Proposition 2.7. First, we list some helpful facts that will allow us to compute these cohomology groups.

Associated to any group extension is a “five term exact sequence in cohomology” (see section 3.5 of [5] for a proof and details):

**Proposition 5.1** *Let  $G$  be a group,  $N$  be a normal subgroup of  $G$ , and  $M$  be a  $G$ -module. Then the following sequence is exact:*

$$\begin{array}{ccccccc} 0 & \rightarrow & H^1(G/N; M^N) & \xrightarrow{\text{inf}} & H^1(G; M) & \xrightarrow{\text{res}} & H^1(N; M)^{G/N} & \xrightarrow{d_2} \\ & & & & & & H^2(G/N; M^N) & \xrightarrow{\text{inf}} & H^2(G; M), \end{array}$$



where  $\text{inf}$  refers to the inflation map induced by the quotient map  $G \twoheadrightarrow G/N$ ,  $\text{res}$  refers to the restriction map induced by the inclusion  $N \hookrightarrow G$ , and  $d_2$  is the differential on the  $E_2$ -page of a spectral sequence defined in section 3.5 of [5].

One also has, from section 3.5 of [5], a “five term exact sequence in homology”:

**Proposition 5.2** *Let  $G$  be a group,  $N$  be a normal subgroup of  $G$ , and  $M$  be a  $G$ -module. Then the following sequence is exact:*

$$\begin{aligned} H_2(G; M) &\rightarrow H_2(G/N; M_N) \rightarrow \\ &H_1(N; M)_{G/N} \rightarrow H_1(G; M) \rightarrow H_1(G/N; M_N) \rightarrow 0. \end{aligned}$$

We will also need a result of Hatcher in [14]:

**Theorem 5.3 (Hatcher)** *The homology of the infinite symmetric group  $H_t(\Sigma_\infty; \mathbb{Z})$  is a direct summand of  $H_t(\text{Aut}(F_\infty); \mathbb{Z})$ . For  $t = 1, 2$  the complementary summand is zero. In addition,  $H_1(\text{Aut}(F_\infty); \mathbb{Z}) = H_1(\text{Aut}(F_m); \mathbb{Z})$  for  $m \geq 2$ .*

It will also prove useful to cite a theorem of Hatcher and Vogtmann in [15] which gives a linear stability range for the homology of  $\text{Aut}(F_n)$ :

**Theorem 5.4 (Hatcher-Vogtmann)** *The natural stabilization map*

$$H_t(\text{Aut}(F_m); \mathbb{Z}) \rightarrow H_t(\text{Aut}(F_{m+1}); \mathbb{Z})$$

*is an isomorphism for  $n \geq 2t + 3$ .*

The following theorem of Swan’s (see [25] or [1]) is a standard tool for computing the cohomology of groups:

**Theorem 5.5 (Swan)** *If  $G$  is a finite group with a  $p$ -Sylow subgroup  $P$  that is abelian, then*

$$H^*(G; \mathbb{Z}_{(p)}) = H^*(P; \mathbb{Z}_{(p)})^{N_G(P)}.$$

We begin our computations with a few preliminary lemmas about the first cohomology groups of the quotient spaces  $Q_m$  and  $\tilde{Q}_m$ .

**Lemma 5.6** 1. *For all integers  $1 \leq m \leq p - 1$  and for  $t = 1, 2$ ,*

$$H^t(Q_m; \mathbb{Z}/p) = H^t(\text{Aut}(F_m); \mathbb{Z}/p).$$

2. *For all integers  $1 \leq m \leq p - 1$ ,*

$$H^1(\text{Aut}(F_m); \mathbb{Z}/p) = 0.$$

**Proof.** First, we show that  $H^t(Q_m; \mathbb{Z}/p) = H^t(\text{Aut}(F_m); \mathbb{Z}/p)$  for  $t = 1, 2$ . Apply the equivariant cohomology spectral sequence 1.1 corresponding to  $\text{Aut}(F_m)$  acting on  $X_m$ . This requires us to look at the cohomology groups

$$H^*(\text{stab}(\delta); \mathbb{Z}/p)$$

of stabilizers of simplices  $\delta$  in  $X_m$ .

If  $m < p - 1$ , none of the simplices  $\delta$  have any  $p$ -symmetry. So  $H^t(\text{stab}(\delta); \mathbb{Z}/p)$  is 0 for all  $t \neq 0$  in those cases. For  $t = 0$ , the cohomology group is just  $\mathbb{Z}/p$ . Hence the spectral sequence 1.1 applied to this situation yields that  $H^t(Q_m; \mathbb{Z}/p) = H^t(\text{Aut}(F_m); \mathbb{Z}/p)$  for all  $t$ . Specializing this to  $t = 1, 2$  gives us our desired result.

If  $m = p - 1$ , then the only simplices  $\delta$  with  $p$ -symmetry are vertices (i.e., marked graphs) whose underlying graph is  $\Theta_{p-1}$ . For a such a  $\delta$ ,

$$H^t(\text{stab}(\delta); \mathbb{Z}/p) = H^t(\Sigma_p; \mathbb{Z}/p) = \begin{cases} \mathbb{Z}/p & t \geq 0, t \equiv 0 \pmod{n} \\ \mathbb{Z}/p & t > 0, t \equiv -1 \pmod{n} \\ 0 & \text{otherwise} \end{cases}$$

Since  $p \geq 3$ , the three rows  $s = 1, 2, 3$  of the  $E_1$ -page of spectral sequence 1.1 are all zero. Consequently, the spectral sequence gives us that  $H^t(Q_{p-1}; \mathbb{Z}/p) = H^t(\text{Aut}(F_{p-1}); \mathbb{Z}/p)$  for  $t = 1, 2$ .

Hence if  $t = 1, 2$  then  $H^t(Q_m; \mathbb{Z}/p) = H^t(\text{Aut}(F_m); \mathbb{Z}/p)$  in both cases and 1. is established.

It remains to show that  $H^1(\text{Aut}(F_m); \mathbb{Z}/p) = 0$ . If  $m = 1$  then

$$H^1(\text{Aut}(F_m); \mathbb{Z}/p) = H^1(\text{Aut}(\mathbb{Z}); \mathbb{Z}/p) = H^1(\mathbb{Z}/2; \mathbb{Z}/p) = 0$$

and we are done. On the other hand, if  $m \geq 2$  then Theorem 5.3 and dual universal coefficients yield

$$H^1(\text{Aut}(F_m); \mathbb{Z}/p) = H^1(\text{Aut}(F_\infty); \mathbb{Z}/p) = H^1(\Sigma_\infty; \mathbb{Z}/p) = 0. \square$$

If  $m \geq 5$  then Theorem 5.3 and Theorem 5.4, along with dual universal coefficients, yield

$$H^2(\text{Aut}(F_m); \mathbb{Z}/p) = H^2(\text{Aut}(F_\infty); \mathbb{Z}/p) = H^2(\Sigma_\infty; \mathbb{Z}/p) = 0.$$

If  $p \geq 7$ , this gives

$$H^2(\text{Aut}(F_{p-1}); \mathbb{Z}/p) = 0.$$

We will also need this group to vanish for  $p = 3$  and  $p = 5$ , in the course of our proof of Lemma 5.12. Although the theorems of Hatcher and Vogtmann do not as stated yield the result for  $p = 3, 5$ , it is an easy application of their work to obtain this:

**Fact 5.7**  $H^2(\text{Aut}(F_{p-1}); \mathbb{Z}/p) = 0$ .

For a proof of the above fact, refer to Proposition 10.1 in Chapter 10.

**Lemma 5.8** *For all integers  $1 \leq m \leq p - 1$ ,*

1.  $|H_1(F_m \rtimes \text{Aut}(F_m); \mathbb{Z})| \in \mathbb{Z}^+$  is a power of 2.
2.  $H^1(\tilde{Q}_m; \mathbb{Z}/p) = H^1(F_m \rtimes \text{Aut}(F_m); \mathbb{Z}/p) = 0$ .

**Proof.** For just this proof, set

$$G = F_m \rtimes \text{Aut}(F_m)$$

as a notational convenience. First, we show 1. From the five term exact sequence 5.2 corresponding to the group extension  $G$ , the following is exact:

$$H_1(F_m; \mathbb{Z})_{\text{Aut}(F_m)} \rightarrow H_1(G; \mathbb{Z}) \rightarrow H_1(\text{Aut}(F_m); \mathbb{Z}_{F_m}).$$

Now  $G$  acts trivially on  $\mathbb{Z}$  so that  $\mathbb{Z}_{F_m} = \mathbb{Z}$  and from Theorem 5.3 we see that

$$H_1(\text{Aut}(F_m); \mathbb{Z}) = H_1(\text{Aut}(F_\infty); \mathbb{Z}) = H_1(\Sigma_\infty; \mathbb{Z}) = \mathbb{Z}/2.$$

In addition,

$$H_1(F_m; \mathbb{Z}) = \mathbb{Z} \oplus \dots \oplus \mathbb{Z} = m(\mathbb{Z})$$

and  $Aut(F_m)$  acts on it by first projecting to  $GL_m(\mathbb{Z})$  and then acting in the usual manner. Let  $\xi$  be the element of  $Aut(F_m)$  sending each generator to its inverse. Then  $\xi$  acts on  $m(\mathbb{Z}) = \mathbb{Z} \oplus \dots \oplus \mathbb{Z}$  by sending  $(x_1, \dots, x_m)$  to  $(-x_1, \dots, -x_m)$ . Thus in the module of co-invariants  $(\mathbb{Z} \oplus \dots \oplus \mathbb{Z})_{Aut(F_m)}$  we have

$$[(x_1, \dots, x_m)] = [(-x_1, \dots, -x_m)]$$

or  $2[(x_1, \dots, x_m)] = 0$ . Accordingly, we have that  $(\mathbb{Z} \oplus \dots \oplus \mathbb{Z})_{Aut(F_m)}$  is all 2-torsion.

From the three terms of the five term exact sequence that we printed above,  $H_1(G; \mathbb{Z})$  is a finite group whose order is a power of 2. This proves statement 1.

To prove the second statement, we use the equivariant cohomology spectral sequence 1.1 for

$$G \subset N_{Aut(F_{m+2})}(\mathcal{Q})$$

acting on  $\tilde{Q}_m$ . If  $m < p - 1$ , none of the simplices  $\delta$  of  $\tilde{Q}_m$  have any  $p$ -symmetry. So  $H^t(stab(\delta); \mathbb{Z}/p)$  is 0 for all  $t \neq 0$  in those cases. For  $t = 0$ , the cohomology group is just  $\mathbb{Z}/p$ . Hence the spectral sequence 1.1 applied to this situation yields that  $H^t(\tilde{Q}_m; \mathbb{Z}/p) = H^t(G; \mathbb{Z}/p)$  for all  $t$ . Specializing this to  $t = 1$  gives us that  $H^1(\tilde{Q}_m; \mathbb{Z}/p) = H^1(G; \mathbb{Z}/p)$ .

On the other hand, if  $m = p - 1$ , then the only simplices  $\delta$  with  $p$ -symmetry are vertices (i.e., marked graphs) whose underlying graph is  $\Theta_{p-1}$ . (In other words, there are really two possibilities for underlying graphs here. One is the graph  $\Theta_{p-1}^1$  where  $*=\circ$  are both the same vertex on one side of the  $\Theta$ -graph, and the other is the graph  $\Theta_{p-1}^2$  where  $*$  is the vertex on one side of the  $\Theta$ -graph and  $\circ$  is the vertex

on the other side.) For a such a  $\delta$ ,

$$H^t(\text{stab}(\delta); \mathbb{Z}/p) = H^t(\Sigma_p; \mathbb{Z}/p) = \begin{cases} \mathbb{Z}/p & t \geq 0, t \equiv 0 \pmod{n} \\ \mathbb{Z}/p & t > 0, t \equiv -1 \pmod{n} \\ 0 & \text{otherwise} \end{cases}$$

Since  $p \geq 3$ , the three rows  $s = 1, 2, 3$  of the  $E_1$ -page of spectral sequence 1.1 are all zero. Consequently, the spectral sequence gives us that  $H^1(\tilde{Q}_m; \mathbb{Z}/p) = H^1(G; \mathbb{Z}/p)$ .

Hence  $H^1(\tilde{Q}_m; \mathbb{Z}/p) = H^1(G; \mathbb{Z}/p)$  in both cases. By part 1. and dual universal coefficients, we see that

$$H^1(\tilde{Q}_m; \mathbb{Z}/p) = H^1(G; \mathbb{Z}/p) = 0. \square$$

Finally, we will need the following fact, which is proven later in Proposition 10.2 and Proposition 10.3 of Part II:

**Fact 5.9**  $H^2(\tilde{Q}_{p-1}; \mathbb{Z}/p) = 0$ .

We can now calculate the cohomology of the normalizers of the various subgroups  $A$ ,  $B_k$ ,  $C$ ,  $D$ , and  $E$ .

**Lemma 5.10**

$$\hat{H}^t(N_{\text{Aut}(F_n)}(A); \mathbb{Z}_{(p)}) \cong \begin{cases} \mathbb{Z}/p & t \equiv 0 \pmod{n} \\ 0 & t \equiv \pm 1 \pmod{n} \\ H^r(Q_p^\omega; \mathbb{Z}/p) & t \equiv r \pmod{n}, \\ & 2 \leq r \leq n-2 \end{cases}$$

**Proof.** We now define an action of  $N_{\Sigma_p}(\mathbb{Z}/p) \times N_{\text{Aut}(F_p)}(\omega)$  on the space  $X_p^\omega$  by stipulating that  $N_{\Sigma_p}(\mathbb{Z}/p)$  acts trivially and that  $N_{\text{Aut}(F_p)}(\omega)$  acts in the usual

manner on  $X_p^\omega$ . This in turn defines an action of  $N_{Aut(F_n)}(A)$  on the contractible space  $X_p^\omega$ . This action has finite stabilizers and quotient  $Q_p^\omega$ .

The equivariant cohomology spectral sequence 1.2 for this action is

$$(5.11) \quad E_1^{r,s} = \prod_{[\delta] \in \Delta_{p-1}^r} \hat{H}^s(stab_{N_{Aut(F_n)}(A)}(\delta); \mathbb{Z}_{(p)}) \Rightarrow \hat{H}^{r+s}(N_{Aut(F_n)}(A); \mathbb{Z}_{(p)})$$

where  $[\delta]$  ranges over the set  $\Delta_{p-1}^r$  of orbits of  $r$ -simplices  $\delta$  in  $X_p^\omega$ .

We claim that each  $stab_{N_{Aut(F_n)}(A)}(\delta)$  is the direct sum of  $N_{\Sigma_p}(\mathbb{Z}/p)$  with a finite subgroup of  $N_{Aut(F_p)}(\omega)$  that does not have any  $p$ -torsion. This is because Glover and Mislin showed in [12] that the only  $p$ -torsion in  $Aut(F_p)$  comes from stabilizers of marked graphs with underlying graphs  $\Theta_p$ ,  $\Theta_{p-1} \vee R_1$ ,  $\Xi_p$ , or  $R_p$ . (The graph  $\Xi_p$ , defined to be the 1-skeleton of the cone over a  $p$ -gon, is illustrated in Figure 13.1.) Since  $\omega$  acts by switching the first two petals of the rose  $R_p$ ,  $X_p^\omega$  does not contain any marked graphs with underlying graph  $\Theta_p$ ,  $\Theta_{p-1} \vee R_1$ , or  $\Xi_p$ . Although  $X_p^\omega$  obviously does contain marked graphs with underlying graph  $R_p$ , these will not worry us as  $p$  does not divide the orders of the stabilizers – under the action of just  $N_{Aut(F_p)}(\omega)$  – of such marked graphs. For example,  $N_{Aut(F_p)}(\omega)$  does not contain the permutation  $(12 \dots p)$  that rotates the petals of the rose  $R_p$  because

$$(12 \dots p) \circ \omega \circ (p \dots 21)$$

is the permutation (23), which is not equal to (1) or  $\omega = (12)$ .

Thus for every  $[\delta]$ , we have

$$\hat{H}^s(stab_{N_{Aut(F_n)}(A)}(\delta); \mathbb{Z}_{(p)}) = \hat{H}^s(N_{\Sigma_p}(\mathbb{Z}/p); \mathbb{Z}_{(p)}) = \hat{H}^s(\Sigma_p; \mathbb{Z}_{(p)}).$$

The  $E_1^{r,s}$ -page of the spectral sequence is 0 in the rows where  $s \neq kn$ . On the rows where  $s = kn$ , each  $[\delta]$  of dimension  $r$  contributes exactly one copy of  $\mathbb{Z}/p$  to  $E_1^{r,s}$ . Recall that the quotient of  $X_p^\omega$  by  $N_{\text{Aut}(F_p)}(\omega)$  is  $Q_p^\omega$ . Now each row where  $s = kn$  is simply a copy of the cellular cochain complex with  $\mathbb{Z}/p$ -coefficients of the  $(n-2)$ -dimensional complex  $Q_p^\omega$ :

$$E_2^{r,s} = \begin{cases} \mathbb{Z}/p & r = 0 \text{ and } s = kn \\ H^r(Q_p^\omega; \mathbb{Z}/p) & 1 \leq r \leq n-2 \text{ and } s = kn \\ 0 & \text{otherwise} \end{cases}$$

Hence we see that the spectral sequence converges at the  $E_2$ -page.

It remains to show that  $H^1(Q_p^\omega; \mathbb{Z}/p) = 0$ . From the equivariant spectral sequence 1.1 of the group

$$((F_{p-2} \times F_{p-2}) \rtimes (\mathbb{Z}/2 \times \text{Aut}(F_{p-2}))) \subset N_{\text{Aut}(F_n)}(A)$$

acting on the space  $X_p^\omega$ , we have that

$$H^1(Q_p^\omega; \mathbb{Z}/p) = H^1((F_{p-2} \times F_{p-2}) \rtimes (\mathbb{Z}/2 \times \text{Aut}(F_{p-2})); \mathbb{Z}/p).$$

From the five term sequence of a group extension 5.1, we have that the sequence

$$\begin{aligned} & H^1(\mathbb{Z}/2 \times \text{Aut}(F_{p-2}); \mathbb{Z}/p) \rightarrow \\ & H^1((F_{p-2} \times F_{p-2}) \rtimes (\mathbb{Z}/2 \times \text{Aut}(F_{p-2})); \mathbb{Z}/p) \rightarrow \\ & H^1(F_{p-2} \times F_{p-2}; \mathbb{Z}/p)^{(\mathbb{Z}/2 \times \text{Aut}(F_{p-2}))} \end{aligned}$$

is exact.

First off,

$$H^1(\mathbb{Z}/2 \times \text{Aut}(F_{p-2}); \mathbb{Z}/p) = H^1(\text{Aut}(F_{p-2}); \mathbb{Z}/p) = 0$$



from Lemma 5.6.

Next, we must show that

$$H^1(F_{p-2} \times F_{p-2}; \mathbb{Z}/p)^{(\mathbb{Z}/2 \times \text{Aut}(F_{p-2}))} = 0.$$

Basic calculations in the cohomology of groups yield that

$$H^1(F_{p-2} \times F_{p-2}; \mathbb{Z}/p)^{(\mathbb{Z}/2 \times \text{Aut}(F_{p-2}))} = ((p-2)\mathbb{Z}/p \oplus (p-2)\mathbb{Z}/p)^{(\mathbb{Z}/2 \times \text{Aut}(F_{p-2}))},$$

where the  $\mathbb{Z}/2$  acts by exchanging the two copies of  $(p-2)\mathbb{Z}/p$  and the  $\text{Aut}(F_{p-2})$  acts on the  $(p-2)\mathbb{Z}/p \oplus (p-2)\mathbb{Z}/p$  by first projecting to  $GL_{p-2}(\mathbb{Z}/p)$  and then acting diagonally.

Suppose that

$$(x_1, \dots, x_{p-2}) \oplus (y_1, \dots, y_{p-2})$$

is an element of

$$((p-2)\mathbb{Z}/p \oplus (p-2)\mathbb{Z}/p)^{(\mathbb{Z}/2 \times \text{Aut}(F_{p-2}))}.$$

Define an element  $\xi$  of  $\text{Aut}(F_{p-2})$  on the generators  $a_i$  of  $F_{p-2}$  by  $\xi(a_i) = a_i^{-1}$  for all  $i$ . The automorphism  $\xi$  sends

$$(x_1, \dots, x_{p-2}) \oplus (y_1, \dots, y_{p-2})$$

to

$$(-x_1, \dots, -x_{p-2}) \oplus (-y_1, \dots, -y_{p-2}).$$

So  $x_i = -x_i$  and  $y_j = -y_j$  for all  $i, j$ . Recall that each  $x_i$  and  $y_j$  is in the additive group  $\mathbb{Z}/p$ . As  $p$  is odd, the only possibility is that  $x_i = 0$  for all  $i$  and  $y_j = 0$  for all  $j$ . Consequently, we have that

$$((p-2)\mathbb{Z}/p \oplus (p-2)\mathbb{Z}/p)^{(\mathbb{Z}/2 \times \text{Aut}(F_{p-2}))} = 0.$$

The five term exact sequence thus gives that

$$H^1(Q_p^\omega; \mathbb{Z}/p) = H^1((F_{p-2} \times F_{p-2}) \rtimes (\mathbb{Z}/2 \times \text{Aut}(F_{p-2})); \mathbb{Z}/p) = 0.$$

This completes the proof of the lemma.  $\square$

Note that the proof of this lemma was complicated by the fact that there is no readily defined Künneth formula for Farrell cohomology. Despite the fact that

$$\mathbb{Z}/2 \times N_{\text{Aut}(F_n)}(A) \cong N_{\Sigma_p}(\mathbb{Z}/p) \times N_{\text{Aut}(F_p)}(\omega)$$

and that a spectral sequence argument easily yields that  $\hat{H}^t(N_{\text{Aut}(F_p)}(\omega); \mathbb{Z}_{(p)}) = 0$ , we could not from then go on to claim that

$$\hat{H}^t(N_{\text{Aut}(F_n)}(A); \mathbb{Z}_{(p)}) = \hat{H}^t(\Sigma_p; \mathbb{Z}_{(p)}).$$

**Lemma 5.12**

$$\hat{H}^t(N_{\text{Aut}(F_n)}(B_0); \mathbb{Z}_{(p)}) \cong \begin{cases} \mathbb{Z}/p^2 & t = 0 \\ (j+1)\mathbb{Z}/p & |t| = nj \neq 0 \\ (j-1)\mathbb{Z}/p & |t| = nj - 1 \\ 0 & |t| \equiv 1 \pmod{n} \\ 0 & t \equiv 2 \pmod{n} \\ H^r(Q_{p-1}; \mathbb{Z}/p) & t \equiv r \pmod{n}, \\ & 3 \leq r \leq n-2 \end{cases}$$

For  $k \in \{1, \dots, p-2\}$ ,

$$\hat{H}^t(N_{Aut(F_n)}(B_k); \mathbb{Z}/(p)) \cong \begin{cases} \mathbb{Z}/p & t \equiv 0 \pmod{n} \\ 0 & t \equiv \pm 1, -2, \pmod{n} \\ H^r(\tilde{Q}_k \times Q_{p-1-k}; \mathbb{Z}/p) & t \equiv r \pmod{n}, \\ & 2 \leq r \leq n-3 \end{cases}$$

$$\hat{H}^t(N_{Aut(F_n)}(B_{p-1}); \mathbb{Z}/(p)) \cong \begin{cases} \mathbb{Z}/p^2 \oplus \mathbb{Z}/p & t = 0 \\ (2j+1)\mathbb{Z}/p & |t| = nj \neq 0 \\ 0 & t = nj + 1 > 0 \\ (2j-2)\mathbb{Z}/p & t = -nj + 1 < 0 \\ (2j-2)\mathbb{Z}/p \oplus H^{n-1}(\tilde{Q}_{p-1}; \mathbb{Z}/p) & t = nj - 1 > 0 \\ H^{n-1}(\tilde{Q}_{p-1}; \mathbb{Z}/p) & t = -nj - 1 < 0 \\ 0 & t \equiv 2 \pmod{n} \\ H^r(\tilde{Q}_{p-1}; \mathbb{Z}/p) & t \equiv r \pmod{n}, \\ & 3 \leq r \leq n-2 \end{cases}$$

**Proof.** We use the equivariant cohomology spectral sequence 1.2 corresponding to the action, defined in Definition 4.11 and Definition 4.12, of

$$N_{Aut(F_n)}(B_k) \cong N_{\Sigma_p}(\mathbb{Z}/p) \times (F_k \rtimes Aut(F_k)) \times Aut(F_{p-1-k})$$

on the space  $\tilde{X}_k \times X_{p-1-k}$ . From Theorem 4.13 the action of  $N_{Aut(F_n)}(B_k)$  on the contractible space  $\tilde{X}_k \times X_{p-1-k}$  has finite stabilizers and quotient  $\tilde{Q}_k \times Q_{p-1-k}$ .

Applying the spectral sequence 1.2 we obtain the following  $E_1$ -page:

$$(5.13) \quad E_1^{r,s} = \prod_{[\delta] \in \Delta^r} \hat{H}^s(stab_{N_{Aut(F_n)}(B_k)}(\delta); \mathbb{Z}/(p)) \Rightarrow \hat{H}^{r+s}(N_{Aut(F_n)}(B_k); \mathbb{Z}/(p))$$

where  $[\delta]$  ranges over the set  $\Delta^r$  of orbits of  $r$ -simplices  $\delta$  in  $\tilde{X}_k \times X_{p-1-k}$ . Vertices in  $\Delta^0$  are pairs of unmarked graphs  $(\Gamma_1, \Gamma_2)$  where  $\pi_1(\Gamma_1) \cong F_k$ ,  $\pi_1(\Gamma_2) \cong F_{p-1-k}$ , the graph  $\Gamma_1$  has two distinguished points  $*$  and  $\circ$ , and the graph  $\Gamma_2$  has one distinguished point  $*$ .

The stabilizer of this vertex of  $\Delta^0$  under the action of

$$N_{Aut(F_n)}(B_k) \cong N_{\Sigma_p}(\mathbb{Z}/p) \times (F_k \rtimes Aut(F_k)) \times Aut(F_{p-1-k})$$

is isomorphic to

$$N_{\Sigma_p}(\mathbb{Z}/p) \times Aut(\Gamma_1) \times Aut(\Gamma_2)$$

where by  $Aut(\Gamma_1)$  we mean graph automorphisms of  $\Gamma_1$  that preserve both distinguished points, and  $Aut(\Gamma_2)$  is the group of graph automorphisms of  $\Gamma_2$  that preserve its distinguished point.

There are three cases, depending upon what value  $k$  takes.

1.  $k \in \{1, \dots, p-2\}$ . Consider an  $r$ -simplex  $\delta$

$$((\alpha^0, f^0), \beta^0) > ((\alpha^1, f^1), \beta^1) > \dots > ((\alpha^r, f^r), \beta^r)$$

of  $\tilde{X}_k \times X_{p-1-k}$ . Let  $\Gamma^1$  be the underlying graph of  $(\alpha^0, f^0)$  and let  $\Gamma^2$  be the underlying graph of  $\beta^0$ . The stabilizer of  $\delta$  is a subgroup of the group

$$N_{\Sigma_p}(\mathbb{Z}/p) \times Aut(\Gamma_1) \times Aut(\Gamma_2).$$

The finite group  $Aut(\Gamma_1)$  has no  $p$ -torsion since  $k < p-1$  and so none of the underlying graphs of marked graphs in  $\tilde{X}_k$  have any  $p$ -symmetry. Similarly, the finite group  $Aut(\Gamma_2)$  has no  $p$ -torsion since  $k > 0$  and so none of the

underlying graphs of marked graphs in  $X_{p-1-k}$  have any  $p$ -symmetry. Thus we have that

$$\hat{H}^*(\text{stab}(\delta); \mathbb{Z}/p) \cong \hat{H}^*(N_{\Sigma_p}(\mathbb{Z}/p); \mathbb{Z}/p) \cong \hat{H}^*(\Sigma_p; \mathbb{Z}/p).$$

Since the above holds for every simplex  $\delta$ , we see that the spectral sequence 5.13 has  $E_2$  page

$$E_2^{r,s} = \begin{cases} \mathbb{Z}/p & r = 0 \text{ and } s = kn \\ H^r(\tilde{Q}_k \times Q_{p-1-k}; \mathbb{Z}/p) & 1 \leq r \leq n-3 \text{ and } s = kn \\ 0 & \text{otherwise} \end{cases}$$

because the dimension of  $\tilde{Q}_k \times Q_{p-1-k}$  is  $2p-5$ .

Now apply Lemma 5.6 and Lemma 5.8 to conclude that all of the groups  $H^1(\tilde{Q}_k \times Q_{p-1-k}; \mathbb{Z}/p)$  are zero. The lemma now follows for  $k \in \{1, \dots, p-2\}$ .

2.  $k = 0$ . Then the simplices  $\delta$  in spectral sequence 5.13 are all in  $Q_{p-1}$ . Since only one graph in  $Q_{p-1}$  has  $p$ -symmetry, namely the graph  $\Theta_{p-1}$ , we have

$$\text{stab}_{N_{\text{Aut}(F_n)}(B_k)}(\delta) = \begin{cases} N_{\Sigma_p}(\mathbb{Z}/p) \times \Sigma_p & \text{if } \delta \text{ has underlying graph } \Theta_{p-1} \\ N_{\Sigma_p}(\mathbb{Z}/p) & \text{otherwise} \end{cases}$$

Arguments similar to those in Lemma 5.10 show that the  $E_2$  page has the form

$$E_2^{r,s} = \begin{cases} \mathbb{Z}/p^2 \oplus \mathbb{Z}/p & r = 0 \text{ and } s = 0 \\ H^r(Q_{p-1}; \mathbb{Z}/p) & 1 \leq r \leq n-2, s = kn \\ (j-1)\mathbb{Z}/p & r = 0 \text{ and } |s| = nj - 1 \\ (j+1)\mathbb{Z}/p & r = 0 \text{ and } |s| = nj \neq 0 \\ 0 & \text{otherwise} \end{cases}$$

Because Fact 5.7 and Lemma 5.6 give that  $H^2(Q_{p-1}; \mathbb{Z}/p) = 0$ , the differentials  $d_2 : E_2^{0, -nj+1} \rightarrow E_2^{2, -nj}$  are zero and we see that the spectral sequence converges at the  $E_2$  page. Lastly, by Lemma 5.6,  $H^1(Q_{p-1}; \mathbb{Z}/p) = 0$  and we are done with the case  $k = 0$ .

3.  $k = p - 1$ . Then the simplices  $\delta$  in spectral sequence 5.13 are all in  $\tilde{Q}_{p-1}$ . Now only two graphs in  $\tilde{Q}_{p-1}$  have  $p$ -symmetry. One is the graph  $\Theta_{p-1}^1$  where both  $*$  and  $\circ$  are the left hand vertex of the  $\Theta$ -graph. The other is the graph  $\Theta_{p-1}^2$  where  $*$  is the vertex on the left side of the  $\Theta$ -graph and  $\circ$  is the vertex on the right side. Each of these graphs gives a vertex of  $\tilde{Q}_{p-1}$  with  $p$ -symmetry.

We have

$$stab_{N_{Aut(F_n)}(B_k)}(\delta) = \begin{cases} N_{\Sigma_p}(\mathbb{Z}/p) \times \Sigma_p & \text{if } \delta \text{ has underlying graph } \Theta_{p-1}^1 \\ & \text{or } \Theta_{p-1}^2 \\ N_{\Sigma_p}(\mathbb{Z}/p) & \text{otherwise} \end{cases}$$

Arguments similar to those in Lemma 5.10 show that the  $E_2$  page has the form

$$E_2^{r,s} = \begin{cases} \mathbb{Z}/p^2 \oplus \mathbb{Z}/p & r = 0 \text{ and } s = 0 \\ H^r(\tilde{Q}_{p-1}; \mathbb{Z}/p) & 1 \leq r \leq n-1, s = kn \\ (2j-2)\mathbb{Z}/p & r = 0 \text{ and } |s| = nj-1 \\ (2j+1)\mathbb{Z}/p & r = 0 \text{ and } |s| = nj \neq 0 \\ 0 & \text{otherwise} \end{cases}$$

Let  $j \geq 2$ . Now the differential

$$d_n : E_n^{0,nj-1} \rightarrow E_n^{n,n(j-1)} = 0$$

is necessarily trivial and thus  $\hat{H}^{nj-1}(N_{Aut(F_n)}(B_{p-1}); \mathbb{Z}_{(p)})$  has a filtration with successive terms

$$E_2^{0,nj-1} = (2j-2)\mathbb{Z}/p$$

and

$$E_2^{2p-3,n(j-1)} = H^{2p-3}(\tilde{Q}_{p-1}; \mathbb{Z}/p).$$

Since

$$\hat{H}^{nj-1}(N_{Aut(F_n)}(B_{p-1}); \mathbb{Z}_{(p)}) = H^{nj-1}(N_{Aut(F_n)}(B_{p-1}); \mathbb{Z}_{(p)})$$

(because  $nj-1$  is above the vcd of  $N_{Aut(F_n)}(B_{p-1})$ ), we can use the Künneth formula for the latter cohomology group to specify the form that the above filtration takes and obtain that

$$\hat{H}^{nj-1}(N_{Aut(F_n)}(B_{p-1}); \mathbb{Z}_{(p)}) = (2j-2)\mathbb{Z}/p \oplus H^{2p-3}(\tilde{Q}_{p-1}; \mathbb{Z}/p).$$

The other tricky cohomology group to calculate is

$$\hat{H}^{-nj+1}(N_{Aut(F_n)}(B_{p-1}); \mathbb{Z}_{(p)})$$

(again, for  $j \geq 2$ .) This can be computed by noting that

$$d_2 : E_2^{0, -nj+1} \rightarrow E_2^{2, -nj}$$

is zero by Fact 5.9 and that

$$E_2^{1, -nj} = H^1(\tilde{Q}_{p-1}; \mathbb{Z}/p) = 0$$

by Lemma 5.8. The result follows for the case  $k = p - 1$ .  $\square$

**Lemma 5.14**

$$\hat{H}^t(N_{Aut(F_n)}(C); \mathbb{Z}_{(p)}) \cong \begin{cases} \mathbb{Z}/p^2 \oplus \mathbb{Z}/p & t = 0 \\ (\frac{3k(p-1)}{2} + 1)\mathbb{Z}/p & |t| = kn \neq 0 \\ (\frac{3k(p-1)}{2} - 1)\mathbb{Z}/p & |t| = kn - 1 \\ 0 & \text{otherwise} \end{cases}$$

**Proof.** The normalizer  $N_{Aut(F_n)}(C)$  acts on the contractible space  $X_n^C$  with finite stabilizers and finite quotient. Hence we can use the equivariant cohomology spectral sequence 1.2 to calculate the cohomology of the normalizer. This gives us:

$$(5.15) \quad E_1^{r,s} = \prod_{[\delta] \in \Delta^r} \hat{H}^s(stab_{N_{Aut(F_n)}(C)}(\delta); \mathbb{Z}_{(p)}) \Rightarrow \hat{H}^{r+s}(N_{Aut(F_n)}(C); \mathbb{Z}_{(p)})$$

where  $[\delta]$  ranges over the set  $\Delta^r$  of orbits of  $r$ -simplices  $\delta$  in  $X_n^C$ .

**Claim 5.16** *The quotient space  $\bigcup_r \Delta^r$  has 3 vertices and 2 edges in it. The vertices correspond to marked graphs with underlying graphs  $\Phi_n$ ,  $\Omega_n$ , and  $\Psi_n$ . The two edges come from the forest collapses of  $\Phi_n$  to  $\Omega_n$  or  $\Psi_n$ . Pictorially, we have*

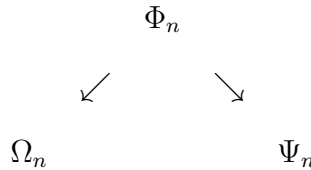



**Proof.** From Theorem 2.6, if  $\Gamma_1$  and  $\Gamma_2$  are reduced as  $C$ -graphs then they are Nielsen equivalent, up to an equivariant isomorphism (a basepoint preserving isomorphism.) That is, any two vertices (marked graphs) of  $X_n^C$  whose underlying graphs are reduced, can be connected by a sequence of Nielsen transformations. But the graphs that you get from  $\Psi_n$  by doing Nielsen moves are all isomorphic to either  $\Psi_n$  or  $\Omega_n$ .

It follows that if  $\eta$  is a vertex of  $X_n^C$  corresponding to a reduced marked graph, then the underlying graph of  $\eta$  is either  $\Psi_n$  or  $\Omega_n$ .

It remains to consider which graphs can be blowups (see Definition 4.5) of  $\Psi_n$  or  $\Omega_n$ . Such a blowup would have a nontrivial  $\mathbb{Z}/p$  action on at least  $2p$  of its edges. From this, it is not hard to see (using similar methods to those in Proposition 1.6) that the only possibility for the underlying graph of such a blowup is  $\Phi_n$ .  $\square$

Direct examination reveals that the vertex in  $\Delta^0$  corresponding to  $\Phi_n$  has automorphism group  $\Sigma_p \times \mathbb{Z}/2$ . In the notation used to define  $\Phi_n$  (refer to the text just above Figure 1.1), the  $\Sigma_p$  in  $\Sigma_p \times \mathbb{Z}/2$  acts on the collections of edges  $\{a_i\}$ ,  $\{b_i\}$ , and  $\{c_i\}$ , respectively, by permuting their indices. On the other hand, the  $\mathbb{Z}/2$  in  $\Sigma_p \times \mathbb{Z}/2$  fixes the edges  $a_i$  and switches the edges  $b_i$  with the edges  $c_i$ . The group  $C$  is included in  $\Sigma_p \times \mathbb{Z}/2$  as the cyclic group generated by the permutation  $(12 \dots p)$  in  $\Sigma_p$ . Hence the subgroup of normalizing graph automorphisms in  $\Sigma_p \times \mathbb{Z}/2$  is

$$N_{\Sigma_p}(\mathbb{Z}/p) \times \mathbb{Z}/2.$$

The stabilizer of the vertex in  $\Delta^0$  corresponding to  $\Phi_n$  has cohomology

$$\hat{H}^*(N_{\Sigma_p}(\mathbb{Z}/p) \times \mathbb{Z}/2; \mathbb{Z}_{(p)}) = \hat{H}^*(\Sigma_p; \mathbb{Z}_{(p)}).$$

Similarly, the group of graph automorphisms of  $\Omega_n$  is

$$\Sigma_p \times \Sigma_p.$$

The group  $C$  is included in this as the subgroup generated by

$$(12 \dots p) \times (12 \dots p).$$

The stabilizer of the vertex in  $\Delta^0$  which corresponds to  $\Omega_n$  is the the normalizer of  $C$  in  $\Sigma_p \times \Sigma_p$ . Using the definition of a normalizer, we see that this normalizer is

$$(\mathbb{Z}/p \times \mathbb{Z}/p) \rtimes \mathbb{Z}/(p-1).$$

The generator of  $\mathbb{Z}/(p-1)$  acts diagonally on  $(\mathbb{Z}/p \times \mathbb{Z}/p)$  by conjugating the generator of either  $\mathbb{Z}/p$  to its  $s$ -th power for some generator  $s$  of  $\mathbb{F}_p^\times$ .

The cohomology of  $(\mathbb{Z}/p \times \mathbb{Z}/p) \rtimes \mathbb{Z}/(p-1)$  can be calculated in a straightforward way from the cohomology of  $\mathbb{Z}/p \times \mathbb{Z}/p$  using Swan's theorem 5.5 which gives us that

$$H^*((\mathbb{Z}/p \times \mathbb{Z}/p) \rtimes \mathbb{Z}/(p-1); \mathbb{Z}_{(p)}) = H^*(\mathbb{Z}/p \times \mathbb{Z}/p; \mathbb{Z}_{(p)})^{\mathbb{Z}/(p-1)}.$$

So we see that  $\hat{H}^t((\mathbb{Z}/p \times \mathbb{Z}/p) \rtimes \mathbb{Z}/(p-1); \mathbb{Z}_{(p)}) =$

$$\begin{cases} \mathbb{Z}/p^2 & t = 0 \\ (k(p-1) + 1)\mathbb{Z}/p & |t| = kn \neq 0 \\ (k(p-1) - 1)\mathbb{Z}/p & |t| = kn - 1 \\ 0 & \text{otherwise} \end{cases}$$

Lastly, the group of graph automorphisms of  $\Psi_n$  is

$$(\Sigma_p \times \Sigma_p) \rtimes \mathbb{Z}/2.$$

The group  $C$  is included in this as the subgroup generated by

$$(12 \dots p) \times (12 \dots p).$$

The stabilizer of the vertex in  $\Delta^0$  which corresponds to  $\Psi_n$  is the the normalizer of  $C$  in  $(\Sigma_p \times \Sigma_p) \rtimes \mathbb{Z}/2$ . Using the definition of a normalizer, we see that this normalizer is

$$(\mathbb{Z}/p \times \mathbb{Z}/p) \rtimes (\mathbb{Z}/2 \times \mathbb{Z}/(p-1)).$$

The generator of  $\mathbb{Z}/(p-1)$  acts diagonally on  $(\mathbb{Z}/p \times \mathbb{Z}/p)$  by conjugating the generator of either  $\mathbb{Z}/p$  to its  $s$ -th power for some generator  $s$  of  $\mathbb{F}_p^\times$ . The  $\mathbb{Z}/2$  acts by exchanging one  $\mathbb{Z}/p$  for the other in  $\mathbb{Z}/p \times \mathbb{Z}/p$ . The cohomology of  $(\mathbb{Z}/p \times \mathbb{Z}/p) \rtimes (\mathbb{Z}/2 \times \mathbb{Z}/(p-1))$  can be calculated using Swan's theorem 5.5 which indicates that

$$H^*((\mathbb{Z}/p \times \mathbb{Z}/p) \rtimes (\mathbb{Z}/2 \times \mathbb{Z}/(p-1)); \mathbb{Z}_{(p)}) = H^*(\mathbb{Z}/p \times \mathbb{Z}/p; \mathbb{Z}_{(p)})^{(\mathbb{Z}/2 \times \mathbb{Z}/(p-1))}.$$

Hence  $\hat{H}^t((\mathbb{Z}/p \times \mathbb{Z}/p) \rtimes (\mathbb{Z}/2 \times \mathbb{Z}/(p-1)); \mathbb{Z}_{(p)}) =$

$$\begin{cases} \mathbb{Z}/p^2 & t = 0 \\ \left(\frac{k(p-1)}{2} + 1\right)\mathbb{Z}/p & |t| = kn \neq 0 \\ \left(\frac{k(p-1)}{2}\right)\mathbb{Z}/p & |t| = kn - 1 \\ 0 & \text{otherwise} \end{cases}$$

The two edges in  $\Delta^1$  have stabilizers isomorphic to  $N_{\Sigma_p}(\mathbb{Z}/p)$  or  $N_{\Sigma_p}(\mathbb{Z}/p) \times \mathbb{Z}/2$ . We omit the argument here, but the stabilizers of the edges can be found by examining which graph automorphisms in

$$\text{stab}(\Phi_n) = N_{\Sigma_p}(\mathbb{Z}/p) \times \mathbb{Z}/2$$

preserve the relevant forest collapses. In either case, if we take Farrell cohomology with  $\mathbb{Z}_{(p)}$ -coefficients, then both edges have stabilizers whose cohomology is the same as that of the symmetric group  $\Sigma_p$ .

Combining all of this into the spectral sequence 5.15 and then applying the differential on the  $E_1$  page, we see that

$$E_2^{r,s} = \begin{cases} \mathbb{Z}/p^2 \oplus \mathbb{Z}/p & r = 0, s = 0 \\ \left(\frac{3k(p-1)}{2} - 1\right)\mathbb{Z}/p & r = 0, |s| = kn - 1 \\ \left(\frac{3k(p-1)}{2} + 1\right)\mathbb{Z}/p & r = 0, |s| = kn \neq 0 \\ 0 & \text{otherwise} \end{cases}$$

Thus  $E_2 = E_\infty$  and  $\hat{H}^*(N_{Aut(F_n)}(C); \mathbb{Z}_{(p)})$  is as stated.  $\square$

**Lemma 5.17**

$$\hat{H}^t(N_{Aut(F_n)}(D); \mathbb{Z}_{(p)}) \cong \hat{H}^t(\Sigma_p \times \Sigma_p; \mathbb{Z}_{(p)}).$$

$$\begin{aligned} \hat{H}^t(N_{Aut(F_n)}(E); \mathbb{Z}_{(p)}) &\cong \hat{H}^t((\Sigma_p \times \Sigma_p) \rtimes \mathbb{Z}/2; \mathbb{Z}_{(p)}) \\ &\cong \begin{cases} \mathbb{Z}/p^2 & t = 0 \\ ([k/2] + 1)\mathbb{Z}/p & |t| = kn \neq 0 \\ ([k/2])\mathbb{Z}/p & |t| = kn - 1 \\ 0 & \text{otherwise} \end{cases} \end{aligned}$$

**Proof.** From Lemma 3.9,

$$N_{Aut(F_n)}(D) = N_{\Sigma_p}(\mathbb{Z}/p) \times N_{\Sigma_p}(\mathbb{Z}/p).$$

and

$$N_{Aut(F_n)}(E) = (N_{\Sigma_p}(\mathbb{Z}/p) \times N_{\Sigma_p}(\mathbb{Z}/p)) \rtimes \mathbb{Z}/2.$$

The detailed description of the cohomology of  $N_{Aut(F_n)}(E)$  in the statement of this lemma is then obtained by using Swan's theorem 5.5.  $\square$

# Chapter 6

## Cohomology of $Aut(F_n)$

In this chapter, we will use the lemmas of the previous chapter to calculate the Farrell cohomology of  $Aut(F_n)$  with coefficients in  $\mathbb{Z}_{(p)}$ , for  $n = 2(p - 1)$ .

**Theorem 6.1** *Let  $p$  be an odd prime, and  $n = 2(p - 1)$ . Then  $\hat{H}^t(Aut(F_n); \mathbb{Z}_{(p)})$*

$$\cong \left\{ \begin{array}{ll} \mathbb{Z}/p^2 \oplus p(\mathbb{Z}/p) & t = 0 \\ (p + [\frac{3k}{2}] - 1)\mathbb{Z}/p & |t| = kn \neq 0 \\ \mathbb{Z}/p & t = 1 \\ 0 & t = kn + 1 > 1 \\ ([\frac{3k}{2}] - 1)\mathbb{Z}/p & t = -kn + 1 < 0 \\ H^{n-1}(\tilde{Q}_{p-1}; \mathbb{Z}/p) \oplus ([\frac{3k}{2}] - 1)\mathbb{Z}/p & t = kn - 1 > 0 \\ H^{n-1}(\tilde{Q}_{p-1}; \mathbb{Z}/p) & t = -kn - 1 < 0 \\ H^r(Q_p^\omega; \mathbb{Z}/p) \oplus \sum_{i=0}^{p-1} H^r(\tilde{Q}_i \times Q_{p-1-i}; \mathbb{Z}/p) & t = kn + r, 2 \leq r \leq n - 2 \end{array} \right.$$

**Proof.** The cohomology  $\hat{H}^*(Aut(F_n); \mathbb{Z}_{(p)})$  will be calculated using the normalizer spectral sequence 2.3, which has  $E_1$  page

$$E_1^{r,s} = \prod_{(A_0 \subset \dots \subset A_r) \in |\mathcal{B}|_r} \hat{H}^s\left(\bigcap_{i=0}^r N_{Aut(F_n)}(A_i); \mathbb{Z}_{(p)}\right) \Rightarrow \hat{H}^{r+s}(Aut(F_n); \mathbb{Z}_{(p)})$$

where  $\mathcal{B}$  denotes the poset of conjugacy classes of nontrivial elementary abelian  $p$ -subgroups of  $Aut(F_n)$ , and  $|\mathcal{B}|_r$  is the set of  $r$ -simplices in  $|\mathcal{B}|$ . We computed  $|\mathcal{B}|$  in Proposition 2.7. It is 1-dimensional, so the above spectral sequence is zero except in the columns  $r = 0$  and  $r = 1$ .

Recall that the realization  $|\mathcal{B}|$  of the poset  $\mathcal{B}$  has  $p$  path components. One component just consists of a point corresponding to the subgroup  $A$ . In addition,  $p - 2$  other components are also just points corresponding to the subgroups  $B_k$  for  $k \in \{1, \dots, p-2\}$ . Finally, the last component is a 1-dimensional simplicial complex corresponding to the subgroups listed in diagram 2.8, which we duplicate here:

$$\begin{array}{ccc}
 & B_0 & \\
 & \downarrow & \\
 & D & \\
 \nearrow & & \nwarrow \\
 B_{p-1} & & C \\
 \searrow & & \swarrow \\
 & E &
 \end{array}$$

We have already calculated (in the lemmas of the previous chapter) the contributions of all of the vertices in  $|\mathcal{B}|$  to the  $E_1$  page in 2.3.

The contribution of a 1-simplex in  $|\mathcal{B}|$  can be obtained by taking the cohomology of the intersections of the normalizers of the vertices of the 1-simplex. Note that

each of these intersections is a finite group (since each is a subgroup of either the finite group  $N_{Aut(F_n)}(D)$  or  $N_{Aut(F_n)}(E)$  of normalizing graph automorphisms.) In this way, we can calculate the (now just Tate) cohomological contributions of the 1-simplices in 2.8 to be:

$$\begin{aligned}
\hat{H}^*(N_{Aut(F_n)}(D) \cap N_{Aut(F_n)}(B_0); \mathbb{Z}_{(p)}) &= \hat{H}^*(N_{\Sigma_p}(\mathbb{Z}/p) \times N_{\Sigma_p}(\mathbb{Z}/p); \mathbb{Z}_{(p)}) \\
&= \hat{H}^*(\Sigma_p \times \Sigma_p; \mathbb{Z}_{(p)}). \\
\hat{H}^*(N_{Aut(F_n)}(D) \cap N_{Aut(F_n)}(B_{p-1}); \mathbb{Z}_{(p)}) &= \hat{H}^*(N_{\Sigma_p}(\mathbb{Z}/p) \times N_{\Sigma_p}(\mathbb{Z}/p); \mathbb{Z}_{(p)}) \\
&= \hat{H}^*(\Sigma_p \times \Sigma_p; \mathbb{Z}_{(p)}). \\
\hat{H}^t(N_{Aut(F_n)}(D) \cap N_{Aut(F_n)}(C); \mathbb{Z}_{(p)}) &= \hat{H}^t((\mathbb{Z}/p \times \mathbb{Z}/p) \rtimes \mathbb{Z}/(p-1); \mathbb{Z}_{(p)}) \\
&= \begin{cases} \mathbb{Z}/p^2 & t = 0 \\ (k(p-1) + 1)\mathbb{Z}/p & |t| = kn \neq 0 \\ (k(p-1) - 1)\mathbb{Z}/p & |t| = kn - 1 \\ 0 & \text{otherwise} \end{cases} \\
\hat{H}^*(N_{Aut(F_n)}(E) \cap N_{Aut(F_n)}(B_{p-1}); \mathbb{Z}_{(p)}) &= \hat{H}^*(N_{\Sigma_p}(\mathbb{Z}/p) \times N_{\Sigma_p}(\mathbb{Z}/p); \mathbb{Z}_{(p)}) \\
&= \hat{H}^*(\Sigma_p \times \Sigma_p; \mathbb{Z}_{(p)}). \\
\hat{H}^t(N_{Aut(F_n)}(E) \cap N_{Aut(F_n)}(C); \mathbb{Z}_{(p)}) &= \hat{H}^t((\mathbb{Z}/p \times \mathbb{Z}/p) \rtimes (\mathbb{Z}/2 \times \mathbb{Z}/(p-1)); \mathbb{Z}_{(p)}) \\
&= \begin{cases} \mathbb{Z}/p^2 & t = 0 \\ (\frac{k(p-1)}{2} + 1)\mathbb{Z}/p & |t| = kn \neq 0 \\ (\frac{k(p-1)}{2})\mathbb{Z}/p & |t| = kn - 1 \\ 0 & \text{otherwise} \end{cases}
\end{aligned}$$

(Note that  $N_{Aut(F_n)}(E) \cap N_{Aut(F_n)}(B_{p-1})$  is not  $(N_{\Sigma_p}(\mathbb{Z}/p) \times N_{\Sigma_p}(\mathbb{Z}/p)) \rtimes \mathbb{Z}/2$  as you might expect, because the map that “flips” the two sides of  $\Psi_n$  is not in the normalizer  $N_{Aut(F_n)}(B_{p-1})$ .)

We are now ready to compute the  $E_2$  page of the spectral sequence 2.3. The contributions coming from the isolated points of  $|\mathcal{B}|$  (i.e., from  $A, B_1, \dots, B_{p-2}$ )

survive unaltered from the  $E_1$  page. The contributions from the 1-dimensional component of  $|\mathcal{B}|$  pictured in 2.8 will be what we concentrate on from now on.

First off, it is easy to compute the values for the  $E_2$  page in rows  $s$  where  $s = nj + k$  with  $2 \leq k \leq 2(p-2)$ . This is because the  $E_1$  page is only nonzero in the column  $r = 0$  for these rows. Hence the entries in  $E_1^{0,s}$  necessarily survive to the  $E_2$  page and from there survive to the  $E_\infty$  page. This gives us that  $\hat{H}^t(\text{Aut}(F_n); \mathbb{Z}_{(p)})$  is as the proposition claims for  $t = nj + k$  with  $2 \leq k \leq 2(p-2)$ .

For the rest of our calculations, we will use the fact that the boundary map on the  $E_1$  page is just the restriction map. From a comment by Brown in [7] on page 286, we know that we can compute these restriction maps (from normalizers of  $p$ -subgroups to finite subgroups of those normalizers) just by looking at the  $E_2$  pages of the various spectral sequences used to compute the cohomologies of the normalizers (in the lemmas of the previous chapter.) This will help us to compute, for any row  $s$ , the value  $E_2^{0,s}$ . As an example of this, consider the copy of  $\hat{H}^*(N_{\text{Aut}(F_n)}(B_0); \mathbb{Z}_{(p)})$  contained in the column  $E_2^{0,s}$  of our spectral sequence 2.3. Recall from Lemma 5.12 that the cohomology of  $N_{\text{Aut}(F_n)}(B_0)$  is

$$\hat{H}^t(N_{\text{Aut}(F_n)}(B_0); \mathbb{Z}_{(p)}) = \begin{cases} \mathbb{Z}/p^2 & t = 0 \\ (j+1)\mathbb{Z}/p & |t| = nj \neq 0 \\ (j-1)\mathbb{Z}/p & |t| = nj - 1 \\ 0 & |t| \equiv 1 \pmod{n} \\ 0 & t \equiv 2 \pmod{n} \\ H^r(Q_{p-1}; \mathbb{Z}/p) & t \equiv r \pmod{n}, \\ & 3 \leq r \leq n-2 \end{cases}$$



and this was calculated by looking at a spectral sequence whose  $\mathcal{E}_2$  page (which we now denote with a script  $E$  as  $\mathcal{E}$  to distinguish it from the spectral sequence 2.3 above) is

$$\mathcal{E}_2^{r,s} = \begin{cases} \mathbb{Z}/p^2 & r = 0 \text{ and } s = 0 \\ H^r(Q_{p-1}; \mathbb{Z}/p) & 1 \leq r \leq 2(p-2), s = kn \\ (j-1)\mathbb{Z}/p & r = 0 \text{ and } |s| = nj - 1 \\ (j+1)\mathbb{Z}/p & r = 0 \text{ and } |s| = nj \neq 0 \\ 0 & \text{otherwise} \end{cases}$$

From Proposition (4.6) in [7], the restriction map from  $\hat{H}^*(N_{Aut(F_n)}(B_0); \mathbb{Z}_{(p)})$  to the ring  $\mathfrak{H}^*(N_{Aut(F_n)}(B_0); \mathbb{Z}_{(p)})$  deriving from the cohomology of the finite subgroups of  $N_{Aut(F_n)}(B_0)$  (see [7] for a definition of this ring) is just the canonical surjection coming from the vertical edge homomorphism

$$\hat{H}^t(N_{Aut(F_n)}(B_0); \mathbb{Z}_{(p)}) \rightarrow \mathcal{E}_2^{0,t} = \hat{H}^t(N_{\Sigma_p}(\mathbb{Z}/p) \times N_{\Sigma_p}(\mathbb{Z}/p); \mathbb{Z}_{(p)})$$

where

$$\hat{H}^t(N_{\Sigma_p}(\mathbb{Z}/p) \times N_{\Sigma_p}(\mathbb{Z}/p); \mathbb{Z}_{(p)}) = \begin{cases} \mathbb{Z}/p^2 & t = 0 \\ (j+1)\mathbb{Z}/p & |t| = nj \neq 0 \\ (j-1)\mathbb{Z}/p & |t| = nj - 1 \\ 0 & \text{otherwise} \end{cases}$$

Recall that in order to know the column  $E_2^{0,s}$  of 2.3, we want to calculate the restriction map

$$\begin{aligned} \hat{H}^*(N_{Aut(F_n)}(B_0); \mathbb{Z}_{(p)}) &\rightarrow \hat{H}^*(N_{Aut(F_n)}(B_0) \cap N_{Aut(F_n)}(D)) \\ &= \hat{H}^*(N_{\Sigma_p}(\mathbb{Z}/p) \times N_{\Sigma_p}(\mathbb{Z}/p); \mathbb{Z}_{(p)}) \end{aligned}$$

So from the above work this restriction map is just the vertical edge homomorphism calculated above. We can similarly look at the  $\mathcal{E}_2$ -pages of the other spectral

sequences in chapter 5 to calculate the restriction maps from the cohomologies of  $N_{Aut(F_n)}(B_{p-1})$  and  $N_{Aut(F_n)}(C)$  to their finite subgroups

$$N_{Aut(F_n)}(B_{p-1}) \cap N_{Aut(F_n)}(D), \quad N_{Aut(F_n)}(B_{p-1}) \cap N_{Aut(F_n)}(E),$$

$$N_{Aut(F_n)}(C) \cap N_{Aut(F_n)}(D), \quad \text{and} \quad N_{Aut(F_n)}(C) \cap N_{Aut(F_n)}(E).$$

On the other hand, the restrictions from  $N_{Aut(F_n)}(D)$  and  $N_{Aut(F_n)}(E)$  to their subgroups are easy to compute as  $N_{Aut(F_n)}(D)$  and  $N_{Aut(F_n)}(E)$  are just well known finite groups.

After calculating all of the terms in the column  $E_2^{0,s}$  of 2.3 as above, the value  $E_2^{1,s}$  is found from an Euler characteristic argument using  $E_1^{0,s}$  and  $E_1^{1,s}$ . That is, if  $s \neq 0$  then  $E_1^{0,s}$  and  $E_1^{1,s}$  are the only nonzero terms on the row  $s$  and they are both  $\mathbb{F}_p$ -vector spaces. As the boundary map goes from  $E_1^{0,s} \rightarrow E_1^{1,s}$ , this yields  $\dim_{\mathbb{F}_p}(E_1^{0,s}) - \dim_{\mathbb{F}_p}(E_1^{1,s}) = \dim_{\mathbb{F}_p}(E_2^{0,s}) - \dim_{\mathbb{F}_p}(E_2^{1,s})$  by the standard Euler characteristic argument.

Assume  $s = -kn + 1 < 0$  (the case  $s = kn - 1 > 0$  follows similarly, with the only exception being the additional summand of  $H^{n-1}(\tilde{Q}_{p-1}; \mathbb{Z}/p)$  that needs to be dealt with.) Then  $E_2^{0,s} = (k + [k/2] - 1)\mathbb{Z}/p$ . Now  $k - 1$  of these  $\mathbb{Z}/p$ 's come from 0-cocycles that are summations of cocycles from:

- The portion of  $\hat{H}^s(N_{Aut(F_n)}(B_{p-1}); \mathbb{Z}_{(p)})$  coming from the graph  $\Omega_n$ . (In the spectral sequence we used to calculate  $\hat{H}^s(N_{Aut(F_n)}(B_{p-1}); \mathbb{Z}_{(p)})$  in part 3. of Lemma 5.12, this was the contribution given by the stabilizer of the graph  $\Theta_{p-1}^2$ .)
- $\hat{H}^s(N_{Aut(F_n)}(D); \mathbb{Z}_{(p)})$ .

- $\hat{H}^s(N_{Aut(F_n)}(B_0); \mathbb{Z}_{(p)})$ .
- The portion of  $\hat{H}^s(N_{Aut(F_n)}(C); \mathbb{Z}_{(p)})$  coming from the graph  $\Omega_n$  (in the spectral sequence we used to calculate  $\hat{H}^s(N_{Aut(F_n)}(C)); \mathbb{Z}_{(p)}$ .)

The other  $[k/2]$  of the  $\mathbb{Z}/p$ 's come from 0-cocycles that are summations of cocycles from:

- The portion of  $\hat{H}^s(N_{Aut(F_n)}(B_{p-1}); \mathbb{Z}_{(p)})$  coming from the graph  $\Psi_n$ . (In the spectral sequence we used to calculate  $\hat{H}^s(N_{Aut(F_n)}(B_{p-1}); \mathbb{Z}_{(p)})$  in part 3. of Lemma 5.12, this was the contribution given by the stabilizer of the graph  $\Theta_{p-1}^1$ .)
- $\hat{H}^s(N_{Aut(F_n)}(E); \mathbb{Z}_{(p)})$ .
- The portion of  $\hat{H}^s(N_{Aut(F_n)}(C); \mathbb{Z}_{(p)})$  coming from the graph  $\Psi_n$  (in the spectral sequence we used to calculate  $\hat{H}^s(N_{Aut(F_n)}(C)); \mathbb{Z}_{(p)}$ .)

This allows us to find that the contribution of the component of  $|\mathcal{B}|$  corresponding to diagram 2.8 in the row  $s = -kn + 1 < 0$  is  $E_2^{0,s} = (k + [k/2] - 1)\mathbb{Z}/p$ . Since  $\dim_{\mathbb{F}_p}(E_1^{0,s}) - \dim_{\mathbb{F}_p}(E_1^{1,s}) =$

$$(4(k-1) + \frac{3k(p-1)}{2} + [k/2] - 1) - (3(k-1) + \frac{3k(p-1)}{2}) = k + [k/2] - 1,$$

we find that  $E_2^{1,s} = 0$ .

Assume  $s = kn > 0$  or  $s = -kn < 0$ . Then  $E_2^{0,s} = (k + [k/2] + p - 1)\mathbb{Z}/p$ . First, observe that  $p-1$  of these  $\mathbb{Z}/p$ 's come from the points in  $|\mathcal{B}|$  corresponding to  $A, B_1, \dots, B_{p-2}$ . Also,  $k-1$  of these  $\mathbb{Z}/p$ 's come from summations of cocycles in  $H^s(N; \mathbb{Z}_{(p)})$

for  $N$  equal to  $N_{Aut(F_n)}(B_0)$ ,  $N_{Aut(F_n)}(B_{p-1})$ ,  $N_{Aut(F_n)}(C)$ , and  $N_{Aut(F_n)}(E)$  where in all cases the cohomology came from the graph  $\Omega_n$  (in the spectral sequences used to calculate the cohomology groups of the various normalizers.) In addition,  $[k/2]$  of the  $\mathbb{Z}/p$ 's come from 0-cocycles that are summations of cocycles from  $H^s(N; \mathbb{Z}/p)$  for  $N$  equal to  $N_{Aut(F_n)}(B_{p-1})$ ,  $N_{Aut(F_n)}(C)$ , and  $N_{Aut(F_n)}(E)$  where in all cases the cohomology came from the graph  $\Psi_n$ . Finally, one cocycle comes from summing up cocycles from  $H^s(N; \mathbb{Z}/p)$  for  $N$  equal to  $N_{Aut(F_n)}(B_0)$ ,  $N_{Aut(F_n)}(B_{p-1})$ ,  $N_{Aut(F_n)}(C)$ ,  $N_{Aut(F_n)}(D)$ , and  $N_{Aut(F_n)}(E)$ . This allows us to find that the contribution of the component of  $B$  corresponding to diagram 2.8 in the row  $s = kn > 0$  or  $s = -kn < 0$  is  $E_2^{0,s} = (k + [k/2] + p - 1)\mathbb{Z}/p$ . Note that because  $\dim_{\mathbb{F}_p}(E_1^{0,s}) - \dim_{\mathbb{F}_p}(E_1^{1,s}) =$

$$(4k + \frac{(3k+2)(p-1)}{2} + [k/2] + 5) - (3k + \frac{3k(p-1)}{2} + 5) = k + [k/2] + p - 1,$$

we find that  $E_2^{1,s} = 0$ .

Next,  $E_2^{0,0}$  is readily computed to be  $\mathbb{Z}/p^2 \oplus p(\mathbb{Z}/p)$ , where  $p - 1$  of the  $\mathbb{Z}/p$ 's come from the isolated points of  $|\mathcal{B}|$  and  $\mathbb{Z}/p^2 \oplus \mathbb{Z}/p$  comes from vertices in the 1-dimensional component of  $|\mathcal{B}|$ . Finally,  $E_2^{0,1} = \mathbb{Z}/p$  where the  $\mathbb{Z}/p$  corresponds to edges of  $|\mathcal{B}|$  which give cohomology classes in  $E_1^{0,1}$  that are not mapped onto by cohomology classes in  $E_1^{0,0}$ .  $\square$

# Chapter 7

## Notes about the usual cohomology of $Aut(F_{2(p-1)})$

We now state what our calculations using Farrell cohomology tell us about the usual cohomology of  $Aut(F_n)$ ,  $n = 2(p - 1)$ .

### Proposition 7.1

$$H^t(Aut(F_n); \mathbb{Z}_{(p)}) = \begin{cases} \hat{H}^t(Aut(F_n); \mathbb{Z}_{(p)}) & t > 4p - 6 \\ H^t(Q_n; \mathbb{Z}_{(p)}) & 0 \leq t \leq 2p - 3 \end{cases}$$

**Proof.** Since the virtual cohomological dimension of  $Aut(F_n)$  is  $4p - 6$ , it follows directly (see [7]) that  $H^t(Aut(F_n); \mathbb{Z}_{(p)}) = \hat{H}^t(Aut(F_n); \mathbb{Z}_{(p)})$  for  $t > 4p - 6$  and that the sequence

$$H^m(\Gamma; \mathbb{Z}_{(p)}) \rightarrow H^m(Aut(F_n); \mathbb{Z}_{(p)}) \rightarrow \hat{H}^m(Aut(F_n); \mathbb{Z}_{(p)}) \rightarrow 0$$

is exact for  $m = 4p - 6$ , where  $\Gamma$  is any torsion free subgroup of  $Aut(F_n)$  of finite index and where the first map is the transfer map.

To establish the final part of the proposition, we can use the spectral sequence 1.1 to calculate  $H^t(\text{Aut}(F_n); \mathbb{Z}_{(p)})$  for  $0 \leq t \leq 2p - 3$ . We want to show that for  $0 < s \leq 2p - 3$ , the rows  $\tilde{E}_2^{t,s}$  on the  $E_2$  page of this spectral sequence, are all zero. If this is true, then the cohomology of  $\text{Aut}(F_n)$  for  $0 \leq s \leq 2p - 3$  comes just from the terms  $H^s(Q_n; \mathbb{Z}_{(p)})$  on the horizontal axis of the  $E_2$  page, which proves the proposition.

On the  $E_1$ -page of the spectral sequence 1.1, the only simplices that contribute to terms above the horizontal axis are ones with “ $p$ -symmetry”. In other words, let  $X_s$  be the  $p$ -singular locus of  $X_n$ , or the set of all simplices in  $X_n$  such that  $p$  divides  $|\text{stab}(\delta)|$ . Then  $\text{Aut}(F_n)$  also acts on  $X_s$  and there is a spectral sequence analogous to 1.1 which calculates the equivariant cohomology  $H_{\text{Aut}(F_n)}^*(X_s; \mathbb{Z}_{(p)})$ . Above the horizontal axes, the  $E_1$ -pages of the two spectral sequences (i.e., the ones corresponding to  $X_n$  and  $X_s$ ) are the same. In particular, the boundary maps  $E_1^{r,s} \rightarrow E_1^{r+1,s}$  are the same so that the entries  $E_2^{r,s}$  of the two spectral sequences are identical for  $s > 0$ . So we have reduced the problem to showing that for  $0 < s \leq 2p - 3$ , the rows  $\tilde{E}_2^{*,s}$  on the  $E_2$ -page of this spectral sequence for calculating  $H_{\text{Aut}(F_n)}^*(X_s; \mathbb{Z}_{(p)})$ , are all zero. But note that  $X_s$  separates into  $p$  disjoint,  $\text{Aut}(F_n)$ -invariant (not necessarily connected) subcomplexes corresponding to the  $p$  path components of  $|\mathcal{B}|$ . (These path components were mentioned in the proof of Theorem 6.1.) So we see that

$$H_{\text{Aut}(F_n)}^*(X_s; \mathbb{Z}_{(p)}) = \prod_Y \hat{H}_{\text{Aut}(F_n)}^*(Y; \mathbb{Z}_{(p)})$$

where  $Y$  ranges over the  $p$  distinct, disjoint,  $\text{Aut}(F_n)$ -invariant subcomplexes. Hence the  $E_1$  and  $E_2$  pages can be calculated separately for each  $Y$ . Recall that we are only

concerned with calculating the  $E_2$  page in the horizontal rows between 1 and  $2p-3$ . The only simplices of  $X_n^s$  that contribute terms to these rows are the ones with dihedral symmetry. Now only one of the subcomplexes  $Y$  has dihedral symmetry in it and is relevant; namely, the subcomplex  $Y_A$  which has marked graphs with underlying graph the rose  $R_n$  in it. (This subcomplex  $Y_A$  corresponds to the fixed point subcomplex  $X_n^A$ . More precisely,  $Y_A$  is  $\text{Aut}(F_n) \cdot X_n^A$ , several disjoint copies of  $X_n^A$  grouped together.) Let  $\Xi_p$  be the 1-skeleton of the cone over a  $p$ -gon. Note that  $\Xi_p$  has dihedral symmetry; moreover, marked graphs with underlying graph of the form  $\Xi_p \vee \Gamma_{p-2}$  are in  $Y_A$  and have dihedral symmetry, where  $\Gamma_{p-2}$  is any graph with fundamental group isomorphic to  $F_{p-2}$ .

Now consider a specific path component of  $Y_A$ , say  $X_n^A$ . There is an action of  $A \cong \mathbb{Z}/p$  on each simplex of  $X_n^A$ . In [19], Krstic and Vogtmann define an equivariant deformation retract  $L_A$  of  $X_n^A$  by only keeping the “essential graphs” in  $X_n^A$ . Among the graphs that are in  $X_n^A - L_A$  are all of the ones with dihedral symmetry, along with various other inessential graphs. The ones with dihedral symmetry are of the form  $\Xi_p \vee \Gamma_{p-2}$  mentioned above (where the basepoint is in  $\Gamma_{p-2}$  and the wedge doesn’t necessarily take place at the basepoint.) We can use the same idea that Krstic and Vogtmann used and define  $L'_A$  to be the subcomplex of  $X_n^A$  obtained by collapsing out graphs with dihedral symmetry. By the same poset lemma used in [19], the obvious collapse from  $X_n^A$  to  $L'_A$  is an equivariant deformation retraction. Observe that  $X_n^A \supseteq L'_A \supseteq L_A$ .

The contribution of the equivariant cohomology of  $Y_A$  to  $\tilde{E}_1^{r,s}$  is the same as that for the  $E_1$ -page of the spectral sequence used to calculate the equivariant cohomol-

ogy of  $N_{Aut(F_n)}(A)$  acting on  $X_n^A$ . (This follows immediately, as  $Y_A$  is  $Aut(F_n) \cdot X_n^A$  in  $X_s$  so that we see that the  $E_1$ -pages of the equivariant spectral sequences used to calculate  $\hat{H}_{Aut(F_n)}^*(Y_A; \mathbb{Z}_{(p)})$  and  $\hat{H}_{N_{Aut(F_n)}(A)}^*(X_n^A; \mathbb{Z}_{(p)})$  are identical.)

To avoid confusion, denote the  $E_1$ -page of the spectral sequence used to calculate  $\hat{H}_{N_{Aut(F_n)}(A)}^*(X_n^A; \mathbb{Z}_{(p)})$  by  $\mathcal{E}_1^{r,s}$ . We want to show that  $\mathcal{E}_1^{*,s} = 0$  for  $0 < s \leq 2p - 3$ . For  $0 < s \leq 2p - 3$  and  $s \neq 4k$ , the row  $\mathcal{E}_1^{*,s}$  is all zero. On the other hand, for  $0 < s = 4k < 2p - 3$ , direct examination (since only simplices  $\sigma$  in  $X_n^A - L'_A$  contribute to the row  $\mathcal{E}_1^{*,s}$  and  $H^s(stab(\sigma); \mathbb{Z}_{(p)}) = \mathbb{Z}/p$  for such simplices) reveals that the row  $\mathcal{E}_1^{*,s}$  is just the relative cochain complex  $C^*(X_n/N_{Aut(F_n)}(A), L'_A/N_{Aut(F_n)}(A); \mathbb{Z}/p)$ . Because the homotopy in the deformation retraction from  $X_n^A$  to  $L'_A$  is  $N_{Aut(F_n)}(A)$ -equivariant, we see that the relative cohomology groups

$$H^*(X_n/N_{Aut(F_n)}(A), L'_A/N_{Aut(F_n)}(A); \mathbb{Z}/p)$$

are all zero. Hence all of the rows  $\mathcal{E}_2^{r,s}$  are zero for  $0 < s \leq 2p - 3$ , which completes the proof.  $\square$



# Chapter 8

## The Farrell cohomology of $Aut(F_l)$ for $l < 2(p - 1)$

For  $l < p - 1$  an easy spectral sequence argument yields that  $\hat{H}^*(Aut(F_l); \mathbb{Z}_{(p)}) = 0$ . We have already remarked that Glover and Mislin's work in [12] directly implies that  $\hat{H}^*(Aut(F_{p-1}); \mathbb{Z}_{(p)}) = \hat{H}^*(\Sigma_p; \mathbb{Z}_{(p)})$ ,  $\hat{H}^*(Aut(F_p); \mathbb{Z}_{(p)}) = 3\hat{H}^*(\Sigma_p; \mathbb{Z}_{(p)})$ , and we have noted that Yu Qing Chen's work in [9] shows that

$$\hat{H}^*(Aut(F_{p+1}); \mathbb{Z}_{(p)}) = 4\hat{H}^*(\Sigma_p; \mathbb{Z}_{(p)})$$

and that  $\hat{H}^t(Aut(F_{p+1}); \mathbb{Z}_{(p)}) = 5\hat{H}^t(\Sigma_p; \mathbb{Z}_{(p)}) \oplus \hat{H}^{t-4}(\Sigma_p; \mathbb{Z}_{(p)})$ .

In this chapter, we show how to calculate  $\hat{H}^*(Aut(F_l); \mathbb{Z}_{(p)})$  for  $p \leq l < n$ , where  $n = 2(p - 1)$ . We do this by modifying in a direct manner the arguments we have made in the previous chapters to calculate  $\hat{H}^*(Aut(F_{2(p-1)}); \mathbb{Z}_{(p)})$ . (It should be noted that using the normalizer spectral sequence perhaps amounts to overkill in these situations, however, as the realization  $|\mathcal{B}|$  of conjugacy classes of elementary

abelian  $p$ -subgroups is just a collection of  $l - p + 3$  points.)

As before, one of the elements of  $\mathcal{B}$  corresponds to the subgroup  $A \cong \mathbb{Z}/p$  of  $\text{Aut}(F_l)$  obtained by rotating the first  $p$  petals of the rose  $R_l$ . The other elements of  $\mathcal{B}$  correspond to subgroups  $B_k \cong \mathbb{Z}/p$  for  $k \in \{0, \dots, l - p + 1\}$ . The subgroup  $B_k$  is obtained, as before, by rotating the  $p$ -edges of the  $\Theta$ -graph in the middle of  $R_k \vee \Theta_{p-1} \vee R_{l-p+1-k}$ .

As in Lemma 5.10, we see that

$$N_{\text{Aut}(F_l)}(A) \cong N_{\Sigma_p}(\mathbb{Z}/p) \times ((F_{l-p} \times F_{l-p}) \rtimes (\mathbb{Z}/2 \times \text{Aut}(F_{l-p})))$$

where the semi-direct product corresponds to the obvious action of  $\mathbb{Z}/2 \times \text{Aut}(F_{l-p})$  on  $F_{l-p} \times F_{l-p}$ . Let  $\langle \omega \rangle \cong \mathbb{Z}/2$  be the subgroup of  $\text{Aut}(F_{l-p+2})$  corresponding to the action given by switching the first two petals of the rose  $R_{l-p+2}$ . Accordingly,

$$N_{\text{Aut}(F_l)}(A) \cong C_{\text{Aut}(F_l)}(A) \cong (F_{l-p} \times F_{l-p}) \rtimes (\mathbb{Z}/2 \times \text{Aut}(F_{l-p})).$$

As in Definition 4.2, let  $X_{l-p+2}^{(\omega)}$  be the fixed point set of  $\omega$  in  $X_{l-p+2}$ . Then let  $X_{l-p+2}^\omega$  be the deformation retract of  $X_{l-p+2}^{(\omega)}$  obtained by collapsing out inessential edges of marked graphs. Finally, define  $Q_{l-p+2}^\omega$  to be the quotient of  $X_{l-p+2}^\omega$  by  $N_{\text{Aut}(F_{l-p+2})}(\omega)$ .

Putting all of this together, and using the same methods as those used in Lemma 5.10, Lemma 5.12 and Theorem 6.1, we see that

$$\hat{H}^t(N_{\text{Aut}(F_l)}(A); \mathbb{Z}(p)) = \begin{cases} \mathbb{Z}/p & t \equiv 0 \pmod{n} \\ H^r(Q_{l-p+2}^\omega; \mathbb{Z}/p) & t \equiv r \pmod{n}, \\ & 2 \leq r \leq 2(l-p) \\ 0 & \text{otherwise} \end{cases}$$

and that for  $k \in \{0, \dots, l - p + 1\}$ ,

$$\hat{H}^t(N_{Aut(F_l)}(B_k); \mathbb{Z}_{(p)}) =$$

$$\begin{cases} \mathbb{Z}/p & t \equiv 0 \pmod{n} \\ H^r(\tilde{Q}_k \times Q_{p-1-k}; \mathbb{Z}/p) & t \equiv r \pmod{n}, \\ & 2 \leq r \leq 2(l-p) + 1 \\ 0 & \text{otherwise} \end{cases}$$

so we have that for  $p$  odd and  $l \in \{p, \dots, 2p - 3\}$ ,

$$\hat{H}^t(Aut(F_l); \mathbb{Z}_{(p)}) =$$

$$\begin{cases} (l-p+3)\mathbb{Z}/p & t \equiv 0 \pmod{n} \\ \sum_{k=0}^{l-p+1} H^r(\tilde{Q}_k \times Q_{l-p+1-k}; \mathbb{Z}/p) & t \equiv r \pmod{n}, \\ \oplus H^r(Q_{l-p+2}^\omega; \mathbb{Z}/p) & 2 \leq r \leq 2(l-p) + 1 \\ 0 & \text{otherwise} \end{cases}$$

The aforementioned results of Glover and Mislin and Chen give more information than our results here, however, as they actually explicitly calculate the cohomology groups

$$\sum_{k=0}^{l-p+1} H^r(\tilde{Q}_k \times Q_{l-p+1-k}; \mathbb{Z}/p) \oplus H^r(Q_{l-p+2}^\omega; \mathbb{Z}/p)$$

that arise in the above formula in their cases.

## Part II

### Modified degree theorem

# Chapter 9

## The modified degree theorem

Before reading Part II, we strongly recommend that the reader study the entirety of [15] by Hatcher and Vogtmann. This part is essentially a modification of their results on the space  $X_n$  to the space  $\tilde{X}_n$  and is not meant to be read independently of their work.

Our goal is to use a modified version of Hatcher and Vogtmann's Degree Theorem and roughly similar computer calculations to those used by Hatcher and Vogtmann in [16], to establish Fact 5.9 which stated that

$$H^2(\tilde{Q}_{p-1}; \mathbb{Z}/p) = 0$$

and was needed in the last part of the proof of Lemma 5.12.

In this chapter and the following one, we will use the notation developed in Proposition 4.4 for describing marked graphs in  $\tilde{X}_n$ . (For this and the following chapter, take  $n$  be just any positive integer, rather than  $2(p-1)$  as we often did in Part I.)

Define the *degree* of a marked graph

$$(\alpha, f) : R_n \coprod I \rightarrow \Gamma_n$$

or, equivalently, the degree of the underlying graph  $\Gamma_n$  of the marked graph, to be

$$\deg(\alpha, f) = \deg(\Gamma_n) = \sum_{v \neq * } |v| - 2,$$

where the sum is over all vertices of  $\Gamma_n$  except the basepoint, and where the valence  $|v|$  of a vertex  $v \neq \circ$  is the number of oriented edges starting at  $v$ . The valence of the vertex  $\circ$  is defined to be one plus the number of oriented edges starting at  $\circ$ . This definition is similar to the one given in [15], but the intuition (which we do not attempt to make precise) is that we treat the vertex  $\circ$  as if it signifies that a small germ of an extra edge is coming into that vertex. Throughout this section, our modified definitions of degree, split degree, canonical splitting, etc., will be motivated by this notion of thinking that the vertex  $\circ$  denotes the germ of another edge entering that vertex.

Let  $\tilde{X}_{n,k}$ ,  $\tilde{Q}_{n,k}$ , and  $\tilde{\mathbb{A}}_{n,k}$  be the subspaces of  $\tilde{X}_n$ ,  $\tilde{Q}_n$ , and  $\tilde{\mathbb{A}}_n$ , respectively, where only marked graphs of degree at most  $k$  are considered.

Our goal is to show that the arguments which Hatcher and Vogtmann used in [15] carry over in an essentially unchanged way to this new context. In particular, we want to prove the following analogue of their degree theorem:

**Theorem 9.1** *A piecewise linear map  $f_0 : D_k \rightarrow \tilde{\mathbb{A}}_n$  is homotopic to a map  $f_1 : D_k \rightarrow \tilde{\mathbb{A}}_{n,k}$  by a homotopy  $f_t$  during which degree decreases monotonically, i.e., if  $t_1 < t_2$  then  $\deg(f_{t_1}(s)) \geq \deg(f_{t_2}(s))$  for all  $s \in D_k$ .*

As in [15], the immediate corollary is

**Corollary 9.2** *The pair  $(\tilde{\mathbb{A}}_n, \tilde{\mathbb{A}}_{n,k})$  is  $k$ -connected.*

In Part III we will show that  $\tilde{\mathbb{A}}_n$  is contractible, so that Corollary 9.2 is equivalent to the statement that  $\tilde{\mathbb{A}}_{n,k}$  is  $(k - 1)$ -connected.

Hatcher and Vogtmann prove their degree theorem by using various homotopies to deform the underlying graphs of marked graphs

$$\alpha : R_n \rightarrow \Gamma_n.$$

We will use these same homotopies to deform the marked graphs

$$(\alpha, f) : R_n \amalg I \rightarrow \Gamma_n$$

that appear in the context of  $\tilde{\mathbb{A}}_n$ . In a remark following “Stage 1: Simplifying the critical point” in [15], Hatcher and Vogtmann mention that it is obvious where their homotopies of the underlying graph  $\Gamma_n$  send the basepoint  $*$  and the marking  $\alpha$ . Our task is to decide where these homotopies send the extra point  $\circ$  on the graph. It will then be clear where the homotopies send the path  $f$  from  $*$  to  $\circ$  in the graph  $\Gamma_n$ .

As in the case of  $\mathbb{A}_n$ , graphs in  $\tilde{\mathbb{A}}_n$  come equipped with a “height function” measuring distance to the basepoint. A point in the graph is a *critical point* if near that point there is more than one way to travel “down” toward the basepoint.

A few notes are in order about specific parts of the paper by Hatcher and Vogtmann and how these should be modified:

1. Canonical splittings. A procedure called “canonical splitting” is defined in [15] which is used to decrease the degrees of graphs (with lengths assigned to their edges) in a canonical way. In our new case, think of  $\circ$  as denoting the germ of an extra edge attached to the graph at that point. A canonical splitting should split this extra edge down to the next critical point, assuming  $\circ$  is not already a critical point itself. In other words, a canonical splitting should move  $\circ$  down to the next critical point or the basepoint, provided  $\circ$  is not already a critical point. Otherwise, do the canonical splitting as described in [15]. See Figure 9.1 for examples.

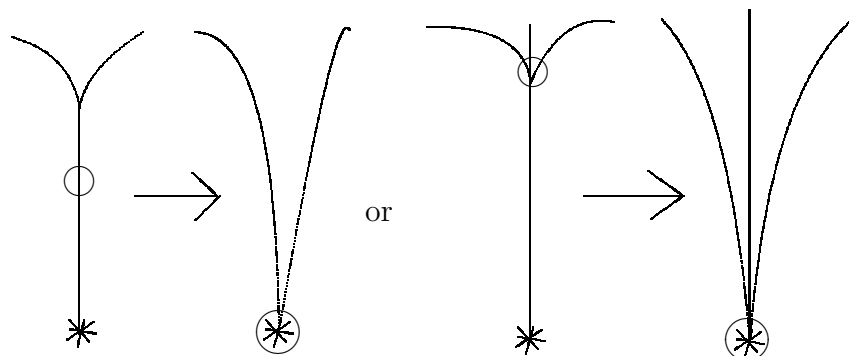

Figure 9.1: Canonical splittings

2. Sliding  $\epsilon$ -cones. This is another procedure defined by Hatcher and Vogtmann to reduce degrees, and can be directly modified by taking  $\circ$  to signify that the germ of an extra edge is attached there. In other words,  $\circ$  signifies the attaching point of an extra branch lying above that vertex. Just like the attaching points of other branches lying above the critical point, it can be



perturbed slightly off of the critical point. The result of this is that  $\circ$  is perturbed slightly downward off the critical point.

3. Codimension. Codimension is defined without trouble as before. Namely, the *codimension* of a point on the graph is one less than the number of downward directions from that point. The *codimension* of a graph is the sum of the codimensions of its critical points.

Figure 9.2 below shows some examples of this when we are calculating the codimension of  $\circ$  in a graph.

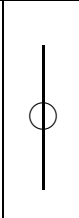
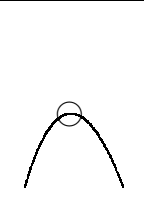
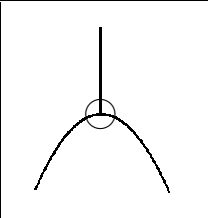
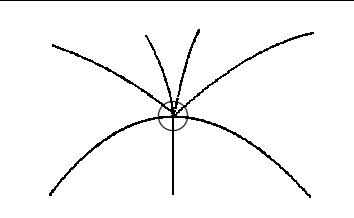
vertex				
codim	0	$2-1=1$	$2-1=1$	$3-1=2$

(Note that the vertex in the first example is not a critical point, while the vertices in the latter three examples are critical points.)

Figure 9.2: Some examples of codimensions concerning  $\circ$

To illustrate this, consider the second example in the above figure. There are two different ways to start an edgepath going down from the vertex  $\circ$ . If both of these edges leading down from  $\circ$ , say  $a$  and  $b$ , went directly to the basepoint, then the condition that they have equal length would be given by  $2 - 1 = 1$  linear equations among the lengths of the edges of the graph. In other words, the vertex  $\circ$  has codimension 1 and the graph is contained in the hyperplane

$l(a) = l(b)$  of codimension 1. Thus a stratum where the codimension is equal to  $i$  is contained in a critical plane of codimension  $i$ .

4. Lemma 4.1. This lemma is fine as stated because the same proof with its statements about codimension remains true when applied to the new space  $\tilde{A}_n$ .
5. Lemma 4.2. During the homotopies used in Lemma 4.2, only the lengths of the edges of the underlying graph  $\Gamma_n$  are perturbed. The combinatorial structure of the graph is not changed at all. Hence it is clear where  $\circ$  and the path  $f$  from  $*$  to  $\circ$  are sent during these homotopies.
6. Complexity. As before, we think of  $\circ$  as meaning that the germ of an extra edge is attached there. Previously, Hatcher and Vogtmann defined a connecting path in the graph as a downward path from one critical point to another. We just modify this by saying that the extra germ attached at  $\circ$  counts as the beginning of a downward path that came from a critical point (although, of course, there is no critical point at the top of this extra path, which is why we just consider  $\circ$  to be the germ of an attached edge, rather than a whole extra edge attached.) With this convention, complexity  $c_s$  is defined as in [15] as the number of connecting paths in the graph. Also,  $e_s$  is the number of connecting paths without critical points in their interiors. See Figure 9.3.

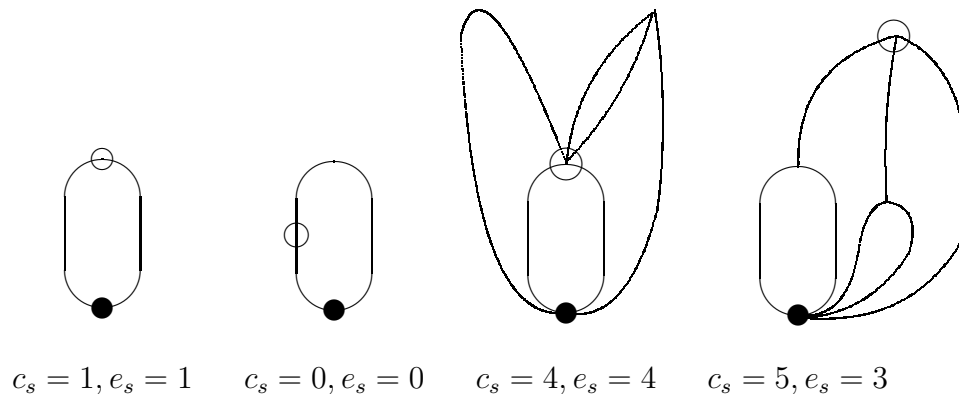

Figure 9.3: Complexity examples with  $\circ$

With this definition of complexity in mind, the section “canonical splitting and extension to a neighborhood” can be done as before. For the section “reducing complexity by sliding in the  $\epsilon$ -cones”, consider  $\circ$  as giving an attaching point  $\alpha_j$  of a branch  $\beta_j$ . Now argue as directed in [15].

7. Reducing the degree. The final section, “Reducing the degree”, presents no further difficulties. Define the split degree of a graph as the degree of its canonical splitting. All of the codimension arguments check out because Lemma 4.2 still holds in this new context.

Using the above guidelines, the proof of Theorem 9.1 is immediate from the work of Hatcher and Vogtmann in [15].

# Chapter 10

## Using the modified degree theorem

We now describe how the modified degree theorem, Theorem 9.1, can be used to calculate  $H_2(\tilde{Q}_n; \mathbb{Z}/p) = 0$ . The idea to use low dimensional calculations and the degree theorem to calculate rational homology groups of spaces having to do with  $Aut(F_n)$  and  $Out(F_n)$  comes from Hatcher and Vogtmann's work in [16]. In addition, much of the specific methods used to calculate  $H_2(\tilde{Q}_n; \mathbb{Z}/p) = 0$  here come from their work, the only real exceptions being modifying the methods to work with different coefficient rings like  $\mathbb{Z}_{(p)}$  or  $\mathbb{Z}/p$  and the idea that the degree theorem could be modified to calculate homology groups of  $\tilde{Q}_{p-1}$ .

As a warm-up exercise to the real problem, we prove the following proposition using the original Degree Theorem techniques of Hatcher and Vogtmann from [15] and [16]. Their work directly implies the truth of the proposition, and it is only

because the results in [16] were stated using rational – rather than  $\mathbb{Z}/p$  – coefficients that we need to write anything at all here.

**Proposition 10.1**

$$H^2(\text{Aut}(F_{p-1}); \mathbb{Z}/p) = 0.$$

**Proof.** By dual universal coefficients,

$$H^2(\text{Aut}(F_{p-1}); \mathbb{Z}/p) \cong \text{Hom}(H_2(\text{Aut}(F_{p-1})), \mathbb{Z}/p) \oplus \text{Ext}(H_1(\text{Aut}(F_{p-1})), \mathbb{Z}/p).$$

From Theorem 5.3,

$$\text{Ext}(H_1(\text{Aut}(F_{p-1})), \mathbb{Z}/p) = 0.$$

It remains to show that

$$H_2(\text{Aut}(F_{p-1}); \mathbb{Z}/p) = 0.$$

In addition, note from Lemma 5.6 that

$$H_2(\text{Aut}(F_{p-1}); \mathbb{Z}/p) = H_2(Q_{p-1}; \mathbb{Z}/p).$$

From Corollary 3.2 in [15],  $X_{p-1,3}$  is 2-connected and so we can use a spectral sequence to calculate  $H_2(\text{Aut}(F_{p-1}); \mathbb{Z}/p)$  by taking a resolution  $F \rightarrow \mathbb{Z}$  of  $\mathbb{Z}$  as a  $\mathbb{Z}(\text{Aut}(F_{p-1}))$ -module and considering two different filtrations of the complex  $F \otimes C_*(X_{p-1,3}; \mathbb{Z}/p)$ . Using one filtration, one obtains a spectral sequence that satisfies

$$E_{r,s}^2 \Rightarrow H_{r+s}(\text{Aut}(F_{p-1}); \mathbb{Z}/p), \text{ for } r + s \leq 2,$$

because  $X_{p-1,3}$  is 2-connected. Then using the other filtration gives a spectral sequence

$$E_{r,s}^1 = \prod_{[\delta] \in \Delta^r} H_s(\text{stab}_{\text{Aut}(F_{p-1})}(\delta); \mathbb{Z}/p) \Rightarrow H_{r+s}(\text{Aut}(F_{p-1}); \mathbb{Z}/p), \text{ for } r + s \leq 2,$$

where  $[\delta]$  ranges over the set  $\Delta^r$  of orbits of  $r$ -simplices  $\delta$  in  $X_{p-1,3}$ . As always, for  $s > 0$  we need only be concerned with simplices with  $p$ -symmetry. Moreover, as we are truncating at degree 3, there are not that many simplices with  $p$ -symmetry. Explicitly, we are looking for graphs with degree no greater than 3 and no more than  $p - 1$  holes. The only relevant ones occur when  $p = 3, 5$  and consist of the graphs  $\Theta_2$  and  $\Theta_4$ , respectively. Each gives a vertex of  $Q_{p-1,3}$  with  $p$ -symmetry in the case  $p = 3$  or  $p = 5$ , respectively. Fortunately, the homology of the stabilizers of these simplices is 0 for  $0 < t < 3$ , Because the differential on the  $E^r$ -page has bidegree  $(-r, r - 1)$ , only the horizontal axis of the  $E^1$ -page of the spectral sequence is relevant to our calculation of  $H_2(\text{Aut}(F_{p-1}); \mathbb{Z}/p)$ . Hence we see that

$$H_2(Q_{p-1,3}; \mathbb{Z}/p) = H_2(\text{Aut}(F_{p-1}); \mathbb{Z}/p).$$

Now follow similar reasoning and consider two different spectral sequences corresponding to two different filtrations of  $F \otimes \tilde{C}_*(\mathcal{C}; \mathbb{Z}/p)$  where  $\mathcal{C}$  is the mapping cone of the inclusion  $X_{p-1,3} \rightarrow X_{p-1}$ . Because  $(X_{p-1}, X_{p-1,3})$  is 3-connected, standard arguments with these spectral sequences imply that

$$H_3(Q_{p-1}, Q_{p-1,3}; \mathbb{Z}/p) = 0.$$

Similarly,

$$H_2(Q_{p-1}, Q_{p-1,2}; \mathbb{Z}/p) = 0.$$

Hence the long exact sequence of the triple  $(X_{p-1}, X_{p-1,3}, X_{p-1,2})$  shows that  $H_2(Q_{p-1,3}, Q_{p-1,2}; \mathbb{Z}/p) = 0$ . Consequently, the long exact sequence of the pair  $(X_{p-1,3}, X_{p-1,2})$  yields that the sequence

$$H_3(Q_{p-1,3}, Q_{p-1,2}; \mathbb{Z}/p) \rightarrow H_2(Q_{p-1,2}; \mathbb{Z}/p) \rightarrow H_2(Q_{p-1,3}; \mathbb{Z}/p) \rightarrow 0$$

is exact. Now from §5 of [15], the space  $Q_{p-1,2}$  is contractible. So

$$H_2(Q_{p-1,2}; \mathbb{Z}/p) = 0$$

and the above exact sequence implies that

$$H_2(Q_{p-1,3}; \mathbb{Z}/p) = 0.$$

As we have already shown that the latter cohomology group is isomorphic to

$$H_2(\text{Aut}(F_{p-1}); \mathbb{Z}/p),$$

we are done.  $\square$

In the following proposition, we apply the same methods that were used in Proposition 10.1, but this time using the modified degree theorem:

**Proposition 10.2** 1.  $H^2(\tilde{Q}_{p-1}; \mathbb{Z}/p) \cong H_2(\tilde{Q}_{p-1}; \mathbb{Z}/p) \cong H_2(\tilde{Q}_{p-1,3}; \mathbb{Z}/p)$ , and

2.  $H_3(\tilde{Q}_{p-1,3}, \tilde{Q}_{p-1,2}; \mathbb{Z}/p) \rightarrow H_2(\tilde{Q}_{p-1,2}; \mathbb{Z}/p) \rightarrow H_2(\tilde{Q}_{p-1,3}; \mathbb{Z}/p) \rightarrow 0$  is exact.

**Proof.** Let  $G = F_{p-1} \rtimes \text{Aut}(F_{p-1})$ , thought of as a subgroup of

$$N_{\text{Aut}(F_n)}(B_{p-1}) \cong N_{\Sigma_p}(\mathbb{Z}/p) \times (F_{p-1} \rtimes \text{Aut}(F_{p-1})).$$

Recall from chapter 4 and in particular Proposition 4.8 that  $G$  acts on  $\tilde{X}_{p-1}$  with finite quotient  $\tilde{Q}_{p-1}$  and finite stabilizers.

By dual universal coefficients,

$$H^2(G; \mathbb{Z}/p) \cong \text{Hom}(H_2(G), \mathbb{Z}/p) \oplus \text{Ext}(H_1(G), \mathbb{Z}/p).$$

Since from Lemma 5.8  $H_1(G; \mathbb{Z})$  is a finite group whose order is a power of 2,

$$\text{Hom}(H_2(G), \mathbb{Z}/p) \cong \text{Hom}(H_2(G; \mathbb{Z}/p), \mathbb{Z}/p) \cong H_2(G; \mathbb{Z}/p)$$

and

$$\text{Ext}(H_1(G), \mathbb{Z}/p) = 0.$$

Hence  $H^2(G; \mathbb{Z}/p) \cong H_2(G; \mathbb{Z}/p)$  by our earlier calculation with dual coefficients.

Using the standard equivariant spectral sequences in cohomology and homology for  $G$  acting on  $\tilde{X}_{p-1}$ , we note that

$$H^2(G; \mathbb{Z}/p) \cong H^2(\tilde{Q}_{p-1}; \mathbb{Z}/p)$$

and

$$H_2(G; \mathbb{Z}/p) \cong H_2(\tilde{Q}_{p-1}; \mathbb{Z}/p)$$

by the standard arguments we have used throughout this paper. (In other words, we need only pay attention to the simplices of  $\tilde{X}_{p-1}$  with  $p$ -symmetry if we are concerned with terms above the horizontal axis in either spectral sequence. The only marked graphs corresponding to vertices in  $\tilde{X}_{p-1}$  which have  $p$ -symmetry, are the ones whose underlying graphs are  $\Theta_{p-1}$  with either both  $*$  and  $\circ$  on the same side of the  $\Theta$ -graph or on opposite sides of the  $\Theta$ -graph. Each contributes one copy of the (co)homology of the symmetric group  $\Sigma_p$  to the vertical axis of its spectral sequence. Since the (co)homology of  $\Sigma_p$  is 0 for  $t \in \{1, \dots, 2p-4\}$ , it is not relevant to our calculation of  $H^2(G; \mathbb{Z}/p)$  or  $H_2(G; \mathbb{Z}/p)$ .)

Thus we have

$$H^2(\tilde{Q}_{p-1}; \mathbb{Z}/p) \cong H_2(G; \mathbb{Z}/p) \cong H_2(\tilde{Q}_{p-1}; \mathbb{Z}/p),$$



which establishes part of 1. in the proposition.

From Theorem 9.1,  $\tilde{X}_{p-1,3}$  is 2-connected and so we can use a spectral sequence to calculate  $H_2(G; \mathbb{Z}/p)$  by taking a resolution  $F \rightarrow \mathbb{Z}$  of  $\mathbb{Z}$  as a  $\mathbb{Z}G$ -module and considering two different filtrations of the complex  $F \otimes C_*(\tilde{X}_{p-1,3}; \mathbb{Z}/p)$ . Using one filtration, one obtains a spectral sequence that satisfies

$$E_{r,s}^2 \Rightarrow H_{r+s}(G; \mathbb{Z}/p), \text{ for } r + s \leq 2,$$

because  $\tilde{X}_{p-1,3}$  is 2-connected. Then using the other filtration gives a spectral sequence

$$E_{r,s}^1 = \prod_{[\delta] \in \Delta^r} H_s(\text{stab}_G(\delta); \mathbb{Z}/p) \Rightarrow H_{r+s}(G; \mathbb{Z}/p), \text{ for } r + s \leq 2,$$

where  $[\delta]$  ranges over the set  $\Delta^r$  of orbits of  $r$ -simplices  $\delta$  in  $\tilde{X}_{p-1,3}$ . As always, for  $s > 0$  we need only be concerned with simplices with  $p$ -symmetry. Moreover, as we are truncating at degree 3, there are not that many simplices with  $p$ -symmetry. In particular, the only relevant ones occur when

- $p = 3$  where two vertices of  $\tilde{Q}_{p-1,3}$  contribute  $\Sigma_3$ -symmetry. (Explicitly, since  $p - 1 = 3 - 1 = 2$  in this case, we are looking for graphs with degree no greater than 3, with 3-symmetry, and with just two holes in them. The only possibilities are  $\Theta_2$  with both  $*$  and  $\circ$  the same vertex, and  $\Theta_2$  with  $*$  on one side and  $\circ$  on the other. Graphs like  $\Xi_3$  cannot occur because the ranks of their fundamental groups are too high.)
- $p = 5$  where one vertex of  $\tilde{Q}_{p-1,3}$  contributes  $\Sigma_5$ -symmetry. (Explicitly, since  $p - 1 = 5 - 1 = 4$  in this case, we are looking for graphs with degree no

greater than 3, with 5-symmetry, and with just four holes in them. The only possibility is  $\Theta_4$  with both  $*$  and  $\circ$  the same vertex.)

Fortunately, the homology of the stabilizers of these simplices is 0 for  $0 < t < 3$ . Since the differential on the  $E^r$ -page has bidegree  $(-r, r-1)$ , only the horizontal axis of the  $E^1$ -page of the spectral sequence is relevant to our calculation of  $H_2(G; \mathbb{Z}/p)$ . Hence we see that

$$H_2(\tilde{Q}_{p-1,3}; \mathbb{Z}/p) = H_2(G; \mathbb{Z}/p).$$

Part 1. of the proposition follows.

For part 2. we also follow similar reasoning and consider two different spectral sequences corresponding to two different filtrations of  $F \otimes \tilde{C}_*(\mathcal{C}; \mathbb{Z}/p)$  where  $\mathcal{C}$  is the mapping cone of the inclusion  $\tilde{X}_{p-1,3} \rightarrow \tilde{X}_{p-1}$ . Now because  $(\tilde{X}_{p-1}, \tilde{X}_{p-1,3})$  is 3-connected, standard arguments with these spectral sequences imply that

$$H_3(\tilde{Q}_{p-1}, \tilde{Q}_{p-1,3}; \mathbb{Z}/p) = 0.$$

Similarly,

$$H_2(\tilde{Q}_{p-1}, \tilde{Q}_{p-1,2}; \mathbb{Z}/p) = 0.$$

Hence the long exact sequence of the triple  $(\tilde{X}_{p-1}, \tilde{X}_{p-1,3}, \tilde{X}_{p-1,2})$  shows that  $H_2(\tilde{Q}_{p-1,3}, \tilde{Q}_{p-1,2}; \mathbb{Z}/p) = 0$ . Consequently, the long exact sequence of the pair  $(\tilde{X}_{p-1,3}, \tilde{X}_{p-1,2})$  yields 2. of the proposition.  $\square$

The vertices of the space  $\tilde{Q}_{p-1,2}$  are given by underlying basepointed graphs  $\Gamma_{p-1}$  with one extra distinguished vertex  $\circ$  where  $\pi_1(\Gamma_{p-1}) \cong F_{p-1}$  and  $\deg(\Gamma_{p-1}) \leq 2$ . As a notational device, when writing a graph  $\Gamma_{p-1}$  omit any loops at the basepoint.

So if a graph  $\Gamma$  with  $\pi_1(\Gamma) \cong p - 1 - k$  is written down and asserted to represent a vertex of  $\tilde{Q}_{p-1,2}$ , then the vertex it is representing is the graph  $\Gamma_{p-1}$  obtained from  $\Gamma$  by adding  $k$  loops at the basepoint. Note that  $\deg(\Gamma_{p-1}) = \deg(\Gamma)$  since edges beginning at the basepoint are not relevant to degree computations.

An example of a 2-cycle in  $\tilde{Q}_{p-1,2}$  is illustrated below in Figure 10.1. In the figure, a filled dot represents the basepoint  $*$  and a hollow dot represents the other distinguished point  $\circ$ . The cycle forms a 2-sphere, and the hash marks on the boundary of the pictured disk shows how the 2-sphere is formed.

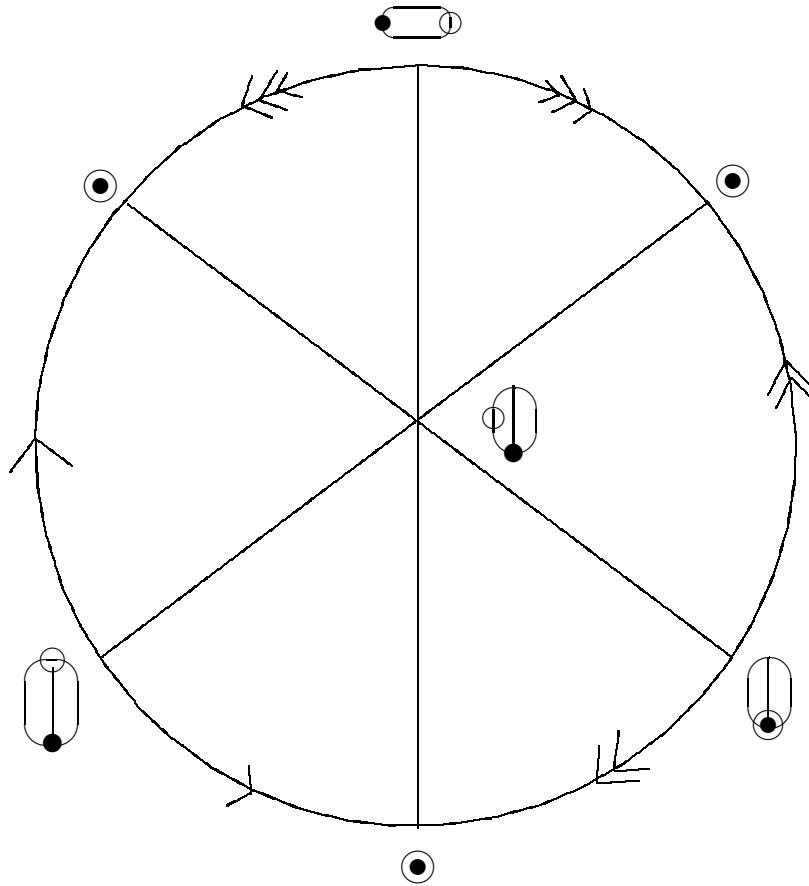

Figure 10.1: The 2-sphere in  $\tilde{Q}_{p-1,2}$

**Proposition 10.3**  $H_2(\tilde{Q}_{p-1}; \mathbb{Z}/p) = 0$ .

**Proof.** We will show that the complex  $\tilde{Q}_{p-1,2}$  deformation retracts to the 2-sphere given by Figure 10.1 so that  $H_2(\tilde{Q}_{p-1,2}; \mathbb{Z}/p) = \mathbb{Z}/p$ . Then an explicit element will be found in in

$$H_3(\tilde{Q}_{p-1,3}, \tilde{Q}_{p-1,2}; \mathbb{Z}/p)$$

which maps onto the generator of

$$H_2(\tilde{Q}_{p-1,2}; \mathbb{Z}/p) = \mathbb{Z}/p.$$

So by 2. of Proposition 10.2,  $H_2(\tilde{Q}_{p-1,3}; \mathbb{Z}/p)$  will be zero and then the corollary will follow from 1. of Proposition 10.2.

The proof of this adopts much of the same logic as that used by Hatcher and Vogtmann in [16]. In particular, we make use of a cubical structure on some simplices in  $\tilde{Q}_{p-1,2}$  and  $\tilde{Q}_{p-1,3}$  and the notion of “plusfaces” and “minusfaces” for this cubical structure and more generally for the simplicial structure.

Let us illustrate this with an example. Note that  $\tilde{Q}_{p-1,3}$  is a 3-dimensional complex (because we can collapse at most three 3-valence vertices or two 3-valence vertices and a bivalent  $\circ$ , to the basepoint.)

Consider a graph  $\Gamma'$  with 4 vertices:  $*$ ,  $\circ$ , and two other valence 3 vertices  $x$  and  $y$ . The graph  $\Gamma'$  has 5 (unoriented) edges:  $a, b, c, d$  and  $e$ . The edge  $a$  connects  $\circ$  and  $x$ ,  $b$  connects  $\circ$  and  $y$ ,  $c$  connects  $x$  and  $y$ ,  $d$  connects  $*$  and  $x$ , and  $e$  connects  $*$  and  $y$ . Define a forest  $F$  in  $\Gamma'$  by  $F = \{a, b, d\}$ . There are 6 3-simplices in  $\tilde{Q}_{p-1,2}$  corresponding to the forest  $F$ . Each corresponds to some collapse of the edges in  $F$  in a particular order. So, for example, one particular 3-simplex comes from collapsing first  $a$ , then  $b$ , and then  $d$ . These 6 3-simplices all fit together in a cube. Refer to Figures 10.2 and 10.3 for illustrations of this behavior.

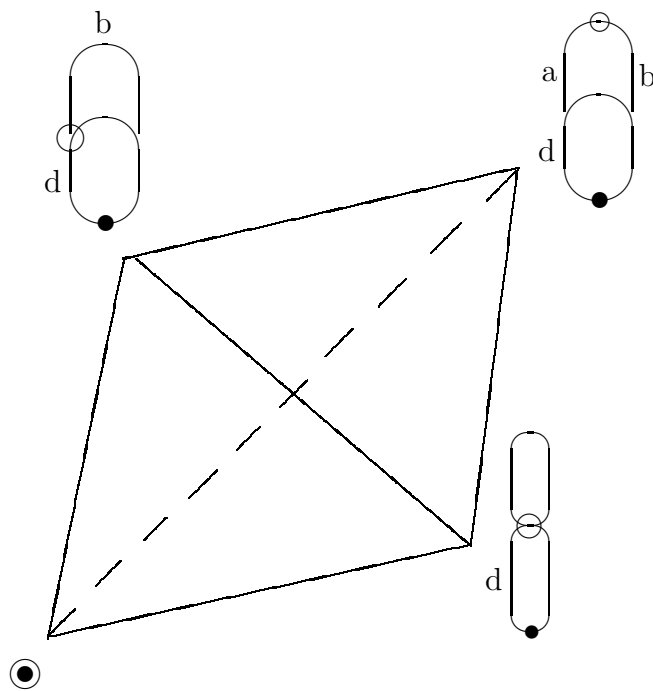

Figure 10.2: One of 6 3-simplices making up the sample cube.

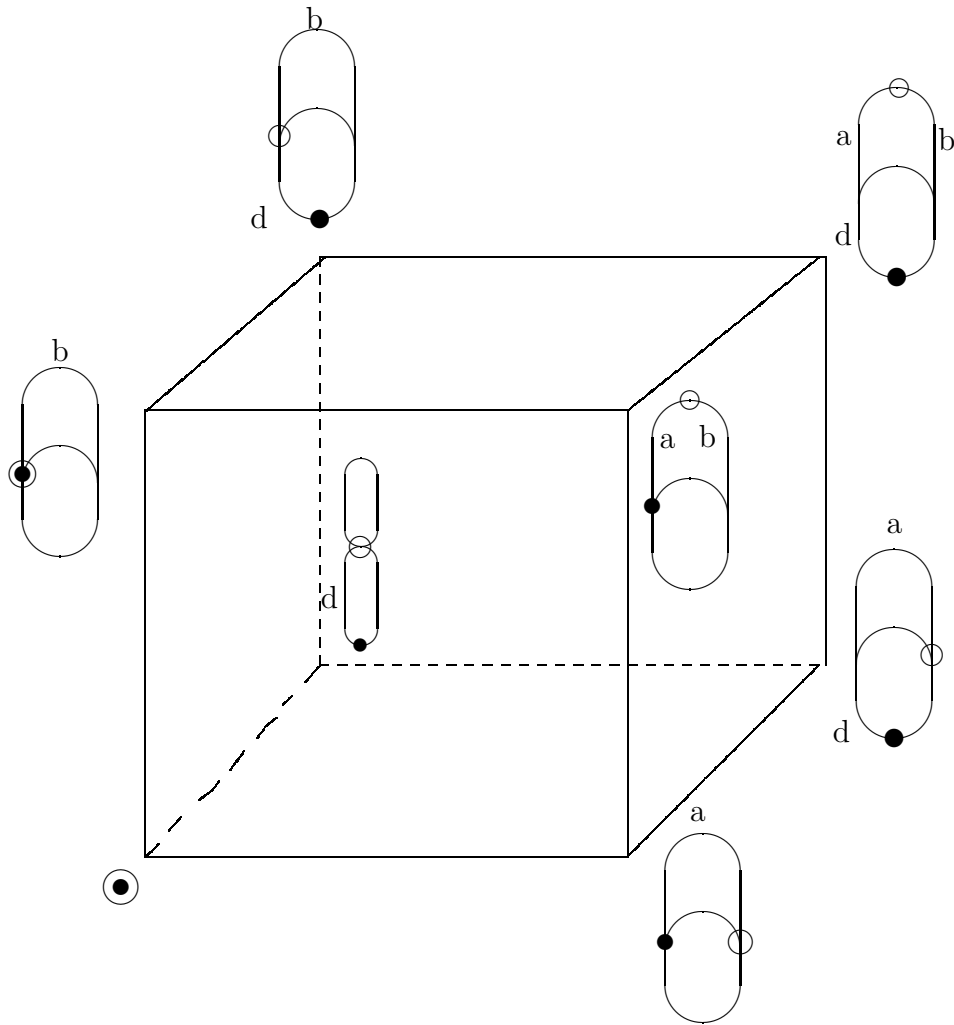

Figure 10.3: A sample cube in  $\tilde{Q}_{p-1,3}$

The 3 faces of the cube that are adjacent to the vertex  $\Gamma'$  are its *plusfaces*, and the 3 faces of the cube that are adjacent to the vertex  $R_{p-1}$  are its *minusfaces*. For the 3-simplex pictured above the cube, the 3 faces of it that are adjacent to the vertex  $\Gamma'$  will be called its *plusfaces*, and the 1 face of it that is not adjacent to the vertex  $\Gamma'$  will be called its *minusface*. (Sometimes, the 3 one-dimensional edges of

the cube adjacent to the vertex  $\Gamma'$  will also be called (lower dimensional) plusfaces of the cube; and the 3 edges of the above pictured 3-simplex that are adjacent to the vertex  $\Gamma'$  will be called plusfaces of the 3-simplex.)

The subset  $F$  of edges of  $\Gamma'$  actually gives the interior of a 3-dimensional cube as pictured above because all of the 6 3-simplices that form the cube are distinct. This in turn is true because no graph automorphism of  $\Gamma'$  takes the forest  $F$  to itself except the trivial graph automorphism. Despite this, however, parts of the boundary of the cube are self-identified. For example, the plusface corresponding to  $\{a, b\}$  “folds over” along its diagonal so that the square forming the plusface is glued together to form just one 2-simplex, a triangle. All of the other faces (the two other plusfaces and the three other minusfaces) of the pictured cube are actually squares, and not self-identified into triangles.

In general, suppose we have a graph  $\Gamma$  (now not necessarily the specific graph  $\Gamma'$  referred to in the above two figures) which has degree 3 and a forest  $F = \{a, b, c\}$  in  $\Gamma$ . Then the pair  $(\Gamma, F)$  will give a cube in  $\tilde{Q}_{p-1}$  if no nontrivial graph automorphism of  $\Gamma$  sends  $F$  to itself. Note that if this is the case, then even though  $(\Gamma, F)$  gives a cube, its faces might be identified or glued to each other in various ways. This can happen with both the plusfaces and the minusfaces. For example, say  $\hat{\Gamma}$  is the graph obtained from  $\Gamma$  by collapsing the edge  $a$ . Then if a nontrivial graph automorphism of  $\hat{\Gamma}$  switches  $b$  and  $c$ , the minusface (which would have been a square if not for this nontrivial graph automorphism) of the cube corresponding to  $\hat{\Gamma}$  is glued to itself along a diagonal of the square and so is really just a 2-simplex or a triangle.

Our first goal is to show that  $\tilde{Q}_{p-1,2}$  deformation retracts to the 2-sphere pictured



in Figure 10.1. We do this by listing all of the graphs that give 2-simplices in Figure 10.4 and then handling these graphs in order.

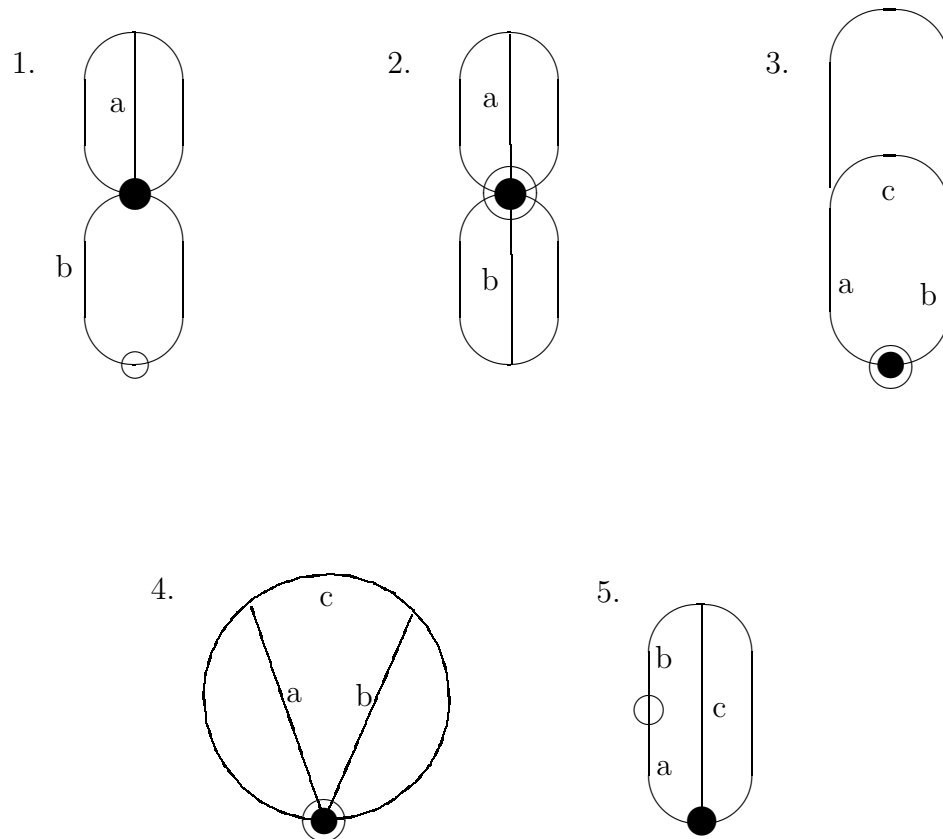

Figure 10.4: Graphs giving 2-simplices

1. This graph only has one maximal subforest  $\{a, b\}$  so that the corresponding square (i.e., two 2-simplices that join together to form a square) has free plusfaces. So we can collapse this square away.
2. This graph also only has one maximal subforest  $\{a, b\}$  and moreover there is

an automorphism of the graph that switches  $a$  and  $b$ . So this graph just contributes one 2-simplex, the diagonal of which is automatically a free plusface.

3. The 2-simplex corresponding to  $\{a, b\}$  has a free diagonal plusface and so can be removed. In addition, the square corresponding to  $\{a, c\}$  has free plusface  $c$ .
4. Use exactly the same argument as that for 3.
5. The three squares that this graph contributes join together to form the 2-sphere in Figure 10.1, as previously mentioned.

To complete the proof, it remains to find a specific relative cycle in

$$H_3(\tilde{Q}_{p-1,3}, \tilde{Q}_{p-1,2}; \mathbb{Z}/p)$$

which maps onto the generator of

$$H_2(\tilde{Q}_{p-1,2}; \mathbb{Z}/p) = \mathbb{Z}/p.$$

We use the graph  $\Gamma'$ , mentioned earlier in this proof, to construct the relative cycle. Basically, the cycle is formed by joining together the cubes corresponding to the subforests  $\{a, b, d\}$ ,  $\{a, c, d\}$ , and  $\{a, c, e\}$ .

The plusface corresponding to  $\{a, b\}$  of  $\{a, b, d\}$  folds back onto itself along its diagonal and so it not free. The plusface  $\{a, d\}$  of  $\{a, b, d\}$  connects up with the plusface  $\{a, d\}$  of  $\{a, c, d\}$ . The remaining plusface  $\{b, d\}$  of  $\{a, b, d\}$  joins up with the plusface  $\{a, e\}$  of  $\{a, c, e\}$ .

Moreover, the plusface  $\{a, c\}$  of  $\{a, c, d\}$  joins up with the plusface  $\{a, c\}$  of  $\{a, c, e\}$ . Finally, the last remaining plusface  $\{c, d\}$  of  $\{a, c, d\}$  connects with the last remaining plusface  $\{c, e\}$  of  $\{a, c, e\}$ .

The minusface obtained by collapsing  $a$  in  $\{a, b, d\}$  is the same as that obtained by collapsing  $a$  in  $\{a, c, d\}$ . The one obtained by collapsing  $b$  in  $\{a, b, d\}$  is the same as what we get if we collapse  $a$  in  $\{a, c, e\}$ . The remaining minusface of  $\{a, b, d\}$  procured by collapsing  $d$  is one of the three squares pictured in Figure 10.1 and corresponds to the subforest  $\{a, b\}$  of graph 5.

Following the same logic, we see that the minusface of  $\{a, c, d\}$  corresponding to collapsing the edge  $c$ , is the same as that of  $\{a, c, e\}$  obtained by collapsing  $c$ . The square  $\{a, c\}$  of the graph 5. is now seen to be the remaining minusface acquired from  $\{a, c, d\}$  by collapsing  $d$ . Similarly, the square  $\{b, c\}$  of the graph 5. is the remaining minusface of  $\{a, c, e\}$  which we get if we collapse the edge  $e$ .

The above argument shows that is it at least possible for the three cubes  $\{a, b, d\}$ ,  $\{a, c, d\}$ , and  $\{a, c, e\}$  to join together to form a solid ball with boundary the sphere pictured in Figure 10.1. (Our only remaining concern might be sign considerations.) Specific signed computations using the 18 3-simplices (6 for each cube) involved show that they glue together as we have claimed.  $\square$

## Part III

# Contractibility of fixed point sets

# Chapter 11

## Preliminaries

Before reading Part III, we strongly recommend that the reader study the entirety of [19] by Krstic and Vogtmann. This part is essentially a modification of their results on fixed point spaces of outer space to fixed point spaces of outer space, and is not meant to be read independently of their work.

We show that for a finite subgroup  $G$  of  $Aut(F_n)$ , the fixed point set  $X_n^G$  is contractible. This was shown for subgroups of  $Out(F_n)$  by Krstic and Vogtmann in [19] and our work here borrows their basic approach and methods (which in turn are similar to the methods used by Culler and Vogtmann in [10] to show that outer space is contractible).

In particular, Krstic and Vogtmann define a complex  $L_G$  of “essential marked  $G$ -graphs” that the fixed point set  $X_n^G$  in outer space deformation retracts to. Then they order the reduced marked  $G$ -graphs in  $L_G$  using a norm  $\|\cdot\|_{out}$ . Using this norm to determine which reduced marked  $G$ -graph should be considered next, Krstic

and Vogtmann performed a transfinite induction argument to show that  $L_G$  is contractible, by building  $L_G$  up as the union of stars of reduced marked  $G$ -graphs.

We will follow a similar approach, and define norms

$$\|\cdot\|_{out} \text{ and } \|\cdot\|_{tot} = \|\cdot\|_{out} \times \|\cdot\|_{out}$$

to order the reduced marked essential  $G$ -graphs in outer space. For technical reasons,  $\|\cdot\|_{tot}$  will be the appropriate norm to use when performing the transfinite induction argument to show the contractibility of the corresponding  $L_G$  in outer space.

The norm  $\|\cdot\|_{out}$  was defined by Krstic and Vogtmann as follows. Order the set  $\mathcal{W}$  of conjugacy classes of elements of  $F_n$  as  $\mathcal{W} = \{w_1, w_2, \dots\}$ . Totally order  $\mathbb{Z}^{\mathcal{W}}$  by the lexicographic order. Let  $\sigma = [s, \Gamma]$  be a marked graph and define  $\|\sigma\|_{out} \in \mathbb{Z}^{\mathcal{W}}$  by letting  $(\|\sigma\|_{out})_i$  be the sum over all  $x \in G$  of the lengths in  $\Gamma$  of the reduced loops (given by the marking  $s$ ) corresponding to  $xw_i$ . Equivalently, they define an absolute value  $|\cdot|_{out} \in \mathbb{Z}^{\mathcal{W}}$  on the edges of  $\Gamma$  and set

$$\|\sigma\|_{out} = \frac{1}{2} \sum_{e \in E(\Gamma)} |e|_{out}.$$

The  $i$ th coordinate of  $|e|_{out}$  is simply the sum for all  $x \in G$  of the contributions of  $e$  or  $\bar{e}$  to the loop  $xw_i$  in  $\Gamma$ . In other words, it is the sum over all  $x \in G$  of the number of times  $e$  or  $\bar{e}$  appears in the cyclically reduced edge path representing  $xw_i$ . For  $A, B \subseteq E(\Gamma)$  define  $(A.B)_{out} \in \mathbb{Z}^{\mathcal{W}}$  to be the function whose  $i$ th coordinate is the sum over all  $x \in G$  of the number of times  $a\bar{b}$  or  $b\bar{a}$  appears in the reduced loop in  $\Gamma$  corresponding to  $xw_i$ . Finally, for  $C \subseteq E(\Gamma)$ , define  $|C|_{out}$  inductively by the

formula

$$|A \amalg B|_{out} = |A|_{out} + |B|_{out} - 2(A.B)_{out}$$

for disjoint subsets  $A$  and  $B$  of  $E(\Gamma)$ . Note that with the above definition,  $|A|_{out} = (A.E(\Gamma) - A)_{out} = |E(\Gamma) - A|_{out}$ .

The corresponding quantities for  $Aut(F_n)$  are defined in much the same way, the basic difference being that we think of the lengths of reduced paths rather than reduced loops. Order  $F_n$  as  $F_n = \{\alpha_1, \alpha_2, \dots\}$ , and give  $\mathbb{Z}^{F_n}$  the lexicographic order. For a finite subgroup  $G$  of  $Aut(F_n)$ , consider a basepointed marked  $G$ -graph  $\sigma = [s, \Gamma]$ . Define the norm  $\|\sigma\|_{aut} \in \mathbb{Z}^{F_n}$  to be  $|G| \cdot L$ , where  $L : F_n \rightarrow \mathbb{Z}$  is the Lyndon length function of the marked graph. In other words, the basepointed marked graph  $\sigma$  corresponds to an action of  $F_n$  on a rooted  $\mathbb{Z}$ -tree  $T$ . Define

$$L(\alpha_i) = \{\text{the distance } \alpha_i \text{ moves the root of } T\}.$$

Equivalently, the  $i$ th coordinate of  $\|\sigma\|_{aut}$  is the sum over all  $x \in G$  of the lengths in  $\Gamma$  of the reduced (but *not* cyclically reduced) paths corresponding to  $x\alpha_i \in \pi_1(\Gamma, *)$ .

As before in the case of  $Out(F_n)$ , we can define an absolute value  $|\cdot|_{aut} \in \mathbb{Z}^{F_n}$  on the edges of  $\Gamma$  and set

$$\|\sigma\|_{aut} = \frac{1}{2} \sum_{e \in E(\Gamma)} |e|_{aut}.$$

The  $i$ th coordinate of  $|e|_{aut}$  is simply the sum of for all  $x \in G$  of the contributions of  $e$  or  $\bar{e}$  to the reduced (but not cyclically reduced) path  $x\alpha_i$  in  $\pi_1(\Gamma, *)$ . Hence it is the sum over all  $x \in G$  of the number of times  $e$  or  $\bar{e}$  appears in the reduced edge path representing  $x\alpha_i$ . For  $A, B \subseteq E(\Gamma)$  define  $(A.B)_{aut} \in \mathbb{Z}^{\mathcal{W}}$  to be the function whose  $i$ th coordinate is the sum over all  $x \in G$  of the number of times  $a\bar{b}$  or  $b\bar{a}$

appears in the reduced path in  $\Gamma$  corresponding to  $x\alpha_i$ . Finally, for  $C \subseteq E(\Gamma)$ , define  $|C|_{aut}$  inductively by the formula

$$|A \amalg B|_{aut} = |A|_{aut} + |B|_{aut} - 2(A.B)_{aut}$$

for disjoint subsets  $A$  and  $B$  of  $E(\Gamma)$ . In contrast to the case with  $Out(F_n)$  the formula  $|A|_{aut} = (A.E(\Gamma) - A)_{aut}$  certainly does not hold any longer.

Our final norm  $\|\cdot\|_{tot}$  is just the product of the previous two. That is, let  $\sigma = [s, \Gamma]$  be a basepointed marked  $G$ -graph for a finite subset  $G$  of  $Aut(F_n)$  and totally order  $\mathbb{Z}^{\mathcal{W}} \times \mathbb{Z}^{F_n}$  by the lexicographic order. Define  $\|\sigma\|_{tot} \in \mathbb{Z}^{\mathcal{W}} \times \mathbb{Z}^{F_n}$  as  $\|\sigma\|_{tot} = \|\sigma\|_{out} \times \|\sigma\|_{aut}$ , where to calculate  $\|\sigma\|_{out}$  we just forget that  $\Gamma$  has a basepoint. The functions  $|e|_{tot}$ ,  $(A.B)_{tot}$ , and  $|A|_{tot}$  are defined similarly.

For a vertex  $v$ , let  $E_v$  be the set of oriented edges ending at  $v$ . The notion of ideal edges is defined as in [19], with the exception that if the ideal edge  $\alpha \subseteq E_*$  then condition (i) of their definition should be changed to:

$$(i) \text{ card}(\alpha) \geq 2 \text{ and } \text{card}(E_* - \alpha) \geq 1.$$

That is, ideal edges at the basepoint can contain all except one of the edges of  $E_*$ . The definition of blowing up an ideal edge is taken exactly as defined in [19]. Hence if we are blowing up an ideal edge  $\alpha \subseteq E_*$  then we are pulling the edges of  $\alpha$  away from the basepoint along a new edge  $e(\alpha)$  we just constructed. If  $\text{card}(E_* - \alpha) = 1$ , this will result in a graph whose basepoint has valence 2.

Let  $\alpha$  be an ideal edge of  $\sigma = [s, \Gamma]$  and  $\sigma^{G\alpha} = [s^{G\alpha}, \Gamma^{G\alpha}]$  be the result of blowing up the ideal edge  $\alpha$ . Then it is easy to show that  $|\alpha|_{aut}$  in  $\Gamma$  is equal to  $|e(\alpha)|_{aut}$  in  $\Gamma^{G\alpha}$  (which was the whole point of defining  $|\cdot|_{aut}$  on subsets of edges.) Hence



$|\alpha|_{tot} = |e(\alpha)|_{tot}$  also, as Krstic and Vogtmann show the corresponding formula for  $|\cdot|_{out}$ . From this, the analogues of Proposition 6.4 about Whitehead moves in [19] are true for the norms  $\|\cdot\|_{aut}$  and  $\|\cdot\|_{tot}$ . That is, for an ideal edge  $\alpha$  define  $D(\alpha)$  by

$$D(\alpha) = \{a \in \alpha : \text{stab}(a) = \text{stab}(\alpha) \text{ and } \bar{a} \notin \bigcup G\alpha\}.$$

Then the Whitehead move  $(G\alpha, Ga)$  is the result of first blowing up  $\alpha$  in  $\Gamma$  to get  $\sigma^{G\alpha}$  and then collapsing  $Ga$  in  $\Gamma^{G\alpha}$  to get  $\sigma'$ . Proposition 6.4 of [19] states that

$$\|\sigma'\|_{out} = \|\sigma\|_{out} + [G : \text{stab}(\alpha)](|\alpha|_{out} - |a|_{out}).$$

As mentioned before, this remains true if out-norms and absolute values are replaced by aut- or tot-norms and absolute values.

The value  $[G : \text{stab}(\alpha)](|a|_{out} - |\alpha|_{out})$  is called the *out-reductivity* of  $(\alpha, a)$  and is denoted  $red_{out}(\alpha, a)$ . Similar notions of *aut-reductivity* and *tot-reductivity* are defined as well. A Whitehead move reduces the norm iff the corresponding reductivity is greater than zero, in which case the Whitehead move is called *reductive*. The *x-reductivity* of an ideal edge  $\alpha$  is the maximum over all elements  $a \in D(\alpha)$  of  $red_x(\alpha, a)$ , where  $x$  is out, aut, or tot. It thus makes sense to talk of an ideal edge  $\alpha$  as being *out-reductive*, etc. The main reason we are interested in the norm  $\|\cdot\|_{tot}$  rather than just using the norm  $\|\cdot\|_{aut}$  is the following proposition.

**Proposition 11.1** *Let  $\alpha \subseteq E_v$  be a tot-reductive ideal edge of a reduced marked  $G$ -graph  $\rho$ . Suppose  $\alpha$  is invertible (that is,  $E_v - \alpha \not\subseteq G\alpha$  and  $E_v - \alpha$  is an ideal edge.) Then  $\alpha^{-1} = E_v - \alpha$  is tot-reductive.*

**Proof.** Assume  $v = *$ , else the proof is trivial. Say  $(\alpha, a)$  is the reductive ideal edge. Since  $\text{stab}(*) = G$  and  $\alpha$  is invertible, the analogue of Lemma 5.1 of [19] gives us that  $\text{stab}(\alpha) = \text{stab}(a) = G$ . Say  $\rho = [s, \Gamma]$ . As before, let  $\rho^{G\alpha} = [s^{G\alpha}, \Gamma^{G\alpha}]$  be the result of blowing up the ideal edge  $(\alpha, a)$ . Then let  $\rho' = [s', \Gamma']$  be the result of collapsing  $a$  in  $\Gamma^{G\alpha}$ . We know that  $\|\rho'\|_{\text{tot}} < \|\rho\|_{\text{tot}}$  as  $(\alpha, a)$  is tot-reductive.

Assuming the claim below, it will be easy to complete the proof as follows: Since  $\|\rho'\|_{\text{out}} \neq \|\rho\|_{\text{out}}$  and  $\|\rho'\|_{\text{tot}} < \|\rho\|_{\text{tot}}$ , we must have  $\|\rho'\|_{\text{out}} < \|\rho\|_{\text{out}}$ . Let  $\rho''$  be the result of doing the Whitehead move  $(\alpha^{-1}, a^{-1})$  to  $\rho$ . Because  $\text{red}_{\text{out}}(\alpha, a) = \text{red}_{\text{out}}(\alpha^{-1}, a^{-1})$  (see the comments in [19] following the proof of §6.4), it follows that  $\|\rho''\|_{\text{out}} = \|\rho'\|_{\text{out}}$ . So  $\|\rho''\|_{\text{out}} < \|\rho\|_{\text{out}}$  and hence  $\|\rho''\|_{\text{tot}} < \|\rho\|_{\text{tot}}$ . Thus  $\alpha^{-1}$  is reductive.  $\square$

**Claim 11.2**  $\|\rho'\|_{\text{out}} \neq \|\rho\|_{\text{out}}$ .

**Proof.** Since  $\text{stab}(a) = G$  and  $\rho = [s, \Gamma]$  is reduced, the edge  $a$  must both begin and end at  $*$ . (The only edges which end at  $*$  but begin somewhere else are the ones on which  $G$  acts nontrivially, else they are a  $G$ -invariant forest which we could collapse.) Since  $a \in D(\alpha)$ ,  $a^{-1} \notin \alpha$ . There is at least one edge in  $\alpha - \{a\}$ . Enumerate the edges of  $\alpha - \{a\}$  as  $b_0, \dots, b_r$ . Similarly, there is at least one edge in  $\alpha^{-1} - \{a^{-1}\}$ . Enumerate these as  $c_0, \dots, c_s \in \alpha^{-1} - \{a^{-1}\}$ . We have three cases, which are not disjoint but are exhaustive.

1. Some  $b_i$  is a loop at  $*$  and  $b_i^{-1} \notin \alpha$ . Let  $w_k \in \mathcal{W}$  be an element that maps to the loop  $b_i$ . Then  $(|a|_{\text{out}})_k = 0$  and  $(|\alpha|_{\text{out}})_k \geq 1$  since the loop  $b_i$  is sent to  $b_i e(\alpha)$ .

2. Some  $b_i$  starts at another vertex  $v_1 \neq *$ . Since  $G$  acts nontrivially on  $b_i$  and because  $b_i$  must be elliptic (as it is clearly not bent hyperbolic), there must be another  $b_j \neq b_i$  also going from  $*$  to  $v_1$ . (For the definitions of elliptic and bent hyperbolic see §4A in the paper by Krstic and Vogtmann.) There are two subcases:

- There is an edge  $c_l$  in  $\alpha^{-1} - \{a^{-1}\}$  that begins and ends at  $*$ . We can assume  $c_l^{-1} \in \alpha^{-1} - \{a^{-1}\}$  also, else we are in case 1. Choose a  $w_k \in \mathcal{W}$  that maps to the loop  $b_i b_j^{-1} c_l$ . Now  $(|a|_{out})_k = 0$  and  $(|\alpha|_{out})_k \geq 1$  since  $w_k$  is sent to  $e(\alpha)^{-1} b_i b_j^{-1} e(\alpha) c_l$ .
- There is an edge  $c_l$  in  $\alpha^{-1} - \{a^{-1}\}$  that begins at  $v_2 \neq *$  and ends at  $*$ . Because  $G$  acts nontrivially on  $c_l$  and  $c_l$  is elliptic, there is another edge  $c_m \neq c_l$  also going from  $v_2$  to  $*$ . Choose a  $w_k \in \mathcal{W}$  that maps to the loop  $b_i b_j^{-1} c_l c_m^{-1}$ . Then  $(|a|_{out})_k = 0$  but  $(|\alpha|_{out})_k \geq 1$  as  $b_i b_j^{-1} c_l c_m^{-1}$  is sent to  $e(\alpha)^{-1} b_i b_j^{-1} e(\alpha) c_l c_m^{-1}$ .

3. Some  $b_i$  is a loop at  $*$  and  $b_i^{-1} \notin \alpha$  also. As in case 2. above, there are two subcases.

- Same as in case 2. above. Choose a  $w_k \in \mathcal{W}$  that maps to  $b_i c_l$ . Then  $(|a|_{out})_k = 0$  but  $(|\alpha|_{out})_k \geq 1$  as  $b_i c_l$  is sent to  $e(\alpha)^{-1} b_i e(\alpha) c_l$ .
- Same as in case 2. above. Choose a  $w_k \in \mathcal{W}$  that maps to  $b_i c_l c_m^{-1}$ . Hence  $(|a|_{out})_k = 0$  and yet  $(|\alpha|_{out})_k \geq 1$  because  $b_i c_l c_m^{-1}$  is mapped to  $e(\alpha)^{-1} b_i e(\alpha) c_l c_m^{-1}$ .

In each case we have  $|a|_{out} \neq |\alpha|_{out}$ ; therefore,  $red_{out}(\alpha, a) \neq 0$  and  $\|\rho'\|_{out} = \|\rho\|_{out}$ .  $\square$

Proposition 6.1 of [19], states that

$$|A \amalg B|_{out} = |A|_{out} + |B|_{out} - 2(A.B)_{out}$$

for disjoint subsets  $A$  and  $B$  of  $E(\Gamma)$ . This also holds for *aut*-norms because it is our definition of the absolute values  $|\cdot|_{out}$  for sets of edges and can be inductively shown to be well-defined. It is important that this property holds for *aut*-norms because it is used by many of the later propositions in Krstic and Vogtmann (e.g., Proposition 6.2 of [19] which will correspond to our Proposition 11.4.)

Proposition 6.2 of [19] states that:

**Proposition 11.3 (Krstic-Vogtmann)** *Let  $K$  be a subgroup of  $G$ , let  $A$  be a  $K$ -invariant subset of  $E(\Gamma)$ , and let  $e$  be an edge of  $\Gamma$  with  $stab(e)$  contained in  $K$ . Then*

$$((Ke).A)_{out} = [K : stab(e)](e.A)_{out}.$$

We now show Proposition 6.2 of [19] also holds for the *aut*-norm, which will be useful in some combinatorial lemmas later in this chapter. Once we show that the analogue of Proposition 11.3 is true for the *aut*-norm, it will be true for both the *out*- and *aut*-norms on a component-by-component basis. In other words, the equality stated in the proposition is true for each component of  $\mathbb{Z}^{\mathcal{W}}$  or  $\mathbb{Z}^{F_n}$  and does not use the total (lexicographic) order on those sets. Hence it is automatically true for the *tot*-norm, as the *tot*-norm is just the product of the *out*-norm and the *aut*-

norm. We will be able to use the same approach (that of just showing something to be true for the aut-norm) in some lemmas later on in this chapter.

**Proposition 11.4** *Let  $K$  be a subgroup of  $G$ ,  $A$  be a  $K$ -invariant subset of  $E(\Gamma)$ , and  $e$  be an edge of  $\Gamma$  with  $\text{stab}(e)$  contained in  $K$ . Then*

$$((Ke).A)_{\text{aut}} = [K : \text{stab}(e)](e.A)_{\text{aut}}.$$

**Proof.** To simplify the notation in the proof below, we write (just for this proof)  $\|\cdot\|$  for  $\|\cdot\|_{\text{aut}}$ ,  $|\cdot|$  for  $|\cdot|_{\text{aut}}$ , reductive for aut-reductive, etc.

Examine  $((Ke).A)_i$ . It is the number of times one of the strings  $(ke)a^{-1}$  or  $a(ke)^{-1}$  appears in one of the  $x\alpha_i$ , for all  $k \in K$ ,  $a \in A$ , and  $x \in G$ .

Now  $\text{stab}(e) \subseteq K$  and we can write

$$K = \text{stab}(e) \coprod k_2\text{stab}(e) \coprod \dots \coprod k_{[K:\text{stab}(e)]}\text{stab}(e)$$

using coset representatives  $k_i$ . Further note that the number of times one of the strings  $ea^{-1}$  or  $ae^{-1}$  appears in one of the strings  $x\alpha_i$  for  $a \in A$ ,  $x \in G$  is exactly the same as the number of times one of the strings  $k_iae^{-1}$  or  $a(k_ie)^{-1}$  appears in one of the  $x\alpha_i$  for  $a \in A$ ,  $x \in G$ . This is because each  $k_i$  is in  $G$  and  $A$  is  $K$ -invariant so if  $ea^{-1}$  is in  $x\alpha_i$  then  $(k_ie)(k_ia)^{-1}$  is in  $(k_ix)\alpha_i$ . So  $((Ke).A)_i = [K : \text{stab}(e)](e.A)_i$ .  $\square$

Because of Proposition 11.1, tot-reductivity will be the most useful of the three types of reductivity (out, aut, and tot) for us. From now on when we say that  $\rho$  is *reductive*, this is just shorthand for saying  $\rho$  is tot-reductive.

**Proposition 11.5** *The set of basepointed marked  $G$ -graphs is well-ordered by the tot-norm.*

**Proof.** Note that Proposition 6.3 of [19] establishes the corresponding result for the out-norm. (It probably also holds for the aut-norm, but as we do not need this here we make no attempt to prove it.)

Let  $\mathcal{A}$  be a nonempty collection of basepointed marked  $G$ -graphs. We must find a least element of  $\mathcal{A}$ . Let  $[\mathcal{A}]$  be the set of equivalence classes of marked  $G$ -graphs in  $\mathcal{A}$  obtained by forgetting the basepoint  $*$ . Since from Proposition 6.3 of [19] the out-norm well orders marked  $G$ -graphs,  $[\mathcal{A}]$  has a least element  $U \subseteq \mathcal{A}$ .

Say  $\sigma = [s, \Gamma]$  is the (non-basepointed) marked  $G$ -graph representing this  $U$ . The marked graph  $\sigma$  corresponds to an action of  $F_n$  on the tree  $\tilde{\Gamma} = \Lambda$ . From [10] this action is free, *minimal* (there are no invariant proper subtrees), and not abelian (an action is *abelian* iff every element of the commutator  $[F_n, F_n]$  has length 0.) It also follows that the action is without inversions. (Suppose  $1 \neq a \in F_n$  acts as an inversion. Then  $a^2$  has a fixed point. Because the action of  $F_n$  on  $\Lambda$  is free, this means  $a^2 = 1$ . In the free group  $F_n$ , however, you can not have  $a \neq 1$  with  $a^2 = 1$ .)

The action has an associated length function  $l$  on  $F_n$ . Since the action is non-abelian, the length function is non-abelian. (See Alperin and Bass in [2] for the definition of an abelian length function. Further see Theorem 7.6(a) of [2] for a theorem which gives the above implication.) By Theorem 7.4 of [2], there exist  $\alpha_n, \alpha_m \in F_n$  such that the characteristic subtrees  $A_{\alpha_n}$  and  $A_{\alpha_m}$  are disjoint. (Recall that  $F_n = \{\alpha_1, \alpha_2, \dots\}$  as an ordered set.) Without loss of generality, we may assume  $n < m$ .

Since the action of  $F_n$  is free, both  $\alpha_n$  and  $\alpha_m$  are hyperbolic and  $A_{\alpha_n}, A_{\alpha_m}$  are linear subtrees. Recall that we wish to find the least element of  $U$  in the tot-

norm. Following the proof of Proposition 6.3 in [19], we set  $U_0 = U$  and define  $U_i$  inductively for  $i \geq 1$ . Let  $\gamma_i = \min\{(\|\delta\|_{out})_i : \delta \in U_{i-1}\}$ . Next define  $U_i$  to be the subset of  $U_{i-1}$  consisting of  $\delta$  with  $(\|\delta\|_{out})_i = \gamma_i$ . Our goal is to show that  $U_m$  contains only finitely many elements, because then we could just compare these finitely many elements to get the least one.

In order to make explicit a minor technical point, a couple of definitions are appropriate here. Say we have an action of the free group  $F_n$  on a basepointed tree  $T$ . Then the tree  $T'$  obtained by *forgetting the basepoint of  $T$*  is defined as follows. First, if the basepoint  $*$  of  $T$  had valence greater than or equal to 3, then  $T'$  is obtained by replacing the vertex  $*$  of  $T$  with a normal (i.e., not distinguished and not a basepoint) vertex. On the other hand, if  $*$  of  $T$  had valence 2, then we form  $T'$  by removing from  $T$  all of the vertices in the  $F_n$ -orbit of  $*$ . Hence, in both cases,  $T'$  is a tree which does not have a basepoint  $*$  and all of whose vertices have valence at least 3.

Next, we define an inverse of the above operation. That is, say that we have an action of the free group  $F_n$  on a (non-basepointed) tree  $T'$ . Choose a point  $v$  on  $T'$ , where  $v$  can either be a vertex of  $T'$  or the midpoint of an edge of  $T'$ . Then the tree  $T$  obtained by *placing a basepoint on  $T'$  at  $v$*  is defined as follows. First, if  $v$  is a vertex of  $T'$ , then  $T$  is just the tree  $T'$  with the vertex  $v$  replaced by the basepoint  $*$ . On the other hand, if  $v$  is the midpoint of an edge  $e$  of  $T'$ , then define  $T$  to be the result of adding a basepoint  $*$  to  $T'$  at  $v$  and subdividing all of the edges in the  $F_n$  orbit of  $e$ . Hence, in both cases, we have an induced action of  $F_n$  on a simplicial, basepointed tree  $T$ .

Each element of  $U$  corresponds to an action of  $F_n$  on a basepointed tree. In each case, if we forget the basepoint then the tree is just  $\Lambda$ . For each of these actions corresponding to elements of  $U$ , we can obtain a Lyndon length function on  $F_n$  by seeing how far each element moves the basepoint. This map from  $U$  to Lyndon length functions is injective (see [15], [2].) Note that in each case, the action of  $F_n$  on the underlying non-basepointed tree  $\Lambda$  is the same. We are only varying where we place the basepoint of  $\Lambda$  and seeing how far elements of  $F_n$  move this basepoint.

The elements of  $U_1$  are those where the basepoint is located closest to the linear subtree  $A_{\alpha_1} \subset \Lambda$ . Hence  $U_1$  could be infinite. (For example, if one element of  $U_1$  has its basepoint on  $A_{\alpha_1}$ , then  $U_1$  could be all of the vertices on  $A_{\alpha_1}$ .) By the  $m$ th stage, however, we have already considered both  $\alpha_n$  and  $\alpha_m$ . Because  $A_{\alpha_n}$  and  $A_{\alpha_m}$  are disjoint, there are only finitely many elements in  $U_m$ , as we show in the next two paragraphs.

Let  $B$  be the bridge joining  $A_{\alpha_n}$  and  $A_{\alpha_m}$ . Elements of  $U_m$  have basepoints that are both closest first to  $A_{\alpha_n}$  and then to  $A_{\alpha_m}$ . So they must be both close to  $A_{\alpha_n}$  and close to the endpoint of the bridge  $B$  on  $A_{\alpha_m}$ . Since only finitely many basepoints can be closest to the endpoint of this bridge, we are done and  $U_m$  is finite.

More formally, it suffices to show that there are only finitely many points at fixed distances  $d_1$  and  $d_2$  from  $A_{\alpha_n}$  and  $A_{\alpha_m}$ , respectively. If  $d(x, A_{\alpha_n}) = d_1$  and  $d(x, A_{\alpha_m}) = d_2$ , then choose paths  $p_1$  and  $p_2$  of lengths  $d_1$  and  $d_2$  from  $x$  to  $q_1 \in A_{\alpha_n}$  and  $q_2 \in A_{\alpha_m}$ , respectively. The union of these two paths  $p_1$  and  $p_2$  contains the bridge  $B$ . Consequently,  $d(x, B) \leq d_1 + d_2$ . Since the tree is locally finite and  $B$  is



finite,  $x$  is one of a finite number of vertices.  $\square$

A few definitions are in order at this point. Basically, we are trying to find the appropriate parallels of definitions in [19]. Fix a reduced marked  $G$ -graph  $\rho = [s, \Gamma]$ . Let  $(\mu, m)$  be a maximally reductive ideal pair of  $\rho$ . That is,  $\mu$  is the maximally reductive ideal edge in  $\rho$  and  $m \in D(\mu)$  is an edge in  $\mu$  which allows the Whitehead move  $(\mu, m)$  to realize this maximum.

Let  $\alpha \subset E_u$  and  $\beta \subset E_v$  be ideal edges of  $\rho$ . Then the ideal edge orbits  $G\alpha$  and  $G\beta$  are *compatible* if one of the following holds:

1.  $G\alpha \subseteq G\beta$ .
2.  $G\beta \subseteq G\alpha$ .
3.  $G\alpha \cap G\beta = \emptyset$  and  $\alpha \neq \beta^{-1}$ .
4.  $G\alpha \cap G\beta = \emptyset$  and  $u = v = *$ .

The ideal edge orbits  $G\alpha$  and  $G\beta$  are *pre-compatible* if one of the following holds:

1. They are compatible.
2.  $\alpha$  is invertible and  $\alpha^{-1} \subseteq \beta$ .
3.  $\beta$  is invertible and  $\beta^{-1} \subseteq \alpha$ .

Note that 2. and 3. above would be equivalent if we did not need to consider ideal edges of the form  $\gamma = E_* - \{c^{-1}\}$  which have  $stab(\gamma) = G$  but are not invertible.

An *oriented ideal forest* is a collection of pairwise compatible ideal edge orbits. These can be blown up to obtain marked graphs in the star in  $L_G$  of  $\rho$ . The

correspondence is not unique, however, as two different oriented ideal forests can be blown up to yield the same marked graph. This problem is solved by defining ideal forests. There is a poset isomorphism between the poset of ideal forests and the star of  $\rho$  in  $L_G$ .

An *ideal forest* is a collection  $\Phi = \Phi_1 \amalg \Phi_2$  where  $\Phi_1$  are the edges at  $*$  and  $\Phi_2$  are the edges not at  $*$ , such that

1. The elements of  $\Phi_2$  are pairwise pre-compatible and  $\Phi_2$  contains the inverse of each of its invertible edge orbits; and
2. The elements of  $\Phi_1$  are pairwise compatible.

With respect to a particular reduced marked  $G$ -graph  $\rho$  and maximally reductive ideal edge  $(\mu, m)$ , the following definitions will be used frequently in the next chapter (which contains the core proof of the contractibility of  $L_G$ .)

- $\mathcal{R} = \{\text{reductive ideal edges}\}$ .
- If  $\mathcal{C}$  is a set of ideal edges, then let  $\mathcal{C}^\pm$  denote the set obtained by adjoining to  $\mathcal{C}$  the inverses of its invertible elements that are not at the basepoint.
- Let  $S(\mathcal{C})$  be the subcomplex of the star  $st(\rho)$  spanned by ideal forests of  $\rho$ , all of whose edges are in  $\mathcal{C}$ . Note: The empty forest should not be taken to be in  $S(\mathcal{C})$ .
- $\mathcal{C}_0 = \{\alpha \in \mathcal{R} : \alpha \text{ is compatible with } \mu\}$ .
- $\mathcal{C}'_0 = \mathcal{C}_0 \cup \{\alpha \in \mathcal{R} : \text{if } \alpha \subset E_v \text{ then } stab(\alpha) = stab(v)\}$  (cf. Lemma 5.1 of [19].)

- $\mathcal{C}_1 = \mathcal{C}'_0 \cup \{\alpha \in \mathcal{R} : m \in G\alpha \text{ and } N(G\alpha, G\mu) = 1\}$ .

The definition of the crossing number  $N(G\alpha, G\mu)$  comes from §7 of [19] where it and other combinatorial notions are defined. For the reader's convenience, we briefly state their definitions again here. Say  $\alpha$  and  $\beta$  are two ideal edges at some vertex  $v$ , with stabilizers  $P$  and  $Q$ , respectively, of indices  $p$  and  $q$  in  $G$ . Choose double coset representatives  $x_1, \dots, x_k$  of  $P \backslash G / Q$ . The intersection  $\delta = \alpha \cap G\beta$  breaks up as a disjoint union

$$\delta = \gamma_1 \amalg \dots \amalg \gamma_k$$

with each  $\gamma_i = \alpha \cap Px_i\beta$ . The  $\gamma_i$  are called the *intersection components* of  $\alpha$  with  $\beta$  and the number  $N(G\alpha, G\beta)$  of nonempty intersection components is called the *crossing number*. If  $N(G\alpha, G\beta) = 1$  then  $G\alpha$  and  $G\beta$  are said to *cross simply*.

The following two lemmas are stated for the out-norm by Krstic and Vogtmann. We will show them for the aut-norm. The proofs will be routine, although they are not the same as the proofs given in [19]. This is because their proofs use the fact that  $|A|_{out} = (A.E(\Gamma) - A)_{out}$ , which is no longer true with the new norms. As with Proposition 11.4, the lemmas are true for both the out- and aut- norms on a component-by-component basis. That is, the inequalities stated in the lemmas are true for each component of  $\mathbb{Z}^W$  or  $\mathbb{Z}^{F_n}$  and do not use the total (lexicographic) order on those sets. Hence it suffices to show them for the aut-norm, as the tot-norm is just the products of the out-norm and the aut-norm.

**Lemma 11.6** *Suppose  $G\alpha$  and  $G\beta$  cross simply, with  $P \leq Q$ , then*

$$p|\alpha \cap \beta|_{aut} + q|\beta \cup Q\alpha|_{aut} \leq p|\alpha|_{aut} + q|\beta|_{aut}.$$

**Proof.** To simplify the notation in the proof below, we write (just for this proof)  $\|\cdot\|$  for  $\|\cdot\|_{aut}$ ,  $|\cdot|$  for  $|\cdot|_{aut}$ , reductive for aut-reductive, etc.

Let  $[Q : P] = n$ . Then  $p = nq$ . Dividing by  $q$ , we see that we want to show that

$$n|\alpha \cap \beta| + |\beta \cup Q\alpha| \leq n|\alpha| + |\beta|.$$

Let  $q_1, \dots, q_n$  be a set of coset representatives for  $P$  in  $Q$ . Let  $\delta = \alpha \cap \beta$ ,  $A = \alpha - \delta$ , and  $B = \beta - Q\delta$ .

Then the left hand side of what we want to show is

$$\begin{aligned} n|\delta| + |B \coprod Q\alpha| &= n|\delta| + |B| + |Q\alpha| - 2B.Q\alpha \\ &= n|\delta| + |B| + |Q\delta \coprod QA| - 2B.Q\alpha \\ &= n|\delta| + |B| + |Q\delta| + |QA| - 2Q\delta.QA - 2B.Q\alpha. \end{aligned}$$

Similarly, the right hand side of what we want to show is

$$n|\delta \coprod A| + |B \coprod Q\delta| = n|\delta| + n|A| - 2n\delta.A + |B| + |Q\delta| - 2B.Q\delta.$$

So we have reduced the problem to showing that

$$|QA| - 2Q\delta.QA - 2B.Q\alpha \leq n|A| - 2n\delta.A - 2B.Q\delta.$$

Note that  $-2B.Q\alpha \leq -2B.Q\delta$  as  $Q\delta \subseteq Q\alpha$ . Also note that

$$\begin{aligned} Q\delta.QA &= Q\delta.(q_1A \coprod \dots \coprod q_nA) \\ &= Q\delta.q_1A + \dots + Q\delta.q_nA \\ &= Q\delta.A + \dots + Q\delta.A \\ &= nQ\delta.A \\ &\geq n\delta.A. \end{aligned}$$

Hence  $-2Q\delta.QA \leq -2n\delta.A$ . In addition, we could use induction to show

$$\begin{aligned} |QA| &= |q_1A \amalg \dots \amalg q_nA| \\ &\leq |q_1A| + \dots + |q_nA| \\ &= |A| + \dots + |A| \\ &= n|A|. \end{aligned}$$

This establishes the lemma.  $\square$

**Lemma 11.7** *Suppose  $G\alpha$  and  $G\beta$  cross (i.e.,  $N(G\alpha, G\beta) \neq 0$ ). Just as  $\delta$  breaks up into intersection components of  $\alpha$  with  $\beta$ , let  $\delta' = \beta \cap G\alpha$  give the analogous disjoint components*

$$\delta' = \gamma'_1 \amalg \dots \amalg \gamma'_k$$

with  $\gamma'_i = \beta \cap Qx_i^{-1}\alpha$ . Then for all  $i$ ,

$$p|\alpha - \gamma_i|_{aut} + q|\beta - \gamma'_i|_{aut} \leq p|\alpha|_{aut} + q|\beta|_{aut}.$$

**Proof.** To simplify the notation in the proof below, we write (just for this proof)

$\|\cdot\|$  for  $\|\cdot\|_{aut}$ ,  $|\cdot|$  for  $|\cdot|_{aut}$ , reductive for aut-reductive, etc.

Let  $A = \alpha - \gamma_i$  and  $B = \beta - \gamma'_i$ . We must show that

$$p|\gamma_i| + q|\gamma'_i| \geq 2\gamma_i.A + 2\gamma'_i.B.$$

Note that  $G\gamma_i = G\gamma'_i$ . Choose coset representatives  $y_1, \dots, y_p$  for  $P$  in  $G$  and  $z_1, \dots, z_q$  for  $Q$  in  $G$ . Accordingly, we can express the left hand side of what we

want to show as

$$\begin{aligned}
p|\gamma_i| + q|\gamma'_i| &= \sum_{n=1}^p |\gamma_i| + \sum_{m=1}^q |\gamma'_i| \\
&= \sum_{n=1}^p |y_n \gamma_i| + \sum_{m=1}^q |z_m \gamma'_i| \\
&\geq |\coprod_{n=1}^p y_n \gamma_i| + |\coprod_{m=1}^q z_m \gamma'_i| \\
&= |G\gamma_i| + |G\gamma'_i| \\
&= 2|G\gamma_i| = 2|G\gamma'_i|.
\end{aligned}$$

Moreover, the right hand side of what we want to show is

$$\begin{aligned}
2\gamma_i.A + 2\gamma'_i.B &\leq 2G\gamma_i.A + 2G\gamma'_i.B \\
&= 2G\gamma_i.(A \coprod B) \\
&\leq 2G\gamma_i.(E(\Gamma) - G\gamma_i).
\end{aligned}$$

So to prove the lemma it suffices to show

$$|G\gamma_i| \geq G\gamma_i.(E(\Gamma) - G\gamma_i).$$

This can be shown by induction on  $|G\gamma_i|$ . In other words, say  $|C| \geq C.(E(\Gamma) - C)$

and assume  $y \notin C$ . Observe that

$$\begin{aligned}
|C \coprod \{y\}| &= |C| + |y| - 2C.y \\
&\geq C.(E(\Gamma) - C) + |y| - 2C.y \\
&= (C.(E(\Gamma) - C) - C.y) + (|y| - C.y) \\
&\geq C.(E(\Gamma) - (C \coprod \{y\})) + 0
\end{aligned}$$

so that the inductive step is completed.  $\square$

Next we show that the Pushing and Shrinking Lemmas of Krstic and Vogtmann hold in the context of aut-norms and absolute values. Unlike the proofs of the previous two lemma, the proofs for the next two follow exactly the same lines as the original proofs by Krstic and Vogtmann for out-norms and absolute values.

Basically, the only way that the new proofs will differ from the old ones is that occasionally we will have to verify the new cardinality conditions for ideal edges  $\alpha_0 \subseteq E_v$ , namely that:

- If  $v = *$  then  $\text{card}(\alpha_0) \geq 2$  and  $\text{card}(E_v - \alpha_0) \geq 1$ .
- If  $v \neq *$  then  $\text{card}(\alpha_0) \geq 2$  and  $\text{card}(E_v - \alpha_0) \geq 2$ .

As before, it is easily seen from the proofs of the lemmas that since they hold for both the out- and aut-norms and absolute values, they also hold for the tot-norms and absolute values.

**Lemma 11.8 (Pushing Lemma)** *Let  $(\mu, m)$  be a maximally aut-reductive ideal edge of a reduced basepointed marked  $G$ -graph with  $m \in D(\mu)$ . Let  $(\alpha, a)$  be an aut-reductive ideal edge containing  $m$  which simply crosses  $\mu$ , and set  $P = \text{stab}(\alpha)$ . Then either both  $\mu - \alpha$  and  $\alpha - \mu$  are aut-reductive or both  $\alpha \cup P\mu$  and  $\alpha \cap \mu$  are aut-reductive.*

**Proof.** To simplify the notation in the proof below, we write (just for this proof)  $\|\cdot\|$  for  $\|\cdot\|_{\text{aut}}$ ,  $|\cdot|$  for  $|\cdot|_{\text{aut}}$ , reductive for aut-reductive, etc.

Note that since  $m \in \alpha$ ,  $\text{stab}(\mu) \leq P$ . As in [19], there are four cases depending upon where  $a^{-1}$  and  $m^{-1}$  are located. Since this follows the proof by Krstic and Vogtmann so closely, the only real detail will be put into the first case.

*Case 1.*  $a^{-1} \notin G\mu$ . From Lemma 11.6,

$$[G : \text{stab}(\mu)]|\alpha \cap \mu| + [G : \text{stab}(\alpha)]|\alpha \cup P\mu| \leq [G : \text{stab}(\mu)]|\mu| + [G : \text{stab}(\alpha)]|\alpha|.$$

Consequently,

$$[G : \text{stab}(\mu)](|m| - |\alpha \cap \mu|) + [G : \text{stab}(\alpha)](|a| - |\alpha \cup P\mu|)$$

is greater than or equal to

$$[G : \text{stab}(\mu)](|m| - |\mu|) + [G : \text{stab}(\alpha)](|a| - |\alpha|).$$

In other words,

$$\text{red}(\alpha \cap \mu, m) + \text{red}(\alpha \cup P\mu) \geq \text{red}(\mu, m) + \text{red}(\alpha, a).$$

Since  $(\mu, m)$  is maximally reductive and  $(\alpha, a)$  is reductive, both of  $(\alpha \cup P\mu, a)$  and  $(\alpha \cap \mu, m)$  are reductive. As mentioned above in the discussion preceeding this lemma, we must verify the cardinality conditions on these two prospective ideal edges.

First we deal with  $(\alpha \cup P\mu, a)$ . The edge  $a$  is either bent hyperbolic or elliptic (see Corollary 4.5 of [19].) Assume it is bent hyperbolic. Then as in [19] we can choose  $x \in G$  such that  $xa^{-1} \in E_v - (G\alpha \cup G\mu)$ . If  $v \neq *$  and  $xa^{-1}$  is the only edge in  $E_v - (\alpha \cup P\mu)$  then

$$|\alpha \cup P\mu| = |xa^{-1}| = |a^{-1}| = |a|,$$

where the first equality holds because  $v \neq *$ , the second is by the  $G$ -invariance of  $|\cdot|$ , and the third follows from our definition of  $|\cdot|$  for edges.

In more detail, the first equality  $|\alpha \cup P\mu| = |xa^{-1}|$  holds since

$$E_v = (\alpha \cup P\mu) \coprod \{xa^{-1}\}$$



and  $v \neq *$ . For a particular coordinate  $i$ , both  $|\alpha \cup P\mu|_i$  and  $|xa^{-1}|_i$  are measuring the number of times one of the paths  $y\alpha_i$  enters  $v$  via  $\alpha \cup P\mu$  and leaves via the reverse of  $xa^{-1}$  (i.e.,  $xa$ ) or enters  $v$  via  $xa^{-1}$  and leaves it via the reverse of something in  $\alpha \cup P\mu$ . There would be problems if  $v = *$  since the above paths could then enter  $v$  and not have to leave it again.

But  $|\alpha \cup P\mu| = |a|$  contradicts the fact that  $(\alpha \cup P\mu, a)$  is reductive because

$$[G : \text{stab}(\alpha)](|a| - |\alpha \cup P\mu|) > 0.$$

So if  $v \neq *$  then  $xa^{-1}$  is not the only edge in  $E_v - (\alpha \cup P\mu)$ .

For the next possibility, that  $a$  is elliptic, the proof by Krstic and Vogtmann can be used verbatim.

Second we deal with  $(\alpha \cap \mu, m)$ . The set  $\alpha \cap \mu$  must contain more than two edges because it is reductive:

$$[G : \text{stab}(\mu)](|m| - |\alpha \cap \mu|) > 0.$$

The condition on the cardinality of  $E_v - (\alpha \cap \mu)$  is easily satisfied because  $\alpha$  is an ideal edge and so satisfies the corresponding condition with  $E_v - \alpha$ .

*Case 2.*  $a^{-1} \in G\mu$  and  $m^{-1} \in G\alpha$ .

Krstic and Vogtmann show that both  $(\alpha - \mu, ym^{-1})$  and  $(\mu - \alpha, xa^{-1})$  are reductive. The cardinality conditions on the edges for  $\alpha - \mu$  are easily satisfied. First,  $\alpha - \mu$  has more than one edge because it is a reductive set. Second,  $E_v - (\alpha - \mu)$  satisfies its cardinality condition because  $E_v - \alpha$  does. Analogous arguments also show the cardinality conditions for  $\mu - \alpha$ .

*Case 3.*  $a^{-1} \in G\mu$ ,  $m^{-1} \notin G\alpha$ , and  $a \in \mu$ .

Both  $(\alpha \cup \mu, m)$  and  $(\alpha \cap \mu, a)$  are reductive. See case 1. for how the cardinality checks should go.

*Case 4.*  $a^{-1} \in G\mu$ ,  $m^{-1} \notin G\alpha$ , and  $a \notin \mu$ .

Both  $(\alpha \cup \mu, m)$  and  $(\alpha \cap \mu, m)$  are reductive. See case 1. for how the cardinality checks should go.  $\square$

**Lemma 11.9 (Shrinking Lemma)** *Let  $(\mu, m)$  be as before. Let  $\alpha$  be an ideal edge with  $N(G\alpha, G\mu) \neq 0$ . Let  $\gamma_{i_1}, \dots, \gamma_{i_k}$  be the intersection components of  $\alpha$  with  $\mu$  which contain no translate of  $m$  and let  $\beta = \alpha - \bigcup \gamma_{i_j}$ . Then  $\beta$  or one of the sets  $\gamma_{i_j}$  is an aut-reductive ideal edge.*

**Proof.** See verbatim the proof by Krstic and Vogtmann. If  $\alpha_0$  is one of the above sets, we know it is aut-reductive, and we want to show it is an ideal edge, then the cardinality checks are easy. The set  $\alpha_0$  contains more than one edge because it is aut-reductive. Moreover, the cardinality checks on  $E_v - \alpha_0$  follow from similar ones on  $E_v - \alpha$ , because  $\alpha_0 \subset \alpha$  for each possibility of  $\alpha_0$ .  $\square$

The following proposition will also be useful in the next chapter. As before, ideal edges are in the reduced, basepointed marked  $G$ -graph  $\rho$  and  $(\mu, m)$  is a maximally reductive ideal edge.

**Proposition 11.10** *There is at most one reductive ideal edge  $(\gamma, c)$  at  $*$  with  $\text{stab}(\gamma) = G$  but where  $\gamma$  is not invertible. The Whitehead move  $(\gamma, c)$  is just conjugation by  $c$ , and  $\|\gamma\|_{\text{out}} = 0$ . If  $\gamma$  is not compatible with  $\mu$ , then  $c = m^{-1}$  and  $\mu$  is invertible.*

**Proof.** Since  $\text{stab}(\gamma) = G$  and yet  $\gamma$  is not invertible,  $E_* - \gamma$  must contain just one element. As  $c^{-1} \in E_* - \gamma$ , this means that  $E_* - \gamma = \{c^{-1}\}$ . So the Whitehead move  $(\gamma, c)$  consists of first blowing up  $\gamma$  and then collapsing  $c$ .

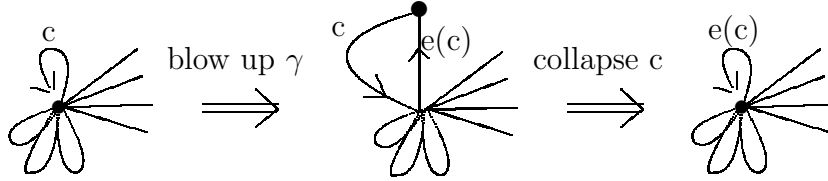

Figure 11.1: The Whitehead move  $(\gamma, c)$ .

The Whitehead move has no effect on the out-norm. The effect on the aut-norm can be calculated as follows. Recall that  $F_n = \{\alpha_1, \alpha_2, \dots\}$ . The Whitehead move  $(\gamma, c)$  conjugates each  $\alpha_i$  by  $c$ ; i.e., each  $\alpha_i \mapsto c^{-1}\alpha_i c$  (or  $e(c)^{-1}\alpha_i e(c)$  more accurately, but in the final graph we can just relabel  $e(c)$  as  $c$ .)

Since  $\gamma$  is reductive, it must decrease the length of some  $\alpha_i$ . Say  $\alpha_n$  is the first one whose length is decreased. Then the  $\alpha_1, \dots, \alpha_{n-1}$  are of the form

$$(c \rightsquigarrow x) \text{ or } (y \rightsquigarrow c^{-1})$$

where  $x \neq c^{-1}$ ,  $y \neq c$  and the  $\rightsquigarrow$  are just any words in the edges. In addition,  $\alpha_n$  is of the form

$$c \rightsquigarrow c^{-1}.$$

Thus for any other  $\gamma' = E_* - \{d^{-1}\}$ ,  $d \neq c$ ,  $\gamma'$  will increase the length of one of the  $\alpha_1, \dots, \alpha_n$  and it will not be reductive. So  $(\gamma, c)$  is the only reductive edge at  $*$  with  $\text{stab}(\gamma) = G$  but where  $\gamma$  is not invertible.

Further suppose that  $\gamma$  is not compatible with  $\mu$ . If  $c^{-1} \notin \mu$ , then  $\mu \subseteq \gamma$  and they are compatible. So  $c^{-1} \in \mu$ . As  $\text{stab}(c^{-1}) = G$ ,  $\text{stab}(\mu) = G$ . Since  $\mu$  is reductive and not equal to  $\gamma$ ,  $\mu$  is invertible. By way of contradiction, assume  $m \in \gamma$ . Then  $m \neq c$  else  $\gamma$  and  $\mu$  are compatible. We apply the Pushing Lemma to  $\gamma$  and  $\mu$ . Case 2 is the relevant case and so  $(\mu - \gamma, a^{-1})$  is reductive. This contradicts the fact that  $\mu - \gamma = \{a^{-1}\}$  has just one edge in it. So  $m \notin \gamma$  and hence  $c = m^{-1}$ .  $\square$

# Chapter 12

## The contractibility lemmas

**Theorem 12.1** *The fixed point subcomplex  $X_n^G$  is contractible.*

**Proof.** The space  $X_n^G$  deformation retracts to  $L_G$ . Following the proof of Theorem 8.1 by Krstic and Vogtmann in [19], we show that the complex  $L_G$  is contractible by setting

$$L_{<\rho} = \bigcup_{\|\rho'\|_{tot} < \|\rho\|_{tot}} st(\rho')$$

and letting

$$S_\rho = st(\rho) \cap L_{<\rho}.$$

As in [19], we show that  $S_\rho$  is contractible when it is non-empty, so that a transfinite induction argument then yields that for all  $\rho$ , all of the components of  $L_{<\rho}$  are contractible. Krstic's work in [18] shows that any two reduced graphs in  $L_G$  can be connected by Whitehead moves, so that  $L_G$  is connected. Thus  $L_G$  is contractible if we can perform the above transfinite induction.

As in [19], the first step is to deformation retract  $S_{<\rho}$  to  $S(\mathcal{R})$  by the Poset Lemma (stated in [19], deriving from Quillen in [22].) We can do this for the case of  $Aut(F_n)$  rather than  $Out(F_n)$  without any significant modifications of the arguments in the previous case. This is because the Factorization Lemma and Proposition 6.5 of [19] let us identify  $S_{<\rho}$  with the poset of ideal forests which contain a reductive ideal edge (where we must, of course, use the newly modified definition of an ideal forest.) (The Factorization Lemma gives a certain isomorphism between forest that does *not* preserve basepoints, but the fact that basepoints are not preserved is not relevant to Proposition 6.5.)

After contracting  $S_{<\rho}$  to  $S(\mathcal{R})$ , Krstic and Vogtmann then use a series of lemmas to deformation retract from  $S(\mathcal{R})$  to  $S(\mathcal{C}_1)$ , from there to  $S(\mathcal{C}_0)$ , and finally to a point. We more or less follow this, except there is an additional intermediate step where we deformation retract from  $S(\mathcal{C}_1)$  to  $S(\mathcal{C}'_0)$  and from there to  $S(\mathcal{C}_0)$ .

The rest of this chapter will be devoted to proving the aforementioned series of lemmas which show that  $S(\mathcal{R})$  deformation retracts to a point.  $\square$

We assume that the maximally reductive ideal edge  $(\mu, m)$  is at the basepoint in all that follows, else the arguments of Krstic and Vogtmann directly give the contractibility of  $S(\mathcal{R})$ . Moreover, if  $(\mu, m) = (\gamma, c)$  where  $\gamma = E_* - \{c^{-1}\}$ , then  $\mu$  is not out-reductive at all. Since  $\mu$  is maximally reductive, Proposition 11.10 implies that  $\mu$  is the only reductive ideal edge. So in this case  $\mathcal{R} = \mathcal{C}_0 = \{\mu\}$  and  $S(\mathcal{R})$  is contractible. Assume  $\mu \neq \gamma$  from now on.

Note the slight difference in our definition of  $\mathcal{C}_1$  from that of [19], where here it is phrased to include  $\alpha \subset E_v$  which have  $stab(\alpha) = stab(v)$ , rather than just

invertible  $\alpha$ . In other words, from Proposition 11.10, there is at most one reductive ideal edge  $(\gamma, c)$  at the basepoint which has  $\text{stab}(\gamma) = G$  and yet is not invertible. This  $\gamma$  would be in both  $\mathcal{C}_1$  and  $\mathcal{C}'_0$ .

The next lemma (unlike the ones which follow it) is essentially the corresponding lemma in [19] with minimal modifications. We repeat their arguments here for the sake of convenience.

**Lemma 12.2** *The complex  $S(\mathcal{R})$  deformation retracts onto  $S(\mathcal{C}_1)$ .*

**Proof.** Let  $\mathcal{C} = \mathcal{C}^\pm$  be a subset of  $\mathcal{R}$  which contains  $\mathcal{C}_1$ . We show that  $S(\mathcal{C})$  deformation retracts to  $S(\mathcal{C}_1)$  by induction on the cardinality of  $\mathcal{C} - \mathcal{C}_1$ .

Choose  $\alpha \in \mathcal{C} - \mathcal{C}_1$  which satisfies both of:

1. The cardinality  $|\alpha \cap G\mu|$  is minimal (recall that  $\mu$  is the maximally reductive ideal edge.)
2. The ideal edge  $\alpha$  is minimal with respect to property 1.

Using the Shrinking Lemma 7.4 of [19] with  $\alpha$  and  $\mu$ , we obtain a reductive ideal edge  $\alpha_0 \subset \alpha$  which is compatible with  $\mu$ . Let  $\gamma_i$  be the intersection components of  $\alpha$  with  $\mu$  and index them so that  $m \in \gamma_0$ . Now from the Shrinking Lemma, we can choose  $\alpha_0$  so that it is either one of the intersection components  $\gamma_{i_j}$  of  $\alpha$  with  $\mu$  which contain no translate of  $m$ , or it is  $\alpha - \cup \gamma_{i_j}$ . Because  $\alpha \in \mathcal{C} - \mathcal{C}_1$ ,  $\text{stab}(\alpha) \neq G$  and  $\alpha$  is neither invertible nor equal to  $\gamma = E_* - \{c^{-1}\}$ .

**Claim 12.3** *For every  $\beta \in \mathcal{C}$ , if  $G\beta$  is compatible with  $G\alpha$ , then  $G\beta$  is compatible with  $G\alpha_0$ .*

**Proof.** The three cases are

1.  $G\alpha \subseteq G\beta$ . In this case,  $G\alpha_0 \subseteq G\beta$  as  $G\alpha_0 \subseteq G\alpha$ .
2.  $G\alpha \cap G\beta = \emptyset$ . It follows that  $G\alpha_0 \cap G\beta = \emptyset$  since  $G\alpha_0 \subseteq G\alpha$ .
3.  $G\beta \subseteq G\alpha$ . Without loss of generality  $\beta \subseteq \alpha$ . If  $\beta \notin \mathcal{C}_1$ , then the minimality conditions on  $\alpha$  imply that  $\beta = \alpha$ , in which case  $\beta$  is clearly compatible with  $\alpha_0$ . So assume  $\beta \in \mathcal{C}_1$ . As  $G\beta \subseteq G\alpha$ ,  $\text{stab}(\beta) \neq G$  since  $\text{stab}(\alpha) \neq G$ . So either  $\beta \in \mathcal{C}_0$  or  $m \in G\beta$  and  $N(G\beta, G\mu) = 1$ . If  $\beta \in \mathcal{C}_0$  then either  $G\beta \subseteq G\mu$  (in which case  $\beta$  is in some  $\gamma_i$  and thus compatible with  $\alpha_0$ ),  $G\mu \subseteq G\beta$  (which can not happen as then  $\alpha$  would be in  $\mathcal{C}_0$ ), or  $G\beta \cap G\mu = \emptyset$  (in which case  $\beta \subseteq \alpha - \cup \gamma_{i_j}$  and thus compatible with  $\alpha_0$ .) Finally, if  $m \in G\beta$  and  $N(G\beta, G\mu) = 1$  then  $\beta \cap G\mu$  is not in any of the  $\gamma_{i_j}$ 's as those are the intersection components of  $\alpha$  with  $\mu$  that do not contain a translate of  $m$ . In fact,  $\beta \cap G\mu$  is in  $\gamma_0$  and  $\beta \subseteq \alpha - \cup \gamma_{i_j}$ . Thus  $\beta$  is compatible with every choice of  $\alpha_0$ .  $\square$

Define a poset map  $f : S(\mathcal{C}) \rightarrow S(\mathcal{C})$  by sending an ideal forest  $\Phi$  to  $\Phi \cup \{G\alpha_0\}$  if  $\Phi$  contains  $\alpha$  and to itself otherwise. By the Poset Lemma, the image of  $f$  is a deformation retract of  $S(\mathcal{C})$ , because  $\Phi \subseteq f(\Phi)$  for all  $\Phi$ . Define another poset map  $g : f(S(\mathcal{C})) \rightarrow f(S(\mathcal{C}))$  by sending an ideal forest  $\Psi$  to  $\Psi - \{G\alpha\}$  if  $\Psi$  contains  $\alpha$  and to itself otherwise. By the Poset Lemma, the image of  $g$  is a deformation retract of  $f(S(\mathcal{C}))$ , as  $g(\Psi) \subseteq \Psi$  for all  $\Psi$ . Hence  $S(\mathcal{C})$  deformation retracts to  $S(\mathcal{C} - \{G\alpha\})$ , completing the induction step.  $\square$



**Lemma 12.4** *The complex  $S(\mathcal{C}_1)$  deformation retracts onto  $S(\mathcal{C}'_0)$ .*

**Proof.** Let  $\mathcal{C}$  be a subset of  $\mathcal{C}_1$  which contains  $\mathcal{C}'_0$ . We show that  $S(\mathcal{C})$  deformation retracts to  $S(\mathcal{C}'_0)$  by induction on the cardinality of  $\mathcal{C} - \mathcal{C}'_0$ .

Choose  $\alpha \in \mathcal{C} - \mathcal{C}'_0$  such that  $m \in \alpha$  and

1. The cardinality  $|\alpha \cap G\mu|$  is minimal.
2. The ideal edge  $\alpha$  is minimal with respect to property 1.

We apply the Pushing Lemma 7.3 of [19] (just look at the actual results that each of the cases in the proof gives you) to get a reductive edge  $\alpha_0$  with  $\alpha_0 = \alpha \cap \mu$  or  $\alpha_0 = \alpha - \mu$ . Note that  $\alpha_0 \in \mathcal{C}_0$ .

**Claim 12.5** *For every  $\beta \in \mathcal{C}$ , if  $G\beta$  is compatible with  $G\alpha$ , then  $G\beta$  is compatible with  $G\alpha_0$ .*

**Proof.** The three cases are

1.  $G\alpha \subseteq G\beta$ . In this case,  $G\alpha_0 \subseteq G\beta$  as  $G\alpha_0 \subseteq G\alpha$ .
2.  $G\alpha \cap G\beta = \emptyset$ . It follows that  $G\alpha_0 \cap G\beta = \emptyset$  since  $G\alpha_0 \subseteq G\alpha$ .
3.  $G\beta \subseteq G\alpha$ . Without loss of generality  $\beta \subseteq \alpha$ . If  $\beta \notin \mathcal{C}'_0$ , then the minimality conditions on  $\alpha$  imply that  $\beta = \alpha$ , in which case  $\beta$  is clearly compatible with  $\alpha_0$ . So assume  $\beta \in \mathcal{C}'_0$ . Since  $\alpha \in \mathcal{C} - \mathcal{C}'_0$ ,  $\text{stab}(\alpha) \neq G$ . As  $G\beta \subseteq G\alpha$ ,  $\text{stab}(\beta) \neq G$  also, which means that  $\beta \in \mathcal{C}_0$ . The three ways in which  $\beta$  could be compatible with  $\mu$  are:

- $G\beta \cap G\mu = \emptyset$ . Then  $G\beta$  is disjoint from  $G(\alpha \cap \mu)$  and contained in  $G(\alpha - \mu)$ .
- $G\beta \subseteq G\mu$ . Then  $G\beta \subseteq G(\alpha \cap \mu)$  and  $G\beta$  is disjoint from  $G(\alpha - \mu)$ .
- $G\mu \subseteq G\beta$ . Then  $G\mu \subseteq G\alpha$  and so  $G\mu$  and  $G\alpha$  are compatible, a contradiction.  $\square$

Define a poset map  $f : S(\mathcal{C}) \rightarrow S(\mathcal{C})$  by sending an ideal forest  $\Phi$  to  $\Phi \cup \{G\alpha_0\}$  if  $\Phi$  contains  $\alpha$  and to itself otherwise. By the Poset Lemma, the image of  $f$  is a deformation retract of  $S(\mathcal{C})$ , because  $\Phi \subseteq f(\Phi)$  for all  $\Phi$ . Define another poset map  $g : f(S(\mathcal{C})) \rightarrow f(S(\mathcal{C}))$  by sending an ideal forest  $\Psi$  to  $\Psi - \{G\alpha\}$  if  $\Psi$  contains  $\alpha$  and to itself otherwise. By the Poset Lemma, the image of  $g$  is a deformation retract of  $f(S(\mathcal{C}))$ , as  $g(\Psi) \subseteq \Psi$  for all  $\Psi$ . Hence  $S(\mathcal{C})$  deformation retracts to  $S(\mathcal{C} - \{G\alpha\})$ , completing the induction step.  $\square$

Now we are left with the task of showing that  $S(\mathcal{C}'_0)$  deformation retracts to  $S(\mathcal{C}_0)$  and from there to a point. From Proposition 11.10, we see that this can be handled in three separate cases:

- The ideal edge  $\mu$  is invertible and the reductive ideal edge  $\gamma = E_* - \{c^{-1}\}$  is not compatible with  $\mu$ . In this case, the proposition gives us that  $c = m^{-1}$ .
- The ideal edge  $\mu$  is invertible and the reductive ideal edge  $\gamma = E_* - \{c^{-1}\}$  is compatible with  $\mu$ .
- The ideal edge  $\mu$  is not invertible.

**Lemma 12.6** *Suppose  $\mu$  is invertible and  $\gamma = E_* - \{m\}$  is reductive. Then  $S(\mathcal{C}'_0)$  is contractible.*

**Proof.** We first contract  $S(\mathcal{C}'_0)$  to  $S(\mathcal{C}_0 \cup \{\gamma\})$ . Let  $\mathcal{C}$  be a subset of  $\mathcal{C}'_0$  which contains  $\mathcal{C}_0 \cup \{\gamma\}$ . Also assume that if  $\alpha \in \mathcal{C}$  is not pre-compatible with  $\mu$ , then  $\alpha^{-1} \in \mathcal{C}$  also. We will use induction on  $|\mathcal{C} - (\mathcal{C}_0 \cup \{\gamma\})|$  to show that  $S(\mathcal{C})$  deformation retracts to  $S(\mathcal{C}_0 \cup \{\gamma\})$ .

Choose  $\alpha \in \mathcal{C} - (\mathcal{C}_0 \cup \{\gamma\})$  such that  $m \in \alpha$  and

1. The cardinality  $|\alpha \cap \mu|$  is maximal.
2. The edge  $\alpha$  is maximal with respect to property 1.

There are two main cases, and two subcases in the second case.

*Case 1.*  $\alpha^{-1}$  is compatible with  $\mu$ .

Then  $\mu \not\subseteq \alpha^{-1}$  because  $m \in \mu$  and  $m \in \alpha$ . Also,  $\mu \cap \alpha^{-1} \neq \emptyset$  else  $\mu \subseteq \alpha$  and  $\alpha$  is compatible with  $\mu$ . So  $\alpha^{-1} \subseteq \mu$ . Let  $\alpha_0 = \alpha^{-1}$  and note that  $\alpha_0 \in \mathcal{C}$ .

**Claim 12.7** *For every  $\beta$  in  $\mathcal{C}$ , if  $G\beta$  is compatible with  $\alpha$ , then  $G\beta$  is compatible with  $\alpha_0$ .*

**Proof.** If  $G\beta \subseteq \alpha$  then  $G\beta \cap \alpha_0 = \emptyset$ . On the other hand, if  $G\beta \cap \alpha = \emptyset$ , then  $G\beta \subseteq \alpha_0$ .

Finally, assume  $\alpha \subseteq G\beta$ . Note that  $\beta \neq \gamma$  as  $m \in \alpha \subseteq G\beta$ . So  $\beta$  is invertible and  $G\beta = \beta$ , as  $\alpha \subseteq G\beta$  and  $\alpha$  is invertible. Since  $\alpha \subseteq \beta$  and  $\alpha^{-1} \subseteq \mu$ ,  $\beta^{-1} \subseteq \mu$ . As  $m \in \beta \cap \mu$  and  $\beta^{-1} \subseteq \mu$ ,  $\beta$  is not compatible with  $\mu$ . So  $\beta \in \mathcal{C} - (\mathcal{C}_0 \cup \{\gamma\})$ .

But  $|\alpha \cap \mu| \leq |\beta \cap \mu|$  and so the maximality conditions on  $\alpha$  give  $\beta = \alpha$ . Hence  $\beta$  is compatible with  $\alpha_0$ .  $\square$

By the claim we can define  $f : S(\mathcal{C}) \rightarrow S(\mathcal{C})$  by sending an ideal forest  $\Phi$  to  $\Phi \cup \{G\alpha_0\}$  if  $\Phi$  contains  $\alpha$  and to itself otherwise. We can also define  $g : f(S(\mathcal{C})) \rightarrow f(S(\mathcal{C}))$  by sending an ideal forest  $\Psi$  to  $\Psi - \{G\alpha\}$  if  $\Psi$  contains  $\alpha$  and to itself otherwise. Then  $g(f(S(\mathcal{C}))) = S(\mathcal{C} - \{\alpha\})$  and  $S(\mathcal{C})$  deformation retracts to this by two applications of the Poset Lemma.

*Case 2.*  $\alpha^{-1}$  is not compatible with  $\mu$ .

Since  $\alpha$  and  $\mu$  cross simply (this is automatic because  $\alpha$  is invertible), the Pushing Lemma applies. Thus one of the sets  $\alpha_0 = \mu - \alpha$  or  $\alpha_0 = \alpha \cup \mu$  is a reductive ideal edge. As  $\mu - \alpha \subseteq \mu$  and  $\mu \subseteq \alpha \cup \mu$ ,  $\alpha_0 \in \mathcal{C}_0$  in either case.

*Subcase 1.*  $\alpha_0 = \mu - \alpha$ .

**Claim 12.8** *For every  $\beta \in \mathcal{C}$ , if  $G\beta$  is pre-compatible with  $\alpha$ , then  $G\beta$  is compatible with  $\alpha_0$ .*

**Proof.** We list what happens in each of the possible ways that  $G\beta$  can be pre-compatible with  $\alpha$ .

- $\beta = \gamma$ . Now  $m \in \alpha$  and thus  $m \notin \mu - \alpha$ . So  $\alpha_0 \subseteq \gamma$ .
- $G\beta \subseteq \alpha$ . Then  $G\beta \cap \alpha_0 = \emptyset$ .
- $\beta$  is invertible and  $\beta^{-1} \subseteq \alpha$ . Then  $\alpha_0 \subseteq \beta$ .
- $\alpha \subseteq G\beta$ . Then  $\beta$  is invertible and  $\alpha \subseteq \beta$ . Also  $|\alpha \cap \mu| \leq |\beta \cap \mu|$ . If  $\beta \notin \mathcal{C}_0 \cup \{\gamma\}$  then the maximality conditions on  $\alpha$  give us that  $\beta = \alpha$ . As  $\alpha \cap \alpha_0 = \emptyset$ , they

are compatible in this situation. Now  $\beta \neq \gamma$  as  $m \in \alpha \subseteq \beta$  (or, alternatively, just because we already handled that case above.) So the possibility left is that  $\beta \in \mathcal{C}_0$ . If  $\beta \subseteq \mu$ , then we get a contradiction because then  $\alpha \subseteq \beta \subseteq \mu$  and  $\alpha \in \mathcal{C}_0$ . Similarly, since  $m \in \beta \cap \mu$ , we also can not have  $\beta \cap \mu = \emptyset$ . So  $\mu \subseteq \beta$  and thus  $\beta \supseteq \mu - \alpha = \alpha_0$ .

- $\alpha \cap G\beta = \emptyset$ .

If  $\beta$  is invertible, then  $\alpha \subseteq \beta^{-1}$  and we can apply the methods of the previous case. Namely, if  $\beta^{-1} \in \mathcal{C}_0$  then  $\mu \subseteq \beta^{-1}$  is the only possible case. So  $\beta$  is disjoint from  $\mu - \alpha = \alpha_0$ . Also if  $\beta \subseteq \mu$  then  $\beta \subseteq \mu - \alpha = \alpha_0$  since  $\alpha \cap G\beta = \emptyset$ . Alternatively, if we assume  $\beta$  is not pre-compatible with  $\mu$ , then  $\beta^{-1} \in \mathcal{C}$  as  $\beta \in \mathcal{C}$ . So we have  $\beta^{-1} \in \mathcal{C} - (\mathcal{C}_0 \cup \{\gamma\})$  and  $\alpha \subseteq \beta^{-1}$ . Hence the maximality conditions on  $\alpha$  yield that  $\beta^{-1} = \alpha$ . Since  $\alpha_0 = \mu - \alpha \subseteq \alpha^{-1} = \beta$ ,  $\alpha_0$  is compatible with  $\beta$  here also.

Next assume  $\beta$  is not invertible. Consequently,  $\beta \in \mathcal{C}_0$  and we have the standard three possibilities for how  $\beta$  and  $\mu$  are compatible. If  $G\beta \subseteq \mu$ , then  $G\beta \subseteq \alpha_0$ . On the other hand, if  $G\beta \cap \mu = \emptyset$  then  $G\beta \cap \alpha_0 = \emptyset$ . Finally, since  $m \in G\beta \cap \alpha$ , we can not have  $G\beta \supseteq \mu$ .  $\square$

So by the claim we can define  $f : S(\mathcal{C}) \rightarrow S(\mathcal{C})$  by sending an ideal forest  $\Phi$  to  $\Phi \cup \{G\alpha_0\}$  if  $\Phi$  contains  $\alpha$  or  $\alpha^{-1}$  and to itself otherwise. We can also define  $g : f(S(\mathcal{C})) \rightarrow f(S(\mathcal{C}))$  by sending an ideal forest  $\Psi$  to  $\Psi - \{\alpha, \alpha^{-1}\}$  if  $\Psi$  contains  $\alpha$  or  $\alpha^{-1}$  and to itself otherwise. Then  $g(f(S(\mathcal{C}))) = S(\mathcal{C} - \{\alpha, \alpha^{-1}\})$  and  $S(\mathcal{C})$  deformation retracts to this by two applications of the Poset Lemma.

Subcase 2.  $\alpha_0 = \alpha \cup \mu$ . The ideal edge  $\alpha_0$  does not equal  $\gamma$  since it is out-reductive by the proof of the Pushing Lemma (because  $\alpha$  and  $\mu$  are not equal to  $\gamma$  and thus out-reductive.) (Alternatively, it is clear that  $\alpha_0 \neq \gamma$  because  $m \in \alpha_0$ .) Accordingly,  $\alpha_0$  is invertible and both  $\alpha_0$  and  $\alpha_0^{-1}$  are in  $\mathcal{C}_0$ .

**Claim 12.9** *For every  $\beta \in \mathcal{C}$ , if  $G\beta$  is compatible with  $\alpha^{-1}$  then  $G\beta$  is compatible with  $\alpha_0^{-1}$ .*

**Proof.** We list what happens in each of the possible ways that  $G\beta$  can be compatible with  $\alpha^{-1}$ .

- $\beta = \gamma$ . Note that  $m \in \alpha_0$  and consequently  $m \notin \alpha_0^{-1}$ . For this reason,  $\alpha_0^{-1} \subseteq \beta$  and they are compatible. Assume  $\beta \neq \gamma$  from now on.
- $G\beta \cap \alpha^{-1} = \emptyset$ . Hence  $G\beta \subseteq \alpha \subseteq \alpha \cup \mu = \alpha_0$  and  $G\beta \cap \alpha_0^{-1} = \emptyset$ .
- $\alpha^{-1} \subseteq G\beta$ . In this case,  $\alpha_0^{-1} \subseteq \alpha^{-1} \subseteq G\beta$ .
- $G\beta \subseteq \alpha^{-1}$ .

Suppose  $\beta$  is invertible. Then  $\alpha \subseteq \beta^{-1}$ . Now if  $\beta \subseteq \mu$  then  $\beta \cap \alpha_0^{-1} = \emptyset$  and they are compatible. Also if  $\beta^{-1} \in \mathcal{C}_0$ , then neither  $\beta^{-1} \subseteq \mu$  nor  $\beta^{-1} \cap \mu = \emptyset$  can occur because the first contradicts the fact that  $\alpha$  is not compatible with  $\mu$  and the second contradicts the fact that  $m \in \beta^{-1} \cap \mu$ . Accordingly,  $\mu \subseteq \beta^{-1}$  and  $\beta^{-1} \supseteq \alpha \cup \mu = \alpha_0$ . Thus  $\alpha_0^{-1} \supseteq \beta$  and  $\beta$  is compatible with  $\alpha_0^{-1}$ . So the last possibility is that  $\beta$  is not pre-compatible with  $\mu$ . Then our assumptions on  $\mathcal{C}$  imply that  $\beta^{-1} \in \mathcal{C}$  also. Since  $\alpha \subseteq \beta^{-1}$ , the maximality conditions on  $\alpha$  yield that  $\alpha = \beta^{-1}$ . It follows that  $\alpha_0^{-1} \subseteq \beta$  and they are compatible.

If we suppose  $\beta$  is not invertible, then  $\beta \in \mathcal{C}_0$  and there are three possibilities. If  $G\beta \subseteq \mu$ , then  $G\beta \cap \alpha_0^{-1} = \emptyset$ . If  $G\beta \cap \mu = \emptyset$  then  $G\beta \subseteq (\alpha \cup \mu)^{-1} = \alpha_0^{-1}$  since  $G\beta \subseteq \alpha^{-1}$  also. Finally, because  $m \notin \alpha^{-1}$  and  $G\beta \subseteq \alpha^{-1}$ , the last case  $G\beta \supseteq \mu$  will not happen.  $\square$

Therefore we can define  $f : S(\mathcal{C}) \rightarrow S(\mathcal{C})$  by sending an ideal forest  $\Phi$  to  $\Phi \cup \{\alpha_0^{-1}\}$  if  $\Phi$  contains  $\alpha^{-1}$  and to itself otherwise. We can also define  $g : f(S(\mathcal{C})) \rightarrow f(S(\mathcal{C}))$  by sending an ideal forest  $\Psi$  to  $\Psi - \{\alpha^{-1}\}$  if  $\Psi$  contains  $\alpha^{-1}$  and to itself otherwise. Then  $g(f(S(\mathcal{C}))) = S(\mathcal{C} - \{\alpha^{-1}\})$  and  $S(\mathcal{C})$  deformation retracts to this by two applications of the Poset Lemma.

We must further contract  $S(\mathcal{C} - \{\alpha^{-1}\})$  to  $S(\mathcal{C} - \{\alpha, \alpha^{-1}\})$ . This is done via the following claim:

**Claim 12.10** *For every  $\beta \in \mathcal{C} - \{\alpha^{-1}\}$ , if  $G\beta$  is compatible with  $\alpha$  then  $G\beta$  is compatible with  $\alpha_0$ .*

**Proof.** Note that  $\gamma$  is not compatible with  $\alpha$ . As before, we list the standard cases:

- $G\beta \subseteq \alpha$ . Then  $G\beta \subseteq \alpha \cup \mu = \alpha_0$ .
- $\alpha \subseteq G\beta$ . Then  $\beta$  is invertible and  $\alpha \subseteq \beta$ . Note that  $|\alpha \cap \mu| \leq |\beta \cap \mu|$ . If  $\beta \notin \mathcal{C}_0 \cup \{\gamma\}$  then the maximality conditions on  $\alpha$  give us that  $\beta = \alpha$ . As  $\alpha \subseteq \alpha \cup \mu = \alpha_0$ , they are compatible in this situation. Next we examine what happens if  $\beta \in \mathcal{C}_0$ . Neither the case  $\beta \subseteq \mu$  nor  $\beta \cap \mu = \emptyset$  can occur as the first contradicts the fact that  $\alpha$  is not compatible with  $\mu$  and the second that  $m \in \beta \cap \mu$ . Accordingly,  $\mu \subseteq \beta$  and  $\beta \supseteq \alpha \cup \mu = \alpha_0$ .

- $\alpha \cap G\beta = \emptyset$ .

If  $\beta$  is invertible, then  $\alpha \subseteq \beta^{-1}$  and we can apply similar methods to those used in the last case. Namely, if  $\beta^{-1} \in \mathcal{C}_0$  then  $\mu \subseteq \beta^{-1}$  is the only possible case. So  $\beta^{-1} \supseteq \alpha \cup \mu$  and  $\alpha_0 \cap \beta = \emptyset$ . Also if  $\beta \subseteq \mu$  then  $\beta \subseteq \alpha \cup \mu = \alpha_0$ . Hence the last case left is where  $\beta$  is not pre-compatible with  $\mu$ . Then  $\beta^{-1} \in \mathcal{C}$  because  $\beta \in \mathcal{C}$ . Since  $\alpha \subseteq \beta^{-1}$ , the maximality conditions on  $\alpha$  yield that  $\alpha = \beta^{-1}$ . As  $\beta$  lies in  $\mathcal{C} - \{\alpha^{-1}\}$ , this gives a contradiction. So the last case will not actually occur.

Now assume  $\beta$  is not invertible, so that  $\beta \in \mathcal{C}_0$ . If  $G\beta \subseteq \mu$ , then  $G\beta \subseteq \alpha \cup \mu = \alpha_0$ . Alternatively, if  $G\beta \cap \mu = \emptyset$  then  $G\beta \cap (\alpha \cup \mu) = \emptyset$  as  $\alpha \cap G\beta = \emptyset$  also.

Finally, the case  $G\beta \supseteq \mu$  does not take place, else  $m \in G\beta \cap \alpha$ .  $\square$

Using this last claim we can define  $f : S(\mathcal{C} - \{\alpha_0^{-1}\}) \rightarrow S(\mathcal{C} - \{\alpha_0^{-1}\})$  by sending an ideal forest  $\Phi$  to  $\Phi \cup \{\alpha_0\}$  if  $\Phi$  contains  $\alpha$  and to itself otherwise. We can also define  $g : f(S(\mathcal{C} - \{\alpha_0^{-1}\})) \rightarrow f(S(\mathcal{C} - \{\alpha_0^{-1}\}))$  by sending an ideal forest  $\Psi$  to  $\Psi - \{\alpha\}$  if  $\Psi$  contains  $\alpha$  and to itself otherwise. Then  $g(f(S(\mathcal{C}))) = S(\mathcal{C} - \{\alpha, \alpha^{-1}\})$  and  $S(\mathcal{C})$  deformation retracts to this by two applications of the Poset Lemma.

This concludes our argument that  $S(\mathcal{C}'_0)$  contracts to  $S(\mathcal{C}_0 \cup \{\gamma\})$ . To eliminate  $\gamma$ , note that  $\gamma$  is compatible with  $\mu^{-1} \in \mathcal{C}_0$  and proceed to the following claim:

**Claim 12.11** *For every  $\beta \in \mathcal{C}_0$ , if  $G\beta$  is compatible with  $\gamma$  then  $G\beta$  is compatible with  $\mu^{-1}$ .*

**Proof.** Observe that if  $G\beta$  is not invertible then the fact that it is compatible with  $\mu$  means it is compatible with  $\mu^{-1}$ . So we can assume  $\beta$  is invertible. Since  $\beta$  is



compatible with  $\gamma$ ,  $m \notin \beta$ . Because  $m \in \mu$ , we can not have  $\mu \subseteq \beta$ . If  $\mu \cap \beta = \emptyset$  then  $\beta \subseteq \mu^{-1}$  and we are fine. Also if  $\beta \subseteq \mu$  then  $\beta \cap \mu^{-1} = \emptyset$  and  $\beta$  and  $\mu^{-1}$  are compatible here also.  $\square$

Now define poset maps  $f$  and  $g$  analogously to all of the times we did this above to add  $\mu^{-1}$  to ideal forests containing  $\gamma$ , and then to delete  $\gamma$ . This allows us to deformation retract  $S(\mathcal{C}_0 \cup \{\gamma\})$  to  $S(\mathcal{C})$ .

The final step of contracting  $S(\mathcal{C}_0)$  to a point is done with poset maps  $f$  and  $g$  as above which first add  $\mu$  to all ideal forests and then delete from these ideal forests everything except  $\mu$ .  $\square$

**Lemma 12.12** *Suppose  $\mu$  is invertible and the reductive  $\gamma = E_* - \{c^{-1}\}$  is compatible with  $\mu$ . Then  $S(\mathcal{C}'_0)$  is contractible.*

**Proof.** The proof of the more complicated case in Lemma 12.6 carries over to this one, with the exception that the penultimate step of deformation retracting from  $S(\mathcal{C}_0 \cup \{\gamma\})$  to  $S(\mathcal{C})$  is unnecessary, because  $\gamma$  is already compatible with  $\mu$ . In addition, various other minor changes need to be made to the claims listed under Lemma 12.6, because  $\gamma$  is now compatible with  $\mu$ , but the changes are all easy and direct.  $\square$

**Lemma 12.13** *Suppose  $\mu$  is not invertible. Then  $S(\mathcal{C}'_0)$  is contractible.*

**Proof.** As before, let  $\gamma = E_* - \{c^{-1}\}$  be the reductive edge that Proposition 11.10 gives us (if it exists). We know that  $\gamma$  is compatible with  $\mu$  because  $\text{stab}(\mu) \neq G = \text{stab}(c^{-1})$ .

The proof of this lemma is basically the proof in Subcase 2, Case 2 of Lemma 12.6 above; however, since  $\mu$  not being invertible changes a few things, it seems useful to state the entire proof here.

We first contract  $S(\mathcal{C}'_0)$  to  $S(\mathcal{C}_0)$ . Let  $\mathcal{C}$  be a subset of  $\mathcal{C}'_0$  which contains  $\mathcal{C}_0$ . Also assume that if  $\alpha \in \mathcal{C}$  and  $\alpha$  is invertible, then  $\alpha^{-1} \in \mathcal{C}$  also. We will use induction on  $|\mathcal{C} - \mathcal{C}_0|$  to show that  $S(\mathcal{C})$  deformation retracts to  $S(\mathcal{C}_0)$ .

Choose  $\alpha \in \mathcal{C} - (\mathcal{C}_0)$  such that  $m \in \alpha$  and

1. The cardinality  $|\alpha \cap G\mu|$  is maximal.
2. The edge  $\alpha$  is maximal with respect to property 1.

Since  $\alpha$  and  $\mu$  cross simply (this is automatic because  $\alpha$  is invertible), the Pushing Lemma applies. Say  $\alpha = (\alpha, a)$ . Neither  $a$  nor  $a^{-1}$  is in  $\mu$  since  $\text{stab}(a) = G$  and  $\mu$  is not invertible (and not equal to  $\gamma$ .) So case 1 of the Pushing Lemma shows that  $\alpha_0 = \alpha \cup G\mu$  is a reductive ideal edge. As  $\mu \subseteq \alpha \cup G\mu$ ,  $\alpha_0 \in \mathcal{C}_0$ . The ideal edge  $\alpha_0$  is not equal to  $\gamma$  because it is out-reductive by the proof of the Pushing Lemma (as both  $\alpha$  and  $\mu$  are out-reductive.) So  $\alpha_0$  is invertible and  $\alpha_0^{-1} \in \mathcal{C}_0$  also.

**Claim 12.14** *For every  $\beta \in \mathcal{C}$ , if  $G\beta$  is compatible with  $\alpha^{-1}$  then  $G\beta$  is compatible with  $\alpha_0^{-1}$ .*

**Proof.** We list what happens in each of the possible ways that  $G\beta$  can be compatible with  $\alpha^{-1}$ .

- $\beta = \gamma$ . Then  $\alpha^{-1} \subseteq \gamma$  so  $c^{-1} \notin \alpha^{-1}$ . Thus  $c^{-1} \in \alpha$ . So  $c^{-1} \in \alpha \cup G\mu = \alpha_0$  and  $c^{-1} \notin \alpha_0^{-1}$ . Hence  $\gamma$  is compatible with  $\alpha_0^{-1}$ . Assume  $\beta \neq \gamma$  from now on.

- $G\beta \cap \alpha^{-1} = \emptyset$ . Hence  $G\beta \subseteq \alpha \subseteq \alpha \cup G\mu = \alpha_0$  and  $G\beta \cap \alpha_0^{-1} = \emptyset$ .
- $\alpha^{-1} \subseteq G\beta$ . In this case,  $\alpha_0^{-1} \subseteq \alpha^{-1} \subseteq G\beta$ .
- $G\beta \subseteq \alpha^{-1}$ .

Suppose  $\beta$  is invertible. Then  $\alpha \subseteq \beta^{-1}$ . If  $\beta^{-1} \in \mathcal{C}_0$ , then neither  $\beta^{-1} \subseteq G\mu$  nor  $\beta^{-1} \cap G\mu = \emptyset$  can occur because the first contradicts the fact that  $\alpha$  is not compatible with  $G\mu$  (or alternatively the fact that  $\mu$  is not invertible) and the second contradicts the fact that  $m \in \beta^{-1} \cap G\mu$ . Accordingly,  $G\mu \subseteq \beta^{-1}$  and  $\beta^{-1} \supseteq \alpha \cup G\mu = \alpha_0$ . Thus  $\alpha_0^{-1} \supseteq \beta$  and  $\beta$  is compatible with  $\alpha_0^{-1}$ . So the last possibility is that  $\beta^{-1} \in \mathcal{C} - \mathcal{C}_0$ . Since  $\alpha \subseteq \beta^{-1}$ , the maximality conditions on  $\alpha$  yield that  $\alpha = \beta^{-1}$ . It follows that  $\alpha_0^{-1} \subseteq \beta$  and they are compatible.

If we suppose  $\beta$  is not invertible, then  $\beta \in \mathcal{C}_0$  and there are three possibilities. If  $G\beta \subseteq G\mu$ , then  $G\beta \cap \alpha_0^{-1} = \emptyset$ . If  $G\beta \cap G\mu = \emptyset$  then  $G\beta \subseteq (\alpha \cup G\mu)^{-1} = \alpha_0^{-1}$  since  $G\beta \subseteq \alpha^{-1}$  also. Finally, because  $m \notin \alpha^{-1}$  and  $G\beta \subseteq \alpha^{-1}$ , the last case  $G\beta \supseteq G\mu$  will not happen.  $\square$

Therefore we can define  $f : S(\mathcal{C}) \rightarrow S(\mathcal{C})$  by sending an ideal forest  $\Phi$  to  $\Phi \cup \{\alpha_0^{-1}\}$  if  $\Phi$  contains  $\alpha^{-1}$  and to itself otherwise. We can also define  $g : f(S(\mathcal{C})) \rightarrow f(S(\mathcal{C}))$  by sending an ideal forest  $\Psi$  to  $\Psi - \{\alpha^{-1}\}$  if  $\Psi$  contains  $\alpha^{-1}$  and to itself otherwise. Then  $g(f(S(\mathcal{C}))) = S(\mathcal{C} - \{\alpha^{-1}\})$  and  $S(\mathcal{C})$  deformation retracts to this by two applications of the Poset Lemma.

We must further contract  $S(\mathcal{C} - \{\alpha^{-1}\})$  to  $S(\mathcal{C} - \{\alpha, \alpha^{-1}\})$ . This is done via the following claim:

**Claim 12.15** *For every  $\beta \in \mathcal{C} - \{\alpha^{-1}\}$ , if  $G\beta$  is compatible with  $\alpha$  then  $G\beta$  is compatible with  $\alpha_0$ .*

**Proof.** As before, we list the standard cases:

- $\beta = \gamma$ . Then  $c^{-1} \notin \alpha$ . As  $c^{-1} \notin G\mu$  also, this means  $c^{-1} \notin \alpha \cup G\mu = \alpha_0$ . So  $\gamma$  is compatible with  $\alpha_0$ . Assume  $\beta \neq \gamma$  from now on.
- $G\beta \subseteq \alpha$ . Then  $G\beta \subseteq \alpha \cup G\mu = \alpha_0$ .
- $\alpha \subseteq G\beta$ . Then  $\beta$  is invertible and  $\alpha \subseteq \beta$ . Note that  $|\alpha \cap G\mu| \leq |\beta \cap G\mu|$ . If  $\beta \notin \mathcal{C}_0$  then the maximality conditions on  $\alpha$  give us that  $\beta = \alpha$ . As  $\alpha \subseteq \alpha \cup G\mu = \alpha_0$ , they are compatible in this situation. Next we examine what happens if  $\beta \in \mathcal{C}_0$ . Neither the case  $\beta \subseteq G\mu$  nor  $\beta \cap G\mu = \emptyset$  can occur as the first contradicts the fact that  $\mu$  is not invertible and the second that  $m \in \beta \cap G\mu$ . Accordingly,  $G\mu \subseteq \beta$  and  $\beta \supseteq \alpha \cup G\mu = \alpha_0$ .
- $\alpha \cap G\beta = \emptyset$ .

If  $\beta$  is invertible, then  $\alpha \subseteq \beta^{-1}$  and we can apply similar methods to those used in the last case. Namely, if  $\beta^{-1} \in \mathcal{C}_0$  then  $G\mu \subseteq \beta^{-1}$  is the only possible case. So  $\beta^{-1} \supseteq \alpha \cup G\mu$  and  $\alpha_0 \cap \beta = \emptyset$ . On the other hand, suppose  $\beta \in \mathcal{C} - \mathcal{C}_0$ . Since  $\alpha \subseteq \beta^{-1}$ , the maximality conditions on  $\alpha$  yield that  $\alpha = \beta^{-1}$ . As  $\beta$  lies in  $\mathcal{C} - \{\alpha^{-1}\}$ , this gives a contradiction. So the last case will not actually occur.

Now assume  $\beta$  is not invertible, so that  $\beta \in \mathcal{C}_0$ . If  $G\beta \subseteq G\mu$ , then  $G\beta \subseteq \alpha \cup G\mu = \alpha_0$ . Alternatively, if  $G\beta \cap G\mu = \emptyset$  then  $G\beta \cap (\alpha \cup G\mu) = \emptyset$

as  $\alpha \cap G\beta = \emptyset$  also. Finally, the case  $G\beta \supseteq G\mu$  does not take place, else  $m \in G\beta \cap \alpha$ .  $\square$

Using this last claim we can define  $f : S(\mathcal{C} - \{\alpha_0^{-1}\}) \rightarrow S(\mathcal{C} - \{\alpha_0^{-1}\})$  by sending an ideal forest  $\Phi$  to  $\Phi \cup \{\alpha_0\}$  if  $\Phi$  contains  $\alpha$  and to itself otherwise. We can also define  $g : f(S(\mathcal{C} - \{\alpha_0^{-1}\})) \rightarrow f(S(\mathcal{C} - \{\alpha_0^{-1}\}))$  by sending an ideal forest  $\Psi$  to  $\Psi - \{\alpha\}$  if  $\Psi$  contains  $\alpha$  and to itself otherwise. Then  $g(f(S(\mathcal{C}))) = S(\mathcal{C} - \{\alpha, \alpha^{-1}\})$  and  $S(\mathcal{C})$  deformation retracts to this by two applications of the Poset Lemma.

This concludes our argument that  $S(\mathcal{C}'_0)$  contracts to  $S(\mathcal{C}_0)$ . The final step of contracting  $S(\mathcal{C}_0)$  to a point is done with poset maps  $f$  and  $g$  as above which first add  $G\mu$  to all ideal forests and then delete from these ideal forests everything except  $G\mu$ .  $\square$

The sequence of lemmas above concludes our proof of Theorem 12.1.

Back in the beginning of this paper, in Definition 4.2, we asserted that the dimension of  $X_p^\omega$  was  $2p - 4$ . We are now in a position to justify this.

**Remark 12.16** *The dimension of  $X_p^\omega$  is  $2p - 4$ .*

**Proof.** Just as asserted in §9 of [19], every maximal simplex in  $X_p^\omega$  has the same dimension. We can obtain a maximal simplex of  $X_p^\omega$  by first taking a  $(2p - 6)$ -dimensional maximal simplex in  $X_{p-2}$  which has no inessential edges under the action of the trivial group 1, say the simplex

$$\eta : R_{p-2} \rightarrow \Gamma_{p-2}^0 \rightarrow \Gamma_{p-2}^1 \rightarrow \cdots \rightarrow \Gamma_{p-2}^{2p-6},$$

and then modifying the simplex as follows. Choose some edge  $e$  of  $\Gamma_{p-2}^0$  which survives (uncollapsed) to the graph  $\Gamma_{p-2}^{2p-6}$ . and pick two points  $x_1 \neq x_2$  in the

interior of that edge. Now attach two other edges  $f_1$  and  $f_2$  to the graph  $\Gamma_{p-2}^0$  by letting them both start at  $x_1$  and both end at  $x_2$ . Call the resulting graph  $\Gamma_p^0$  and define an  $\omega$ -action on it by having  $\omega$  switch the edges  $f_1$  and  $f_2$  and leave all other edges fixed. By adding the vertices  $x_1$  and  $x_2$  to the edge  $e$ , we divided  $e$  into three smaller edges, which we will call  $e_1$ ,  $e_2$ , and  $e_3$ .

In a similar manner, for all  $i \in \{1, \dots, 2p-6\}$ , define an  $\omega$ -graph  $\Gamma_p^i$  by attaching edges  $f_1$  and  $f_2$  to  $\Gamma_{p-2}^i$ .

Define  $\Gamma_p^{2p-5}$  to be the result of collapsing the edge  $e_1$  in  $\Gamma_p^{2p-6}$  and define  $\Gamma_p^{2p-4}$  to be the result of collapsing the edge  $e_2$  in  $\Gamma_p^{2p-5}$ .

Then it is easy to see that the chain of forest collapses

$$\Gamma_p^0 \rightarrow \Gamma_p^1 \rightarrow \dots \rightarrow \Gamma_p^{2p-4}$$

gives us that the dimension of a maximal simplex in  $X_p^\omega$  is  $2p-4$ . This is because the only places that the graph  $\Gamma_p^0$  can be blown up are at the vertices  $x_1$  or  $x_2$ , and any such blowup would result in an inessential edge.  $\square$

## Part IV

# Cohomology of moduli spaces of graphs

# Chapter 13

## Symmetry groups of graphs

We now examine the cohomology of the quotient  $Q_n$  of the spine  $X_n$  of outer space. There are natural inclusions  $Q_m \hookrightarrow Q_{m+1}$ , and it is known [15] that the induced map  $H^i(Q_{m+1}; \mathbb{Q}) \rightarrow H^i(Q_m; \mathbb{Q})$  is an isomorphism for  $m > 3i/2$ . Our goal is to show that, in contrast,  $H^5(Q_m; \mathbb{Z})$  never stabilizes as  $m \rightarrow \infty$ . This is done by showing that as  $m$  increases, torsion from increasingly higher primes is introduced in  $H^5(Q_m; \mathbb{Z})$ . To this end, we do specific calculations in the spectral sequence 1.1 applied to the action of  $\text{Aut}(F_n)$  on  $X_n$  for  $n = 2p - 1$ . The  $E_2^{r,0}$ -term of this spectral sequence is  $H^r(Q_n; \mathbb{Z}_{(p)})$ , and the sequence converges to  $H^r(\text{Aut}(F_n); \mathbb{Z}_{(p)})$ . Results from Hatcher and Vogtmann [15] on the cohomology of  $\text{Aut}(F_n)$  are then used to obtain the result.

In this chapter, we do the ground work necessary to compute the  $E_1$ -page of the spectral sequence: we find all simplices of  $X_n$  with  $p$ -symmetry and compute the cohomology of the stabilizers of these simplices with coefficients in  $\mathbb{Z}_{(p)}$ . In Chapter



14 we will compute the  $E_2$ -page of the spectral sequence, and use this calculation to obtain the result.

Unless otherwise stated,  $p \geq 5$  will be prime and  $n = 2p - 1$ . The assumption that  $p \geq 5$  is for convenience more than any other reason, as the main results will only consider arbitrarily large primes  $p$  and so we should not devote extra time to the (fairly easy to resolve) complications introduced by considering the prime  $p = 3$ . These complications arise from the fact that the dihedral group  $D_6$  is the same as the symmetric group  $S_3$ , so that we cannot distinguish between dihedral and symmetric symmetry in that case.

We now define some graphs that we will need for this chapter. (Refer to Figure 13.1 for illustrations of most of these graphs.) Let  $\Theta_{p-1}$  and  $R_p$  be as before. That is,  $R_p$  is a rose and  $\Theta_{p-1}$  is the graph with two vertices and  $p$  edges, each of which goes from one vertex to the other. Let  $\Xi_p$  be the 1-skeleton of the cone over a  $p$ -gon, so that  $\Xi_p$  has  $p + 1$  vertices and  $2p$  edges, one vertex has valence  $p$  and the other  $p$  vertices all have valence 3. Let  $\Upsilon_{2p-1}$  be the 1-skeleton of the suspension of a  $p$ -gon. Hence  $\Upsilon_{2p-1}$  has  $p + 2$  vertices and  $3p$  edges; two of the vertices have valence  $p$  and the other  $p$  have valence 4. Let  $\Upsilon_{2p-1}^1$  and  $\Upsilon_{2p-1}^2$  be the two possible graphs that can be obtained from  $\Upsilon_{2p-1}$  by equivariantly blowing up (see Definition 4.5) the  $p$  valence 4 vertices into  $2p$  valence 3 vertices. That is,  $\Upsilon_{2p-1}^1$  can be obtained by first taking a  $p$ -gon and then attaching  $p$  free edges to the  $p$  vertices of the  $p$ -gon. Say each of these new edges  $e_i$  begins at the vertex  $x_i$  and ends at the vertex  $y_i$ , and suppose that the vertices  $x_i$  are the ones that are attached to the  $p$ -gon. Now form the 1-skeleton of the double cone or suspension over the  $p$  vertices  $y_i$ . This gives the

graph  $\Upsilon_{2p-1}^1$ . The graph  $\Upsilon_{2p-1}^2$  can be thought of as follows: First take a  $p$ -gon and cone off over the  $p$  vertices of the  $p$ -gon. Now also cone off over the  $p$  midpoints of the  $p$  edges of the  $p$ -gon. Note that there is an obvious  $\mathbb{Z}_p$ -action on each of  $\Theta_{p-1}$ ,  $\Xi_p$ ,  $\Upsilon_{2p-1}$ ,  $\Upsilon_{2p-1}^1$ , and  $\Upsilon_{2p-1}^2$ .

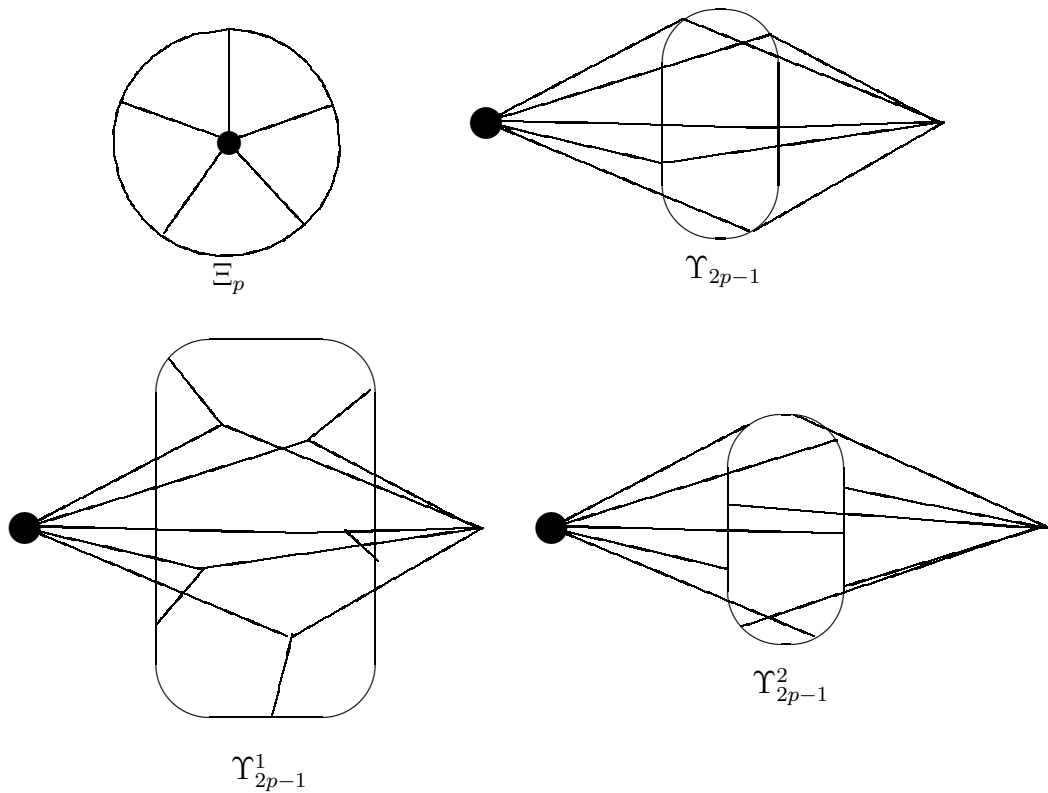

Figure 13.1: Some graphs with  $D_{2p}$ -symmetry

Choose basepoints for the graphs  $\Theta_{p-1}$ ,  $\Upsilon_{2p-1}$ ,  $\Upsilon_{2p-1}^1$ , and  $\Upsilon_{2p-1}^2$  as illustrated in Figure 13.1: Let the vertex on the “leftmost” side of  $\Theta_{p-1}$  be the basepoint. Additionally, orient  $\Upsilon_{2p-1}$ ,  $\Upsilon_{2p-1}^1$ , and  $\Upsilon_{2p-1}^2$  so that one of their valence  $p$  vertices is on the “left” and the other is on the “right” and choose the leftmost vertex to be the basepoint. Writing  $R_p \vee \Theta_{p-1}$  will mean that the two graphs are wedged

together at the basepoint of  $\Theta_{p-1}$ , while writing  $\Theta_{p-1} \vee R_p$  will mean that the non-basepointed vertex of  $\Theta_{p-1}$  is wedged to the vertex of  $R_p$ . Let  $\Upsilon_{2p-1}^{2a}$  be the graph obtained from  $\Upsilon_{2p-1}^2$  by collapsing the leftmost  $p$  edges and let  $\Upsilon_{2p-1}^{2b}$  be the one obtained by collapsing the rightmost  $p$  edges. Refer to Figure 13.2 for pictures of these graphs. Figure 13.2 also depicts two graphs  $\Lambda_{2p-1}^1$  and  $\Lambda_{2p-1}^2$  which will be used in the proof of Lemma 13.1.

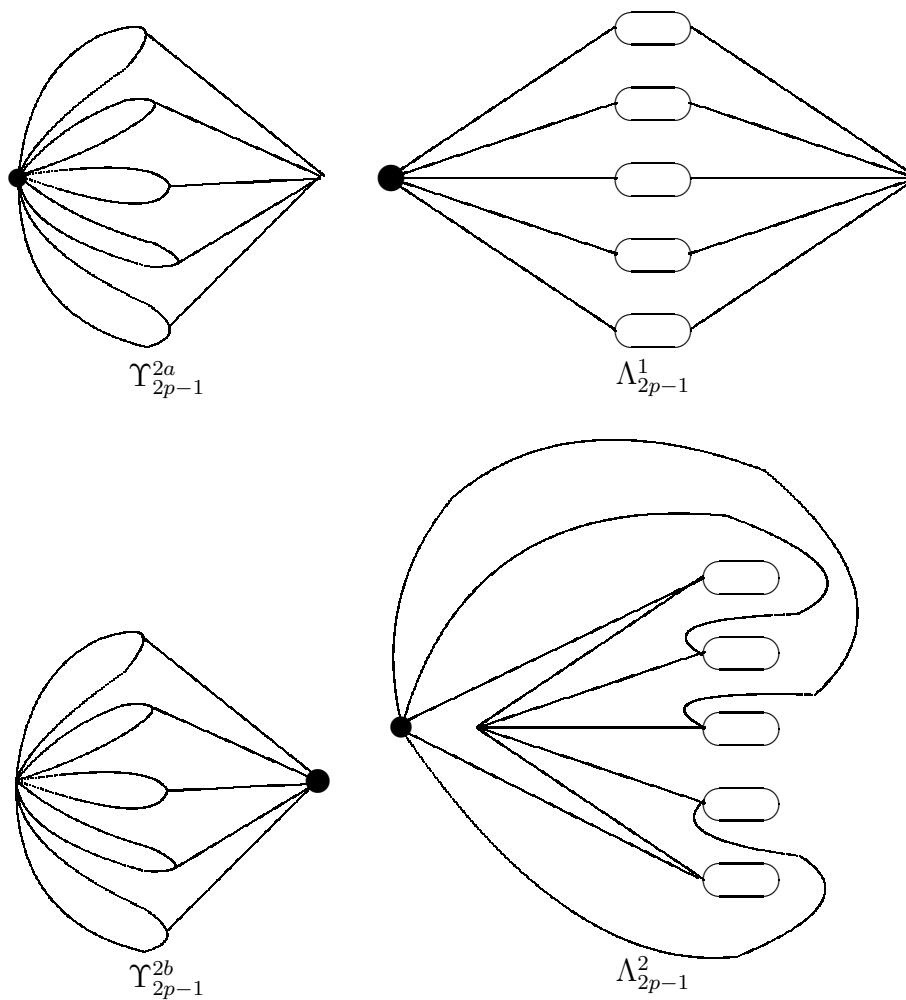

Figure 13.2: Some graphs with (cohomologically)  $\Sigma_p$ -symmetry

For the next lemma (Lemma 13.1) only, we will consider the above graphs not to have basepoints specified. The basepoint is just assumed to be located at some spot which is invariant under the  $\mathbb{Z}/p$  action. (This assumption is for convenience rather than anything else, so that we will not need to introduce several separate subcases, each corresponding to a different location for the basepoint.)

We will be looking at the standard equivariant spectral sequence 1.1 applied to calculating the cohomology groups  $H^*(\text{Aut}(F_n); \mathbb{Z}_{(p)})$ . In particular, we will be looking at the  $E_1$  page of this spectral sequence only in rows 0 through  $2p - 3$ , and often just in rows 1 through  $2p - 3$ . One interesting fact about these rows is that they allow us to distinguish between simplices that have stabilizers whose cohomology is  $\mathbb{Z}/p$ ,  $D_{2p}$ , or  $\Sigma_p$ . It is well known that

$$\begin{aligned} H^*(\mathbb{Z}/p; \mathbb{Z}_{(p)}) &= \mathbb{Z}_{(p)}[x_2]/(px_2), \\ H^*(D_{2p}; \mathbb{Z}_{(p)}) &= \mathbb{Z}_{(p)}[x_4]/(px_4), \\ \text{and } H^*(\Sigma_p; \mathbb{Z}_{(p)}) &= \mathbb{Z}_{(p)}[x_{2(p-1)}]/(px_{2(p-1)}), \end{aligned}$$

where  $x_2$ ,  $x_4$  and  $x_{2(p-1)}$  are generators of dimensions 2, 4 and  $2(p-1)$ , respectively. Hence if a simplex of  $X_n$  has stabilizer isomorphic to  $\mathbb{Z}/p$  or  $D_{2p}$  then it will contribute something to the  $E_1$  page of the spectral sequence in some of the rows 1 through  $2p - 3$ . On the other hand, if its stabilizer is isomorphic to  $\Sigma_p$ , then it will not contribute anything to the  $E_1$  page of the spectral sequence in the given rows.

Define an  $r$ -simplex in the  $p$ -singular locus of  $X_n$  to have *exactly  $\mathbb{Z}/p$  symmetry* if it contributes exactly one copy of  $\mathbb{Z}/p$  to each of the entries  $E_1^{r, 2k}$ ,  $0 < 2k < 2(p-1)$ , in the  $E_1$  page of the spectral sequence. Define an  $r$ -simplex in the  $p$ -singular locus of  $X_n$  to have *at most dihedral symmetry* if it contributes exactly one copy of  $\mathbb{Z}/p$  to each of the entries  $E_1^{r, 4k}$ ,  $0 < 4k < 2(p-1)$ , in the  $E_1$  page of the spectral sequence.

The next lemma examines which vertices in  $X_n$  contribute to the spectral sequence in the given rows. The proof of the lemma actually explicitly enumerates which graphs have  $p$ -symmetry, which will be very useful to us later.

**Lemma 13.1** *Let  $p \geq 5$  be prime and set  $n = 2p - 1$ . Let the marked graph  $(\xi, G, x_0)$*

be a vertex in the  $p$ -singular locus of  $X_n$ . Then the cohomology  $H^*(Aut(G, x_0); \mathbb{Z}_{(p)})$  of the stabilizer of this vertex is the same as the cohomology with  $\mathbb{Z}_{(p)}$  coefficients of one of  $D_{2p}$ ,  $D_{2p} \times \Sigma_p$ ,  $\Sigma_p$ ,  $\Sigma_p \times \Sigma_p$ ,  $(\Sigma_p \times \Sigma_p) \rtimes \mathbb{Z}/2$  or  $\Sigma_{2p}$ .

**Proof.** The interested reader should refer to chapter 6 of Adem and Milgram [1] for information about the cohomology of the symmetric groups in general. There they calculate, for example,  $H^*(\Sigma_{2p}; \mathbb{Z}/p)$  and more generally  $H^*(\Sigma_m; \mathbb{Z}/p)$ . We will not go into this here, as we are not so much interested in the structure of  $H^t(\Sigma_{2p}; \mathbb{Z}_{(p)})$  as we are interested in the fact that it is 0 for  $1 \leq t \leq 2p - 3$ .

From [3] and [21], we see that  $p^2$  is an upper bound for the order of any  $p$ -subgroup of  $Aut(F_n)$ . Thus  $p^2$  is an upper bound for the order of a maximal  $p$ -subgroup  $P$  of  $Aut(G, x_0)$ . Since all possible choices for  $P$  are abelian (i.e., there are only three possibilities:  $\mathbb{Z}/p$ ,  $\mathbb{Z}/p^2$ , and  $\mathbb{Z}/p \times \mathbb{Z}/p$ ), we can apply Swan's theorem 5.5 to see that

$$(13.2) \quad H^*(Aut(G, x_0); \mathbb{Z}_{(p)}) = H^*(P; \mathbb{Z}_{(p)})^{N_{Aut(G, x_0)}(P)}.$$

We now look at each of the individual cases  $P = \mathbb{Z}/p$ ,  $\mathbb{Z}/p^2$ , and  $\mathbb{Z}/p \times \mathbb{Z}/p$ .

1. We will first examine the case where  $P = \mathbb{Z}/p^2$ . In this case, we have that  $p^2$  edges  $e_1, \dots, e_{p^2}$  in  $G$  are rotated around by  $P$ . An examination of all possible ways that these edges could be connected together, keeping in mind that  $G$  is admissible, reveals that this case is impossible. For example, the first subcase is that all of the  $e_i$  begin and end at the same vertex. This is not possible because the fundamental group of  $R_{p^2}$  is too large for it to be a subgraph of

$G$ . For the next subcase, suppose each edge goes from some vertex  $y_1$  to some other vertex  $y_2$ . Then they form a  $\Theta_{p^2-1}$  inside  $G$ , which is also impossible. In the next subcase, the edges begin at one common vertex  $y_0$  and end at  $p^2$  distinct vertices  $y_1, \dots, y_{p^2}$ . Since the graph  $G$  is admissible, it has no free edges and every nonbasepointed vertex has valence at least 3. So all of the vertices  $y_1, \dots, y_{p^2}$  have to connect up in some manner, and in doing so they will violate the fact that  $\pi_1(G) = F_{2p-1}$ . The final three subcases, in which the  $e_i$  either form a  $p^2$ -gon, have no common vertices, or form loops with  $p^2$  distinct endpoints, are similar. Hence  $P$  will never be  $\mathbb{Z}/p^2$  and this case will not occur.

2. Next we will examine the case where  $P = \mathbb{Z}/p \times \mathbb{Z}/p = (\alpha) \times (\beta)$ . The first cyclic summand  $(\alpha)$  must rotate  $p$  edges  $e_1, \dots, e_p$  of  $G$ . Without loss of generality, we may assume that  $(\beta)$  fixes these edges (by setting the new  $\beta$  to be  $\beta - \alpha^j$  for some  $j$ .) Now  $(\beta)$  must rotate  $p$  other edges  $f_1, \dots, f_p$  of  $G$ . (Note that we cannot have each  $e_i$  forming a loop with endpoints  $y_i$ , where  $y_1, \dots, y_p$  are all distinct. This is because we could then choose  $p$   $\alpha$ -equivariant paths from each of these points to the basepoint. This would give us at least  $p$  different separating edges in the graph, and hence this cannot occur. The same argument also holds for the  $f_i$  instead of the  $e_i$ .) By doing the sort of case-by-case analysis that we did in the previous paragraph, we see that  $G$  must be one of the following graphs (listed in increasing order with respect to the number of vertices):

- $R_p \vee \Theta_{p-1}$ , whose automorphism group has the same cohomology as  $\Sigma_p \times \Sigma_p$ .
  - $\Theta_{2p-1}$ , whose automorphism group is  $\Sigma_{2p}$ .
  - $\Theta_{p-1} \vee \Theta_{p-1}$ , plus one additional edge  $e$  attached in some manner to the existing vertices. The automorphism group here will have the same cohomology as either  $\Sigma_p \times \Sigma_p$  or  $(\Sigma_p \times \Sigma_p) \rtimes \mathbb{Z}/2$ .
  - $\Theta_{p-1} \amalg \Theta_{p-1}$ , with one additional edge  $e_1$  attached going from an already existing vertex of one of the  $\Theta$ -graphs to one on the other  $\Theta$ -graph, after which we sequentially attach another edge  $e_2$  to that resulting graph. The endpoints of  $e_2$  can be attached to any of the already existing vertices, or they can be attached anywhere in the interior of  $e_1$ . The automorphism group here will have the same cohomology as either  $\Sigma_p \times \Sigma_p$  or  $(\Sigma_p \times \Sigma_p) \rtimes \mathbb{Z}/2$ .
  - $\Theta_{p-1} \vee \Xi_p$ , with automorphism group  $\Sigma_p \times D_{2p}$ .
3. For the final case,  $P = \mathbb{Z}/p = \langle \alpha \rangle$ . The idea behind our proof of part 3. is that we want to show that all of the  $p$ -symmetries in the graph  $G$  are also at least  $D_{2p}$ -symmetries. That is, in addition to the rotation by  $\mathbb{Z}/p$ , there is also a dihedral “flip”. We will be able to get this result because  $n = 2p - 1$  is not “large enough” with respect to  $p$  for us to be able to generate graphs  $G$  with  $\pi_1(G) = F_n$  that have  $\mathbb{Z}/p$ -symmetries but not  $D_{2p}$ -symmetries.

We have  $P = \mathbb{Z}/p$  acting on a graph whose fundamental group has rank  $n = 2p - 1$ . As before, there exist at least  $p$  edges  $e_1, \dots, e_p$  that  $P$  rotates. If



these edges form a  $\Theta_{p-1}$  or an  $R_p$ , we are done. This is because now  $P$  cannot move any other edges of  $G$ , else we are in the case of the previous paragraph where  $P = \mathbb{Z}/p \times \mathbb{Z}/p$ . As the automorphism groups of both  $\Theta_{p-1}$  and  $R_p$  contain the symmetric group  $\Sigma_p$ , we are done in this subcase.

Now suppose we are in the other extreme subcase, the one where  $e_1, \dots, e_p$  have no endpoints in common. Choose a minimal path  $\gamma_1$  from  $e_1$  to the basepoint. Since  $P = \langle \alpha \rangle$  fixes the basepoint, we have that  $\gamma_i := \alpha^{i-1}\gamma_1$  is a minimal path from  $e_i$  to  $x_0$  for all  $i = 1, \dots, p$ . Since none of the endpoints of the  $e_i$  can be the basepoint, there are at least  $p$  distinct edges  $f_1, \dots, f_p$  in  $\gamma_1, \dots, \gamma_p$ , respectively. We can also assume that each  $f_i$  has at least one endpoint that is not the basepoint. Because  $G$  has no free edges, no separating edges, and all non-basepointed vertices have valence at least three, another case-by-case analysis reveals that since  $\pi_1(G)$  must have rank less than  $2p$ , the graph is forced to be either  $\Upsilon_{2p-1}^1$ ,  $\Upsilon_{2p-1}^2$ , or  $\Lambda_{2p-1}^1$ . The first two of these graphs have dihedral symmetry, while the last has automorphism group with the same cohomology as  $\Sigma_p$ .

The next case is the one in which the  $e_i$  are all loops with  $p$  distinct endpoints  $y_i$ . As in the previous case, we can choose a  $\mathbb{Z}/p$  equivariant path from each  $y_i$  to the basepoint. The admissibility conditions on the graph only allow one possibility, namely the graph  $\Lambda_{2p-1}^2$ . As this graph has automorphism group with the same cohomology as  $\Sigma_p$ , we are finished with this case.

Next consider the case where the  $e_i$  form a  $p$ -gon. Since the vertices of  $G$  have

valence at least 3, there must be  $p$  other edges  $f_1, \dots, f_p$  in  $G$  that each start at one of the  $p$  vertices of the  $p$ -gon. Since  $G$  is admissible and the rank of  $\pi_1(G)$  is  $2p - 1$ , these additional edges cannot also join up to form a  $p$ -gon. (Why? Both  $p$ -gons still need to connect up to the basepoint in some way, and in connecting up to  $x_0$  the rank of the fundamental group of  $G$  will be forced too high.) In addition, the edges must have some vertices in common, else we reduce to the previous case; therefore, the  $f_i$  are all forced to end at some common vertex  $y_0$ . In other words, we have a  $\Xi_p$  embedded in  $G$ . If  $P$  doesn't move any other edges in  $G$ , we are done since  $\Xi_p$  has dihedral symmetry. If some other edges  $g_1, \dots, g_p$  are moved, they must also be attached to the  $p$ -gon that the  $e_i$  form, or we will have two independent  $\mathbb{Z}/p$ -actions and be in the case  $P = \mathbb{Z}/p \times \mathbb{Z}/p$ . None of the following cases can happen, else  $\text{rank}(\pi_1(G)) \geq 2p$ :

- The other endpoints of the  $g_i$  all connect to  $y_0$ .
- The other endpoints of the  $g_i$  also connect to the  $p$ -gon formed by the  $e_i$ .
- The other endpoints of the  $g_i$  form  $p$  other distinct vertices.

Hence these other endpoints all have to connect to some other common vertex  $y_1$ , forming another copy of  $\Xi_p$  in  $G$ . Thus  $G$  must be the graph  $\Upsilon_{2p-1}$ , which certainly has dihedral symmetry.

For the final case, the edges  $e_i$  have one common vertex  $y_0$ , and end in  $p$  other distinct vertices  $y_1, \dots, y_p$ . In addition, i) there are no  $p$ -gons in  $G$ , ii) there are no collections of  $p$  edges in  $G$  that are rotated by  $P$  and that have no common

vertices, and iii) there are no collections of  $p$  edges in  $G$  that are rotated by  $P$  and that each form loops with distinct endpoints. Since all of  $y_1, \dots, y_p$  have valence three,  $P$  must rotate two other collections of edges  $\{f_1, \dots, f_p\}$  and  $\{g_1, \dots, g_p\}$  that begin at the vertices  $y_1, \dots, y_p$  and end at the vertices  $z_1$  and  $z_2$ , respectively. Note that since  $\pi_1(G) = F_{2p-1}$ ,  $|\{y_0, z_1, z_2\}| \geq 2$ . Also note that  $P$  cannot move any other edges of  $G$  except the ones we have listed. In this case, the symmetric group  $\Sigma_p$  acts on the collections of edges defined above, and so the cohomology of the group of graph automorphisms of the graph is the same as that of the symmetric group. If  $|\{y_0, z_1, z_2\}| = 2$  then the only edges in the graph are the  $e_i$ ,  $f_i$ , and  $g_i$  and the graph is either  $\Upsilon_{2p-1}^{2a}$  or  $\Upsilon_{2p-1}^{2b}$ . On the other hand, if  $|\{y_0, z_1, z_2\}| = 3$ , then the graph has one additional edge besides the  $e_i$ ,  $f_i$ , or  $g_i$ . Accordingly, the graph looks like a  $\Phi_{2p-1}$  (See Figure 1.1) with one additional edge added. This additional edge can go from any of the  $\{y_0, z_1, z_2\}$  to any other one, including possibly the same one. In any case, it is definitely true that the graph has automorphism group with the same cohomology as  $\Sigma_p$ . The lemma follows.  $\square$

For an example of what we were trying to avoid in the proof of the above lemma, refer to the three examples given in the Figure 13.3 below.

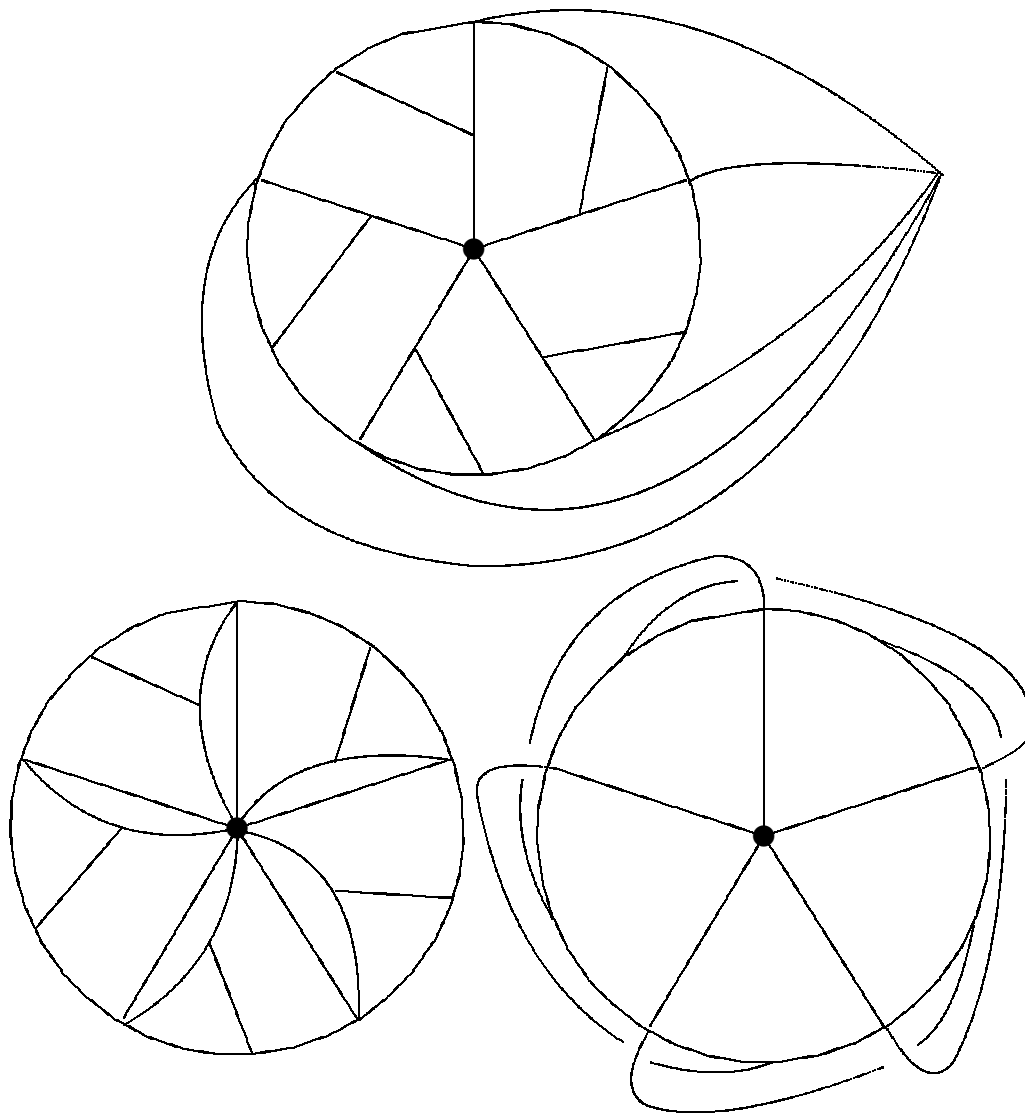

Figure 13.3: Graphs whose symmetry groups are exactly  $\mathbb{Z}/p$

The graphs pictured above have an obvious  $\mathbb{Z}/p$ -symmetry given by rotation about the basepoint, which is indicated by a solid dot. But they have no dihedral flip, and their basepoint-preserving automorphism groups are all exactly  $\mathbb{Z}/p$ , where  $p = 5$  in the examples pictured and where obvious analogues exist for other odd

primes. The ranks of the fundamental groups of the graphs pictured are  $3p - 1$ ,  $3p$ , and  $2p$ , respectively. The last rank,  $2p$ , is the lowest rank possible where one can have a graph with exactly  $\mathbb{Z}/p$  symmetry. (Note that one can always construct graphs with exactly  $\mathbb{Z}/p$  symmetry, but higher rank fundamental groups, from any of the above graphs, by adding concentrically embedded circles around the basepoint of the graph, where the circles are attached to the “spokes” radiating away from the basepoint.)

**Corollary 13.3** *A vertex in the  $p$ -singular locus of  $X_n$  has at most dihedral symmetry if its cohomology is the same as that of  $D_{2p}$  or  $D_{2p} \times \Sigma_p$ , and vertices in the  $p$ -singular locus will never have exactly  $\mathbb{Z}/p$  symmetry.*

By analyzing the  $\mathbb{Z}/p$ -invariant subforests of all of the graphs explicitly listed in the proof of Lemma 13.1, we can see what types of stabilizers higher dimensional simplices (rather than just vertices) have.

We will show that the simplices with at most dihedral symmetry will fall into two (exhaustive but not disjoint) categories. The first category consists of those that are listed in Figure 13.4 below. The second category consists of simplices whose maximal vertex (recall that  $X_n$  is the realization of a poset) has the form  $\Xi_p \vee \Gamma_{p-1}$  where  $\Gamma_{p-1}$  is some basepointed graph with fundamental group of rank  $p - 1$ , the wedge does not necessarily take place at the basepoint, and where the forest collapses of the simplex respect the  $\mathbb{Z}/p$  action on  $\Xi_p$ .

We will also show that the simplices listed in Figure 13.5 are the only ones with exactly  $\mathbb{Z}/p$  symmetry.

In the figures below, a dotted line or a hollow dot indicates that the given edge or vertex, respectively, does not have the indicated property. A solid dot, a solid line, or a 2-simplex with an X in it, means that the given vertex, edge, or 2-simplex, respectively, does have the indicated property.

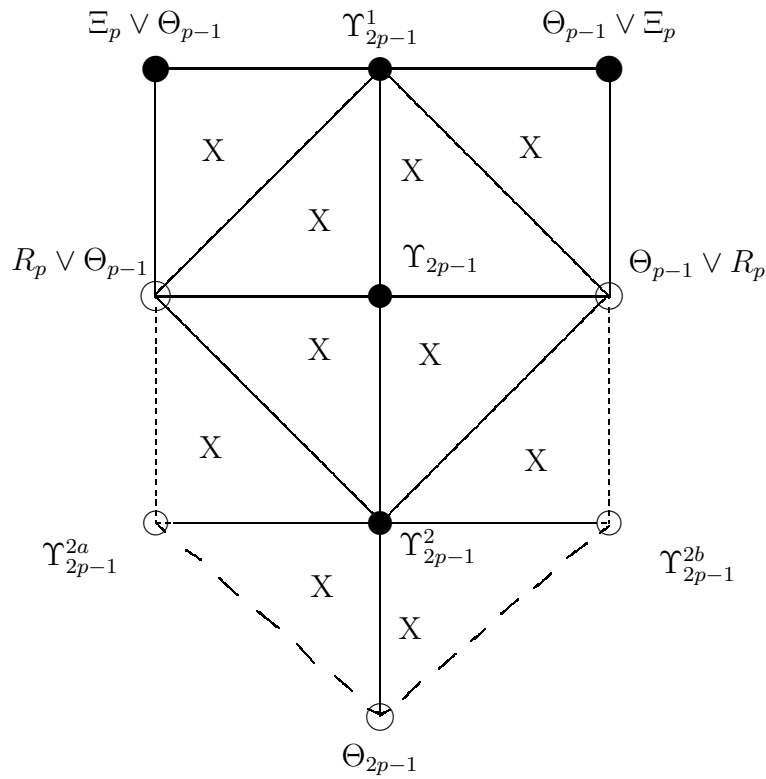

Figure 13.4: Some simplices with at most dihedral symmetry

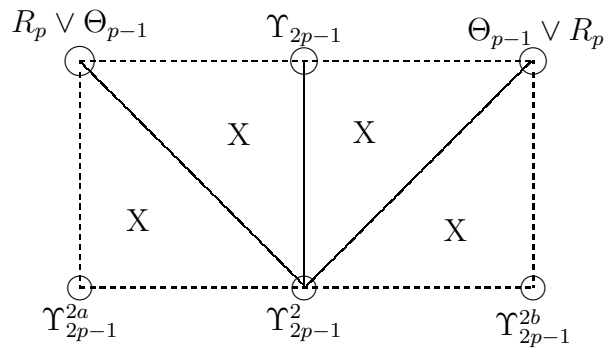

Figure 13.5: Simplices with exactly  $\mathbb{Z}/p$  symmetry

**Corollary 13.4** *Let  $p \geq 5$  be prime,  $n = 2p - 1$ , and consider the  $p$ -singular locus of the spine  $X_n$  of outer space.*

- *The only simplices with at most dihedral symmetry are either: (i) listed in Figure 13.4; or (ii) have maximal vertex of the form  $\Xi_p \vee \Gamma_{p-1}$ .*
- *The only simplices with exactly  $\mathbb{Z}/p$  symmetry are those listed in Figure 13.5.*

**Proof.** We examine each of the graphs listed in Lemma 13.1 separately. By enumerating the  $\mathbb{Z}/p$  invariant subforests of each of these graphs, one can list all of the simplices in the  $p$ -singular locus of  $X_n$ . We can ignore the graphs in Lemma 13.1 that do not have dihedral symmetry, as all of their symmetry comes from symmetric groups. When you collapse invariant subforests of these graphs, you still get graphs with symmetry coming from the symmetric group.

So we are left with analyzing the graphs from Lemma 13.1 with dihedral symmetry, which were:

- $\Theta_{p-1} \vee \Xi_p$ . (There are actually two possibilities here as the enumeration in Lemma 13.1 did not specify basepoints. The central vertex of  $\Xi_p$  could be attached to either the basepoint of  $\Theta_{p-1}$  or the other vertex of  $\Theta_{p-1}$ .)
- $\Gamma_{p-1} \vee \Xi_p$ , where  $\Gamma_{p-1}$  is a basepointed graph with fundamental group of rank  $p-1$  which has no  $p$ -symmetry (or where  $\Gamma_{p-1}$  is  $\Theta_{p-1}$  but the central vertex of  $\Xi_p$  is attached to the midpoint of an edge of  $\Gamma_{p-1}$ .)
- $\Upsilon_{2p-1}$ .
- $\Upsilon_{2p-1}^1$ .
- $\Upsilon_{2p-1}^2$ .



For the first two types of graphs, you can obtain simplices with dihedral symmetry by collapsing all of the spokes of  $\Xi_p$  and/or any forest in the other graph of the wedge sum (either  $\Theta_{p-1}$  or  $\Gamma_{p-1}$ .) The resulting simplex with maximal vertex  $\Theta_{p-1} \vee \Xi_p$  or  $\Gamma_{p-1} \vee \Xi_p$  will clearly have at most dihedral symmetry, and will also just as clearly not give you a graph with exactly  $\mathbb{Z}/p$  symmetry.

In a similar manner, simplices in the  $p$ -singular locus of  $X_n$  with maximal vertex  $\Upsilon_{2p-1}$  or  $\Upsilon_{2p-1}^1$  are (exhaustively) listed in Figure 13.4. Note that  $\Upsilon_{2p-1}$  can only be blown up (while still preserving the  $\mathbb{Z}/p$  action so that we stay in the  $p$ -singular locus of  $X_n$ ) in two ways, to either  $\Upsilon_{2p-1}^1$  or  $\Upsilon_{2p-1}^2$ . The latter two graphs cannot be blown up at all.

Finally, the simplices with maximal vertex  $\Upsilon_{2p-1}^2$  are listed in Figure 13.4 or Figure 13.5. Note that we can obtain edges and 2-simplices with exactly  $\mathbb{Z}/p$  symmetry, even though no actual vertex of  $X_n$  has exactly  $\mathbb{Z}/p$  symmetry. This is because you can choose subforests of  $\Upsilon_{2p-1}^2$  that do respect the dihedral “flip” of  $\Upsilon_{2p-1}^2$ . In other words, this flip will not take the subforest to itself again. Hence the resulting simplex will just have symmetry group  $\mathbb{Z}/p$ . Last of all, note that you can also choose subforests of  $\Upsilon_{2p-1}^2$  which do respect the dihedral flip, and these give simplices with dihedral symmetry.  $\square$

# Chapter 14

## The integral cohomology of the quotient never stabilizes

The main result of this chapter will be to show that for each  $k \in \mathbb{Z}^+$ , either

$$H^{4k}(\text{Aut}(F_\infty); \mathbb{Q}) \neq 0$$

or

$$H^{4k+1}(\text{Aut}(F_m); \mathbb{Z}) \text{ never stabilizes as } m \rightarrow \infty.$$

In particular, since  $H^4(\text{Aut}(F_\infty); \mathbb{Q}) = 0$  by [16], this will prove that  $H^5(\text{Aut}(F_m); \mathbb{Z})$  never stabilizes. As in Chapter 13, all primes  $p$  considered are assumed to be greater than or equal to 5.

**Lemma 14.1** *For the rows  $0 \leq s < 2(p-1)$ , the  $E_2$  page of the spectral sequence 1.1 applied to calculate  $H^*(\text{Aut}(F_{2p-1}); \mathbb{Z}_{(p)})$  is given by*

$$E_2^{r,s} = \begin{cases} H^r(Q_{2p-1}; \mathbb{Z}_{(p)}) & s = 0 \\ \mathbb{Z}/p & r = 2 \text{ and } s = 4k - 2 > 0, k \in \mathbb{Z}^+ \\ 0 & \text{otherwise} \end{cases}$$

**Proof.** As  $E_1^{r,0}$  is the cochain complex  $C^r(Q_{2p-1}; \mathbb{Z}_{(p)})$ , it follows that  $E_2^{r,0} = H^r(Q_{2p-1}; \mathbb{Z}_{(p)})$  as claimed above.

None of the simplices in  $X_{2p-1}$  contribute anything to the odd rows between 0 and  $2(p-1)$  of the above spectral sequence, from Corollary 13.4. Also from Corollary 13.4, the ones that contribute to rows of the form  $4k-2$ ,  $k \in \mathbb{Z}^+$ , are all listed in Figure 13.5. Let  $A$  be the subcomplex of  $Q_n$  generated by all of the simplices pictured in Figure 13.5 and let  $B$  be the subcomplex generated by just the simplices corresponding to dotted lines or hollow dots in Figure 13.5. Then the row  $s = 4k - 2$  on the  $E_1$  page of the spectral sequence is  $C^r(A, B; \mathbb{Z}/p)$ . Examining Figure 13.5 we see that

$$H^r(A, B; \mathbb{Z}/p) = \begin{cases} \mathbb{Z}/p & r = 2 \\ 0 & \text{otherwise} \end{cases}$$

Consequently the  $E_2$  page is as claimed for the rows  $s = 4k - 2$ .

Our final task is to calculate the  $E_2$  page for the rows  $s = 4k$ . Simplices in the  $p$ -singular locus of the spine with “at most dihedral symmetry” contribute to these rows. From Corollary 13.4, we have a characterization of such simplices. Define the subcomplex  $M$  of the  $p$ -singular locus of the spine  $X_{2p-1}$  of outer space to be the subcomplex generated by simplices with “at most dihedral symmetry”. More precisely, from Corollary 13.4, we know it is generated by the simplices corresponding to those in Figure 13.4 (i.e., corresponding in the sense that we are taking  $M$  to be a subcomplex of the spine rather than its quotient and Figure 13.4 is a picture in

the quotient) in addition to simplices whose maximal vertex has underlying graph of the form  $\Xi_p \vee \Gamma_{p-1}$  (where the forest collapses in the simplices respect the  $\mathbb{Z}/p$  action on  $\Xi_p$ .) Recall that an  $r$ -simplex with at most dihedral symmetry contributes exactly one  $\mathbb{Z}/p$  to  $E_1^{r,4k}$ , while all other simplices (those without dihedral or exactly  $\mathbb{Z}/p$  symmetry) contribute nothing to this row.

Let  $N$  be the full subcomplex of  $M$  generated by simplices in  $M$  which do not have at most dihedral symmetry. Observe that none of the simplices in  $N$  have at most dihedral symmetry. Also note that the row  $E_1^{*,4k}$  is the relative cochain complex

$$C^*(M/Aut(F_{2p-1}), N/Aut(F_{2p-1}); \mathbb{Z}/p).$$

Let  $M'$  be the subcomplex of  $M$  generated by  $N$  and by simplices whose maximal vertex is  $\Upsilon_{2p-1}^2$ . Hence  $M'$  is the subcomplex consisting of  $N$  and the bottom two thirds of Figure 13.4. There is an  $Aut(F_{2p-1})$ -equivariant deformation retraction of  $M$  onto  $M'$ , given on the vertices of the poset by:

- Contracting the spokes of the graph  $\Xi_p$  in  $\Theta_{p-1} \vee \Xi_p$ .
- Contracting the spokes of the graph  $\Xi_p$  in  $\Gamma_{p-1} \vee \Xi_p$ , where  $\Gamma_{p-1}$  has no  $p$ -symmetry.
- Contracting the  $p$  outward radiating edges attached to the  $p$ -gon in the center of the graph  $\Upsilon_{2p-1}^1$ . In the terminology used at the beginning of Chapter 13 while defining  $\Upsilon_{2p-1}^1$ , we are contracting the edges  $e_i$ .

That it is a deformation retraction follows from the Poset Lemma in [19] attributed to Quillen.

In other words, the deformation retraction of  $M$  to  $M'$  comes from collapsing the “inessential edges of the  $D_{2p}$ -action” (see part III and [19].) Two words of caution are in order here with respect to this use of the word “inessential”. First, note that we are not collapsing all of the inessential edges with respect to some  $D_{2p}$  action, just those edges that are associated with some  $p$ -gon giving dihedral symmetry. Hence, for example, we are not collapsing any of the  $2p$  inessential edges of the graph  $\Lambda_{2p-1}^1$  with respect to some  $D_{2p}$  action on that graph. Second, do not be fooled into thinking that there is only one conjugacy class of subgroups of  $Aut(F_{2p-1})$  that is providing all of these  $D_{2p}$ -symmetries for  $M$ . In other words, our calculations are not taking place in the fixed point subcomplex  $X_{2p-1}^G$  for just one particular  $D_{2p} \cong G \subset Aut(F_{2p-1})$ . For example, it can be seen from Theorem 2.6 that the dihedral groups corresponding to  $\Upsilon_{2p-1}^1$  and  $\Xi_p \vee R_{p-1}$  are not conjugate to each other.

As the homotopy retracting  $M$  to  $M'$  is  $Aut(F_{2p-1})$ -invariant, it descends to a deformation retraction of  $M/Aut(F_{2p-1})$  to  $M'/Aut(F_{2p-1})$ . Hence the relative cohomology groups

$$H^*(M/Aut(F_{2p-1}), N/Aut(F_{2p-1}); \mathbb{Z}/p)$$

and

$$H^*(M'/Aut(F_{2p-1}), N/Aut(F_{2p-1}); \mathbb{Z}/p)$$

are isomorphic. Now referring to Figure 13.4, we see that

$$H^t(M'/Aut(F_{2p-1}), N/Aut(F_{2p-1}); \mathbb{Z}/p) = 0$$

for all  $t$  because we can contract all of the simplices in  $M'/\text{Aut}(F_{2p-1})$  uniformly into  $N/\text{Aut}(F_{2p-1})$ .  $\square$

An immediate consequence is

**Remark 14.2** *Let  $k$  be such that  $0 < 4k - 2 < 2(p - 1)$ . In the spectral sequence 1.1 applied to calculate  $H^*(\text{Aut}(F_{2p-1}); \mathbb{Z}_{(p)})$ , a nontrivial torsion cohomology class in  $E_1^{2, 4k-2}$  survives at least until it would be mapped to the  $r$ -axis; that is, it survives at least up to the  $E_{4k-1}$ -page, after which the differential*

$$d_{4k-1} : E_{4k-1}^{2, 4k-2} \cong \mathbb{Z}/p \rightarrow E_{4k-1}^{4k+1, 0} \cong H^{4k+1}(Q_{2p-1}; \mathbb{Z}_{(p)})$$

*might kill the class by mapping it to something nonzero.*

**Theorem 14.3** *For all positive integers  $k$ , either*

$$H^{4k}(\text{Aut}(F_\infty); \mathbb{Q}) \neq 0$$

*or*

$$H^{4k+1}(Q_m; \mathbb{Z}) \text{ never stabilizes as } m \rightarrow \infty.$$

**Proof.** From [15], if  $m \geq 8k + 3$ , then the standard map

$$H^{4k}(\text{Aut}(F_{m+1}); \mathbb{Z}) \rightarrow H^{4k}(\text{Aut}(F_m); \mathbb{Z})$$

is an isomorphism. Observe that  $H^{4k}(\text{Aut}(F_{8k+3}); \mathbb{Z}) = H^{4k}(\text{Aut}(F_\infty); \mathbb{Z})$  is a finitely generated abelian group. If it contains a torsion free summand isomorphic to  $\mathbb{Z}$ , then we are done and  $H^{4k}(\text{Aut}(F_\infty); \mathbb{Q}) \neq 0$ . Otherwise, choose a prime  $q$  such that  $2q - 1 \geq 8k + 3$  and so that for all primes  $p \geq q$  there is no  $p$ -torsion in

$H^{4k}(\text{Aut}(F_{8k+3}); \mathbb{Z})$ . We will show that  $H^{4k+1}(Q_{2p-1}; \mathbb{Z})$  has  $p$ -torsion for all primes  $p \geq q$ , which will prove the theorem.

Let  $p \geq q$ . From the lemma above, if we use the standard equivariant spectral sequence to calculate  $H^*(\text{Aut}(F_{2p-1}); \mathbb{Z}_{(p)})$ , then a class  $\alpha \in E_1^{2,4k-2}$  in the  $E_1$ -page survives at least until the  $E_{4k-1}$ -page. Because  $H^{4k}(\text{Aut}(F_{2p-1}); \mathbb{Z})$  has no  $p$ -torsion and  $H^{4k}(\text{Aut}(F_{2p-1}); \mathbb{Q}) = 0$ , we have  $H^{4k}(\text{Aut}(F_{2p-1}); \mathbb{Z}_{(p)}) = 0$ . Hence the class  $\alpha \in E_1^{2,4k-2}$  cannot survive to the  $E_\infty$  page.

It follows that there is  $p$ -torsion in  $E_{4k-1}^{4k+1,0}$ . Recall that  $E_1^{r,0}$  corresponds to the cellular chain complex with  $\mathbb{Z}_{(p)}$  coefficients for  $Q_{2p-1}$ . The  $p$ -torsion in  $E_{4k-1}^{4k+1,0}$ , therefore, would have to have been created when going from the  $E_1$  to  $E_2$  pages, because any of the torsion above the horizontal axis of the spectral sequence could not map onto a torsion free element on the horizontal axis. So  $H^{4k+1}(Q_{2p-1}; \mathbb{Z}_{(p)})$  has  $p$ -torsion, and thus  $H^{4k+1}(Q_{2p-1}; \mathbb{Z})$  has  $p$ -torsion.  $\square$

From calculations in [16] that  $H^4(\text{Aut}(F_\infty); \mathbb{Q}) = 0$ , it follows that

**Corollary 14.4** *The cohomology group  $H^5(Q_m; \mathbb{Z})$  never stabilizes as  $m \rightarrow \infty$ .*

# Chapter 15

## Graphs without basepoints

Let  $\hat{X}_n$  be the spine of Culler-Vogtmann space [10] for  $Out(F_n)$ , a moduli space of marked graphs. Let  $\hat{Q}_n$ , a moduli space of graphs, be the quotient of  $\hat{X}_n$  by  $Out(F_n)$ .

For the case of graphs without basepoints, substantially the same arguments can be made as those in the previous two chapters. For example, we can state exact analogues of Theorem 14.3 and Corollary 14.4:

**Theorem 15.1** *For all positive integers  $k$ , either*

$$H^{4k}(Out(F_\infty); \mathbb{Q}) \neq 0$$

*or*

$$H^{4k+1}(\hat{Q}_m; \mathbb{Z}) \text{ never stabilizes as } m \rightarrow \infty.$$

**Proof.** From [14],

$$H^{4k}(Out(F_\infty); \mathbb{Q}) = H^{4k}(Aut(F_\infty); \mathbb{Q})$$



and if  $m \geq 4k^2 + 10k + 1$ , then the standard map

$$H^{4k}(\text{Aut}(F_m); \mathbb{Z}) \rightarrow H^{4k}(\text{Out}(F_m); \mathbb{Z})$$

is an isomorphism. Observe that  $H^{4k}(\text{Out}(F_{4k^2+10k+1}); \mathbb{Z}) = H^{4k}(\text{Out}(F_\infty); \mathbb{Z})$  is a finitely generated abelian group. If it contains a torsion free summand isomorphic to  $\mathbb{Z}$ , then we are done and  $H^{4k}(\text{Out}(F_\infty); \mathbb{Q}) \neq 0$ . Otherwise, choose a prime  $q$  such that  $q + 1 \geq 4k^2 + 10k + 1$  and so that for all primes  $p \geq q$  there is no  $p$ -torsion in  $H^{4k}(\text{Out}(F_{4k^2+10k+1}); \mathbb{Z})$ . We will show that  $H^{4k+1}(\hat{Q}_{p+1}; \mathbb{Z})$  has  $p$ -torsion for infinitely many primes  $p$ , namely those primes  $p \geq q$  which are congruent to 3 modulo 4, which will prove the theorem.

Let  $p \geq q$  with  $p \equiv 3 \pmod{4}$ . Because  $H^{4k}(\text{Out}(F_{p+1}); \mathbb{Z})$  has no  $p$ -torsion, there is also no  $p$ -torsion in  $H^{4k}(\text{Out}(F_{p+1}); \mathbb{Z}_{(p)})$ . From the calculation of Glover and Mislin in [12] of the  $E_2$ -page of the equivariant spectral sequence used to calculate  $H^*(\text{Out}(F_{2p-1}); \mathbb{Z}_{(p)})$ , we know that this  $E_2$ -page, in the rows  $0 \leq s < 2(p-1)$ , is given by

$$E_2^{r,s} = \begin{cases} H^r(\hat{Q}_{p+1}; \mathbb{Z}_{(p)}) & s = 0 \\ \mathbb{Z}/p & r = 0 \text{ and } s = 4k > 0, k \in \mathbb{Z}^+ \\ (n_p)\mathbb{Z}/p & r = 1 \text{ and } s = 4k > 0, k \in \mathbb{Z}^+ \\ 0 & \text{otherwise} \end{cases}$$

where  $n_p = (p-1)/12 - \epsilon_p$  and  $\epsilon_p \in \{0, 1\}$ .

Hence a class  $\hat{\alpha} \in E_2^{0,4k}$  in the  $E_2$ -page survives at least until the  $E_{4k+1}$ -page. The class  $\hat{\alpha} \in E_2^{0,4k}$  cannot survive to the  $E_\infty$  page, however, because there is no  $p$ -torsion in the finite (since  $H^{4k}(\text{Out}(F_{p+1}); \mathbb{Q}) = 0$ ) additive group  $H^{4k}(\text{Out}(F_{p+1}); \mathbb{Z}_{(p)})$ .

It follows that there is  $p$ -torsion in

$$E_{4k+1}^{4k+1,0} = H^{4k+1}(\hat{Q}_{p+1}; \mathbb{Z}_{(p)}).$$

Thus  $H^{4k+1}(\hat{Q}_{p+1}; \mathbb{Z})$  has  $p$ -torsion.  $\square$

From calculations in [16] that  $H^4(\text{Out}(F_\infty); \mathbb{Q}) = 0$ , it follows that

**Corollary 15.2** *The cohomology group  $H^5(\hat{Q}_m; \mathbb{Z})$  never stabilizes as  $m \rightarrow \infty$ .*

Note that the behavior illustrated in Theorem 15.1 appears to be a fairly common phenomenon, and that additional theorems could be stated about similar phenomena. For example, from looking at the terms  $E_2^{1,4k}$  in the spectral sequence Glover and Mislin [12] used to calculate  $H^*(\text{Out}(F_{p+1}); \mathbb{Z}_{(p)})$ , one could state an exact analogue of Theorem 15.1 which implies that either

$$H^{4k+1}(\text{Out}(F_\infty); \mathbb{Q}) \neq 0$$

or

$$H^{4k+2}(\hat{Q}_m; \mathbb{Z}) \text{ never stabilizes as } m \rightarrow \infty.$$

From this in turn one could use Vogtmann's calculation that  $H^5(\text{Out}(F_\infty); \mathbb{Q}) = 0$  to get an analogue of Corollary 15.2 about  $H^6(\hat{Q}_m; \mathbb{Z})$  never stabilizing.

# Appendix A

## On the prime $p = 3$

For the sake of having a concrete example, we calculate the cohomologies of all of the quotient spaces involved in Theorem 6.1 when  $p = 3$ . This was also done, independently, by Glover and Henn.

### Theorem A.1

$$\hat{H}^t(\text{Aut}(F_4); \mathbb{Z}_{(3)}) = \begin{cases} \mathbb{Z}/9 \oplus 3(\mathbb{Z}/3) & t = 0 \\ ([\frac{3k}{2}] + 2)\mathbb{Z}/3 & |t| = 4k \neq 0 \\ \mathbb{Z}/3 & t = 1 \\ 0 & |t| \equiv 1, 2 \pmod{4} \text{ and } t \neq 1 \\ ([\frac{3k}{2}] - 1)\mathbb{Z}/3 & |t| = 4k - 1 \end{cases}$$

**Proof.** Examining Theorem 6.1 reveals that we must show that none of the various quotient spaces  $H^r(\tilde{Q}_k; \mathbb{Z}/3)$ ,  $H^r(Q_k; \mathbb{Z}/3)$ , and  $H^r(Q_2^\omega; \mathbb{Z}/3)$  (where  $k = 1, 2$ ) contribute any nonzero cohomology classes.

The groups  $H^r(Q_1; \mathbb{Z}/3)$ ,  $H^r(Q_2; \mathbb{Z}/3)$ ,  $H^r(\tilde{Q}_1; \mathbb{Z}/3)$ , and  $H^1(\tilde{Q}_2; \mathbb{Z}/3)$  are all zero by Lemma 5.6, Lemma 5.8, and Proposition 10.1. In addition, Fact 5.9 gives us that  $H^2(\tilde{Q}_2; \mathbb{Z}/3) = 0$ .

For  $H^r(Q_3^\omega; \mathbb{Z}/3)$  (see Definition 4.2 to recall the definitions related to this space), we note that the relevant marked graphs in  $Q_3^{(\omega)} \cong X_4^A/N_{Aut(F_4)}(A)$  are those listed in component  $(\mathcal{A})$  of section 4 in the paper [12] by Glover and Mislin, with the additional complication that a basepoint  $*$  can be added to the graphs in various places. However, most of these graphs have inessential edges (see [19]) under the action of  $N_{Aut(F_4)}(A)$ , and are thus collapsed directly away when we reduce from  $Q_3^{(\omega)} \cong X_4^A/N_{Aut(F_4)}(A)$  to the space  $Q_3^\omega$ . We list the graphs from [12] that give  $X_4^A/N_{Aut(F_4)}(A)$  here:

- $R_4$ . The rose has no inessential edges, even when you attach the basepoint  $*$  to the middle of one of the petals.
- $\Theta_4$ . This  $\Theta$ -graph has no inessential edges, regardless of where the basepoint is attached.
- $W_3 \vee R_1$ . In our notation, this would be  $\Xi_3 \vee R_1$ . The inessential edges in the “spokes” of the graph  $W_3$  are collapsed and reduce this graph to  $R_4$ .
- $\Theta_3 * R_1$ . This is  $\Theta_3$  with a loop  $R_1$  attached to the middle of one of the edges of the  $\Theta$ -graph. The edge of the  $\Theta$ -graph that the loop is attached to is inessential. (It will be 2 or 3 actual edges in the resulting graph, all of which are inessential, depending upon where the basepoint is placed.) Collapsing the inessential edges yields  $R_4$ .

- $\Theta_2 \diamond Y$ . A graph in the shape of a letter  $Y$  attached to the graph  $\Theta_2$ , with the top vertices of the  $Y$  attached to one side of the  $\Theta$ -graph, and the bottom vertex of the  $Y$  attached to the other side of the  $\Theta$ -graph. The bottom edge of the  $Y$  is inessential. Collapsing this gives  $\Theta_4$ .
- $\Theta_2 * * \Theta_1$ . Two  $\Theta$ -graphs with a line drawn from the left vertex of one to the left vertex of the other, and a line drawn from the right vertex of one to the right vertex of the other. The new lines drawn are inessential edges, and can be collapsed away to yield  $\Theta_4$ .

So we are left with 4 basepointed graphs. Two come from the rose  $R_4$ , depending upon where we place the basepoint, and the other two come from  $\Theta_4$  in a similar manner. In particular, only  $\Theta_4$  (with the basepoint  $*$  placed in the middle of one of its edges) can contribute a 2-simplex to our complex, and the relevant marked graph only has one maximal subforest (up to an isomorphism of the graph). Hence it contributes exactly two 2-simplices, which join together to form a square. Consequently it is clear that  $H^2(Q_3^\omega; \mathbb{Z}/3) = 0$ , which is all we needed to show to prove that  $Q_3^\omega$  contributes nothing more to our cohomology calculations.

For the final case of considering the contributions of  $H^3(\tilde{Q}_2; \mathbb{Z}/3)$ , we again use arguments like those in [16] and Proposition 10.3 from Part II. We show that all of the 3-simplices in  $\tilde{Q}_2$  can be collapsed away, so that  $H^3(\tilde{Q}_2; \mathbb{Z}/3)$  is necessarily zero. The relevant graphs which can give 3-simplices are:

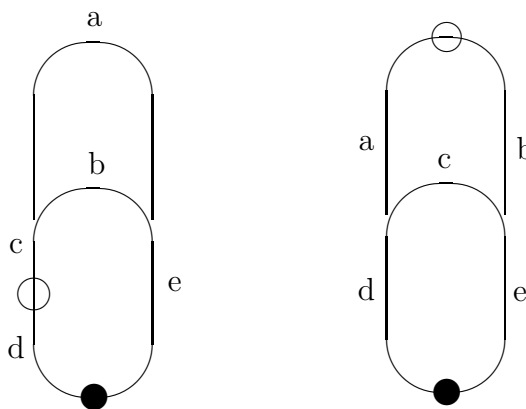

Figure A.1: Graphs giving some 3-simplices

For the graphs in Figure A.1, the basepoint is given by a filled-in dot. The open circle  $\circ$  is the other “distinguished point” of the graph and indicates where a  $\Theta$ -graph  $\Theta_2$  should be attached.

The first of these graphs has four subforests  $\{b, c, e\}$ ,  $\{b, c, d\}$ ,  $\{b, d, e\}$ , and  $\{c, d, e\}$ , each of which gives a 3-dimensional cube. These can be collapsed in a manner similar to that described in Proposition 10.3 in Chapter 10. That is, the cube corresponding to the first subforest  $\{b, c, e\}$  has a free minusface obtained by collapsing  $b$ . So we can collapse the interior of this cube away from that face. Then the cube  $\{b, c, d\}$  has a free plusface corresponding to  $\{b, c\}$  and  $\{b, d, e\}$  has a free plusface corresponding to  $\{b, e\}$ . Both of these cubes can be collapsed away from those respective plusfaces. This leaves the cube corresponding to  $\{c, d, e\}$  with all plusfaces free. Thus we can disregard the first of the graphs in Figure A.1. (For a more detailed description of what plusfaces and minusfaces are, along with several more examples, see part II of this paper.)

The second of the graphs that give 3-simplices contributes 4 cubes, one for each of the subforests  $\{a, d, e\}$ ,  $\{a, b, d\}$ ,  $\{a, c, d\}$ , and  $\{a, c, e\}$ . The cube corresponding to  $\{a, d, e\}$  has a free minusface given by collapsing the edge  $a$ . So we can disregard this cube. The remaining 3 cubes join together to form a solid 3-ball as described in the proof of Proposition 10.3, and so can also be collapsed away.  $\square$

# Bibliography

- [1] A. Adem and R. J. Milgram, *Cohomology of Finite Groups*, Springer-Verlag Berlin, Heidelberg 1994.
- [2] R. Alperin and H. Bass, *Length functions of group actions on  $\Lambda$ -trees*, Gersten, S. M. et al., *Combinatorial Group Theory and Topology*, Princeton University Press Princeton (1987) 265-378.
- [3] G. Baumslag and T. Taylor, *The center of groups with one defining relator*, Math. Ann. 175 (1968) 315-319.
- [4] D. J. Benson, *Representations and cohomology I: Basic representation theory of finite groups and associative algebras* Cambridge University Press Cambridge 1991.
- [5] D. J. Benson, *Representations and cohomology II: Cohomology of groups and modules* Cambridge University Press Cambridge 1991.
- [6] T. Brady, *The integral cohomology of  $Out_+(F_3)$* , J. Pure Appl. Algebra 87 (1993) 123-167.
- [7] K. Brown, *Cohomology of Groups*, Springer-Verlag Berlin, Heidelberg 1982.
- [8] Y. Q. Chen, *Farrell cohomology of automorphism groups of free groups of finite rank*, Ohio State University Ph.D. dissertation, Columbus, Ohio 1998.
- [9] M. Culler, *Finite groups of outer automorphisms of a free group*, Contemporary Math 33 (1984) 197-207.
- [10] M. Culler and K. Vogtmann, *Moduli of graphs and automorphisms of free groups*, Invent. Math. 84 (1986) 91-119.
- [11] F. Thomas Farrell, *An extension of Tate cohomology to a class of infinite groups*, J. Pure Appl. Algebra 10 (1977) 153-161.



- [12] H. H. Glover and G. Mislin, *On the  $p$ -primary cohomology of  $\text{Out}(F_n)$  in the  $p$ -rank one case*, Ohio State University preprints.
- [13] P. M. Gudivok, *On the Sylow subgroups of the full linear group over the ring of integers*, Leningrad Math J. Vol. 2 (1991), No. 6, 1279-1285.
- [14] Allen Hatcher, *Homological stability for automorphism groups of free groups*, Comment. Math. Helv. 70 (1995) 39-62.
- [15] A. Hatcher and K. Vogtmann, *Cerf theory for graphs*, preprint.
- [16] A. Hatcher and K. Vogtmann, *Rational homology of  $\text{Aut}(F_n)$* , preprint.
- [17] Hans-Werner Henn, *Centralizers of elementary abelian  $p$ -subgroups, the Borel construction of the singular locus and applications to the cohomology of discrete groups*, preprint.
- [18] Sava Krstic, *Actions of Finite Groups on Graphs and Related Automorphisms of Free Groups*, J. Algebra 124 (1989) 119-138.
- [19] Sava Krstic and Karen Vogtmann, *Equivariant outer space and automorphisms of free-by-finite groups*, Comment. Math. Helv. 68 (1993) 216-262.
- [20] R. Lyndon and P. Schupp, *Combinatorial Group Theory*, Springer Verlag Berlin, 1977.
- [21] H. Minkowski, *Zur Theorie der positiven quadratischen Formen*, Crelles J. 101 (1887) 196-202.
- [22] D. Quillen, *Homotopy properties of the poset of  $p$ -subgroups of a finite group*, Advances in Math. 28 (1978) 101-128.
- [23] J. Smillie and K. Vogtmann, *A generating function for the Euler characteristic of  $\text{Out}(F_n)$* , J. Pure Appl. Algebra 44 (1987) 329-348.
- [24] J. Smillie and K. Vogtmann, *Automorphisms of graphs,  $p$ -subgroups of  $\text{Out}(F_n)$  and the euler characteristic of  $\text{Out}(F_n)$* , J. Pure Appl. Algebra 49 (1987) 187-200.
- [25] R. G. Swan, *The  $p$ -period of a finite group*, Ill. J. Math 4 (1960), 341-346.