

Geometry & Topology
Volume 6 (2002) 153–194
Published: 30 March 2002

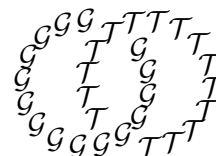

Laminar Branched Surfaces in 3–manifolds

TAO LI

*Department of Mathematics, 401 Math Sciences
Oklahoma State University, Stillwater, OK 74078, USA*

Email: tli@math.okstate.edu

URL: <http://www.math.okstate.edu/~tli>

Abstract

We define a laminar branched surface to be a branched surface satisfying the following conditions: (1) Its horizontal boundary is incompressible; (2) there is no monogon; (3) there is no Reeb component; (4) there is no sink disk (after eliminating trivial bubbles in the branched surface). The first three conditions are standard in the theory of branched surfaces, and a sink disk is a disk branch of the branched surface with all branch directions of its boundary arcs pointing inwards. We will show in this paper that every laminar branched surface carries an essential lamination, and any essential lamination that is not a lamination by planes is carried by a laminar branched surface. This implies that a 3–manifold contains an essential lamination if and only if it contains a laminar branched surface.

AMS Classification numbers Primary: 57M50

Secondary: 57M25, 57N10

Keywords 3–manifold, branched surface, lamination

Proposed: Cameron Gordon
Seconded: Joan Birman, Robion Kirby

Received: 16 February 2001
Revised: 8 July 2001

0 Introduction

It has been a long tradition in 3–manifold topology to obtain topological information using codimension one objects. Almost all important topological information has been known for 3–manifolds that contain incompressible surfaces, eg, [21, 20]; other codimension one objects, such as Reebless foliations and immersed surfaces, have also been proved fruitful [3, 4, 5, 11, 17]. In [9], essential laminations were introduced as a generalization of incompressible surfaces and Reebless foliations and it was proved in [9] that if a closed and orientable 3–manifold contains an essential lamination, then its universal cover is \mathbb{R}^3 . More recently, Gabai and Kazez proved that if an orientable and atoroidal 3–manifold contains a genuine lamination, ie, an essential lamination that can not be trivially extended to a foliation, then its fundamental group is negatively curved in the sense of Gromov.

Ever since the invention of essential laminations, branched surfaces have been a practical tool to study them [9]. Gabai and Oertel have shown that some splitting of any essential lamination is fully carried by a branched surface satisfying some natural conditions (see Proposition 1.1) and any lamination carried by such a branched surface is an essential lamination. However, these conditions do not guarantee the existence of essential laminations. In fact, it was shown [9] that even S^3 contains branched surfaces satisfying those conditions. One of the most important problems in the theory of essential laminations is to find sufficient conditions for a branched surface to carry an essential lamination (see Gabai’s problem list [7]). In this paper we will show that those standard conditions in [9] plus one more, which is that the branched surface does not contain sink disks, are sufficient and (except for a single 3–manifold) necessary conditions, see section 1 for definition of sink disk. We call a branched surface satisfying these conditions a laminar branched surface.

Theorem 1 *Suppose M is a closed and orientable 3–manifold. Then:*

- (a) *Every laminar branched surface in M fully carries an essential lamination.*
- (b) *Any essential lamination in M that is not a lamination by planes is fully carried by a laminar branched surface.*

Furthermore, if $\lambda \subset M$ is a lamination by planes (hence $M = T^3$), then any branched surface carrying λ is not a laminar branched surface.

Since $T^3 = S^1 \times S^1 \times S^1$ is Haken, and incompressible surfaces are very special cases of essential laminations, we have:

Theorem 2 *A 3-manifold contains an essential lamination if and only if it contains a laminar branched surface.*

In many situations, it is easier to construct a branched surface than to construct an essential lamination. Theorem 1 gives a criterion to tell whether a branched surface carries an essential lamination. It is a very useful theorem. For example, Delman and Wu [1, 22] have shown that many 3-manifolds contain essential laminations by constructing branched surfaces in certain classes of knot complements and showing that they carry essential laminations. Theorem 1 can simplify, to some extent, their proofs. It is also easy to see that Hatcher's branched surfaces [13] satisfy our conditions. Moreover, after splitting the branched surfaces near the boundary torus such that the train tracks (ie, Hatcher's branched surfaces restricted to the boundary) become circles, the branched surfaces also satisfy our conditions (after capping the circles off). This implies that they are laminar branched surfaces in the manifolds after the Dehn fillings along these circles. Hence Hatcher's branched surfaces carry more laminations than what was shown in [13] and Theorem 1 gives a simpler proof of a theorem of Naimi [16]. More recently, Roberts has constructed taut foliations in many manifolds using this theorem [19].

Another interesting question that arose when the concept of essential lamination was introduced is whether there is a lamination-free theory for branched surfaces. In a subsequent paper [15], we will discuss this question by proving the following theorem and some interesting properties of laminar branched surfaces without using lamination techniques. Theorem 3 is just the branched surface version of the theorems of Gabai–Oertel [9] and Gabai–Kazez [10], and it is an immediate corollary of Theorem 1.

Theorem 3 *Let M be a closed and orientable 3-manifold that contains a laminar branched surface B . Then:*

- (i) *The universal cover of M is \mathbb{R}^3 .*
- (ii) *If, in addition, the 3-manifold is atoroidal and at least one component of $M - B$ is not an I -bundle, then the fundamental group of M is word hyperbolic.*

We organize the paper as follows: in section 1, we list some basic definitions and results about essential laminations and give the definition of laminar branched surfaces; in section 2, we prove some topological lemmas that we need in the construction of essential laminations; in sections 3 and 4, we show that every

laminar branched surface carries an essential lamination; in section 5, we prove part (b) of Theorem 1.

Acknowledgments I would like to thank Dave Gabai and Ian Agol for many very helpful conversations. I would also like to thank the referee for many corrections and suggestions.

1 Preliminaries

A (codimension one) lamination λ in a 3-manifold M is a foliated, closed subset of M , ie, λ is covered by a collection of open sets of the form $\mathbb{R}^2 \times \mathbb{R}$ such that, for any open set U , $\lambda \cap U = \mathbb{R}^2 \times C$, where C is a closed set in \mathbb{R} , and the transition maps preserve the product structures. The coordinate neighborhoods of leaves are of the form $\mathbb{R}^2 \times x$ ($x \in C$).

Unless specified, our laminations in this paper are always assumed to be codimension one laminations in closed and orientable 3-manifolds. Similar results hold for laminations (with boundary) in 3-manifolds whose boundary is incompressible. Let λ be a lamination in M , and M_λ be the metric completion of the manifold $M - \lambda$ with the path metric inherited from a Riemannian metric on M .

Definition 1.1 [9] λ is an *essential lamination* in M if it satisfies the following conditions.

- (1) The inclusion of leaves of the lamination into M induces an injection on π_1 .
- (2) M_λ is irreducible.
- (3) λ has no sphere leaves.
- (4) λ is end-incompressible.

Definition 1.2 A *branched surface* B in M is a union of finitely many compact smooth surfaces glued together to form a compact subspace (of M) locally modeled on Figure 1.1.

Notation Throughout this paper, we denote the interior of X by $\text{int}(X)$, and denote the number of components of X by $|X|$, for any X .

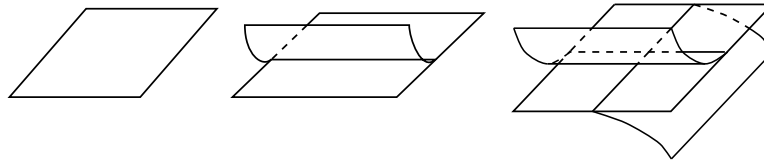

Figure 1.1

Given a branched surface B embedded in a 3-manifold M , we denote by $N(B)$ a regular neighborhood of B , as shown in Figure 1.2. One can regard $N(B)$ as an interval bundle over B . We denote by $\pi: N(B) \rightarrow B$ the projection that collapses every interval fiber to a point. The *branch locus* of B is $L = \{b \in B : b \text{ does not have a neighborhood homeomorphic to } \mathbb{R}^2\}$. So, L can be considered as a union of smoothly immersed curves in B , and we call a point in L a *double point* of L if any small neighborhood of this point is modeled on the third picture of Figure 1.1.

Let D_0 be a component of $B - L$, and D be the closure of D_0 in the path metric (of $B - L$). Then, $\text{int}(D) = D_0$, $\partial D \subset L$, and those non-smooth points in ∂D are double points of L . Note that $\text{int}(D) = D_0$ is embedded in B , but ∂D may not be embedded in B (there may be two boundary arcs of D that are glued to the same arc in L). We call D a *branch* of B .

The boundary of $N(B)$ is a union of two compact surfaces $\partial_h N(B)$ and $\partial_v N(B)$. An interval fiber of $N(B)$ meets $\partial_h N(B)$ transversely, and intersects $\partial_v N(B)$ (if at all) in one or two closed intervals in the interior of this fiber. Note that $\partial_v N(B)$ is a union of annuli, and $\pi(\partial_v N(B))$ is exactly the branch locus of B (see Figure 1.2). We call $\partial_h N(B)$ the *horizontal boundary* of $N(B)$ and $\partial_v N(B)$ the *vertical boundary* of $N(B)$.

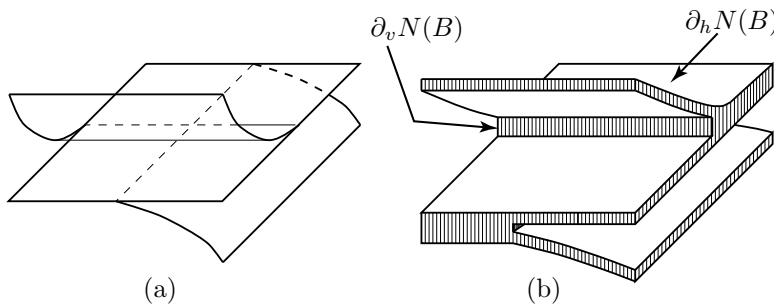

Figure 1.2

We say a lamination λ is *carried* by B if, after some splitting, λ can be isotoped

into $\text{int}(N(B))$ so that it intersects the interval fibers transversely, and we say λ is *fully carried* by B if λ intersects every fiber of $N(B)$.

Gabai and Oertel [9] found the first relation between essential laminations and the branched surfaces that carry them.

Proposition 1.1 (Gabai and Oertel) (a) *Every essential lamination is fully carried by a branched surface with the following properties.*

- (1) $\partial_h N(B)$ is incompressible in $M - \text{int}(N(B))$, no component of $\partial_h N(B)$ is a sphere, and $M - B$ is irreducible.
- (2) There is no monogon in $M - \text{int}(N(B))$, ie, no disk $D \subset M - \text{int}(N(B))$ with $\partial D = D \cap N(B) = \alpha \cup \beta$, where $\alpha \subset \partial_v N(B)$ is in an interval fiber of $\partial_v N(B)$ and $\beta \subset \partial_h N(B)$.
- (3) There is no Reeb component, ie, B does not carry a torus that bounds a solid torus in M .
- (4) B has no disk of contact, ie, no disk $D \subset N(B)$ such that D is transverse to the I -fibers of $N(B)$ and $\partial D \subset \partial_v N(B)$, see Figure 1.3 (a) for an example.

(b) *If a branched surface with properties above fully carries a lamination, then it is an essential lamination.*

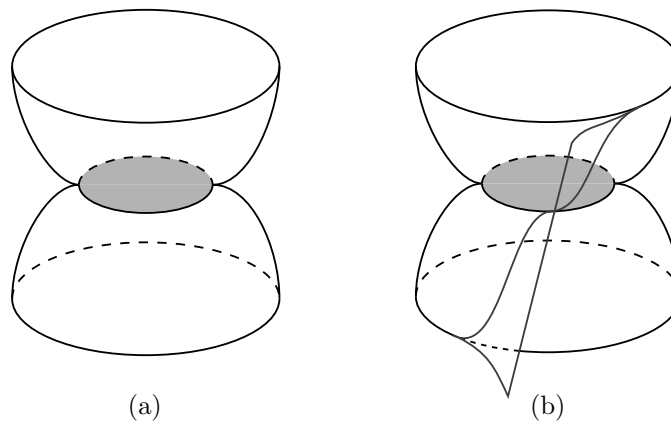

Figure 1.3

However, such branched surfaces may not carry any laminations and they do not give much information about the 3-manifolds.

Proposition 1.2 (Gabai and Oertel) S^3 contains a branched surface satisfying all the conditions in Proposition 1.1.

It has also been pointed out in [9] that a twisted disk of contact is an obvious obstruction for a branched surface to carry a lamination, because it forces non-trivial holonomy along trivial curves, which contradicts the Reeb stability theorem (see Figure 1.3 (b)).

Let L be the branch locus of B . L is a collection of smooth immersed curves in B . Let X be the union of double points of L . We associate with every component of $L - X$ a vector (in B) pointing in the direction of the cusp, as shown in Figure 1.4. We call it the *branch direction* of this arc.

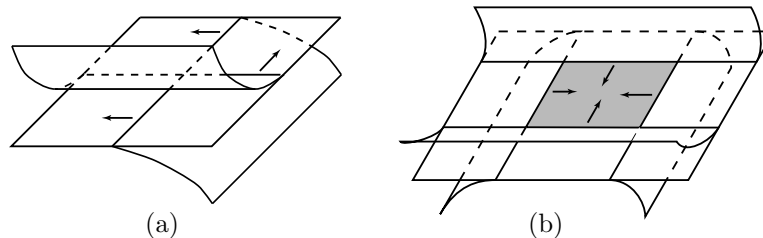

Figure 1.4

We call a disk branch of B a *sink disk* if the branch direction of every smooth arc (or curve) in its boundary points into the disk. The standard pictures of disks of contact (Figure 1.3 (a)) and twisted disks of contact (Figure 1.3 (b)) are all sink disks by our definition. Moreover, the disk in Figure 1.4 (b) is also a sink disk. Note that a disk of contact can be much more complicated than Figure 1.3 (a) (see Proposition 1.1 for the definition of disk of contact). We will discuss the relation between a sink disk and a disk of contact in section 2 (see Corollary 2.3).

A sink disk can be considered to be a generalized disk of contact. Here is another way to see this. In a regular neighborhood of such a disk, we consider the two components of the complement of B (the one above the disk and the one below). The disk is exactly the intersection of the boundaries of the two components. Moreover in each component, one can have a properly embedded disk with smooth boundary, which is isotopic to the sink disk.

Let K be a component of $M - \text{int}(N(B))$. If K is homeomorphic to a 3-ball, then, since $\partial_h N(B)$ is incompressible in $M - \text{int}(N(B))$, ∂K consists of two disk components of $\partial_h N(B)$ and an annulus component of $\partial_v N(B)$. Moreover, we can give K a fiber structure $D^2 \times I$, with $D^2 \times \partial I \subset \partial_h N(B)$

and $\partial D^2 \times I \subset \partial_v N(B)$. We call K a $D^2 \times I$ region in $M - \text{int}(N(B))$, $D^2 \times \partial I$ the *horizontal boundary* of K and $\partial D^2 \times I$ the *vertical boundary* of K .

Definition 1.3 Let D_1 and D_2 be the two disk components of the horizontal boundary of a $D^2 \times I$ region K in $M - \text{int}(N(B))$. Hence, D_1 and D_2 are also two disk components of $\partial_h N(B)$ and $D_1 \cup D_2 = D^2 \times \partial I$. Thus, $\pi(\partial D_1) = \pi(\partial D_2)$ is a circle in the branch locus L , where $\pi: N(B) \rightarrow B$ is the collapsing map. If π restricted to the interior of $D_1 \cup D_2$ is injective, ie, the intersection of any I -fiber of $N(B)$ with $\text{int}(D_1) \cup \text{int}(D_2)$ is either empty or a single point, then we call K a *trivial $D^2 \times I$ region*, and we say that $\pi(D_1 \cup D_2)$ forms a *trivial bubble* in B .

Let $K = D^2 \times I$ be a trivial $D^2 \times I$ region. Then, after collapsing each I -fiber of $K = D^2 \times I$ to a point, $N(B) \cup K$ becomes a fibered neighborhood of another branched surface with the induced fiber structure from $N(B)$. Thus, if B contains a trivial bubble, we can pinch B to get another branched surface by collapsing the I -fibers in the corresponding trivial $D^2 \times I$ region, and the new branched surface after this pinching preserves the properties 1–4 in Proposition 1.1. There is really no difference between the branched surface before this pinching and the one after the pinching. It is easy to see that a branched surface carries a lamination if and only if, after we collapse all trivial bubbles in B as above, the new branched surface carries a lamination. Not all $D^2 \times I$ regions are trivial, eg, we cannot collapse all the $D^2 \times I$ regions in a standard Reeb component. Moreover, if we blow an “air bubble” into the interior of a sink disk, it will destroy the sink disk by definition but nothing really changes. So, in this paper, we always assume B contains no trivial bubble.

Definition 1.4 A branched surface B in M is called a *laminar branched surface* if it satisfies conditions 1–3 in Proposition 1.1, and B has no sink disk (after we collapse all the trivial bubbles as described above).

In this paper, we will also use some techniques about train tracks. We refer readers to [18] section 1.1 for basic definitions and properties about train tracks. Let D be a disk and τ be a train track in D . Suppose W is a closed disk embedded in the plane whose boundary is piecewise smooth with $k \geq 0$ discontinuities in the tangent. Let $h: W \rightarrow D$ be a C^1 immersion which is an embedding of the interior of W , and $h(W) \subset \tau$. Let $\Delta = h(W)$, and we denote the image (under h) of $\text{int}(W)$ by $\text{int}(\Delta)$. Note that $\text{int}(\Delta)$ is an embedded open disk in D , but $\Delta - \text{int}(\Delta)$ may not be embedded in D . We call Δ a *k-gon*, if $k > 0$ and $\tau - \text{int}(\Delta)$ is a sub train track of τ in D . So, $\Delta - \text{int}(\Delta)$

is an immersed circle with k prongs, each smooth arc in $\Delta - \text{int}(\Delta)$ is carried by τ , and the k non-smooth points in $\partial\Delta$ are switches (non-manifold points) of τ . If $k = 1$, we also call Δ a monogon, and if $k = 2$, we also call Δ a bigon. If $\tau \cap \text{int}(\Delta) = \emptyset$, we call Δ a k -gon component of $D - \tau$. We call Δ a *smooth disk* if $k = 0$ and $\tau - \text{int}(\Delta)$ is a sub train track of τ in D , ie, $\text{int}(\Delta)$ is an embedded disk, and $\Delta - \text{int}(\Delta)$ is a circle carried by τ . We call Δ a *smooth disk component* of $D - \tau$ if $\tau \cap \text{int}(\Delta) = \emptyset$. Let $N(\tau)$ be a fibered neighborhood of τ . Then, the Δ above corresponds to an embedded disk in D ; if Δ is a smooth disk, $\partial\Delta$ corresponds to an embedded circle in $N(\tau)$ transversely intersecting the I -fibers of $N(\tau)$; if Δ is a k -gon, $\partial\Delta$ corresponds to an embedded circle in $N(\tau)$ consisting of k arcs, each of which is transverse to the I -fibers of $N(\tau)$. Throughout this paper, when we talk about an object in D with respect to the train track τ , we simultaneously use the same notation to denote the corresponding object in D with respect to $N(\tau)$.

Let Δ be a k -gon as above. We call $\Delta - \text{int}(\Delta)$ (ie, $h(W - \text{int}(W))$) the boundary of Δ , which we denote by $\partial\Delta$. We call the image (under h) of a non-smooth point of ∂W a *vertex* of the k -gon Δ , and call the image (under h) of a smooth arc between two non-smooth points in ∂W an *edge* of the k -gon Δ .

2 Some topological lemmas

In this section, we explore topological and combinatorial properties of laminar branched surfaces by proving some lemmas. Lemmas 2.4 and 2.5 will be used in section 4 to guarantee that a part of the lamination constructed in section 4 satisfies a technical condition in a lemma. Lemma 2.1 is interesting in its own right. In particular, we prove Corollary 2.3, which basically says that the condition of no sink disks implies that there is no disk of contact. Note that the condition of no disks of contact plays an important role in the proof of Proposition 1.1 (b) [9].

Let B be a laminar branched surface, and S be a branch of B . The boundary of S is piecewise smooth, and each smooth arc in ∂S has a transverse direction induced from the branch direction of the corresponding arc in L , where L denotes the branch locus throughout this paper. Then, we can consider B to be the object obtained by gluing all the branches of B together along their boundaries according to the branch directions. If the branch direction of each smooth arc in ∂S points out of S and there are no two arcs in ∂S glued together (to the same arc in L), then $B - \text{int}(S)$ naturally forms another

branched surface, as shown in Figure 2.1. We denote this branched surface ($B - \text{int}(S)$) by B^- . Note that if two arcs in ∂S are identified to the same arc in L , $B - \text{int}(S)$ is not a branched surface anymore near this arc. Moreover, no three arcs in ∂S can be identified to the same arc in L , because otherwise, one of the three arcs must have induced direction (from the branch direction) pointing into S .

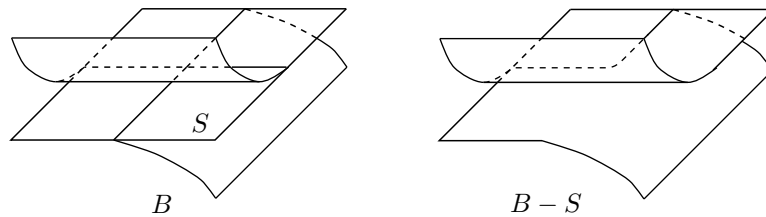

Figure 2.1

Definition 2.1 Let S be a disk branch of B with branch direction of each boundary edge pointing out of S . If there are no two arcs in the boundary of S identified to the same arc in L , we call S a *removable disk*. If B contains no removable disk, we say that B is *efficient*.

Lemma 2.1 Let B be a laminar branched surface and S be a removable disk in B . Then, $B^- = B - \text{int}(S)$ is also a laminar branched surface.

Proof We first note that we have assumed our laminar branched surface B does not have any trivial bubble. Then, B^- does not contain any trivial bubble either, since B can be considered as the branched surface obtained by adding a branch S to B^- and if we add a disk branch inside a trivial bubble of B^- , we always get a trivial bubble in B .

Now, we show that B^- has no sink disk. Suppose D is a sink disk in B^- , ie, D is a disk branch with branch directions of its boundary arcs pointing into D . If $D \cap \partial S$ is a union of arcs, then D is cut into pieces by ∂S , but at least one of these pieces is a sink disk in B , which gives a contradiction. If $D \cap \partial S$ contains a circle, since S is a disk branch of B and $\partial_h N(B)$ has no sphere component, ∂S must be a circle that bounds a disk D' in D and the branch direction of ∂S must point out of D' . Thus, $S \cup D'$ forms a trivial bubble in B , as $M - B$ is irreducible, which contradicts our assumption of no trivial bubbles.

Since any surface (or lamination) carried by B^- must also be carried by B , B^- has no Reeb component. Since no component of $\partial_h N(B)$ is a 2-sphere, it is

easy to see that no component of $\partial_h N(B^-)$ is a 2-sphere. Moreover, $M - B^-$ is irreducible, since a reducing sphere intersects S in loops, which bound disks in the disk branch S , and the irreducibility follows from a standard cut and paste argument. So, we only need to show that $\partial_h N(B^-)$ is incompressible in $M - \text{int}(N(B^-))$, and there is no monogon in $M - B^-$.

Note that $\partial_v N(B^-)$ has a natural fiber structure with every I -fiber a subarc of an I -fiber of $N(B^-)$. Let $\psi: N(B^-) \rightarrow N_{B^-}$ be a map such that:

- (1) ψ collapses every I -fiber of $\partial_v N(B^-)$ to a point;
- (2) ψ , when restricted to $\text{int}(N(B^-))$ and $\text{int}(\partial_h N(B^-))$, is a homeomorphism.

Figure 2.2 is a schematic picture of ψ . We denote the image of ψ by N_{B^-} . Let $\partial_h N_{B^-}$ be the image of $\text{int}(\partial_h N(B^-))$ (under the map ψ). If $\partial_h N(B^-)$ is compressible in $M - \text{int}(N(B^-))$, then $\partial_h N_{B^-}$ is compressible in $M - \text{int}(N_{B^-})$.

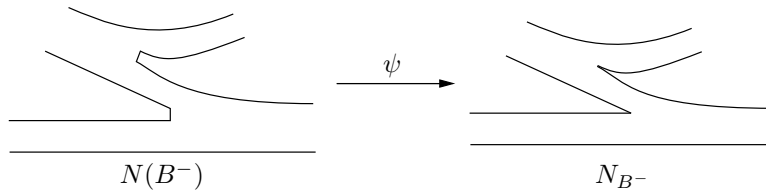

Figure 2.2

The component S is a surface with $\partial S \subset B^-$ and $\text{int}(S)$ embedded in $M - B^-$. The branched surface B can be considered as the union of B^- and S by smoothing out ∂S according to the branch direction. In the same way as adding S to B^- , we can add S to N_{B^-} . We can view S as a surface properly embedded in $M - \text{int}(N_{B^-})$ with ∂S piecewise smoothed out according to the branch direction. We consider this complex $N_{B^-} \cup S$. Note that if we collapse every I -fiber of N_{B^-} to a point, $N_{B^-} \cup S$ becomes B ; and if we thicken $N_{B^-} \cup S$ a little, it becomes $N(B)$. Let E be a compressing disk in $M - \text{int}(N_{B^-})$ with $\partial E \subset \partial_h N_{B^-}$. We may assume that the compressing disk E intersects S transversely except at $\partial E \cap \partial S$. We also assume $|E \cap S|$ (the number of components of $E \cap S$) is minimal among all compressing disks for $\partial_h N_{B^-}$. Thus, $E \cap S$ contains no closed circles, otherwise, since a circle of intersection bounds a disk in S , a standard cutting and pasting argument gives us a compressing disk with fewer intersection curves (with S).

Next, we show that $E \cap S \neq \emptyset$. Suppose $E \cap S = \emptyset$. Let K be the closure of the component of $M - N_{B^-}$ that contains S . Then, $E \subset K$, otherwise, it contradicts the assumption that $\partial_h N(B)$ is incompressible in $M - \text{int}(N(B))$.

As $E \cap S = \emptyset$, we can simultaneously consider E to be a disk embedded in $M - \text{int}(N(B))$ with ∂E a smooth nontrivial circle in $\partial_h N(B)$. Since $\partial_h N(B)$ is incompressible, there is an embedded disk $E' \subset \partial_h N(B)$ with $\partial E = \partial E'$ and $E \cup E'$ bounds an embedded 3-ball in $M - \text{int}(N(B))$. There are a pair of disks in $\partial_h N(B)$, which we denoted by S_1 and S_2 , such that $\pi(S_1) = \pi(S_2) = S$ (S_1 and S_2 can be considered as two sides of S). For each smooth arc $\alpha \subset \partial S$, let $\alpha_1 \subset \partial S_1$ and $\alpha_2 \subset \partial S_2$ be the two corresponding arcs such that $\pi(\alpha_1) = \pi(\alpha_2) = \alpha$. Then, since the branch direction of ∂S points out of S , either α_1 or α_2 must lie in the boundary of $\partial_h N(B)$ (ie, $\partial_h N(B) \cap \partial_v N(B)$). Thus, $E' \subset \text{int}(\partial_h N(B))$ cannot intersect both S_1 and S_2 . Therefore, there must be a smooth disk Δ embedded in $\partial_h N_{B^-} \cup S$ such that $\partial \Delta = \partial E$ and $\Delta \cup E$ bounds an embedded 3-ball in K . Since $\partial_h N(B)$ is incompressible, $\Delta \cap S \neq \emptyset$. Note that the purpose of the argument about S_1 and S_2 is to show that Δ cannot cover S from both sides of S and hence the 3-ball bounded by $E \cup \Delta$ is embedded. Since $E \cap S = \emptyset$, S must lie in the interior of Δ . Since S is a disk and since $\partial_h N(B)$ is incompressible in $M - \text{int}(N(B))$, K must be a solid torus with $\partial K \subset \partial_h N_{B^-}$, and $K \cup S$ forms a Reeb component, which contradicts our assumptions on B .

So, $E \cap S \neq \emptyset$. Since E and S are properly embedded in $M - \text{int}(N_{B^-})$, $E \cap S$ is a union of disjoint simple arcs in E . Since ∂S is smoothed out according to the branch direction, the union of ∂E and $E \cap S$ is a train track in E with all the switches (ie non-manifold points) in ∂E . Moreover, since $M - B$ has no monogon, $E - E \cap S$ has no monogon component. Hence, by a standard index argument, $E - E \cap S$ must have a smooth disk component (see section 1 for our definitions of smooth disk component and smooth disk). We denote this smooth disk component of $E - E \cap S$ by E_0 . Since $E \cap S$ is a union of disjoint properly embedded arcs, $E - E_0$ is a union of bigons, which we denote by E_1, \dots, E_n (E_i may contain other components of $E \cap S$). The boundary of each bigon E_i consists of two edges, α_i and β_i , where $\alpha_i = E_i \cap E_0$ and $\beta_i = E_i \cap \partial E$.

Since $\partial_h N(B)$ is incompressible, E_0 must be parallel to $\partial_h N_{B^-} \cup S$, ie, there is a smooth disk Δ in $\partial_h N_{B^-} \cup S$ such that $\partial \Delta = \partial E_0$ and $\Delta \cup E_0$ bounds a 3-ball. Note that by the argument about S_1 and S_2 above, only one side of S (near ∂S) can be in the interior of a smooth surface that corresponds to $\partial_h N(B)$. Hence, Δ must be embedded in $\partial_h N_{B^-} \cup S$, and $\Delta \cup E_0$ bounds an embedded 3-ball T . If $(E - E_0) \cap T \neq \emptyset$, then (since E is embedded) there must be another smooth disk component E'_0 (of $E - E \cap S$) lying in $(E - E_0) \cap T$, and there is a sub-disk of Δ , say Δ' , such that $\partial E'_0 = \partial \Delta'$ and $E'_0 \cup \Delta'$ bounds a 3-ball inside T . Thus, by choosing an appropriate smooth disk component,

we can assume that $(E - E_0) \cap T = \emptyset$.

Since there are no two arcs in ∂S identified to the same arc in L , ∂S is embedded in ∂N_{B^-} . Hence, $\Delta \cap \partial S$ is a union of disjoint curves that are properly embedded in Δ . Since S is a disk, $\Delta \cap \partial S$ contains no closed curves, and hence $\Delta \cap S$ is a union of disks in Δ . We denote the components of $\Delta \cap S$ by F_1, \dots, F_m . Then, each arc in $\partial F_i - \partial S$ is one of the α_j 's (in ∂E_j 's) defined before.

Let \hat{F}_i be the union of F_i and those E_j 's that share boundary edges α_j 's with F_i . By our construction, $\cup_{i=1}^n \alpha_i \subset \cup_{i=1}^m F_i$, and hence $\cup_{i=1}^n E_i \subset \cup_{i=1}^m \hat{F}_i$. Since each E_j is a bigon with $\partial E_j = \alpha_j \cup \beta_j$ ($\beta_j \subset \partial E - \partial E_0 \subset \partial_h N_{B^-}$), and since $(E - E_0) \cap T = \emptyset$, \hat{F}_i is an embedded disk with $\partial \hat{F}_i \subset \partial_h N_{B^-}$. Moreover, after pushing \hat{F}_i out of T , $\hat{F}_i \cap S$ has fewer components than $E \cap S$. Since we have assumed that $E \cap S$ has the least number of components among compressing disks, \hat{F}_i cannot be a compressing disk. So, \hat{F}_i can be homotoped into $\partial_h N_{B^-}$ fixing $\partial \hat{F}_i$, for any i . However, we can then first homotope E_0 into Δ fixing ∂E_0 and each E_i , then we homotope every \hat{F}_i into $\partial_h N_{B^-}$ fixing $\partial \hat{F}_i$. Since $\Delta - \partial_h N_{B^-} = \cup_{i=1}^m F_i$, and since $\cup_{i=1}^n E_i \subset \cup_{i=1}^m \hat{F}_i$, after those homotopies above, we have homotoped E into $\partial_h N_{B^-}$ fixing ∂E , which contradicts the assumption that E is a compressing disk. Therefore, $\partial_h N_{B^-}$ is incompressible in $M - \text{int}(N_{B^-})$, and hence $\partial_h N(B^-)$ is incompressible in $M - \text{int}(N(B^-))$.

Using a similar argument, we can show that $M - N_{B^-}$ contains no monogons. Note that since the argument in this case is very similar to the one above, we keep the same notation, and refer many details to the argument above. Now, we let E be a monogon, and suppose E intersects S transversely except at ∂S . We assume $E \cap S$ has the least number of components among all monogons. Note that $E \cap S \neq \emptyset$, since $M - B$ contains no monogons. As in the argument above, $(E \cap S) \cup \partial E$ is a train track in E . Since $M - B$ contains no monogons, $E - E \cap S$ contains no monogon component. Hence, by a standard index argument, there must be a smooth disk component in $E - E \cap S$, which we denote by E_0 . In this case, $E - E_0$ is a union of bigons and one 3-gon (ie, a disk with three prongs). Let E_1, \dots, E_n be the components of $E - E_0$, and suppose E_1 is the disk with three prongs. As before, there is a smooth disk Δ in $\partial_h N_{B^-} \cup S$ such that $\partial \Delta = \partial E_0$ and $\Delta \cup E_0$ bounds an embedded 3-ball. We can define F_i 's and \hat{F}_i 's as above. However, in this case, the \hat{F}_k that contains E_1 must be a monogon. After pushing this \hat{F}_k out of the 3-ball bounded by $\Delta \cup E_0$, we get a monogon with fewer intersection curves (with S), which gives a contradiction. □

- Remark 2.1** (1) Let B and B^- be as above. By Corollary 2.3, B and B^- have no disks of contact. Hence, if B^- fully carries a lamination, using the techniques in [6, 3] (see also section 3), we can construct a lamination fully carried by B . Then, by Proposition 1.1 (b), this lamination is an essential lamination.
- (2) Let B_1, \dots, B_m be a series of branched surfaces, L_i be the branch locus of B_i (for any i), and S_i ($i < m$) be a removable disk of B_i . Suppose $B_{i+1} = B_i - \text{int}(S_i)$ ($i < m$). If B_1 is a laminar branched surface, then by Lemma 2.1, we can inductively show that each B_i is a laminar branched surface. Moreover, as we point out above, if B_m fully carries a lamination, we can inductively construct a lamination for each B_i . For any laminar branched surface $B = B_1$, there always exist such a series of branched surfaces such that B_m is efficient. If we can construct a lamination carried by B_m , we can inductively extend this lamination to a lamination fully carried by $B = B_1$.
- (3) Although we used the hypothesis that S is a disk in the proof, Lemma 2.1 is still true if S is not a disk.

Definition 2.2 Let S_1 and S_2 be two surfaces or arcs in $N(B)$ that are transverse to the I -fibers of $N(B)$. We say that S_1 and S_2 are *parallel* if there is an embedding $H: S \times [1, 2] \rightarrow N(B)$ such that $H(S \times \{i\}) = S_i$ ($i = 1, 2$) and $H(\{x\} \times [1, 2])$ is a subarc of an I -fiber of $N(B)$ for any $x \in S$.

Definition 2.3 Let B be a branched surface and D be an embedded disk in $N(B)$ that is transverse to the I -fibers of $N(B)$. Suppose $\partial D \subset \pi^{-1}(L)$, where L is the branch locus of B . Then, every arc in ∂D has an induced direction that is consistent with the branch direction of the corresponding arc in L . We call D a *generalized sink disk* if the induced direction of every arc in ∂D points into D . Note that if $\pi^{-1}(L) \cap \text{int}(D) = \emptyset$, $\pi(D)$ is a sink disk.

Lemma 2.2 *Let B be a laminar branched surface. Then, $N(B)$ contains no generalized sink disk.*

Proof Suppose D is a generalized sink disk. We first show that there must be a subdisk of D , which we denote by D' , such that D' is a generalized sink disk, and $\pi|_{D'}$ is injective (ie, the intersection of each I -fiber of $N(B)$ with D' is either empty or a single point).

Let n be the maximal number of intersection points of D with any I -fiber of $N(B)$, and X_n be the union of I -fibers of $N(B)$ whose intersection with D

consists of n points. We assume $n > 1$, otherwise, $D' = D$. We use induction on n . Since the induced direction of every arc in ∂D points into D , $X_n \cap D$ is a collection of compact subsurfaces of D . Moreover, since n is maximal, the boundary of $X_n \cap D$ lies in $\pi^{-1}(L)$ with direction (induced from the branch direction of L) pointing into $X_n \cap D$. Let P_1, \dots, P_k be the components of $X_n \cap D$, and hence each P_i is a planar surface in D . We call a boundary circle of P_i the *outer boundary* of P_i if it bounds a disk in D that contains P_i . We denote the outer boundary of P_i by α_i ($i = 1, \dots, k$) and let D_i be the disk bounded by α_i in D . Hence, $P_i \subset D_i$. Without loss of generality, we can assume that α_1 is an inner most circle (among the α_i 's), ie, $D_i \not\subset D_1$ for any $i \neq 1$. Then, $\partial D_1 \subset \pi^{-1}(L)$ and the induced direction of every arc in ∂D_1 points into D_1 . Hence, D_1 is a generalized sink disk. Next, we show that we can assume the maximal number of intersection points of P_1 with any I -fiber of $N(B)$ is less than n .

Note that X_n can be considered as an I -bundle over a compact surface (if one collapses every I -fiber in X_n to a point, since n is maximal, one does not get any branching). Thus, if P_1 contains all n points of the intersection, X_n must be a twisted I -bundle over a nonorientable surface, $n = 2$, and P_1 double covers a nonorientable surface. If two inner boundary components, say c_1 and c_2 , of P_1 are two parallel curves in a vertical boundary component of the I -bundle X_n , we can replace the disk (in D) bounded by c_1 by a disk that is parallel to the disk (in D) bounded by c_2 . By this cutting and pasting, we can assume that P_1 is an annulus that double covers a Möbius band. Moreover, the outer boundary α_1 of P_1 bounds a disk that is parallel to the disk (in D) bounded by the inner boundary of P_1 . By capping α_1 off using this disk, we get an embedded 2-sphere that double covers a projective plane carried by B . Then, by applying the train track argument below to this 2-sphere, one either gets a generalized sink disk D' in this 2-sphere with $\pi|_{D'}$ injective, or gets a removable disk disjoint from a generalized sink disk and eventually has a contradiction similar to the argument below. Note that if we assume M to be irreducible here, M must be $\mathbb{R}P^3$ and it is easy to conclude that this case cannot happen. Hence, we may assume the maximal number of intersection points of P_1 with any I -fiber of $N(B)$ is less than n .

Since α_1 is innermost, the maximal number of intersection points of D_1 with any I -fiber of $N(B)$ must be less than n . Inductively, we can eventually find a generalized sink disk $D' \subset D$ such that $\pi|_{D'}$ is injective. Note that $\pi(D')$ is not necessarily a sink disk by definition because $\pi^{-1}(L) \cap \text{int}(D')$ may not be empty.

In the remaining part of the proof, we will show that there is a removable

disk S in B such that the fibered neighborhood of the branched surface $B^- = B - \text{int}(S)$ also contains a generalized sink disk. Let D' be a generalized sink disk such that $\pi|_{D'}$ is injective. Moreover, we may assume that D' contains no subdisk that is a generalized sink disk. Note that $\pi^{-1}(L) \cap \text{int}(D') \neq \emptyset$, otherwise, $\pi(D')$ is a sink disk which contradicts the hypothesis that B is a laminar branched surface.

We fix a normal direction for D' . For every point $x \in \text{int}(D')$, let J_x be the I -fiber of $N(B)$ that contains x . Then, $J_x - x$ has two components. According to the fixed normal direction of D' , we say that the points in one component of $J_x - x$ are on the positive side of x , and points in the other component of $J_x - x$ are on the negative side of x . Let G be the union of $x \in D'$ such that $J_x \subset \pi^{-1}(L)$ and $\partial_v N(B) \cap J_x$ contains a component on the positive side of x . Note that if $\pi(J_x)$ is a double point of L , $\partial_v N(B) \cap J_x$ consists of two disjoint arcs. Then, by the construction of G and the local model (Figure 1.2) of a branched surface, $G \cup \partial D'$ is a trivalent graph and each edge has a direction induced from the branch direction. As shown in Figure 2.3, this trivalent graph $G \cup \partial D'$ can be deformed into a transversely oriented train track τ according to the directions of the edges in G . Since the direction of every arc in $\partial D'$ points into D' and τ is transversely oriented, $\partial D'$ is a smooth circle in τ . Note that, by choosing an appropriate normal direction for D' , we can assume $G \neq \emptyset$, since $\pi^{-1}(L) \cap \text{int}(D') \neq \emptyset$. By a standard index argument, $D' - \tau$ must have a smooth disk component, ie, there is a smooth circle in τ which is the boundary of the closure of a disk component of $D' - \tau$. We denote this disk with smooth boundary by Δ . So, $\partial \Delta \subset \tau$ and the directions of the arcs in $\partial \Delta$ either all point inwards or all point outwards, as τ is transversely oriented according to the branch direction. Since we have assumed that D' contains no subdisk that is a generalized sink disk, the direction of $\partial \Delta$ must point out of Δ , and hence $\Delta \subset \text{int}(D')$. Therefore, by our construction of G , Δ must be parallel to a disk component of $\partial_h N(B)$ (see Definition 2.2 for the definition of parallel). After an isotopy in a small neighborhood of Δ , we can assume that Δ is a disk component of $\partial_h N(B)$. Since $\partial_h N(B)$ is incompressible, Δ must be a horizontal boundary component of a $D^2 \times I$ region of $M - \text{int}(N(B))$. Let $K = D^2 \times I$ ($I = [-1, 1]$) be the component of $M - \text{int}(N(B))$ such that $\Delta = D^2 \times \{-1\} \subset \partial K$. We denote $D^2 \times \{1\} \subset \partial K$ by Δ' . Then, we can isotope D' across K in a small neighborhood of K . In other words, $(D' - \Delta) \cup A \cup \Delta'$, where $A = \partial D^2 \times I \subset \partial K$ is the vertical boundary of K , is an embedded disk in $N(B)$ that is isotopic (in M) to D' . Then, by a small perturbation near A , we can isotope the disk $(D' - \Delta) \cup A \cup \Delta'$ to be transverse to the I -fibers of $N(B)$. We denote the disk after this perturbation by D'' . Clearly D'' is

isotopic to D' . Moreover, we can assume that $\Delta' \subset D''$ and D' coincides with D'' outside a small neighborhood of Δ . The picture of $D' \cup D''$ is like a disk with an “air bubble” inside which corresponds to the $D^2 \times I$ region K .

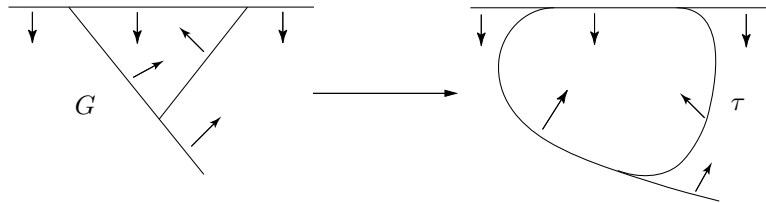

Figure 2.3

Let G' be the union of $x \in \text{int}(\Delta)$ such that $J_x \subset \pi^{-1}(L)$ and $\partial_v N(B) \cap J_x$ contains a component on the negative side of x . Then, $G' \cup \partial\Delta$ is also a trivalent graph, and each edge of G' has a direction induced from the branch direction of the corresponding arc in L . Note that $G' \cup \partial\Delta = \Delta \cap \pi^{-1}(L)$, since $\Delta \subset \partial_h N(B)$. As before, we can deform $G' \cup \partial\Delta$ into a transversely oriented train track τ' . By a standard index argument, $\Delta - \tau'$ must have a smooth disk component, ie, there is a smooth circle in τ' which is the boundary of the closure of a component of $\Delta - \tau'$. We denote this disk with smooth boundary by δ . Since τ' is transversely oriented and $\partial\delta$ is a smooth circle in τ' , the directions of the arcs in $\partial\delta$ either all point into δ or all point out of δ . If the direction of $\partial\delta$ points into δ , since $G' \cup \partial\Delta = \Delta \cap \pi^{-1}(L)$, $\pi(\delta)$ is a sink disk, which gives a contradiction. Thus, $\pi(\delta)$ must be a branch of B with branch direction of each boundary arc pointing outwards. Moreover, since $\pi|_{D'}$ is injective, $\pi(\delta)$ is a removable disk.

Next, we show that $\pi(D'')$ does not contain $\pi(\text{int}(\delta))$, and hence D'' is carried by the branched surface $B - \text{int}(\delta)$, as δ is removable. We first show that there is no I -fiber of $N(B)$ that intersects both Δ' and $\text{int}(\delta)$ (note that $\Delta' \subset D''$ and $\delta \subset \Delta \subset D'$). Otherwise, since $\delta \cap \pi^{-1}(L) = \partial\delta$, δ is parallel to a subdisk of Δ' . As $\partial\delta \subset \partial\Delta \cup G'$, we have two cases: one case is $\partial\delta = \partial\Delta$ and the other case is $\partial\delta \cap G' \cap \text{int}(\Delta) \neq \emptyset$. If $\partial\delta = \partial\Delta$, we have $\delta = \Delta$ and $G' = \emptyset$. Then, since δ is parallel to a subdisk of Δ' and $G' = \emptyset$, $\Delta = \delta$ is parallel to a subdisk in the interior of Δ' . Since Δ and Δ' are the two components of the horizontal boundary of the $D^2 \times I$ region K , K forms a standard Reeb component, which gives a contradiction. In fact, in this case, $B - \pi(\text{int}(\delta))$ is a branched surface with one horizontal boundary component a torus that bounds a solid torus in M . Thus, $\partial\delta \cap G' \cap \text{int}(\Delta) \neq \emptyset$. As δ is parallel to a subdisk of Δ' and $\delta \subset \Delta$, there is an I -fiber J of $N(B)$ that intersects both Δ' and $\partial\delta \cap \text{int}(\Delta)$. Note

that since Δ is a disk component of $\partial_h N(B)$ and $J \cap \text{int}(\Delta) \neq \emptyset$, one endpoint of J must lie in $\text{int}(\Delta)$. As $\partial\delta \subset \pi^{-1}(L)$, $J \cap \partial_v N(B) \neq \emptyset$. Moreover, since Δ' is also a disk component of $\partial_h N(B)$ and since δ is parallel to a subdisk of Δ' , $J \cap \partial\Delta' \neq \emptyset$. Then, as Δ and Δ' are the two horizontal boundary components of the $D^2 \times I$ region K , $J \cap \partial\Delta' \neq \emptyset$ implies $J \cap \partial\Delta \neq \emptyset$. Thus, $J \cap \text{int}(\Delta) \neq \emptyset$ and $J \cap \partial\Delta \neq \emptyset$, and hence $J \cap \Delta$ contains at least two points, which contradicts our assumption that $\pi|_{D'}$ is injective. Therefore, there is no I -fiber of $N(B)$ that intersects both Δ' and $\text{int}(\delta)$.

Since $\pi|_{D'}$ is injective and since there is no I -fiber of $N(B)$ that intersects both Δ' and $\text{int}(\delta)$, by our construction of D'' , there is no I -fiber of $N(B)$ that intersects both D'' and $\text{int}(\delta)$. Since $\pi(\delta)$ is a removable disk, D'' is a generalized sink disk in $N(B^-)$, where B^- is the branched surface $B - \pi(\text{int}(\delta))$. Note that $\pi|_{D''}$ is not necessarily injective.

Now, D'' is a generalized sink disk in a fibered neighborhood of the branched surface $B^- = B - \pi(\text{int}(\delta))$. We can then apply the same argument above to $B^- = B - \pi(\text{int}(\delta))$, replacing B and D by B^- and D'' respectively. As in the argument above, the existence of a generalized sink disk always yields a removable disk (such as the δ above). However, if we keep eliminating these removable disks, we eventually get an efficient laminar branched surface that still has a generalized sink disk. This gives a contradiction. \square

Remark 2.2 It is easy to see from the proof of Lemma 2.2 that if a branched surface B contains a trivial bubble but has no sink disk, then B must contain a removable disk.

An easy corollary (Corollary 2.3) of Lemma 2.2 is that there is no disk of contact in a laminar branched surface. Figure 1.3 (a) is the simplest example of a disk of contact. By definition (see condition 4 in Proposition 1.1), a disk of contact is an embedded disk $D \subset N(B)$ such that D is transverse to the I -fibers of $N(B)$ and $\partial D \subset \partial_v N(B)$. If $\pi^{-1}(L) \cap \text{int}(D) \neq \emptyset$, $\pi(D)$ is not even a branch of B . For example, we can add some branches to Figure 1.3 (a) in a complicated way, but it can still be a disk of contact by definition. In general, it is not obvious that the condition of no sink disks implies that there is no disk of contact, although Figure 1.3 (a) is an example of sink disk.

Corollary 2.3 *A laminar branched surface does not contain any disk of contact.*

Proof By the definition of disk of contact in Proposition 1.1, a disk of contact is a generalized sink disk and Corollary 2.3 follows from Lemma 2.2. \square

The next two lemmas will be used in section 4, and the proofs are essentially the same as the proof of Lemma 2.2.

Lemma 2.4 *Let B be a laminar branched surface. Then, $N(B)$ contains no disk D with the following properties:*

- (1) D is an embedded disk in $N(B)$ that is transverse to the I -fibers of $N(B)$;
- (2) $\pi(\partial D)$ is a nontrivial simple closed curve in $B - L$.

Proof We first show that if $N(B)$ contains such a disk D , then D has a subdisk E such that $\pi(\partial E) = \pi(\partial D)$ and $\pi(\partial E) \cap \pi(\text{int}(E)) = \emptyset$. Since $\pi(\partial D)$ is a nontrivial simple closed curve in $B - L$, $D \cap \pi^{-1}(\pi(\partial D))$ is a union of simple closed curves in D . Let $E \subset D$ be a disk bounded by an innermost (among curves in $D \cap \pi^{-1}(\pi(\partial D))$) simple closed curve. Then, since ∂E is innermost, $\pi(\partial E) \cap \pi(\text{int}(E)) = \emptyset$. Therefore, we may assume that our disk D has an additional property that $\pi(\partial D) \cap \pi(\text{int}(D)) = \emptyset$.

If $\pi|_D$ is not injective, since $\pi(\partial D) \cap \pi(\text{int}(D)) = \emptyset$, similar to the proof of Lemma 2.2, there must be a subdisk in $\text{int}(D)$ that is a generalized sink disk, which contradicts Lemma 2.2. More precisely, let n be the maximal number of intersection points of D with any I -fibers of $N(B)$, and X_n be the union of I -fibers of $N(B)$ whose intersection with D consists of n points. Since $\pi|_D$ is not injective, $n > 1$. Then, since $\pi(\partial D) \cap \pi(\text{int}(D)) = \emptyset$ and $\pi|_{\partial D}$ is injective, $X_n \cap D$ is a collection of compact subsurfaces of $\text{int}(D)$. Moreover, since n is maximal, the boundary of $X_n \cap D$ lies in $\pi^{-1}(L)$ with direction (induced from the branch direction of L) pointing into $X_n \cap D$. Thus, the outer boundary of a component of $X_n \cap D$ bounds a generalized sink disk in $\text{int}(D)$, which contradicts Lemma 2.2. Therefore, $\pi|_D$ must be injective.

Since $\pi|_D$ is injective, as in the proof of Lemma 2.2, we can find a removable disk δ in $\text{int}(D)$. Moreover, we can find another disk D' , which we get by isotoping D across a $D^2 \times I$ region, such that $\partial D = \partial D'$ and $\pi(D') \cap \pi(\text{int}(\delta)) = \emptyset$.

Therefore, D' satisfies the two hypotheses (for D) in the lemma, and D' is carried by the branched surface $B - \text{int}(\delta)$. Then, we can apply the same argument to the branched surface $B - \text{int}(\delta)$, replacing B and D by $B - \text{int}(\delta)$ and D' respectively. Similar to the proof of Lemma 2.2, we get a contradiction once the branched surface becomes efficient. \square

Lemma 2.5 *Let B be a laminar branched surface. Then, $N(B)$ contains no disk D with the following properties:*

- (1) D is an embedded disk in $N(B)$ that is transverse to the I -fibers of $N(B)$;
- (2) $\pi(\partial D)$ is a simple closed curve in B that is transverse to L ($L \cap \pi(\partial D) \neq \emptyset$) and does not contain any double point of L ;
- (3) the points in $L \cap \pi(\partial D)$ have coherent branch directions along $\pi(\partial D)$ (clockwise or counterclockwise), where we consider the branch direction of each point in $L \cap \pi(\partial D)$ to be along $\pi(\partial D)$, ie, a small neighborhood of $\pi(\partial D)$ is either a branched annulus or a branched Möbius band with coherent branch direction as shown in Figure 4.4.

Proof The proof is very similar to the proof of Lemma 2.4. We first show that $D \cap \pi^{-1}(\pi(\partial D))$ is a union of simple closed curves in D . Since $\pi^{-1}(\pi(\partial D))$ is a compact set, $D \cap \pi^{-1}(\pi(\partial D))$ is a union of circles or compact arcs in D . If $D \cap \pi^{-1}(\pi(\partial D))$ has a component that is a compact arc, which we denote by α , then by our hypothesis that $\pi|_{\partial D}$ is injective, $\partial\alpha$ must lie in $\pi^{-1}(L)$ with direction (consistent with the branch direction) pointing into α . However, this is impossible because the points in $L \cap \pi(\partial D)$ have coherent branch directions along $\pi(\partial D)$, in other words, there is no subarc of $\pi(\partial D)$ with endpoints in L and branch directions of both endpoints pointing into this arc. Thus, $D \cap \pi^{-1}(\pi(\partial D))$ is a union of simple closed curves in D . Let $E \subset D$ be a disk bounded by an innermost (among curves in $D \cap \pi^{-1}(\pi(\partial D))$) simple closed curve. Since ∂E is innermost, $\pi(\partial E) \cap \pi(\text{int}(E)) = \emptyset$. Therefore, similar to the proof of Lemma 2.4, we can assume that our disk D has an additional property that is $\pi(\partial D) \cap \pi(\text{int}(D)) = \emptyset$.

Thus, as in the proof of Lemma 2.4, $\pi|_D$ must be injective. Then, as in the proof of Lemma 2.2, we can construct a train track $\tau \subset \text{int}(D)$ as follows. We first fix a normal direction for D . For every point $x \in \text{int}(D)$, let J_x be the I -fiber of $N(B)$ that contains x . Then, $J_x - x$ has two components. According to the fixed normal direction of D , we say that the points in one component of $J_x - x$ are on the positive side of x , and points in the other component of $J_x - x$ are on the negative side of x . Let G be the union of $x \in \text{int}(D)$ such that $J_x \subset \pi^{-1}(L)$ and $\partial_v N(B) \cap J_x$ contains a component on the positive side of x . Then, G is a trivalent graph and each edge has a direction induced from the branch direction. As shown in Figure 2.3, this trivalent graph G can be deformed into a transversely oriented train track τ according to the directions of the edges in G . By fixing an appropriate normal direction for D , we can assume that $\tau \neq \emptyset$.

Since the branch directions of points in $L \cap \pi(\partial D)$ are coherent along $\pi(\partial D)$ and since τ is transversely oriented according to the branch direction, there is

no arc carried by τ with both endpoints in ∂D . Then, similar to the argument in the Poincaré-Bendixson theorem [17], τ must carry a circle that bounds a disk in $\text{int}(D)$. Hence, there must be a smooth disk whose boundary is a smooth circle in τ and whose interior is a component of $\text{int}(D) - \tau$. As in the proof of Lemma 2.2, we can find a removable disk in $\text{int}(D)$, and we can get another disk D' (with $\partial D = \partial D'$) by isotoping D across a $D^2 \times I$ region K of $M - \text{int}(N(B))$. Moreover, $\pi(D')$ does not pass through the removable disk δ .

Then, we can apply the argument above again to the branched surface $B - \text{int}(\delta)$, replacing B and D by $B - \text{int}(\delta)$ and D' respectively. As in the proof of Lemma 2.2, we get a contradiction once the branched surface becomes efficient. \square

3 Extending laminations

In this section, we show that, in most cases, we can extend a lamination from the vertical boundary of an I -bundle over a surface to its interior. The results in this section appear in [6] implicitly, and most of the proof we give here is in fact a modification of the arguments in [6].

Let B be a branched surface carrying a lamination λ . Suppose ∂B is a union of circles. By ‘blowing air’ into leaves, ie, replacing leaves by I -bundles over these leaves and deleting the interior of these I -bundles, we can assume that λ is nowhere dense in $N(B)$. For simplicity, we will assume the intersection of λ with every interval fiber is a Cantor set.

Let $I = [-1, 1]$ and $\text{Homeo}^+(I)$ be the group of self-homeomorphism of I fixing endpoints. The next lemma is well-known, and the proof is easy (see also [2]).

Lemma 3.1 *Any map $f \in \text{Homeo}^+(I)$ is a commutator, ie, there are $g, h \in \text{Homeo}^+(I)$ such that $f = g \circ h \circ g^{-1} \circ h^{-1}$.*

Proof As the fixed points of f is a closed set in I and the complement of a closed set is a union of intervals, it suffices to prove Lemma 3.1 for maps without fixed points in the interior of I . Hence, we may assume that $f(z) > z$ for any $z \in (-1, 1)$ (the case $f(z) < z$ is similar). It suffices to show that f is conjugate to any map $p \in \text{Homeo}^+(I)$ with the property that $p(z) > z$ for any $z \in (-1, 1)$.

Let x be an arbitrary point in the interior of I . As $f(x) > x$ and $p(x) > x$, the intervals $[f^n(x), f^{n+1}(x)]$ ($n \in \mathbb{Z}$, $f^0(x) = x$ and $f^1 = f$) partition the interval I , and the intervals $[p^n(x), p^{n+1}(x)]$ ($n \in \mathbb{Z}$) also partition the interval I . Let $q_0: [x, f(x)] \rightarrow [x, p(x)]$ be any homeomorphism fixing endpoints. We define $q_n = p^n \circ q_0 \circ f^{-n}: [f^n(x), f^{n+1}(x)] \rightarrow [p^n(x), p^{n+1}(x)]$. These maps q_n fit together to give a homeomorphism $q: [-1, 1] \rightarrow [-1, 1]$, and it follows from the definition of q_n that $f = q^{-1} \circ p \circ q$, ie, f and p are conjugate. \square

The following lemma is an application of Lemma 3.1.

Lemma 3.2 *Let c be a circular component of ∂B . If B fully carries a lamination, then the new branched surface constructed by gluing B and a once-punctured orientable surface with positive genus along c also carries a lamination.*

Proof Let $A = \pi^{-1}(c)$, where $\pi: N(B) \rightarrow B$ is the collapsing map. Then $\lambda|_A$ is a one-dimensional lamination in the annulus $\text{int}(A) = S^1 \times \text{int}(I)$, and $A - \lambda|_A$ is a union of I -bundles. Each I -bundle is homeomorphic to either $\mathbb{R} \times I$ or $S^1 \times I$. We trivially extend $\lambda|_A$ to a (one-dimensional) foliation of $\text{int}(A)$ by associating each I -bundle with its canonical product foliation. Assume that the foliation of $\text{int}(A)$ constructed above is the suspension of a homeomorphism $f: \text{int}(I) \rightarrow \text{int}(I)$

Let S be the once-punctured surface that we glue to B . We consider the I -bundle $S \times I$ and $A = \partial S \times I = c \times I$. By Lemma 2.1, there exist $a_1, b_1, \dots, a_g, b_g$ such that $f = [a_1, b_1] \circ \dots \circ [a_g, b_g]$, where a_i, b_i are homeomorphisms of $\text{int}(I)$ and g is the genus of S . By attaching thick bands foliated by the suspensions of a_i 's and b_i 's to a $\text{disk} \times I$ with the trivial product foliation, we can build $S \times I$. The foliations of the thick band and the disk can be glued together according to the identity map of I . This gives us a foliation of $S \times I$ whose boundary on $\partial S \times I$ is the suspension of f . In other words, we can extend the foliation of A to a foliation of $S \times I$.

Then by 'blowing air' into leaves, we can change the foliation of $S \times I$ to a nowhere dense lamination ν such that $\lambda|_A$ is a sub-lamination of $\nu|_A$. Indeed, by our construction of the foliation of A , $\nu|_A$ is just $\lambda|_A$ plus some parallel nearby leaves. Now we change the lamination λ in $N(B)$ by adding some parallel leaves so that the new lamination restricted to A is the same as $\nu|_A$. Gluing up the two laminations, we get a lamination fully carried by the new branched surface. \square

Remark 3.1 The operations we used on laminations and foliations in the proof above are standard, see operations 2.1.1, 2.1.2, 2.1.3 in [6].

Corollary 3.3 *Let c_1, c_2, \dots, c_n be n circular components of ∂B . If B fully carries a lamination, then the new branched surface constructed by gluing a non-planar orientable surface with n boundary components along c_i 's fully carries a lamination.*

Proof We first glue a planar surface with $n + 1$ boundary components to B . By adding thickened bands between c_1, c_2, \dots, c_n , we can trivially extend the lamination through the planar surface. Then we can glue a once-punctured surface to the $(n + 1)$ th boundary component of the planar surface and the result follows from Lemma 3.2. \square

The next Lemma is a modification of operation 2.4.4 in [6].

Lemma 3.4 *Let c_1 and c_2 be two circular components of ∂B . If B fully carries a lamination without disk leaves, then the new branched surface constructed by gluing an annulus between c_1 and c_2 carries a lamination.*

Proof Let the vertical boundary components of $N(B)$ along c_1 and c_2 be annuli A_1 and A_2 , $A_i = c_i \times [-1, 1]$. What we want to do is to add some leaves to λ so that the restriction of the new lamination to A_1 and A_2 are the same, hence we can glue them together.

First, we replace every boundary leaf of λ by an embedded I -bundle over this leaf, then we delete the interior of the I -bundle. We still call this lamination λ . After this operation, $\lambda|_{A_i}$ has two pairs of isolated circles near ∂A_i .

Then we isotope λ such that $\lambda|_{c_1 \times [-1, 0]}$ is an isolated circle, say e_1 , $e_1 = c_1 \times \{-1\}$, and $\lambda|_{c_2 \times [0, 1]}$ is also an isolated circle, say e_2 , $e_2 = c_2 \times \{1\}$. Let L_1 and L_2 be the leaves in λ corresponding to e_1 and e_2 respectively. Clearly L_1 and L_2 are orientable surfaces. Then we add two leaves L'_1, L'_2 to λ which are parallel and close to L_1, L_2 respectively such that $L_i \cup L'_i$ bounds a product region in $N(B)$. This is actually the same operation as replacing L_i by an I -bundle and deleting the interior of the I -bundle. Let $L'_i \cap A_i = e'_i$, $i = 1, 2$. Let the annulus in A_i bounded by $e'_1 \cup c_1 \times \{1\}$ be J_1 , the one bounded by $c_2 \times \{-1\} \cup e'_2$ be J_2 , the one bounded by $e'_1 \cup e_1$ be K_1 , and the one bounded by $e'_2 \cup e_2$ be K_2 .

Before we proceed, we point out a fact that is the following. Let $F \times I$ be a product region over a surface F (F could be non-compact). Suppose F is not

a disk and C is a boundary component of F . Then any foliation on $C \times I$ can be extended to the whole of $F \times I$. The proof is easy. If F has another boundary component or an end, the construction is trivial, and otherwise, it follows from Lemma 3.1.

Case 1 One of L_1 and L_2 (say L_1) is not a compact planar surface with boundary on $A_1 \cup A_2$.

Case 1a L_2 is not a compact planar surface with boundary on $A_1 \cup A_2$ either.

We foliate J_1 and J_2 as before, ie, foliate all annular components of $A_i - \lambda|_{A_i}$ by circles and other components by adding spirals coherent to $\lambda|_{A_i}$. Then we foliate K_1 with the same foliation of J_2 and K_2 with the same foliation of J_1 . Now the foliation on A_1 and A_2 are the same. By our assumption on L_1 and L_2 , we can extend the foliation of K_i to the product region bounded by $L_i \cup L'_i$. Then, as before, by ‘blowing air’ into leaves we can change the foliation on A_i to be a nowhere dense lamination that contains $\lambda|_{A_i}$ as a sublamination. By our construction of foliation on A_i , the complement of $\lambda|_{A_i}$ is a product lamination. After possibly replacing every leaf by a product lamination of *leaf* \times {a cantor set}, we can extend the lamination on A_i to $N(B)$. Now the new lamination in $N(B)$ when restricted to A_1 and A_2 , gives the same lamination.

Case 1b L_2 is a compact planar surface with boundary on $A_1 \cup A_2$, but $L_2 \cap J_1 = \emptyset$.

This case is very similar to Case 1a. We first foliate J_1 in the same way as before, then give K_2 the same foliation as that of J_1 . Since L_2 is not a disk, we can extend the foliation on K_2 to the product region bounded by $L_2 \cup L'_2$. Now we might have changed the lamination on J_2 . We can extend the (new) lamination on J_2 to a foliation as before and give K_1 the same foliation as J_2 , and the rest is as in Case 1a.

Before we proceed, we quote the Lemma 2.1 of [6].

Lemma 3.5 *Let f, h, σ, τ be either homeomorphisms of I fixing endpoints or maps of the empty set.*

- i) *There exists a homeomorphism g conjugate to the concatenation of f, g, h .*
- ii) *There exists homeomorphisms g, μ of I such that μ is conjugate to the concatenation of f, g^{-1} and h , and g is conjugate to the concatenation of σ, μ^{-1} and τ .*

Remark 3.2 Let A be an annulus and $\mathcal{F}_1, \mathcal{F}_2$ be two foliations on $\partial A \times I$. Suppose \mathcal{F}_i is a suspension of a homeomorphism of I fixing endpoints, say f_i , $i = 1, 2$. Then we can extend \mathcal{F}_1 and \mathcal{F}_2 to a foliation of $A \times I$ if and only if f_1 is conjugate to f_2 .

Case 1c L_2 is a compact planar surface and has some boundary component E in J_1 .

Since $L'_2 \cup L_2$ bounds a product region, L'_2 has a boundary component E' and $E' \cup E$ bounds an annulus J' in J_1 . We first extend the lamination on $J_1 - J'$ to a foliation as before, and assume that this foliation is a suspension of maps f and h (since $J_1 - J'$ consists of two annuli). Then we construct the same foliation, which is the suspension of g , on J' and K_2 , where g is as in Lemma 3.5 (i). By Lemma 3.5 (i), K_2 and J_1 have the same foliation. So we can extend it to a foliation in the product region bounded by $L_2 \cup L'_2$, and the rest is the same as Case 1b.

Case 2a Both L_1 and L_2 are planar and some non- e_1 component of ∂L_1 is disjoint from J_1 .

We first foliate J_1 as before, then give K_2 the same foliation as that of J_1 and extend it to a foliation of the product region bounded by $L_2 \cup L'_2$. Applying Lemma 3.5 (i), if necessary, we can construct the same foliation on K_1 and J_2 such that it can be extended to a foliation in the product region bounded by $L_1 \cup L'_1$ (using our assumption of ∂L_1).

Case 2b Both L_1 and L_2 are compact planar surfaces and all the non- e_i components of ∂L_i are in J_i , $i = 1, 2$.

Let d_i be another boundary component of L_i and d'_i be the corresponding boundary component of L'_i . Then $d_i \cup d'_i$ bounds a annulus J'_i in J_i , $i = 1, 2$. We extend the lamination on $J_i - J'_i$ as before, and foliate K_1 by the suspension of a map g , J'_1 by the suspension of map g^{-1} , K_2 by the suspension of a map μ , and J'_2 by the suspension of map μ^{-1} . By our assumption on L_1 and L_2 , we can extend the foliation to the product region bounded by $L_i \cup L'_i$, $i = 1, 2$. Using Lemma 3.5 (ii), we can find maps g and μ such that the foliation on J_i is the same as the foliation on K_j , $i \neq j$, and the rest is the same as before. \square

Lemma 3.6 Let c_1, c_2, \dots, c_n be n circular components of ∂B . If B fully carries a lamination without disk leaves, then the new branched surface constructed by gluing a non-disk surface with n boundary components along c_i 's fully carries a lamination.

Proof Let S be the surface that we glue to B . The case that S is orientable follows from the lemmas above. As in the previous arguments, we only need to consider case that S is a Möbius band.

Let $c_1 = \partial S$ and $A = c_1 \times [-1, 1]$. As in the proof of Lemma 3.4, by replacing a boundary leaf by an I -bundle over this leaf and deleting the interior of the I -bundle, we can assume that $c_1 \times \{-1, 0, 1\} \subset \lambda|_A$ are isolated circles. Since the ambient manifold M is assumed to be orientable, we can glue a twisted I -bundle over a Möbius band, which we denote by U , to $N(B)$ along $A = c_1 \times [-1, 1]$. Then, $c_1 \times \{0\}$ bounds a Möbius band u in U . Topologically, $U - u$ is a fibered neighborhood of an annulus with each fiber a half open and half closed interval, ie, $U - u = \text{annulus} \times [a, b)$. The vertical boundary of $U - u$ is the union of $c_1 \times [-1, 0)$ and $c_1 \times (0, 1]$. By Lemma 3.4, we can extend the lamination through $U - u$ and the Lemma holds. \square

4 Constructing laminations carried by branched surfaces

Suppose B is a laminar branched surface. Let L' be a graph in B , whose local picture is as shown in Figure 4.1 (a). We can also describe L' as follows. Let l_1, l_2, \dots, l_s be the boundary curves of the surface $\partial_h N(B)$. For each l_i , we take a simple closed curve l'_i in the interior of $\partial_h N(B)$ that is close and parallel to l_i . Let $DL = \cup_{i=1}^s \pi(l'_i)$. Near every double point of L , the intersection of DL with L consists of two points. Then, we add some short arcs connecting these intersection points to DL , as shown in Figure 4.1 (a), and the union of DL and these short arcs is L' .

Let $K_{L'}$ be a closed small regular neighborhood of L' in M . Let $P(L') = B \cap K_{L'}$, whose local picture is as shown in Figure 4.1 (b). We call $B \cap \partial K_{L'}$ the *boundary* of the branched surface $P(L')$, and denote $B \cap \text{int}(K_{L'})$ by $\text{int}(P(L'))$. The branch locus of the branched surface $P(L')$ is a union of simple arcs, as shown in Figure 4.1 (b).

There is a one-one correspondence between the components of $B - L$ and the components of $B - P(L')$. For each branch D of B , we denote the corresponding component of $B - \text{int}(P(L'))$ by D^B . For example, the shaded branch in Figure 4.2 (a) corresponds to Figure 4.2 (b), which is a component of $B - \text{int}(P(L'))$. The relation between D and D^B can also be described as follows. We consider $N(B)$ as a fibered regular neighborhood of B , and B lies in the interior of $N(B)$ such that every I -fiber of $N(B)$ is transverse to B . To

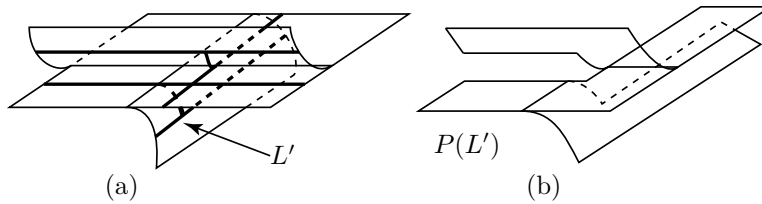

Figure 4.1

simplify notation, we do not distinguish the B in the interior of $N(B)$ and the B as the image of the map $\pi: N(B) \rightarrow B$, which collapses every I -fiber of $N(B)$ to a point. There is a natural one-one correspondence between components of $B - L$ and components of $N(B) - \pi^{-1}(L)$. For any branch D of B , $int(D)$ is a component of $B - L$, and the corresponding component of $N(B) - \pi^{-1}(L)$ is an I -bundle over $int(D)$, whose intersection with the B lying in $int(N(B))$ is the same as the component of $B - P(L')$ that corresponds to $int(D)$.

For any branch D of B , we denote by $N_B(D)$ the closure in the path metric of the component of $N(B) - \pi^{-1}(L)$ that corresponds to D . Thus, $N_B(D)$ is an I -bundle over D with a bundle structure induced from $N(B)$. The vertical boundary of $N_B(D)$ is bundle isomorphic to $\partial D \times I$, and we can identify $N_B(D) - \partial D \times I$ with the component of $N(B) - \pi^{-1}(L)$ that corresponds to D . By our argument above, $B \cap (N_B(D) - \partial D \times I)$ is the same as the component of $B - P(L')$ corresponding to D . Thus, we can assume that D^B , the corresponding component of $B - int(P(L'))$ lies in $N_B(D)$ with $\partial D^B \subset \partial D \times I$.

We can reconstruct $N(B)$ by gluing all the $N_B(D)$'s (for all the branches of B) together along their vertical boundaries, and simultaneously, those D^B 's (lying in $N_B(D)$'s) are glued together to form B . Moreover, the gluing (for D^B 's) above is essentially the same as gluing the D^B 's and $P(L')$ together to form B .

Now, we let D be a disk branch of B , and we identify $N_B(D)$ and $D \times I$. Let $O_D = \{E \mid E \text{ is an edge of } \partial D \text{ with branch direction pointing outwards}\}$. For each edge $E \in O_D$, $D^B \cap (E \times I)$ (where $E \times I \subset D \times I = N_B(D)$) must be one of the three patterns shown in Figure 4.3 (b) by our construction. In particular, let p be the midpoint of E , $\{p\} \times I \subset E \times I$ intersects $D^B \cap (E \times I)$ in a single point. The train track in Figure 4.3 (a) is a picture of the intersection of D^B with $\partial D \times I$ (the shaded annulus), where D is as in Figure 4.2 (a).

The next proposition is an important observation for our construction. The notation used is the same as that in the discussion above.

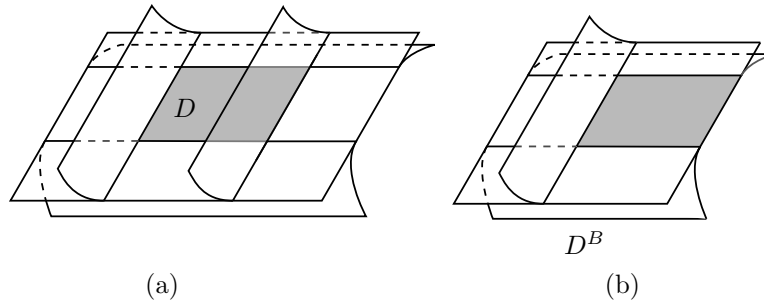

Figure 4.2

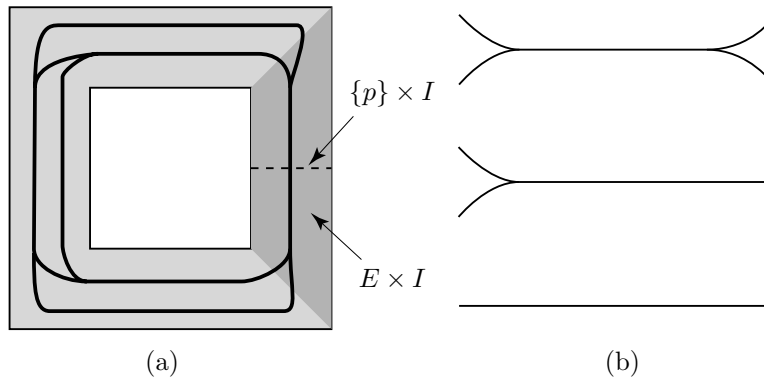

Figure 4.3

Proposition 4.1 *Let $E \in O_D$ and p be the midpoint of E . Then, as shown in Figure 4.3 (a), the I -fiber $\{p\} \times I$ of $N_B(D) = D \times I$ intersects B in a single point. Given any 1-dimensional lamination μ carried by the train track $D^B \cap \partial N_B(D)$, where $\mu \subset \partial D \times I$ is transverse to each I -fiber of $\partial D \times I$, we can change the lamination μ near $\{p\} \times I$ to get a new lamination μ' carried by $D^B \cap \partial N_B(D)$ such that all the leaves in μ' are circles, and hence μ' can be extended to a (2-dimensional) product lamination carried by D^B .*

Proof The proof is easy. We cut $\partial D \times I$ along $\{p\} \times I$. Then μ is cut into a collection of compact arcs. We can re-glue them along $\{p\} \times I$ in such a way that these arcs close up to become circles. Since the intersection of $\{p\} \times I$ and ∂D^B is a single point, the new (1-dimensional) lamination is still carried by ∂D^B . □

Now we are in position to construct a lamination carried by B .

The first step is to construct a lamination with boundary carried by $P(L')$. For each branch of $P(L')$, say S , we construct a product lamination $\{a \text{ cantor}$

set $\} \times S$. Since the branch locus of $P(L')$ does not have double points, by gluing together finitely many $\{cantor\ sets\} \times I$'s along the branch locus of $P(L')$, one can easily construct a lamination fully carried by $P(L')$. What we want to do next is to modify this lamination so that it can be extended to $B - int(P(L'))$, which is the union of D^B 's for all the branches.

Let D_1, D_2, \dots, D_n be all the disk branches of $B - L$. Since there is no sink disk, any disk D_i has a boundary edge, say E_i , with direction pointing outwards. Locally there are 3 branches incident to E_1 . If the branch to which the branch direction of E_1 points is a disk, say it is D_2 , we denote $D_1 \cup D_2$ by $D_1 \rightarrow D_2$. Note that E_1 is also a boundary edge of D_2 with branch direction points into D_2 . D_2 also has a boundary edge, say E_2 , with direction pointing outwards. If the branch to which E_2 points is a disk, say it is D_3 , we denote $D_1 \cup D_2 \cup D_3$ by $D_1 \rightarrow D_2 \rightarrow D_3$. Note that the branch direction of E_2 points out of D_2 and points into D_3 . We proceed in this manner. We call $D_1 \rightarrow D_2 \rightarrow \dots \rightarrow D_k$ a *chain* if $D_i \neq D_j$ for any $i \neq j$, and call it a *cycle* if $D_1 = D_k$ and $D_1 \rightarrow \dots \rightarrow D_{k-1}$ is a chain. We say that two cycles are disjoint if there is no disk branch appearing in both cycles. We can decompose the union of disk branches of $B - L$ into a collection of finitely many disjoint cycles and finitely many chains that connect these cycles and the non-disk branches. Moreover, we can assume that the union of all the disk branches in those chains does not contain any cycle, otherwise we can increase the number of disjoint cycles. Note that a disk branch can belong to more than one chain, but it can neither belong to more than one cycle nor belong to both a cycle and a chain.

Remark 4.1 $D_1 \rightarrow D_1$ could be a cycle.

The next step is to modify the lamination and extend it through all the chains. For any chain $D_1 \rightarrow D_2 \rightarrow \dots \rightarrow D_k$, we consider $N_B(D_i)$ and D_i^B , $i = 1, 2, \dots, k$. There is a one-dimensional lamination carried by ∂D_1^B , which is induced from the boundary of the lamination carried by $P(L')$. By Proposition 4.1, we can cut $\partial D_1 \times I$ along $\{p\} \times I$ ($p \in E_1$) and re-glue it so that the one-dimensional lamination carried ∂D_1^B is a union of circles. There is an arc l properly embedded in a branch of $P(L')$ that corresponds to E_1 , such that one endpoint of l is p (in Proposition 4.1) and the other endpoint of l is in ∂D_2^B . Moreover, we can cut this branch of $P(L')$ (as well as the lamination carried by $P(L')$) along l , then glue it back in such a way that the lamination carried by $P(L')$, when restricted to ∂D_1^B , becomes a lamination by circles. Clearly this operation changes the one-dimensional lamination carried by ∂D_2^B , but it does not change the boundary lamination carried by ∂D_i^B for $i \neq 1, 2$. Now applying Proposition 4.1 to D_2^B , we can modify the lamination

carried by $P(L')$ along E_2 so that the new lamination restricted to ∂D_2^B is a lamination by circles. Since $D_1 \neq D_2$ and $D_1 \rightarrow D_2 \rightarrow D_1$ is not a cycle by our assumptions, the modification along ∂D_2^B does not affect the lamination along ∂D_1^B , in other words, after this modification, the lamination carried by $P(L')$ restricted to both ∂D_1^B and ∂D_2^B is a lamination by circles. We repeat this operation through the chain and eventually get a lamination carried by $P(L')$ whose restriction to ∂D_i^B is a lamination by circles for each $i = 1, 2, \dots, k$. We can perform this operation for all our chains and extend the lamination of $P(L')$ through D_i^B for every D_i in a chain.

For any non-disk component of $B - L$, let C be a simple closed curve that is non-trivial in this component. By Lemma 2.4, C does not bound a disk in $N(B)$ that is transverse to the interval fibers. So the lamination we have constructed (for $P(L')$ and the chains) so far does not contain any disk leaf whose boundary is in the vertical boundary of $N_B(S)$ for any non-disk branch S .

By repeated application of Lemma 3.6, we can modify the lamination and extend it through all the non-disk branches of B . So, it remains to be shown that the lamination can be extended through all the cycles. We denote the lamination that we have constructed so far by λ . Note that λ is carried by B excluding those D_i^B 's that correspond to the disk branches in finitely many disjoint cycles.

Let $D_1 \rightarrow D_2 \rightarrow \dots \rightarrow D_k \rightarrow D_1$ be a cycle and c be the core of the cycle, ie, a simple closed curve in $\bigcup_{i=1}^k D_i$ such that $c \cap D_i$ is a simple arc connecting E_{i-1} to E_i for each i (let $E_0 = E_k$). The intersection of B with a small regular neighborhood of c in M , which we denote by $N(c)$, is either a branched annulus or a branched Möbius band with coherent branch directions, as shown in Figure 4.4.

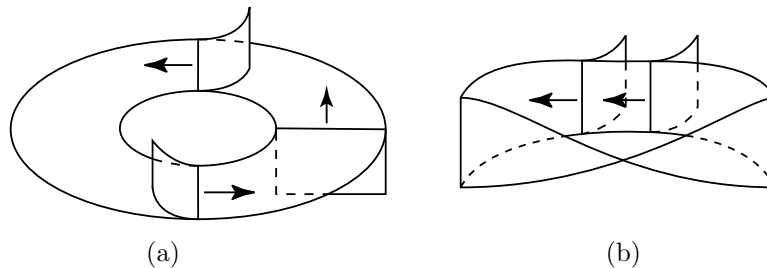

Figure 4.4

The lamination λ can be trivially extended to a lamination carried by $B - \bigcup_{all\ cycles} N(c)$. Hence, it suffices to extend the lamination from the boundary

of a branched annulus (or Möbius band) to its interior. We also use λ to denote the lamination carried by $B - \bigcup_{\text{all cycles}} N(c)$.

We will only discuss the branched annulus case (ie Figure 4.4 (a)). The branched Möbius band case is similar.

Let $A = \bigcup_{i=1}^k d_i$ be the annulus, where $d_i = D_i \cap N(c)$, and A' be the whole branched annulus (ie, $A' = B \cap N(c)$). Then $\partial A = A_1 \cup A_2$ consists of two circles and $A' = T_1 \times I = T_2 \times I$, where T_i is a train track consisting of the circle A_i and some ‘tails’ with coherent switch directions, $i = 1, 2$.

Now we consider the one-dimensional lamination in $\pi^{-1}(T_i)$ induced from λ . Since branch directions of the branched annulus are coherent, as shown in Figure 4.4 (a), the (one-dimensional) leaves that come into $\pi^{-1}(T_i)$ from the ‘tails’ must be spirals with the same spiraling direction (ie, clockwise or counterclockwise). So the leaves coming from the ‘tails’ above the circle A_i have the same limiting circle H_i , and the leaves coming from the ‘tails’ below the circle A_i have the same limiting circle L_i , $i = 1, 2$. Note that the leaves may come into A_i from different sides depending on the side from which the disks in $A' - A$ are attached to A , and this is what the words ‘above’ and ‘below’ mean; in the branched Möbius band case, we do not have such problems. After replacing a leaf by an I -bundle over this leaf and deleting the interior of the I -bundle, we can assume that $H_i \neq L_i$, $i = 1, 2$.

Then we add two annuli H and L in $\pi^{-1}(A)$ such that $\partial H = H_1 \cup H_2$ and $\partial L = L_1 \cup L_2$. Notice that the spirals above H_1 (resp. below L_1) in $\pi^{-1}(T_1)$ are connected, one to one, to the spirals above H_2 (resp. below L_2) in $\pi^{-1}(T_2)$ by the lamination λ (restricted to $\pi^{-1}(\partial A' - T_1 - T_2)$). So, in $\pi^{-1}(A')$, we can naturally connect the spirals above H_1 (resp. below L_1) carried by T_1 to the spirals above H_2 (resp. below L_2) carried by T_2 using some (2-dimensional) leaves of the form $\text{spiral} \times I$ such that the boundaries of these $\text{spiral} \times I$'s lie in $\partial\lambda$, and H (resp. L) is the limiting annulus of these $\text{spiral} \times I$ leaves.

There is a product region in $\pi^{-1}(A')$ between annuli H and L . As in Lemma 3.4, we can modify and extend the lamination from the vertical boundary of this product region to its interior, and hence we can extend our lamination through a given cycle. Note that in order to apply Lemma 3.4, we need the hypothesis that there is no disk leaf whose boundary is in the vertical boundary of the product region between by $H \cup L$, and this is guaranteed by Lemma 2.5.

Since the cycles are disjoint by our assumption, we can successively modify and extend the lamination through all the cycles. The lamination we get in the end is fully carried by B . \square

Next, we will show that if λ is a lamination by planes, then any branched surface that carries λ must contain a sink disk.

Proposition 4.2 was proved by Gabai (see [8]), and it is a lamination version of a theorem of Imanishi [14] for C^0 foliations by planes.

Proposition 4.2 *If M contains an essential lamination by planes, then M is homeomorphic to the 3-torus T^3 .*

Proof Because λ is an essential lamination by planes, the complement of any branched surface carrying it must be a collection of $D^2 \times I$ regions. Hence, λ can be trivially extended to a C^0 foliation by planes. Then a theorem of Imanishi [14], the classification of leaf spaces and Hölder's theorem together imply that $\pi_1(M)$ is commutative and hence $M = T^3$. \square

Proposition 4.3 *Let λ be a lamination by planes in a 3-manifold M . Then, any branched surface carrying λ cannot be a laminar branched surface.*

Proof Suppose B is a laminar branched surface that carries λ and L is the branch locus. If $B - L$ contains a nondisk component, then there is a simple closed curve $C \subset B - L$ that is homotopically nontrivial in $B - L$. Since B fully carries a lamination λ ($\lambda \subset N(B)$), $\pi^{-1}(C) \cap \lambda$ must contain a simple closed curve in a leaf of λ . Since every leaf of λ is a plane, this simple closed curve bounds an embedded disk D in a leaf. The disk clearly satisfies the two conditions in Lemma 2.4 with $\pi(\partial D) = C$, which contradicts the assumption that B is a laminar branched surface. Therefore, $B - L$ is a union of disks. Since there is no sink disk, every disk branch of B has an edge whose branch direction points outwards. Then the disk branches of B form at least one cycle as before. A small neighborhood of the core of the cycle is either a branched annulus or a branched Möbius band, as shown in Figure 4.4. Hence, one gets a curve with non-trivial holonomy, which contradicts the Reeb Stability Theorem and the assumption that every leaf is a plane. \square

5 Splitting branched surfaces along laminations

Suppose λ is an essential lamination in an orientable 3-manifold M and λ is not a lamination by planes. By 'blowing air' into leaves, ie, replacing every leaf by an I -bundle over this leaf and then deleting the interior of the I -bundle, we can assume that λ is nowhere dense and fully carried by a branched surface

B . By [9], we can assume that B satisfies the conditions in Proposition 1.1. It is easy to see that B still satisfies conditions 1, 2, and 3 in Proposition 1.1 after any further splitting along λ . We will show in this section that we can split B along λ to make it a laminar branched surface.

Let B' be a union of some branches of B . We call a point of B' an interior point if it has a small open neighborhood in M whose intersection with B' is a small branched surface without boundary, ie, the intersection is one of the 3 pictures as shown in Figure 1.1, otherwise we call it a boundary point. We denote the union of boundary points of B' by $\partial B'$. Next, we give every arc in $\partial B'$ a normal direction pointing into B' , and give every arc in $L \cap (B' - \partial B')$ its branch direction. We call the direction that we just defined for $\partial B'$ and $L \cap (B' - \partial B')$ the *direction associated with B'* . We call B' (and also $N(B') = \pi^{-1}(B')$) a *safe region* if it satisfies the following conditions:

- (1) B' does not contain any disk branch with the induced direction (from the direction associated with B' that we just defined) of every boundary arc pointing inwards;
- (2) for any non-disk branch in B' , if the direction (associated with B') of every boundary arc points inwards, then it contains a closed curve that is homotopically non-trivial in M .

Thus, by our definition, every disk branch (of B) lying in a safe region B' must have a boundary arc lying in the interior of B' with branch direction pointing outwards.

Proposition 5.1 *Let B' be a safe region. For any smooth arc $\alpha \subset L$, if either $\alpha \subset B' - \partial B'$ or $\alpha \subset \partial B'$ and the branch direction of α points into B' , then the union of B' and all the branches that are incident to α is still a safe region.*

Proof Let $D \not\subset B'$ be a branch incident to α . Then the branch direction of α points out of D . Hence $B' \cup D$ still satisfies our conditions for safe regions. \square

Proposition 5.2 *Let B' be a safe region. If $B' = B$, then the branched surface B is a laminar branched surface.* \square

Next, we will show how the safe region changes when we split the branched surface. What we want is to enlarge our safe region by splitting the branched surface. Suppose we do some splitting to B whose local picture is shown in Figure 5.1. We will call the splitting an *unnecessary splitting* if the shaded area in Figure 5.1 belongs to the safe region, otherwise, we call it a *necessary*

splitting. Note that, by Proposition 5.1, if the shaded area belongs to the safe region, we can include all the branches (of the branched surface on the left) in Figure 5.1 into the safe region, so we do not need to do such a splitting to enlarge our safe region. The following proposition says that the safe region does not decrease under necessary splittings. The proof is an easy application of Proposition 5.1. Figure 5.2 is just Figure 5.1 with different shaded regions which denote the safe region.

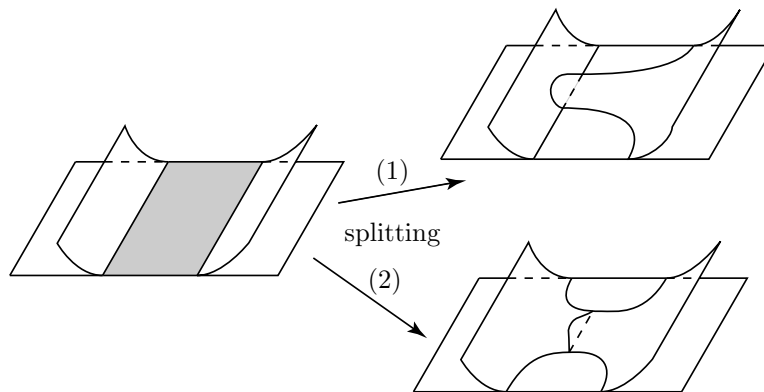

Figure 5.1

Proposition 5.3 *Let B' be a safe region. If after a necessary splitting, a branch S of B slides on B' , as shown in splitting (1) in Figure 5.2, or S and a branch in B' locally becomes one branch, as shown in splitting (2) in Figure 5.2, then we can enlarge the safe region after the splitting as shown in the two pictures on the right in Figure 5.2. In particular, for any interval fiber of $N(B)$ that is in a safe region, if this fiber breaks into two interval fibers after some necessary splitting, then we can enlarge the safe region after the splitting such that both interval fibers lie in the safe region.*

Proof After the splitting (1) in Figure 5.2, S has a boundary arc, with branch direction pointing outwards, lying in the interior of the shaded region in Figure 5.2. So, by Proposition 5.1, after splitting (1), the union of the original safe region and this branch is still a safe region. Note that, since it is a necessary splitting, the branch in the middle does not belong to the safe region and the change (done by the splitting) of this branch does not affect the safe region.

In the splitting (2) of Figure 5.2, if S and the shaded region in the left picture of Figure 5.2 do not belong to the same branch in B , then after splitting (2) the

new shaded branch in B either has a boundary arc with direction (associated with the safe region) pointing outwards or contains a non-trivial curve, since the shaded branch before the splitting is in the safe region.

Suppose S and the shaded region in the left picture of Figure 5.2 belong to the same branch in B (before the splitting). We denote this branch by D ($D \subset B'$). If D has a boundary arc whose direction (associated with the safe region) points outwards, then after the splitting, it still has such a boundary arc. If D does not have such an arc, then D is not a disk and it contains a curve that is homotopically non-trivial in M . Thus, after splitting (2), the branch still contains such an essential closed curve, and we can include this branch (after the splitting) into the safe region. \square

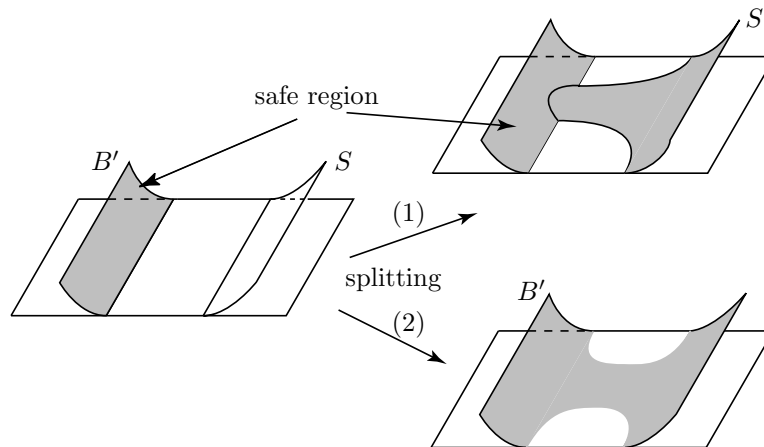

Figure 5.2

Now we are ready to prove the following lemma that is a half of Theorem 1. In the proof, we first construct a safe region B' by taking a small neighborhood of a union of finitely many essential curves in leaves of λ . Then, we perform some necessary splitting (along λ) and enlarge B' so that $B - B'$ lies in a union of disjoint 3-balls. After splitting B along the boundary of these 3-balls and getting rid of the disks of contact in these 3-balls, we can include the whole of B to the safe region, and hence B becomes a laminar branched surface.

Lemma 5.4 *Let λ be an essential lamination that is not a lamination by planes. Then λ is carried by a laminar branched surface.*

Proof Suppose that λ is an essential lamination in a 3-manifold M . We first show that any sub-lamination μ of λ is not a lamination by planes. Suppose μ

is a lamination by planes and γ is a closed curve in $M - \mu$. Then, by splitting μ , we can assume that μ is carried by $N(B)$ and γ lies in a component C of $M - \text{int}(N(B))$. By isotoping μ , we can assume that $\partial_h N(B) \subset \mu$. Let l be a boundary leaf of the component of $M - \mu$ that contains γ . Then, we can choose a big disk $D_1 \subset l$ such that $l \cap \partial_h N(B) \subset D_1$. Moreover, there is a vertical annulus A consisting of subarcs of I -fibers of $N(B)$ such that one boundary circle of the A is ∂D_1 , $\partial A \subset \mu$, and the $\text{int}(A)$ lies in the same component of $M - \mu$ that contains γ . Since μ is assumed to be a lamination by planes, the other boundary circle of the A bounds a disk D_2 in a leaf of μ . So, $D_1 \cup A \cup D_2$ forms a sphere. Since M is irreducible, $D_1 \cup A \cup D_2$ bounds a 3-ball whose interior lies in $M - \mu$. As $l \cap \partial_h N(B) \subset D_1$, C and hence γ must lie in this 3-ball, which implies every component of $M - \mu$ is simply connected. Since every leaf of λ is π_1 -injective, every leaf of λ must be a plane, which contradicts our hypothesis. Therefore, any sub-lamination of λ is not a lamination by planes.

By [9], we can assume that λ is carried by a branched surface B that satisfies the conditions in Proposition 1.1. Moreover, we also assume that λ is in Kneser-Haken normal form with respect to a triangulation \mathcal{T} (one can take a fine enough triangulation so that the branched surface B is a union of normal disks in this triangulation). Now, λ lies in $N(B)$ transversely intersecting every interval fiber of $N(B)$, and $N(B) \cap \mathcal{T}^{(1)}$ is a union of I -fibers of $N(B)$, where $\mathcal{T}^{(1)}$ is the 1-skeleton of \mathcal{T} . Note that, by [9], B still satisfies conditions 1–3 in Proposition 1.1 after any splitting.

For any point $x \in \lambda \cap \mathcal{T}^{(1)}$, we denote the leaf that contains x by l_x . Let μ_x be the closure of l_x . Then μ_x is a sub-lamination of λ . Hence, μ_x is not a lamination by planes. Let c_x be a non-trivial simple closed curve in a non-plane leaf of μ_x . Then there is an embedding $A: S^1 \times I \rightarrow N(B)$, where $I = [-1, 1]$, such that $A(\{p\} \times I)$ is a sub-arc of an interval fiber of $N(B)$, $A(S^1 \times \{0\}) = c_x$, and every closed curve in $A^{-1}(\lambda)$ is of the form $S^1 \times \{t\}$ for some $t \in (-1, 1)$. Moreover, after some isotopies, we can assume that there are $a, b \in I$ such that $-1 < a \leq 0 \leq b < 1$, $A(S^1 \times \{a, b\}) \subset \lambda$, and $A^{-1}(\lambda) \cap (S^1 \times (I - [a, b]))$ is either empty or a union of spirals whose limiting circles are $S^1 \times \{a, b\}$. We call such embedded annuli *regular annuli*.

To simplify notation, we will not distinguish the map A and its image. Since c_x lies in the closure of l_x , there must be a simple arc in l_x connecting x to the annulus A . Moreover, there is an embedding $b: I \times (-1, 1) \rightarrow N(B)$ such that $b(-1, 0) = x$, $b(\{1\} \times (-1, 1)) \subset A$, $I_x = b(\{-1\} \times (-1, 1)) \subset \mathcal{T}^{(1)}$, and $b^{-1}(\lambda)$ is a union of compact parallel arcs connecting $\{-1\} \times (-1, 1)$ to $\{1\} \times (-1, 1)$. Hence, I_x is an open neighborhood of x in $\mathcal{T}^{(1)}$. For every

point $x \in \lambda \cap \mathcal{T}^{(1)}$, we have such an open interval I_x and a regular annulus as A above. By compactness, there are finitely many points x_1, x_2, \dots, x_n in $\lambda \cap \mathcal{T}^{(1)}$ such that $\lambda \cap \mathcal{T}^{(1)} \subset \cup_{i=1}^n I_{x_i}$, where I_{x_i} is an open neighborhood of x_i in $\mathcal{T}^{(1)}$ as above. Let A_1, \dots, A_n be the regular annuli that correspond to x_1, \dots, x_n respectively as above. Since $\lambda \cap \mathcal{T}^{(1)} \subset \cup_{i=1}^n I_{x_i}$, for any $x \in \lambda \cap \mathcal{T}^{(1)}$, there is an arc on a leaf of λ connecting x to A_i for some i . Note that each A_i is embedded but A_i and A_j may intersect each other if $i \neq j$.

Claim There are finitely many disjoint regular annuli E_1, \dots, E_k such that, for any $x \in \lambda \cap \mathcal{T}^{(1)}$, there is an arc in a leaf of λ connecting x to E_i for some i .

Proof of the Claim If A_1, \dots, A_n are disjoint, the claim holds immediately. Suppose that $A_1 \cap A_2 \neq \emptyset$. As a map, $A_i: S^1 \times I \rightarrow N(B)$ is an embedding ($i = 1, \dots, n$). To simplify notation, we use A_i to denote both the map and its image in $N(B)$. After some homotopies, we can assume that $A_i^{-1}(A_j)$ is a union of disjoint sub-arcs of the I -fibers of $S^1 \times I$, and $(S^1 \times \partial I) \cap A_i^{-1}(\lambda) \cap A_i^{-1}(A_j) = \emptyset$ ($i \neq j$). Thus, the intersection of $A_i^{-1}(\lambda)$ and $A_i^{-1}(A_j)$ must lie in the interior of $A_i^{-1}(A_j)$.

$A_1^{-1}(\lambda)$ is a one-dimensional lamination in $S^1 \times I$, and by our construction, every leaf of $A_1^{-1}(\lambda)$ that is not a circle must have a limiting circle in $A_1^{-1}(\lambda)$. Therefore, if every circular leaf of $A_1^{-1}(\lambda)$ has non-empty intersection with $A_1^{-1}(\cup_{i=2}^n A_i)$, then for every point $p \in A_1(A_1^{-1}(\lambda))$, there is an arc in a leaf of λ connecting p to $\cup_{i=2}^n A_i$. Hence, for any point $x \in \lambda \cap \mathcal{T}^{(1)}$, there is an arc in l_x connecting x to $\cup_{i=2}^n A_i$, and we only need to consider $n - 1$ annuli A_2, \dots, A_n . If there are circular leaves in $A_1^{-1}(\lambda)$ whose intersection with $A_1^{-1}(\cup_{i=2}^n A_i)$ is empty, then since $A_1^{-1}(\lambda) \cap A_1^{-1}(\cup_{i=2}^n A_i)$ lies in the interior of $A_1^{-1}(\cup_{i=2}^n A_i)$, there are finitely many disjoint annuli B_1, \dots, B_m in $S^1 \times I$ such that $A_1^{-1}(\cup_{i=2}^n A_i) \cap (\cup_{j=1}^m B_j) = \emptyset$, every circular leaf of $A_1^{-1}(\lambda)$ either has non-empty intersection with $A_1^{-1}(\cup_{i=2}^n A_i)$ or lies in B_j for some j , and $A_1|_{B_j}$ is a regular annulus for each j . To simplify notation, we will not distinguish $A_1|_{B_j}$ and its image in $N(B)$. Thus, for any point $x \in \lambda \cap \mathcal{T}^{(1)}$, there is an arc in a leaf of λ connecting x to $(\cup_{i=2}^n A_i) \cup (\cup_{j=1}^m A_1|_{B_j})$, and $A_1|_{B_j}$ is disjoint from A_i for any i, j ($i \neq 1$).

By repeating the construction above, eventually we will get finitely many such disjoint regular annuli as in the claim. □

As in the claim, E_1, \dots, E_k are disjoint regular annuli. Let $N(E_i)$ be a small neighborhood of E_i in M such that $N(E_i) \cap N(E_j) = \emptyset$ if $i \neq j$. Topologically,

$N(E_i)$ is a solid torus for each i . $N(E_i) \cap \lambda$ consists of a union of parallel annuli and some simply connected leaves. The limit of every simply connected leaf in $N(E_i) \cap \lambda$ is either an annulus or a union of two annuli depending on the number of ends of the leaf. Since the $N(E_i)$'s are disjoint, by 'blowing air' into the leaves, we can split the branched surface B along λ such that every component of $B \cap N(E_i)$ is either an annulus or a branched annulus with coherent branch directions, as shown in Figure 4.4 (a), whose core is homotopically essential in M . Let D be a component of $B \cap N(E_i)$ that is a branched annulus. Since D has coherent branch directions, every branch in D has a boundary edge with branch direction pointing outwards. Since the core of every solid torus $N(E_i)$ is an essential curve in M , the union of the branches of B that have non-empty intersection with $\cup_{i=1}^k N(E_i)$ is a safe region. We denote the safe region by B' and $N(B') = \pi^{-1}(B')$ as before.

Note that if B contains a trivial bubble, then we can collapse the trivial bubble without destroying the branched annuli constructed above, though the number of "tails" in a branched annulus may decrease. More precisely, let c be the core of a branched annulus as above, by the definition of trivial bubble, we can always pinch B to eliminate a trivial bubble so that the neighborhood of c after this pinching is still a branched annulus with coherent branch direction. Moreover, if $B \cap N(E_i)$ is an annulus, since the core of $N(E_i)$ is homotopically nontrivial, the operation of eliminating trivial bubbles does not affect the annulus $B \cap N(E_i)$. Thus, our safe region will never be empty due to eliminating trivial bubbles. Next, we will perform necessary splitting to our branched surface. If we see any trivial bubble during the splitting, we eliminate it by pinching the branched surface and start over. Since the number of components of the complement of the branched surface never increases during necessary splittings and the number of components decreases by one after a trivial bubble is eliminated, eventually we will never get any trivial bubble. Therefore, we can assume the necessary splittings we perform in the following never create any trivial bubble.

For any $x \in \lambda \cap \mathcal{T}^{(1)}$, by the claim and our construction of B' , there is a simple arc $\gamma: [0, 1] \rightarrow l_x$ connecting x to a point in $N(B')$, ie, $\gamma(0) = x$ and $\gamma(1) = y \in N(B')$. Moreover, there is an embedding $b_x: [0, 1] \times (-\epsilon, \epsilon) \rightarrow N(B)$ such that $b_x|_{[0, 1] \times \{0\}} = \gamma$, $b_x(\{t\} \times (-\epsilon, \epsilon))$ is a subarc of an I -fiber of $N(B)$, and $b_x^{-1}(\lambda)$ is a union of parallel arcs connecting $\{0\} \times (-\epsilon, \epsilon)$ to $\{1\} \times (-\epsilon, \epsilon)$. For each $t \in [0, 1]$, we denote $b_x(\{t\} \times (-\epsilon, \epsilon))$ by I_t , and we also use I_x to denote I_0 . Thus, $x \in I_x$. To simplify notation, we do not distinguish b_x and its image in $N(B)$. So, $b_x = \cup_{t \in [0, 1]} I_t$. Now for every $x \in \lambda \cap \mathcal{T}^{(1)}$, we have such an open interval $I_x \subset N(B) \cap \mathcal{T}^{(1)}$ as above. By compactness, we can choose finitely many points $x_1, x_2, \dots, x_n \in \lambda \cap \mathcal{T}^{(1)}$ such that $\lambda \cap \mathcal{T}^{(1)} \subset \cup_{i=1}^n I_{x_i}$.

Using Proposition 5.1, we enlarge our safe region as much as we can. Then we do the necessary splitting along λ , and include all possible branches into our safe region (using Proposition 5.3) after the splitting. We will always denote the safe region by B' (or $N(B')$). If a certain splitting cuts through a band b_x and a vertical arc I_t of b_x breaks into some smaller arcs $J_{t_1}, J_{t_2}, \dots, J_{t_h}$, to simplify notation, we will denote $\cup_{i=1}^h J_{t_i}$ also by I_t , and denote $\cup_{t \in [0,1]} I_t$ also by b_x . Note that our new bands after splitting may contain some ‘bubbles’, as shown in Figure 5.3, but they are always embedded in $N(B)$ by our construction.

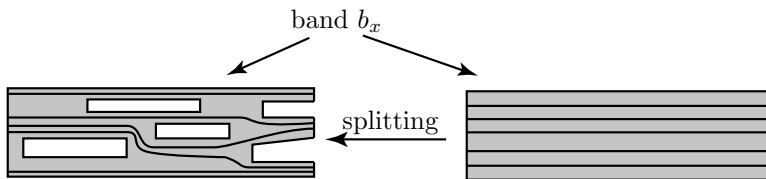

Figure 5.3

Next, we will show that we can do some necessary splitting along a band b_x and include I_x in the safe region. By Proposition 5.3, we know that once an interval fiber of $N(B)$ is in the safe region, it will stay in the safe region forever, though it may break into some small intervals after further splitting.

Suppose after some splitting, the band b_x contains some ‘bubbles’ as shown in Figure 5.3. Although b_x is embedded in $N(B)$, there may be an I -fiber of $N(B)$ whose intersection with b_x has more than one component. By perturbing b_x a little, we can assume that there are only finitely many I -fibers of $N(B)$ whose intersection with b_x have more than one component. So, $\pi(b_x)$ is an immersed train track (immersed curve with some ‘bubbles’) on B , where π is the map collapsing every interval fiber to a point. Those finitely many I -fibers whose intersection with b_x have more than one component become double points of $\pi(b_x)$ after the collapsing. Let \mathcal{C} be the number of double points of $\pi(b_x) - B'$. If $\mathcal{C} = 0$, then we perform all possible necessary splittings along b_x and enlarge our safe region as in Proposition 5.3. Since b_x is compact, after finitely many necessary splittings along b_x , the whole of b_x and (hence I_x) is included in the safe region.

Let $\cup_{t \in (a,b)} I_t \subset b_x - N(B')$ and $I_a \subset N(B')$ ($[a, b] \subset [0, 1]$). Suppose that $\pi(\cup_{t \in (a,b)} I_t)$ contains double points. We split $N(B)$ between I_a and I_b along b_x (using only necessary splittings) as above. After the splitting passes an interval fiber that is the inverse image (ie, π^{-1}) of a double point of $\pi(b_x) - B'$, either the double point disappears under the collapsing map of the new branched surface after the splitting, or it is included in the safe region, as shown in Figure 5.4.

Therefore, \mathcal{C} decreases and eventually we can include the whole band b_x in the safe region.

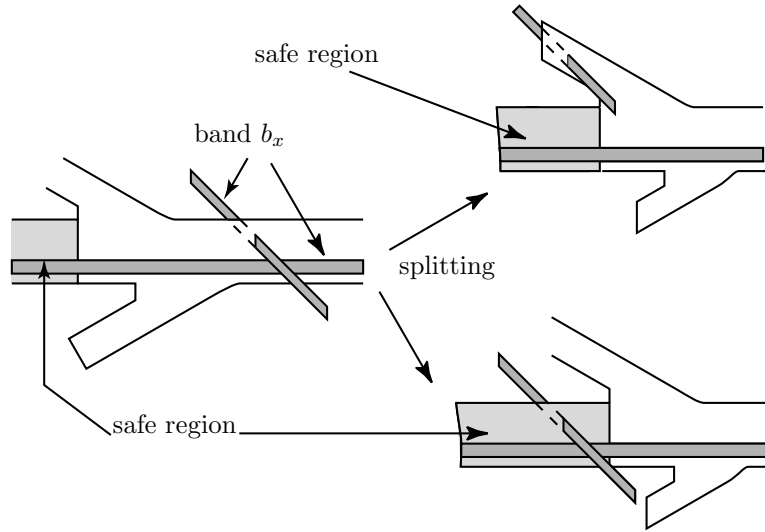

Figure 5.4

Since there are finitely many such intervals that cover $\lambda \cap \mathcal{T}^{(1)}$, we can include $N(B) \cap \mathcal{T}^{(1)}$ into the safe region after finitely many steps. Then, by performing similar splittings, we can include $N(B) \cap \mathcal{T}^{(2)}$ into the safe region. Now $N(B) - N(B')$ is contained in the interior of finitely many disjoint 3-simplices, ie 3-balls.

We consider $B - (B' - \partial B')$, and let $\Gamma_1, \dots, \Gamma_s$ be the components of $B - (B' - \partial B')$. Each Γ_i is a union of branches of B . We can define the boundary of Γ_i in the same way as we did for B' at the beginning of this section. The branch direction of every boundary arc of any Γ_i must point into Γ_i , and the other two (local) branches incident to this arc must belong to B' (since it is a boundary arc of Γ_i), otherwise, using Proposition 5.1, we can enlarge B' by adding all the branches incident to this arc to B' . Thus, for each Γ_i , there is a small neighborhood of Γ_i , which we denote by $N(\Gamma_i)$, such that $N(\Gamma_i) \cap N(\Gamma_j) = \emptyset$ if $i \neq j$. Moreover, after some necessary splitting, we can assume that each $N(\Gamma_i)$ is homeomorphic to a 3-ball. By our definition of the safe region, any branch in B' that has non-empty intersection with $\cup_{i=1}^s \partial N(\Gamma_i)$ either contains an essential closed curve, or has a boundary arc (lying in the interior of B') with branch direction pointing outwards. Therefore, after any (unnecessary) splitting along $B \cap \partial N(\Gamma_i)$, each branch in $B - int(N(\Gamma_i))$ either contains an essential

closed curve, or has a boundary arc (lying in the interior of $B - \text{int}(N(\Gamma_i))$) with branch direction pointing outwards. Next, we split B along $\lambda \cap \partial N(\Gamma_i)$ (for each i) so that $B \cap (\cup_{i=1}^s \partial N(\Gamma_i))$ becomes a union of circles, and at this point, each branch of $B - \text{int}(N(\Gamma_i))$ that has non-empty intersection with $\partial N(\Gamma_i)$ either contains an essential closed curve, or has a boundary arc (lying in the interior of $B - \text{int}(N(\Gamma_i))$) with branch direction pointing outwards. Then, we split B to get rid of the disks of contact in $\cup_{i=1}^s \text{int}(N(\Gamma_i))$. After this splitting, $B \cap N(\Gamma_i)$ becomes a union of disks for each i , and each branch of B either contains an essential closed curve, or has a boundary arc with branch direction pointing outwards. Hence, B contains no sink disk after all these splittings, and becomes a laminar branched surface. \square

References

- [1] **C Delman**, *Essential laminations and Dehn surgery on 2-bridge knots*, Topology Appl. 63 (1995) 201–221
- [2] **D Eisenbud, U Hirsch, W Neumann**, *Transverse foliations of Seifert bundles and self-homeomorphism of the circle*, Comment. Math. Helv. 56 (1981) 638–660
- [3] **D Gabai**, *Foliations and the topology of 3-manifolds*, J. Differential Geometry, 18 (1983) 445–503
- [4] **D Gabai**, *Foliations and the topology of 3-manifolds II*, J. Differential Geometry, 26 (1987) 461–478
- [5] **D Gabai**, *Foliations and the topology of 3-manifolds III*, J. Differential Geometry, 26 (1987) 479–536
- [6] **D Gabai**, *Taut foliations of 3-manifolds and suspensions of S^1* , Ann. Inst. Fourier, Grenoble, 42 (1992) 193–208
- [7] **D Gabai**, *Problems in Foliations and Laminations*, Stud. in Adv. Math. AMS/IP, 2 (1997) 1–34
- [8] **D Gabai**, *Foliations and 3-manifolds*, Proceedings of the International Congress of Mathematicians, Vol. I (Kyoto, 1990) 609–619
- [9] **D Gabai, U Oertel**, *Essential laminations in 3-manifolds*, Ann. of Math. 2 (1989) 41–73
- [10] **D Gabai, W H Kazez**, *Group negative curvature for 3-manifolds with genuine laminations*, Geometry and Topology, 2 (1998) 65–77
- [11] **J Hass, H Rubinstein, P Scott**, *Compactifying coverings of closed 3-manifolds*, J. Differential Geomerry, 30 (1989) 817–832
- [12] **A Hatcher**, *On the Boundary Curves of Incompressible Surfaces*, Pacific J. Math. 99 (1982) 373–377

- [13] **A Hatcher**, *Some examples of essential laminations in 3-manifolds*, Ann. Inst. Fourier, Grenoble, 42 (1992) 313–325
- [14] **H Imanishi**, *On the theorem of Denjoy-Sacksteder for codimension one foliations without holonomy*, J. Math. Kyoto Univ. 14 (1974) 607–634
- [15] **T Li**, *Laminar branched surface in 3-manifolds II*, in preparation
- [16] **R Naimi**, *Constructing essential laminations in 2-bridge knot surgered 3-manifolds*, Pacific J. Math. 180 (1997) 153–186
- [17] **S Novikov**, *Topology of Foliations*, Moscow Math. Soc. 14 (1963) 268–305
- [18] **R C Penner, J L Harer**, *Combinatorics of train tracks*, Annals of Mathematics Studies 125, Princeton University Press
- [19] **R Roberts**, *Taut foliations in punctured surface bundles, III*, preprint
- [20] **W P Thurston**, *Three-dimensional manifolds, Kleinian groups and hyperbolic geometry*, Bull. Amer. Math. Soc. 6 (1982) 357–381
- [21] **F Waldhausen**, *On Irreducible 3-manifolds which are Sufficiently Large*, Ann. of Math. 87 (1968) 56–88
- [22] **Ying-Qing Wu**, *Sutured manifold hierarchies, essential laminations, and Dehn surgery*, J. Differential Geometry, 48 (1998) 407–437