

# HERMITIAN CHARACTERISTICS OF NILPOTENT ELEMENTS

E. TEVELEV

University of Texas in Austin

tevelev@math.utexas.edu

ABSTRACT. We define and study several equivariant stratifications of the isotropy and coisotropy representations of a parabolic subgroup in a complex reductive group.

## §0. INTRODUCTION

Let  $G$  be a connected complex reductive algebraic group,  $P \subset G$  a proper parabolic subgroup,  $L \subset P$  a Levi subgroup,  $Z \subset L$  the connected component of the center of  $L$ ,  $P^-$  the opposite parabolic subgroup, so  $P \cap P^- = L$ . Let  $\mathfrak{g}$ ,  $\mathfrak{p}$ ,  $\mathfrak{l}$ ,  $\mathfrak{z}$ , and  $\mathfrak{p}^-$  denote the corresponding Lie algebras. Then  $\mathfrak{g}$  is  $\widehat{Z}$ -graded, where  $\widehat{Z}$  is the character group of  $Z$  written additively,  $\mathfrak{g} = \bigoplus_{\chi \in \widehat{Z}} \mathfrak{g}_\chi$ ,  $\mathfrak{g}_0 = \mathfrak{l}$ .  $P$  is maximal if and only if  $\widehat{Z}$ -grading reduces to  $\mathbb{Z}$ -grading of the form  $\bigoplus_{i=-k}^k \mathfrak{g}_i$ . Let  $\mathfrak{n} \subset \mathfrak{p}$  be the unipotent radical of  $\mathfrak{p}$ . The group  $\widehat{Z}$  admits a total ordering such that  $\mathfrak{p} = \bigoplus_{\chi \geq 0} \mathfrak{g}_\chi$ ,  $\mathfrak{n} = \bigoplus_{\chi > 0} \mathfrak{g}_\chi$ . We shall also use the identification  $\mathfrak{g}/\mathfrak{p}^- = \bigoplus_{\chi > 0} \mathfrak{g}_\chi$ , which is an isomorphism of  $L$ -modules. Any element  $e \in \mathfrak{n}$  (resp.  $e \in \mathfrak{g}/\mathfrak{p}^-$ ) has the weight decomposition  $e = \sum_{\chi > 0} e_\chi$ , where  $e_\chi \in \mathfrak{g}_\chi$ . Each  $e_\chi$  is a homogeneous nilpotent element of  $\mathfrak{g}$ , and therefore can be embedded (not uniquely) in a homogeneous  $\mathfrak{sl}_2$ -triple  $\langle e_\chi, h_\chi, f_\chi \rangle$ , where  $f_\chi \in \mathfrak{g}_{-\chi}$ ,  $h_\chi \in \mathfrak{l}$ . Here by an  $\mathfrak{sl}_2$ -triple  $\langle e, f, h \rangle$  we mean a collection of possibly zero vectors such that  $[e, f] = h$ ,  $[h, e] = 2e$ ,  $[h, f] = -2f$ . The collection of elements  $\{h_\chi\}$  is called a *multiple characteristic* of  $e$  (or of the collection  $\{e_\chi\}$ ). A compact real form of the Lie algebra of a reductive subgroup in  $G$  is, by definition, the Lie algebra of a compact real form of this complex algebraic subgroup. We fix a compact real form  $\mathfrak{k} \subset \mathfrak{l}$ . The multiple characteristic  $\{h_\chi\}$  is called *Hermitian* if any  $h_\chi \in i\mathfrak{k}$ .

In this paper we consider the following question: is it true that any  $e \in \mathfrak{n}$  (resp.  $e \in \mathfrak{g}/\mathfrak{p}^-$ ) admits a Hermitian multiple characteristic up to  $P$ -conjugacy (resp. up to  $P^-$ -conjugacy)? Clearly, we may (and shall) suppose that  $G$  is simple. We can identify parabolic subgroups with coloured Dynkin diagrams. Black vertices correspond to simple roots such that the corresponding root subspaces belong to the Levi part of the parabolic subgroup. The following theorem is the main result of this paper.

**Theorem 1.** *Suppose that  $G$  is simple and not  $E_7$  or  $E_8$ , or  $G$  is equal to  $E_7$  or  $E_8$ , but  $P$  is not of type 38–59 (see the Table at the end of this paper). Then for any  $e \in \mathfrak{n}$  (resp.  $e \in \mathfrak{g}/\mathfrak{p}^-$ ) there exists  $p \in P$  (resp.  $p \in P^-$ ) such that  $Ad(p)e$  admits a Hermitian multiple characteristic.*

The remaining cases 38–59 will be studied in the sequel of this paper. We remark here that the *adjoint case*  $e \in \mathfrak{g}/\mathfrak{p}^-$  and the *coadjoint case*  $e \in \mathfrak{n}$  are indeed being considered separately.

Theorem 1 has the following corollary valid over arbitrary algebraically closed field  $k$  of characteristic 0. For any collection of elements  $v_1, \dots, v_n$  of an algebraic Lie algebra  $\mathfrak{h}$  we denote by  $\langle v_1, \dots, v_n \rangle_{alg}$  the minimal algebraic Lie subalgebra of  $\mathfrak{h}$  containing  $v_1, \dots, v_n$ .

**Theorem 2.** *For the pairs  $(G, P)$  satisfying Theorem 1 over  $\mathbb{C}$ , the following is true over  $k$ . For any  $e \in \mathfrak{n}$  (resp.  $e \in \mathfrak{g}/\mathfrak{p}^-$ ) there exists  $p \in P$  (resp.  $p \in P^-$ ) such that  $Ad(p)e$  admits a multiple characteristic  $\{h_\chi\}$  with reductive  $\langle h_\chi \rangle_{alg}$ .*

The following Theorem 3 (conjectured in [Te2]) was already proved in [Te1] for all parabolic subgroups that satisfy Theorem 2. Let  $\mathfrak{R}_G$  denote the set of irreducible representations of  $G$ . For any  $V \in \mathfrak{R}_G$ , there exists a unique maximal proper  $P$ -submodule  $M_V \subset V$ . Therefore, we have a linear map  $\Psi_V : \mathfrak{g}/\mathfrak{p} \rightarrow \text{Hom}(M_V, V/M_V)$ ,  $\Psi_V(x)v = x \cdot v \pmod{M_V}$ .

**Theorem 3.** *For the pairs  $(G, P)$  satisfying Theorem 2, there exists an algebraic  $P$ -invariant stratification  $\mathfrak{g}/\mathfrak{p} = \sqcup_{i=1}^N X_i$  such that for any  $V \in \mathfrak{R}_G$ , the function  $rk \Psi_V$  is constant along each  $X_i$ . In other words, the linear span of functions  $rk \Psi_V$  in the algebra of constructible functions on  $\mathfrak{g}/\mathfrak{p}$  is finite-dimensional.*

If the stratification is known explicitly it allows to solve the following classical geometric problem effectively. For any irreducible equivariant spanned vector bundle  $\mathcal{L}$  on  $G/P$ , to check whether its generic global section has zeros. This class of geometric problems includes, for example, the exact estimates on the maximal possible dimension of a projective subspace in a generic projective hypersurface of given degree, or of an isotropic subspace of a generic skew-symmetric form of given degree. The corresponding algorithm and examples were given in [Te2].

The stratification from Theorem 3 provides an alternative to the orbit decomposition for the action of  $P^-$  on  $\mathfrak{g}/\mathfrak{p}^-$ . It is known that this action has an open orbit, see [LW], however the number of orbits is usually infinite, see [PR], [BHR].

All necessary facts about complex and real Lie groups, Lie algebras, and algebraic groups used in this paper without specific references can be found in [VO]. In particular, we numerate simple roots of simple Lie algebras as in [loc. cit.]. If  $\mathfrak{g}$  is a simple group of rank  $r$  then  $\alpha_1, \dots, \alpha_r$  denote its simple roots,  $\varphi_1, \dots, \varphi_r$  denote its fundamental weights. For any dominant weight  $\lambda$  we denote by  $R(\lambda)$  the irreducible representation of highest weight  $\lambda$ .

This paper was written during my stay at the Erwin Schrödinger Institute in Vienna and at the University of Glasgow. I would like to thank my hosts for the warm hospitality.

## §1. HERMITIAN CHARACTERISTICS IN CLASSICAL GROUPS

In this section we give some background information, prove Theorem 1 for classical groups, and prove Theorem 2. Let us consider the case  $\mathfrak{g} = \mathfrak{gl}(V)$  first. We recall the notion of the Moore–Penrose inverse of linear maps. Let  $V_1$  and  $V_2$  be vector spaces with Hermitian scalar products. For any linear map  $F : V_1 \rightarrow V_2$  its Moore–Penrose inverse is a linear map  $F^+ : V_2 \rightarrow V_1$  defined as follows. Consider  $\text{Ker } F \subset V_1$  and  $\text{Im } F \subset V_2$ . Let  $\text{Ker}^\perp F \subset V_1$  and  $\text{Im}^\perp F \subset V_2$  be their orthogonal

complements with respect to the Hermitian scalar products. Then  $F$  defines via restriction a bijective linear map  $\tilde{F} : \text{Ker}^\perp F \rightarrow \text{Im} F$ . Then  $F^+ : V_2 \rightarrow V_1$  is a unique linear map such that  $F^+|_{\text{Im}^\perp F} = 0$  and  $F^+|_{\text{Im} F} = \tilde{F}^{-1}$ . It is easy to see that  $F^+$  is the unique solution of the following system of *Penrose equations*:

$$F^+ F F^+ = F^+, \quad F F^+ F = F, \quad F F^+ \text{ and } F^+ F \text{ are Hermitian.} \quad (*)$$

For example, if  $F$  is invertible then  $F^+ = F^{-1}$ .

Suppose now that  $\mathfrak{g} = \mathfrak{gl}(V)$  and take any decomposition  $V = V_1 \oplus \dots \oplus V_k$ . Then we have a block decomposition  $\mathfrak{gl}(V) = \bigoplus_{i,j=1}^k \text{Hom}(V_i, V_j)$ . The parabolic subalgebra  $\mathfrak{p} = \bigoplus_{i \leq j} \text{Hom}(V_i, V_j)$  has the unipotent radical  $\mathfrak{n} = \bigoplus_{i < j} \text{Hom}(V_i, V_j)$  and any parabolic subalgebra in  $\mathfrak{gl}(V)$  has this form. Consider the corresponding  $\widehat{Z}$ -grading. Then  $\mathfrak{l} = \mathfrak{gl}(V)_0 = \bigoplus_{i=1}^k \text{End}(V_i)$  and all other rectangular blocks  $\text{Hom}(V_i, V_j)$  get different grades.

We claim that for any collection  $\{e_{ij}\}$ ,  $e_{ij} \in \text{Hom}(V_i, V_j)$ ,  $i < j$ , there exists a unique Hermitian multiple characteristic with respect to any compact real form of  $\mathfrak{l}$ . Indeed, we fix Hermitian scalar products in  $V_1, \dots, V_k$  and set  $\mathfrak{k} = \bigoplus_{i=1}^k \mathfrak{u}(V_i)$ , where  $\mathfrak{u}(V_i)$  is the Lie algebra of skew-Hermitian operators. Any compact real form of  $\mathfrak{l}$  has this presentation. Now let us take Moore–Penrose inverses  $f_{ji} = e_{ij}^+ \in \text{Hom}(V_j, V_i)$  of elements  $e_{ij}$ . The equations (\*) are equivalent to the statement that  $\langle e_{ij}, h_{ij} = [e_{ij}, f_{ji}], f_{ji} \rangle$  is an  $\mathfrak{sl}_2$ -triple containing  $e_{ij}$  with a Hermitian characteristic  $h_{ij}$ . Therefore,  $\{h_{ij}\}_{i < j}$  is a unique Hermitian multiple characteristic of  $\{e_{ij}\}$ . In particular, Theorem 1 is proved for  $\mathfrak{gl}(V)$ . The same argument applies for  $\mathfrak{sl}(V)$ .

### Definitions.

- An  $\text{Ad}(L)$ -orbit  $\mathcal{O} \subset \mathfrak{g}_\chi$  is called an *ample orbit* if for any  $e_\chi \in \mathcal{O}$  there exists a homogeneous  $\mathfrak{sl}_2$ -triple  $\langle e_\chi, h_\chi, f_\chi \rangle$  with Hermitian characteristic  $h_\chi \in i\mathfrak{k}$ .
- An element  $x \in \mathfrak{g}_\chi$  is called *ample* if its  $L$ -orbit is ample.
- The  $\widehat{Z}$ -grading of  $\mathfrak{g}$  is called *ample in degree*  $\chi$ , if all  $\text{Ad}(L)$ -orbits in  $\mathfrak{g}_\chi$  are ample.
- For some parabolic subgroups the element  $p$  in Theorem 1 can be chosen within the Levi subgroup  $L$ . These parabolic subgroups are called *weakly ample*.

A non-zero weight  $\chi \in \widehat{Z}$  is called *reduced* if  $\mathfrak{g}_{2\chi} = 0$ .

**Basic Lemma** (see [Te1]). *If  $\chi \in \widehat{Z}$  is reduced then the grading is ample in degree  $\chi$ .*

Basic Lemma shows that almost all components of the grading are automatically ample. Now we can prove Theorem 1 for orthogonal and symplectic groups.

**Theorem 4.** *Any parabolic subgroup in  $SO_n(\mathbb{C})$  or  $Sp_n(\mathbb{C})$  is weakly ample.*

Suppose that  $V = \mathbb{C}^n$  is a complex vector space endowed with a non-degenerate bilinear form  $\omega$ , which is either symmetric or skew-symmetric. We denote by  $G(\omega) \subset \text{SL}(V)$  the corresponding special orthogonal or symplectic group of automorphisms of  $V$  preserving  $\omega$ . Let  $\mathfrak{g} \subset \mathfrak{sl}(V)$  be its Lie algebra of skew-symmetric operators with respect to  $\omega$ . The subspace  $U \subset V$  is called *isotropic* if  $\omega$  vanishes on  $U$ . Let  $0 = F_0 \subset F_1 \subset \dots \subset F_k \subset V$  be a flag of isotropic subspaces. Then the stabilizer  $P$  of this flag in  $G(\omega)$  is a parabolic subgroup and any parabolic subgroup has this form.

In order to fix the Levi subgroup of  $P$ , we choose subspaces  $U_k^+ \subset F_k$  complement to  $F_{k-1}$  and we choose an isotropic subspace  $G_k$  transversal to  $F_k$  such that the restriction of  $\omega$  on  $F_k \oplus G_k$  is non-degenerate. Then the subgroup  $L$  of  $G(\omega)$  preserving both  $U_1^+, \dots, U_k^+$  and  $G_k$  is a Levi subgroup of  $P$ .  $F_k$  and  $G_k$  are naturally dual to each other with respect to the bilinear form: any  $v \in G_k$  defines a linear functional  $\omega(v, \cdot)$  on  $F_k$ . Let  $G_k = U_1^- \oplus \dots \oplus U_k^-$  be the decomposition dual to the decomposition  $F_k = U_1^+ \oplus \dots \oplus U_k^+$ . Let  $W = (F_k \oplus G_k)^\perp$ . Then  $L$  automatically preserves  $U_1^-, \dots, U_k^-$  and  $W$ . The semisimple part of  $\mathfrak{l}$  is isomorphic to  $\mathfrak{sl}(U_1^-) \oplus \dots \oplus \mathfrak{sl}(U_k^-) \oplus \mathfrak{g}(W)$ , where  $\mathfrak{g}(W)$  is the Lie algebra of skew-symmetric operators of  $W$ . Each  $\mathfrak{sl}(U_i^-)$  acts naturally in  $U_i^-$ , dually on  $U_i^+$ , and trivially on  $W$  and on  $U_j^+, U_j^-$  for  $j \neq i$ .  $\mathfrak{g}(W)$  acts naturally on  $W$  and trivially on  $F_k \oplus G_k$ . The center  $\mathfrak{z}$  of  $\mathfrak{l}$  acts on  $U_k^+$  by scalar transformations  $\lambda_k E$ , on  $U_k^-$  by  $-\lambda_k E$ , and trivially on  $W$ . Here  $\lambda_1, \dots, \lambda_k$  is a basis of  $\mathfrak{z}^*$ .

The choice of a compact form in  $\mathfrak{l}$  is equivalent to the choice of a compact form in each  $\mathfrak{sl}(U_i^-)$  (i.e. the choice of a Hermitian scalar product in  $U_i^-$ ) and a compact form  $\mathfrak{k}(W)$  of  $\mathfrak{g}(W)$ . We shall vary Hermitian scalar products in  $U_i^-$  later, but the compact real form of  $\mathfrak{g}(W)$  is to be fixed forever now. We fix a basis  $b_1, \dots, b_m$  of  $W$  such that the matrix of  $\omega$  in this basis is equal to  $I$ , where  $I = \text{Id}$  in the symmetric case and  $I = \begin{pmatrix} 0 & \text{Id} \\ -\text{Id} & 0 \end{pmatrix}$  in the skew-symmetric case. We fix a standard Hermitian form in  $W$  by formula  $\{u, v\} = \omega(u, I^t \bar{v})$ . Then the subalgebra  $\mathfrak{k}(W)$  of skew-Hermitian operators in  $\mathfrak{g}(W)$  is its compact real form.

Non-trivial  $\widehat{Z}$ -graded components of  $\mathfrak{g}$  can be described as follows.

- Any linear operator  $A_{ij} : U_i^+ \rightarrow U_j^+$ ,  $i \neq j$  gives by duality the linear operator  $A'_{ij} : U_j^- \rightarrow U_i^-$ . We define the skew-symmetric operator  $\tilde{A}_{ij}$  by setting  $\tilde{A}_{ij}|_{U_i^+} = A_{ij}$ ,  $\tilde{A}_{ij}|_{U_j^-} = -A'_{ij}$ , the restriction of  $\tilde{A}_{ij}$  on other components of the decomposition  $V = \bigoplus_k U_k^+ \oplus \bigoplus_k U_k^- \oplus W$  is trivial. These operators form  $\mathfrak{g}_{\lambda_j - \lambda_i}$ , which belongs to  $\mathfrak{n}$  if  $i > j$ .
- Any linear operator  $A'_i : W \rightarrow U_i^+$  (resp.  $A_i : W \rightarrow U_i^-$ ) determines by duality the linear operator  $A_i : U_i^- \rightarrow W$  (resp.  $A'_i : U_i^+ \rightarrow W$ ), where we identify  $W$  and  $W^*$ ,  $w \mapsto \omega(w, \cdot)$ . We define the skew-symmetric operator  $\tilde{A}_i$  by setting  $\tilde{A}_i|_W = A'_i$ ,  $\tilde{A}_i|_{U_i^\mp} = -A_i$ , the restriction of  $\tilde{A}_i$  on other components of the decomposition  $V = \bigoplus_k U_k^+ \oplus \bigoplus_k U_k^- \oplus W$  is trivial. These operators form  $\mathfrak{g}_{\lambda_i} \subset \mathfrak{n}$  (resp.  $\mathfrak{g}_{-\lambda_i}$ ).
- Any linear operator  $B_{ij} : U_i^- \rightarrow U_j^+$  (resp.  $B_{ij} : U_i^+ \rightarrow U_j^-$ ),  $i \neq j$  determines by duality the linear operator  $B'_{ij} : U_j^- \rightarrow U_i^+$  (resp.  $B'_{ij} : U_j^+ \rightarrow U_i^-$ ). We define the skew-symmetric operator  $\tilde{B}_{ij}$  with respect to  $\omega$  by setting  $\tilde{B}_{ij}|_{U_i^\mp} = B_{ij}$ ,  $\tilde{B}_{ij}|_{U_j^\pm} = -B'_{ij}$ , the restriction of  $\tilde{B}_{ij}$  on other components of the decomposition  $V = \bigoplus_k U_k^+ \oplus \bigoplus_k U_k^- \oplus W$  is trivial. These operators form  $\mathfrak{g}_{\lambda_i + \lambda_j} \subset \mathfrak{n}$  (resp.  $\mathfrak{g}_{-\lambda_i - \lambda_j}$ ).
- Finally, any skew-symmetric linear operator  $B_i : U_i^- \rightarrow U_i^+$  (resp.  $B_i : U_i^+ \rightarrow U_i^-$ ) defines the skew-symmetric operator  $\tilde{B}_i$  with respect to  $\omega$ :  $\tilde{B}_i|_{U_i^\mp} = B_i$ , the restriction of  $\tilde{B}_i$  on other components of the decomposition  $V = \bigoplus_k U_k^+ \oplus \bigoplus_k U_k^- \oplus W$  is trivial. These operators form  $\mathfrak{g}_{2\lambda_i} \subset \mathfrak{n}$  (resp.  $\mathfrak{g}_{-2\lambda_i}$ ). This component is

trivial if  $\dim U_i^+ = 1$ .

By Basic Lemma, if  $\mathfrak{g}_{2\chi} = 0$  then for any  $e \in \mathfrak{g}_\chi$  and for any compact form  $\mathfrak{k} \subset \mathfrak{l}$  there exists a homogeneous  $\mathfrak{sl}_2$  triple  $\langle e, h, f \rangle$  with a Hermitian characteristic  $h \in i\mathfrak{k}$ . Therefore, in our case it remains to prove that for any set of elements  $e_i \in \mathfrak{g}_{\lambda_i}$ ,  $i = 1 \dots k$  there exists a compact form  $\mathfrak{k} \subset \mathfrak{l}$  and a Hermitian multiple characteristic  $h_i \in i\mathfrak{k}$ ,  $i = 1, \dots, k$ .

Any  $e_i$  is defined by a linear map  $A_i : U_i^- \rightarrow W$ ,  $f_i \in \mathfrak{g}_{-\lambda_i}$  is defined by a linear map  $B_i : W \rightarrow U_i^-$ . Using the description of weighted components of  $\mathfrak{g}$  given above, it is easy to see that  $e_i$  and  $f_i$  can be embedded in a homogeneous  $\mathfrak{sl}_2$ -triple if and only if  $A_i$  and  $B_i$  satisfy the following system of matrix equations

$$2A_i = 2A_i B_i A_i - (A_i B_i)^\# A_i, \quad 2B_i = 2B_i A_i B_i - B_i (A_i B_i)^\#,$$

where for any  $A \in \text{Hom}(W, W)$  we denote by  $A^\#$  its adjoint operator with respect to  $\omega$ . Moreover, the characteristic of this  $\mathfrak{sl}_2$ -triple will be Hermitian if and only if

$$B_i A_i, \quad A_i B_i - (A_i B_i)^\# \text{ are Hermitian operators.}$$

Therefore, it remains to prove the following lemma.

**Lemma.** *Suppose that  $U = \mathbb{C}^n$ ,  $W = \mathbb{C}^k$  are complex vector spaces. Let  $\omega$  be a non-degenerate symmetric (resp. skew-symmetric) form on  $W$  with matrix  $I = \text{Id}$ , resp.  $I = \begin{pmatrix} 0 & \text{Id} \\ -\text{Id} & 0 \end{pmatrix}$ . We fix a standard Hermitian form in  $W$ . Let  $A \in \text{Hom}(U, W)$ . Then there exists a Hermitian form on  $U$  and an operator  $B \in \text{Hom}(W, U)$  such that*

$$2A = 2ABA - (AB)^\# A, \quad 2B = 2BAB - B(AB)^\#, \quad (*)$$

$$BA, \quad AB - (AB)^\# \text{ are Hermitian operators,} \quad (**)$$

where for any  $A \in \text{Hom}(W, W)$  we denote by  $A^\#$  its adjoint operator with respect to  $\omega$ .

*Proof.* Let  $W_0 = \text{Ker } \omega|_{\text{Im} A}$ , let  $W_1$  be the orthogonal complement to  $W_0$  in  $\text{Im} A$  w.r.t. the Hermitian form. Let  $U_2 = \text{Ker} A$ . Choose a subspace  $\tilde{U} \subset U$  complement to  $U_2$ . Then  $A$  defines a bijective linear map  $\tilde{A} : \tilde{U} \rightarrow \text{Im} A$ . Let  $U_0 = \tilde{A}^{-1}(W_0)$ ,  $U_1 = \tilde{A}^{-1}(W_1)$ . We fix a Hermitian form on  $U$  such that  $U_0$ ,  $U_1$ , and  $U_2$  are pairwise orthogonal and claim that the system of equations  $(*, **)$  has a solution.

Let  $W_2 = \overline{I W_0}$ , where bar denotes the complex conjugation. Then  $W_0 \cap W_2 = \{0\}$ , the restriction of  $\omega$  on  $W_0 \oplus W_2$  is non-degenerate, and  $W_0 \oplus W_2$  is orthogonal to  $W_1$  both w.r.t.  $\omega$  and w.r.t. the Hermitian form. Let  $W_3$  be the orthogonal complement to  $W_0 \oplus W_1 \oplus W_2$  w.r.t. the Hermitian form.

We define the operator  $B$  as follows:

$$B|_{W_0} = \tilde{A}^{-1}, \quad B|_{W_1} = 2\tilde{A}^{-1}, \quad B|_{W_2} = B|_{W_3} = 0.$$

Then we have

$$AB|_{W_0} = \text{Id}, \quad AB|_{W_1} = 2 \cdot \text{Id}, \quad AB|_{W_2} = AB|_{W_3} = 0,$$

therefore

$$(AB)^\#|_{W_0} = 0, (AB)^\#|_{W_1} = 2 \cdot \text{Id}, (AB)^\#|_{W_2} = \text{Id}, (AB)^\#|_{W_3} = 0.$$

Since  $W_0, W_1, W_2,$  and  $W_3$  are pairwise orthogonal w.r.t. the Hermitian form, it follows that  $AB - (AB)^\#$  is a Hermitian operator. It is easy to check that  $(*)$  holds. Now, we have

$$BA|_{U_0} = \text{Id}, BA|_{U_1} = 2 \cdot \text{Id}, BA|_{U_2} = 0.$$

Since  $U_0, U_1,$  and  $U_2$  are pairwise orthogonal w.r.t. the Hermitian form, it follows that  $BA$  is also a Hermitian operator.  $\square$

Now we prove Theorem 2. Until the end of this section “an algebraic subvariety” means “a union of locally closed subvarieties”. To avoid repetition, we consider the coadjoint case only, the adjoint case is absolutely similar.

Let  $e \in \mathfrak{n}$ . We need to prove that there exists  $p \in P$  such that  $\text{Ad}(p)e$  admits a multiple characteristic  $\{h_\chi\}$  with reductive  $\langle h_\chi \rangle_{alg}$ . At this point, without loss of generality, we may assume that  $k$  is embedded into  $\mathbb{C}$ . By Theorem 1, there exists  $p' \in P(\mathbb{C})$  such that  $\text{Ad}(p')e$  admits a Hermitian multiple characteristic  $\{h'_\chi\}$  (defined over  $\mathbb{C}$ ). It easily follows (see [Te1]) that  $\langle h'_\chi \rangle_{alg}$  is reductive. Let  $W \subset \mathfrak{n}$  be a subset of all points that admit a multiple characteristic  $\{h_\chi\}$  with reductive  $\langle h_\chi \rangle_{alg}$ . We are going to show that  $W$  is a subvariety defined over  $k$ . Then the argument above implies that  $\text{Ad}(P)e \cap W$  is non-empty over  $\mathbb{C}$  hence non-empty over  $k$  hence the Theorem.

Let  $n$  be the number of positive weights. Consider the variety of  $\mathfrak{sl}_2$ -triples

$$S \subset \bigoplus_{\chi < 0} \mathfrak{g}_\chi \oplus \mathfrak{g}_0^n \oplus \bigoplus_{\chi > 0} \mathfrak{g}_\chi,$$

$$S = \{f_\chi \in \mathfrak{g}_{-\chi}, h_\chi \in \mathfrak{g}_0, e_\chi \in \mathfrak{g}_\chi \mid [e_\chi, f_\chi] = h_\chi, [h_\chi, e_\chi] = 2e_\chi, [h_\chi, f_\chi] = -2f_\chi\}.$$

Let  $\pi_1$  denote the projection of  $S$  on  $\mathfrak{g}_0^n$ ,  $\pi_2$  denote the projection of  $S$  on  $\mathfrak{n}$ . These projections are defined over  $k$ . Let  $R$  denote the set of  $n$ -tuples of points  $(x_1, \dots, x_n) \in \mathfrak{g}_0^n$  such that  $\langle x_1, \dots, x_n \rangle_{alg}$  is reductive. Then, clearly,  $W = \pi_2(\pi_1^{-1}(R))$ . Therefore, it suffices to show that  $R$  is a subvariety of  $\mathfrak{g}_0^n$ . By a theorem of Richardson [Ri],  $\langle x_1, \dots, x_n \rangle_{alg}$  is reductive if and only if the orbit of  $(x_1, \dots, x_n) \in \mathfrak{g}_0^n$  is closed w.r.t. the diagonal action of  $L = G_0$ . It remains to notice that if a reductive group  $L$  acts on the affine variety  $X$  then the set of closed orbits  $Y \subset X$  is a subvariety. Indeed, one can argue using induction on  $\dim X$  and two following observations. If the action of  $G$  on  $X$  is not stable (i.e. a generic  $G$ -orbit in  $X$  is not closed) then there exists a proper closed subvariety  $X_0 \subset X$  that contains all closed orbits, [Vi]. If the action of  $G$  on  $X$  is stable, then we can choose an open  $G$ -invariant subset  $U \subset X$  such that all orbits in  $U$  are closed in  $X$ . Then we may pass from  $X$  to  $X \setminus U$ .

### §3. EXCEPTIONAL GROUPS

**§3.0. Comparison Lemma.** It follows from Basic Lemma that if all positive weights  $\chi \in \widehat{Z}$  are reduced except at most one, then the corresponding parabolic subgroup is weakly ample. Therefore, we need to prove Theorem 1 only for parabolic subgroups such that there exist two or more not reduced  $\widehat{Z}$ -weights. Moreover, some not reduced weights may also correspond to ample components of the grading. The following lemma provides a lot of examples.

**Comparison Lemma.** *Let  $G'$  and  $G''$  be reductive algebraic groups with Lie algebras  $\mathfrak{g}'$  and  $\mathfrak{g}''$ , parabolic subgroups  $P' \subset G'$  and  $P'' \subset G''$ , Levi subgroups  $L' \subset P'$  and  $L'' \subset P''$ . Let  $Z'$  and  $Z''$  be the centers of  $L'$  and  $L''$ . Consider positive weights  $\chi' \in \widehat{Z}'$  and  $\chi'' \in \widehat{Z}''$ . Suppose that  $[L', L'] = [L'', L''] = H$  and  $H$ -modules  $\mathfrak{g}'_{\chi'}$  and  $\mathfrak{g}''_{\chi''}$  coincide. Suppose that  $H$  is either simple or isomorphic to  $SL_n \times SL_m$ , in which case  $\mathfrak{g}'_{\chi'} \simeq \mathfrak{g}''_{\chi''} \simeq \mathbb{C}^n \otimes \mathbb{C}^m$  as an  $H$ -module. Then, the  $\widehat{Z}'$ -grading of  $\mathfrak{g}'$  is ample in degree  $\chi'$  iff the  $\widehat{Z}''$ -grading of  $\mathfrak{g}''$  is ample in degree  $\chi''$ .*

*Proof.* We may assume without loss of generality that  $P'$  and  $P''$  are maximal parabolic subgroups. Let  $\mathfrak{h}$  be the Lie algebra of  $H$ . Consider two local Lie algebras  $\mathfrak{g}'_{-\chi'} \oplus \mathfrak{g}'_0 \oplus \mathfrak{g}'_{\chi'}$  and  $\mathfrak{g}''_{-\chi''} \oplus \mathfrak{g}''_0 \oplus \mathfrak{g}''_{\chi''}$ . We choose  $c' \in \mathfrak{z}'$  and  $c'' \in \mathfrak{z}''$  such that  $\text{ad}(c')|_{\mathfrak{g}'_{\pm\chi'}} = \pm \text{Id}$  and  $\text{ad}(c'')|_{\mathfrak{g}''_{\pm\chi''}} = \pm \text{Id}$ . Then  $\mathfrak{g}'_0 = \mathbb{C}c' \oplus \mathfrak{h}$  and  $\mathfrak{g}''_0 = \mathbb{C}c'' \oplus \mathfrak{h}$ . We fix compact real forms  $\mathfrak{k}' \subset \mathfrak{g}'_0$  and  $\mathfrak{k}'' \subset \mathfrak{g}''_0$ . Then  $\mathfrak{k}' = i\mathbb{R}c' \oplus \mathfrak{m}$  and  $\mathfrak{k}'' = i\mathbb{R}c'' \oplus \mathfrak{m}$ , where  $\mathfrak{m}$  is a compact real form in  $\mathfrak{h}$ . Suppose that  $e' \in \mathfrak{g}'_{\chi'}$  and the  $\widehat{Z}'$ -grading of  $\mathfrak{g}'$  is ample in degree  $\chi'$ . Then there exists  $f' \in \mathfrak{g}'_{-\chi'}$  such that  $\langle e', h' = [e', f'], f' \rangle$  is an  $\mathfrak{sl}_2$ -triple and  $h' \in i\mathfrak{k}'$ . Let  $h' = h'_1 + h'_2$ , where  $h'_1 \in i\mathbb{R}c'$  and  $h'_2 \in i\mathfrak{m}$ . Let  $\mathfrak{h} = \oplus \mathfrak{h}_p$  be the direct sum of simple Lie algebras. Then we have the corresponding decomposition  $\mathfrak{m} = \oplus \mathfrak{m}_p$  and  $h'_2 = \sum (h'_2)_p$ . We can identify  $\mathfrak{g}'_0$  and  $\mathfrak{g}''_0$  as Lie algebras by assigning  $c''$  to  $c'$ . Then we can identify  $\mathfrak{g}'_{\chi'}$  with  $\mathfrak{g}''_{\chi''}$  and  $\mathfrak{g}'_{-\chi'}$  with  $\mathfrak{g}''_{-\chi''}$  as their modules. Let  $e'' \in \mathfrak{g}''_{\chi''}$  corresponds to  $e'$  and  $f'' \in \mathfrak{g}''_{-\chi''}$  corresponds to  $f'$ . Let  $h'' = [e'', f''] = h''_1 + h''_2$ , where  $h''_1 \in \mathbb{C}c''$  and  $h''_2 \in \mathfrak{h}$ ,  $h''_2 = \sum (h''_2)_p$ . We claim that  $h'' \in i\mathfrak{k}''$  and its real multiple is a characteristic of  $e''$ . It would follow that the  $\widehat{Z}''$ -grading of  $\mathfrak{g}''$  is ample in degree  $\chi''$ .

Let  $\tilde{h}' = \tilde{h}'_1 + \tilde{h}'_2$  be the corresponding element of  $\mathfrak{g}'_0$ , where  $\tilde{h}'_1 \in \mathbb{C}c'$  and  $\tilde{h}'_2 \in \mathfrak{h}$ ,  $\tilde{h}'_2 = \sum (\tilde{h}'_2)_p$ . It is sufficient to prove that  $\tilde{h}'_1 = \alpha h'_1$  and  $(\tilde{h}'_2)_p = \beta_p (h'_2)_p$ , where  $\alpha$  and  $\beta$  are positive real numbers (here we use our restrictions on  $H$ ). The commutator maps

$$\Phi' : \mathfrak{g}'_{-\chi'} \otimes \mathfrak{g}'_{\chi'} \rightarrow \mathfrak{g}'_0 \quad \text{and} \quad \Phi'' : \mathfrak{g}''_{-\chi''} \otimes \mathfrak{g}''_{\chi''} \rightarrow \mathfrak{g}''_0$$

can be decomposed as  $\Phi' = \Omega' \circ \Psi'$ ,  $\Phi'' = \Omega'' \circ \Psi''$ , where  $\Psi'$  and  $\Psi''$  are moment maps and  $\Omega' : (\mathfrak{g}'_0)^* \rightarrow \mathfrak{g}'_0$ ,  $\Omega'' : (\mathfrak{g}''_0)^* \rightarrow \mathfrak{g}''_0$  are pairings given  $K'$  and  $K''$ , where  $K'$ ,  $K''$  are restrictions of the Killing forms in  $\mathfrak{g}'$  and  $\mathfrak{g}''$  on  $\mathfrak{g}'_0$  and  $\mathfrak{g}''_0$ . Under the identifications above we have  $\Psi' = \Psi''$ . It remains to notice that  $\mathbb{C}c'$  is orthogonal to  $\mathfrak{h}$  under  $K'$ ,  $\mathbb{C}c''$  is orthogonal to  $\mathfrak{h}$  under  $K''$ , restrictions of  $K'$  and  $K''$  on  $(\mathfrak{h})_p$  coincide with the Killing form of  $(\mathfrak{h})_p$  multiplied by a positive real number,  $K'(c', c')$  and  $K''(c'', c'')$  are both real and positive.  $\square$

We can use this lemma and examples of ample maximal parabolic subgroups in classical groups obtained in [Te1] to verify that all parabolic subgroups not listed in the table at the end of the paper are weakly ample (this is simple combinatorics).

In particular, we see that all parabolic subgroups in  $G_2$ ,  $F_4$  and  $E_6$  are weakly ample. Theorem 1 for the entries 1–37 from the table will be checked in the next sections. Entries 38–59 will be verified in the sequel of this paper.

**3.1. Non-degenerate Deformations.** A projective variety  $X \subset \mathbb{P}(V)$  is called a 2-variety if it is cut out by quadrics, i.e. its homogeneous ideal  $I \in \mathbb{C}[V]$  is generated by  $I_2$ . For example, if  $G$  is a semi-simple Lie group and  $V$  is an irreducible  $G$ -module then the projectivization of the cone of highest weight vectors in  $V$  is a 2-variety by [Li]. Suppose that  $X \subset \mathbb{P}(V)$  is a 2-variety. A linear map  $A : \mathbb{C}^2 \rightarrow V$  is called degenerate if  $\dim \text{Im} A = 2$  and  $\mathbb{P}(\text{Im} A) \cap X$  is a point.

**Proposition 1.**

(A) If  $A : \mathbb{C}^2 \rightarrow V$  is degenerate,  $B \in \text{Hom}(\mathbb{C}^2, \mathbb{C}^p)$  is non trivial, then there exists  $C \in \text{Hom}(\mathbb{C}^p, V)$  such that  $A + CB$  is non-degenerate.

(B) If  $A, B : \mathbb{C}^2 \rightarrow V$  are degenerate, then there exists  $E \in \text{Hom}(\mathbb{C}^2, \mathbb{C}^2)$  such that  $A + BE$  is non-degenerate.

(C) Suppose  $A : \mathbb{C}^2 \rightarrow V$  is degenerate,  $v \in V$  does not belong to the cone over  $X$ . Then there exists  $f \in (\mathbb{C}^2)^*$  such that  $A + v \cdot f$  is non-degenerate.

*Proof.* (A) Clearly, we can choose  $C$  such that  $\dim \text{Im}(A + CB) < 2$ .

(B) If  $(\text{Im}A) \cap (\text{Im}B) \neq 0$  then there exists  $E \in \text{Hom}(\mathbb{C}^2, \mathbb{C}^2)$  such that we have inequality  $\dim \text{Im}(A + BE) < 2$  and we are done. Otherwise, let  $V_0 = (\text{Im}A) + (\text{Im}B)$ ,  $X_0 = X \cap \mathbb{P}(V_0)$ . Clearly,  $\dim V_0 = 4$  and  $X_0$  is a 2-variety in  $\mathbb{P}(V_0)$ . We take skew lines  $l_0 = \mathbb{P}(\text{Im}A)$  and  $l_1 = \mathbb{P}(\text{Im}B)$ . Each of them intersects  $X_0$  at a point. For any  $E \in \text{Hom}(\mathbb{C}^2, \mathbb{C}^2)$ ,  $\dim \text{Im}(A + BE) = 2$ . A line  $l \subset \mathbb{P}(V_0)$  is equal to  $\mathbb{P}(\text{Im}(A + BE))$  for some  $E \in \text{Hom}(\mathbb{C}^2, \mathbb{C}^2)$  if and only if  $l \cap l_1 = \emptyset$ .

Clearly,  $\dim X_0 < 3$ . If  $\dim X_0 < 2$  then there exists a line  $l \subset \mathbb{P}(V_0)$  such that  $l \cap l_1 = l \cap X_0 = \emptyset$  and we are done. Otherwise, since  $l_1 \not\subset X_0$ , there exist hyperplanes  $H_1, H_2 \subset \mathbb{P}(V)$  and points  $p_1 \in H_1$ ,  $p_2 \in H_2$  such that  $l_1 = H_1 \cap H_2$ ,  $p_1, p_2 \notin l_1$ ,  $p_1, p_2 \in X_0$ . Then the line  $l$  connecting  $p_1$  and  $p_2$  does not intersect  $l_1$  and either intersects  $X_0$  in two points or belongs to  $X_0$ .

(C) Indeed, if  $v \in \text{Im}A$ , then we can find  $f$  such that  $\dim \text{Im}(A + v \cdot f) < 2$ . Suppose that  $v \notin \text{Im}A$ . Then any 2-dimensional subspace in  $U = \langle v \rangle + \text{Im}A$  not containing  $v$  can be realised as  $\text{Im}(A + v \cdot f)$  for some  $f$ . Let  $Y = \mathbb{P}U \cap X$ ,  $b \in \mathbb{P}U$  be the point corresponding to  $v$ . Then  $b \notin Y$ . We need to find a line  $l$  in  $\mathbb{P}U$  such that  $b \notin l$  and  $l \cap Y$  is not a point. If  $\dim Y = 0$ , then we can find a line that does not intersect  $b$  and  $Y$  at all. If  $\dim Y = 1$  and  $Y$  has a line as an irreducible component, then we can take this component as a line we are looking for. Finally, in remaining cases a generic line in  $\mathbb{P}U$  intersects  $Y$  in more than one (actually, two) points.  $\square$

**3.2. Kac Theorem.** Consider the  $\widehat{Z}$ -graded reductive Lie algebra  $\mathfrak{g} = \bigoplus_{\chi \in \widehat{Z}} \mathfrak{g}_\chi$ ,  $\chi \neq 0$ . Let  $\mathcal{O}$  denote the open  $L$ -orbit in  $\mathfrak{g}_\chi$ ,  $e \in \mathcal{O}$ . Kac has proved in [Ka] that there exists an  $\mathfrak{sl}_2$ -triple  $\langle e, h, f \rangle$  with  $h \in \mathfrak{z}$  if and only if the complement of  $\mathcal{O}$  has codimension 1. In particular, we have the following proposition

**Proposition 2.** *If  $\mathcal{O}$  is open and its complement has codimension 1, then  $\mathcal{O}$  is ample.*

The list of representations of  $[L, L]$  on  $\mathfrak{g}_\chi$  with the above property can be found in [loc. cit.].

**3.3. Witt Theorem.** The following proposition is well known as Witt Theorem.

**Proposition 3.** *Consider a vector space  $W$  endowed with a non-degenerate quadratic form  $Q$ . Orbits of  $GL(V) \times O(W)$  on  $\text{Hom}(V, W)$  are parametrized by pairs of integers  $(i, j)$  such that*

$$0 \leq i \leq \min(\dim V, \dim W), \quad 0 \leq j \leq \min(i, \dim W - i).$$

Here  $A \in \text{Hom}(V, W)$  corresponds to the pair  $(\dim A, \dim \text{Ker } Q|_{\dim A})$ .

With respect to the action of  $GL(V) \times SO(W)$ , some of these orbits may split into two orbits. This action appears as the action of a Levi subgroup of a maximal



parabolic subgroup in  $G = \mathrm{SO}_n$  on  $\mathfrak{g}_1$ . It was shown in [Te1] that ample orbits correspond to pairs  $(k, 0)$  and  $(k, k)$ . More precisely, a linear map  $A : \mathbb{C}^k \rightarrow \mathbb{C}^n$  (or the corresponding tensor  $\tilde{A} \in (\mathbb{C}^k)^* \otimes \mathbb{C}^n$ , where  $\mathbb{C}^n$  is endowed with a non-degenerate scalar product, is called ample if the restriction of the scalar product in  $\mathbb{C}^n$  on  $\mathrm{Im}A$  is either non-degenerate or trivial.

**Proposition 4.** *Let  $V = \mathbb{C}^n$  be endowed with a non-degenerate scalar product.*

(A) *Let  $k \leq 3$  or  $k = n = 4$ . Suppose that a linear map  $A : \mathbb{C}^k \rightarrow V$  is not ample, and a linear map  $B : \mathbb{C}^k \rightarrow \mathbb{C}^p$  is not trivial. Then  $A + CB$  is ample for some  $C \in \mathrm{Hom}(\mathbb{C}^p, V)$ .*

(B) *Let  $n \leq 4$ . Suppose that the linear map  $A : \mathbb{C}^k \rightarrow V$  is not ample,  $v \in V$  is not trivial. Then there exists a linear function  $f : (\mathbb{C}^k)^*$  such that  $A + v \cdot f$  is ample.*

*Proof.* Simple calculation.  $\square$

The tensor  $\tilde{A} \in \mathbb{C}^k \otimes \mathbb{C}^2 \otimes \mathbb{C}^2$  may be considered as a linear map  $A_0 : (\mathbb{C}^k)^* \rightarrow (\mathbb{C}^2 \otimes \mathbb{C}^2)$ . The space  $\mathbb{C}^2 \otimes \mathbb{C}^2$  has a canonical quadratic form  $\det$ .  $\tilde{A}$  is called not ample if restriction of  $\det$  on  $\mathrm{Im}A_0$  is degenerate but not trivial.  $\tilde{A}$  may also be viewed as a linear map  $A : (\mathbb{C}^2)^* \rightarrow (\mathbb{C}^2 \otimes \mathbb{C}^k)$ . Then  $\tilde{A}$  is not ample if and only if  $\mathrm{Im}A$  is 2-dimensional and  $(\mathrm{Im}A) \cap R$  is a line, where  $R \subset \mathbb{C}^2 \otimes \mathbb{C}^k$  is the variety of rank 1 matrices.

**Proposition 5.**

(A) *Suppose that linear maps  $A : \mathbb{C}^2 \rightarrow (\mathbb{C}^2 \otimes \mathbb{C}^3)$  and  $B : \mathbb{C}^2 \rightarrow (\mathbb{C}^2 \otimes \Lambda^2 \mathbb{C}^3)$  are not ample. Then there exists  $E \in \mathrm{End}(\mathbb{C}^2) \otimes \mathbb{C}^3$  such that  $B + E \circ A$  is ample, here we embed  $\mathbb{C}^3$  in  $\mathrm{Hom}(\mathbb{C}^3, \Lambda^2 \mathbb{C}^3)$  in the obvious way.*

(B) *Suppose that the linear map  $A : \Lambda^2 \mathbb{C}^3 \rightarrow (\mathbb{C}^2 \otimes \mathbb{C}^2)$  is not ample,  $B \in \mathrm{Hom}(\mathbb{C}^3, \mathbb{C}^2)$  is not trivial. Then there exists a linear map  $C \in \mathrm{Hom}(\mathbb{C}^3, \mathbb{C}^2)$  such that  $A + B \wedge C$  is ample.*

(C) *Let  $v \in \mathbb{C}^3$ ,  $v \neq 0$ ,  $B \in (\Lambda^2 \mathbb{C}^3) \otimes \mathbb{C}^2$ . Then there exists  $A \in \mathbb{C}^3 \otimes \mathbb{C}^2$  such that  $B + v \wedge A \in (\Lambda^2 \mathbb{C}^3) \otimes \mathbb{C}^2$  has rank 2.*

*Proof.* (A) Direct calculation shows that there exists  $E_0 \in \mathrm{End}(\mathbb{C}^2) \otimes \mathbb{C}^3$  such that  $E_0 \circ A$  belongs to the open orbit in  $\mathrm{Hom}(\mathbb{C}^2, \mathbb{C}^2 \otimes \Lambda^2 \mathbb{C}^3)$  w.r.t. the group  $G = \mathrm{GL}_2 \times \mathrm{GL}_2 \times \mathrm{GL}_3$ . This complement of this orbit has codimension 1, therefore there exists  $\lambda \in \mathbb{C}$  such that  $B + \lambda E_0 \circ A$  belongs to this open orbit. Now we can take  $E = \lambda E_0$  by Proposition 2.

(B) Suppose first that  $\dim \mathrm{Im}B = 2$ . We take a basis  $\{e_1, e_2, e_3\}$  of  $\mathbb{C}^3$  such that  $B(e_3) = 0$ . If we take  $C$  such that  $C(e_3) = 0$ , then  $B \wedge C(e_1 \wedge e_3) = B \wedge C(e_2 \wedge e_3) = 0$  and  $B \wedge C(e_1 \wedge e_2)$  can be made arbitrary. Thus we are done by Proposition 4.A.

Suppose now that  $\dim \mathrm{Im}B = 1$ . Then the linear space of all possible maps of the form  $B \wedge C$  consists of all linear maps  $X : \Lambda^2 \mathbb{C}^3 \rightarrow (\mathbb{C}^2 \otimes \mathbb{C}^2)$  such that  $\mathrm{Ker}X \supset R$  and  $\mathrm{Im}X \subset L$ , where  $R \subset \mathbb{C}^3$  is a fixed 1-dimensional subspace and  $L \subset \mathbb{C}^2 \otimes \mathbb{C}^2$  is a fixed 2-dimensional subspace isotropic w.r.t.  $\det$ . We need to consider two cases:  $\dim \mathrm{Im}A = 2$  and  $\dim \mathrm{Im}A = 3$ .

Let  $\dim \mathrm{Im}A = 2$ . We fix a basis  $\{e_1, e_2, e_3\}$  of  $\Lambda^2 \mathbb{C}^3$  such that  $A(e_1) = 0$  and  $v = A(e_2)$  spans the kernel of restriction of  $\det$  on  $\langle v, u \rangle$ , where  $u = A(e_3)$ . Clearly, we may assume that  $R$  is spanned by  $e_1, e_2$ , or  $e_3$ . If  $R = \mathbb{C}e_1$  and  $L \cap \langle v, u \rangle = 0$  then we can choose  $X$  such that  $\mathrm{Im}(A + X)$  is an arbitrary 2-dimensional subspace not intersecting  $L$  and the claim obviously follows. If  $R = \mathbb{C}e_1$  and  $L \cap \langle v, u \rangle \neq 0$  then we can choose  $X$  such that  $\dim(A + X) < 2$  and we are done. If  $R = \mathbb{C}e_2$  and

$v \notin L$  then we can find  $w \in L$  such that  $v$  and  $w$  are not orthogonal. Then we take the map  $X$  such that  $X(e_1) = w$ ,  $X(e_3) = 0$ .  $\text{Im}(A + X)$  is 3-dimensional and non-degenerate w.r.t. det. If  $R = \mathbb{C}e_2$  and  $v \in L$  then we take  $X$  such that  $X(e_1) = 0$  and  $u + X(e_3)$  is isotropic w.r.t. det. This is possible, because the orthogonal complement to  $L$  is  $L$  itself, but  $u \notin L$ . Then  $\text{Im}(A + X)$  is 2-dimensional and isotropic w.r.t. det. If  $R = \mathbb{C}e_3$  and  $v \notin L$  then we can find  $w \in L$  such that  $v$  and  $w$  are not orthogonal. Then we take the map  $X$  such that  $X(e_1) = w$ ,  $X(e_2) = 0$ .  $\text{Im}(A + X)$  is 3-dimensional and non-degenerate w.r.t. det. If  $R = \mathbb{C}e_3$  and  $v \in L$  then we take  $X$  such that  $X(e_2) = -v$  and  $X(e_1)$  is not orthogonal to  $u$  w.r.t. det. This is possible, because the orthogonal complement to  $L$  is  $L$  itself, but  $u \notin L$ . Then  $\text{Im}(A + X)$  is 2-dimensional and non-degenerate w.r.t. det.

Now let  $\dim \text{Im} A = 3$ . We fix a basis  $\{e_1, e_2, e_3\}$  of  $\Lambda^2 \mathbb{C}^3$  such that  $v = A(e_1)$  spans the kernel of restriction of det on  $\text{Im} A$ ,  $u = A(e_2)$  and  $w = A(e_3)$  are isotropic. We may assume that  $R$  either belongs to  $\langle e_2, e_3 \rangle$  or coincides with  $\mathbb{C}e_1$ .

Let  $R \subset \langle e_2, e_3 \rangle$ . If  $v \notin L$ , then we take  $x \in L$  such that  $v$  is not orthogonal to  $x$ . We take an operator  $X$  such that  $X(e_2) = X(e_3) = 0$ ,  $X(e_1) = \lambda x$ ,  $\lambda \in \mathbb{C}$ . Then  $\text{Im}(A + X)$  is 3-dimensional and non-degenerate w.r.t. det for generic  $\lambda$ . If  $v \in L$ , then we take  $X$  such that  $X(e_1) = -v$ ,  $X(e_2) = X(e_3) = 0$ . Then  $\text{Im}(A + X)$  is 2-dimensional and non-degenerate w.r.t. det.

Let  $R = \mathbb{C}e_1$ . If  $v \notin L$ , then we take  $x \in L$  such that  $v$  is not orthogonal to  $x$ . We take an operator  $X$  such that  $X(e_1) = 0$ ,  $X(e_2) = X(e_3) = x$ . Then  $\text{Im}(A + X)$  is 3-dimensional and non-degenerate w.r.t. det. If  $v \in L$  then either  $L = \langle v, u \rangle$  or  $L = \langle v, w \rangle$ . It is sufficient to consider only the first case. We take  $X$  such that  $X(e_1) = 0$ ,  $X(e_2) = -u$ ,  $X(e_3) = 0$ . Then  $\text{Im}(A + X) = \langle v, w \rangle$  is 2-dimensional and isotropic.

(C) We fix a basis  $\{e_1, e_2, e_3\}$  of  $\mathbb{C}^3$  such that  $v = e_1$  and a basis  $\{f_1, f_2\}$  of  $\mathbb{C}^2$ . We take  $A = e_2 \otimes f_1 + e_3 \otimes f_2$ . Then  $v \wedge A = (e_1 \wedge e_2) \otimes f_1 + (e_1 \wedge e_3) \otimes f_2$  has rank 2. Therefore,  $B + v \wedge \lambda A$  has rank 2 for some  $\lambda \in \mathbb{C}$ .  $\square$

A tensor  $\tilde{A} \in \mathbb{C}^k \otimes \Lambda^2 \mathbb{C}^4$  is called ample, if restriction of the quadratic form Pf on  $\text{Im} A$  is trivial or non-degenerate, where  $A : (\mathbb{C}^k)^* \rightarrow \Lambda^2 \mathbb{C}^4$  is the corresponding map.

**Proposition 6.**

- (A) Suppose that linear maps  $A : \mathbb{C}^2 \rightarrow \Lambda^2 \mathbb{C}^4$  and  $B : \mathbb{C}^2 \otimes \mathbb{C}^2 \rightarrow \Lambda^3 \mathbb{C}^4$  are not ample. Then there exists a map  $C : \mathbb{C}^2 \rightarrow \mathbb{C}^4$  such that  $B + A \wedge C$  is ample.
- (B) Suppose that linear maps  $A : \Lambda^2 \mathbb{C}^4 \rightarrow \mathbb{C}^2$  and  $B : \mathbb{C}^4 \rightarrow (\mathbb{C}^2 \otimes \mathbb{C}^2)$  are not ample. Then there exists a map  $C : \mathbb{C}^4 \rightarrow (\mathbb{C}^2)^* \otimes \mathbb{C}$  such that  $A + B \wedge C$  is ample.
- (C) Suppose that a linear map  $A : \mathbb{C}^2 \rightarrow \Lambda^2 \mathbb{C}^4$  is not ample,  $w \in \mathbb{C}^4$  is not trivial. Then there exists a map  $B : \mathbb{C}^2 \rightarrow \mathbb{C}^4$  such that  $A + w \wedge B$  is ample.
- (D) Suppose that  $A \in \mathbb{C}^4 \otimes \Lambda^2 \mathbb{C}^4$  is not ample. If  $B \in \Lambda^2 \mathbb{C}^4 \otimes \Lambda^3 \mathbb{C}^4$  is not ample, then there exists  $C \in \mathbb{C}^4 \otimes \mathbb{C}^4$  such that  $B + A \wedge C$  is ample.
- (E) Suppose that  $A \in \mathbb{C}^4 \otimes \Lambda^2 \mathbb{C}^4$  is not ample. If  $u \in \mathbb{C}^4$ ,  $u \neq 0$ , then there exists  $C = \sum v_i \otimes w_i \in \mathbb{C}^4 \otimes \mathbb{C}^4$  such that  $A + \sum v_i \otimes (w_i \wedge u)$  is ample.

*Proof.* (A) It suffices to find  $C$  such that  $A \wedge C$  belongs to the open orbit, because it is ample. We fix bases  $\{e_1, e_2, e_3, e_4\}$  of  $\mathbb{C}^4$ ,  $\{f_1, f_2\}$  of the first  $\mathbb{C}^2$ ,  $\{g_1, g_2\}$  of the second  $\mathbb{C}^2$ . We may assume that  $A(f_1) = e_1 \wedge e_2 + e_3 \wedge e_4$ ,  $A(f_2) = e_1 \wedge e_3$ . Consider  $C$  such that  $C(g_1) = e_4$ ,  $C(g_2) = e_2$ . Then  $A \wedge C$  is an isomorphism.

(B) If  $\dim B = 3$ , then there exists a map  $C : \mathbb{C}^4 \rightarrow (\mathbb{C}^2)^* \otimes \mathbb{C}$  such that  $A + B \wedge C$

belongs to the open orbit, hence it is ample. Let  $\dim B = 2$ . Simple calculations show that we need to prove the following claim.

Let  $\{e_1, e_2, e_3, e_4\}$  (resp.  $\{f_1, f_2\}$ ) be a basis of  $\mathbb{C}^4$  (resp. of  $\mathbb{C}^2$ ). Suppose that the map  $A : \mathbb{C}^2 \rightarrow \Lambda^2 \mathbb{C}^4$  is not ample. Then we claim that there exist vectors  $v, u \in \mathbb{C}^4$  such that the map  $B$  is ample, where  $B(f_1) = A(f_1) + e_1 \wedge u$ ,  $B(f_2) = A(f_2) + e_2 \wedge u + e_1 \wedge v$ . Indeed,  $\dim \text{Im} A = 2$  and we may assume that either  $A(f_1)$  or  $A(f_2)$  spans the kernel of restriction of Pf on  $\text{Im} A$ . Consider the first case. If  $A(f_1) = e_1 \wedge w$ , then we take  $v = 0$ ,  $u = -w$ . If  $A(f_1)$  is not of the form  $e_1 \wedge w$ , then there exists  $v$  such that  $A(f_1) \wedge e_1 \wedge v \neq 0$ . If we take  $u = 0$ , then  $B$  is ample. Consider the second case. Since  $A(f_1) \wedge A(f_2) \neq 0$ , we can find  $w$  such that  $A(f_1) \wedge e_1 \wedge w \neq 0$ . If  $v = \lambda w$  and  $u = 0$ , then  $B$  is ample for generic  $\lambda \in \mathbb{C}$ .

(C) We fix a basis  $\{e_1, e_2, e_3, e_4\}$  of  $\mathbb{C}^4$  such that  $w = e_1$  and a basis  $\{f_1, f_2\}$  such that  $A(f_1)$  spans the kernel of restriction of Pf on  $\text{Im} A$ . We need to prove that there exist  $u, v \in \mathbb{C}^4$  such that the linear map  $C : \mathbb{C}^2 \rightarrow \Lambda^2 \mathbb{C}^4$  is ample, where  $C(f_1) = A(f_1) + e_1 \wedge u$ ,  $C(f_2) = A(f_2) + e_1 \wedge v$ . If  $A(f_1) = e_1 \wedge x$ , then it suffices to take  $u = -x$ . Otherwise, we take  $u = 0$  and we choose  $v$  such that  $A(f_1) \wedge e_1 \wedge v \neq 0$ . Then  $\dim \text{Im} C = 2$  and restriction of Pf on  $\text{Im} C$  is non-degenerate.

(D) and (E). Let  $\tilde{A} : (\mathbb{C}^4)^* \rightarrow \Lambda^2 \mathbb{C}^4$  be the corresponding map. Since restriction of Pf on  $\text{Im} \tilde{A}$  is degenerate but not-trivial, in the suitable bases  $A$  has one of the following forms:

$$A_1 = e_1 \otimes (f_1 \wedge f_2 + f_3 \wedge f_4) + e_2 \otimes (f_1 \wedge f_3),$$

$$A_2 = e_1 \otimes (f_1 \wedge f_2 + f_3 \wedge f_4) + e_2 \otimes (f_1 \wedge f_3) + e_3 \otimes (f_1 \wedge f_4),$$

$$A_3 = e_1 \otimes (f_1 \wedge f_2 + f_3 \wedge f_4) + e_2 \otimes (f_1 \wedge f_3) + e_3 \otimes (f_3 \wedge f_4),$$

$$A_4 = e_1 \otimes (f_1 \wedge f_2 + f_3 \wedge f_4) + e_2 \otimes (f_1 \wedge f_3) + e_3 \otimes (f_1 \wedge f_4) + e_4 \otimes (f_1 \wedge f_2),$$

$$A_5 = e_1 \otimes (f_1 \wedge f_2 + f_3 \wedge f_4) + e_2 \otimes (f_1 \wedge f_3) + e_3 \otimes (f_1 \wedge f_4) + e_4 \otimes (f_2 \wedge f_4).$$

(D) We take  $C = e_3 \otimes f_2 + e_4 \otimes f_4$ . Then

$$\begin{aligned} A \wedge C &= (e_1 \wedge e_3) \otimes (f_2 \wedge f_3 \wedge f_4) - (e_2 \wedge e_3) \otimes (f_1 \wedge f_2 \wedge f_3) + \\ &+ (e_1 \wedge e_4) \otimes (f_1 \wedge f_2 \wedge f_4) + (e_2 \wedge e_4) \otimes (f_1 \wedge f_3 \wedge f_4). \end{aligned}$$

Restriction of Pf on the 4-dimensional image of the corresponding map is non-degenerate, so  $A \wedge C$  belongs to the open orbit, which is ample by the results of §3.2. Therefore,  $B + A \wedge (\lambda C)$  is also ample for some  $\lambda \in \mathbb{C}$ .

(E) Let  $A = A_1$ . If  $u \in \langle f_1, f_3 \rangle$ , then we take  $C = e_2 \otimes u'$  such that  $u' \wedge u = -f_1 \wedge f_3$ . If  $u \notin \langle f_1, f_3 \rangle$ , then there exists  $u'$  such that  $f_1 \wedge f_3 \wedge u' \wedge u \neq 0$  and we take  $C = e_1 \otimes u'$ .

Let  $A = A_2$  or  $A_4$ . If  $u \notin \langle f_1, f_3 \rangle$ , then there exists  $u'$  such that  $f_1 \wedge f_3 \wedge u' \wedge u \neq 0$  and we take  $C = e_3 \otimes u'$ . If  $u \notin \langle f_1, f_4 \rangle$ , then there exists  $u'$  such that  $f_1 \wedge f_4 \wedge u' \wedge u \neq 0$  and we take  $C = e_2 \otimes u'$ . Finally, if  $u = \lambda f_1$ , then we take  $C = (e_2 \otimes f_3 + e_3 \otimes f_4) / \lambda$ .

Let  $A = A_3$ . If  $u \in \langle f_1, f_3 \rangle$ , then we take  $C = e_2 \otimes u'$  such that  $u' \wedge u = -f_1 \wedge f_3$ . If  $u \notin \langle f_1, f_3 \rangle$ , then there exists  $u'$  such that  $f_1 \wedge f_3 \wedge u' \wedge u \neq 0$  and we take  $C = e_3 \otimes u'$ .

Let  $A = A_5$ . If  $u \in \langle f_1, f_4 \rangle$ , then we take  $C = e_3 \otimes u'$  such that  $u' \wedge u = -f_1 \wedge f_4$ . If  $u \notin \langle f_1, f_4 \rangle$ , then there exists  $u'$  such that  $f_1 \wedge f_4 \wedge u' \wedge u \neq 0$  and we take  $C = e_1 \otimes u'$ .  $\square$

### 3.4. Spinors.

We recall the definition of half-spinor representations. Let  $V = \mathbb{C}^{2m}$  be an even-dimensional vector space with a non-degenerate symmetric scalar product  $(\cdot, \cdot)$ . Let  $\text{Cl}(V)$  be the Clifford algebra of  $V$ . Recall that  $\text{Cl}(V)$  is in fact a superalgebra,  $\text{Cl}(V) = \text{Cl}^0(V) \oplus \text{Cl}^1(V)$ , where  $\text{Cl}^0(V)$  (resp.  $\text{Cl}^1(V)$ ) is a linear span of elements of the form  $v_1 \cdot \dots \cdot v_r$ ,  $v_i \in V$ ,  $r$  is even (resp.  $r$  is odd). Then we have

$$\text{Spin}(V) = \{a \in \text{Cl}^0(V) \mid a = v_1 \cdot \dots \cdot v_r, v_i \in V, Q(v_i, v_i) = 1\}.$$

$\text{Spin}(V)$  is a connected simply-connected algebraic group.

Given  $a \in \text{Cl}(V)$ ,  $a = v_1 \cdot \dots \cdot v_r$ ,  $v_i \in V$ , let  $\bar{a} = (-1)^r v_r \cdot \dots \cdot v_1$ . This is a well-defined involution of  $\text{Cl}(V)$ . Using it, we may define an action  $R$  of  $\text{Spin}(V)$  on  $V$  by formula  $R(a)v = a \cdot v \cdot \bar{a}$ . Then  $R$  is a double covering  $\text{Spin}(V) \rightarrow \text{SO}(V)$ .

Let  $U \subset V$  be a maximal isotropic subspace, hence  $\dim U = m$ . Take also any maximal isotropic subspace  $U'$  such that  $U \oplus U' = V$ . For any  $v \in U$  we define an operator  $\rho(v) \in \text{End}(\Lambda^*U)$  by the formula

$$\rho(v) \cdot u_1 \wedge \dots \wedge u_r = v \wedge u_1 \wedge \dots \wedge u_r.$$

For any  $v \in U'$  we define an operator  $\rho(v) \in \text{End}(\Lambda^*U)$  by the formula

$$\rho(v) \cdot u_1 \wedge \dots \wedge u_r = \sum_{i=1}^r (-1)^{i-1} (v, u_i) \wedge u_1 \wedge \dots \wedge u_{i-1} \wedge u_{i+1} \wedge \dots \wedge u_r.$$

These operators are well-defined and therefore by linearity we have a linear map  $\rho : V \rightarrow \text{End}(\Lambda^*U)$ . It is easy to check that for any  $v \in V$  we have  $\rho(v)^2 = (v, v)\text{Id}$ . Therefore we have a homomorphism of associative algebras  $\text{Cl}(V) \rightarrow \text{End}(\Lambda^*U)$ , i.e.,  $\Lambda^*U$  is a  $\text{Cl}(V)$ -module, easily seen to be irreducible. Therefore,  $\Lambda^*U$  is also a  $\text{Spin}(V)$ -module (spinor representation), now reducible. However, the even part  $\Lambda^{ev}U$  is an irreducible  $\text{Spin}(V)$ -module, called the half-spinor module  $S^+$ . Another irreducible half-spinor module  $S^-$  is defined as  $\Lambda^{od}U$ .

The map  $\rho$  defines a morphism of  $\text{Spin}(V)$  modules  $V \otimes S^\pm \rightarrow S^\mp$ . If  $m$  is odd, then  $S^+$  is dual to  $S^-$ . If  $m$  is even, then the spinor representation  $\Lambda^*U$  admits an interesting non-degenerate bilinear form  $(\cdot, \cdot)$  defined as follows. Let  $\det \in \Lambda^m U$  be a fixed non-trivial element. Then  $(u, v)$  is equal to the coefficient at  $\det$  of the element  $(-1)^{\lfloor \frac{\deg u}{2} \rfloor} u \wedge v$ . Obviously,  $S^+$  is orthogonal to  $S^-$  and restriction of  $(u, v)$  on  $S^\pm$  is orthogonal if  $m = 4k$  and symplectic if  $m = 4k + 2$ . In particular,  $S^+$  and  $S^-$  are self-dual if  $m$  is even.

If  $m = 4$ , then  $V$ ,  $S^+$  and  $S^-$  are twisted forms of each other w.r.t. outer isomorphisms of  $\text{Spin}_8$  (triality principle). Let  $V = \mathbb{C}^8$  be a vector space equipped with a non-degenerate scalar product. We denote by  $S^+$ ,  $S^-$  the corresponding half-spinor modules. If  $R$  denotes  $V$ ,  $S^+$ , or  $S^-$ , then a tensor  $A \in \mathbb{C}^k \otimes R$  is called ample if restriction of the scalar product of  $R$  on  $\text{Im} \tilde{A}$  is trivial or non-degenerate, where  $\tilde{A} : (\mathbb{C}^k)^* \rightarrow R$  is the corresponding map.

#### Proposition 7.

(A) Let  $k = 2, 3$ . If  $A = \sum a_i \otimes s_i \in \mathbb{C}^k \otimes S^+$  and  $B \in \mathbb{C}^k \otimes S^-$  are not ample, then there exists  $v \in V$  such that  $C = B + \sum a_i \otimes \rho(v)s_i$  is ample.

(B) If  $A = \sum a_i \otimes s_i \in \mathbb{C}^3 \otimes S^+$  and  $B \in \Lambda^2 \mathbb{C}^3 \otimes S^-$  are not ample, then there

exists  $x = \sum v_i \otimes s_i \in \mathbb{C}^3 \otimes V$  such that  $C = B + \sum_{i,j} (a_i \wedge v_j) \otimes \rho(x_j) s_i$  is ample.

(C) If  $A \in \mathbb{C}^3 \otimes S^-$  is not ample and  $s \in S^+$  is not trivial, then there exists  $B = \sum a_i \otimes w_i \in \mathbb{C}^3 \otimes V$  such that  $C = A + \sum a_i \otimes \rho(w_i) s$  is ample.

*Proof.* (A) Let  $k = 2$ . We choose a basis  $f_1, f_2$  of  $\mathbb{C}^2$  and  $e_1, e_2, e_3, e_4$  of  $U$  (maximal isotropic subspace of  $V$ ) such that

$$A = f_1 \otimes 1 + f_2 \otimes (e_1 \wedge e_2 + e_3 \wedge e_4), \quad B = f_1 \otimes x_1 + f_2 \otimes x_2.$$

If  $x_1 \in U \subset \Lambda^{od}U$  then we take  $v = -x_1$ . Otherwise, there exists  $v' \in U'$  such that  $\rho(v')(e_1 \wedge e_2 + e_3 \wedge e_4)$  is not orthogonal to  $x_1$ . Then we take  $v = \lambda v'$ : for generic  $\lambda$  restriction of  $(\cdot, \cdot)$  on  $\text{Im}\tilde{C}$  is non-degenerate, hence  $C$  is ample.

Let  $k = 3$ . We choose a basis  $\{f_1, f_2, f_3\}$  of  $\mathbb{C}^3$  and  $\{e_1, e_2, e_3, e_4\}$  of  $U$  (maximal isotropic subspace of  $V$ ) such that  $A$  has one of the following forms:

$$A_1 = f_1 \otimes (e_1 \wedge e_2 + e_3 \wedge e_4) + f_2 \otimes 1,$$

$$A_2 = f_1 \otimes 1 + f_2 \otimes (e_1 \wedge e_2) + f_3 \otimes (e_3 \wedge e_4),$$

$$A_3 = f_1 \otimes (1 + e_1 \wedge e_2 \wedge e_3 \wedge e_4) + f_2 \otimes e_1 \wedge e_2 + f_3 \otimes e_1 \wedge e_3.$$

Let

$$B = f_1 \otimes x_1 + f_2 \otimes x_2 + f_3 \otimes x_3.$$

**Let  $\mathbf{A} = \mathbf{A}_1$ .** We need to show, that there exist  $u, v \in U$  such that the following element is ample:

$$C = f_1 \otimes (x_1 + u + v \wedge (e_1 \wedge e_2 + e_3 \wedge e_4)) + f_2 \otimes (x_2 + v) + f_3 \otimes x_3.$$

If  $x_3 \notin U$ , then there exists  $v' \in U$  such that  $(v, x_3) \neq 0$  and  $u' \in U$  such that  $(e_1 \wedge e_2 + e_3 \wedge e_4) \wedge u' \wedge v' \neq 0$ . We take  $v = \lambda v'$ ,  $u = \lambda u'$ . Then for generic  $\lambda$  the image of  $\tilde{C}$  is 3-dimensional and non-degenerate, hence  $C$  is ample.

Suppose now that  $x_3 \in U$ . If  $x_3 = 0$ , then we finish the proof as in the case  $k = 2$ .

Let  $x_3 \neq 0$ . If  $x_2 \notin U$ , then there exist  $v' \in U$  such that  $(x_3, v' \wedge (e_1 \wedge e_2 + e_3 \wedge e_4)) \neq 0$ ,  $x_2 \wedge v' \neq 0$ . We take  $u = 0$ ,  $v = \lambda v'$ . Then for generic  $\lambda$  the image of  $\tilde{C}$  is 3-dimensional and non-degenerate, hence  $C$  is ample.

Suppose now that  $x_2 \in U$ . Then we choose  $u$  and  $v$  such that  $u + v \wedge (e_1 \wedge e_2 + e_3 \wedge e_4) = -x_1$ . Then the image of  $\tilde{C}$  is isotropic.

**Let  $\mathbf{A} = \mathbf{A}_2$ .** We need to show, that there exist  $v \in U$ ,  $u \in \langle e_1, e_2 \rangle$ ,  $w \in \langle e_3, e_4 \rangle$  such that the following element is ample:

$$C = f_1 \otimes (x_1 + v) + f_2 \otimes (x_2 + v \wedge (e_1 \wedge e_2) + u) + f_3 \otimes (x_3 + v \wedge (e_3 \wedge e_4) + w).$$

If  $x_1 \notin U$ , then there exists  $v' \in U$  such that  $(v, x_1) \neq 0$  and  $u \in \langle e_1, e_2 \rangle$  (or  $w \in \langle e_3, e_4 \rangle$ ) such that  $u \wedge v \wedge e_3 \wedge e_4 \neq 0$  (or  $w \wedge v \wedge e_1 \wedge e_2 \neq 0$ ). We take  $v = \lambda v'$ ,  $u = \lambda u'$ ,  $w = 0$  (or  $w = \lambda w'$ ,  $u = 0$ ). Then for generic  $\lambda$  the image of  $\tilde{C}$  is 3-dimensional and non-degenerate, hence  $C$  is ample.

Suppose now that  $x_1 \in U$ . Then we may suppose that  $x_1 = 0$  after taking  $v = -x_1$ . Now we are going to find  $u$  and  $w$ .

If  $x_3$  is not perpendicular to  $\langle e_1, e_2 \rangle$  (resp.  $x_2$  is not perpendicular to  $\langle e_3, e_4 \rangle$ ), then we take  $u'$  such that  $\langle u', x_3 \rangle \neq 0$ ,  $w' = 0$  (resp. take  $w'$  such that  $\langle w', x_2 \rangle \neq 0$ ,  $u' = 0$ ) and set  $u = \lambda u'$ ,  $w = \lambda w'$ . Then  $\text{Im} \tilde{C}$  is 2-dimensional and non-degenerate, hence ample, for generic  $\lambda$ .

Let  $x_3 \perp \langle e_1, e_2 \rangle$ ,  $x_2 \perp \langle e_3, e_4 \rangle$ .

If  $\langle x_3, x_3 \rangle = 0$ , then  $\langle x_2, x_3 \rangle = 0$ , otherwise  $B$  is ample. Then  $\langle x_2, x_2 \rangle \neq 0$ , otherwise  $B$  is ample. Hence  $x_2$  is not perpendicular to  $\langle e_1, e_2 \rangle$  and we take  $w = 0$  and  $v$  such that  $\langle x_2, x_2 \rangle + 2\langle x_2, u \rangle = 0$

Suppose, therefore, that  $\langle x_3, x_3 \rangle \neq 0$ , and, similarly, that  $\langle x_2, x_2 \rangle \neq 0$ . It follows that  $x_2$  is not perpendicular to  $\langle e_1, e_2 \rangle$ ,  $x_3$  is not perpendicular to  $\langle e_3, e_4 \rangle$ . We take  $u'$ ,  $w'$  such that  $\langle x_2, u \rangle \neq 0$ ,  $\langle x_3, w \rangle \neq 0$ . We set  $u = \lambda u'$ ,  $w = \lambda w'$ . Then  $\text{Im} \tilde{C}$  is 2-dimensional and non-degenerate for generic  $\lambda$ , hence  $C$  is ample for these values of  $\lambda$ .

**Let  $\mathbf{A} = \mathbf{A}_3$ .** There exists  $x \in V$  such that  $\rho(x)(1 + e_1 \wedge e_2 \wedge e_3 \wedge e_4) = -x_1$ . Therefore, without loss of generality we may assume that  $x_1 = 0$ . If  $B$  is ample, then there is nothing to prove. Otherwise, the restriction of a scalar form  $R$  on  $\langle x_2, x_3 \rangle$  has one-dimensional kernel. After a suitable change of bases we may assume that this kernel is spanned by  $x_2$ . There exists  $x' \in V$  such that  $\rho(x')(1 + e_1 \wedge e_2 \wedge e_3 \wedge e_4)$  is not orthogonal to  $x_2$ . We take  $x = \lambda x'$ . Then for generic  $\lambda$  the image of  $\tilde{C}$  is three-dimensional and non-degenerate w.r.t.  $R$ .

(B) We choose a basis  $\{f_1, f_2, f_3\}$  of  $\mathbb{C}^2$  and  $\{e_1, e_2, e_3, e_4\}$  of  $U$  (maximal isotropic subspace of  $V$ ) such that  $A$  has one of the following forms:

$$A_1 = f_1 \otimes (e_1 \wedge e_2 + e_3 \wedge e_4) + f_2 \otimes 1,$$

$$A_2 = f_1 \otimes 1 + f_2 \otimes (e_1 \wedge e_2) + f_3 \otimes (e_3 \wedge e_4),$$

$$A_3 = f_1 \otimes (1 + e_1 \wedge e_2 \wedge e_3 \wedge e_4) + f_2 \otimes e_1 \wedge e_2 + f_3 \otimes e_1 \wedge e_3.$$

Let

$$B = (f_2 \wedge f_3) \otimes x_1 + (f_1 \wedge f_3) \otimes x_2 + (f_1 \wedge f_2) \otimes x_3.$$

We take an isotropic subspace  $U' \subset V$  complement to  $U$  and choose a basis  $\{e_1^*, e_2^*, e_3^*, e_4^*\}$  of  $U'$  such that  $\langle e_i, e_j^* \rangle = \delta_{ij}$ .

**Let  $\mathbf{A} = \mathbf{A}_3$ .** We take

$$x = \lambda(f_3 \otimes e_1 + f_1 \otimes e_4 + f_2 \otimes e_1^* + f_3 \otimes e_3^*).$$

Then the image of  $\tilde{D}$  is 3-dimensional and non-degenerate, where  $D = \sum_{i,j} (a_i \wedge v_j) \otimes \rho(x_j) s_i$ . Therefore, for generic  $\lambda$ , the image of  $\tilde{C}$  is 3-dimensional and non-degenerate, hence  $C$  is ample.

**Let  $\mathbf{A} = \mathbf{A}_2$ .** The same proof as above, but for

$$x = \lambda(f_3 \otimes e_1^* + f_2 \otimes e_3^* + f_1 \otimes (e_1 + e_2 + e_3 + e_1^*)).$$

**Let  $\mathbf{A} = \mathbf{A}_1$ .** The same proof as above, but for

$$x = \lambda(f_3 \otimes e_1 + f_3 \otimes e_1^* + f_2 \otimes e_2).$$

(C) If  $\langle s, s \rangle \neq 0$ , then  $\rho(V)s = S^-$ , otherwise,  $\rho(V)s = U_0$ , where  $U_0 \subset S^-$  is a maximal isotropic subspace. It is clear now that we can find  $B$  such that  $\text{Im} \tilde{C}$  is isotropic.  $\square$

§4.  $E_7$  AND  $E_8$ : THE ZOO

We associate to each parabolic subgroup its coloured Dynkin diagram. To each graded component  $\mathfrak{g}_\chi$ ,  $\chi > 0$  we associate the coloured Dynkin diagram of the corresponding parabolic subgroup with vertices indexed as follows. The lattice  $\widehat{Z}$  is isomorphic to a sublattice in the root lattice spanned by simple roots marked white on the coloured Dynkin diagram. We write the corresponding coefficient of  $\chi$  near each white vertex. The representation of  $[\mathfrak{l}, \mathfrak{l}]$  on  $\mathfrak{g}_\chi$  is irreducible and the Dynkin diagram of  $[\mathfrak{l}, \mathfrak{l}]$  is equal to the black subdiagram of the coloured Dynkin diagram. We write the numerical labels of  $\chi$  near each black vertex (omitting zeroes). We shall pick several positive weights and call them *twisting weights*. All reduced positive weights of the form  $\chi + \sum \pm \mu_i$ , where  $\chi > 0$  is not reduced and all  $\mu_i > 0$  are twisting, are called *rubbish weights*. We shall draw a diagram with the set of vertices given by not reduced and rubbish weights and arrows indexed by twisting weights: an arrow  $\mu$  has a tail  $\chi_1$  and a head  $\chi_2$  if and only if  $[\mathfrak{g}_{\chi_1}, \mathfrak{g}_\mu] = \mathfrak{g}_{\chi_2}$ . For any  $e \in \mathfrak{n}$  (resp.  $e \in \mathfrak{g}/\mathfrak{p}^-$ ) we shall try to find an element  $u \in U$  (resp.  $u \in U^-$ ) such that all not reduced graded components of the element  $\text{Ad}(u)e$  belong to ample orbits, except at most one. Here  $U \subset P$  is the subgroup with a Lie algebra generated by all twisting weights components,  $U^- \subset P^-$  is the subgroup with a Lie algebra generated by all graded components  $\mathfrak{g}_\chi$ , where  $-\chi$  is twisting. The standard strategy will be to decrease the number of non-reduced components by applying elements of the form  $\exp p$ , where  $p$  belongs to the graded component of some twisting weight. These ‘elementary transformations’ will be made in the special order, because they may change some other components as well. We shall use big Latin letters for not reduced weights, small Latin letters for rubbish weights, and numbers for twisting weights. To save space, we shall use abbreviations of the form

$$L \xrightarrow[X.Y]{n} M.$$

This means that if  $x_L \in \mathfrak{g}_L$  is not ample (or not trivial if  $L$  is a reduced weight), then we can apply the element  $\exp(p_n)$ , where  $p_n \in \mathfrak{g}_n$ , to make  $x_M \in \mathfrak{g}_M$  ample, and reason for this is given in Proposition X.Y. Parabolic subgroups from the table will be joined in several groups, in each group the proof is similar.

**Case 1A.** This case includes parabolic subgroups 1 and 2. We shall consider the 1st.

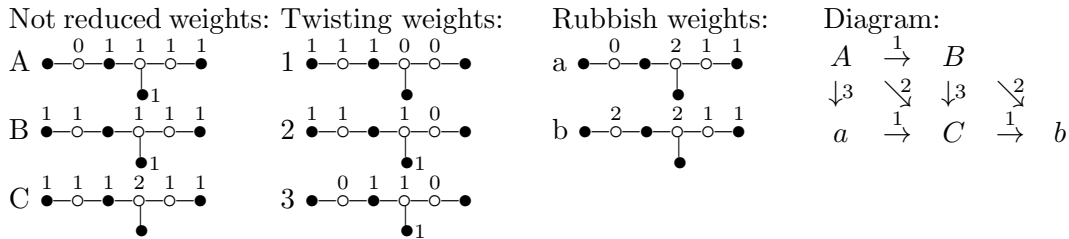

Consider the coadjoint case,  $x \in \mathfrak{n}$ . Then  $A \xrightarrow[1.B]{1} B$ ,  $A \xrightarrow[1.B]{2} C$ . If  $x_A$  is ample, then  $B \xrightarrow[1.B]{3} C$ .

Adjoint case,  $x \in \mathfrak{g}/\mathfrak{p}^-$ .  $b \xrightarrow[1.A]{-2} B$ ,  $b \xrightarrow[1.A]{-1} C$ . Let  $x_b = 0$ . Then  $C \xrightarrow[1.B]{-3} B$ ,  $C \xrightarrow[1.B]{-2} A$ . If  $x_C$  is ample, then  $B \xrightarrow[1.B]{-1} A$ .

**Case 1B.** This case includes parabolic subgroups 3, 4, 5, 6, 7, 8, 9. The proof is similar to the previous case (using Proposition 1.A and 1.B) but combinatorics is more involved. To save space, we omit this proof and refer the reader to the even more complicated Case 5.

**Case 2A.** Parabolic subgroup number 19.

$$\begin{array}{c}
 A \begin{array}{c} \bullet \xrightarrow{0} \circ \bullet \xrightarrow{1} \bullet \xrightarrow{1} \bullet \xrightarrow{1} \bullet \\ | \\ \bullet \end{array} \quad 1 \begin{array}{c} \bullet \xrightarrow{1} \bullet \xrightarrow{1} \bullet \xrightarrow{0} \bullet \\ | \\ \bullet \end{array} \quad a \begin{array}{c} \bullet \xrightarrow{2} \bullet \xrightarrow{1} \bullet \xrightarrow{1} \bullet \\ | \\ \bullet \end{array} \\
 B \begin{array}{c} \bullet \xrightarrow{1} \bullet \xrightarrow{1} \bullet \xrightarrow{1} \bullet \xrightarrow{1} \bullet \\ | \\ \bullet \end{array}
 \end{array} \quad A \xrightarrow{1} B \xrightarrow{1} a$$

Adjoint and coadjoint cases follow from Propositions 6.A, 6.B and 1.A.

**Case 2B.** This case includes parabolic subgroups with numbers 20 and 21. We shall consider 20.

$$\begin{array}{c}
 A \begin{array}{c} \bullet \xrightarrow{1} \bullet \xrightarrow{1} \bullet \xrightarrow{1} \bullet \xrightarrow{1} \bullet \\ | \\ \bullet \end{array} \quad B \begin{array}{c} \bullet \xrightarrow{1} \bullet \xrightarrow{2} \bullet \xrightarrow{1} \bullet \xrightarrow{1} \bullet \\ | \\ \bullet \end{array} \quad 1 \begin{array}{c} \bullet \xrightarrow{1} \bullet \xrightarrow{1} \bullet \xrightarrow{0} \bullet \\ | \\ \bullet \end{array} \\
 \end{array} \quad A \xrightarrow{1} B$$

Both adjoint and coadjoint cases follow from Proposition 6.A and Proposition 6.B.

**Case 2C.** This case includes parabolic subgroups 22, 23, 24, 25, 26, 27. We shall consider the 26.

$$\begin{array}{c}
 A \begin{array}{c} \bullet \xrightarrow{1} \bullet \xrightarrow{1} \bullet \xrightarrow{1} \bullet \xrightarrow{1} \bullet \\ | \\ \circ_1 \end{array} \quad 1 \begin{array}{c} \bullet \xrightarrow{1} \bullet \xrightarrow{1} \bullet \xrightarrow{1} \bullet \xrightarrow{0} \bullet \\ | \\ \circ_0 \end{array} \quad a \begin{array}{c} \bullet \xrightarrow{1} \bullet \xrightarrow{1} \bullet \xrightarrow{2} \bullet \\ | \\ \circ_1 \end{array} \\
 B \begin{array}{c} \bullet \xrightarrow{1} \bullet \xrightarrow{2} \bullet \xrightarrow{1} \bullet \xrightarrow{1} \bullet \\ | \\ \circ_1 \end{array} \quad 2 \begin{array}{c} \bullet \xrightarrow{1} \bullet \xrightarrow{1} \bullet \xrightarrow{1} \bullet \xrightarrow{1} \bullet \\ | \\ \circ_0 \end{array} \quad b \begin{array}{c} \bullet \xrightarrow{1} \bullet \xrightarrow{3} \bullet \xrightarrow{2} \bullet \\ | \\ \circ_1 \end{array} \\
 C \begin{array}{c} \bullet \xrightarrow{1} \bullet \xrightarrow{2} \bullet \xrightarrow{1} \bullet \xrightarrow{2} \bullet \\ | \\ \circ_1 \end{array} \quad 3 \begin{array}{c} \bullet \xrightarrow{0} \bullet \xrightarrow{1} \bullet \xrightarrow{1} \bullet \xrightarrow{1} \bullet \\ | \\ \circ_0 \end{array}
 \end{array} \quad \begin{array}{c} A \xrightarrow{1} B \\ \downarrow 3 \quad \searrow 2 \quad \downarrow 3 \quad \searrow 2 \\ a \xrightarrow{1} C \xrightarrow{1} b \end{array}$$

Coadjoint case,  $x \in \mathfrak{n}$ . Then  $A \xrightarrow{1} B$ ,  $A \xrightarrow{2} C$ . If  $x_A$  is ample, then  $B \xrightarrow{3} C$ .

Adjoint case,  $x \in \mathfrak{g}/\mathfrak{p}^-$ . Then  $b \xrightarrow{-2} B$  and  $b \xrightarrow{-1} C$ . Let  $x_b = 0$ . Then  $C \xrightarrow{-3} B$  and  $C \xrightarrow{-2} A$ . Let  $x_C$  be ample. Then  $B \xrightarrow{-1} A$ .

**Case 2D.** This case includes parabolic subgroups 27, 28, 29. We shall consider 29.

$$\begin{array}{c}
 A \begin{array}{c} \bullet \xrightarrow{0} \bullet \xrightarrow{1} \bullet \xrightarrow{1} \bullet \xrightarrow{1} \bullet \\ | \\ \circ_1 \end{array} \quad 1 \begin{array}{c} \bullet \xrightarrow{1} \bullet \xrightarrow{1} \bullet \xrightarrow{1} \bullet \xrightarrow{0} \bullet \\ | \\ \circ_0 \end{array} \quad a \begin{array}{c} \bullet \xrightarrow{0} \bullet \xrightarrow{1} \bullet \xrightarrow{2} \bullet \\ | \\ \circ_1 \end{array} \\
 B \begin{array}{c} \bullet \xrightarrow{1} \bullet \xrightarrow{1} \bullet \xrightarrow{1} \bullet \xrightarrow{1} \bullet \\ | \\ \circ_1 \end{array} \quad 2 \begin{array}{c} \bullet \xrightarrow{1} \bullet \xrightarrow{1} \bullet \xrightarrow{1} \bullet \xrightarrow{1} \bullet \\ | \\ \circ_0 \end{array} \quad b \begin{array}{c} \bullet \xrightarrow{2} \bullet \xrightarrow{1} \bullet \xrightarrow{1} \bullet \xrightarrow{1} \bullet \\ | \\ \circ_1 \end{array} \\
 C \begin{array}{c} \bullet \xrightarrow{1} \bullet \xrightarrow{1} \bullet \xrightarrow{1} \bullet \xrightarrow{2} \bullet \\ | \\ \circ_1 \end{array} \quad 3 \begin{array}{c} \bullet \xrightarrow{0} \bullet \xrightarrow{1} \bullet \xrightarrow{1} \bullet \xrightarrow{1} \bullet \\ | \\ \circ_0 \end{array} \quad c \begin{array}{c} \bullet \xrightarrow{2} \bullet \xrightarrow{1} \bullet \xrightarrow{2} \bullet \\ | \\ \circ_1 \end{array}
 \end{array} \quad \begin{array}{c} A \xrightarrow{1} B \xrightarrow{1} b \\ \downarrow 3 \quad \searrow 2 \quad \downarrow 3 \quad \searrow 2 \quad \downarrow 3 \\ a \xrightarrow{1} C \xrightarrow{1} c \end{array}$$

Coadjoint case,  $x \in \mathfrak{n}$ . Then  $A \xrightarrow{1} B$ ,  $A \xrightarrow{2} C$ . If  $x_A$  is ample, then  $B \xrightarrow{3} C$ .

Adjoint case,  $x \in \mathfrak{g}/\mathfrak{p}^-$ . Then  $c \xrightarrow{-1} C$  and  $c \xrightarrow{-2} B$ . Let  $x_c = 0$ . Then  $C \xrightarrow{-3} B$  and  $C \xrightarrow{-2} A$ . Let  $x_C$  be ample. If  $x_b = 0$ , then  $B \xrightarrow{-1} A$ . If  $x_b \neq 0$  then  $b \xrightarrow{-1} B$ .

**Case 2E.** This case includes parabolic subgroups 30, 31. We shall consider 31.



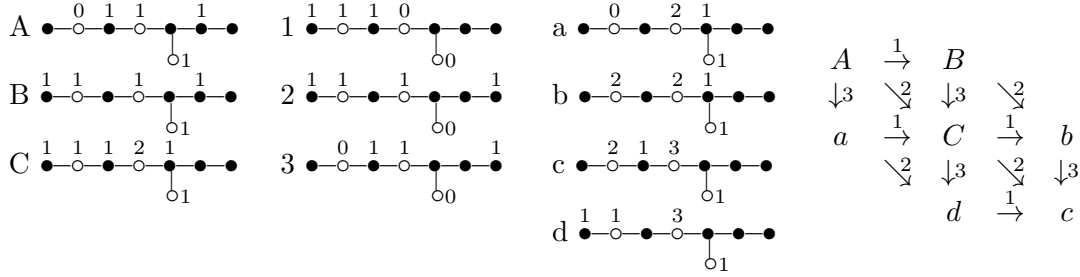

Coadjoint case,  $x \in \mathfrak{n}$ . Then  $A \xrightarrow{1} B$  and  $A \xrightarrow{2} C$ . If  $x_A$  is ample, then  $B \xrightarrow{3} C$ .

Adjoint case,  $x \in \mathfrak{g}/\mathfrak{p}^-$ . If  $x_c \neq 0$  or  $x_b \neq 0$ , then we first apply  $\exp(p_{-3})$  to make  $x_b \neq 0$  if necessary. Then  $b \xrightarrow{-2} B$  and  $b \xrightarrow{-1} C$ . If  $x_c, x_b = 0$  then  $d \xrightarrow{-3} C$  and  $B \xrightarrow{-1} A$ . If  $x_c, x_b, x_d = 0$  then  $C \xrightarrow{-3} B$  and  $C \xrightarrow{-2} A$ . If  $x_C$  is ample, then  $B \xrightarrow{-1} A$ .

**Case 3.** This case includes parabolic subgroups 32, 33. We shall consider 33.

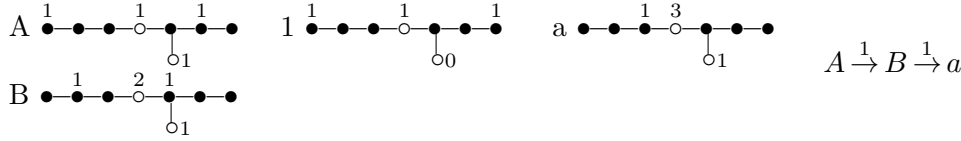

Adjoint and coadjoint cases follow from Proposition 6.D and Proposition 6.E.

**Case 4A.** In this case we study the parabolic subgroup number 34.

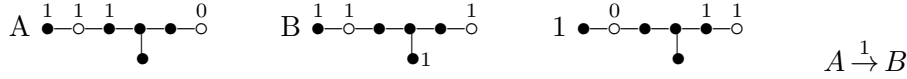

Both adjoint and coadjoint cases follow from Proposition 7.A.

**Case 4B.** This case includes parabolic subgroups 35, 36. We shall consider 36.

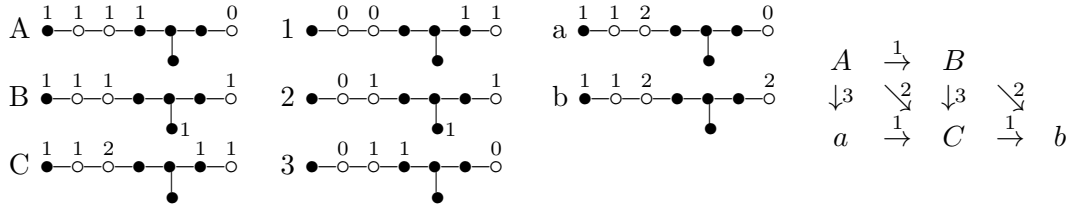

Easy digram-walking shows that everything follows from Propositions 7.A and 1.A.

**Case 4C.** This case includes the parabolic subgroup 37.

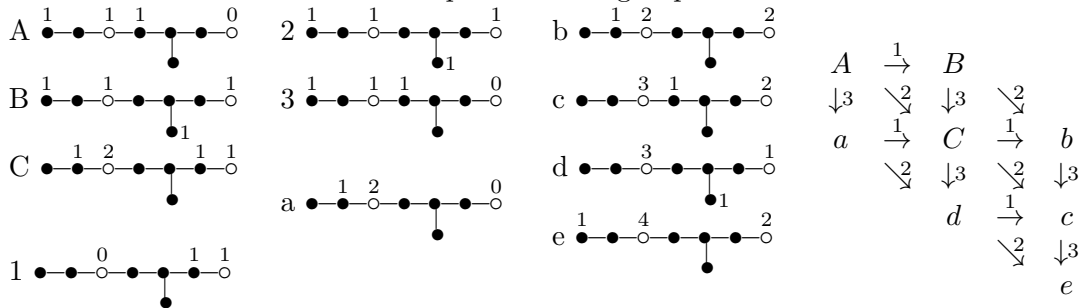

The coadjoint case follows from Proposition 7.A and Proposition 7.B. The adjoint case easily follows from Proposition 7.A, Proposition 7.B, Proposition 4.A, and Proposition 7.C.

**Case 5A.** This case contains parabolic subgroup 10.

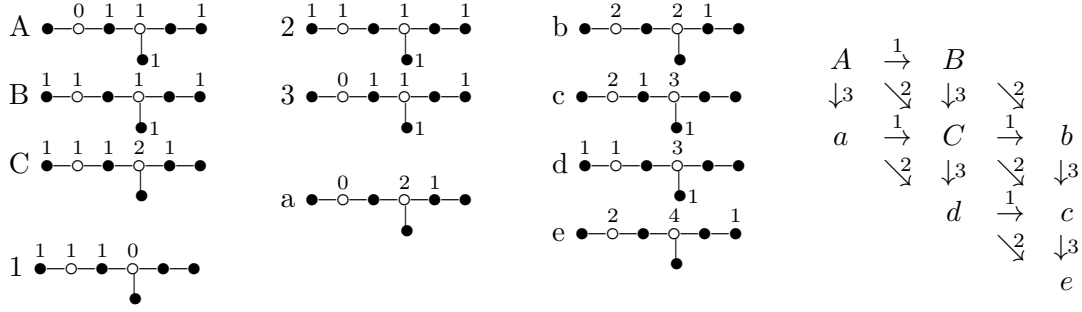

Consider the coadjoint case, let  $x \in \mathfrak{n}$ . Then  $A \xrightarrow{1} B$ ,  $A \xrightarrow{2} C$ . If  $x_A$  is ample, then  $B \xrightarrow{3} C$ .

Adjoint case,  $x \in \mathfrak{g}/\mathfrak{p}^-$ . Suppose first that either  $x_b$ ,  $x_c$ , or  $x_e$  is not trivial. Applying  $\exp(p_{-3})$  if necessary, we may assume that  $x_b \neq 0$ . Then  $b \xrightarrow{-2} B$ ,  $b \xrightarrow{-1} C$ . Let  $x_b = x_c = x_e = 0$ . Then  $d \xrightarrow{-3} C$ ,  $B \xrightarrow{-1} A$ . Let  $x_d = 0$ . Then  $C \xrightarrow{-3} B$ ,  $C \xrightarrow{-2} A$ . Let  $x_C$  be ample, then  $B \xrightarrow{-1} A$ .

**Case 5B.** This case includes parabolic subgroups 11, 12, 13. We shall consider the 11.

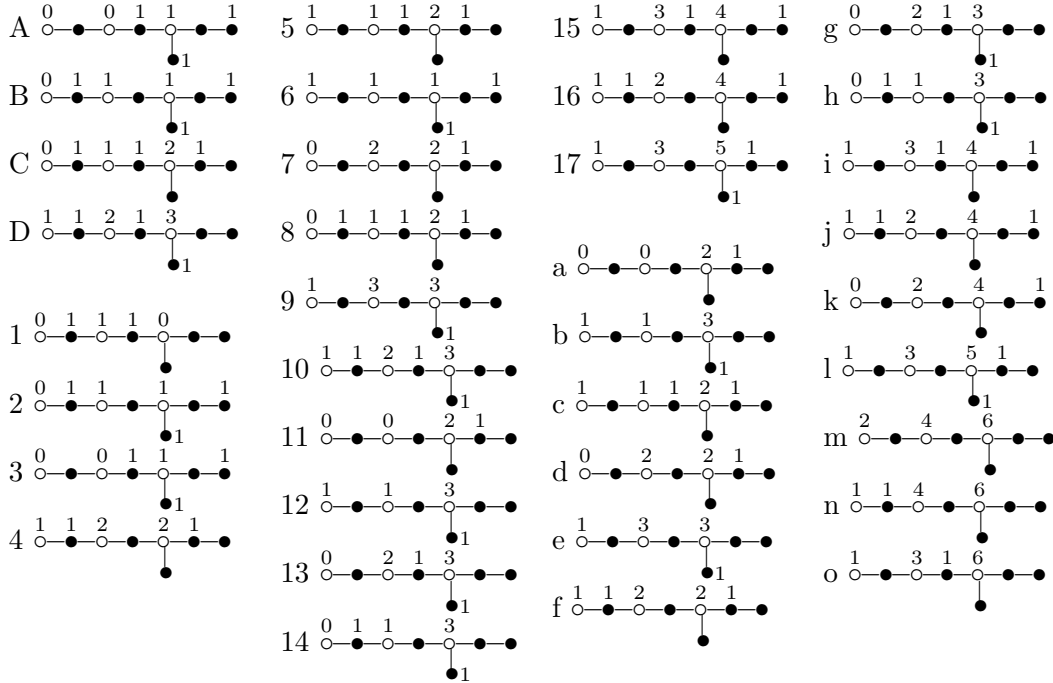

$$\begin{aligned}
 & A \xrightarrow{1} B \quad a \xrightarrow{1} C \xrightarrow{1} d \quad b \xrightarrow{1} D \xrightarrow{1} e \quad c \xrightarrow{1} f \quad h \xrightarrow{1} g \quad j \xrightarrow{1} i \quad o \xrightarrow{1} n \\
 & A \xrightarrow{2} C \xrightarrow{2} g \quad B \xrightarrow{2} d \quad c \xrightarrow{2} D \xrightarrow{2} i \quad a \xrightarrow{2} h \xrightarrow{2} k \quad b \xrightarrow{2} j \xrightarrow{2} l \xrightarrow{2} n \quad f \xrightarrow{2} e \\
 & A \xrightarrow{3} a \quad B \xrightarrow{3} C \xrightarrow{3} h \quad f \xrightarrow{3} D \xrightarrow{3} j \quad c \xrightarrow{3} b \quad d \xrightarrow{3} g \xrightarrow{3} k \quad e \xrightarrow{3} i \xrightarrow{3} l \xrightarrow{3} o \\
 & A \xrightarrow{4} D \quad B \xrightarrow{4} e \quad C \xrightarrow{4} i \quad a \xrightarrow{4} j \xrightarrow{4} m \quad h \xrightarrow{4} l \quad k \xrightarrow{4} n \\
 & A \xrightarrow{5} b \quad B \xrightarrow{5} D \quad C \xrightarrow{5} j \quad d \xrightarrow{5} i \xrightarrow{5} m \quad g \xrightarrow{5} l \quad k \xrightarrow{5} o \\
 & A \xrightarrow{6} c \quad B \xrightarrow{6} f \quad C \xrightarrow{6} D \quad a \xrightarrow{6} b \quad d \xrightarrow{6} e \quad g \xrightarrow{6} i \quad h \xrightarrow{6} j \quad k \xrightarrow{6} l \xrightarrow{6} m \\
 & A \xrightarrow{7} g \quad a \xrightarrow{7} k \quad b \xrightarrow{7} l \quad c \xrightarrow{7} i \quad j \xrightarrow{7} n \\
 & A \xrightarrow{8} h \quad B \xrightarrow{8} g \quad C \xrightarrow{8} k \quad D \xrightarrow{8} l \quad c \xrightarrow{8} j \xrightarrow{8} o \quad f \xrightarrow{8} i \xrightarrow{8} n
 \end{aligned}$$

$$\begin{array}{cccccccc}
A \xrightarrow{9} i & a \xrightarrow{9} l & b \xrightarrow{9} m & h \xrightarrow{9} n & & & & \\
A \xrightarrow{10} j & B \xrightarrow{10} i & C \xrightarrow{10} l & D \xrightarrow{10} m & g \xrightarrow{10} n & h \xrightarrow{10} o & & \\
B \xrightarrow{11} h & d \xrightarrow{11} k & e \xrightarrow{11} l & f \xrightarrow{11} j & i \xrightarrow{11} o & B \xrightarrow{12} j & d \xrightarrow{12} l & e \xrightarrow{12} m & g \xrightarrow{12} o \\
A \xrightarrow{13} k & D \xrightarrow{13} n & b \xrightarrow{13} o & c \xrightarrow{13} l & B \xrightarrow{14} k & D \xrightarrow{14} o & e \xrightarrow{14} n & f \xrightarrow{14} l \\
A \xrightarrow{15} l & C \xrightarrow{15} n & a \xrightarrow{15} o & & & & & \\
c \xrightarrow{15} m & B \xrightarrow{16} l & C \xrightarrow{16} o & d \xrightarrow{16} n & f \xrightarrow{16} m & A \xrightarrow{17} o & B \xrightarrow{17} n & 
\end{array}$$

Consider the coadjoint case,  $x \in \mathfrak{n}$ . Then  $A \xrightarrow[1.B]{1} B$ ,  $A \xrightarrow[5.A]{2} C$ ,  $A \xrightarrow[4.B]{4} D$ . Suppose that  $x_A$  is ample, then  $B \xrightarrow[5.A]{3} C$ ,  $B \xrightarrow[4.B]{5} D$ . Let  $x_B$  be ample, then  $C \xrightarrow[4.B]{6} D$ .

Adjoint case,  $x \in \mathfrak{g}/\mathfrak{p}^-$ . Then  $n \xrightarrow[1.A]{-13} D$ ,  $n \xrightarrow[1.A]{-15} C$ ,  $n \xrightarrow[1.A]{-17} B$ . Let  $x_n = 0$ , then  $o \xrightarrow[1.A]{-14} D$ ,  $o \xrightarrow[1.A]{-16} C$ ,  $o \xrightarrow[1.A]{-17} A$ . Let  $x_o = 0$ ,  $x_l \neq 0$  or  $x_m \neq 0$  (in the latter case we apply  $\exp(p_{-6})$  if necessary to make  $x_l \neq 0$ ). Then  $l \xrightarrow[4.A]{-10} C$ ,  $l \xrightarrow[5.C]{-15} A$ ,  $l \xrightarrow[5.C]{-16} B$ . Let  $x_l = x_m = 0$ , then  $i \xrightarrow[1.A]{-2} D$ ,  $i \xrightarrow[5.C]{-4} C$ ,  $i \xrightarrow[4.A]{-10} B$ . Let  $x_i = 0$ , then  $j \xrightarrow[1.A]{-3} D$ ,  $j \xrightarrow[5.C]{-5} C$ ,  $j \xrightarrow[4.A]{-10} A$ . Let  $x_j = 0$ , then  $k \xrightarrow[4.A]{-8} C$ ,  $k \xrightarrow[4.A]{-13} A$ ,  $k \xrightarrow[4.A]{-14} B$ . Let  $x_k = 0$ , then  $g \xrightarrow[1.A]{-2} C$ ,  $g \xrightarrow[1.A]{-8} B$ ,  $g \xrightarrow[4.B]{-7} A$ . Let  $x_g = 0$ , then  $h \xrightarrow[1.A]{-3} C$ ,  $h \xrightarrow[1.A]{-8} A$ ,  $h \xrightarrow[4.B]{-11} B$ . Let  $x_h = 0$ ,  $x_e \neq 0$ . Applying  $\exp(p_{-6})$  if necessary, we also make  $x_d = 0$ . Then  $e \xrightarrow[4.A]{-1} D$ ,  $e \xrightarrow[1.A]{-4} B$ ,  $C \xrightarrow[5.A]{-2} A$ , Let  $x_e = 0$ , then  $D \xrightarrow[4.B]{-6} C$ ,  $D \xrightarrow[4.B]{-5} B$ ,  $D \xrightarrow[4.B]{-4} A$ . Let  $x_D$  be ample, then  $d \xrightarrow[4.A]{-1} C$ ,  $d \xrightarrow[4.A]{-2} B$ . Let  $x_d = 0$ , then  $C \xrightarrow[5.A]{-2} A$ ,  $C \xrightarrow[5.A]{-3} B$ . Let  $x_C$  be ample. Then  $B \xrightarrow[1.B]{-1} A$ .

**Case 5C.** This case includes parabolic subgroups 14, 15. We shall consider number 14.

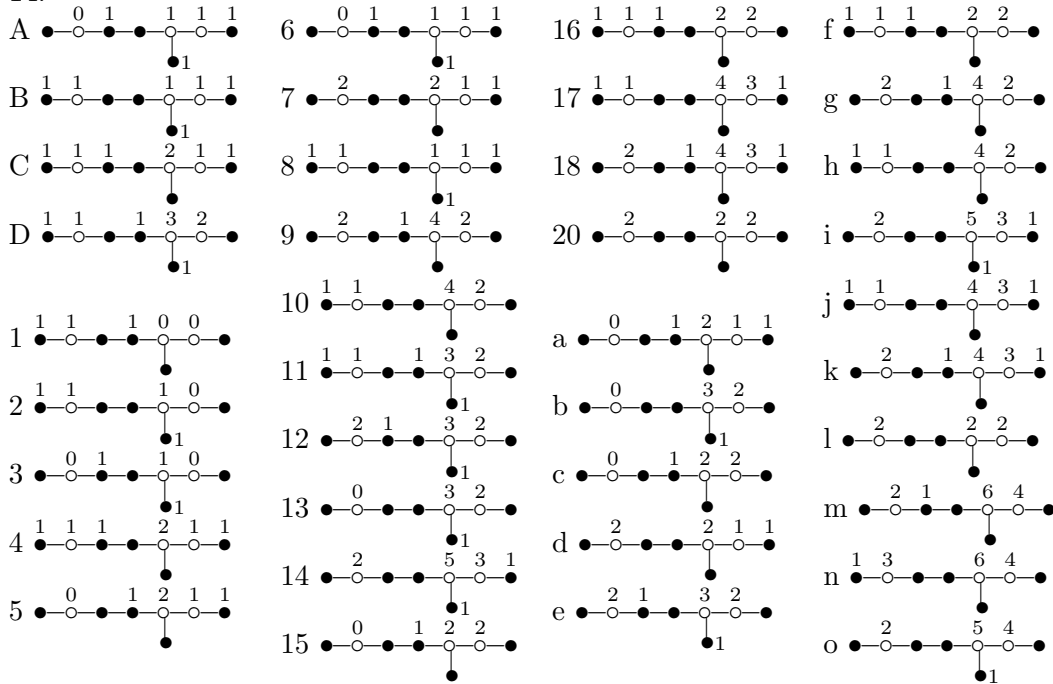

$$\begin{aligned}
& A \xrightarrow{1} B \quad a \xrightarrow{1} C \xrightarrow{1} d \quad b \xrightarrow{1} D \xrightarrow{1} e \quad c \xrightarrow{1} f \quad f \xrightarrow{1} l \quad h \xrightarrow{1} g \quad j \xrightarrow{1} k \quad m \xrightarrow{1} n \\
& A \xrightarrow{2} C \quad B \xrightarrow{2} d \quad b \xrightarrow{2} h \quad c \xrightarrow{2} D \xrightarrow{2} g \quad f \xrightarrow{2} e \quad j \xrightarrow{2} i \quad o \xrightarrow{2} n \\
& A \xrightarrow{3} a \quad B \xrightarrow{3} C \quad c \xrightarrow{3} b \quad f \xrightarrow{3} D \xrightarrow{3} h \quad k \xrightarrow{3} i \quad l \xrightarrow{3} e \xrightarrow{3} g \quad o \xrightarrow{3} m \\
& A \xrightarrow{4} D \xrightarrow{4} i \quad B \xrightarrow{4} e \quad C \xrightarrow{4} g \quad a \xrightarrow{4} h \quad c \xrightarrow{4} j \xrightarrow{4} m \quad f \xrightarrow{4} k \xrightarrow{4} n \\
& A \xrightarrow{5} b \quad B \xrightarrow{5} D \quad C \xrightarrow{5} h \quad d \xrightarrow{5} g \quad e \xrightarrow{5} i \quad f \xrightarrow{5} j \quad l \xrightarrow{5} k \xrightarrow{5} m \\
& A \xrightarrow{6} c \quad B \xrightarrow{6} f \quad C \xrightarrow{6} D \xrightarrow{6} j \quad a \xrightarrow{6} b \quad d \xrightarrow{6} e \xrightarrow{6} k \xrightarrow{6} o \quad g \xrightarrow{6} i \quad i \xrightarrow{6} m \\
& A \xrightarrow{7} e \quad a \xrightarrow{7} g \quad b \xrightarrow{7} i \quad c \xrightarrow{7} k \quad j \xrightarrow{7} n \\
& A \xrightarrow{8} f \quad B \xrightarrow{8} l \quad C \xrightarrow{8} e \quad a \xrightarrow{8} D \xrightarrow{8} k \quad b \xrightarrow{8} j \xrightarrow{8} o \quad h \xrightarrow{8} i \xrightarrow{8} n \\
& A \xrightarrow{9} i \quad c \xrightarrow{9} m \quad f \xrightarrow{9} n \quad B \xrightarrow{10} i \quad f \xrightarrow{10} m \quad l \xrightarrow{10} n \\
& A \xrightarrow{11} j \quad B \xrightarrow{11} k \quad C \xrightarrow{11} i \quad D \xrightarrow{11} m \quad e \xrightarrow{11} n \quad f \xrightarrow{11} o \\
& A \xrightarrow{12} k \quad D \xrightarrow{12} n \quad a \xrightarrow{12} i \quad b \xrightarrow{12} m \quad c \xrightarrow{12} o \quad B \xrightarrow{13} j \quad d \xrightarrow{13} i \quad e \xrightarrow{13} m \quad l \xrightarrow{13} o \\
& A \xrightarrow{14} m \quad B \xrightarrow{14} n \quad C \xrightarrow{15} j \quad d \xrightarrow{15} k \quad e \xrightarrow{15} o \quad g \xrightarrow{15} m \\
& C \xrightarrow{16} k \quad D \xrightarrow{16} o \quad a \xrightarrow{16} j \quad g \xrightarrow{16} n \quad h \xrightarrow{16} m \quad B \xrightarrow{17} o \quad C \xrightarrow{17} m \quad d \xrightarrow{17} n \\
& A \xrightarrow{18} o \quad C \xrightarrow{18} n \quad a \xrightarrow{18} m \quad a \xrightarrow{20} k \quad b \xrightarrow{20} o \quad h \xrightarrow{20} n
\end{aligned}$$

Consider the coadjoint case, let  $x \in \mathfrak{n}$ . Then  $A \xrightarrow[4.B]{1} B$ ,  $A \xrightarrow[1.B]{2} C$ ,  $A \xrightarrow[5.A]{4} D$ . Let  $x_A$  be ample, then  $B \xrightarrow[4.B]{3} C$ ,  $B \xrightarrow[4.B]{5} D$ . Let  $x_B$  be ample, then  $C \xrightarrow[5.A]{6} D$ .

Adjoint case,  $x \in \mathfrak{g}/\mathfrak{p}^-$ . Then  $n \xrightarrow[1.A]{-12} D$ ,  $n \xrightarrow[1.A]{-14} B$ ,  $n \xrightarrow[1.A]{-18} C$ . Let  $x_n = 0$ , then  $m \xrightarrow[4.A]{-11} D$ ,  $m \xrightarrow[4.A]{-14} A$ ,  $m \xrightarrow[4.A]{-17} C$ . Let  $x_m = 0$ , then  $o \xrightarrow[1.A]{-16} D$ ,  $o \xrightarrow[1.A]{-17} B$ ,  $o \xrightarrow[1.A]{-18} A$ . Let  $x_o = 0$ , then  $i \xrightarrow[1.A]{-4} D$ ,  $i \xrightarrow[1.A]{-11} C$ ,  $i \xrightarrow[4.B]{-9} A$ . Let  $x_i = 0$ , then  $k \xrightarrow[4.A]{-8} D$ ,  $k \xrightarrow[1.A]{-11} B$ ,  $k \xrightarrow[5.C]{-12} A$ . Let  $x_k = 0$ , then  $j \xrightarrow[1.A]{-6} D$ ,  $j \xrightarrow[1.A]{-11} A$ ,  $j \xrightarrow[4.B]{-15} C$ . Let  $x_j = 0$ . If  $x_g \neq 0$ , then by Proposition 5.E, we can apply  $\exp(p_{-3})$  to force  $x_e$  to have rank 2. Afterwards,  $e \xrightarrow[5.C]{-1} D$ ,  $e \xrightarrow[1.A]{-4} B$ ,  $e \xrightarrow[1.C]{-7} A$ . Let  $x_g = 0$ , then  $e \xrightarrow[5.C]{-1} D$ ,  $e \xrightarrow[4.A]{-8} C$ ,  $e \xrightarrow[1.A]{-4} B$ . Let  $x_e = 0$ , then  $h \xrightarrow[1.A]{-3} D$ ,  $h \xrightarrow[1.A]{-5} C$ ; if  $x_d \neq 0$  then  $d \xrightarrow[1.A]{-2} B$ , if  $x_d = 0$  then  $B \xrightarrow[4.B]{-1} A$ . Let  $x_h = 0$ , then  $D \xrightarrow[5.A]{-6} C$ ,  $D \xrightarrow[4.B]{-5} B$ ,  $D \xrightarrow[5.A]{-4} A$ . Let  $x_D$  be ample, then  $d \xrightarrow[1.A]{-1} C$ ,  $d \xrightarrow[1.A]{-2} B$ . Let  $x_d = 0$ , then  $C \xrightarrow[4.B]{-3} B$ ,  $C \xrightarrow[1.B]{-2} A$ . Let  $x_C$  be ample, then  $B \xrightarrow[4.B]{-1} A$ .

**Case 5D.** In this case we study parabolic subgroup 16.

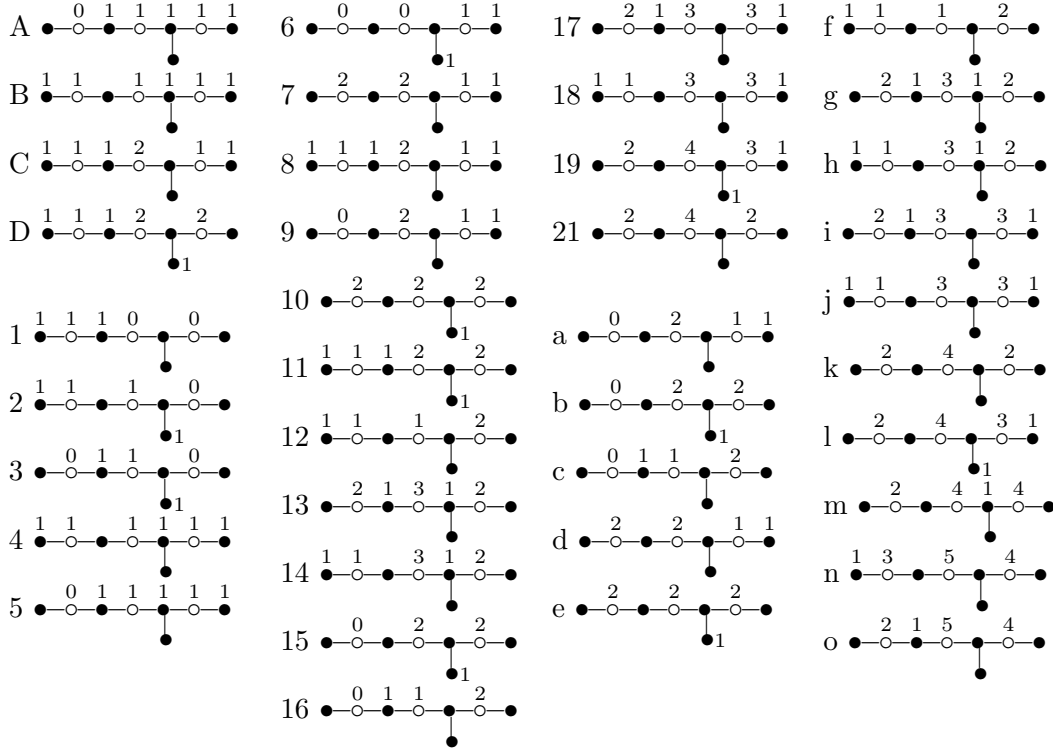

$$\begin{aligned}
& A \xrightarrow{1} B \quad a \xrightarrow{1} C \xrightarrow{1} d \quad b \xrightarrow{1} D \xrightarrow{1} e \quad c \xrightarrow{1} f \quad h \xrightarrow{1} g \quad j \xrightarrow{1} i \quad o \xrightarrow{1} n \\
& A \xrightarrow{2} C \quad B \xrightarrow{2} d \quad b \xrightarrow{2} h \xrightarrow{2} k \quad c \xrightarrow{2} D \xrightarrow{2} g \quad f \xrightarrow{2} e \quad j \xrightarrow{2} l \quad m \xrightarrow{2} n \\
& A \xrightarrow{3} a \quad B \xrightarrow{3} C \quad c \xrightarrow{3} b \quad e \xrightarrow{3} g \xrightarrow{3} k \quad f \xrightarrow{3} D \xrightarrow{3} h \quad i \xrightarrow{3} l \quad m \xrightarrow{3} o \\
& A \xrightarrow{4} D \xrightarrow{4} i \quad B \xrightarrow{4} e \quad C \xrightarrow{4} g \quad a \xrightarrow{4} h \xrightarrow{4} l \xrightarrow{4} n \quad b \xrightarrow{4} j \xrightarrow{4} m \\
& A \xrightarrow{5} b \quad B \xrightarrow{5} D \xrightarrow{5} j \quad C \xrightarrow{5} h \quad d \xrightarrow{5} g \xrightarrow{5} l \xrightarrow{5} o \quad e \xrightarrow{5} i \xrightarrow{5} m \\
& A \xrightarrow{6} c \quad B \xrightarrow{6} f \quad C \xrightarrow{6} D \quad a \xrightarrow{6} b \quad d \xrightarrow{6} e \quad g \xrightarrow{6} i \quad h \xrightarrow{6} j \quad k \xrightarrow{6} l \xrightarrow{6} m \\
& A \xrightarrow{7} g \quad a \xrightarrow{7} k \quad b \xrightarrow{7} l \quad c \xrightarrow{7} i \quad j \xrightarrow{7} n \\
& A \xrightarrow{8} h \quad B \xrightarrow{8} g \quad C \xrightarrow{8} k \quad D \xrightarrow{8} l \quad c \xrightarrow{8} j \xrightarrow{8} o \quad f \xrightarrow{8} i \xrightarrow{8} n \\
& B \xrightarrow{9} h \quad d \xrightarrow{9} k \quad e \xrightarrow{9} l \quad f \xrightarrow{9} j \quad i \xrightarrow{9} o \\
& A \xrightarrow{10} i \quad a \xrightarrow{10} l \quad b \xrightarrow{10} m \quad h \xrightarrow{10} n \\
& A \xrightarrow{11} j \quad B \xrightarrow{11} i \quad C \xrightarrow{11} l \quad D \xrightarrow{11} m \quad g \xrightarrow{11} n \quad h \xrightarrow{11} o \\
& C \xrightarrow{12} i \quad a \xrightarrow{12} j \quad h \xrightarrow{12} m \quad k \xrightarrow{12} n \quad A \xrightarrow{13} l \quad D \xrightarrow{13} n \quad b \xrightarrow{13} o \quad c \xrightarrow{13} m \\
& B \xrightarrow{14} l \quad D \xrightarrow{14} o \quad e \xrightarrow{14} n \quad f \xrightarrow{14} m \quad B \xrightarrow{15} j \quad d \xrightarrow{15} l \quad e \xrightarrow{15} m \quad g \xrightarrow{15} o \\
& C \xrightarrow{16} j \quad d \xrightarrow{16} i \quad g \xrightarrow{16} m \quad k \xrightarrow{16} o \quad A \xrightarrow{17} m \quad C \xrightarrow{17} n \quad a \xrightarrow{17} o \\
& B \xrightarrow{18} m \quad C \xrightarrow{18} o \quad d \xrightarrow{18} n \quad A \xrightarrow{19} o \quad B \xrightarrow{19} n \quad c \xrightarrow{21} o \quad f \xrightarrow{21} n
\end{aligned}$$

Coadjoint case,  $x \in \mathfrak{n}$ . Then  $A \xrightarrow[1.B]{1} B$ ,  $A \xrightarrow[4.B]{2} C$ ,  $A \xrightarrow[5.A]{4} D$ . Let  $x_A$  be ample.

Then  $B \xrightarrow[4.B]{3} C$ ,  $B \xrightarrow[5.A]{5} D$ . Let  $x_B$  be ample. Then  $C \xrightarrow[4.B]{6} D$ .

Adjoint case,  $x \in \mathfrak{g}/\mathfrak{p}^-$ . Then  $n \xrightarrow[1.A]{-13} D$ ,  $n \xrightarrow[1.A]{-17} C$ ,  $n \xrightarrow[1.A]{-19} B$ . Let  $x_n = 0$ . Then  $o \xrightarrow[1.A]{-14} D$ ,  $o \xrightarrow[1.A]{-18} C$ ,  $o \xrightarrow[1.A]{-19} A$ . Let  $x_o = 0$ . Then  $m \xrightarrow[4.A]{-11} D$ ,  $m \xrightarrow[4.A]{-17} A$ ,  $m \xrightarrow[4.A]{-18} B$ . Let  $x_m = 0$ . Then  $l \xrightarrow[4.A]{-8} D$ ,  $l \xrightarrow[1.A]{-11} C$ ,  $l \xrightarrow[5.C]{-13} A$ . Let  $x_l = 0$ . Then  $i \xrightarrow[1.A]{-4} D$ ,  $i \xrightarrow[1.A]{-11} B$ ,  $i \xrightarrow[4.B]{-10} A$ . Let  $x_i = 0$ . Then  $j \xrightarrow[1.A]{-5} D$ ,  $j \xrightarrow[1.A]{-11} A$ ,  $j \xrightarrow[4.B]{-15} B$ . Let  $x_j = 0$ ,  $x_k \neq 0$ . We can apply

$\exp(p_{-3})$  to force  $x_g$  to have rank 2, then  $g \xrightarrow[5.C]{-2} D$ ,  $g \xrightarrow[1.A]{-4} C$ ,  $g \xrightarrow[1.C]{-7} A$ . Let  $x_k = 0$ , then  $g \xrightarrow[5.C]{-2} D$ ,  $g \xrightarrow[1.A]{-4} C$ ,  $g \xrightarrow[4.A]{-8} B$ . Let  $x_g = 0$ , then  $h \xrightarrow[5.C]{-3} D$ ,  $h \xrightarrow[1.A]{-5} C$ ,  $h \xrightarrow[4.A]{-8} A$ . Let  $x_h = 0$ ,  $x_e \neq 0$ . Applying  $\exp(p_{-6})$  if necessary, we make  $x_d = 0$ , then  $e \xrightarrow[4.A]{-1} D$ ,  $e \xrightarrow[4.A]{-4} B$ ,  $C \xrightarrow[4.B]{-2} A$ . Let  $x_e = 0$ . Then  $D \xrightarrow[4.B]{-6} C$ ,  $D \xrightarrow[5.A]{-5} B$ ,  $D \xrightarrow[5.A]{-4} A$ . Suppose  $x_D$  is ample. Then  $d \xrightarrow[1.A]{-1} C$ ,  $d \xrightarrow[1.A]{-2} B$ . Let  $x_d = 0$ . Then  $C \xrightarrow[4.B]{-3} B$ ,  $C \xrightarrow[4.B]{-2} A$ . Let  $x_C$  be ample, then  $B \xrightarrow[1.B]{-1} A$ .

**Case 5E.** This case consists of parabolic subgroups 17 and 18. We shall consider number 17.

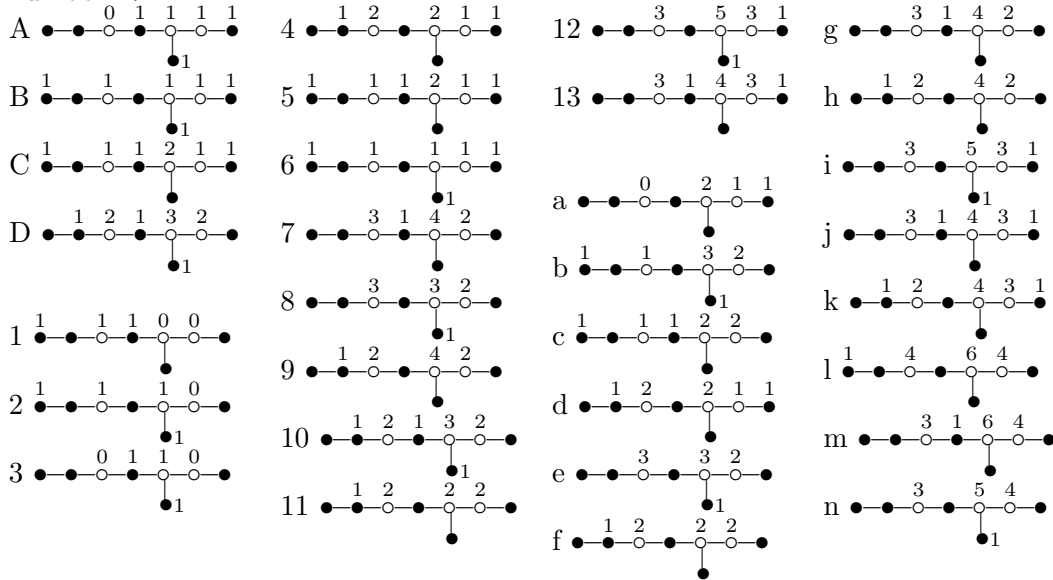

$$\begin{aligned}
A &\xrightarrow{1} B & a &\xrightarrow{1} C \xrightarrow{1} d & b &\xrightarrow{1} D \xrightarrow{1} e & c &\xrightarrow{1} f & h &\xrightarrow{1} g & k &\xrightarrow{1} j & m &\xrightarrow{1} l \\
A &\xrightarrow{2} C & B &\xrightarrow{2} d & b &\xrightarrow{2} h & c &\xrightarrow{2} D \xrightarrow{2} g & f &\xrightarrow{2} e & k &\xrightarrow{2} i & n &\xrightarrow{2} l \\
A &\xrightarrow{3} a & B &\xrightarrow{3} C & c &\xrightarrow{3} b & e &\xrightarrow{3} g & f &\xrightarrow{3} D \xrightarrow{3} h & j &\xrightarrow{3} i & n &\xrightarrow{3} m \\
A &\xrightarrow{4} D & B &\xrightarrow{4} e & C &\xrightarrow{4} g & a &\xrightarrow{4} h & b &\xrightarrow{4} i & c &\xrightarrow{4} j & k &\xrightarrow{4} l \\
A &\xrightarrow{5} b & B &\xrightarrow{5} D \xrightarrow{5} i & C &\xrightarrow{5} h & c &\xrightarrow{5} k \xrightarrow{5} m & d &\xrightarrow{5} g & f &\xrightarrow{5} j \xrightarrow{5} l \\
A &\xrightarrow{6} c & B &\xrightarrow{6} f & C &\xrightarrow{6} D \xrightarrow{6} j & a &\xrightarrow{6} b \xrightarrow{6} k \xrightarrow{6} n & d &\xrightarrow{6} e & h &\xrightarrow{6} i \xrightarrow{6} l \\
A &\xrightarrow{7} i & c &\xrightarrow{7} l & A &\xrightarrow{8} j & a &\xrightarrow{8} i & b &\xrightarrow{8} l \\
B &\xrightarrow{9} i & c &\xrightarrow{9} m & f &\xrightarrow{9} l & A &\xrightarrow{10} k & B &\xrightarrow{10} j & C &\xrightarrow{10} i & D &\xrightarrow{10} l & b &\xrightarrow{10} m & c &\xrightarrow{10} n \\
C &\xrightarrow{11} j & a &\xrightarrow{11} k & b &\xrightarrow{11} n & h &\xrightarrow{11} l & A &\xrightarrow{12} m & B &\xrightarrow{12} l \\
A &\xrightarrow{13} n & C &\xrightarrow{13} l & a &\xrightarrow{13} m
\end{aligned}$$

Consider the coadjoint case, let  $x \in \mathfrak{n}$ . Then  $A \xrightarrow[4.B]{1} B$ ,  $A \xrightarrow[4.B]{2} C$ ,  $A \xrightarrow[4.B]{4} D$ . Let  $x_A$  be ample. Then  $B \xrightarrow[1.B]{3} C$ ,  $B \xrightarrow[5.A]{5} D$ . Suppose that  $x_B$  is also ample. Then  $C \xrightarrow[5.A]{6} D$ .

Adjoint case, let  $x \in \mathfrak{g}/\mathfrak{p}^-$ . Then  $l \xrightarrow[4.A]{-10} D$ ,  $l \xrightarrow[4.A]{-12} B$ ,  $l \xrightarrow[4.A]{-13} C$ . Let  $x_l = 0$ . Then  $i \xrightarrow[1.A]{-5} D$ ,  $i \xrightarrow[1.A]{-10} C$ ,  $i \xrightarrow[4.B]{-9} B$ . Let  $x_i = 0$ . Then  $j \xrightarrow[1.A]{-6} D$ ,  $j \xrightarrow[1.A]{-10} B$ ,  $j \xrightarrow[4.B]{-11} C$ . Let  $x_j = 0$ ,  $x_g \neq 0$ . Then we first apply  $\exp(p_{-3})$  and  $\exp(p_{-5})$  to make  $x_e = x_d = 0$ , then  $g \xrightarrow[1.A]{-2} D$ ,  $g \xrightarrow[1.A]{-4} C$ ,  $B \xrightarrow[4.B]{-1} A$ . Let  $x_g = 0$ ,  $x_e \neq 0$ . First, we apply  $\exp(p_{-6})$  to make

$x_d = 0$ , then  $e \xrightarrow[1.A]{-1} D$ ,  $e \xrightarrow[1.A]{-4} B$ ,  $C \xrightarrow[4.B]{-2} A$ . Let  $x_e = 0$ . Then  $d \xrightarrow[5.C]{-1} C$ ,  $d \xrightarrow[5.C]{-2} B$ ,  $D \xrightarrow[4.B]{-4} A$ . Let  $x_d = 0$ . Then  $h \xrightarrow[4.A]{-3} D$ ,  $h \xrightarrow[4.A]{-5} C$ ,  $B \xrightarrow[4.B]{-1} A$ . Let  $x_h = 0$ . Then  $D \xrightarrow[5.A]{-6} C$ ,  $D \xrightarrow[5.A]{-5} B$ ,  $D \xrightarrow[4.B]{-4} A$ . Let  $x_D$  be ample. Then  $C \xrightarrow[1.B]{-3} B$ ,  $C \xrightarrow[4.B]{-2} A$ . Let  $x_C$  be ample, then  $B \xrightarrow[4.B]{-1} A$ .

§5. TABLE

1		2		3		4	
5		6		7		8	
9		10		11		12	
13		14		15		16	
17		18		19		20	
21		22		23		24	
25		26		27		28	
29		30		31		32	
33		34		35		36	
37		38		39		40	
41		42		43		44	
45		46		47		48	
49		50		51		52	
53		54		55		56	
57		58		59			

REFERENCES

[BHR] T. Brüstle, L. Hille, G. Röhrle, *Finiteness for parabolic group actions in classical groups*, Arch. Math. **76**(2) (2001), 81–87.  
 [Ka] V. G. Kac, *Some remarks on nilpotent orbits*, J. Algebra **64** (1980), 190–213.  
 [Li] W. Lichtenstein, *A system of quadrics describing the orbit of the highest weight vector*, Proc. A.M.S. **84** (1982), 605–608.  
 [LW] R. Lipsman, J. Wolf, *Canonical semi-invariants and the Plancherel formula for parabolic groups*, Trans. Amer. Math. Soc. **269**(1) (1982), 111–131.  
 [PR] V. Popov, G. Röhrle, *On the number of orbits of a parabolic subgroup on its unipotent radical*, Algebraic Groups and Lie Groups, Lehrer G.I., Ed., Austr. Math. Soc. Lecture Series **9** (1997).

- [Ri] R.W. Richardson, *Conjugacy classes of  $n$ -tuples in Lie algebras and algebraic groups*, Duke Math. J. **57** (1988), 1–35.
- [Te1] E. Tevelev, *Moore–Penrose inverse, parabolic subgroups, and Jordan pairs*, to appear in: Journal of Lie Theory.
- [Te2] E. Tevelev, *Isotropic subspaces of multi-linear forms*, Matematicheskie Zametki **69(6)** (2001), 925–933 (in Russian).
- [VO] E. Vinberg, A. Onischik, “Seminar on Lie Groups and Algebraic Groups”, Berlin: Springer, 1990.
- [Vi] E. Vinberg, *On stability of actions of reductive algebraic groups.*, In: Lie Algebras, Rings and Related Topics (Fong Yuen, A.A.Mikhalev, E.Zelmanov, Eds.), Springer, Hong Kong (2000), 188-202.