

Abelian ideals in a Borel subalgebra of a complex simple Lie algebra

Ruedi Suter

Departement Mathematik, ETH Zürich,
ETH Zentrum, 8092 Zürich, Switzerland
suter@math.ethz.ch

Abstract

Let \mathfrak{g} be a complex simple Lie algebra and \mathfrak{b} a fixed Borel subalgebra of \mathfrak{g} . We shall describe the abelian ideals of \mathfrak{b} in a uniform way, that is, independent of the classification of complex simple Lie algebras.

1 Introduction

Let \mathfrak{g} be a complex simple Lie algebra and \mathfrak{b} a fixed Borel subalgebra of \mathfrak{g} .

This paper has three purposes. First, the maximal dimension among the abelian ideals in \mathfrak{b} is determined purely in terms of certain invariants (dual Coxeter number and numbers of positive roots) of the root system and some associated root subsystems. To assuage any possible curiosity we already list the maximal dimensions together with their computations for the five exceptional types. The whole picture will be revealed in the table on page 29.

$$g_{E_6} - 1 + N_{A_5} - N_{A_4} = 12 - 1 + 15 - 10 = 16$$

$$g_{E_7} - 1 + N_{D_6} - N_{D_5} = 18 - 1 + 20 - 10 = 27$$

$$g_{E_8} - 1 + N_{A_7} - N_{A_6} = 30 - 1 + 28 - 21 = 36$$

$$g_{F_4} - 1 + N_{A_1} - N_{\emptyset} = 9 - 1 + 1 - 0 = 9$$

$$g_{G_2} - 1 + N_{\emptyset} - N_{\emptyset} = 4 - 1 + 0 - 0 = 3$$

Second, we answer a question of Panyushev and Röhrle, asking for a uniform explanation for the one-to-one correspondence between the maximal

abelian ideals in \mathfrak{b} and the long simple roots. More generally, in our approach all positive long roots will emerge in a natural way.¹

Third, we keep the promise² of giving a generalization and explanation of the symmetry property of a certain subposet of Young's lattice (the lattice of integer partitions) that was observed in [Sut] and which we now recall. For that consider the subposet \mathbb{Y}_N of Young's lattice induced by the Young diagrams whose (largest) hook lengths are at most $N - 1$. One sees easily that the poset \mathbb{Y}_N has 2^{N-1} elements. This follows for instance by associating to each such diagram an integer between 0 and $2^{N-1} - 1$ by the following procedure: in each column of the diagram write the figure 1 at the bottom and fill the rest by 0; then read the binary number along the rim.

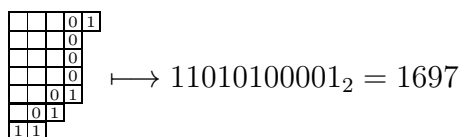

The main result of [Sut] states that the Hasse graph of \mathbb{Y}_N (considered as an undirected graph) has the dihedral group Dih_N of order $2N$ as its automorphism group provided $N \geq 3$. The following figure exemplifies this fact for $N = 5$.

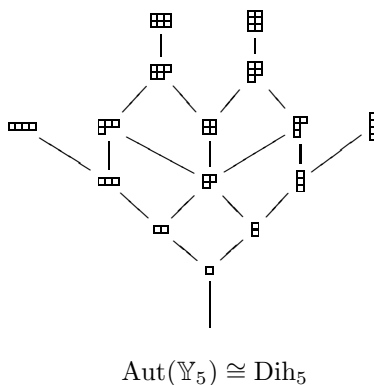

The case dealt with in [Sut] is now seen as the A_{N-1} case, i.e., associated with the Lie algebra $\mathfrak{g} = \mathfrak{sl}_N(\mathbb{C})$. It is so to say the most spectacular case.

¹In the very recent preprint [Pan] Panyushev answers this question. He finds the natural mapping from the set of nonzero abelian ideals onto the set of positive long roots, too. He then proves that each fibre of this mapping is a poset having a unique maximal element and a unique minimal element and asks for further investigating the poset structure and, in particular, to find a general description of the maximal element of each fibre. Our main theorem solves this problem.

²The announcement was made in [Stu] as well as in a talk one year ago in the algebra and topology seminar at ETH Zurich. I decided to post the present version of the paper rather than keep it back any longer.

The reason is that its affine Coxeter-Dynkin graph is a cycle of length N . Its dihedral symmetry induces a dihedral symmetry on a certain simplicial complex \mathcal{C} . The Hasse graph of \mathbb{Y}_N can be geometrically realized as the 1-skeleton of the cell complex dual to \mathcal{C} .

Let me close this section with a brief historical narrative. In his 1905 paper [Sch] in Crelle's journal I. Schur proved that the maximum number of linearly independent commuting $N \times N$ matrices is $\lfloor \frac{N^2}{4} \rfloor + 1$. In 1944 Jacobson [Jac] gave a simplified derivation of Schur's result. In the next year A. Malcev [Mal] determined the commutative subalgebras of maximum dimension of the semisimple complex Lie groups, or equivalently, their Lie algebras. The next entry in this short historical outline is Kostant's paper [K1] published in 1965. There he gave a connexion of Malcev's result with the maximal eigenvalue of the Laplacian acting on the exterior powers $\bigwedge^k \mathfrak{g}$ of the adjoint representation. Kostant [K2] again, in 1998, reconsidered the theme of abelian ideals in a Borel subalgebra of \mathfrak{g} and reported inter alia about Peterson's proof that the number of abelian ideals in a fixed Borel subalgebra of \mathfrak{g} is $2^{\text{rank } \mathfrak{g}}$. This, in Kostant's words, utterly surprising and ingenious proof involves the affine Weyl group.

A natural generalization of Peterson's approach from abelian to ad-nilpotent ideals was developed recently by several authors in various collaborations [AKOP, CP1, CP2, CP3, KOP], see also [Shi], and for Kostant's results [CMP].

2 Notations and tools

Basic facts concerning root systems can be found in the standard references [Bou, Hum] and also in [Bro, Hil]. Let us fix a complex simple Lie algebra \mathfrak{g} of rank l together with a Borel subalgebra \mathfrak{b} and a Cartan subalgebra $\mathfrak{h} \subseteq \mathfrak{b}$. Associated with these data there are quite a number of further objects whose notations are provided in the following table. Most of them are standard (but sometimes there are different conventions). We list the most important notations used here for the reader's convenience.

A	(closed) fundamental alcove,
Alt_N	alternating group of degree N ,
C	(closed) dominant chamber,
Dih_N	dihedral group of order $2N$,
F_i	facets of type i ($i = 0, \dots, l$) of the fundamental alcove A ,
g	dual Coxeter number,
\mathfrak{g}_φ	root subspace,
h	Coxeter number,

$\mathfrak{h}_{\mathbb{R}}^*, \mathfrak{h}_{\mathbb{R}}$	real vector space spanned by the roots, and its predual,
H_i	hyperplanes supporting the facets F_i ($i = 0, \dots, l$) of A ,
l	$= \text{rk } \mathfrak{g}$,
ℓ	length function on \widehat{W} or on W ,
L	$L(\varphi) = \frac{2(\theta - \varphi \rho)}{(\theta \theta)}$,
m_i	exponents ($i = 1, \dots, l$),
n_i	marks ($i = 1, \dots, l$), $\theta = \sum_{i=1}^l n_i \alpha_i$, in addition, $n_0 = 1$,
$N_{\mathbf{X}}$	number of positive roots for a root system of type \mathbf{X} ,
s_i	simple reflections ($i = 1, \dots, l$), in addition, $s_0 : \mathfrak{h}_{\mathbb{R}}^* \rightarrow \mathfrak{h}_{\mathbb{R}}^*$, $s_0(\lambda) = \lambda - \langle \lambda, \theta^\vee \rangle \theta + g\theta$,
s_θ	reflection along the highest root, $s_\theta(\lambda) = s_0(\lambda) - s_0(0)$,
Sym_N	symmetric group of degree N ,
$w_\circ^\varphi, \widehat{w}_\circ^\varphi$	longest elements in $W_{\perp\varphi}, \widehat{W}_{\perp\varphi}$, respectively,
W, \widehat{W}	finite Weyl group, affine Weyl group,
$W_{\perp\varphi}$	$= \text{gp}(s_i \mid \alpha_i \perp \varphi \ (i = 1, \dots, l))$,
$\widehat{W}_{\perp\varphi}$	$\widehat{W}_{\perp\varphi} = W_{\perp\varphi}$ if $\theta \not\perp \varphi$, $\widehat{W}_{\perp\varphi} = \text{gp}(s_0, W_{\perp\varphi})$ if $\theta \perp \varphi$,
α_i	simple roots ($i = 1, \dots, l$), in addition, $\alpha_0 = -\theta$,
θ	highest root,
ϖ_i	fundamental weights ($i = 1, \dots, l$),
$\check{\varpi}_i$	$= \frac{1}{\ \alpha_i\ ^2} \varpi_i$,
Π	$= \{\alpha_1, \dots, \alpha_l\}$ set of simple roots,
ρ	half the sum of positive roots,
φ^\vee	coroot corresponding to $\varphi \in \Phi$,
Φ, Φ_\pm	root system, set of positive/negative roots,
$\Phi(\mathfrak{a})$	positive roots such that $\mathfrak{a} = \bigoplus_{\varphi \in \Phi(\mathfrak{a})} \mathfrak{g}_\varphi$,
Φ_w	$= \Phi_+ \cap w\Phi_-$,
$\widehat{\Phi}, \widehat{\Phi}_\pm$	affine root system, set of positive/negative affine roots,
$\widehat{\Phi}_{\widehat{w}}$	$= \widehat{\Phi}_+ \cap \widehat{w}\widehat{\Phi}_-$,
(\mid)	canonical bilinear form on $\mathfrak{h}_{\mathbb{R}}^*$,
$\ \ \ $	norm from (\mid) ,
$\langle \ , \ \rangle$	natural pairing,
$[\]$	$[n] = \frac{1-t^n}{1-t}$.

We denote by $\Phi_+ \subseteq \mathfrak{h}^*$ the set of positive roots. Here the convention is that the root subspaces of \mathfrak{b} belong to positive roots, i.e., $\mathfrak{b} = \mathfrak{h} \oplus \bigoplus_{\varphi \in \Phi_+} \mathfrak{g}_\varphi$, where \mathfrak{g}_φ is the (1-dimensional) root subspace on which \mathfrak{h} acts by the weight

φ , that is, $\mathfrak{g}_\varphi = \{X \in \mathfrak{g} \mid [H, X] = \varphi(H)X \ \forall H \in \mathfrak{h}\}$. As further pieces of notation we write $\Phi_- = -\Phi_+$ for the set of negative roots, $\Phi = \Phi_+ \amalg \Phi_-$ for the root system of \mathfrak{g} relative to \mathfrak{h} , and $\Pi \subseteq \Phi_+$ for the root basis. Recall that Π consists of the roots in Φ_+ that lie on the edges of the polyhedral (in fact, simplicial) cone spanned by the vectors in Φ_+ . Each positive root is a linear combination of the vectors in Π with nonnegative integral coefficients. The Weyl group of Φ will be denoted by W . More about Weyl groups and some geometry associated with them will be recalled at the appropriate place below.

Now let $\mathfrak{a} \trianglelefteq \mathfrak{b}$ be an ideal. It is $\mathfrak{ad} \mathfrak{h}$ -stable and hence compatible with the root space decomposition. If we further require that \mathfrak{a} lies in the nilpotent radical $\mathfrak{n} = [\mathfrak{b}, \mathfrak{b}]$, we get that \mathfrak{a} is of the form $\mathfrak{a} = \bigoplus_{\varphi \in \Psi} \mathfrak{g}_\varphi$ for some subset $\Psi \subseteq \Phi_+$ of positive roots. The ideal property of \mathfrak{a} translates into the condition for Ψ that $\Psi \dot{+} \Phi_+ := (\Psi + \Phi_+) \cap \Phi_+ \subseteq \Psi$. If, in addition, \mathfrak{a} is supposed to be abelian (so that $\mathfrak{a} \subseteq [\mathfrak{b}, \mathfrak{b}]$ holds automatically), we must have $\Psi \dot{+} \Psi := (\Psi + \Psi) \cap \Phi_+ = \emptyset$. It is plain that there is the following bijection.

$$\left\{ \begin{array}{l} \text{subsets } \Psi \subseteq \Phi_+ \text{ such that} \\ \Psi \dot{+} \Phi_+ \subseteq \Psi \text{ and } \Psi \dot{+} \Psi = \emptyset \end{array} \right\} \xrightarrow{\cong} \{ \text{abelian ideals } \mathfrak{a} \trianglelefteq \mathfrak{b} \}$$

$$\Psi \longmapsto \mathfrak{a}_\Psi := \bigoplus_{\varphi \in \Psi} \mathfrak{g}_\varphi$$

The inner product. Before we can go on and state Konstant's theorem, which will be an essential tool for our approach, we recall the canonical inner product on the real vector space $\mathfrak{h}_{\mathbb{R}}^*$ spanned by the (finite) irreducible (reduced) root system Φ . This inner product will be denoted by (\mid) and the associated Euclidean norm by $\| \cdot \|$. It is characterized by being W -invariant and satisfying the normalization $\|\rho + \theta\|^2 - \|\rho\|^2 = 1$ where ρ is half the sum of positive roots and θ is the highest root.

Remark The canonical inner product is the restriction to $\mathfrak{h}_{\mathbb{R}}^*$ of the symmetric bilinear form dual to the Killing form of \mathfrak{g} . There are several alternative descriptions of the same normalization. Here is a short list.

$\|\rho + \theta\|^2 - \|\rho\|^2 = 1$, i. e., the eigenvalue of the Casimir operator associated to the Killing form is 1 for the adjoint representation;

$\|\theta\|^{-2} = g$, the dual Coxeter number;

$\|\rho\|^2 = \frac{1}{24} \dim \mathfrak{g}$, the ‘‘strange formula’’ of Freudenthal and de Vries;

$\sum_{\varphi \in \Phi} \|\varphi\|^2 = \text{rk } \mathfrak{g}$, a formula due to G. Brown;

$\|\theta\|^2 + \sum_{i=1}^l n_i \|\alpha_i\|^2 = 1$, where n_1, \dots, n_l are the marks and $\alpha_1, \dots, \alpha_l$ the simple roots. (The formula looks funnier if one substitutes $\sum_{i=1}^l n_i \alpha_i$ for θ .) One can show the formula by writing $\|\theta\|^{-2} = g$ and using the connexion between the Coxeter number and the dual Coxeter number. Another derivation will be given in the remark on page 32.

Definition For $\Psi \subseteq \Phi_+$ we define its root sum $\langle \Psi \rangle := \sum_{\varphi \in \Psi} \varphi$.

Lemma 1 (Kostant) *Let $\Psi_i \subseteq \Phi_+$ with $\Psi_i + \Phi_+ \subseteq \Psi_i$ ($i = 1, 2$) (ideals) such that $\langle \Psi_1 \rangle = \langle \Psi_2 \rangle$. Then $\Psi_1 = \Psi_2$.*

Proof. Let $\Psi := \Psi_1 \cap \Psi_2$. Assume to the contrary that $\Psi_1 \neq \Psi_2$. Then since $\langle \Psi_1 \rangle = \langle \Psi_2 \rangle$ both $\Psi_1 - \Psi$ and $\Psi_2 - \Psi$ are nonempty. Let $\varphi_i \in \Psi_i - \Psi$ ($i = 1, 2$). We must have $(\varphi_1 | \varphi_2) \leq 0$. Otherwise $\varphi_1 - \varphi_2$ would be a root which can be assumed positive by possibly interchanging the indices 1 and 2. By the ideal property $\Psi_i + \Phi_+ \subseteq \Psi_i$ we then have $\varphi_1 = \varphi_2 + (\varphi_1 - \varphi_2) \in \Psi_2$, a contradiction. Thus $(\varphi_1 | \varphi_2) \leq 0$. Hence since $\langle \Psi_1 - \Psi \rangle = \langle \Psi_2 - \Psi \rangle$ we obtain

$$0 \leq \|\langle \Psi_i - \Psi \rangle\|^2 = (\langle \Psi_1 - \Psi \rangle | \langle \Psi_2 - \Psi \rangle) \leq 0$$

and so $\Psi = \Psi_1 = \Psi_2$. □

Like the previous lemma the following theorem is due to Kostant and was published in 1965.

Theorem 2 (Kostant) *Let $\Psi \subseteq \Phi_+$ be a set of positive roots. Let $\mathfrak{a}_\Psi := \bigoplus_{\varphi \in \Psi} \mathfrak{g}_\varphi \subseteq \mathfrak{b}$ be the corresponding subspace. Then one always has the inequality*

$$\left\| \rho + \sum_{\varphi \in \Psi} \varphi \right\|^2 - \|\rho\|^2 \leq |\Psi|$$

with equality if and only if \mathfrak{a}_Ψ is an abelian ideal of \mathfrak{b} (and every abelian ideal of \mathfrak{b} is of this form).

In particular, one recovers the normalization $\|\rho + \theta\|^2 - \|\rho\|^2 = 1$ because $\mathfrak{g}_\theta \leq \mathfrak{b}$ is an abelian ideal.

Reflections and Weyl groups. We will see that each sum $\rho + \sum_{\varphi \in \Psi} \varphi = \rho + \langle \Psi \rangle$ that occurs in Kostant's theorem and such that \mathfrak{a}_Ψ is an abelian ideal in \mathfrak{h} can be written as $\rho + \langle \Psi \rangle = \widehat{w}\rho$ for some element \widehat{w} in the affine Weyl group \widehat{W} . Here, the affine Weyl group is the group of affine isometries of $\mathfrak{h}_\mathbb{R}^*$ generated by the finite Weyl group W —which is itself generated by the simple reflections s_1, \dots, s_l along the simple roots $\alpha_1, \dots, \alpha_l$, that is,

$$s_i : \lambda \mapsto \lambda - \frac{2(\lambda|\alpha_i)}{(\alpha_i|\alpha_i)} \alpha_i = \lambda - \langle \lambda, \alpha_i^\vee \rangle \alpha_i$$

—and, in addition, the affine reflection

$$s_0 : \lambda \mapsto \lambda - \left(\frac{2(\lambda|\theta)}{(\theta|\theta)} - g \right) \theta = \lambda - (\langle \lambda, \theta^\vee \rangle - g) \theta = s_\theta \lambda + g\theta.$$

Here, $\langle \cdot, \cdot \rangle : \mathfrak{h}_\mathbb{R}^* \times \mathfrak{h}_\mathbb{R} \rightarrow \mathbb{R}$ is the natural pairing, and $\alpha_1^\vee, \dots, \alpha_l^\vee, \theta^\vee$ are the coroots corresponding to $\alpha_1, \dots, \alpha_l, \theta$. More generally, for any root $\varphi \in \Phi$ the corresponding coroot $\varphi^\vee \in \mathfrak{h}_\mathbb{R}^*$ is defined by

$$\langle \lambda, \varphi^\vee \rangle = \frac{2(\lambda|\varphi)}{(\varphi|\varphi)} \quad \forall \lambda \in \mathfrak{h}_\mathbb{R}^*.$$

The affine Weyl group \widehat{W} is a Coxeter group with Coxeter generators s_0, \dots, s_l . Let $\ell : \widehat{W} \rightarrow \mathbb{Z}_{\geq 0}$ be the usual length function, $\ell(\widehat{w}) = r$ if $\widehat{w} = s_{i_1} \dots s_{i_r}$ with $i_1, \dots, i_r \in \{0, \dots, l\}$ and r minimal. Similarly, denoting again by $\ell : W \rightarrow \mathbb{Z}_{\geq 0}$ the length function of the parabolic subgroup $W \subseteq \widehat{W}$, one knows that it coincides with the restriction of the length function of \widehat{W} .

Remark The definition of the affine Weyl group is not exactly the standard but a scaled one, to the effect that $s_0\rho = \rho + \theta$. One has the well-known decomposition $\widehat{W} \cong gM \rtimes W$ of \widehat{W} as a semidirect product of W acting on the normal subgroup gM , the lattice spanned by the long roots and dilated by the factor g , in the obvious way. Each element $\mu \in gM$ acts as the translation $\lambda \mapsto \lambda + \mu$.

There is of course also the linear version of the affine Weyl group acting on $\mathfrak{h}_\mathbb{R}^* \oplus \mathbb{R}\delta \oplus \mathbb{R}\Lambda_0$ as in the book [Kac]. One extends the inner product in $\mathfrak{h}_\mathbb{R}^*$ to a nondegenerate symmetric bilinear form, again denoted $(\cdot | \cdot)$, by declaring that δ and Λ_0 are isotropic vectors perpendicular to $\mathfrak{h}_\mathbb{R}^*$ and such that $(\delta|\Lambda_0) = 1$. We denote by abuse of notation the reflections $s_0, \dots, s_l \in O(\mathfrak{h}_\mathbb{R}^* \oplus \mathbb{R}\delta \oplus \mathbb{R}\Lambda_0, (\cdot | \cdot))$ given by the formula

$$s_i : \lambda \mapsto \lambda - \frac{2(\lambda|\alpha_i)}{(\alpha_i|\alpha_i)} \alpha_i,$$

where $\alpha_1, \dots, \alpha_l$ are the simple roots as usual but now $\alpha_0 = \delta - \theta$. The group generated by s_0, \dots, s_l will again by abuse of notation be denoted by \widehat{W} . Each

affine hyperplane $\mathfrak{h}_{\mathbb{R}}^* \oplus \mathbb{R}\delta + c\Lambda_0$ is mapped into itself by the reflections s_0, \dots, s_l . The action of \widehat{W} on $\mathfrak{h}_{\mathbb{R}}^*$ defined previously comes from the action of \widehat{W} on the subquotient $\mathfrak{h}_{\mathbb{R}}^* \oplus \mathbb{R}\delta + \frac{1}{2}\Lambda_0 \pmod{\mathbb{R}\delta}$ if one identifies this subquotient with $\mathfrak{h}_{\mathbb{R}}^*$ in the evident way.

The fundamental weights $\varpi_1, \dots, \varpi_l \in \mathfrak{h}_{\mathbb{R}}^*$ are the basis dual to the basis $\alpha_1^\vee, \dots, \alpha_l^\vee$ of $\mathfrak{h}_{\mathbb{R}}$. Recall also that $\rho = \sum_{i=1}^l \varpi_i$. The next definition is slightly non-standard: define $\check{\varpi}_1, \dots, \check{\varpi}_l \in \mathfrak{h}_{\mathbb{R}}^*$ by $(\check{\varpi}_i | \alpha_j) = \delta_{ij} \frac{1}{2}$, that is, $\check{\varpi}_i = \frac{1}{\|\alpha_i\|^2} \varpi_i$.

The map $\widehat{W} \rightarrow \mathfrak{h}_{\mathbb{R}}^*$, $\widehat{w} \mapsto \widehat{w}\rho$ is injective. Its image will be termed the set of **ρ -points**. Let

$$A = \{ \lambda \in \mathfrak{h}_{\mathbb{R}}^* \mid (\lambda | \alpha) \geq 0 \text{ for all } \alpha \in \Pi \text{ and } \langle \lambda, \theta^\vee \rangle \leq g \}$$

be the (closed) fundamental alcove, which is a fundamental domain for \widehat{W} acting on $\mathfrak{h}_{\mathbb{R}}^*$. The fundamental alcove A is the simplex whose vertices are $0, \frac{\check{\varpi}_1}{n_1}, \dots, \frac{\check{\varpi}_l}{n_l}$ where n_1, \dots, n_l are the marks, i. e., the (positive integer) coefficients in $\theta = \sum_{i=1}^l n_i \alpha_i$.

The cone with apex 0 spanned by A is the dominant chamber

$$C = \{ \lambda \in \mathfrak{h}_{\mathbb{R}}^* \mid (\lambda | \alpha) \geq 0 \text{ for all } \alpha \in \Pi \}.$$

It is a fundamental domain for the finite Weyl group W .

The \widehat{W} -translates of the fundamental alcove are called alcoves. For each $i = 0, \dots, l$ one has the (affine if $i = 0$) hyperplane

$$H_i := \{ \lambda \in \mathfrak{h}_{\mathbb{R}}^* \mid s_i \lambda = \lambda \},$$

and their \widehat{W} -translates are termed walls.

The ρ -points are precisely the integral weights in the interior of an alcove. So there are the natural bijections

$$\begin{array}{ccc} \widehat{W} & \xrightarrow{\cong} & \{\text{alcoves}\} & \xrightarrow{\cong} & \{\rho\text{-points}\} \\ \widehat{w} & \longleftrightarrow & \widehat{w}A & \longleftrightarrow & \widehat{w}\rho. \end{array}$$

We have already mentioned above that $\rho + \theta$ is the ρ -point of the alcove s_0A . The ρ -points of the other neighbours s_1A, \dots, s_lA of the fundamental alcove are $\rho - \alpha_1, \dots, \rho - \alpha_l$. This follows because s_i (for $i = 1, \dots, l$) permutes all positive roots other than α_i and $s_i(\alpha_i) = -\alpha_i$.

The following picture shows part of the tessellation of the plane by alcoves for type G_2 . The shaded region marks the fundamental alcove A . The boundaries of the four alcoves in $2A = \{2\lambda \mid \lambda \in A\}$ are drawn in solid lines.

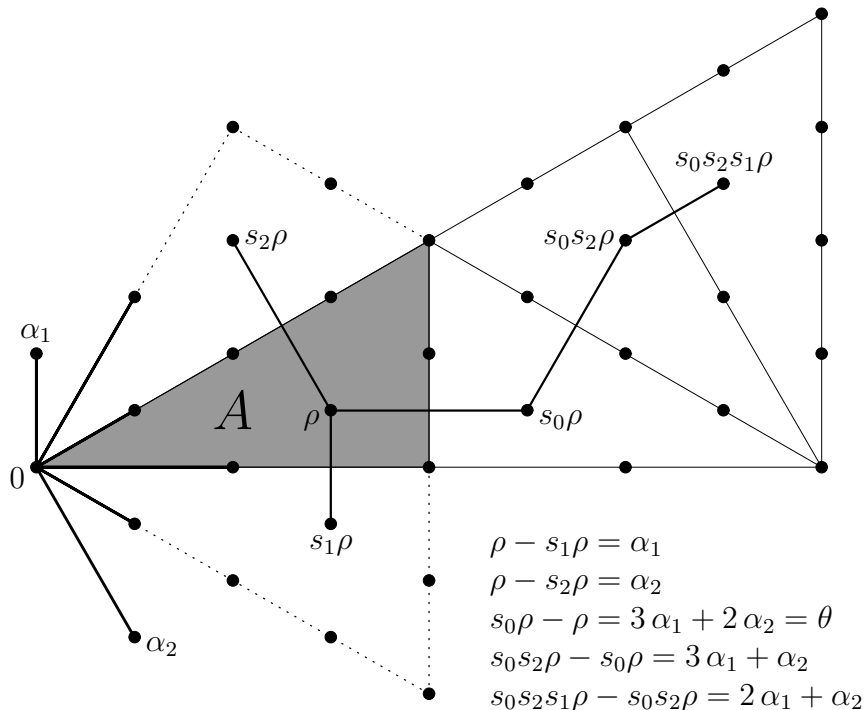

Passing from the sum $\rho + \langle \Psi \rangle = \widehat{w}\rho$ to the corresponding alcove $\widehat{w}A$, one can rephrase Kostant's theorem by saying that the alcoves belonging to an abelian ideal are exactly those lying in $2A$ (so there are 2^l of them).

Let us also recall that there is a close connexion between reduced expressions for elements $\widehat{w} \in \widehat{W}$ and minimal galleries going from A to $\widehat{w}A$. In fact, in general, one has the bijection

$$\begin{aligned} \{\text{words in } s_0, \dots, s_l\} &\xrightarrow{\cong} \{\text{non-stuttering galleries beginning at } A\} \\ s_{i_1}s_{i_2}\dots s_{i_r} &\longleftrightarrow A, s_{i_1}A, s_{i_1}s_{i_2}A, \dots, s_{i_1}s_{i_2}\dots s_{i_r}A, \end{aligned}$$

and reduced words correspond to minimal galleries. The length $\ell(\widehat{w})$ is the number of walls for which A and $\widehat{w}A$ lie on opposite sides of the wall.

3 Explicit description of the abelian ideals

Our approach to describing the abelian ideals hinges on the observation that for each abelian ideal $\mathfrak{a} \leq \mathfrak{b}$ its subspace $\mathfrak{a}^{\neq \theta}$ spanned by the root subspaces

for the roots that are not perpendicular to the highest root θ is again an abelian ideal in \mathfrak{b} . This is the content of the next proposition.

Proposition 3 *Let $\mathfrak{a} \trianglelefteq \mathfrak{b}$ be an abelian ideal with $\Phi(\mathfrak{a}) \subseteq \Phi_+$ the corresponding set of positive roots. Then*

$$\Phi^{\perp\theta}(\mathfrak{a}) := \{\varphi \in \Phi(\mathfrak{a}) \mid (\varphi|\theta) > 0\}$$

is also the set of positive roots for an abelian ideal $\mathfrak{a}^{\perp\theta} \trianglelefteq \mathfrak{b}$:

$$\Phi^{\perp\theta}(\mathfrak{a}) = \Phi(\mathfrak{a}^{\perp\theta}) \quad (= \Phi^{\perp\theta}(\mathfrak{a}^{\perp\theta})).$$

Proof. The abelianess is clear: $\Phi^{\perp\theta}(\mathfrak{a}) \dot{+} \Phi^{\perp\theta}(\mathfrak{a}) \subseteq \Phi(\mathfrak{a}) \dot{+} \Phi(\mathfrak{a}) = \emptyset$. That the ideal property holds is also easy to show. For that we must see that $\Phi^{\perp\theta}(\mathfrak{a}) \dot{+} \Phi_+ \subseteq \Phi^{\perp\theta}(\mathfrak{a})$. Let $\varphi \in \Phi^{\perp\theta}(\mathfrak{a})$ and $\varphi' \in \Phi_+$. Of the four a priori possibilities (1) $\varphi + \varphi' \notin \Phi_+$, (2) $\varphi + \varphi' \in \Phi_+ - \Phi(\mathfrak{a})$, (3) $\varphi + \varphi' \in \Phi(\mathfrak{a}) - \Phi^{\perp\theta}(\mathfrak{a})$, (4) $\varphi + \varphi' \in \Phi^{\perp\theta}(\mathfrak{a})$, we must exclude the cases (2) and (3). That (2) is impossible follows from $\Phi^{\perp\theta}(\mathfrak{a}) \subseteq \Phi(\mathfrak{a})$ and the fact that \mathfrak{a} is an ideal. Case (3) cannot occur because $(\varphi'|\theta) \geq 0$ and hence $(\varphi + \varphi'|\theta) > 0$ by the definition of $\Phi^{\perp\theta}(\mathfrak{a})$. \square

Now the problem of describing the abelian ideals in \mathfrak{b} decomposes into two problems according to the disjoint union decomposition

$$\{\text{abelian ideals } \mathfrak{a} \trianglelefteq \mathfrak{b}\} = \coprod_{\mathfrak{a}'} \{\text{abelian ideals } \mathfrak{a} \trianglelefteq \mathfrak{b} \text{ with } \mathfrak{a}^{\perp\theta} = \mathfrak{a}'\}.$$

The two tasks are

- (1) describe the index set $\{\mathfrak{a}' \mid \mathfrak{a}' \trianglelefteq \mathfrak{b} \text{ abelian ideal with } \mathfrak{a}' = \mathfrak{a}'^{\perp\theta}\}$;
- (2) for each $\mathfrak{a}' = \mathfrak{a}'^{\perp\theta}$ describe the set of abelian ideals \mathfrak{a} with $\mathfrak{a}' = \mathfrak{a}^{\perp\theta}$.

We will first deal with task (1) and show that there is a canonical one-to-one correspondence

$$\{\mathfrak{a}^{\perp\theta} \mid 0 \neq \mathfrak{a} \trianglelefteq \mathfrak{b} \text{ abelian ideal}\} \xrightarrow{\cong} \Phi_+^{(\text{long})}$$

(see Theorem 7 below). This will then extend and give an a priori explanation for the observation that the maximal abelian ideals are in canonical one-to-one correspondence with the simple long roots, as it was recorded in [PR]. We need some preparation.

Recall that the height $\text{ht}(\varphi)$ of a root $\varphi = \sum_{i=1}^l c_i \alpha_i$ is defined to be $\text{ht}(\varphi) = \sum_{i=1}^l c_i$, its coefficient sum with respect to the basis of simple roots. The simple

roots are those having height 1, and the highest root θ is the root whose height is maximal, namely, $\text{ht}(\theta) = h - 1$, which is 1 less than the Coxeter number.

For our purpose a modification of the height will be important. We define the affine functional $L : \mathfrak{h}_{\mathbb{R}}^* \rightarrow \mathbb{R}$ by

$$L(\varphi) := \frac{2(\theta - \varphi|\rho)}{(\theta|\theta)}. \quad (1)$$

Whereas $\text{ht}(\varphi) > 0$ for $\varphi \in \Phi_+$ and $\text{ht}(\varphi) < 0$ for $\varphi \in \Phi_-$, we have $L(\varphi) \geq 0$ for all $\varphi \in \Phi$; more precisely, $L(\theta) = 0$ and $L(\varphi) > 0$ for all $\varphi \in \Phi - \{\theta\}$. A second modification concerns the root lengths. Let us write again $\varphi = \sum_{i=1}^l c_i \alpha_i$. Then

$$\begin{aligned} L(\varphi) &= \frac{2(\theta - \varphi|\rho)}{(\theta|\theta)} = g - 1 - \frac{2}{(\theta|\theta)} \left(\sum_{i=1}^l c_i \alpha_i \mid \sum_{j=1}^l \varpi_j \right) \\ &= g - 1 - \sum_{i=1}^l c_i \frac{(\alpha_i|\alpha_i)}{(\theta|\theta)} \end{aligned}$$

because $(\alpha_i|\varpi_j) = \frac{1}{2}(\alpha_i|\alpha_i) \delta_{ij}$. Note also that $L(\varphi) = g - 1 - \langle \rho, \varphi^\vee \rangle \in \mathbb{Z}_{\geq 0}$ if φ is a long root. In particular, for $\varphi \in \Phi_+^{(\text{long})}$ we have $L(\varphi) = g - 2$ if and only if φ is a long simple root. The affine functional L shows its importance in the following proposition.

Proposition 4 *For each positive long root $\varphi \in \Phi_+^{(\text{long})}$ there is a unique Weyl group element $w \in W$ of length $\ell(w) = L(\varphi)$ such that $w\varphi = \theta$ is the highest root. Moreover, $w'\varphi \neq \theta$ for all $w' \in W$ with $\ell(w') < L(\varphi)$.*

Proof. We first show the minimality that is expressed in the second sentence. Let s_i be a simple reflection with $s_i\varphi$ positive, too, hence $\varphi \neq \pm\alpha_i$. We compute

$$\begin{aligned} L(\varphi) - L(s_i\varphi) &= \frac{2(\theta - \varphi|\rho)}{(\theta|\theta)} - \frac{2(\theta - s_i\varphi|\rho)}{(\theta|\theta)} && \text{(by definition (1))} \\ &= -\frac{2(\varphi|\rho)}{(\theta|\theta)} + \frac{2(\varphi|s_i\rho)}{(\theta|\theta)} && \text{(by orthogonality)} \\ &= -\frac{2(\varphi|\rho)}{(\theta|\theta)} + \frac{2(\varphi|\rho - \alpha_i)}{(\theta|\theta)} && (s_i \text{ is a simple reflection)} \\ &= -\frac{2(\varphi|\alpha_i)}{(\theta|\theta)} = -\frac{2(\varphi|\alpha_i)}{(\varphi|\varphi)} && (\varphi \text{ is a long root)} \\ &= -\langle \alpha_i, \varphi^\vee \rangle \in \{0, \pm 1\}. && (\varphi \neq \pm\alpha_i \text{ is a long root)} \end{aligned}$$

It follows that $L(\varphi) = L(\varphi) - L(\theta) \leq \ell(w)$ if $w\varphi = \theta$.

The same calculation shows that given $\varphi \in \Phi_+^{(\text{long})} - \{\theta\}$, there exists a simple reflection s_i such that $L(\varphi) - L(s_i\varphi) = 1$. Otherwise, by the previous computation, we would get $\langle \alpha_i, \varphi^\vee \rangle \geq 0$ for all $i = 1, \dots, l$, so that φ would lie in the dominant chamber. This is absurd because θ is the only long dominant root and $\varphi \neq \theta$ by assumption. Hence there is a sequence $s_{i_1}, \dots, s_{i_{L(\varphi)}}$ of simple reflections such that $L(s_{i_p} s_{i_{p-1}} \dots s_{i_1} \varphi) = L(\varphi) - p$ (for $p = 0, \dots, L(\varphi)$). In particular, $s_{i_{L(\varphi)}} s_{i_{L(\varphi)-1}} \dots s_{i_1} \varphi = \theta$.

Uniqueness follows from the uniqueness of coset representatives of minimal length for standard parabolic subgroups. In fact, let $W_{\perp\theta}$ be the standard parabolic subgroup generated by the simple reflections that fix the highest root θ . Its Coxeter-Dynkin graph is the subgraph of the Coxeter-Dynkin graph of W induced by those nodes that are not adjacent to the affine node. The quotient in question is then the set of right cosets $W_{\perp\theta} \backslash W$. \square

The following table compiles for each long simple root α_i the Weyl group element w with $\ell(w) = g - 2$ and such that $w\alpha_i = \theta$. The labeling coincides with the labeling in the table following page 19.

X	i	w such that $w\alpha_i = \theta$
A_l	i	$s_1 \nearrow \dots s_{i-1} s_l \searrow \dots s_{i+1}$
C_l	l	$s_1 \nearrow \dots s_{l-1}$
B_l	i	$s_2 \nearrow \dots s_l s_1 \nearrow \dots s_{i-1} s_{l-1} \searrow \dots s_{i+1} \quad (i = 1, \dots, l-1)$
D_l	i	$s_2 \nearrow \dots s_{l-2} s_1 \nearrow \dots s_{i-1} s_l \searrow \dots s_{i+1} \quad (i = 1, \dots, l-2)$
	i	$s_2 \nearrow \dots s_{l-2} s_1 \nearrow \dots s_{l-3} s_{2l-i-1} s_{l-2} \quad (i = l-1, l)$
E_6	1	$s_1 s_2 s_3 s_4 s_2 s_5 s_3 s_6 s_4 s_2$
	2	$s_1 s_2 s_3 s_4 s_2 s_1 s_5 s_3 s_6 s_4$
	3	$s_1 s_2 s_3 s_4 s_2 s_1 s_5 s_6 s_4 s_2$
	4	$s_1 s_2 s_3 s_4 s_2 s_1 s_5 s_3 s_2 s_6$
	5	$s_1 s_2 s_3 s_4 s_2 s_1 s_6 s_4 s_2 s_3$
	6	$s_1 s_2 s_3 s_4 s_2 s_1 s_5 s_3 s_2 s_4$
E_7	1	$s_1 s_2 s_3 s_4 s_5 s_3 s_2 s_6 s_4 s_3 s_5 s_7 s_6 s_4 s_3 s_2$
	2	$s_1 s_2 s_3 s_4 s_5 s_3 s_2 s_1 s_6 s_4 s_3 s_5 s_7 s_6 s_4 s_3$
	3	$s_1 s_2 s_3 s_4 s_5 s_3 s_2 s_1 s_6 s_4 s_3 s_2 s_5 s_7 s_6 s_4$
	4	$s_1 s_2 s_3 s_4 s_5 s_3 s_2 s_1 s_6 s_4 s_3 s_2 s_5 s_3 s_7 s_6$
	5	$s_1 s_2 s_3 s_4 s_5 s_3 s_2 s_1 s_6 s_4 s_3 s_2 s_7 s_6 s_4 s_3$
	6	$s_1 s_2 s_3 s_4 s_5 s_3 s_2 s_1 s_6 s_4 s_3 s_2 s_5 s_3 s_4 s_7$
	7	$s_1 s_2 s_3 s_4 s_5 s_3 s_2 s_1 s_6 s_4 s_3 s_2 s_5 s_3 s_4 s_6$

E ₈	1	$s_1 s_2 s_3 s_4 s_5 s_6 s_7 s_5 s_4 s_3 s_2 s_8 s_6 s_5 s_4 s_3 s_7 s_5 s_4 s_6 s_5 s_7 s_8 s_6 s_5 s_4 s_3 s_2$
	2	$s_1 s_2 s_3 s_4 s_5 s_6 s_7 s_5 s_4 s_3 s_2 s_1 s_8 s_6 s_5 s_4 s_3 s_7 s_5 s_4 s_6 s_5 s_7 s_8 s_6 s_5 s_4 s_3$
	3	$s_1 s_2 s_3 s_4 s_5 s_6 s_7 s_5 s_4 s_3 s_2 s_1 s_8 s_6 s_5 s_4 s_3 s_2 s_7 s_5 s_4 s_6 s_5 s_7 s_8 s_6 s_5 s_4$
	4	$s_1 s_2 s_3 s_4 s_5 s_6 s_7 s_5 s_4 s_3 s_2 s_1 s_8 s_6 s_5 s_4 s_3 s_2 s_7 s_5 s_4 s_3 s_6 s_5 s_7 s_8 s_6 s_5$
	5	$s_1 s_2 s_3 s_4 s_5 s_6 s_7 s_5 s_4 s_3 s_2 s_1 s_8 s_6 s_5 s_4 s_3 s_2 s_7 s_5 s_4 s_3 s_6 s_5 s_4 s_7 s_8 s_6$
	6	$s_1 s_2 s_3 s_4 s_5 s_6 s_7 s_5 s_4 s_3 s_2 s_1 s_8 s_6 s_5 s_4 s_3 s_2 s_7 s_5 s_4 s_3 s_6 s_5 s_4 s_7 s_5 s_8$
	7	$s_1 s_2 s_3 s_4 s_5 s_6 s_7 s_5 s_4 s_3 s_2 s_1 s_8 s_6 s_5 s_4 s_3 s_2 s_7 s_5 s_4 s_3 s_6 s_5 s_4 s_8 s_6 s_5$
	8	$s_1 s_2 s_3 s_4 s_5 s_6 s_7 s_5 s_4 s_3 s_2 s_1 s_8 s_6 s_5 s_4 s_3 s_2 s_7 s_5 s_4 s_3 s_6 s_5 s_4 s_7 s_5 s_6$
F ₄	1	$s_1 s_2 s_3 s_2 s_4 s_3 s_2$
	2	$s_1 s_2 s_3 s_2 s_1 s_4 s_3$
G ₂	2	$s_2 s_1$

The notations \nearrow and \searrow mean that one has to interpolate by increasing and decreasing indices, respectively, with the obvious conventions understood, e. g., $s_1 \nearrow s_4 = s_1 s_2 s_3 s_4$ and also $s_1 \searrow s_1 = s_1$ and $s_1 \searrow s_0 = 1$ (empty index set).

Remark Note that if $s_{j_1} \dots s_{j_{g-2}} \alpha_i = \theta$, then for each $r = 1, \dots, g-2$,

$$\theta - \sum_{k=1}^r \frac{\|\theta\|^2}{\|\alpha_{j_k}\|^2} \alpha_{j_k}$$

is a positive root (and for $r = g-2$ equals α_i).

Surely, one can count the number of reduced decompositions, and one gets generalizations of binomial coefficients. We do not elaborate on this point here which seems to be known anyway.

Remark The lengths of the Weyl group elements that occurred in Proposition 4 have the following description. Let

$$q(t) := \sum_{\substack{\varphi \in \Phi^{(\text{long})} \\ \left\{ \begin{array}{l} w\varphi = \theta \text{ with} \\ \ell(w) \text{ minimal} \end{array} \right.}} t^{\ell(w)} = \sum_{\varphi \in \Phi_+^{(\text{long})}} t^{L(\varphi)}.$$

Since $s_i(\alpha_i) = -\alpha_i$, we have the corresponding sum

$$\sum_{\substack{\varphi \in \Phi^{(\text{long})} \\ \left\{ \begin{array}{l} w\varphi = \theta \text{ with} \\ \ell(w) \text{ minimal} \end{array} \right.}} t^{\ell(w)} = q(t) + t^{2g-3} q(t^{-1})$$

for all the (positive and negative) long roots, which is the Poincaré polynomial for the set of minimal coset representatives for $W_{\perp\theta} \backslash W$. The usual Poincaré polynomial $W(t)$ of W is $W(t) = \sum_{w \in W} t^{\ell(w)}$. It can be expressed by a product formula.

Namely, if m_1, \dots, m_l are the exponents³ of W (or of its type X), then using the abbreviation $[n] := (1 - t^n)/(1 - t)$ one can write $W(t) = \prod_{i=1}^l [m_i + 1]$.

The Poincaré polynomial of $W_{\perp\theta} \setminus W$ is the quotient $W(t)/W_{\perp\theta}(t)$ of the corresponding Poincaré polynomials. The rightmost column in the next table contains the numbers $\nu(X) =$ the number of positive long roots in a root system of type X . The Poincaré polynomial evaluated at $t = 1$ equals $2\nu(X)$.

X	$X_{\perp\theta}$	exponents of X	$W(t)/W_{\perp\theta}(t)$	$\nu(X)$
A_l	A_{l-2}	$1, 2, \dots, l$	$[l][l+1]$	$\frac{l(l+1)}{2}$
C_l	C_{l-1}	$1, 3, \dots, 2l-1$	$[2l]$	l
B_l	$B_{l-2} + A_1$	$1, 3, \dots, 2l-1$	$\frac{[2l-2][2l]}{[2]}$	$l(l-1)$
D_l	$D_{l-2} + A_1$	$1, 3, \dots, 2l-3, l-1$	$\frac{[l][2l-4][2l-2]}{[2][l-2]}$	$l(l-1)$
E_6	A_5	$1, 4, 5, 7, 8, 11$	$\frac{[8][9][12]}{[3][4]}$	36
E_7	D_6	$1, 5, 7, 9, 11, 13, 17$	$\frac{[12][14][18]}{[4][6]}$	63
E_8	E_7	$1, 7, 11, 13, 17, 19, 23, 29$	$\frac{[20][24][30]}{[6][10]}$	120
F_4	B_3	$1, 5, 7, 11$	$\frac{[8][12]}{[4]}$	12
G_2	A_1	$1, 5$	$[6]$	3

The usual conventions are employed for the entries in the column marked $X_{\perp\theta}$, namely, $A_{-1} = A_0 = B_0 = \emptyset$, $C_1 = B_1 = A_1$, $C_2 = B_2$, $D_2 = A_1 + A_1$.

Remark Putting $[n]_k := (1 - t^{kn})/(1 - t^k)$ one can write, e.g., $\frac{[8][9][12]}{[3][4]} = [2]_4[3]_3[12]_1 = [2]_4[9]_1[4]_3 = [8]_1[3]_3[3]_4$.

³A word about the labeling: the numbers m_1, \dots, m_l are not naturally associated to the nodes of the Coxeter-Dynkin graph.

In all cases, $W(t)/W_{\perp\theta}(t)$ is of the form $\frac{[a][c][e]}{[b][d]}$ (since $1 = [1]$). Of course, one can always take $e = h$.

Here is a little numerological table for the types D_4 , E_6 , E_7 , and E_8 .

X	$r := \frac{h}{6} = \frac{l+2}{10-l}$	$\frac{[a][c][e]}{[b][d]} = \frac{[4r][5r-1][6r]}{[r+1][2r]}$	group = $(r+1)2r$
D_4	1	$\frac{[4][4][6]}{[2][2]}$	Dih ₂ = $2 \cdot 2$
E_6	2	$\frac{[8][9][12]}{[3][4]}$	Alt ₄ = $3 \cdot 4$
E_7	3	$\frac{[12][14][18]}{[4][6]}$	Sym ₄ = $4 \cdot 6$
E_8	5	$\frac{[20][24][30]}{[6][10]}$	Alt ₅ = $6 \cdot 10$

One could extend the table above to the types A_1 and A_2 but without the entries for the last column. The six types A_1 , A_2 , D_4 , E_6 , E_7 , and E_8 are precisely the simply laced ones in Deligne's family (see [Del] and follow-up papers by various authors). Further numerology pertaining to the types E_6 , E_7 , E_8 can be found in the paper of Arnold [Arn] about trinities.

For $w \in W$ one defines $\Phi_w := \Phi_+ \cap w\Phi_-$, the set of positive roots which are of the form $w\varphi$ for a negative root φ . The following fundamental lemma is well-known.

Lemma 5 *For a Weyl group element $w \in W$ with reduced decomposition $w = s_{i_1} \dots s_{i_k}$ ($i_j \in \{1, \dots, l\}$) the set Φ_w consists of the k distinct positive roots*

$$\alpha_{i_1}, s_{i_1}(\alpha_{i_2}), s_{i_1}s_{i_2}(\alpha_{i_3}), \dots, s_{i_1} \dots s_{i_{k-1}}(\alpha_{i_k}).$$

Proof. Clearly $\Phi_1 = \emptyset$. Now one uses induction to show that $\Phi_{s_i w} = s_i\Phi_w \cup \{\alpha_i\}$ if $\ell(s_i w) = \ell(w) + 1$ ($\alpha_i \notin \Phi_w$) using the fact that s_i (for $i = 1, \dots, l$) permutes all positive roots other than α_i and $s_i(-\alpha_i) = \alpha_i$. \square

One can define $s(w) := \sum_{\varphi \in \Phi_w} \varphi$. The function $s : W \rightarrow \mathfrak{h}_{\mathbb{R}}^*$ satisfies the 1-cocycle condition $s(w w') = w s(w') + s(w)$, and in fact, $s(w) = \rho - w\rho$.

Lemma 6 $\ell(s_i w) = \ell(w) \pm 1 \iff w^{-1}\alpha_i \in \Phi_{\pm}$,
 $\ell(w s_i) = \ell(w) \pm 1 \iff w\alpha_i \in \Phi_{\pm}$.

Now we work in the affine Kac-Moody algebra context. For that we need the affine root system and its partition into the sets of positive and

negative roots. The so-called imaginary roots are fixed by \widehat{W} and play no role here. So we disregard them. Let $\widehat{\Phi}_+ := \Phi_+ \cup \{\varphi + n\delta \mid \varphi \in \Phi, n \in \mathbb{Z}_{>0}\}$ and $\widehat{\Phi}_- := -\widehat{\Phi}_+$. We further define for $\widehat{w} \in \widehat{W}$ the set $\widehat{\Phi}_{\widehat{w}} := \widehat{\Phi}_+ \cap \widehat{w}\widehat{\Phi}_-$ of cardinality $\ell(\widehat{w})$. The sum of the elements of $\widehat{\Phi}_{\widehat{w}}$ is $\widehat{\rho} - \widehat{w}\widehat{\rho}$ where $\widehat{\rho} = \rho + \frac{1}{2}\Lambda_0$. Similarly, one can extend Lemma 5 and Lemma 6 to the affine Kac-Moody algebra context.

One knows from Peterson's work that $\Psi = \Phi(\mathfrak{a})$ for an abelian ideal $\mathfrak{a} \trianglelefteq \mathfrak{b}$ if and only if the set $\{\delta - \varphi \mid \varphi \in \Psi\}$ is of the form $\widehat{\Phi}_{\widehat{w}}$. The affine point of view explains Kostant's theorem (Theorem 2). For instance if \mathfrak{a} is a k -dimensional abelian ideal in \mathfrak{b} with $\Psi := \Phi(\mathfrak{a}) = \{\varphi_1, \dots, \varphi_k\}$, then we have $\widehat{\Phi}_{\widehat{w}} = \{\delta - \varphi_1, \dots, \delta - \varphi_k\}$ for some $\widehat{w} \in \widehat{W}$. From

$$k\delta - \langle \Psi \rangle = (\delta - \varphi_1) + \dots + (\delta - \varphi_k) = \widehat{\rho} - \widehat{w}\widehat{\rho}$$

and since \widehat{w} is orthogonal, we get

$$\begin{aligned} 0 &= \|\widehat{w}\widehat{\rho}\|^2 - \|\widehat{\rho}\|^2 = \|\rho + \langle \Psi \rangle - k\delta + \frac{1}{2}\Lambda_0\|^2 - \|\rho + \frac{1}{2}\Lambda_0\|^2 \\ &= \|\rho + \langle \Psi \rangle\|^2 - k - \|\rho\|^2, \end{aligned}$$

so that in fact

$$\left\| \rho + \sum_{\varphi \in \Psi} \varphi \right\|^2 - \|\rho\|^2 = |\Psi|.$$

Theorem 7 *Let $\varphi \in \Phi_+^{(\text{long})}$ be a positive long root. Let $w \in W$ be the Weyl group element such that $w\varphi = \theta$ and with $\ell(w) = L(\varphi)$ as in Proposition 4. Then for all $\psi \in \Phi_w$, $\theta - \psi$ is a positive root and*

$$\mathfrak{a}^{\varphi, \min} := \mathfrak{g}_\theta \oplus \bigoplus_{\psi \in \Phi_w} \mathfrak{g}_{\theta - \psi}$$

is an abelian ideal of \mathfrak{b} . The ρ -point of the alcove corresponding to $\mathfrak{a}^{\varphi, \min}$ is $s_0 w \rho$.

Remark We shall see later that each nonzero abelian ideal $\mathfrak{a} \trianglelefteq \mathfrak{b}$ that satisfies $\mathfrak{a} = \mathfrak{a}^{\not\perp \theta}$ is of the form $\mathfrak{a} = \mathfrak{a}^{\varphi, \min}$ for a unique positive long root φ .

Proof. For the proof we use Kostant's criterion. First let us write w as a reduced decomposition $w = s_{i_{L(\varphi)}} \dots s_{i_1}$ as in the proof of Proposition 4.

Each root $\psi \in \Phi_w$ is of the form $\psi = s_{i_{L(\varphi)}} \dots s_{i_{q+1}}(\alpha_{i_q})$ and we compute

$$\begin{aligned} \frac{2(\psi|\theta)}{(\theta|\theta)} &= \frac{2}{(\theta|\theta)}(s_{i_{L(\varphi)}} \dots s_{i_{q+1}}(\alpha_{i_q}) \mid s_{i_{L(\varphi)}} \dots s_{i_1}\varphi) \\ &= \frac{2}{(\theta|\theta)}(\alpha_{i_q} \mid s_{i_q} \dots s_{i_1}\varphi) = \frac{2}{(\theta|\theta)}(-\alpha_{i_q} \mid s_{i_{q-1}} \dots s_{i_1}\varphi) \\ &= -\langle \alpha_{i_q}, (s_{i_{q-1}} \dots s_{i_1}\varphi)^\vee \rangle \\ &= L(s_{i_{q-1}} \dots s_{i_1}\varphi) - L(s_{i_q} \dots s_{i_1}\varphi) = 1. \end{aligned}$$

Hence we have $s_\theta(\psi) = \psi - \theta$ and $\theta - \psi$ is a positive root. Now we put $\ell := \ell(w) = L(\varphi)$ for abbreviation, so that $|\Phi_w| = \ell$. We check that the $\ell + 1$ element set $\Psi := \{\theta\} \cup \{\theta - \psi \mid \psi \in \Phi_w\} \subseteq \Phi_+$ satisfies Kostant's criterion (Theorem 2) for an abelian ideal. Using $\sum_{\psi \in \Phi_w} \psi = \rho - w\rho$ we have

$$\begin{aligned} \rho + \theta + \sum_{\psi \in \Phi_w} (\theta - \psi) &= w\rho + (\ell + 1)\theta = w\rho + (L(\varphi) + 1)\theta \\ &= w\rho + (g - \langle \rho, \varphi^\vee \rangle)\theta \\ &= w\rho + (g - \langle w\rho, (w\varphi)^\vee \rangle)\theta \end{aligned}$$

and because $w\varphi = \theta$ we get

$$= w\rho - \langle w\rho, \theta^\vee \rangle\theta + g\theta = s_0 w\rho.$$

This proves the assertion about the ρ -point. Now we compute

$$\begin{aligned} \|s_0 w\rho\|^2 - \|\rho\|^2 &= \|(\ell + 1)\theta + w\rho\|^2 - \|\rho\|^2 \\ &= (\ell + 1)^2 \|\theta\|^2 + (\ell + 1) 2(\theta|w\rho) \end{aligned}$$

and with $\ell \|\theta\|^2 = 2(\theta - \varphi|\rho)$ and $w^{-1}\theta = \varphi$ the calculation continues

$$\begin{aligned} &= (\ell + 1)(2(\theta - \varphi|\rho) + \|\theta\|^2 + 2(\varphi|\rho)) \\ &= (\ell + 1)(\|\rho + \theta\|^2 - \|\rho\|^2) = \ell + 1. \end{aligned}$$

This completes the proof of the theorem. \square

Remark As the notation $\mathfrak{a}^{\varphi, \min}$ suggests there will also be abelian ideals $\mathfrak{a}^{\varphi, \max}$. In fact, each nonzero abelian ideal \mathfrak{a} satisfies $\mathfrak{a}^{\varphi, \min} \subseteq \mathfrak{a} \subseteq \mathfrak{a}^{\varphi, \max}$ for some positive long root φ which is characterized by $\mathfrak{a}^{\perp \theta} = \mathfrak{a}^{\varphi, \min}$. If φ is not perpendicular to the highest root θ , then $\mathfrak{a}^{\varphi, \max} = \mathfrak{a}^{\varphi, \min}$.

Let us now look closer at the case where $\varphi \perp \theta$. Before giving the general picture, we state a preliminary result.

Proposition 8 *Let $\varphi \in \Phi_+^{(\text{long})}$ and $w \in W$ be as in Theorem 7 and suppose in addition that φ is perpendicular to the highest root θ . Then*

$$\mathfrak{a}^{\varphi, \min^+} := \mathfrak{a}^{\varphi, \min} \oplus \mathfrak{g}_{w\theta}$$

is an abelian ideal of \mathfrak{b} .

Proof. We first show that $w\theta$ is a positive root perpendicular to θ . In fact, $(w\theta|\theta) = (w\theta|w\varphi) = (\theta|\varphi) = 0$. Hence $w\theta$ is a long root spanned by the simple roots α_i that are perpendicular to θ . (To make this assertion clear, let us write $w\theta = \sum_{i=1}^l a_i \alpha_i$. Here the coefficients a_i are either all nonnegative or all nonpositive. Now we take the inner product with θ and use $(\alpha_i|\theta) \geq 0$ because θ lies in the dominant chamber and α_i is a positive root.) For each such root $\alpha_i \perp \theta$ we have $s_i w\varphi = s_i \theta = \theta$. Hence $\ell(s_i w) \geq \ell(w)$ by the minimality of $\ell(w)$. Lemma 6 shows that $w^{-1}\alpha_i \in \Phi_+$. Since θ lies in the dominant chamber, we get $0 \leq (w^{-1}\alpha_i|\theta) = (\alpha_i|w\theta)$ for all simple roots $\alpha_i \perp \theta$. This means that $w\theta$ lies in the dominant chamber for the root subsystem $\Phi_{\perp\theta}$ (spanned by the simple roots $\alpha_i \perp \theta$). One can then see that $w\theta$ is in fact the highest root of the φ -component of $\Phi_{\perp\theta}$.

Putting again $\ell := \ell(w)$ we define the set Ψ of cardinality $\ell + 2$ as $\Psi := \{\theta\} \cup \{\theta - \psi | \psi \in \Phi_w\} \cup \{w\theta\} \subseteq \Phi_+$. ($w\theta$ is of course different from the elements $\theta - \psi$ because only $w\theta$ is perpendicular to θ .) Now we employ Kostant's criterion as in the proof of Theorem 7. Looking back at that proof we see that we must show that

$$\|(\ell + 1)\theta + w\rho + w\theta\|^2 - \|(\ell + 1)\theta + w\rho\|^2 = 1.$$

This follows from $\theta \perp w\theta$ and the W -invariance of the inner product together with the identity $\|\rho + \theta\|^2 - \|\rho\|^2 = 1$. \square

Minimal coset representatives and Poincaré polynomials

In this section we define for each positive root $\varphi \in \Phi_+$ the polynomial $P_\varphi(t) \in \mathbb{Z}_{\geq 0}[t]$ by setting

$$P_\varphi(t) := \frac{\widehat{W}_{\perp\varphi}(t)}{W_{\perp\varphi}(t)}.$$

Here $\widehat{W}_{\perp\varphi}$ is the standard parabolic subgroup of the affine Weyl group \widehat{W} generated by those reflections s_i ($i = 0, \dots, l$) for which $\alpha_i \perp \varphi$ (here $\alpha_0 = -\theta$). Note that $\widehat{W}_{\perp\varphi}$ is a finite Coxeter group. Similarly, $W_{\perp\varphi}$ is the standard

parabolic subgroup of the finite Weyl group W generated by those simple reflections s_i ($i = 1, \dots, l$) for which $\alpha_i \perp \varphi$. In particular, $\widehat{W}_{\perp\varphi} = W_{\perp\varphi}$ if $\varphi \not\perp \theta$. The expressions $\widehat{W}_{\perp\varphi}(t)$ and $W_{\perp\varphi}(t)$ stand for the Poincaré polynomials of the Coxeter groups in question, and the quotient $\frac{\widehat{W}_{\perp\varphi}(t)}{W_{\perp\varphi}(t)}$ is the Poincaré polynomial for the set of minimal coset representatives in $W_{\perp\varphi} \setminus \widehat{W}_{\perp\varphi}$.

Let \widehat{w}_φ be the longest element of $\widehat{W}_{\perp\varphi}$ and w_φ the longest element of $W_{\perp\varphi}$. The set of minimal coset representatives in $W_{\perp\varphi} \setminus \widehat{W}_{\perp\varphi}$ is the interval $[1, w_\varphi \widehat{w}_\varphi]$ in the Bruhat-Chevalley order (note that $(w_\varphi)^2 = 1$ and also $(\widehat{w}_\varphi)^2 = 1$). In particular, the longest element in $[1, w_\varphi \widehat{w}_\varphi]$ has length $\ell(w_\varphi \widehat{w}_\varphi) = \ell(\widehat{w}_\varphi) - \ell(w_\varphi)$.

In the following long table we show the polynomials $P_\alpha(t)$ for all simple roots $\alpha \in \Pi$. The polynomials $P_\varphi(t)$ can be extracted from this piece of information. This is clear for simple types different from A_l because then the affine vertex of the Coxeter-Dynkin graph is a leaf in a tree and hence $P_\varphi(t) = P_\alpha(t)$ for an appropriate simple root $\alpha \in \Pi$. For type A_l we can reduce to the case of a simple root by looking at A_k for appropriate k , namely, $P_{\alpha_i + \dots + \alpha_{i+j}}^{A_l}(t) = P_{\alpha_i}^{A_{l-j}}(t)$.

Definition For a nonnegative integer n let us recall the definition of the polynomial

$$[n] := \frac{1 - t^n}{1 - t} \in \mathbb{Z}_{\geq 0}[t].$$

Moreover, we define the factorials

$$[n]! := \prod_{i=1}^n [i]$$

and their relatives

$$[2n]!! := \prod_{i=1}^n [2i] \quad \text{and} \quad [2n+1]!! := \prod_{i=0}^n [2i+1].$$

Of course, $[0]! = [0]!! = 1$.

The following table shows the polynomials $P_{\alpha_i}(t) = \widehat{W}_{\perp\alpha_i}(t)/W_{\perp\alpha_i}(t)$ and the minimal coset representatives for $W_{\perp\alpha_i} \setminus \widehat{W}_{\perp\alpha_i}$ (the latter for the classical series in the rank 5 case). Above or beneath each node marked by the simple reflection s_i we have depicted along with the polynomial $P_{\alpha_i}(t)$ the Hasse graph of the Bruhat-Chevalley poset of $W_{\perp\alpha_i} \setminus \widehat{W}_{\perp\alpha_i}$. To read a minimal coset representative we have to start at the lower node and read upwards along the edges. E. g., the minimal coset representatives for $W_{\perp\alpha_3} \setminus \widehat{W}_{\perp\alpha_3}$ for type A_5 are $1, s_0, s_0 s_1, s_0 s_5, s_0 s_1 s_5 = s_0 s_5 s_1, s_0 s_1 s_5 s_0 = s_0 s_5 s_1 s_0$.

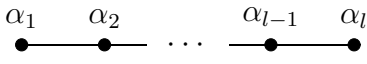
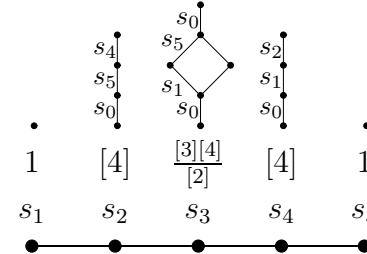
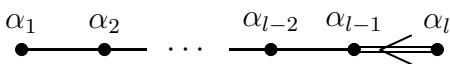
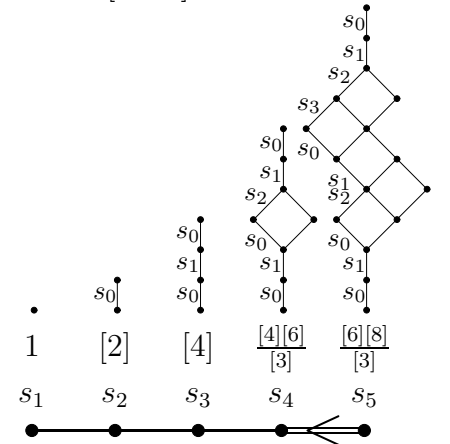
A_l	 $P_{\alpha_i}(t) = \frac{[l-1]!}{[i-1]![l-i]!} \quad (i = 1, \dots, l)$
A_5	
C_l	 $P_{\alpha_i}(t) = \frac{[2i-2]!!}{[i-1]!} \quad (i = 1, \dots, l)$
C_5	

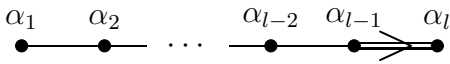
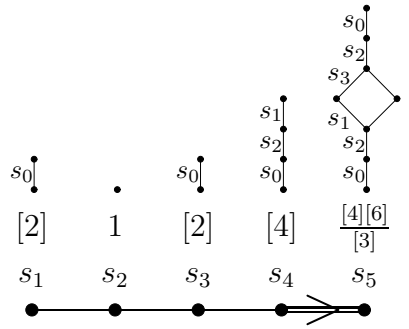
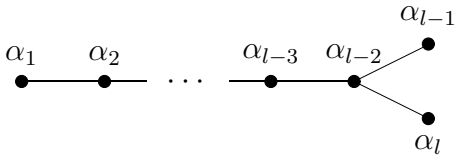
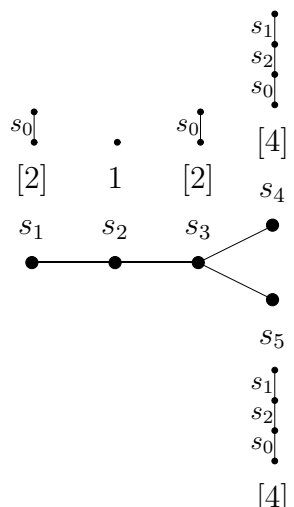
B_l	 $P_{\alpha_1}(t) = [2]$ $P_{\alpha_i}(t) = \frac{[2i-4]!!}{[i-2]!} \quad (i = 2, \dots, l)$
B_5	 $[2] \quad 1 \quad [2] \quad [4] \quad \frac{[4][6]}{[3]}$
D_l	 $P_{\alpha_1}(t) = [2]$ $P_{\alpha_i}(t) = \frac{[2i-4]!!}{[i-2]!} \quad (i = 2, \dots, l-1)$ $P_{\alpha_l}(t) = P_{\alpha_{l-1}}(t)$
D_5	 $[2] \quad 1 \quad [2] \quad [4] \quad [4]$

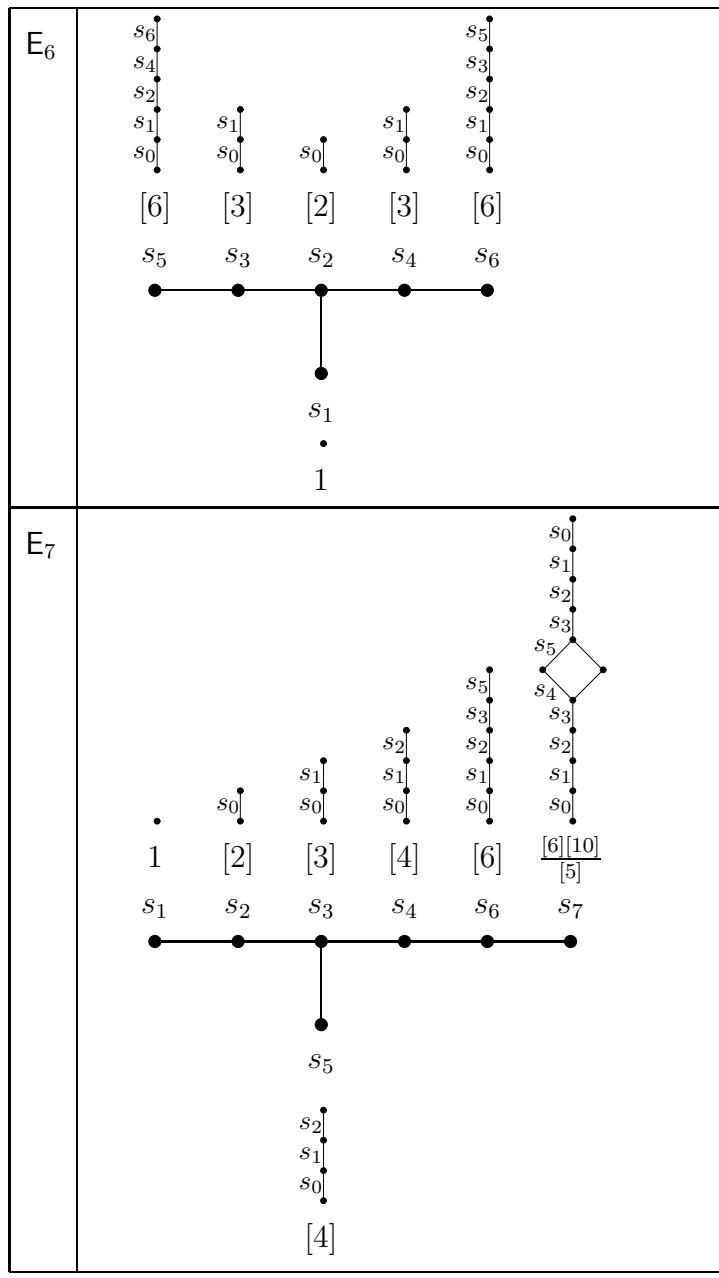

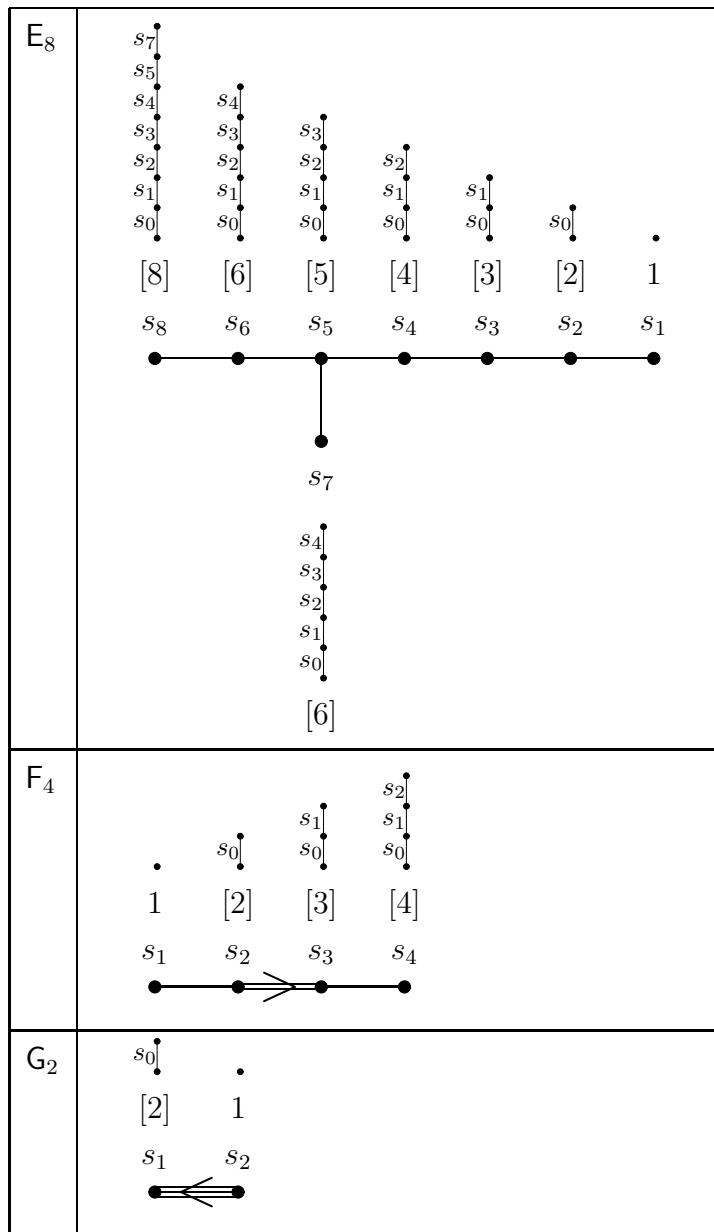

Lemma 9 Let $\widehat{w} \in \widehat{W}_{\perp\varphi}$ be a minimal coset representative for a coset in $W_{\perp\varphi} \setminus \widehat{W}_{\perp\varphi}$. Then $\widehat{w}\rho$ lies in the dominant chamber.

Proof. We have $\ell(s_i\widehat{w}) > \ell(\widehat{w})$ for all $i = 1, \dots, l$, namely, for those i for which $\alpha_i \perp \varphi$ by the minimality of \widehat{w} , and for the remaining i because $s_i \notin \widehat{W}_{\perp\varphi}$. Hence \widehat{w} is a minimal coset representative for a coset in $W \setminus \widehat{W}$. The assertion $\widehat{w}\rho \in C$ is now clear. (Since C is a fundamental domain for W , there is a unique $w \in W$ and a (minimal) gallery from the fundamental alcove A to

$w\widehat{w}A$ which stays inside the dominant chamber C and so does not cross any of the hyperplanes H_1, \dots, H_l . By the minimality of \widehat{w} we get $w = 1$, i. e., $\widehat{w}A \subseteq C$, or equivalently, $\widehat{w}\rho \in C$. \square

The next lemma generalizes the orthogonality statement $w\theta \perp \theta$ in the proof of Proposition 8, which corresponds to $\widehat{w} = s_0$ and requires $\varphi \perp \theta$ in Lemma 10.

Lemma 10 *Let $\varphi \in \Phi_+^{(\text{long})}$. Let $w \in W$ be such that $w\varphi = \theta$ and let $\widehat{w} \in \widehat{W}_{\perp\varphi}$. Then $s_0w\widehat{w}\rho - s_0w\rho$ is perpendicular to the highest root θ .*

Proof. We compute (recall that s_θ is the linear part of s_0)

$$\begin{aligned} (s_0w\widehat{w}\rho - s_0w\rho \mid \theta) &= (s_\theta(w\widehat{w}\rho - w\rho) \mid \theta) \\ &= (w(\widehat{w}\rho - \rho) \mid -\theta) = (\widehat{w}\rho - \rho \mid -\varphi). \end{aligned}$$

It remains to show that $(\widehat{w}\rho - \rho \mid -\varphi) = 0$. Now $\widehat{W}_{\perp\varphi}$ is generated by those reflections s_i for which $\alpha_i \perp \varphi$ (here $\alpha_0 = -\theta$), and hence we have $s_i(\lambda + \varphi^\perp) \subseteq \lambda + \varphi^\perp$ for all $\lambda \in \mathfrak{h}_{\mathbb{R}}^*$. In particular, it follows that $\widehat{w}\rho \in \rho + \varphi^\perp$ so that $(\widehat{w}\rho - \rho \mid -\varphi) = 0$. \square

Remark The following computation suggests the existence of some “shell-like structure”. In the classical A_l case it means that every Young diagram decomposes into a set of hooks that are stacked together.

$$\begin{aligned} &\|s_0w\widehat{w}\rho\|^2 - \|s_0w\rho\|^2 \\ &= \|s_0w\widehat{w}\rho - s_0w\rho\|^2 + 2 \underbrace{(s_0w\widehat{w}\rho - s_0w\rho \mid s_0w\rho)}_{\perp \theta \text{ (by Lemma 10)}} \\ &= \|s_\theta w(\widehat{w}\rho - \rho)\|^2 + 2 \underbrace{(s_\theta w(\widehat{w}\rho - \rho) \mid s_\theta w\rho + g\theta)}_{\perp \theta} \\ &= \|\widehat{w}\rho - \rho\|^2 + 2(\widehat{w}\rho - \rho \mid \rho) = \|\widehat{w}\rho\|^2 - \|\rho\|^2. \end{aligned}$$

Here is the main theorem of this paper.

Theorem 11 *Let $\varphi \in \Phi_+^{(\text{long})}$ be a positive long root and $\widehat{w} \in \widehat{W}_{\perp\varphi}$ be the minimal coset representative for a coset in $W_{\perp\varphi} \backslash \widehat{W}_{\perp\varphi}$. To the pair (φ, \widehat{w}) we associate the ρ -point $s_0w\widehat{w}\rho$ where $w \in W$ is the Weyl group element such that $w\varphi = \theta$ and with $\ell(w) = L(\varphi)$ as in Proposition 4. Then $s_0w\widehat{w}\rho \in 2A - A$ and hence $s_0w\widehat{w}\rho$ is the ρ -point of an alcove that corresponds to a nonzero abelian ideal $\mathfrak{a}^{\varphi, \widehat{w}} \trianglelefteq \mathfrak{b}$. Moreover, each nonzero abelian ideal occurs in this way.*

Hence we have the parametrization we looked for

$$\{\mathfrak{a} \mid 0 \neq \mathfrak{a} \trianglelefteq \mathfrak{b}, \mathfrak{a} \text{ abelian}\} \xleftrightarrow{1:1} \coprod_{\varphi \in \Phi_+^{(\text{long})}} W_{\perp\varphi} \backslash \widehat{W}_{\perp\varphi}$$

where the right coset $W_{\perp\varphi}\widehat{w}$ in the component for φ on the right hand side with $\widehat{w} \in \widehat{W}_{\perp\varphi}$ its minimal coset representative corresponds to the abelian ideal $\mathfrak{a}^{\varphi, \widehat{w}}$.

Remark The abelian ideals $\mathfrak{a}^{\varphi, \min}$, $\mathfrak{a}^{\varphi, \min^+}$ if $\varphi \perp \theta$, and $\mathfrak{a}^{\varphi, \max}$ that were mentioned earlier have the following descriptions.

$$\begin{aligned} \mathfrak{a}^{\varphi, \min} &= \mathfrak{a}^{\varphi, 1} \\ \mathfrak{a}^{\varphi, \min^+} &= \mathfrak{a}^{\varphi, s_0} \text{ if } \varphi \perp \theta \\ \mathfrak{a}^{\varphi, \max} &= \mathfrak{a}^{\varphi, w \circ \widehat{w} \circ \varphi} \end{aligned}$$

Proof. Since $s_0 w \widehat{w} \neq 1$ —in fact, $\ell(s_0 w \widehat{w}) = 1 + \ell(w) + \ell(\widehat{w})$ —we must show that $s_0 w \widehat{w} \rho \in 2A$. Recall that

$$2A = \{\lambda \in \mathfrak{h}_{\mathbb{R}}^* \mid (\lambda | \alpha_i) \geq 0 \ (i = 1, \dots, l) \text{ and } (\lambda | \theta) \leq 1\}.$$

Let us first show that $(s_0 w \widehat{w} \rho | \theta) \leq 1$. For that we compute

$$\begin{aligned} (s_0 w \widehat{w} \rho | \theta) &= \underbrace{(s_0 w \widehat{w} \rho - s_0 w \rho | \theta)}_{= 0 \text{ (by Lemma 10)}} + (s_0 w \rho | \theta) \\ &= (s_{\theta} w \rho + g\theta | \theta) = 1 - (w \rho | \theta) = 1 - (\rho | \varphi) \leq 1 \end{aligned}$$

because ρ lies in the dominant chamber and φ is a positive root.

Next, for a simple root α_i with $\alpha_i \perp \theta$ we have $\ell(s_i w) = \ell(w) + 1$ by the minimality of $\ell(w)$ because $s_i w \varphi = s_i \theta = \theta$. Hence $w^{-1} \alpha_i \in \Phi_+$ by Lemma 6. Now we compute

$$\begin{aligned} (s_0 w \widehat{w} \rho | \alpha_i) &= (s_{\theta} w \widehat{w} \rho + g\theta | \alpha_i) = (w \widehat{w} \rho | s_{\theta} \alpha_i) + g(\theta | \alpha_i) \\ &= (w \widehat{w} \rho | \alpha_i) = (\widehat{w} \rho | w^{-1} \alpha_i) \geq 0 \end{aligned}$$

because $\widehat{w} \rho$ lies in the dominant chamber (by Lemma 9) and $w^{-1} \alpha_i$ is a positive root.

Lastly, we have to deal with the simple roots that are not perpendicular to the highest root. In most cases there is only one such root. The details will appear in the final version of this paper.

Finally, we must show that our construction is exhaustive. It would be nice to have a geometric argument for that. This would then prove the First Sum Formula (Theorem 12) stated below. Momentarily the situation is different. We prove the First Sum Formula directly and thereby see that our construction yields all the $2^l - 1$ nonzero abelian ideals. \square

Theorem 12 (First Sum Formula)

$$\sum_{\varphi \in \Phi_+^{(\text{long})}} P_\varphi(1) = 2^l - 1.$$

Proof. As mentioned above, the proof of the First Sum Formula is the last step in proving Theorem 11. We provide a case by case proof.

Let $S := \sum_{\varphi \in \Phi_+^{(\text{long})}} P_\varphi(1)$.

$\boxed{\text{A}_l}$ Using $P_{\alpha_i + \dots + \alpha_{i+j}}(1) = \frac{(l-j-1)!}{(i-1)!(l-j-i)!}$ ($i = 1, \dots, l, j = 0, \dots, l-i$) we get

$$S = \sum_{i=1}^l \sum_{j=0}^{l-i} P_{\alpha_i + \dots + \alpha_{i+j}}(1) = \sum_{i=1}^l \sum_{j=0}^{l-i} \frac{(l-j-1)!}{(i-1)!(l-j-i)!} = 2^l - 1.$$

For the other simple types the affine Coxeter-Dynkin graph has a tree as its underlying simple graph. Each root φ is of the form $\varphi = \sum_{i=1}^l a_i \alpha_i$ and has support $\text{supp } \varphi := \{\alpha_i \mid a_i \neq 0\}$. Let $\text{pr}(\varphi) \in \text{supp } \varphi$ be the simple root which is nearest to α_0 when considered as nodes in the affine Coxeter-Dynkin tree. It is clear that $P_\varphi(t) = P_{\text{pr}(\varphi)}(t)$. For $i = 1, \dots, l$ let r_i be the number of positive long roots φ for which $\text{pr}(\varphi) = \alpha_i$. The sum S can now be rewritten as $S = \sum_{i=1}^l r_i P_{\alpha_i}(1)$. The numbers r_i can be expressed via the numbers $\nu(\mathbf{X}) =$ the number of positive long roots of a root system of type \mathbf{X} as in the table on page 14.

$\boxed{\text{C}_l}$ $r_i = 1$ ($i = 1, \dots, l$)

$$S = \sum_{i=1}^l 2^{i-1} = 2^l - 1$$

$\boxed{\text{B}_l}$ $r_1 = \nu(\mathbf{A}_1) = 1$

$$r_2 = \nu(\mathbf{B}_l) - \nu(\mathbf{B}_{l-2}) - \nu(\mathbf{A}_1) = 4l - 7$$

$$r_i = \nu(\mathbf{B}_{l-i+1}) - \nu(\mathbf{B}_{l-i}) = 2l - 2i \quad (i = 3, \dots, l-2)$$

$$r_{l-1} = \nu(\mathbf{B}_2) = 2 \quad (\text{for } l \geq 4)$$

$$r_l = 0$$

$$S = 1 \cdot 2 + (4l - 7) \cdot 1 + \sum_{i=3}^{l-1} (2l - 2i) \cdot 2^{i-2} + 0 \cdot 2^{l-2} = 2^l - 1$$

$$\boxed{D_l} \quad r_1 = \nu(A_1) = 1$$

$$r_2 = \nu(D_l) - \nu(D_{l-2}) - \nu(A_1) = 4l - 7$$

$$r_i = \nu(D_{l-i+1}) - \nu(D_{l-i}) = 2l - 2i \quad (i = 3, \dots, l-3)$$

$$r_{l-2} = \nu(A_3) - 2\nu(A_1) = 4 \quad (\text{for } l \geq 5)$$

$$r_{l-1} = r_l = \nu(A_1) = 1$$

$$\begin{aligned} S &= 1 \cdot 2 + (4l - 7) \cdot 1 + \sum_{i=3}^{l-2} (2l - 2i) \cdot 2^{i-2} + 1 \cdot 2^{l-3} + 1 \cdot 2^{l-3} \\ &= 2^l - 1 \end{aligned}$$

For the exceptional types we write the numbers r_i directly near the corresponding node in the Coxeter-Dynkin graph. It is clear how to compute them, e. g., for E_6 , $r_1 = \nu(E_6) - \nu(A_5)$, $r_2 = \nu(A_5) - 2\nu(A_2)$, and so on.

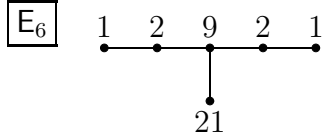

$$S = 21 \cdot 1 + 9 \cdot 2 + 2 \cdot 3 + 2 \cdot 3 + 1 \cdot 6 + 1 \cdot 6 = 2^6 - 1$$

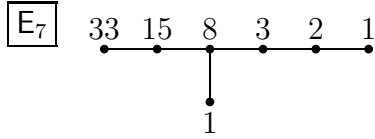

$$S = 33 \cdot 1 + 15 \cdot 2 + 8 \cdot 3 + 3 \cdot 4 + 1 \cdot 4 + 2 \cdot 6 + 1 \cdot 12 = 2^7 - 1$$

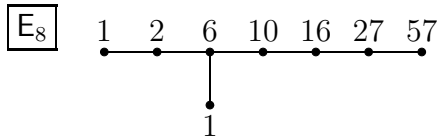

$$\begin{aligned} S &= 57 \cdot 1 + 27 \cdot 2 + 16 \cdot 3 + 10 \cdot 4 + 6 \cdot 5 + 2 \cdot 6 + 1 \cdot 6 + 1 \cdot 8 \\ &= 2^8 - 1 \end{aligned}$$

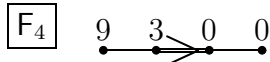

$$S = 9 \cdot 1 + 3 \cdot 2 + 0 \cdot 3 + 0 \cdot 4 = 2^4 - 1$$

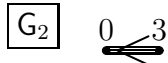

$$S = 3 \cdot 1 + 0 \cdot 2 = 2^2 - 1$$

□

Among the maximal abelian ideals—we shall look at them more closely in the next section—are those whose dimension is maximal. A. Malcev [Mal] calculated the dimension for each type. Our approach allows to express these dimensions in a uniform way as $g - 1 + N' - N''$ where g is the dual Coxeter number of \mathfrak{g} and N', N'' are the numbers of positive roots of certain root subsystems.

Corollary 13 *The maximal dimension of an abelian ideal in \mathfrak{b} can be expressed as $g - 1 + \widehat{N}_{\perp\alpha} - N_{\perp\alpha}$ where $\alpha \in \Pi^{(\text{long})}$ is a long simple root such that the difference $\widehat{N}_{\perp\alpha} - N_{\perp\alpha}$ is maximal. Here $\widehat{N}_{\perp\alpha} = \ell(\widehat{w}_{\circ}^{\alpha})$ is the length of the longest element $\widehat{w}_{\circ}^{\alpha} \in \widehat{W}_{\perp\alpha}$, or, equivalently, the number of positive roots of a root system of type $\widehat{X}_{\perp\alpha}$. Analogously, we have $N_{\perp\alpha} = \ell(w_{\circ}^{\alpha})$ for $w_{\circ}^{\alpha} \in W_{\perp\alpha}$ its longest element.*

Abelian ideals of maximal dimension

The fourth column in the table shows the Coxeter-Dynkin graph CD_X of type X and the affine Coxeter-Dynkin graph $CD_{\hat{X}}$ with the node α_0 encircled.

X	$g_X - 1$	N_X	CD_X $CD_{\hat{X}}$ α	$\hat{X}_{\perp\alpha}$	$X_{\perp\alpha}$	max dim
A_1	1	1		\emptyset	\emptyset	1
A_2	2	3		\emptyset	\emptyset	2
A_l $l \geq 3$ l odd	l	$\frac{l(l+1)}{2}$		A_{l-2}	$A_{\frac{l-3}{2}} + A_{\frac{l-3}{2}}$	$\frac{(l+1)^2}{4}$
A_l $l \geq 4$ l even	l	$\frac{l(l+1)}{2}$		A_{l-2}	$A_{\frac{l-2}{2}} + A_{\frac{l-2}{2}}$	$\frac{l^2 + 2l}{4}$
C_l $l \geq 2$	l	l^2		C_{l-1}	A_{l-2}	$\frac{l^2 + l}{2}$
B_3	4	9		$A_1 + A_1$	A_1	5
B_l $l \geq 4$	$2l - 2$	l^2		D_{l-2}	A_{l-3}	$\frac{l^2 - l + 2}{2}$
D_l $l \geq 4$	$2l - 3$	$l(l - 1)$		$D_{l-2} + A_1$	$A_{l-3} + A_1$	$\frac{l^2 - l}{2}$
E_6	11	36		A_5	A_4	16
E_7	17	63		D_6	D_5	27
E_8	29	120		A_7	A_6	36
F_4	8	24		$A_1 + A_1$	A_1	9
G_2	3	6		\emptyset	\emptyset	3

The usual conventions apply, namely, $A_0 = \emptyset$, $C_1 = A_1$, $B_2 = C_2$, $D_2 = A_1 + A_1$.

Remark In the previous table, in some cases there are several possibilities for the simple long root α that yields an abelian ideal of maximal dimension. By inspection we see that the number of abelian ideals in \mathfrak{b} of maximal dimension is

3 for type D_4 ,

2 for types A_l (l even), D_l ($l > 4$), and E_6 , and

1 for the other types.

Remark Instead of taking $\widehat{X}_{\perp\alpha}$ and $X_{\perp\alpha}$ one could already delete the common components (nonvoid for the types B_3 , D_l , and F_4).

Remark As already mentioned the numbers in the rightmost column of the table above were first computed case by case by A. Malcev [Mal]. In the recent paper [Boe] B. Boe computed, again case by case, the maximal length $\ell(\widehat{w})$ of an affine Weyl group element \widehat{w} such that $\widehat{w}A \subseteq (k+1)A$; see [Boe, Table 1] but with the types C_l and B_l interchanged because there the highest *short* root is used to define the tessellation by alcoves. Neither Boe's paper nor its review paper [Sri] mentions the connexion with Malcev's result about abelian ideals.

4 Maximal abelian ideals

We are now interested in the maximal abelian ideals in \mathfrak{b} . It has been observed in [PR] that the number of maximal abelian ideals in a fixed Borel subalgebra of \mathfrak{g} equals the number of long simple roots. A canonical one-to-one correspondence was exhibited between the two sets. However, the proof was based on a case by case consideration and was therefore rather unsatisfactory. Here we will give a geometric approach which makes the whole picture very transparent.

We know that each abelian ideal $\mathfrak{a} \trianglelefteq \mathfrak{b}$ corresponds to an alcove $\widehat{w}A \subseteq 2A$. If $\widehat{w}A$ has no facet⁴ lying in the wall $2H_0$, then \mathfrak{a} cannot be a maximal ideal. Hence each maximal abelian ideal has an alcove with one facet lying in the wall $2H_0$. It is convenient to have some terminology which describes this geometric situation.

⁴We follow the traditional terminology which speaks of "facets" for "faces of codimension one". This disagrees with the English translation of the Bourbaki volume [Bou]. As far as I understand and remembering A. Borel's course (taught in German) about Tits buildings many years ago, the terminology in French is "face" for "facette de codimension une".

Definition An **upper alcove** $\widehat{w}A$ is an alcove in $2A$ such that one facet of $\widehat{w}A$ lies in the wall $2H_0$. For an upper alcove $\widehat{w}A$ the **lower vertex** is the vertex that sticks out, i. e., does not lie in the wall $2H_0$.

Let us look at some examples. For type A_2 there are two upper alcoves, namely, those with ρ -points $s_0s_2\rho$ and $s_0s_1\rho$. Both belong to maximal abelian ideals, namely, $\mathfrak{a}^{\alpha_1,1}$ and $\mathfrak{a}^{\alpha_2,1}$. For the former alcove, the lower vertex has type 1 and for the latter type 2. For type C_2 there are again two upper alcoves, with ρ -points $s_0s_1\rho$ (ideal $\mathfrak{a}^{\alpha_2,1}$) and $s_0s_1s_0\rho$ (ideal $\mathfrak{a}^{\alpha_2,s_0}$), both with the same lower vertex of type 2. Only the latter belongs to the maximal abelian ideal. For type G_2 (see the picture on page 9) there is only one upper alcove, with ρ -point $s_0s_2s_1\rho$ and lower vertex of type 2.

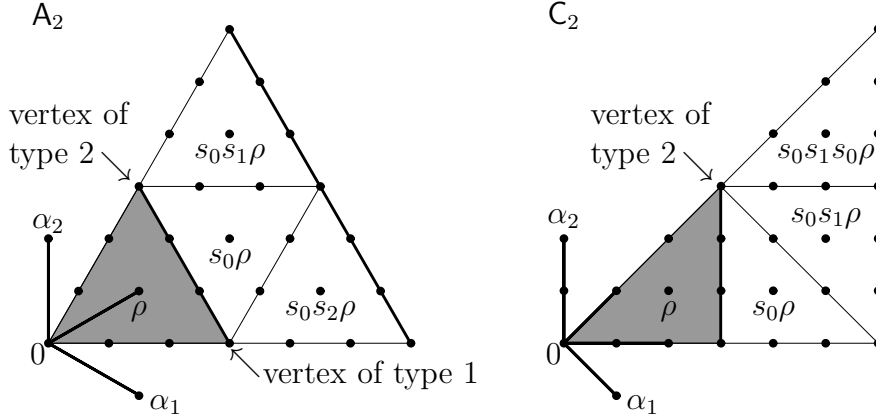

From previous results we already know that the lower vertices are in one-to-one correspondence with the long simple roots.

Another way for proving that each lower vertex has the type of a long simple root can be deduced from the following proposition which we also use for our Second Sum Formula (Theorem 15).

Proposition 14 $\text{vol}_{l-1}(F_0) : \dots : \text{vol}_{l-1}(F_l) = \|\alpha_0\| n_0 : \dots : \|\alpha_l\| n_l$.

Proof. Recall that the vertices of the fundamental alcove A with facets F_0, \dots, F_l are $0, \frac{\varpi_1}{n_1}, \dots, \frac{\varpi_l}{n_l}$. We compute the volume of an alcove in two different ways.

The volume of the pyramid A over F_0 with apex 0 is $\frac{1}{l}$ times $\text{vol}_{l-1}(F_0)$ times the distance of the apex 0 from the hyperplane H_0 supporting the face F_0 . This distance is $\frac{1}{2\|\theta\|}$ because $\frac{\theta}{2\|\theta\|^2} = \frac{1}{2}g\theta \in H_0$ is the orthogonal projection of the apex 0 to H_0 . On the other hand, the volume of A is $\frac{1}{l!}$ times the volume $D = \left| \frac{\varpi_1}{n_1} \wedge \dots \wedge \frac{\varpi_l}{n_l} \right|$ of the parallelepiped spanned by the vectors $\frac{\varpi_i}{n_i}$ ($i = 1, \dots, l$). Hence $\text{vol}_{l-1}(F_0) = 2\|\theta\| \frac{D}{(l-1)!} = 2\|\alpha_0\| n_0 \frac{D}{(l-1)!}$.

Now we compute the $(l-1)$ -dimensional volume of an $(l-1)$ -simplex F_i ($i = 1, \dots, l$) as the l -dimensional volume of the prism $F_i \times I$ where I is a unit interval perpendicular to F_i . Hence

$$\begin{aligned} \text{vol}_{l-1}(F_i) &= \frac{1}{(l-1)!} \left| \frac{\varpi_1}{n_1} \wedge \dots \wedge \frac{\varpi_{i-1}}{n_{i-1}} \wedge \frac{\alpha_i}{\|\alpha_i\|} \wedge \frac{\varpi_{i+1}}{n_{i+1}} \wedge \dots \wedge \frac{\varpi_l}{n_l} \right| \\ &= 2 \|\alpha_i\| n_i \frac{D}{(l-1)!} \end{aligned}$$

because $\alpha_i = 2 \sum_{k=1}^l (\alpha_i \mid \varpi_k) \alpha_k = 2 \sum_{k=1}^l (\alpha_i \mid \alpha_k) \varpi_k$.

This proves the proposition. \square

Remark The two formulae

$$\text{vol}_l(A) = \frac{1}{l} \cdot \text{vol}_{l-1}(F_0) \cdot \frac{1}{2\|\theta\|}$$

and

$$\begin{aligned} \text{vol}_l(A) &= \sum_{i=0}^l \text{vol}_l(\text{pyramid with base } F_i \text{ and apex } \rho) \\ &= \frac{1}{l} \cdot \sum_{i=0}^l \text{dist}(\rho, F_i) \cdot \text{vol}_{l-1}(F_i) \\ &= \frac{1}{l} \cdot \sum_{i=0}^l \frac{1}{2} \|\alpha_i\| \cdot \frac{n_i \|\alpha_i\|}{n_0 \|\alpha_0\|} \cdot \text{vol}_{l-1}(F_0) \\ &= \frac{1}{l} \cdot \frac{1}{2\|\theta\|} \cdot \text{vol}_{l-1}(F_0) \cdot \sum_{i=0}^l n_i \|\alpha_i\|^2 \end{aligned}$$

show that $\sum_{i=0}^l n_i \|\alpha_i\|^2 = 1$.

The previous proposition makes clear that the lower vertex of an upper alcove cannot have the type of a short simple root for commensurability reasons. (Here the convention is that a root is long and not short if the root system is simply laced.) We next observe that no lower vertex can have type 0. For volume reasons such a vertex would have to lie in F_0 which is absurd.

Theorem 15 (Second Sum Formula) *The following sum formula holds.*

$$\sum_{i=1}^l n_i P_{\alpha_i}(1) = 2^{l-1}$$

Proof. We look at $\text{vol}_{l-1}(2F_0)$ and compute the volume in two ways. First, of course, $\text{vol}_{l-1}(2F_0) = 2^{l-1} \text{vol}_{l-1}(F_0)$. Second, consider the tessellation of $2F_0$ induced by the tessellation of $\mathfrak{h}_{\mathbb{R}}^*$ by the alcoves. Namely, $\text{vol}_{l-1}(F_i) = n_i \cdot \text{vol}_{l-1}(F_0)$ and for each $\alpha_i \in \Pi^{(\text{long})}$ there are $P_{\alpha_i}(1)$ simplices of type i in the tessellation of $2F_0$. \square

5 An example

In this section we try to exemplify the remark about the “shell-like” structure before Theorem 11. Take A_{11} . Look at the abelian ideal corresponding to the following Young diagram.

s_0	s_1	s_2	s_3	s_4
s_{11}	s_0	s_1	s_2	
s_{10}	s_{11}	s_0	s_1	
s_9	s_{10}	s_{11}	s_0	
s_8	s_9	s_{10}	s_{11}	
s_7	s_8	s_9		
s_6	s_7			

$$w = s_0 \underbrace{s_1 s_2 s_3 s_4 s_{11} s_{10} s_9 s_8 s_7 s_6}_{=: w_1} s_0 \underbrace{s_1 s_2 s_{11} s_{10} s_9 s_8 s_7}_{=: w_2} s_0 \underbrace{s_2 s_{11} s_{10} s_9}_{=: w_3} s_0 \underbrace{s_{11}}_{=: w_4}$$

r	s_{i_r}	$s_{i_1} \dots s_{i_r} \rho - s_{i_1} \dots s_{i_{r-1}} \rho$	s_{j_r}	$s_{j_1} \dots s_{j_r} \rho - s_{j_1} \dots s_{j_{r-1}} \rho$
1	s_0	111111111111	s_0	111111111111
2	s_1	011111111111	s_1	011111111111
3	s_2	001111111111	s_{11}	111111111110
4	s_3	000111111111	s_0	011111111110
5	s_4	000011111111	s_2	001111111111
6	s_{11}	111111111110	s_1	001111111110
7	s_{10}	111111111100	s_{10}	111111111100
8	s_9	111111110000	s_{11}	011111111100
9	s_8	111111100000	s_0	001111111100
10	s_7	111111000000	s_3	000111111111
11	s_6	111110000000	s_2	000111111110
12	s_0	011111111110	s_1	000111111100
13	s_1	001111111110	s_9	111111110000
14	s_2	000111111110	s_{10}	011111110000
15	s_{11}	011111111100	s_{11}	001111110000
16	s_{10}	011111110000	s_0	000111110000
17	s_9	011111100000	s_4	000011111111
18	s_8	011111000000	s_8	111111100000
19	s_7	011110000000	s_9	011111100000
20	s_0	001111111100	s_{10}	001111100000
21	s_1	000111111100	s_{11}	000111100000
22	s_{11}	001111110000	s_7	111111000000
23	s_{10}	001111100000	s_8	011111000000
24	s_9	001111000000	s_9	001111000000
25	s_0	000111110000	s_6	111110000000
26	s_{11}	000111100000	s_7	011110000000

6 Symmetries of the Hasse graphs

In this section we look at the Hasse graph of the poset of abelian ideals in \mathfrak{b} and determine its group of symmetries. A natural geometric realization of the Hasse graph of abelian ideals in \mathfrak{b} lives in $\mathfrak{h}_{\mathbb{R}}^*$. The nodes are the ρ -points of the alcoves contained in $2A$. Two ρ -points are connected if and only if

their alcoves are adjacent. Surely, the geometric symmetry group of this 1-dimensional complex is a subgroup of the abstract symmetry group of the Hasse graph. In fact, it turns out that the two symmetry groups coincide unless \mathfrak{g} has type C_3 or G_2 . In the former case the abstract Hasse graph has the following shape with symmetry group $\mathbb{Z}/2\mathbb{Z} \times \mathbb{Z}/2\mathbb{Z}$.

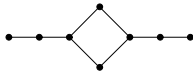

In the natural geometric realization the cycle of length four is actually not a square but a rectangle with side ratio $\sqrt{2} : 1$. Thus the geometric symmetry group collapses to $\mathbb{Z}/2\mathbb{Z}$. In the case of G_2 the two groups are 1 and $\mathbb{Z}/2\mathbb{Z}$ (see page 9).

Loosely speaking, the geometric symmetry group is the symmetry group of $2A$, hence isomorphic to the symmetry group of the affine Coxeter-Dynkin graph. Going through the classification one sees that the abstract symmetry group is the same as the geometric one, with the two exceptions mentioned above.

7 Examples: rank 4

In the next few pages we show the Hasse graphs of the posets of abelian ideals in \mathfrak{b} for the five simple types of rank 4. Each node of the Hasse graph consists of a diagram of a shape of which an enlarged version is drawn before the Hasse graph. The boxes of the enlarged version are filled with the nonforbidden⁵ positive roots. Each node in the Hasse graph corresponds to the abelian ideal $\bigoplus_{\varphi} \mathfrak{g}_{\varphi}$ where φ runs over the positive roots marked by a dot.

The arrows in the Hasse graphs have the following meaning. Each node which is not the source of an arrow corresponds to an ideal of the form $\mathfrak{a}^{\varphi, \min}$ for some $\varphi \in \Phi_+^{(\text{long})}$. For φ a long simple root, we have labeled the node belonging to $\mathfrak{a}^{\varphi, \min}$. The passage from $0 \neq \mathfrak{a}$ to $\mathfrak{a}^{\varphi, \min}$ corresponds to following the arrows till one arrives at a sink. Finally, an arrow points from the empty diagram ($\mathfrak{a} = 0$) to the diagram filled with one dot ($\mathfrak{a} = \mathfrak{g}_{\theta}$). Disregard the arrows for the automorphism groups.

⁵A forbidden positive root φ is such that $\theta - 2\varphi$ is a sum of positive roots. Then the root space \mathfrak{g}_{φ} cannot belong to an abelian ideal of \mathfrak{b} .

A_l

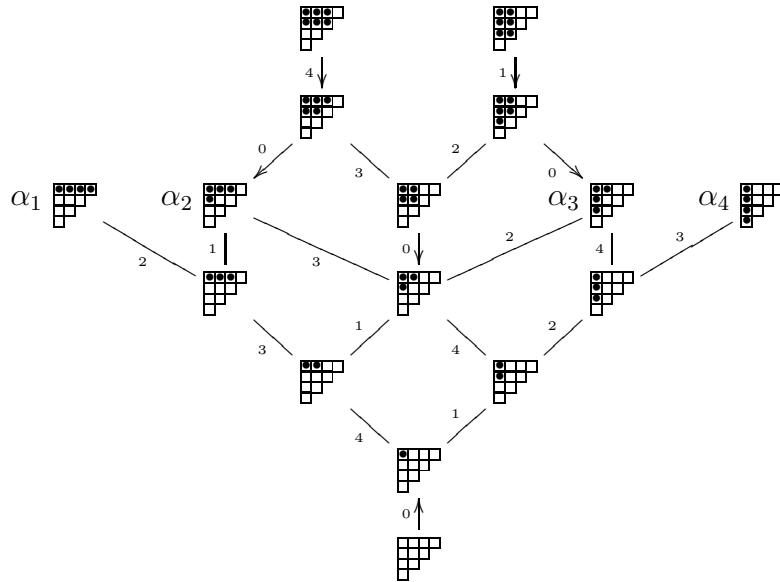
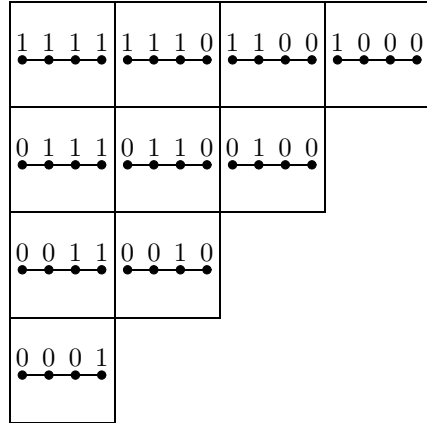
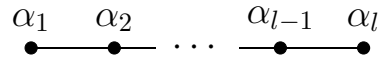

$$\text{Aut}(\text{Hasse}(A_1)) \cong \mathbb{Z}/2\mathbb{Z}$$

$$\text{Aut}(\text{Hasse}(A_l)) \cong \text{Dih}_{l+1} \quad (l \geq 2)$$

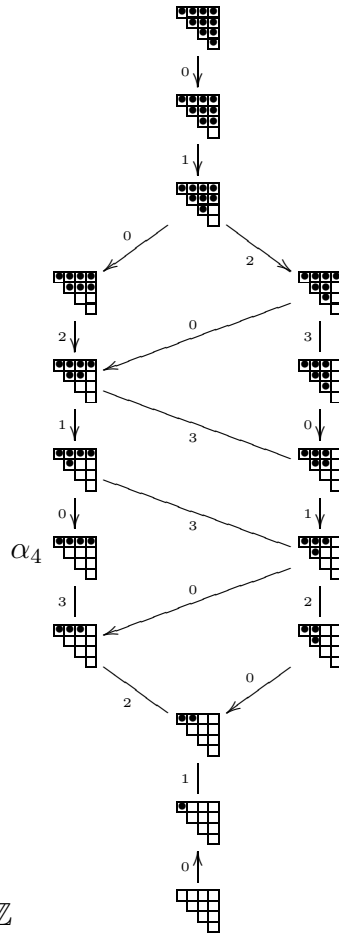
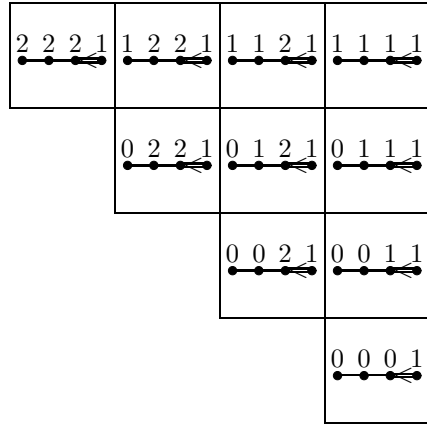
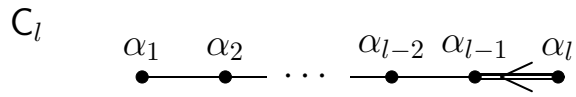

$$\begin{aligned} \text{Aut}(\text{Hasse}(C_2)) &\cong \mathbb{Z}/2\mathbb{Z} \\ \text{Aut}(\text{Hasse}(C_3)) &\cong \mathbb{Z}/2\mathbb{Z} \times \mathbb{Z}/2\mathbb{Z} \\ \text{Aut}(\text{Hasse}(C_l)) &\cong \mathbb{Z}/2\mathbb{Z} \quad (l \geq 4) \end{aligned}$$

B_l

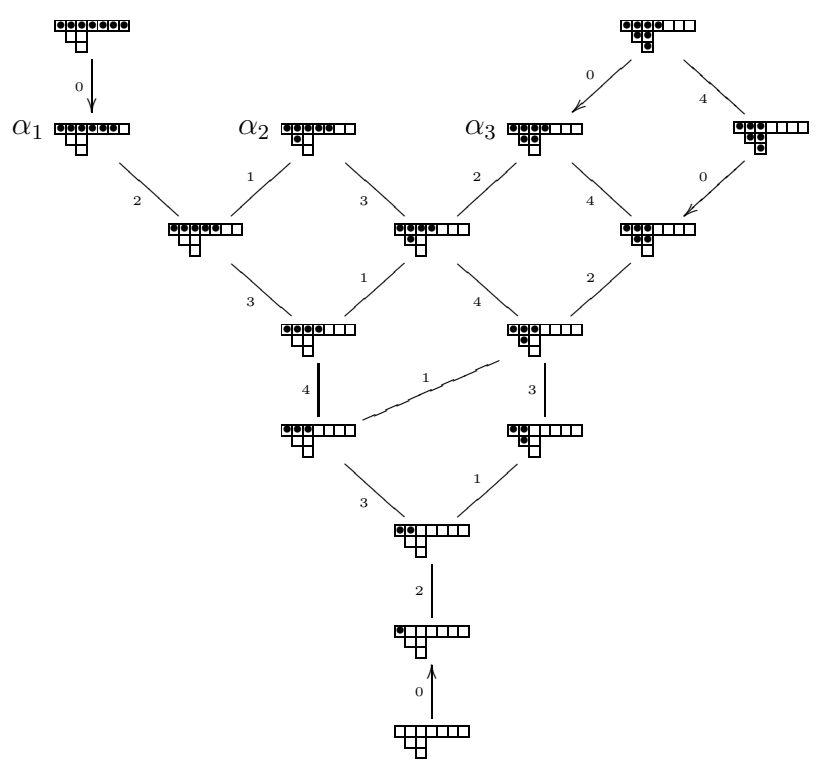
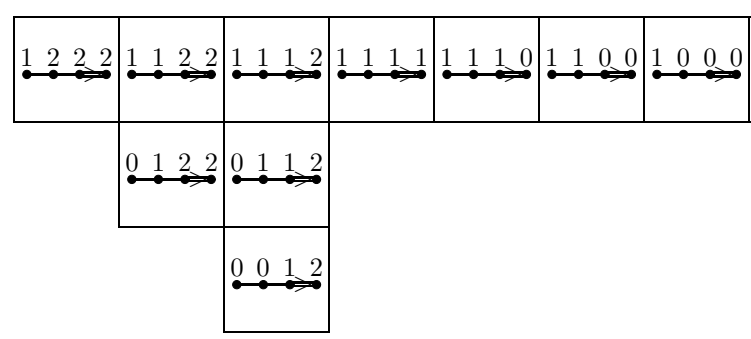
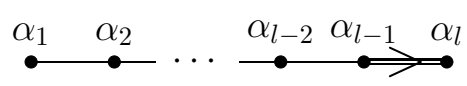

$$\text{Aut}(\text{Hasse}(B_l)) \cong \mathbb{Z}/2\mathbb{Z} \quad (l \geq 2)$$

D_l

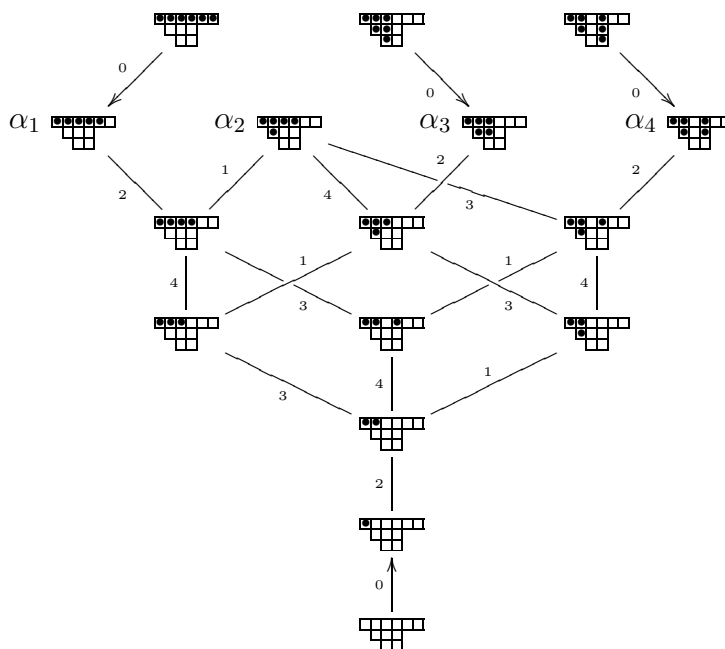
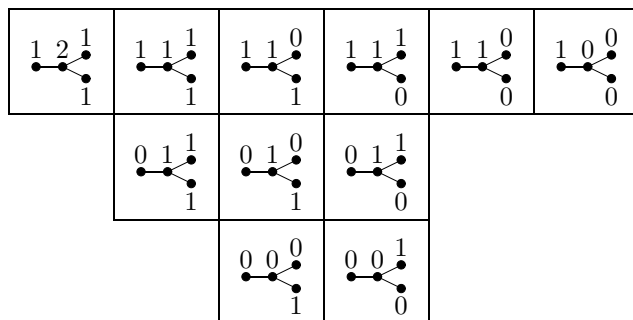
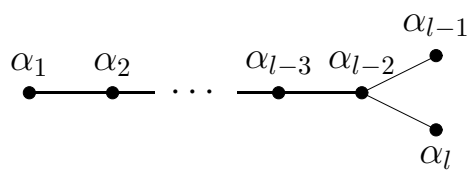

$$\text{Aut}(\text{Hasse}(D_4)) \cong \text{Sym}_4$$

$$\text{Aut}(\text{Hasse}(D_l)) \cong \text{Dih}_4 \quad (l \geq 5)$$

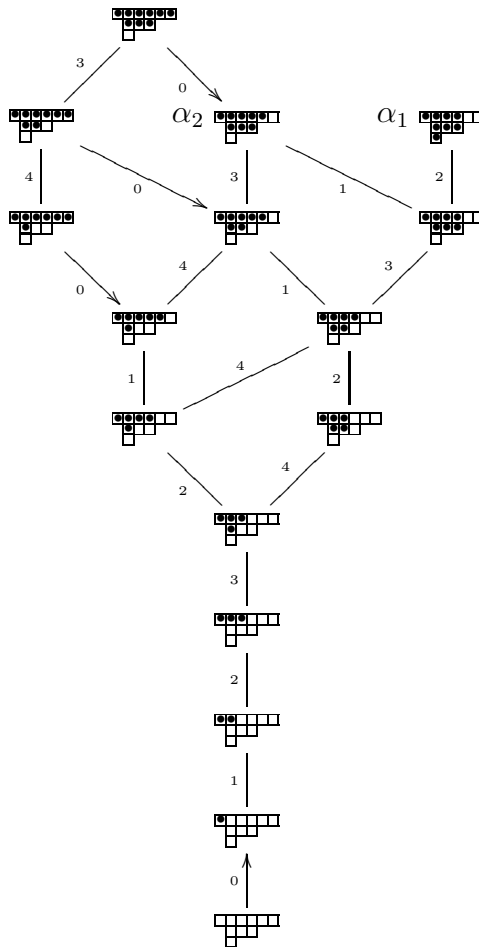
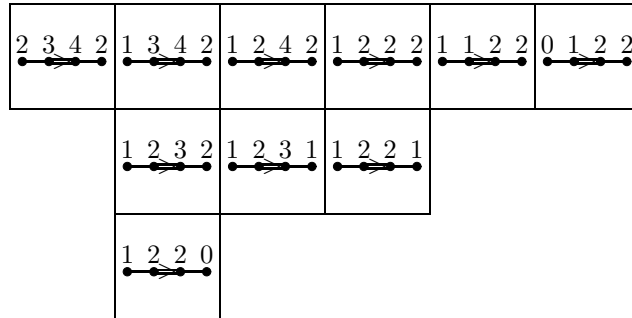
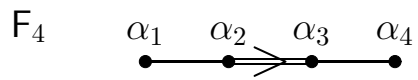

$\text{Aut}(\text{Hasse}(F_4)) = 1$

8 E_6

The picture shows the Hasse graph of the poset of abelian ideals for type E_6 . I chose to draw it in a way in which the symmetry becomes manifest. The nodes marked by $\varphi = \theta, \alpha_1, \dots, \alpha_6$ carry the abelian ideals $\mathfrak{a}^{\varphi, \min}$. The encircled nodes mark the maximal abelian ideals $\mathfrak{a}^{\alpha_i, \max}$ ($i = 1, \dots, 6$).

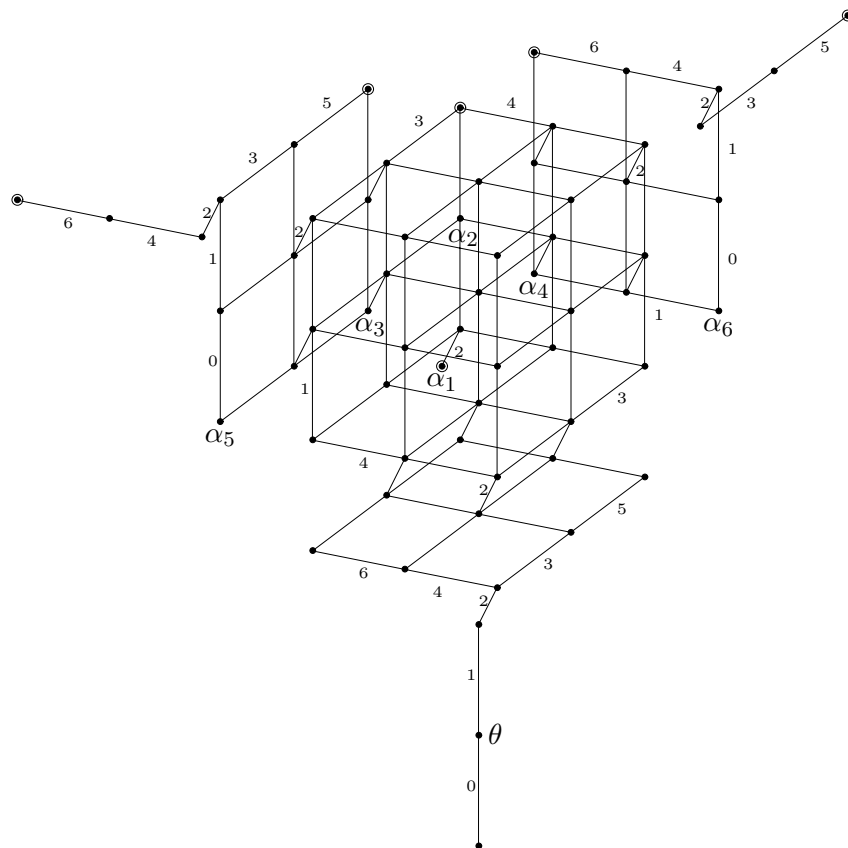

$$\text{Aut}(\text{Hasse}(E_6)) \cong \text{Sym}_3$$

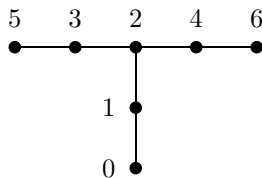

References

- [AKOP] G. E. Andrews, C. Krattenthaler, L. Orsina, P. Papi, *ad-nilpotent \mathfrak{b} -ideals in $\mathfrak{sl}(n)$ having a fixed class of nilpotence: combinatorics and enumeration*, *Trans. Amer. Math. Soc.* **354** (2002), 3835–3853
- [Arn] V. I. Arnold, *Polymathematics: is mathematics a single science or a set of arts?*, In: *Mathematics: frontiers and perspectives*, V. Arnold, M. Atiyah, P. Lax, B. Mazur (eds.), American Mathematical Society, Providence 2000
- [Boe] B. D. Boe, *Geometry of the Jantzen region in Lusztig’s conjecture*, *Math. Comp.* **70** (2001), 1265–1280
- [Bou] N. Bourbaki, *Groupes et algèbres de Lie, Chapitres 4, 5 et 6*, Hermann, Paris 1968, Masson, Paris 1981; *Lie groups and Lie algebras, Chapter 4–6*, Translated from the 1968 French original by Andrew Pressley, Springer, Berlin 2002
- [Bro] K. S. Brown, *Buildings*, Reprint of the 1989 original. Springer Monographs in Mathematics. Springer, New York 1998
- [CMP] P. Cellini, P. Möseneder Frajria, P. Papi, *Compatible discrete series*, [arXiv:math.RT/0207275](https://arxiv.org/abs/math.RT/0207275)
- [CP1] P. Cellini, P. Papi, *ad-nilpotent ideals of a Borel subalgebra*, *J. Algebra* **225** (2000), 130–141
- [CP2] P. Cellini, P. Papi, *Enumeration of ad-nilpotent ideals of a Borel subalgebra in type A by class of nilpotence*, *C. R. Acad. Sci. Paris Sér. I Math.* **330** (2000), 651–655
- [CP3] P. Cellini, P. Papi, *ad-nilpotent ideals of a Borel subalgebra II*, [arXiv:math.RT/0106057](https://arxiv.org/abs/math.RT/0106057)
- [Del] P. Deligne, *La série exceptionnelle de groupes de Lie*, *C. R. Acad. Sci. Paris Sér. I Math.* **322** (1996), 321–326
- [Hil] H. Hiller, *Geometry of Coxeter groups*, *Research Notes in Mathematics* **54**, Pitman, Boston 1982
- [Hum] J. E. Humphreys, *Reflection groups and Coxeter groups*, *Cambridge Studies in Advanced Mathematics* **29**, Cambridge University Press, Cambridge 1990

- [Jac] N. Jacobson, *Schur's theorems on commutative matrices*, Bull. Amer. Math. Soc. **50** (1944), 431–436
- [K1] B. Kostant, *Eigenvalues of the Laplacian and commutative Lie subalgebras*, Topology **3** (1965) suppl. 2, 147–159
- [K2] B. Kostant, *The set of abelian ideals of a Borel subalgebra, Cartan decompositions, and discrete series representations*, Internat. Math. Res. Notices (1998), 225–252
- [Kac] V. G. Kac, *Infinite-dimensional Lie algebras*, third edition, Cambridge University Press, Cambridge 1990
- [KOP] C. Krattenthaler, L. Orsina, P. Papi, *Enumeration of ad-nilpotent \mathfrak{b} -ideals for simple Lie algebras*, Adv. in Appl. Math. **28** (2002), 478–522
- [Mal] A. Malcev, *Commutative subalgebras of semi-simple Lie algebras*, Bull. Acad. Sci. URSS Sér. Math. **9** (1945), 291–300 [Izvestia Akad. Nauk SSSR] A. I. Malcev, *Commutative subalgebras of semi-simple Lie algebras*, Amer. Math. Soc. Translation **40** (1951)
- [Pan] D. I. Panyushev, *Abelian ideals of a Borel subalgebra and long positive roots*, arXiv:math.RT/0210428
- [PR] D. Panyushev, G. Röhrle, *Spherical orbits and abelian ideals*, Adv. Math. **159** (2001), 229–246
- [Sch] I. Schur, *Zur Theorie der vertauschbaren Matrizen*, J. Reine Angew. Math. **130** (1905), 66–76
- [Shi] J.-Y. Shi, *The number of \oplus -sign types*, Quart. J. Math. Oxford Ser. (2) **48** (1997), 93–105
- [Sri] B. Srinivasan, Review of [Boe], MR 2001j:20065
- [Sut] R. Suter, *Young's lattice and dihedral symmetries*, European J. Combin. **23** (2002), 233–238