

# The Conjugacy Problem and Higman Embeddings

A.Yu. Ol'shanskii, M.V. Sapir\*

## Abstract

For every finitely generated recursively presented group  $\mathcal{G}$  we construct a finitely presented group  $\mathcal{H}$  containing  $\mathcal{G}$  such that  $\mathcal{G}$  is (Frattini) embedded into  $\mathcal{H}$  and the group  $\mathcal{H}$  has solvable conjugacy problem if and only if  $\mathcal{G}$  has solvable conjugacy problem. Moreover  $\mathcal{G}$  and  $\mathcal{H}$  have the same r.e. Turing degrees of the conjugacy problem. This solves a problem by D. Collins.

## Contents

<b>1</b>	<b>Introduction</b>	<b>2</b>
<b>2</b>	<b>List of relations</b>	<b>10</b>
2.1	$S$ -machines . . . . .	10
2.2	An auxiliary group . . . . .	11
2.3	The hardware of $\mathcal{S}$ . . . . .	11
2.4	Notation . . . . .	12
2.5	The rules of the $S$ -machine $\mathcal{S}$ . . . . .	13
2.6	The $S$ -machines $\bar{\mathcal{S}}$ and $\mathcal{S} \cup \bar{\mathcal{S}}$ . . . . .	17
2.7	Converting $\mathcal{S}$ into a set of relations . . . . .	18
2.8	Converting $\bar{\mathcal{S}}$ into a set of relations . . . . .	20
2.9	The presentation of the group $\mathcal{H}$ . . . . .	21
<b>3</b>	<b>The first properties of <math>\mathcal{H}</math></b>	<b>21</b>
3.1	Diagrams . . . . .	21
3.2	$\mathcal{G}$ embeds into $\mathcal{H}$ . . . . .	21
3.3	Bands and annuli . . . . .	25
3.4	Forbidden annuli . . . . .	30
3.5	Surgeries involving $\mathcal{G}$ -cells . . . . .	31
3.6	Shifting indexes . . . . .	33
<b>4</b>	<b>The group <math>\mathcal{H}_2</math></b>	<b>34</b>

---

\*Both authors were supported in part by the NSF grant DMS 0072307. In addition, the research of the first author was supported in part by the Russian Fund for Basic Research 99-01-00894 and by the INTAS grant 99-1224, the research of the second author was supported in part by the NSF grant DMS 9978802 and the US-Israeli BSF grant 1999298.

<b>5</b>	<b>The word problem in <math>\mathcal{H}_1</math></b>	<b>39</b>
<b>6</b>	<b>Some special diagrams</b>	<b>44</b>
6.1	$\theta$ -bands and trapezia . . . . .	44
6.2	Trapezia with 2-letter bases . . . . .	47
6.3	Trapezia simulate the work of $S$ -machines . . . . .	48
<b>7</b>	<b>Computations of <math>\mathcal{S} \cup \bar{\mathcal{S}}</math></b>	<b>54</b>
7.1	Brief history . . . . .	55
7.2	Standard computations . . . . .	57
7.3	Tame and wild computations . . . . .	65
7.4	Computations of $\bar{\mathcal{S}}$ . . . . .	70
7.5	All ring computations . . . . .	74
<b>8</b>	<b>Spirals</b>	<b>77</b>
<b>9</b>	<b>Rolls</b>	<b>86</b>
9.1	Rolls without a base . . . . .	87
9.2	Rolls with $L$ -annuli . . . . .	90
9.3	Rolls with base $L_{j-1}^{-1}K_jL_j$ . . . . .	96
9.4	Arbitrary rolls . . . . .	105
<b>10</b>	<b>Arrangement of hubs</b>	<b>107</b>
<b>11</b>	<b>The end of the proof</b>	<b>112</b>
	<b>References</b>	<b>113</b>
	<b>Subject index</b>	<b>116</b>

## 1 Introduction

In 1961, G. Higman [Hi] published the celebrated theorem that a finitely generated group is recursively presented if and only if it is a subgroup of a finitely presented group. Along with the results of Novikov [Nov] and Boone [Bo] this result showed that objects from logic (in that case, recursively enumerable sets) have group theoretic characterizations (see Manin [Ma] for the philosophy of Higman embeddings).

Clapham [Cla] (see also corrections in [Va]) was probably the first to investigate properties preserved under Higman embeddings. In particular, he slightly modified the original Higman construction and showed that his embedding preserves solvability (and even the r.e. Turing degree) of the word problem. Valiev [Va] proved a much stronger result: there exists a version of Higman embedding theorem that preserves the truth-table degree of the word problem. In particular, if the word problem of a finitely generated group is in P (i.e. can be solved in polynomial time by a deterministic Turing machine) then it can be embedded into a finitely presented group whose word problem is also in P (a correction to Valiev's paper was published in Mathematical reviews, review 54 # 413, see also

Lyndon and Schupp [LS] and Manin [Ma]). A simplified version of Valiev’s proof was later published by Aanderaa and Cohen in [AC] (see also Kalorkoti [Kal]). In [BORS], Birget, Rips and the authors of this paper obtained a group theoretic characterization of NP (non-deterministic polynomial time): a finitely generated group  $G$  has word problem in NP if and only if  $G$  is embedded into a finitely presented group with polynomial Dehn function.

The conjugacy problem turned out to be much harder to preserve under embeddings. Collins and Miller [CM] and Gorjaga and Kirkinskii [GK] proved that even subgroups of index 2 of finitely presented groups do not inherit solvability or unsolvability of the conjugacy problem.

In 1976 D. Collins [KT] posed the following question (problem 5.22): *Does there exist a version of the Higman embedding theorem in which the degree of unsolvability of the conjugacy problem is preserved?*

It was quickly realized that the main problem would be in preserving the smallest Turing degree, that is the solvability of conjugacy problem. In 1980, [Col], Collins analyzed existing proofs of Higman’s theorem, and discovered that there are essential difficulties. If a finitely generated group  $C$  is embedded into a finitely presented group  $B$  using any existing at that time constructions then the solvability of conjugacy problem in  $B$  implies certain properties of  $C$  which are much stronger than solvability of conjugacy problem. Collins even wrote the following pessimistic comments: “There seems at present to be no hope to establishing the analogue of Clapham’s theorem. ... Furthermore these difficulties seem to be more or less inevitable given the structure of the proof and probably a wholly new strategy will be needed to avoid them. For the present the most one can be hoped for is the isolation of conditions on  $C$  that are necessary and sufficient for the preservation of the solvability of the conjugacy problem in the Higman embedding.”

In this paper, we do find a “new strategy” and prove the following result. Recall (see R. Thompson [Tho]) that a subgroup  $\mathcal{G}$  of a group  $\mathcal{H}$  is called *Frattini embedded* if any two elements of  $\mathcal{G}$  that are conjugate in  $\mathcal{H}$  are also conjugate in  $\mathcal{G}$ . Clearly if  $\mathcal{G}$  is Frattini embedded into  $\mathcal{H}$  and  $\mathcal{H}$  has solvable conjugacy problem then  $\mathcal{G}$  has solvable conjugacy problem (by results from [CM] and [GK], cited above non-Frattini embedded subgroups do not necessarily inherit solvability of the conjugacy problem).

**Theorem 1.1.** *A finitely generated group has solvable conjugacy problem if and only if it is Frattini embedded into a finitely presented group with solvable conjugacy problem.*

Moreover we prove the following stronger result solving the original problem of Collins:

**Theorem 1.2.** *A finitely generated group  $\mathcal{G}$  with recursively enumerable set of relations has conjugacy problem of r.e. Turing degree  $\alpha$  if and only if  $\mathcal{G}$  can be Frattini embedded into a finitely presented group  $\mathcal{H}$  with conjugacy problem of r.e. Turing degree  $\alpha$ .*

In the forthcoming paper [OlSa4], we will present some corollaries of these theorems (we did not include the proofs of them here in order not to increase the difficulty level unnecessarily). In particular, we will show that one can drop the restriction that  $\mathcal{G}$  is finitely generated in Theorems 1.1, 1.2, replacing it with “countably generated”. We shall also show that a finitely generated group with solvable word, power and order problems can

be embedded into a finitely presented group with solvable word, order, power, and conjugacy problems. Thus a Higman embedding can greatly improve algorithmic properties of a group.

In this section, we explain the main ideas which lead us to our construction. We try to keep notation as simple as possible in this section of the paper, so the notation here does not necessarily coincide with the notation in the rest of the paper.

We consider the case when  $\mathcal{G} = \langle A \mid \mathcal{E} \rangle$  has decidable conjugacy problem and we want to embed it into a finitely presented group with decidable conjugacy problem (the case when the conjugacy problem in  $\mathcal{G}$  has arbitrary r.e. Turing degree is similar). The standard idea is to start with a machine which recognizes the set  $\mathcal{E}$  and then interpret this machine in a group. Of course we would like to have a machine which is easier to interpret. The most suitable machines for our purposes are the so called  $S$ -machines invented by the second author in [SBR] and successfully used in [SBR, BORS, OISa1, OISa2, OISa3]. An  $S$ -machine works with words which can have complicated structure determined by the problem. Different parts of these words can be elements of different groups (so we do not distinguish words whose corresponding parts are equal in the corresponding groups). As in Turing machines, every rule of an  $S$ -machine replaces subwords containing state letters by other subwords. For an exact definition of  $S$ -machines see Section 2.1. For now the reader can imagine just an ordinary Turing machine which works with words from the free group instead of a free monoid.

Here we give just one example of an  $S$ -machine which essentially goes back to C. Miller [Mil] (although Miller did not use  $S$ -machines). The real  $S$ -machine used in this paper is a “descendant” of this  $S$ -machine (obtained from Miller’s machine by several “mutations”). Assume that  $A$  is a symmetric set that is it contains the formal inverses of its elements, and let us embed  $\mathcal{G} = \langle A \mid \mathcal{E} \rangle$  into *some* finitely presented group  $\bar{\mathcal{G}} = \langle A \cup Y \mid \bar{\mathcal{E}} \rangle$  using, say, the standard Higman embedding. Now consider the  $S$ -machine  $\mathcal{M}$  with one state letter  $q$  and the tape alphabet  $A \cup Y$  considered as a generating set of the free group, and the following commands (each command says which subwords of a word should be replaced and the replacement word):

- $[q \rightarrow a^{-1}qa]$ , for every  $a \in A \cup Y$ ,
- $[q \rightarrow rq]$ , for every  $r \in \bar{\mathcal{E}}$ .

The first set of rules allows the state letter to move freely along a word of the form  $uqv$  where  $u, v$  are words from the free group on  $A \cup Y$ . Such words are called *admissible words* for  $\mathcal{M}$ .

The second set of rules allows us to insert any relation from  $\bar{\mathcal{E}}$  into the word (we are also allowed to insert and remove subwords of the form  $aa^{-1}$  because  $A \cup Y$  is a generating set of a free group).

It is easy to see that a word  $qu$ , where  $u$  is a word over  $A$ , is recognized by this machine (that is the machine takes it to the word  $q$ ) if and only if  $u = 1$  in the group  $\bar{\mathcal{G}}$ , that is if and only if  $u = 1$  in  $\mathcal{G}$  (because  $\mathcal{G}$  is embedded into  $\bar{\mathcal{G}}$ ).<sup>1</sup>

---

<sup>1</sup>Notice that by a result of Sapir [OISa2], for every Turing machine  $T$  there exists an  $S$ -machine  $\mathcal{M}$  corresponding to a group  $\bar{\mathcal{G}}$  as above which is polynomially equivalent to  $T$ . This shows that machines  $\mathcal{M}$  are as powerful as ordinary Turing machines.

Now let us present the ideas of a Higman embedding based on  $\mathcal{M}$ . Let  $T_1, T_2, \dots, T_m = W_0$  be an accepting *computation* of  $\mathcal{M}$ , that is a sequence of admissible words such that  $T_{i+1}$  is obtained from  $T_i$  by applying an  $S$ -rule of  $\mathcal{M}$ , the last word in this sequence is equal to  $q$  in the free group.

Suppose that modulo some set of group relations  $Z$  we have for every  $i = 1, \dots, m - 1$

$$P_i T_i = T_{i+1} P'_i$$

for some words  $P_i$  and  $P'_i$  over a certain alphabet (it is included in the finite generating set of the group we are constructing), that is we have a van Kampen diagram with the boundary label  $P_i T_i (P'_i)^{-1} T_{i+1}^{-1}$  (Figure 1):

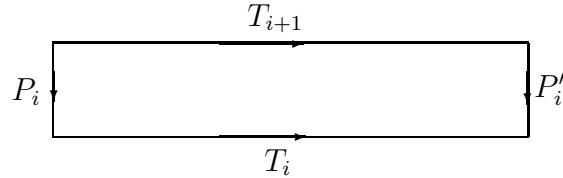

Figure 1.

(the set  $Z$  describes the method of tessellating this rectangle into cells). Then we have that  $PT_1 = W_0 P'$  where  $P = P_{m-1} \dots P_2 P_1$ ,  $P'_i = P'_{m-1} \dots P'_2 P'_1$ . The corresponding van Kampen diagram  $\Delta$  has the form of a *trapezium*:

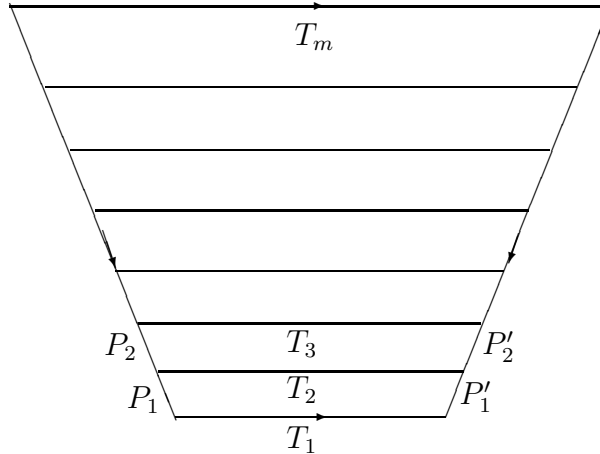

Figure 2.

For example, if we use the  $S$ -machine  $\mathcal{M}$  described above then the presentation  $Z$  is easy to describe: for every rule  $\tau = [q \rightarrow uqv]$  we have the following relations in  $Z$ :  $\theta_\tau^{-1} q \theta_\tau = uqv$ ,  $\theta_\tau a = a \theta_\tau$  for every  $a \in A \cup Y$  (the letters  $\theta_\tau$ , corresponding to the rules of  $\mathcal{M}$  are added to the generating set). In this case the words  $P_i, P'_i$  are of length 1, and are equal to  $\theta_\tau$ .

The words  $P$  and  $P'$  contain the *history* of our computation, because  $P_i$  and  $P'_i$  correspond to  $S$ -rules applied during the computation. The words  $T_1$  and  $T_m$  are labels of the top and the bottom paths of the trapezium.

If the set of relations  $Z$  is chosen carefully (and there are very many ways of doing this, see [SBR, BORS, OlSa2, OlSa1, OlSa3]), then the converse is also true:

**Condition 1.** If there exists a trapezium with the top labelled by  $T_1$ , the bottom labelled by  $W_0$  and the sides labelled by words over  $\Theta$  (the set of all  $\theta_\tau$ ) then  $T_1$  is admissible and the labels of the sides correspond to the history of an accepting computation.

Thus the word  $PT_1(P')^{-1}W_0^{-1}$  written on the boundary of a trapezium if and only if the word  $T_1$  is accepted.

The next step is to consider  $N \geq 1$  copies of our trapezium with labels taken from different alphabets. For technical reasons (similar to the hyperbolic graphs argument in [SBR], [Ol2], [BORS]) we need  $N$  to be even and large enough (say,  $N \geq 8$ ). Let us choose disjoint alphabets in different copies of the trapezium. Then we can glue two copies of the trapezium by using a special letter  $k$  which conjugates letters from the right side of the first trapezium with letters from the left side of the mirror image of another copy (Figure 3):

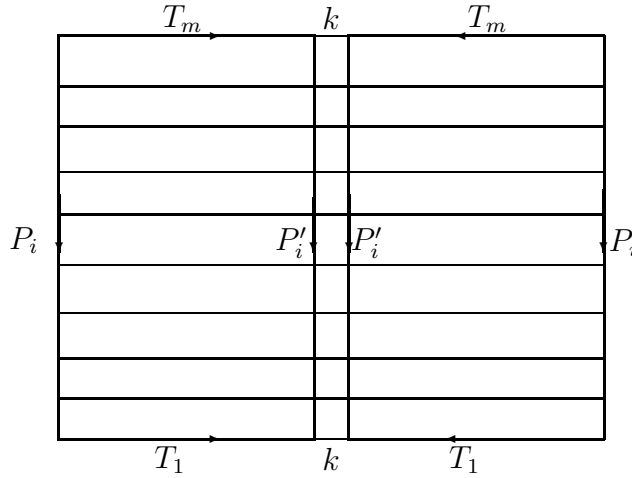

Figure 3.

(Notice that if  $P$  and  $P'$  are copies of each other then we can also glue the right side of one trapezium to the left side of another without taking mirror images.) Of course the conjugacy relations involving letter  $k$  should be added into the set of group relations  $Z$ .

Suppose that  $T_m$  is equal to  $q$ , i.e. the word  $T_1$  is *accepted* by the machine. If we connect the first copy of  $\Delta$  with the second copy, then with the third copy, and finally connect the  $N$ -th copy with the first copy, using different letters  $k_2, \dots, k_N, k_1$ , we get an *annular* diagram, a *ring*. The outer boundary of this ring has label  $\mathcal{K}(T_1)$  of the form  $k_1 T_1' k_2^{-1} (T_1'')^{-1} \dots$  (here we use the fact that  $N$  is even). The words  $T_1', \dots, T_1^{(N)}$  are different copies of  $T_1$ . The inner boundary has label  $k_1 q' k_2^{-1} (q'')^{-1} \dots$  (this word is called the *hub*) (Figure 4 shows the diagram in the case  $N = 4$ ):

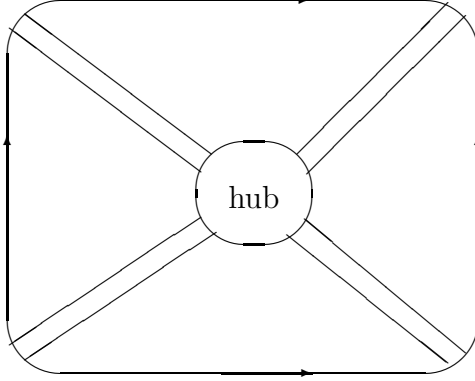

Figure 4.

We add the hub to the list of defining relations  $Z$ . Now with every word  $T$  of the form  $uqv$  where  $u, v$  are words in  $A \cup Y$  we have associated the word  $\mathcal{K}(T)$ , and we see that if  $T$  is accepted then  $\mathcal{K}(T)$  is equal to 1 modulo  $Z$ . Again, if  $Z$  is chosen carefully then the converse is also true:

**Condition 2.** If  $\mathcal{K}(T)$  is equal to 1 modulo  $Z$  then  $T$  is accepted by  $\mathcal{S}$ . Thus we have an interpretation of  $\mathcal{S}$  in the group generated by the tape alphabet and the state alphabet of  $\mathcal{S}$ , the set  $\Theta$ , and the set  $\{k_1, \dots, k_N\}$ , subject to the relations from  $Z$ .

The diagram on the previous Figure is called a *disk*. The trapezia forming this disk are numbered in the natural order (from 1 to  $N$ ).

We assume that the copy of the alphabet  $A$  used in the first subtrapezium of a disk coincides with  $A$  itself (the generating set of  $\mathcal{G}$ ).

Let us denote the group given by the presentation  $Z$  we have got so far by  $G(\mathcal{M})$ .

There are several ways to use the group  $G(\mathcal{M})$  to embed  $\mathcal{G}$  into a finitely presented group. We cannot use the method used by Higman [Hi], Aanderaa [AC], Rotman [Rot], and us in [BORS] because it leads to problems discovered by Collins in [Col]. We use another method, described in [OISa2] and used also in [OISa3].

Consider  $N - 1$  new copies of the trapezium  $\Delta$ . Number these trapezia by  $2', \dots, N'$ . Identify the copy of  $A$  (but not  $Y$ ) and the state letter  $q$  in the trapezium number  $i'$  with the copy of  $A$  and the copy of  $q$  in the “old” trapezium number  $i$ . Now glue the trapezium number  $2'$  with the trapezium number  $3'$  using letter  $k_3$  (as before), then glue in the trapezium number  $4'$  and so on, but glue the trapezium number  $N'$  with the trapezium number  $2'$  using  $k_1 q k_2^{-1}$  (that would be possible because as it will turn out in that case the words  $P, P'$  will be copies of each other). That is conjugation of the letters on the side of the trapezium number  $N'$  by  $k_1 q k_2^{-1}$  gives the letters of the side of the mirror image of the trapezium number  $2'$ . Let us add the relations used in the new trapezia and the conjugation relations (involving  $k_i$ ) to  $Z$ .

The resulting picture is an annular diagram. The inner boundary of it is labelled by the hub. If we add the hub to the diagram, we get a van Kampen diagram which also looks like a disk but has  $N-1$  sectors. The outer boundary of this new disk is labelled by the word  $k_1qk_2^{-1}V$  where  $V$  is the suffix of  $\mathcal{K}(qu)$  staying after  $k_2^{-1}$ . Thus the word  $k_1qk_2^{-1}V$  and the word  $k_1quk_2^{-1}V$  are both equal to 1 modulo  $Z$ , so  $Z$  implies  $u = 1$ . Let us call the group given by the set of relations  $Z$  that we have constructed by  $\mathcal{H}$ .

We have proved that the identity map on  $A$  can be extended to a homomorphism from  $\mathcal{G}$  to the subgroup  $\langle A \rangle$  of the group  $\mathcal{H}$  given by the set of relations  $Z$ . It is possible to show that this homomorphism is injective, so  $\mathcal{G}$  is embedded into  $\mathcal{H}$ .

Suppose that  $\mathcal{G}$  has solvable conjugacy problem. Is it true that  $\mathcal{H}$  has solvable conjugacy problem? The answer is “not always”. Let us give two examples.

**Example 1.** Consider two pairs of words  $u_1, u_2$  and  $v_1, v_2$  over the alphabet  $A$  (we can view these words as elements of  $\mathcal{G}$ ). Let  $q$  be the first state letter in  $\mathcal{K}(qu)$ . Consider the words  $W_1 = q^{-1}u_1qu_2q^{-1}$  and  $W_2 = q^{-1}v_1qv_2q^{-1}$ . Suppose that there exists a word  $W(A)$  in the alphabet  $A$  such that  $W(A)u_1W(A)^{-1} = v_1, W(A)u_2W(A)^{-1} = v_2$ . Let  $W(A) = a_1a_2\dots a_k, a_i \in A$ . For every  $a \in A$  let  $\theta(a)$  correspond to the  $S$ -rule of the form  $[q \rightarrow a^{-1}qa]$ . Consider the word  $W(\Theta) = \theta(a_1)\theta(a_2)\dots\theta(a_k)$ . Then it is easy to see that  $W(\theta)W_1W(\theta^{-1}) = W_2$ . Thus if the pair  $(u_1, u_2)$  is conjugated to the pair  $(v_1, v_2)$  in  $\mathcal{G}$  then the words  $W_1$  and  $W_2$  are conjugated in  $\mathcal{G}$ . One can also prove that the converse statement is also true. In this example, pairs of words can be obviously replaced by any  $t$ -tuples of words,  $t \geq 2$ . Therefore if the conjugacy problem is solvable in  $\mathcal{G}$  then the conjugacy of  $t$ -tuples of elements in  $\mathcal{G}$  is solvable. It is known [Col] that there exists a finitely generated group  $\mathcal{G}$  with solvable conjugacy problem and unsolvable problem of conjugacy for sequences of elements. For such a group  $\mathcal{G}$  the group  $\mathcal{H}$  has undecidable conjugacy problem.

**Example 2.** Take two pairs of words  $(u_1, u_2), (v_1, v_2)$  over one of the copies of the alphabet  $A$ , say,  $A' \neq A$ , let  $q'$  be the corresponding copy of the letter  $q$ . Then it is possible to show that the words  $q'u_1(q')^{-1}u_2q'$  and  $q'v_1(q')^{-1}v_2q'$  (where  $u_1, u_2, v_1, v_2$  are words in  $A'$ ) are conjugated in  $\mathcal{H}$  if and only if for some words  $P, Q$

$$Qu_1Q^{-1} = v_1, P^{-1}u_2P = v_2$$

in the free group and  $PQ = 1$  in  $\mathcal{G}(A')$ , a copy of  $\mathcal{G}$ . This problem easily reduces (exercise!) to the following problem about group  $\mathcal{G}$ : *given four words  $s, t, p, r$  in the alphabet  $A$  find two integers  $m, n$  such that  $st^n = p^mr$  in  $\mathcal{G}$ .* It is quite possible that this problem can be undecidable even if the conjugacy problem is decidable.

These two examples suggest that we need to change the machine  $\mathcal{M}$ : we cannot allow trapezia with top path labelled by words of the form  $qu_1q^{-1}u_2q$  having long histories. In other words, if a computation of the  $S$ -machine starts with  $qu_1q^{-1}u_2q$ , then it should not be too long (more precisely, if it is too long, we should be able to replace it with a shorter computation). If we achieve that then we would have a recursive bound on the length of the word  $W$  in Example 1 and the words  $P, Q$  in Example 2, so we would be able to find these words by a simple search.

This lead us to the  $S$ -machine  $\mathcal{S}$  considered in this paper (see Sections 2.3,2.4,2.5). This machine has four sets of state letters:  $K, L, P, R$ -letters. These letters are placed in an admissible word  $\mathcal{K}(u)$  according to the following pattern:  $KLPRK^{-1}R^{-1}P^{-1}L^{-1}KLPR\dots$



The  $P$ -letters play the role of the many copies of  $q$  in  $\mathcal{K}(qu)$  above: they moves along an admissible word and “find” places where to insert relations from  $\bar{\mathcal{E}}$ . The  $K$ -letters are the letters  $k_i$  in  $\mathcal{K}(qu)$  (they divide admissible words into copies of the same word and do not move). The  $L$ - and  $R$ -letters are “support letters”. While  $P$  is moving,  $L, R$  stay next to  $K$ -letters. But when  $P$  “wants” to insert a relation,  $L, R$  must move next to  $P$  and they insert the relation “together” (executing the rule  $LPR \rightarrow rLPR$ ,  $r \in \bar{\mathcal{E}}$ ). After that  $L, R$  must move back to their initial positions, and  $P$  can move to a new place in the admissible word (the work of the machine resembles a complicated dance performed synchronously by several groups of dancers).

It is important to mention that we cannot allow all parts of the admissible words to be arbitrary group words. To avoid long computations without inserting new relation from  $\bar{\mathcal{E}}$ , we had to require that the words between neighbor  $K$ -letter and  $L$ -letter,  $L$ -letter and  $P$ -letter,  $R$ -letter and  $K$ -letter (but not between  $P$ -letter and  $R$ -letter!) to be positive (i.e. they cannot contain letters  $a^{-1}$ ).

In order to keep these subwords positive we use a trick that goes back to Novikov, Boone and Higman (see Rotman [Rot]). They used a special letter  $x$  and Baumslag-Solitar relations of the form  $a^{-1}xa = x^2$  for every  $a$  in the tape alphabet of the machine. The idea is that if we have relations  $a^{-1}xa = x^2$  for all  $a \in A$  and a word  $u^{-1}xu$ , where  $u$  is a reduced word in  $A$ , is equal modulo these relations to a power of  $x$  then the first letter of  $u$  is positive.

We use a similar idea. But our task is more complicated than in [Nov, Bo, Hi] because we need to consider conjugacy of arbitrary pairs of words, not only those that have “nice” structure. So we had to use many different letters  $x$ , replace 2 by 4 in the Baumslag-Solitar relations, and make some other technical modifications. Notice that one problem with using the  $x$ -letters and Baumslag-Solitar relations is that since  $N - 1$  is odd we cannot use  $x$ -letters in the second disk described above (indeed, otherwise it would be impossible to glue the  $N - 1$  sectors together since the words  $P$  and  $P'$  would not be copies of each other). Thus we need to consider two  $S$ -machines (one responsible for the first disk, another for the second disk) which are very similar but have different “hardware”: the admissible words of the first machine must have positive parts described above, the admissible words of the second machine do not have to satisfy this restriction.

Notice that Examples 1 and 2 are only the main obstacles that we had to overcome in this paper. Other technical difficulties lead to further fine tuning of our  $S$ -machine. Sections 2.7, 2.8, 2.9 contain precise description of the presentation of our group  $\mathcal{H}$ .

Now let us briefly describe the strategy of the proof that the conjugacy problem in  $\mathcal{H}$  is Turing reducible to the conjugacy problem in  $\mathcal{G}$ . As in our previous papers the main tool in this paper is bands (other people call them “strips”, “corridors”, etc.).

In terms of annular (Schupp) diagrams, our task is the following: given two words  $u$  and  $v$  in generators of  $\mathcal{H}$ , find out if there exists an annular diagram over the presentation of  $\mathcal{H}$  with boundary labels  $u$  and  $v$ . It turns out that any annular diagram over  $\mathcal{H}$  (after removing some parts of recursively bounded size) becomes a diagram of one of three main types: a *ring* (where the boundary labels contain  $K$ -,  $L$ -,  $P$ -,  $R$ -letters but do not contain  $\theta$ -letters, all maximal  $\theta$ -bands are annuli surrounding the hole of the diagram), a *roll* (where the boundary label does not contain  $K$ -,  $L$ -,  $P$ -,  $R$ -letters but contain  $\theta$ -letters; all maximal  $K$ -,  $L$ -,  $P$ -,  $R$ -bands are annuli surrounding the hole), and a *spiral* (where

the boundary labels contain both  $K$ -,  $L$ -,  $P$ -, or  $R$ -letters and  $\theta$ -letters; both  $K$ -,  $L$ -,  $P$ -,  $R$ -bands and the  $\theta$ -bands start and end on the different boundary components, and each  $\theta$ -band crosses each  $K$ -,  $L$ -,  $P$ -, and  $R$ -band many times<sup>2</sup>). Different methods are used to treat different cases. Roughly speaking, the study of rings amounts to study the lengths of computations of our  $S$ -machines, the study of rolls amounts to the study of the space complexity (how much space is needed by the machines during a computation), and the study of spirals amounts to the study of computations with periodic history. The  $x$ -letters and the Baumslag-Solitar relations allow us to treat the case of rings, but they cause the main technical difficulties in the cases of rolls and spirals.

## 2 List of relations

### 2.1 $S$ -machines

Here we give the general definition of  $S$ -machines (see [OlSa2]). The precise definition of the  $S$ -machines used in this paper will be given later.

Let  $T_1, \dots, T_k$  be a collection of groups,  $T_i = \langle A_i \rangle$ ,  $i = 1, \dots, k$ , and the sets  $A_i$  of generators pairwise disjoint. Let  $\mathcal{K}$  be a set of *state letters*, disjoint from  $\cup A_i$ . Let  $\mathbf{A}$  be a set of *admissible* words of the form  $q_1 w_1 q_2 \dots q_k w_k q_{k+1}$  where  $w_i$  is a word over some  $A_j$ ,  $q_i \in \mathcal{K} \cup \mathcal{K}^{-1}$ .

We do not distinguish words over  $A_i$  which are equal in the group  $T_i$ . So we can view  $w_i$  as elements in  $T_i$ .

Any  $S$ -rule  $\tau$  has the following form  $[k_1 \rightarrow v_1 k'_1 u_1, \dots, k_n \rightarrow v_n k'_n u_n]$  where  $u_j, v_j$  are group words over  $\cup A_i$ ,  $k_j \in \mathcal{K} \cup \mathcal{K}^{-1}$ . Every  $S$ -rule is a partial transformation on the set of admissible word. Every admissible word  $W$  in the domain of the  $S$ -rule  $\tau$  must have  $\mathcal{K}$ -letters only from the set  $\{k_1^{\pm 1}, \dots, k_n^{\pm 1}\}$  (not all of these letters may occur, and some of them may occur more than once). This transformation takes an admissible word  $W$ , and replaces each  $k_j^{\pm 1}$  by  $(v_j k'_j u_j)^{\pm 1}$ , freely reduces the resulting word and then trims maximal prefix and suffix of the resulting word consisting of non- $\mathcal{K}$ -letters. For example, if  $W \equiv k_1 p_1 k_1 p_2 k_2^{-1} p_3 k_3$  for some words  $p_1, p_2, p_3$  over  $\cup A_i$  (we assume  $n \geq 3$ ) is in the domain of  $\tau$ , then the result of the application of  $\tau$  is the freely reduced form of  $k'_1 u_1 p_1 v_1 k'_1 u_1 p_2 u_2^{-1} k_2^{-1} v_2^{-1} p_3 v_3 k'_3$ . Notice that the resulting word must be an admissible word for the  $S$ -machine as well, otherwise  $W$  is not in the domain of  $\tau$ .

The *inverse* rule  $\tau^{-1}$  is the inverse partial transformation. It has the form  $[k'_1 \rightarrow v_1^{-1} k_1 u_1^{-1}, \dots, k'_n \rightarrow v_n^{-1} k_n u_n^{-1}]$ .

Thus we can view an  $S$ -machines as a semigroup of partial transformations of the set of admissible words. If  $W$  is an admissible word of an  $S$ -machine  $\mathcal{S}$ , and  $h = \tau_1 \tau_2 \dots \tau_n$  is a sequence (word) of rules of  $\mathcal{S}$ , applicable to  $W$  (that is  $W$  is in the domain of the partial map  $h$ ), then the result  $W'$  of application of  $h$  to  $W$  is denoted by  $W \circ h$ . The corresponding computation  $W, W \circ \tau_1, W \circ \tau_1 \tau_2, \dots, W'$  will be denoted by  $W \bullet h$  or  $W \bullet h = W'$ .

The collection of groups  $T_i$  and the set of admissible words form the *hardware* of an  $S$ -machine. The *software* of an  $S$ -machine is a finite collection of  $S$ -rules closed under

---

<sup>2</sup>In that case the  $\theta$ -band looks like a spiral on a plane that starts at the origin and crosses many times straight lines (the  $K$ -,  $L$ -,  $P$ - and  $R$ -bands).

taking inverses.

## 2.2 An auxiliary group

Let  $\mathcal{G}$  be a group given by the following presentation

$$\mathcal{G} = \langle a_1, \dots, a_m \mid w = 1, w \in \mathcal{E} \rangle, \quad (2.1)$$

where  $\mathcal{E}$  is a recursively enumerable set of words in  $a_1, \dots, a_m$ . Adding if necessary, new generators and relations of the form  $a_i a_i' = 1$  one can assume that the set  $\mathcal{E}$  consists of positive words only, i.e., there are no occurrences of  $a_i^{-1}$  in the words  $w \in \mathcal{E}$ .

We first prove Theorem 1.1 and then show how to modify the proof to obtain Theorem 1.2. So we shall assume that  $\mathcal{G}$  has solvable conjugacy problem.

By the Higman Embedding Theorem [Rot] there is a finitely presented group  $\bar{\mathcal{G}}$  generated by  $a_1, \dots, a_m, \dots, a_{\bar{m}}$  containing  $\mathcal{G}$  as a subgroup. By Clapham-Valiev's result [Cla, Va], one can assume that the word problem in  $\bar{\mathcal{G}}$  is decidable.

Besides, one may assume that again, for each generator  $a$  of  $\bar{\mathcal{G}}$ , the inverse letter  $a'$  is also included in the set of generators  $\{a_1, \dots, a_m, \dots, a_{\bar{m}}\}$  of  $\bar{\mathcal{G}}$ . For every  $a \in \{a_1, \dots, a_{\bar{m}}\}$ , we assume that there are positive relators of the form  $aa'$  and  $a'a$  in the finite set  $\bar{\mathcal{E}}$  of positive defining relators for  $\bar{\mathcal{G}}$ . We will also suppose that if  $r \in \bar{\mathcal{E}}$  then  $r' \in \bar{\mathcal{E}}$  where  $r'$  is obtained from  $r^{-1}$  by replacing every occurrence of a letter  $a^{-1}$  by the letter  $a'$ . Finally, we will assume that  $\bar{\mathcal{E}}$  contains the empty word  $\emptyset$ . It is clear that  $\bar{\mathcal{E}}$  is a presentation of the group  $\bar{\mathcal{G}}$  in the class of all monoids, so we have the following

**Lemma 2.1.** *Assume that  $w_1 = w_2$  for positive group words  $w_1, w_2$  in the generators of  $\bar{\mathcal{G}}$ . Then there is a sequence of positive words starting with  $w_1$  and ending with  $w_2$ , where every word in the sequence is obtained from the previous word by insertion or deletion of a subword  $w \in \bar{\mathcal{E}}$ .*

The list of relations of the group  $\mathcal{H}$  which we are going to construct will depend on the set  $\bar{\mathcal{E}}$  of defining words for  $\bar{\mathcal{G}}$ . Lemma 3.9 below claims that there is a natural embedding of the subgroup  $\mathcal{G} \leq \bar{\mathcal{G}}$  into  $\mathcal{H}$ , but (caution!) we will not embed the whole group  $\bar{\mathcal{G}}$  into  $\mathcal{H}$ .

## 2.3 The hardware of $\mathcal{S}$

The group  $\mathcal{H}$  that we are going to construct is associated with two very similar  $S$ -machines,  $\mathcal{S}$  and  $\bar{\mathcal{S}}$ . We shall describe the  $S$ -machines, then we will describe how to convert these machines into a group presentation.

We fix an even number  $N \geq 8$ .

The set  $\mathcal{K}$  of state letters of  $\mathcal{S}$  consists of letters  $z_j(r, i)$  where  $z \in \{K, L, P, R\}$ ,  $j = 1, \dots, N$ ,  $r \in \bar{\mathcal{E}}$ ,  $i \in \{1, 2, 3, 4, 5\}$ .

We also define the set of *basic* letters  $\tilde{\mathcal{K}}$  which consists of letters  $z_j$  where  $z \in \{K, L, P, R\}$ ,  $j = 1, \dots, N$ . Letters from  $\tilde{\mathcal{K}}^{-1}$  are also called *basic* letters. There exists a natural map from  $\mathcal{K} \cup \mathcal{K}^{-1}$  to  $\tilde{\mathcal{K}} \cup \tilde{\mathcal{K}}^{-1}$  which forgets indexes  $r$  and  $i$ . If  $z$  is a basic

letter,  $r \in \bar{\mathcal{E}}$ ,  $i \in \{1, 2, 3, 4, 5\}$  then  $z(r, i) \in \mathcal{K}$ . If  $U$  is a word in  $\tilde{\mathcal{K}}$  and other letters,  $r \in \bar{\mathcal{E}}$ ,  $i \in \{1, 2, 3, 4, 5\}$  then  $U(r, i)$  is a word obtained from  $U$  by replacing every letter  $z \in \tilde{\mathcal{K}}$  by  $z(r, i)$ . The parameters  $r$  and  $i$  in the letter  $z(r, i)$  or in the word  $U(r, i)$  will be called the  $\bar{\mathcal{E}}$ -coordinate and the  $\Omega$ -coordinate of the word.

The set  $\mathcal{A}$  of *tape letters* of the machine  $\mathcal{S}$  consists of letters  $a_i(z)$  where  $i = 1, \dots, \bar{m}$ ,  $z \in \tilde{\mathcal{K}}$ . For every  $z \in \tilde{\mathcal{K}}$  we define  $\mathcal{A}(z)$  as the set of all  $a_i(z)$ ,  $i = 1, \dots, \bar{m}$ .

Let  $\tilde{\Sigma}$  be the following word (considered as a cyclic word):

$$\begin{aligned} & K_1 L_1 P_1 R_1 K_2^{-1} R_2^{-1} P_2^{-1} L_2^{-1} K_3 L_3 P_3 R_3 K_4^{-1} \\ & \dots K_N^{-1} R_N^{-1} P_N^{-1} L_N^{-1} \end{aligned} \quad (2.2)$$

Notice that for every basic letter  $z$  precisely one of  $z$  and  $z^{-1}$  occurs in the word  $\tilde{\Sigma}$ . The word  $\Sigma = \tilde{\Sigma}(\emptyset, 1)$  will be called the *hub*.

For every  $z \in \tilde{\mathcal{K}} \cup \tilde{\mathcal{K}}^{-1}$  by  $z_-$  we denote the letter immediately preceding  $z$  in the cyclic word  $\tilde{\Sigma}$  or in  $\tilde{\Sigma}^{-1}$ . This definition is correct because every basic letter occurs exactly once in the word  $\tilde{\Sigma}$  or its inverse (see remark above). If  $z' = z_-$  then we set  $z = z'_+$ . Similarly we define  $z_-$  and  $z_+$  for  $z \in \mathcal{K}$ . Notice that for every  $j = 1, \dots, N$ ,

$$(L_j)_- = \begin{cases} K_j & \text{if } j \text{ is odd,} \\ K_{j+1}^{-1} & \text{if } j \text{ is even.} \end{cases}$$

and

$$(R_j)_+ = \begin{cases} K_{j+1}^{-1} & \text{if } j \text{ is odd,} \\ K_j & \text{if } j \text{ is even.} \end{cases}$$

To simplify the notation and avoid extra parentheses, we shall denote  $(L_j)_-$  by  $\overleftarrow{L}_j$  and  $(R_j)_+$  by  $\overrightarrow{R}_j$ . We also define  $\mathcal{A}(z^{-1})$  for  $z \in \tilde{\mathcal{K}}$  by setting  $\mathcal{A}(z^{-1}) = \mathcal{A}(z_-)$ .

The language of *admissible words* of the machine  $\mathcal{S}$  consists of all reduced words of the form  $W \equiv y_1 u_1 y_2 u_2 \dots y_t u_t y_{t+1}$  where  $y_1, \dots, y_{t+1} \in \mathcal{K}^{\pm 1}$ ,  $u_i$  are words in  $\mathcal{A}(y_i)$ ,  $i = 1, 2, \dots, t$ , and for every  $i = 1, 2, \dots, t$ , either  $y_{i+1} \equiv (y_i)_+$  or  $y_{i+1} \equiv y_i^{-1}$ . (Here  $\equiv$  is the letter-for-letter, or graphical, equality of words.) The projection of  $y_1 \dots y_{t+1}$  onto  $\tilde{\mathcal{K}}$  will be called the *base* of the admissible word  $W$ . The subword  $y_i u_i y_{i+1}$  is called the  $y_i y_{i+1}$ -*sector* of the admissible word  $W$ ,  $i = 1, 2, \dots$ . The word  $u_i$  is called the *inner part* of the  $y_i y_{i+1}$ -sector. We assume that the inner part of any  $z L_j$ -,  $z P_j$ - or  $R_j z$ -sector of  $W$  and  $W^{-1}$  is a positive word ( $z \in \tilde{\mathcal{K}}$ ), that is it does not contain  $a^{-1}$  for any  $a \in \mathcal{A}$ . Notice that if  $W$  is an admissible word for  $\mathcal{S}$  then  $W^{-1}$  is an admissible word as well.

By definition, all  $\mathcal{K}$ -letters in an admissible word have the same  $\bar{\mathcal{E}}$ -coordinates and  $\Omega$ -coordinates. Notice that  $\tilde{\Sigma}(r, i)$  is an admissible word for every  $r, i$ .

Two admissible words  $W \equiv y_1 u_1 y_2 u_2 \dots y_t u_t y_{t+1}$  and  $W' \equiv y'_1 u'_1 y'_2 u'_2 \dots y'_t u'_t y'_{t+1}$  are considered *equal* if  $W \equiv W'$ .

## 2.4 Notation

In this paper, the  $S$ -rules will have a specific form which allows us to simplify the notation. In every rule  $[k_1 \rightarrow v_1 k'_1 u_1, \dots, k_n \rightarrow v_n k'_n u_n]$ , the projections  $k_i$  and  $k'_i$  on  $\tilde{\mathcal{K}}$  will be always the same, the  $\bar{\mathcal{E}}$ -coordinates and the  $\Omega$ -coordinates of all state letters  $k_1, \dots, k_n$  (resp.

$k'_1, \dots, k'_n$ ) will be the same. In addition, each  $u_i$  (resp.  $v_i$ ) will contain only letters from  $\mathcal{A}(k_i)$  (resp.  $\mathcal{A}((k_i)_-)$ ),  $i = 1, \dots, n$ .

For every word  $W$  in the alphabet  $\{a_1, \dots, a_{\bar{m}}\}$  and every  $k \in \tilde{\mathcal{K}}$ ,  $W(k)$  will denote the word obtained from  $W$  by substitution  $a_i \rightarrow a_i(k)$ ,  $i = 1, \dots, \bar{m}$ .

In any expressions like  $vku$  where  $v$  is a word in  $\mathcal{A}(k_-)$ ,  $u$  is a word in  $\mathcal{A}(k)$ ,  $k \in \tilde{\mathcal{K}}$ , we shall not mention what alphabets these words are written in. For example the notation  $a_i P_j a_i^{-1}$  means  $a_i(L_j) P_j a_i(P_j)^{-1}$ , that is the two  $a_i$  are brothers taken from different alphabets.

Thus in order to simplify notation, we shall write a rule  $\tau$  of the  $S$ -machines  $\mathcal{S}$  in the form

$$[k_1 \rightarrow v_1 k_1 u_1, \dots, k_n \rightarrow v_n k_n u_n; r \rightarrow r', \omega \rightarrow \omega']$$

where  $k_i \in \tilde{\mathcal{K}}$ ,  $v_i$  are words in  $\mathcal{A}((k_i)_-)$ ,  $u_i$  are words in  $\mathcal{A}(k_i)$ . We shall denote  $v_i$  by  $v(\tau((k_i)_-))$ ,  $u_i$  by  $u_\tau(k_i)$ .

Some of the arrows in a rule  $\tau$  can have the form  $k_i \xrightarrow{\ell}$ . This means that the rule  $\tau$  can be applied to an admissible word  $W$  only if the inner part of  $k_i k'_i$ -sectors and  $k_{i''}(k_i)_+$ -sectors in  $W$  are empty words and  $k'_i = (k_i)_+$ ,  $k_{i''} = k_i$  (i.e.  $k'_i \neq k_i^{-1}$  and  $k_{i''} \neq (k_i)_+^{-1}$ ). We shall say that in this case the  $k_i(k_i)_+$ -sectors are *locked* by the rule and the rule *locks* these sectors. If  $kk_+$ -sectors are locked by the rule,  $u(k)$  and  $v(k)$  must be empty. Thus if  $\tau$  locks  $kk_+$ -sectors then  $\tau^{-1}$  locks these sectors as well.

Let us expand the definition of  $u_\tau(k)$ ,  $v_\tau(k_-)$  to the base letters not occurring in the rule by setting that in this case  $u_\tau(k)$  and  $v_\tau(k_-)$  are empty.

**Thus with every rule  $\tau$  and every  $k \in \mathcal{K}$  we associate two words over  $\mathcal{A}$ :  $u_\tau(k)$  and  $v_\tau(k)$ . We expand this definition to  $k \in \tilde{\mathcal{K}}^{-1}$  by saying that  $v_\tau(k^{-1}) \equiv u_\tau(k)^{-1}$ ,  $u_\tau(k^{-1}) \equiv v_\tau(k_-)^{-1}$ .**

By definition, to *apply* the rule  $\tau = [z_1 \rightarrow v_1 z_1 u_1, \dots, z_s \rightarrow v_s z_s u_s; r \rightarrow r', \omega \rightarrow \omega']$  to an admissible word  $W = y_1 w_1 y_2 \dots w_k y_{k+1}$  means replacing each  $y_i(r, \omega)$  by  $v_i y_i(r', \omega') u_i$ , reducing the resulting word, and trimming the prefix  $v_\tau((y_1)_-)$  from the beginning and the suffix  $u_\tau(y_{k+1})$  from the end of the resulting word. (Notice that  $w_i$  is non-empty if  $y_i \equiv y_{i+1}^{-1}$ , and therefore  $y_i(r', \omega')$  will not cancel with  $y_{i+1}(r', \omega')$  in the resulting word, because the subword between these two letters will not be empty.) The rule  $\tau$  is called *applicable* to  $W$  if:

- (1) for every  $z \in \tilde{\mathcal{K}}$  such that  $\tau$  locks  $zz_+$ -sectors the inner parts of  $zz_+$ -sectors in  $W$  are empty words, and  $W$  does not have  $zz^{-1}$ -sectors or  $z_+^{-1}z_+$ -sectors.
- (2) the resulting word  $W'$  is again admissible (that is the inner parts of all sectors which are supposed to be negative or positive are such).

## 2.5 The rules of the $S$ -machine $\mathcal{S}$

The rules from  $\mathcal{S}^+ \subset \mathcal{S}$ , described below, will be called *positive*, the inverses of these rules will be called *negative*, each rule of  $\mathcal{S}$  will be either positive or negative.

The set  $\mathcal{S}^+$  consists of 10 subsets  $\mathcal{S}^+(\omega)$ ,  $\omega \in \{1, 12, 2, 23, 3, 34, 4, 45, 5, 51\}$ .

The set  $\mathcal{S}^+(1)$  consists of rules  $\tau(1, \emptyset, i)$ , where  $i = 1, \dots, \bar{m}$ . The rule  $\tau(1, \emptyset, i)$  has the form

$$[\overleftarrow{L}_j \xrightarrow{\ell} \overleftarrow{L}_j, P_j \rightarrow a_i P_j a_i^{-1}, R_j \xrightarrow{\ell} R_j, j = 1, \dots, N; \emptyset \rightarrow \emptyset, 1 \rightarrow 1].$$

The meaning of this set of rules is that the state letter  $P_j$  can freely move (if the  $(\bar{\mathcal{E}}, \Omega)$ -coordinates are  $(\emptyset, 1)$ , and  $L_j$ -letters and  $R_j$ -letters stay next to  $K_j$ -letters). Indeed, if in an admissible word, the  $\mathcal{A}$ -letter next to the right of  $P_j$  is  $a_i$  (and rule  $\tau(1, \emptyset, i)$  is applicable to the word) then applying the rule  $\tau(1, \emptyset, i)$ , we move all  $P_j$  one letter to the right. Similarly, if we want to move  $P_j$  one letter to the left, we need to apply  $\tau(1, \emptyset, i)^{-1}$  for an appropriate  $i$ .

Notice that, for every  $z \in \mathcal{K}$ , all state letters  $z_j, j = 1, \dots, N$  behave in the same way when we apply  $\tau(1, \emptyset, i)$ . This important property will hold for all other rules of  $\mathcal{S}$ .

Recall also that the two  $a_i$  in  $a_i P_j a_i^{-1}$  are not the same: they are brothers taken from different alphabets (see Section 2.4).

The set  $\mathcal{S}^+(12)$  consists of one rule  $\tau(12, r)$  for each  $r \in \bar{\mathcal{E}} \setminus \{\emptyset\}$ :

$$[\overleftarrow{L}_j \xrightarrow{\ell} \overleftarrow{L}_j, R_j \xrightarrow{\ell} R_j, j = 1, \dots, N; \emptyset \rightarrow r, 1 \rightarrow 2]$$

This rule does not insert any tape letters, it simply changes the  $\bar{\mathcal{E}}$ - and  $\Omega$ -coordinates of state letters. This *transition rule* prepares the machine for step 2.

The set  $\mathcal{S}^+(2)$  consists of rules  $\tau(2, r, i)$  where  $r \in \bar{\mathcal{E}}, i = 1, \dots, \bar{m}$ :

$$\tau(2, r, i) = [L_j \rightarrow a_i L_j a_i^{-1}, R_j \xrightarrow{\ell} R_j, j = 1, \dots, N; r \rightarrow r, 2 \rightarrow 2].$$

The meaning of these rules is that they allow the state letters  $L_j$  to move freely while  $R_j$  stays next to  $\overrightarrow{R}_j$ .

The set  $\mathcal{S}^+(23)$  consists of one rule for each  $r \in \bar{\mathcal{E}}$ :

$$\tau(23, r) = [L_j \xrightarrow{\ell} L_j, R_j \xrightarrow{\ell} R_j; r \rightarrow r, 2 \rightarrow 3].$$

The meaning of this rule is that the machine can start step 3 when  $L_j$  and  $P_j$  meet (that is when the inner parts of  $L_j z$ -sectors are empty).

The set  $\mathcal{S}^+(3)$  consists of one rule for each  $r \in \bar{\mathcal{E}}$  and each  $i$  from 1 to  $\bar{m}$ :

$$\tau(3, r, i) = [L_j \xrightarrow{\ell} L_j, R_j \rightarrow a_i^{-1} R_j a_i, j = 1, \dots, N; r \rightarrow r, 3 \rightarrow 3].$$

These rules allow the state letter  $R_j$  to move freely between  $P_j$  and  $\overrightarrow{R}_j$ .

The set  $\mathcal{S}^+(34)$  consists of one rule for each non-empty  $r \in \bar{\mathcal{E}}$ :

$$\tau(34, r) = [L_j \xrightarrow{\ell} r L_j, P_j \xrightarrow{\ell} P_j, j = 1, \dots, N; r \rightarrow r, 3 \rightarrow 4].$$

This rule can be applied when the state letters  $L_j, P_j, R_j$  meet together; it inserts  $r$  to the left of the state letters  $L_j$ , and prepares the machine for step 4.

The set  $\mathcal{S}^+(4)$  consists of rules  $\tau(4, r, i), r \in \bar{\mathcal{E}}, i = 1, \dots, \bar{m}$ :

$$\tau(4, r, i) = [L_j \rightarrow a_i L_j a_i^{-1}, P_j \xrightarrow{\ell} P_j, j = 1, \dots, N; r \rightarrow r, 4 \rightarrow 4].$$

These rules allow the state letter  $L_j$  to move freely between  $\overleftarrow{L}_j$  and  $P_j$ .

The set  $\mathcal{S}^+(45)$  consists of one rule for each  $r \in \bar{\mathcal{E}}$ :

$$\tau(45, r) = [\overleftarrow{L}_j \xrightarrow{\ell} \overleftarrow{L}_j, P_j \xrightarrow{\ell} P_j, j = 1, \dots, N; r \rightarrow r, 4 \rightarrow 5].$$

The machine can start step 5 when  $L_j$  and  $\overleftarrow{L}_j$  meet.

The set  $\mathcal{S}^+(5)$  consists of one rule for each  $r \in \mathcal{E}, i = 1, \dots, \bar{m}$ :

$$\tau(5, r, i) = [\overleftarrow{L}_j \xrightarrow{\ell} \overleftarrow{L}_j, R_j \rightarrow a_i^{-1} R_j a_i, j = 1, \dots, N; r \rightarrow r, 5 \rightarrow 5].$$

These rules allow  $R_j$  move freely between  $P_j$  and  $\overrightarrow{R}_j$ .

Finally the set  $\mathcal{S}^+(51)$  consists of one rule for each  $r \in \bar{\mathcal{E}}$ :

$$\tau(51, r) = [\overleftarrow{L}_j \xrightarrow{\ell} \overleftarrow{L}_j, R_j \xrightarrow{\ell} R_j, j = 1, \dots, N; r \rightarrow \emptyset, 5 \rightarrow 1].$$

The cycle is complete, the machine can start step 1 again when  $\overleftarrow{L}_j$  meets  $L_j$ , and  $R_j$  meets  $\overrightarrow{R}_j$ .

Rules from the set  $\mathcal{S}(12) \cup \mathcal{S}(23) \cup \mathcal{S}(34) \cup \mathcal{S}(45) \cup \mathcal{S}(51)$  will be called *transition rules*.

A graphical description of the work of the  $S$ -machine  $\mathcal{S}$  is presented on Figure 5 below.

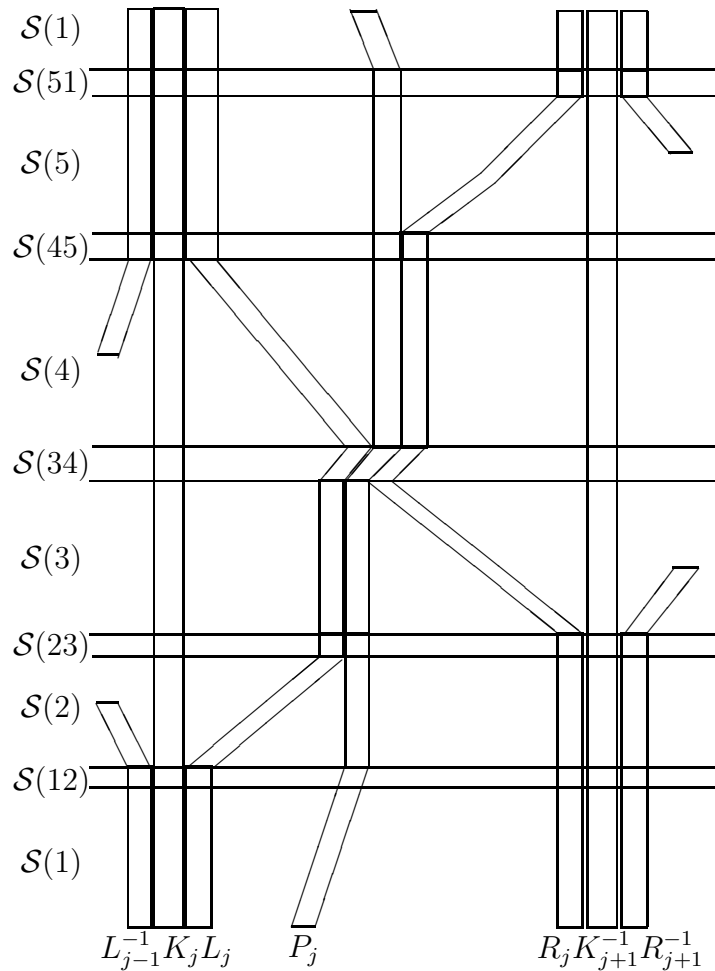

Figure 5.

Some of the main properties of  $\mathcal{S}$  are the following.

**Remark 2.1.** Notice that if  $W = y_1 u_1 y_2 \dots y_{t+1}$  is an admissible word for  $\mathcal{S}$ ,  $y_1$  (resp.  $y_{t+1}$ ) is  $K_j(r, i)^{\pm 1}$  for some  $j, r, i$  then one does not need trimming the prefix (resp. suffix) in order to produce  $W \circ \tau$  because in this case  $v((y_1)_-)$  (resp.  $u(y_{t+1})$ ) is empty for all rules  $\tau$ .

For every word  $w$  in  $\{a_1, \dots, a_{\bar{m}}\}$  let us denote the word

$$\begin{aligned} & K_1(\emptyset, 1)L_1(\emptyset, 1)P_1(\emptyset, 1)w(P_1)R_1(\emptyset, 1)K_2(\emptyset, 1)^{-1}\dots \\ & K_N(\emptyset, 1)^{-1}R_N(\emptyset, 1)^{-1}w(P_N)^{-1}P_N(\emptyset, 1)^{-1}L_N(\emptyset, 1)^{-1} \end{aligned} \quad (2.3)$$

by  $\Sigma(w)$ . Notice that  $\Sigma(\emptyset) = \Sigma$ . Clearly,  $\Sigma(w)K_1(\emptyset, 1)$  is admissible for  $\mathcal{S}$  for every positive  $w$ .

**Lemma 2.2.** An admissible word for  $\mathcal{S}$  cannot have  $L_j^{-1}L_j^-$ ,  $P_j^{-1}P_j^-$ , or  $R_jR_j^{-1}$ -sectors.

*Proof.* Indeed if  $W$  is an admissible word, then  $W^{-1}$  is also an admissible word. So the inner part of a  $L_j^{-1}L_j^-$ ,  $P_j^{-1}P_j^-$ , or  $R_jR_j^{-1}$ -sector of  $W$  must be both positive and negative. Hence the inner part must be empty, and  $W$  is not reduced, a contradiction.  $\square$

**Lemma 2.3.** Suppose that a positive word  $w'$  in  $\{a_1, \dots, a_{\bar{m}}\}$  can be obtained from a positive word  $w$  by insertion or deletion of a word  $r \in \bar{\mathcal{E}}$ . Then there exists a sequence  $h$  of rules of  $\mathcal{S}$  such that

$$\Sigma(w)K_1(\emptyset, 1) \circ h = \Sigma(w')K_1(\emptyset, 1). \quad (2.4)$$

The length of  $h$  is bounded by a linear function in  $|w| + |w'|$ .

Thus, in particular, for every positive word  $w$  which is equal to 1 in  $\bar{\mathcal{G}}$  there exists a word  $h$  in  $\mathcal{S}$  such that

$$\Sigma K_1(\emptyset, 1) \circ h = \Sigma(w)K_1(\emptyset, 1).$$

*Proof.* Without loss of generality we can assume that  $w'$  is obtained from  $w$  by inserting  $r$ . Then we can first apply to  $\Sigma(w)K_1(\emptyset, 1)$  rules from  $\mathcal{S}(1)$  to move the letters  $P_j^{\pm 1}$  to the places in copies of  $w^{\pm 1}$  where the insertion will occur ( $j = 1, \dots, N$ ). Then a rule from  $\mathcal{S}(12)$  (which is applicable) will change the coordinates from  $(\emptyset, 1)$  to  $(r, 2)$ . After that we can apply rules from  $\mathcal{S}(2)$  to move  $L_j^{\pm 1}$  next to  $P_j^{\pm 1}$  and ( $j = 1, \dots, N$ ). Then a rule from  $\mathcal{S}(23)$  will change the coordinates to  $(r, 3)$ . After that we can apply rules from  $\mathcal{S}(3)$  to move  $R_j^{\pm 1}$  next to  $P_j^{\pm 1}$ . Then a rule from  $\mathcal{S}(34)$  will insert  $r$  (resp.  $r^{-1}$ ) to the left of  $L_j$  (resp. to the right of  $L_j^{-1}$ ). Then rules from  $\mathcal{S}(4)$  will move  $L_j$  back to  $K_j$ , for odd  $j$  and  $L_j^{-1}$  to  $K_{j+1}$  for even  $j$ . Then a rule from  $\mathcal{S}(45)$  will change the coordinates to  $(r, 5)$ , and rules from  $\mathcal{S}(5)$  will move the letters  $R_j$  back to  $K_{j+1}^{-1}$  ( $j$  odd), and  $R_j^{-1}$  to  $K_j^{-1}$  ( $j$  even). Finally we can apply a rule from  $\mathcal{S}(51)$  and obtain  $\Sigma(w')K_1(\emptyset, 1)$  as required.

It is clear that the number of rules applied in the described process is bounded by a linear function in  $|w| + |w'|$ .

The ‘‘in particular’’ statement immediately follows from the first statement and Lemma 2.1.  $\square$



## 2.6 The $\mathcal{S}$ -machines $\bar{\mathcal{S}}$ and $\mathcal{S} \cup \bar{\mathcal{S}}$

The  $\mathcal{S}$ -machine  $\bar{\mathcal{S}}$  is similar to  $\mathcal{S}$  so we only present the differences between  $\mathcal{S}$  and  $\bar{\mathcal{S}}$ .

We introduce disjoint copies of sets  $\mathcal{K}, \tilde{\mathcal{K}}, \mathcal{A}$ , denote them by  $\bar{\mathcal{K}}, \tilde{\bar{\mathcal{K}}}, \bar{\mathcal{A}}$ , respectively. In order to make  $\mathcal{S}$  and  $\bar{\mathcal{S}}$  “communicate”, we identify  $z_j(\emptyset, 1)$  with  $\bar{z}_j(\emptyset, 1)$ ,  $z \in \{K, L, P, R\}$ ,  $j = 1, \dots, N$ , and  $a_i(P_j)$  with  $\bar{a}_i(\bar{P}_j)$   $i = 1, \dots, m, j = 1, \dots, N$ . Notice that we do not identify  $a_{m+1}, \dots, a_{\bar{m}}$  with their “bar”-brothers  $\bar{a}_{m+1}, \dots, \bar{a}_{\bar{m}}$ , and we do not identify  $a_i(z)$  with  $\bar{a}_i(z)$  for  $z \neq P_j$ . Notice also that this identification of letters makes the word  $\bar{\Sigma}$  coincide with the hub  $\Sigma$ .

*Admissible words* of  $\bar{\mathcal{S}}$  have the same form as admissible words of  $\mathcal{S}$  except for the following differences:

- All letters are replaced by their “bar”-brothers.
- We drop the restriction that certain parts of admissible words are positive (negative).
- The  $\bar{K}_1 z$ -,  $\bar{L}_1 z$ -,  $\bar{P}_1 z$ - and  $\bar{R}_1 z$ -sectors must be empty ( $z \in \tilde{\bar{\mathcal{K}}}$ ). Thus in every admissible word of  $\bar{\mathcal{S}}$  the part between  $\bar{K}_1$  and  $\bar{K}_2^{-1}$  contains no  $\bar{\mathcal{A}}$ -letters.

The rules of  $\bar{\mathcal{S}}$  are obtained from the corresponding rules of  $\mathcal{S}$  by replacing every letter by its “bar”-brother and by removing letters from  $\bar{\mathcal{A}}(\bar{z}_1)$ ,  $z \in \{K, L, P, R\}$ . Thus rules of  $\bar{\mathcal{S}}$  do not insert any  $\bar{\mathcal{A}}$ -letters in the interval between  $\bar{K}_1$  and  $\bar{K}_2^{-1}$ , and work in other parts of the admissible words just as  $\mathcal{S}$ .

For every admissible word  $W$  for  $\mathcal{S}$ , we define an admissible word  $\bar{W}$  of  $\bar{\mathcal{S}}$  by adding *bar* to all letters, and removing non- $\mathcal{K}$ -letters from all  $zz'$ -sectors, such that  $z$  or  $(z')^{-1}$  belongs to  $\{K_1, L_1, P_1, R_1, K_2\}$ .

**Lemma 2.4.** *Suppose that  $w, u$  are reduced words in  $\{a_1, \dots, a_{\bar{m}}\}$ , and  $w'$  is the freely reduced form of  $wuru^{-1}$ ,  $r \in \bar{\mathcal{E}}$ . Then there exists a sequence  $h$  of rules of  $\bar{\mathcal{S}}$  such that*

$$\bar{\Sigma}(w)K_1(\emptyset, 1) \circ h = \bar{\Sigma}(w')K_1(\emptyset, 1). \quad (2.5)$$

*Therefore, for every word  $w$  which is equal to 1 in  $\bar{\mathcal{G}}$  there exists a word  $h$  in  $\mathcal{S}$  such that*

$$\Sigma K_1(\emptyset, 1) \circ h = \bar{\Sigma}(w)K_1(\emptyset, 1).$$

*If all letters in  $w$  are with indices  $\leq m$ , then one can remove  $\bar{\phantom{x}}$  from the right-hand side of the previous formula (because we have identified these letters with their “bar”-brothers).*

*Proof.* The proof is similar to the proof of Lemma 2.3. The only difference is that at the beginning we transform every subword of the form  $P_j(\emptyset, 1)w(P_j)R_j(\emptyset, 1)$  into  $w(L_j)q(L_j)P_jq(L_j)^{-1}R_j(\emptyset, 1)$  using rules from  $\bar{\mathcal{S}}(1)$ .  $\square$

We shall also need the combined  $\mathcal{S}$ -machine  $\mathcal{S} \cup \bar{\mathcal{S}}$ . An admissible word for  $\mathcal{S} \cup \bar{\mathcal{S}}$  is either an admissible word for  $\bar{\mathcal{S}}$  or a word satisfying all conditions from the definition of an admissible word for  $\mathcal{S}$  except for the positivity condition. The set of rules of  $\mathcal{S} \cup \bar{\mathcal{S}}$  is the union of the set of rules of  $\mathcal{S}$  and  $\bar{\mathcal{S}}$ .

For the sake of simplicity of notation, for every word  $W$  we denote the projection  $W_{\mathcal{A} \cup \bar{\mathcal{A}}}$  of  $W$  onto the alphabet  $\mathcal{A} \cup \bar{\mathcal{A}}$  by  $W_a$ .

We shall call a rule  $\tau \in \mathcal{S}(g) \cup \bar{\mathcal{S}}(g)$  *active with respect to  $zz'$ -sectors* if  $u_\tau(z) \neq \emptyset$  or  $v_\tau(z'_-) \neq \emptyset$ .

We define a map  $\beta$  of the subset of generators  $\mathcal{A} \cup \bar{\mathcal{A}}$  of the group  $\mathcal{H}$  onto  $\{a_1, \dots, a_{\bar{m}}\} \cup \{1\}$  by the rule  $\beta(a_i(z)) = \beta(\bar{a}_i(z)) = a_i$  for all the  $\mathcal{A}$ - and  $\bar{\mathcal{A}}$ -letters. Hence the  $\beta$ -image of arbitrary word in  $\mathcal{A} \cup \bar{\mathcal{A}}$  is defined as an element of the free group with basis  $\{a_1, \dots, a_{\bar{m}}\}$ .

The following two properties of  $\mathcal{S} \cup \bar{\mathcal{S}}$  immediately follows from its definition.

**Lemma 2.5.** *If a rule  $\sigma \in \mathcal{S}(\omega)$  (resp.  $\sigma \in \bar{\mathcal{S}}(\omega)$ ) is active with respect to  $zz'$ -sectors then every rule in  $\mathcal{S}(\omega)$  (resp.,  $\bar{\mathcal{S}}(\omega)$ ) is active with respect to  $zz'$ -sectors.*

**Lemma 2.6.** *Let  $h$  be a sequence of rules from  $\mathcal{S} \cup \bar{\mathcal{S}}$  applicable to an admissible (for  $\mathcal{S} \cup \bar{\mathcal{S}}$ ) word  $W$ . Then for every  $zz'$ -sector  $z(r, i)W'z'(r, i)$  of  $W$  there exist two words  $u = u(h)$  and  $v = v(h)$  such that  $z(r, i)W'z'(r, i) \circ h = z(r_1, i_1)uW'vz'(r_1, i_1)$  in the free group for some coordinates  $r_1, i_1$ . The words  $u = u(z, h)$  and  $v = v(z', h)$  depend on  $z, z'$  and  $h$  only (i.e. they do not depend on the inner part of  $W'$ ). Moreover we have the following equalities:*

$$u(K_j, h) \equiv v(K_j, h) \equiv \emptyset, \beta(u(P_j, h)) = \beta(v(P_j, h))^{-1}, \beta(u(R_j, h)) \equiv \beta(v(R_j, h))^{-1}.$$

We also have that  $\beta(u(L_j, h)) = \beta(v(L_j, h))^{-1}$  provided  $h$  contains no rules from  $\mathcal{S}(34)$ .

**Lemma 2.7.** *Let  $U$  be any word in  $\tilde{\mathcal{K}}$ ,  $g \in \{1, 2, 3, 4, 5\}$ . Then there exist two sequences of numbers  $\{\varepsilon_z, \delta_z \in \{-1, 0, 1\} \mid z \in \tilde{\mathcal{K}}\}$ , such that for every admissible word  $W = W(r, g)$  with base  $U$ , and any group word  $w$  in the alphabet  $\{a_1, \dots, a_{\bar{m}}\}$  there exists a word  $h$  in  $\bar{\mathcal{S}}(g)$  satisfying the following properties:*

1.  $h$  is a copy<sup>3</sup> of  $w$  in the alphabet  $\bar{\mathcal{S}}(g)$ ;
2.  $W$  is in the domain of  $h$ ;
3.  $W \circ h$  is obtained from  $W$  by all replacements of the form

$$\bar{z}(r, g) \rightarrow w(z_-)^{\varepsilon_z} \bar{z}(r, g) w(z)^{\delta_z},$$

where  $z$  runs over all letters in the base of  $W$ . Here  $w(z)$  and  $w(z_-)$  are copies of  $w$  in the alphabets  $\bar{\mathcal{A}}(z)$  and  $\bar{\mathcal{A}}(z_-)$ .

Now we need to explain how to simulate the  $S$ -machines  $\mathcal{S}$  and  $\bar{\mathcal{S}}$  in a group  $\mathcal{H}$ .

## 2.7 Converting $\mathcal{S}$ into a set of relations

In order to convert the machine  $\mathcal{S}$  into a list of defining relations, we need to introduce one more set of letters  $\mathcal{X} = \{x(a, \tau) \mid a \in \mathcal{A} \setminus \cup_j \mathcal{A}(P_j), \tau \in \mathcal{S}^+\}$ . We will subdivide this set into subsets  $\mathcal{X}(z, \tau) = \{x(a, \tau) \mid a \in \mathcal{A}(z)\}$ ,  $z \in \tilde{\mathcal{K}}, z \neq P_j (j = 1, \dots, N), \tau \in \mathcal{S}$  and

---

<sup>3</sup>Here and below, we say that a word  $v$  is a *copy* of a word  $u$  if  $v$  is obtained from  $u$  by replacing equal letters by equal letters and different letters by different letters.

into subsets  $\mathcal{X}(z) = \cup_{\tau \in \mathcal{S}} \mathcal{X}(z, \tau)$ ,  $z \in \tilde{\mathcal{K}}$ , and  $\mathcal{X}(\tau) = \cup_{z \in \tilde{\mathcal{K}}} \mathcal{X}(z, \tau)$ ,  $\tau \in \mathcal{S}^+$ . We also set  $\mathcal{X}(z^{-1}) = \mathcal{X}(z_-)$  for every  $z \in \tilde{\mathcal{K}}$ .

For every  $\tau \in \mathcal{S}$ , we also consider map  $\alpha_\tau$  from  $\mathcal{A}$  to the free group generated by  $\mathcal{A}$  and  $\mathcal{X} \cup \mathcal{X}^{-1}$ . Let  $\tau \in \mathcal{S}^+$ ,  $a \in \mathcal{A}(z)$ ,  $z \in \tilde{\mathcal{K}}$ . Then:

$$\alpha_\tau(a) = \begin{cases} x(a, \tau)a & \text{if } z = K_j, j = 1, \dots, N, \\ x(a, \tau)a & \text{if } z = L_j, j = 1, \dots, N, \\ a & \text{if } z = P_j, j = 1, \dots, N, \\ ax(a, \tau) & \text{if } z = R_j, j = 1, \dots, N. \end{cases}$$

The definition of  $\alpha_\tau^{-1}$ ,  $\tau \in \mathcal{S}^+$ , is obtained from the definition of  $\alpha_\tau$  by replacing all  $\mathcal{X}$ -letters by their inverses.

We expand these maps to all words in the alphabet  $\mathcal{A} \cup \mathcal{A}^{-1} \cup \mathcal{K} \cup \mathcal{K}^{-1}$  in the natural way (mapping letters from  $\mathcal{K} \cup \mathcal{K}^{-1}$  to themselves). Let  $U$  be any word in  $\mathcal{A}$ . Then  $U$  is obviously equal to the *projection* of  $\alpha_\tau(U)$  onto the alphabet  $\mathcal{A}$ , i.e. the word obtained from  $\alpha_\tau(U)$  by removing all non- $\mathcal{A}$ -letters. In general, the projection of a word  $U$  onto an alphabet  $Y$  will be denoted by  $U_Y$ .

Also with every  $\tau \in \mathcal{S}^+$ , we associate a set of letters

$$\Theta(\tau) = \{\theta(\tau, z) \mid z \in \{K_j, L_j, P_j, R_j\}, j = 1, \dots, N\}.$$

Let  $\Theta(z) = \{\theta(\tau, z) \mid \tau \in \mathcal{S}^+\}$ ,  $z \in \{K_j, L_j, P_j, R_j\}$ . Finally the union of all  $\Theta(\tau)$  is denoted by  $\Theta$ .

Let  $\tau = [U_1 \rightarrow V_1, \dots, U_k \rightarrow V_k; r \rightarrow r', l \rightarrow l']$  be one of the rules of  $\mathcal{S}^+$ . Let  $u(z), v(z)$ ,  $z \in \tilde{\mathcal{K}}$ , be the words associated with this rule as in Section 2.4.

Then we associate with  $\tau$  the following list of *main relations* (or just  $(\Theta, k)$ -relations):

$$\theta(\tau, z_-)^{-1} z(r, l) \theta(\tau, z) = \alpha_{\tau^{-1}}(v_i) z(r', l') \alpha_{\tau^{-1}}(u_i), i = 1, \dots, k, \quad (2.6)$$

(Thus, the replacements associated with the rule  $\tau$  are simulated by ‘‘conjugation’’. Figure 6 shows a relation involving a  $P_j$ -letter, corresponding to a rule  $\tau = \tau(1, \emptyset, i)$ ; there  $P = P_j(1, 0)$ ,  $a = a_i(P_j)$ ,  $a' = a_i(L_j)$ ,  $x' = x(a_i(L_j), \tau)$ ,  $\theta = \theta(\tau, P_j)$ ,  $\theta' = \theta(\tau, L_j)$ .)

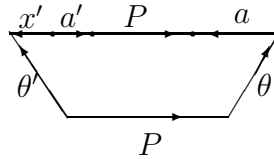

Figure 6.

We also need the following *auxiliary relations*. Let  $z \in \{K_j, L_j, P_j, R_j\}$ ,  $j = 1, \dots, N$ ,  $a, b \in \mathcal{A}(z)$ . Then we add *auxiliary  $\Theta$ -relations* (or  $(\theta, a)$ -relations):

$$\theta(\tau, z)^{-1} \alpha_\tau^+(a) \theta(\tau, z) = \alpha_\tau^-(a) \text{ if } \tau \text{ does not lock } zz_+ \text{-sector} \quad (2.7)$$

(On Figure 7,  $a = a_i(L_j)$ ,  $x = x(a, \tau)$ ,  $\theta = \theta(\tau, L_j)$  where  $\tau = \tau(2, r, i')$  for some  $i, i', r$ .)

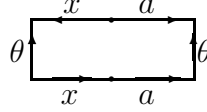

Figure 7.

and *auxiliary*  $(a, x)$ -relations:

$$\begin{aligned} ax(b, \tau)a^{-1} &= x(b, \tau)^4 & \text{if } z = K_j \text{ or } z = L_j, \\ a^{-1}x(b, \tau)a &= x(b, \tau)^4 & \text{if } z = R_j. \end{aligned} \quad (2.8)$$

(On Figure 8,  $a = a_i(L_j)$ ,  $x = x(a_{i'}(L_j), \tau)$  where  $\tau = \tau(2, r, i')$  for some  $i, j, i', r$ .)

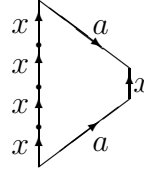

Figure 8.

Finally let  $b'$  be the “brother” of  $b$  in the alphabet  $\mathcal{A}(z_-)$  if  $z = K_j$  or  $z = L_j$ . Then we need auxiliary  $(k, x)$ -relations:

$$\begin{aligned} z(r, i)x(b, \tau) &= x(b', \tau)z(r, i) & \text{if } z = K_j, \\ z(r, i)x(b, \tau) &= x(b', \tau)^4z(r, i) & \text{if } z = L_j. \end{aligned} \quad (2.9)$$

(On Figure 9,  $L = L_j(0, 1)$ ,  $x = x(a_i(L_j), \tau)$ ,  $x' = x(a_i(\overleftarrow{L_j}), \tau)$ , where  $\tau = \tau(2, r, i')$  for some  $i, j, r, i'$ .)

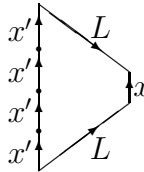

Figure 9.

Let  $\mathcal{R}(\mathcal{S})$  be the set of all relations (2.6) - (2.9) corresponding to the set of  $S$ -rules  $\mathcal{S}^+$ . It is easy to see that the relations corresponding to the negative rules from  $\mathcal{S}$  follow from  $\mathcal{R}(\mathcal{S})$ .

## 2.8 Converting $\bar{\mathcal{S}}$ into a set of relations

To convert  $\bar{\mathcal{S}}$  into a set of relations we do not need  $\mathcal{X}$ -letters, but we need “bar”-brothers of the letters from  $\Theta$ . Let this set be denoted by  $\bar{\Theta}$ . The easiest way to explain how to convert an  $S$ -rule of  $\bar{\mathcal{S}}$  to a set of relations is the following: convert it as in Section 2.7, then add bars to all letters, replace all letters from  $\mathcal{X}$  and from  $\cup \bar{A}(z_1)$ ,  $z \in \{K, L, P, R\}$  by 1. Let  $\mathcal{R}(\bar{\mathcal{S}})$  be the set of all relations corresponding to  $\bar{\mathcal{S}}^+$ .

## 2.9 The presentation of the group $\mathcal{H}$

The group  $\mathcal{H}$  which is the main object studied in this paper is given by the set of generators  $\mathcal{K} \cup \bar{\mathcal{K}} \cup \mathcal{A} \cup \bar{\mathcal{A}} \cup \Theta \cup \bar{\Theta} \cup \mathcal{X}$  and the set of relations  $\mathcal{R} = \mathcal{R}(\mathcal{S}) \cup \mathcal{R}(\bar{\mathcal{S}}) \cup \{\Sigma\}$ .

## 3 The first properties of $\mathcal{H}$

### 3.1 Diagrams

Recall the well-known van Kampen-Lyndon topological interpretation of the consequences of defining relations in groups [LS], [O11]. We define a van Kampen *diagram* over some group presentation  $\mathcal{L} = \langle x_1, \dots, x_k \mid \mathcal{P} \rangle$  (or briefly, by misuse of language, over the group  $\mathcal{L}$ ), where the defining words from  $\mathcal{P}$  are cyclically reduced. It is an oriented, connected, and simply connected, finite planar 2-complex such that every oriented edge  $e$  of it has a label  $\phi(e) \equiv x_i^{\pm 1}$ ,  $i = 1, \dots, k$ , where  $\phi(e^{-1}) \equiv \phi(e)^{-1}$ . In addition, the word read on the boundary  $\partial\Pi$  of an arbitrary 2-cell  $\Pi$  (we call it a *cell* latter on), coincides with one of defining word, up to a cyclic permutation and an inversion.

According to the van Kampen lemma a word  $w = w(x_1, \dots, x_k)$  equals 1 in a group  $\mathcal{L}$  if and only if there exists a van Kampen diagram  $\Delta$  over  $\mathcal{L}$  with  $w$  read clockwise on the boundary  $\partial(\Delta)$  starting from some vertex. All details can be found in [LS] or [O11].

An *annular* diagram  $\Delta$  is not simply connected (unlike a van Kampen diagram), but its complement on the plane has two components: the inner and the outer. So  $\Delta$  has the *inner* and *outer* contours. By the Schupp lemma [LS], [O11] their labels, read clockwise, are conjugate in  $\mathcal{L}$ . Conversely, for any pair of words  $u, v$ , which represent non-trivial conjugate elements of  $\mathcal{L}$ , there exists an annular diagram whose contours are labelled by  $u$  and  $v$  respectively.

### 3.2 $\mathcal{G}$ embeds into $\mathcal{H}$

We define a map  $\delta$  of the set of generators of the group  $\mathcal{H}$  into the group  $\bar{\mathcal{G}}$  by setting  $\delta(a_i(z)) = \delta(\bar{a}_i(z)) = a_i$  for all the  $\mathcal{A}$ - and  $\bar{\mathcal{A}}$ -letters and mapping other letters from the whole set of generators to 1.

**Lemma 3.1.** *The map  $\delta$  extends to the epimorphism  $\delta : \mathcal{H} \rightarrow \bar{\mathcal{G}}$ .*

*Proof.* The map  $\delta$  can be considered as an endomorphism of the free group over the generators of  $\mathcal{H}$ . It immediately follows from the list of relations of the group  $\mathcal{H}$ , that the  $\delta$ -image of every defining word for  $\mathcal{H}$  vanishes in  $\bar{\mathcal{G}}$ . Indeed, it is obvious for the hub word  $\Sigma$  since it does not contain  $\mathcal{A} \cup \bar{\mathcal{A}}$ -letters. It is also true for all auxiliary relations (2.7), (2.8), (2.9) because each of them contains exactly two occurrences of  $\mathcal{A} \cup \bar{\mathcal{A}}$ -letters whose  $\delta$ -images are mutually inverse. Same is true for all relations (2.6) corresponding to  $S$ -rules  $\tau$  and  $z \in \tilde{\mathcal{K}}$  unless  $\tau = \tau(34, r)$  and  $z = L_j$  or  $\tau = \bar{\tau}(34, r)$  and  $z = \bar{L}_j$  (for some  $r$  and  $j$ ). In the latter case the  $\delta$ -image of the relator (2.6) is equal to  $r$  which belongs to  $\bar{\mathcal{E}}$  and is equal to 1 in  $\bar{\mathcal{G}}$ .  $\square$

The following lemma is similar to Lemma 3.1 and immediately follows from the definition of  $\mathcal{S} \cup \bar{\mathcal{S}}$ .

**Lemma 3.2.** *For every word  $U$  in the domain of  $\tau \in \mathcal{S} \cup \bar{\mathcal{S}}$ ,  $\delta(U) = \delta(U \circ \tau)$  in  $\bar{\mathcal{G}}$ .*

**Lemma 3.3.** *a) Let  $W$  be an admissible word for the  $S$ -machine  $\mathcal{S}$ ,  $z$  be its first  $\mathcal{K}$ -letter and  $z'$  be its last  $\mathcal{K}$ -letter. Let  $\tau \in \mathcal{S}$ , and let  $v = v(z_-)$  and  $u = u(z')$  be the words associated with  $\tau$ , defined in Section 2.4. Suppose that  $\tau \in \mathcal{S}$  is applicable to  $W$ . Then*

$$\theta(\tau, z_-)^{-1} \alpha_\tau(W) \theta(\tau, z') = \alpha_{\tau^{-1}}(v) \alpha_{\tau^{-1}}(W \circ \tau) \alpha_{\tau^{-1}}(u)$$

in  $\mathcal{H}$ .

*b) Let  $W$  be an admissible word for the  $S$ -machine  $\bar{\mathcal{S}}$ ,  $z$  is its first  $\mathcal{K}$ -letter and  $z'$  is its last  $\mathcal{K}$ -letter. Let  $\tau \in \bar{\mathcal{S}}$ , and  $v = v(z_-)$  and  $u = u(z')$  be the words associated with  $\tau$ , defined in Section 2.4. Suppose that  $\tau$  is applicable to  $W$ . Then*

$$\theta(\tau, z_-)^{-1} W \theta(\tau, z') = v \cdot (W \circ \tau) \cdot u$$

in  $\mathcal{H}$ .

*Proof.* The proof follows from the definition of admissible words for  $\mathcal{S}$  and  $\bar{\mathcal{S}}$  (we do not need the positivity of certain segments of admissible words of  $\mathcal{S}$ ), relations (2.6), (2.7), and similar relations for  $\bar{\mathcal{S}}$ .  $\square$

**Definition 3.1.** Let  $w$  be a word over  $\{a_1, \dots, a_{\bar{m}}\}$ . For every  $z \in \tilde{\mathcal{K}}$ , let  $w(z)$  be the word  $w$  rewritten in the alphabet  $\mathcal{A}(z)$ . Let  $w_1, w_2, w_3, w_4$  be words over  $\{a_1, \dots, a_{\bar{m}}\}$ , let  $j = 1, \dots, N$ . Denote the word

$$w_1(\overleftarrow{L}_j) L_j w_2(L_j) P_j w_3(P_j) R_j w_4(R_j)$$

by  $W_j = W_j(w_1, w_2, w_3, w_4)$ . Denote the word

$$K_1 W_1 K_2^{-1} W_2^{-1} \dots K_N^{-1} W_N^{-1}$$

by  $\Sigma(w_1, w_2, w_3, w_4)$ . Let the word  $\bar{\Sigma}(w_1, w_2, w_3, w_4)$  be obtained from  $\Sigma(w_1, w_2, w_3, w_4)$  by replacing  $W_1$  with  $L_1 P_1 R_1$ , and adding  $\bar{\cdot}$  to all letters. Finally for every  $i \in \{1, 2, 3, 4, 5\}$  and  $r \in \bar{\mathcal{E}}$  let  $\Sigma_{r,i}(w_1, w_2, w_3, w_4)$  be the word  $\Sigma(w_1, w_2, w_3, w_4)(r, i)$  and  $\bar{\Sigma}_{r,i}(w_1, w_2, w_3, w_4)$  be the word  $\bar{\Sigma}(w_1, w_2, w_3, w_4)(r, i)$ .

Notice that if  $w_1, w_2, w_4$  are positive words (we do not care about  $w_3$ ) then the word  $\Sigma_{r,i}(w_1, w_2, w_3, w_4) K_1(r, i)$  (see the definition of  $U(r, i)$  in 2.3) is admissible for  $\mathcal{S}$  for every  $r, i$ . The word  $\bar{\Sigma}_{r,i}(w_1, w_2, w_3, w_4) \bar{K}(r, i)$  is admissible for  $\bar{\mathcal{S}}$  for every  $w_1, w_2, w_3, w_4, r, i$ .

**Lemma 3.4.** *Preserving the notation from Definition 3.1, suppose that  $w_1, w_2, w_4$  are positive words. Let  $j \in \{1, \dots, N\}$ ,  $r \in \bar{\mathcal{E}}$ ,  $i \in \{1, 2, 3, 4, 5\}$ ,  $W = W_j(r, i)$ , and  $\tau$  is applicable to  $W$ . Then there exist words  $X_1, X'_1, X_2$ , and  $X'_2$  in the alphabet  $\mathcal{X}(\tau)$ , depending on  $w_1, w_2, w_4$  (but not on  $w_3$ ) such that*

$$a) X_1 W X'_1 = \alpha_\tau(W);$$

b)  $X_2WX'_2 = \alpha_{\tau^{-1}}(W)$ ;

c) the words  $X_1$  and  $X_2$  contain only letters from the  $\mathcal{X}(\overleftarrow{L}_j, \tau)$ , the words  $X'_1, X'_2$  contain letters only from  $\mathcal{X}(R_j, \tau)$ .

The lengths of  $X_i, X'_i$  ( $i = 1, 2$ ) are bounded by a recursive function in  $|w_1| + |w_2| + |w_4|$  (in fact it does not exceed  $4^{|w_1|+|w_2|+|w_4|+1}$ ).

*Proof.* The statement immediately follows from relations (2.8).  $\square$

**Lemma 3.5.** a) In the above notation, suppose that  $w_1, w_2, w_4$  are positive words,  $r \in \bar{\mathcal{E}}, i \in \{1, 2, 3, 4, 5\}$ . And suppose that  $\tau \in \mathcal{S}$  is applicable to

$$\Sigma_{r,i}(w_1, w_2, w_3, w_4)K_1(r, i),$$

$\tau$  changes the coordinates  $(r, i)$  into  $(r', i')$ . Then, by (2.6) - (2.9),

$$X^{-1}\Sigma_{r,i}(w_1, w_2, w_3, w_4)XK_1(r', i') = (\Sigma_{r,i}(w_1, w_2, w_3, w_4)K_1(r, i)) \circ \tau$$

for some word  $X = X_1\theta X_2$  where  $X_1$  and  $X_2$  are words in  $\mathcal{X}(\tau)$ , whose lengths are bounded by a recursive function on  $|w_1| + |w_2| + |w_4|$ ,  $\theta \in \Theta(\tau, (K_1)_-)$ .

b) Suppose that  $w_1, w_2, w_3, w_4$  are arbitrary words, and  $\tau$  is applicable to

$$\bar{\Sigma}_{r,i}(w_1, w_2, w_3, w_4)\bar{K}_1(r, i).$$

Then for some  $\theta \in \bar{\Theta}(\tau, (K_1)_-)$  we have

$$\theta^{-1}\bar{\Sigma}_{r,i}(w_1, w_2, w_3, w_4)\theta\bar{K}_1(r', i') = (\bar{\Sigma}_{r,i}(w_1, w_2, w_3, w_4)\bar{K}_1(r, i)) \circ \tau.$$

*Proof.* a) Fix a number  $j$  between 1 and  $N$ . Let  $K = \overleftarrow{L}_j(r, i)$ ,  $K' = \overrightarrow{R}_j(r, i)$ . Since  $\tau$  is applicable to  $\Sigma_{r,i}(w_1, w_2, w_3, w_4)K_1(r, i)$ , it is applicable to  $KW_j(w_1, w_2, w_3, w_4)K'$ . Hence by Lemma 3.4 a), there exist words  $X_j, X'_j$  in the alphabets  $\mathcal{X}(K_j, \tau)$  and  $\mathcal{X}(R_j, \tau)$  respectively such that

$$X_jKW_jK'X'_j = K\alpha_\tau(W_j)K'. \quad (3.10)$$

The words  $X_j$  and  $X'_j$  depend only on  $w_1, w_2, w_4$  and  $\tau$ . So all  $X_j$  (resp.  $X'_j$ ),  $j = 1, \dots, N$ , are copies of each other. The word  $X_j$  contains letters from the set  $\mathcal{X}(K_-, \tau)$  only, the word  $X'_j$  contains letters from  $\mathcal{X}(K', \tau)$  only. Hence by relations (2.9) we have

$$KX_j = X_{j-1}K, \quad (X'_j)^{-1}K' = K'(X'_{j+1})^{-1}. \quad (3.11)$$

Combining (3.10) with (3.11) and using the definition of the word  $\Sigma_{r,i}(w_1, w_2, w_3, w_4)$ , we get

$$X_N^{-1}\Sigma_{r,i}(w_1, w_2, w_3, w_4)X_NK_1(r, i) = \alpha_\tau(\Sigma_{r,i}(w_1, w_2, w_3, w_4))K_1(r, i). \quad (3.12)$$

Now using Lemma 3.3, relation (2.6), and the fact that  $u(K_1) = v(K_1) = \emptyset$  (Remark 2.1) we deduce that

$$\theta^{-1}\alpha_\tau(\Sigma_{r,i}(w_1, w_2, w_3, w_4))\theta K_1(r', i') = \alpha_{\tau^{-1}}(\Sigma_{r,i}(w_1, w_2, w_3, w_4)K_1(r, i) \circ \tau) \quad (3.13)$$

where  $\theta = \theta(\tau, (K_1)_-)$ .

Now using Lemma 3.4 b), c), we deduce (similarly to (3.12)) that for some word  $Y_N$  in  $\mathcal{X}((K_1)_-, \tau)$ , we have

$$Y_N^{-1}\alpha_{\tau^{-1}}(\Sigma_{r',i'}(w_1, w_2, w_3, w_4) \circ \tau)Y_N K_1(r', i') = (\Sigma_{r,i}(w_1, w_2, w_3, w_4)K_1(r, i) \circ \tau). \quad (3.14)$$

Finally combining (3.12), (3.13) and (3.14), we deduce statement a) of the lemma with  $X = X_N\theta Y_N$ .

Statement b) immediately follows from Lemma 3.3 b).  $\square$

Let  $\mathcal{H}_0$  be the group given by all defining relations of  $\mathcal{H}$  except for the hub  $\Sigma$ .

**Lemma 3.6.** *Assume a positive word  $w' = w'(a_1, \dots, a_{\bar{m}})$  can be obtained from a positive word  $w$  by an insertion (deletion) of a word  $r \in \bar{\mathcal{E}}$ . Then the words  $\Sigma(w)$  and  $\Sigma(w')$  are conjugate in the group  $\mathcal{H}_0$ . There is an annular diagram for this conjugacy without  $\bar{\theta}$ -cells, in which the contours  $p$  and  $p'$  can be connected by a path whose length is bounded by a recursive function of  $|w| + |w'|$ .*

*Proof.* Indeed, by Lemma 2.3 there exists a word  $h$  in the alphabet  $\mathcal{S}$  which is applicable to  $\Sigma(w)K_1(\emptyset, 1)$  and such that

$$(\Sigma K_1(\emptyset, 1)) \circ h = \Sigma(w')K_1(\emptyset, 1).$$

The length of  $h$  is bounded by a recursive function of  $|w| + |w'|$ .

Notice that for every words  $w_1, w_2, w_3, w_4$  where  $w_1, w_2, w_4$  are positive and for every rule  $\tau$  applicable to  $\Sigma_{r,i}(w_1, w_2, w_3, w_4)K_1(r, i)$ , the word  $\Sigma_{r,i}(w_1, w_2, w_3, w_4)K_1(r, i) \circ \tau$  also has the form  $\Sigma_{r',i'}(w'_1, w'_2, w'_3, w'_4)K_1(r', i')$  for some  $w'_1, w'_2, w'_3, w'_4, r', i'$ . Now the statement of the lemma follows by  $|h|$  applications of Lemma 3.5 a).  $\square$

**Lemma 3.7.** *Assume a reduced word  $w' = w'(a_1, \dots, a_{\bar{m}})$  is freely equal to a product  $wqrq^{-1}$ ,  $r \in \mathcal{R}$ . Then the words  $\bar{\Sigma}(w)$  and  $\bar{\Sigma}(w')$  are conjugate in  $\mathcal{H}_0$ . There is an annular diagram over  $\mathcal{H}_0$  without  $\theta$ -cells for this conjugacy, in which the contours  $p$  and  $p'$  can be connected by a path whose length is bounded by a linear function of  $|w| + |w'| + |q|$ .*

*Proof.* The proof is completely analogous to the proof of Lemma 3.6  $\square$

**Lemma 3.8.** a) *For every positive word  $w$  in the alphabet  $\{a_1, \dots, a_{\bar{m}}\}$  which is equal to 1 in  $\bar{\mathcal{G}}$  the word  $\Sigma(w)$  is a conjugate of the hub  $\Sigma$  in  $\mathcal{H}_0$ . The length of the conjugating word is a bounded by a recursive function in  $|w|$ . The corresponding annular diagram does not contain  $\bar{\theta}$ -cells.*

b) *For every word  $w$  in the alphabet  $\{a_1, \dots, a_{\bar{m}}\}$  which is equal to 1 in  $\bar{\mathcal{G}}$ , the word  $\bar{\Sigma}(w)$  is a conjugate of  $\Sigma$  in  $\mathcal{H}_0$ . The length of the conjugating word is a bounded by a recursive function in  $|w|$ . The corresponding annular diagram does not contain  $\theta$ -cells.*



*Proof.* It immediately follows from Lemmas 2.1, 3.6, 3.7 and the solvability of the word problem in  $\bar{\mathcal{G}}$ .  $\square$

**Lemma 3.9.** *a) The map  $a_1 \rightarrow a_1(P_1)$ ,  $a_2 \rightarrow a_2(P_1)$ , ...,  $a_m \rightarrow a_m(P_1)$  extends to an injective homomorphism from  $\mathcal{G}$  into  $\mathcal{H}$ .*

*b) For every word  $w$  over  $a_1, \dots, a_m$  which is equal to 1 in  $\mathcal{G}$ , there exists a van Kampen diagram  $\Delta$  over the presentation  $\mathcal{R}$  of  $\mathcal{H}$  with boundary label  $w$  and the number of cells bounded by a recursive function in  $|w|$ .*

*Proof.* a) Let  $w \in \mathcal{E}$ . Then  $w = \bar{w}$  (because we agreed to identify  $a_i$  with  $\bar{a}_i$ ,  $i = 1, \dots, m$ ). By Lemma 3.8, both words  $\Sigma(w)$  and  $\bar{\Sigma}(w)$  are conjugated to  $\Sigma = 1$  in  $\mathcal{H}$ . These words differ only by the subword  $w(P_1)$  (i.e.  $\Sigma(w)$  is obtained from  $\bar{\Sigma}(w)$  by inserting  $w(P_1)$ ). Hence  $w(P_1) = 1$  in  $\mathcal{H}$ . Thus the map  $a_i \rightarrow a_i(P_1)$  extends to a homomorphism from  $\mathcal{G}$  to  $\mathcal{H}$ .

Since  $\mathcal{G}$  is a subgroup of  $\bar{\mathcal{G}}$ , this homomorphism is injective by Lemma 3.1.

b) This statement immediately follows from Lemmas 2.1 and 3.8.  $\square$

### 3.3 Bands and annuli

Let  $s^{\pm 1}$  be a letter, and  $S$  be a set of letters. We call a cell (edge)  $s$ -cell ( $s$ -edge) or  $S$ -cell ( $S$ -edge) provided its label contains a letter  $s^{\pm 1}$  or a letter from  $S \cup S^{-1}$ , respectively. If a cell is both  $S_1$ -cell and  $S_2$ -cell, we call it a  $(S_1, S_2)$ -cell.

For example any cell corresponding to one of the relations (2.6), (2.7) is a  $\Theta(\tau)$ -cell.

For  $z \in \{K, L, P, R\}$ , we shall call a cell a  $z$ -cell or  $z_j$ -cell if it is a  $z_j(r, i)$ -cell for some  $j, r, i$ . Similarly we define  $\bar{z}$ -cells.

For simplicity we shall call an  $\mathcal{A} \cup \bar{\mathcal{A}}$ -edge, (letter, cell) as an  $a$ -edge (letter, cell), a  $\Theta \cup \bar{\Theta}$ -edge (letter, cell) as  $\theta$ -edge (letter, cell), an  $\mathcal{X}$ -edge (letter, cell) as an  $x$ -edge (letter, cell), and  $\mathcal{K} \cup \bar{\mathcal{K}}$ -edge (letter, cell)  $k$ -edge (letter, cell). Thus we can use such notions as  $(a, x)$ -cell,  $(k, x)$ -cell,  $(\theta, a)$ -cell and  $(\theta, k)$ -cell.

As in [OlSa2], we enlarge the set of defining relations of the group  $\mathcal{H}$  by adding some consequences of defining relations. Namely, by Lemma 3.9, we can include all cyclically reduced relations of the copy of the group  $\mathcal{G}$  generated by the set  $\{a_1(P_1), \dots, a_m(P_1)\}$ , i.e. all cyclically reduced words in  $\{a_1(P_1), \dots, a_m(P_1)\}$  which are equal to 1 in the copy of  $\mathcal{G}$ . These relations will be called  $\mathcal{G}$ -relations. The cells corresponding to  $\mathcal{G}$ -relations will be called  $\mathcal{G}$ -cells.

We denote by  $\mathcal{H}_1$  the group given by all generators of  $\mathcal{H}$ , by all  $\mathcal{G}$ -relations, and by all defining relations of  $\mathcal{H}$ , except for the hub  $\Sigma$ .

The new, expanded, set of relations of  $\mathcal{H}$  will be denoted by  $\mathcal{R}'$ .

It is convenient to turn  $\mathcal{R}'$  into a *graded presentation*.

A hub is “higher” than  $(\Theta, k)$ -cells corresponding to (2.6). (We also say that the *rank* of a hub is greater than the rank of  $(\Theta, k)$ -cell.) In turn,  $(\Theta, k)$ -cells are “higher” than  $(\bar{\Theta}, \bar{k})$ -cells, which are “higher” than  $\mathcal{G}$ -cells which are “higher” than  $(\Theta, a)$ -cells and  $(\bar{\Theta}, \bar{a})$ -cells which are “higher” than  $x$ -cells corresponding to relations (2.9), (2.8). The  $(\Theta, k)$  and  $(\bar{\Theta}, \bar{k})$ -relations are also stratified: we set that relations (2.6) corresponding to rules  $\tau$  from connecting steps (12), (34), (51) are “higher” than others.

If  $\Delta$  and  $\Delta'$  are diagrams over  $\mathcal{R}'$  then we say that  $\Delta$  has a higher *type* than  $\Delta'$ , if  $\Delta$  has more hubs, or the numbers of hubs are the same, but  $\Delta$  has more cells which are next in the hierarchy, etc.

It is obvious, that in this way we define a partial quasi-order (a transitive reflective relation) on the set of diagrams over  $\mathcal{R}'$ , and that this partial quasi-order satisfies the descending chain condition, so we can consider type as an inductive parameter.

A diagram  $\Delta$  that has the smallest type among all diagrams with the given boundary label (boundary labels, in the annular case), then  $\Delta$  is called a *minimal* diagram. The following lemma is obvious (see Figure 10).

**Lemma 3.10.** *Assume a diagram  $\Delta$  over  $\mathcal{H}$  has two cells  $\Pi$  and  $\Pi'$  of the same rank  $\rho$  such that words  $V$  and  $V'$  can be read on the boundary paths  $\partial\Pi$  and  $\partial\Pi'$  when going around the cells in opposite directions from vertices  $o$  and  $o'$ . Assume further that there is a path  $p = o - o'$  in  $\Delta$  with no self-intersections,  $\phi(p) = U$ , and there exists a diagram with boundary label  $UV'U^{-1}V^{-1}$  containing at most one cell of rank  $\rho$  and some cells of smaller ranks. Then the number of cells of rank  $\rho$  in  $\Delta$  can be decreased, while the boundary label (boundary labels, in the annular case) and numbers of cells of higher ranks are preserved. In particular  $\Delta$  is not a minimal diagram.*

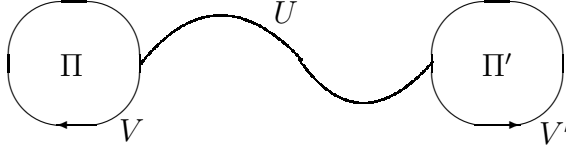

Figure 10.

We say that an annular diagram  $\Gamma$  over  $\mathcal{H}_1$  is *compressible* if

- (1) It contains no hubs, and there are no  $\theta$ -edges on its boundary, and
- (2) There exists another annular diagram  $\Gamma'$  which
  - (a) has no hubs and has the same boundary labels as  $\Gamma$ ,
  - (b) the type of  $\Gamma'$  is smaller than the type of  $\Gamma$ , and these types differ already by the number of  $\theta$ -cells, and
  - (c)  $\Gamma'$  has no  $(\bar{\Theta}, k)$ -cells if  $\Gamma$  has no  $(\bar{\Theta}, k)$ -cells.

By definition, a diagram  $\Delta$  is *not reduced* if either

- (i)  $\Delta$  contains a *reducible* pair of cells having a common edge  $o - o'$  and boundary labels  $w$  and  $w^{-1}$  (read starting at the common vertex  $o$ ) or
- (ii)  $\Delta$  contains a pair of  $(k, \Theta)$ -cells like in Lemma 3.10 where  $V' \equiv V^{-1}$  and  $U$  is a word in  $\mathcal{A}(P_1)$  which is equal to 1 modulo  $\mathcal{G}$ -relations, or
- (iii)  $\Delta$  contains a pair of  $\mathcal{G}$ -cells, and a connecting path  $p$  like in Lemma 3.10, where the label  $U$  of  $p$  is a word in  $\theta(\tau, P_1)$ -letters commuting with letters from  $\mathcal{A}(P_1)$  by relations (2.7) or

- (iv)  $\Delta$  is an annular diagram and contains a compressible annular subdiagram surrounding the hole.

It is easy to see that every non-reduced diagram is not minimal. In case (iii), for example, the word  $U$  commutes with all  $\mathcal{A}(P_1)$ -letters by relations (2.7), hence the subdiagram consisting of the two  $\mathcal{G}$ -cells and the connecting path can be replaced by a subdiagram having at most one  $\mathcal{G}$ -cell and several commutativity  $(\Theta, a)$ -cells. In case (iv), the annular subdiagram can be replaced by an annular diagram of a smaller type with the same boundary labels.

Of course, a diagram is said to be *reduced* if it is not non-reduced. Thus every minimal diagram is reduced (but the converse is not necessarily true).

As in our previous papers (see [OlSa2]), it is convenient to study properties of diagrams using bands. Let us fix a point  $o_\Pi$  inside every cell  $\Pi$  and some point  $o_\Delta$  on the plane outside the diagram (or two points  $o$  and  $o'$  in each of two components of the complement of  $\Delta$  on the plane, in the annular case). Similarly we fix points  $o_e$  inside every edge  $e$  of diagram  $\Delta$ . In the case when  $e$  is an edge on  $\partial(\Pi)$  (on  $\partial(\Delta)$ ), we fix a simple Jordan curve  $l(\Pi, e)$  (respectively  $l(\Delta, e)$ ) that connects the vertex  $o_\Pi$  ( $o_\Delta$ ) with  $o_e$  and has no other common points (except for  $o_e$ ) with the edges of the diagram  $\Delta$ . We also require that  $l(\Pi, e)$  and  $l(\Pi, e')$  have the only common point  $o_\Pi$  for  $e \neq e'$ . The similar requirement concerns the lines  $l(\Delta, e)$ .

Let  $S$  be a set of letters and let  $\Delta$  be a van Kampen diagram. Fix pairs of  $S$ -edges on the boundaries of some cells from  $\Delta$  (we assume that each of these cells has exactly two  $S$ -edges).

Suppose that  $\Delta$  contains a sequence of cells  $(\pi_1, \dots, \pi_n)$  such that for each  $i = 1, \dots, n - 1$  the cells  $\pi_i$  and  $\pi_{i+1}$  have a common  $S$ -edge  $e_i$  and this edge belongs to the pair of  $S$ -edges fixed in  $\pi_i$  and  $\pi_{i+1}$ . Let  $e$  be the other  $S$ -edge ( $\neq e_1$ ) of  $\pi_1$ , and let  $f$  be the other  $S$ -edge ( $\neq e_{n-1}$ ) of  $\pi_n$ . Consider the line which is the union of the lines  $l(\pi_i, e_i)$  and  $l(\pi_{i+1}, e_i)$ ,  $i = 1, \dots, n - 1$ , together with  $l(\pi_1, e)$  and  $l(\pi_n, f)$ . This broken line is called the *median* of this sequence of cells. Then our sequence of cells  $(\pi_1, \dots, \pi_n)$  with common  $S$ -edges  $e_1, \dots, e_{n-1}$ , and distinguished edges  $e, f$ , is called an  *$S$ -band* (with start edge  $e$  and end edge  $f$ ) if the median is an absolutely simple curve or an absolutely simple closed curve (see Fig. 11).

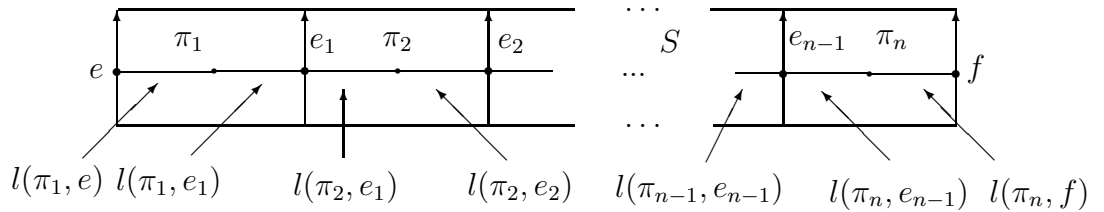

Fig. 11.

A band is said to be a  *$k$ -band* ( *$\theta$ -band*,  *$a$ -band*) if  $S$  consists of  $k$ -letters ( $\theta$ -letters,  $a$ -letters). Similarly, a band is an  *$a_i(z)$ -band* (a  *$z_j$ -band*) if  $S$  consists of one  $a$ -letter  $a_i(z)$  (of  $z_j(r, i)$ - and  $z_j(r, i)$ -letters) for  $z \in \tilde{\mathcal{K}}$ .

Notice that an  $S$ -band may contain no cells. In this case the band is called *empty*.

We say that two bands *cross* if their medians cross. We say that a band is an *annulus* if its median is a closed curve. In this case the first and the last cells of the band coincide. (see Fig. 12a).

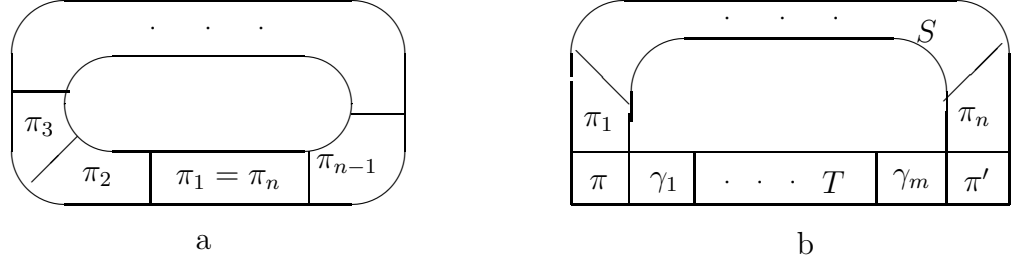

Fig. 12.

Let  $\mathcal{B}$  be an  $S$ -band with common  $S$ -edges  $e_1, e_2, \dots, e_n$  which is not an annulus. Then the first cell has an  $S$ -edge  $e$  which forms a pair with  $e_1$  and the last cell of  $\mathcal{B}$  has an edge  $f$  which forms a pair with  $e_n$ . Then we shall say that  $e$  is the *start edge* of  $\mathcal{B}$  and  $f$  is the *end edge* of  $\mathcal{B}$ . If  $p$  is a path in  $\Delta$  then we shall say that a band starts (ends) on the path  $p$  if  $e$  (resp.  $f$ ) belongs to  $p$ .

Let  $S$  and  $T$  be two disjoint sets of letters, let  $(\pi, \pi_1, \dots, \pi_n, \pi')$  be an  $S$ -band and let  $(\pi, \gamma_1, \dots, \gamma_m, \pi')$  is a  $T$ -band. Suppose that:

- the parts of the medians of these bands lying between their intersections, form a simple closed curve,
- on the boundary of  $\pi$  and on the boundary of  $\pi'$  the pairs of  $S$ -edges separate the pairs of  $T$ -edges,
- the start and end edges of these bands are not contained in the region bounded by the medians of the bands.

Then we say that these bands form an  $(S, T)$ -annulus and the simple curve formed by the medians of these bands is the *median* of this annulus (see Fig. 12b). Fig. 13 shows that a multiple intersection of an  $S$ -band and a  $T$ -band does not necessarily produce an  $(S, T)$ -annulus. Again, for simplicity, we say that this annulus is a  $(\theta, k)$ -annulus, if  $S$  is a  $\theta$ -band and  $T$  is a  $k$ -band. Similarly, the notion of a  $(\theta, a)$ -annulus is defined.

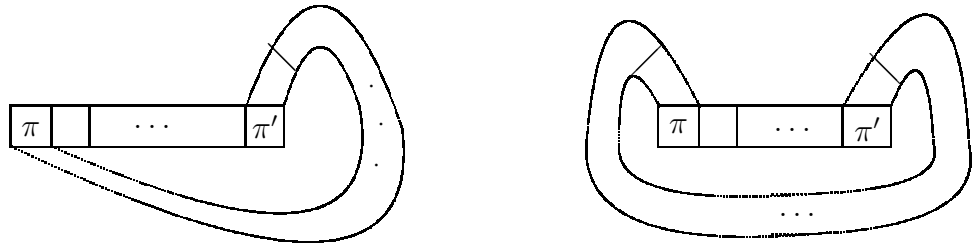

Fig. 13.

If  $\ell$  is the median of an  $S$ -annulus or an  $(S, T)$ -annulus then the maximal subdiagram of  $\Delta$  contained in the region bounded by  $\ell$  is called the *inner diagram* of the annulus.

The union of cells of an  $S$ -band  $\mathcal{B}$  forms a subdiagram. The reduced boundary of this diagram, which we shall call the *boundary of the band*, has the form  $e^{\pm 1} p f^{\pm 1} q^{-1}$  (recall that we trace boundaries of diagrams clockwise). Then we say that  $p$  is the *top path* of  $\mathcal{B}$ , denoted by  $\mathbf{top}(\mathcal{B})$ , and  $q$  is the *bottom path* of  $\mathcal{B}$ , denoted by  $\mathbf{bot}(\mathcal{B})$ .

We shall call an  $S$ -band *maximal* if it is not contained in any other  $S$ -band. If an  $S$ -band  $\mathcal{W}$  starts on the contour of a cell  $\pi$ , does not contain  $\pi$  and is not contained in any other  $S$ -band with these properties then we call  $\mathcal{W}$  a *maximal  $S$ -band starting on the contour of  $\pi$* .

We now list all types of bands in diagrams over the presentation  $\mathcal{R}'$ , that will be considered further.

1. By definition, any  $\Theta$ -cell can be included in a  $\Theta$ -band ( $\Theta$ -annulus) of a diagram  $\Delta$  over  $\mathcal{R}'$ . The cells in these bands correspond to the relations (2.6), (2.7). Similarly  $\bar{\Theta}$ -bands and  $\theta$ -bands are defined.

It is easy to see from (2.6) and (2.7) that if a  $\theta$ -band contains a  $\theta(\tau, z)$ -cell, for some  $\tau \in \mathcal{S} \cup \bar{\mathcal{S}}$ , then all cells in that band correspond to the same rule  $\tau$ . Thus we can talk about  $\Theta(\tau)$ -bands and  $\bar{\Theta}(\tau)$ -bands. Since every  $\theta$ -cell has two  $\theta$ -edges, any maximal  $\theta$ -band, which is not an annulus, must start on a boundary edge of the diagram.

2. By definition, an  $a_j(z)$ -band, where  $z \in \tilde{\mathcal{K}}$ ,  $a_j \in \mathcal{A} \cup \bar{\mathcal{A}}$ , is constructed of  $(a_j(z), \theta)$ -cells and  $(a_j(z), x)$ -cells (see relations (2.7), (2.8)).

These bands can start and end on the boundary of a diagram, on  $(\theta, k)$ -cells and on  $\mathcal{G}$ -cells. Thus, an  $a$ -band is a  $a_j(z)$ -band for some  $j, z$ .

3. For every  $k \in \tilde{\mathcal{K}}$ , a  $k$ -band is constructed of  $(z, \theta)$ - and  $(z, x)$ -cells where  $z \in \mathcal{K} \cup \tilde{\mathcal{K}}$  and  $z$  projects onto  $k$  (see 2.3). These bands can start and end on the boundary of the diagram or on hubs.

Notice that the reducibility of the top and the bottom labels of a  $\theta$ -band can be easily achieved without changing the boundary or the type of the diagram (see [SBR]).

Indeed, if the label of the path  $\mathbf{bot}(\mathcal{B})$  is not reduced then it contains a subpath  $e_1 e_2$  where  $e_1, e_2$  are edges labelled by  $a$  and  $a^{-1}$  respectively, where  $a$  is a letter. These two edges must belong to two different cells  $\pi_1$  and  $\pi_2$  of  $\mathcal{B}$  as in the diagram on the left in the Figure 14.

Then we fold  $e_1$  and  $e_2$ , producing a new edge  $e$  labelled by  $a$  and we introduce a new edge  $f$  with label  $a$  which has a common end vertex with  $e$  so that cells  $\pi_1$  and  $\pi_2$  have a common edge  $e$ . The other cells which were attached to  $e_1$  and  $e_2$  will be attached to the edge  $f$ . The bottom path of the  $\theta$ -band  $\mathcal{B}$  in the new diagram is shorter (by two edges) than the bottom path of  $\mathcal{B}$  in  $\Delta$ . The bottom paths of the other  $\theta$ -bands are not affected by this operation. Thus after a finite number of such operations we get a diagram with the same boundary label as  $\Delta$ , in which all bands  $\mathcal{B}$  have top and bottom paths with reduced labels.

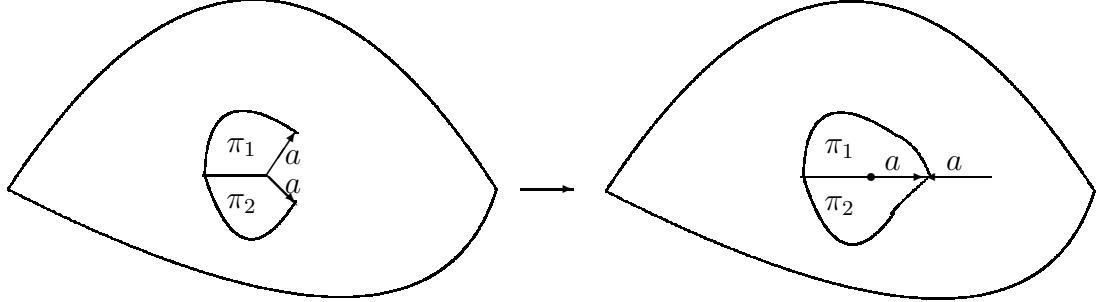

Figure 14.

Thus we will change the definition of reduced diagrams by demanding in addition that the top and bottom labels of any  $\theta$ -band in a reduced diagram are reduced words.

### 3.4 Forbidden annuli

Similarly to [OlSa2], [OlSa1] the absence of annuli of various kinds in reduced diagrams without hubs is important in our present considerations. The following lemma is similar to Lemma 3.1 of [OlSa1].

**Lemma 3.11.** *Let  $\Delta$  be a reduced (in particular, a minimal) van Kampen diagram over the group  $\mathcal{H}_1$ . Then  $\Delta$  has no*

- (1)  $\theta$ -annuli;
- (2)  $k$ -annuli;
- (3)  $a$ -annuli;
- (4)  $(\theta, k)$ -annuli;
- (5)  $(\theta, a)$ -annuli;

*Proof.* We prove the lemma by contradiction. Let us choose a minimal annulus  $\mathcal{T}$  in  $\Delta$  among all counterexamples to any of the assertions (1) - (5). Here “minimal” means that the inner subdiagram of the annulus is of the smallest possible type.

Let  $\mathcal{T}$  be a  $\theta$ -annulus. Suppose it contains a  $(\theta, k)$ -cell. Notice that in every  $(\theta, k)$ -cell the pair of  $\theta$ -edges separates cyclically the pair of  $k$ -edges. Hence both top and bottom sides of  $\mathcal{T}$  contain  $k$ -edges. Thus the inside subdiagram of  $\mathcal{T}$  contains a  $k$ -band starting on the top or bottom of  $\mathcal{T}$ . Since  $\Delta$  does not have hubs, there exists a maximal  $k$ -band  $\mathcal{L}$  starting and ending on the contour of the inside diagram. This gives rise to a  $(\theta, k)$ -annulus with a smaller inside subdiagram than  $\mathcal{T}$  which contradicts the choice of  $\mathcal{T}$  (as the smallest counterexample) and property (4) of the lemma. Hence all cells in  $\mathcal{T}$  are  $(\theta, a)$ -cells corresponding to the auxiliary relations (2.7).

Similarly, the inside subdiagram  $\Delta'$  of  $\mathcal{T}$  contains no  $k$ -edges. Hence the only possible cells in  $\Delta'$  where an  $a$ -band can end would be  $\mathcal{G}$ -cells (whose contours consist of  $a_i(P_1)$ -edges). Hence if  $\Delta'$  contains an  $a_i(z)$ -edge, and  $z \neq P_1$ , the maximal  $a_i(z)$ -band of  $\Delta'$  containing that cell must start and end on the boundary of  $\Delta'$ . This gives rise to a  $(\theta, a)$ -annulus ruled out by property (5) of the lemma. Thus all  $a$ -edges in  $\Delta'$  are  $\mathcal{A}(P_1)$ -edges. Hence all cells in  $\mathcal{T}$  are  $(\Theta, \mathcal{A}(P_1))$ -cells corresponding to relations (2.7). Notice that all these relations are commutativity relations because  $\alpha_{\tau-1}(a_i(P_1)) = \alpha_\tau(a_i(P_1)) = a_i(P_1)$ . Hence the labels of the top and the bottom paths of  $\mathcal{T}$  coincide which contradicts the assumption that  $\Delta$  is reduced (see part (iv) of the definition of non-reduced diagrams).

Now, let  $\mathcal{T}$  be a  $(\theta, k)$ -annulus,  $\mathcal{T}_\theta$  its  $\theta$ -band, and  $\mathcal{T}_k$  its  $k$ -band. We denote by  $\pi$  and  $\pi'$  their common cells, i.e. the *corner cells* of the annulus  $\mathcal{T}$ . The inner diagram  $\Gamma$  of  $\mathcal{T}$  is bounded by a path  $p_\theta p_k$  where  $p_\theta$  is a subpath of  $\partial(\mathcal{T}_\theta)$  and  $p_k$  is a subpath of  $\partial(\mathcal{T}_k)$ .

Property (4), which holds for smaller annuli, ensures that there are no  $\theta$ -edges in  $p_k$  and there are no  $k$ -edges in  $p_\theta$ . Hence every non-corner cell of  $\mathcal{T}_k$  is a cell corresponding to relations (2.9). There exist no such cells if  $\mathcal{T}_k$  is a  $P_j$ - or  $R_j$ -band for any  $j$ . Then  $\pi$  and  $\pi'$  must have a common  $k$ -edge. Moreover,  $\pi$  is a mirror copy of  $\pi'$ , since these cells belong to the same  $\theta$ -band  $\mathcal{T}_\theta$  as well. But this contradicts the assumption that the diagram  $\Delta$  is reduced. Hence we may assume that  $\mathcal{T}_k$  is neither  $P$ - nor  $R$ -band.

Since every non-corner cell of  $\mathcal{T}_k$  corresponds to (2.9), we have  $\phi(p_k) \equiv U$  where  $U$  is a word in  $\mathcal{X}$  (see relations (2.9)). If  $p_k$  contains  $a$ -edges of the corner cells, then we just make the path  $p_k$  shorter and make  $p_\theta$  longer, respectively, keeping the boundary path of  $\Gamma$  equal to  $p_\theta p_k$ .

Again, by (4), for smaller diagrams, every non-corner cell of  $\mathcal{T}_\theta$  is a  $(\theta, a)$ -cell, and the forms of relations (2.7), (2.6) show that  $\phi(p_\theta) \equiv \alpha_{\tau\pm 1}(V)$  for some  $V$  in  $a$ -letters. The word  $V$  has no letters from  $\mathcal{A}(P_1)$  because  $\pi$  and  $\pi'$  are neither  $P_1$ - nor  $R_1$ -cells.

The equality  $U\alpha_{\tau\pm 1}(V) = 1$  given by  $\Gamma$  holds over the group  $\mathcal{H}_2$  given by all the  $x$ -,  $k$ -, and  $a$ -generators, and  $x$ -relations (2.8) and (2.9) (but not (2.7)). Indeed, by statements (1) - (5) for smaller annuli,  $\Gamma$  may contain only cells corresponding to relations of  $\mathcal{H}_2$  and  $\mathcal{G}$ -cells. If we collapse all  $\mathcal{A}(P_1)$ -edges in  $\Gamma$ , we obtain a diagram over  $\mathcal{H}_2$  with the same boundary label (since  $\partial(\Gamma)$  does not contain  $\mathcal{A}(P_1)$ -edges). Thus we can assume that  $\Gamma$  does not contain  $\mathcal{G}$ -cells.

The group  $\mathcal{H}_2$  is a (multiple) HNN-extension of the free group generated by  $x$ -letters where non- $x$ -letters are stable. Hence  $V$  and  $\alpha_{\tau\pm 1}(V)$  are freely trivial words. Then so is the word  $U$ .

Since there are no reducible pairs of  $(k, x)$ -cells in  $\mathcal{T}_k$ , and  $U = 1$  in the free group, we see that  $\pi$  and  $\pi'$  must have a common  $k$ -edge, and we come to a contradiction as above.

Similar arguments work in other cases (see lemma 3.1 in [OISa1] and lemma 6.1 in [OI2] for details).  $\square$

### 3.5 Surgeries involving $\mathcal{G}$ -cells

As in our previous papers, we now describe certain surgeries which can be applied to a diagram to reduce its type.

**Lemma 3.12.** (1) **(Moving a  $\mathcal{G}$ -cell along an  $a$ -band.)** Assume  $\Delta$  is a van Kampen diagram formed by a  $\mathcal{G}$ -cell  $\Pi$  and an  $\mathcal{A}(P_1)$ -band  $\mathcal{T}$  attached to  $\Pi$  along an  $\mathcal{A}(P_1)$ -edge  $e$ . Let  $e^{-1}p$  and  $e q e' q'$  be clockwise contours of  $\Pi$  and  $\mathcal{T}$ , respectively, where  $e$  and  $e'$  are  $a$ -edges. Then there is a reduced diagram  $\Delta'$  with contour  $\tilde{p}\tilde{q}\tilde{e}'\tilde{q}'$ , where the labels of  $\tilde{p}, \tilde{q}, \tilde{e}', \tilde{q}'$  coincide with the labels of  $p, q, e', q'$ , respectively, such that  $\Delta'$  is formed by a copy  $\Pi'$  of the  $\mathcal{G}$ -cell  $\Pi$ , attached to  $\tilde{e}'$ , and by several  $(\Theta, \mathcal{A}(P_1))$ -cells.

(2) **(Merging two  $\mathcal{G}$ -cells connected by an  $a$ -band.)** Let  $\Delta$  be a van Kampen diagram consisting of two distinct  $\mathcal{G}$ -cells  $\Pi_1, \Pi_2$  and an  $a_i(P_1)$ -band  $\mathcal{T}$  connecting them. Then there is a reduced diagram  $\Delta'$  with the same boundary label, which has at most one  $\mathcal{A}$ -cell and several  $(\Theta, \mathcal{A}(P_1))$ -cells; and therefore the diagram  $\Delta$  is not reduced.

(3) There does not exist a reduced van Kampen diagram over  $\mathcal{H}_1$  which contains a  $\mathcal{G}$ -cell  $\Pi$  and an  $\mathcal{A}$ -band  $\mathcal{T}$  that starts and ends on  $\Pi$ .

*Proof.* (1) Consider the cell  $\pi_1$  of  $\mathcal{T}$  containing  $e$  in the boundary. By relations (2.7), the  $\Theta$ -letter  $\theta$  labelling two edges of  $\pi_1$ , commutes with all  $\mathcal{A}(P_1)$ -letters in  $\mathcal{H}_1$ . Hence  $\Pi$  can be surrounded by a  $\theta$ -annulus (i.e. there exists a  $\Theta$ -annulus containing  $\pi$  such that the boundary label of the internal subdiagram of this annulus coincides with the boundary label of  $\Pi$ , so we can glue the annulus around  $\Pi$ ). Next we can glue the resulting diagram inside a  $\Theta$ -annuli starting containing the second cell  $\pi_2$  of  $\mathcal{T}$ , and so on. Notice that the boundary labels of all diagrams constructed this way coincide with the boundary label of  $\Pi$  because all cells in the surrounding annuli are commutativity cells.

Thus, we obtain a diagram  $\Delta_0$  with the same boundary label as  $\Pi$ , such that  $\Delta_0$  contains attached to  $e'$ . This subdiagram can be replaced by a copy  $\Pi'$  of  $\Pi$ . Finally, to restore the boundary label of  $\Delta$ , we can attach a subdiagram  $\Gamma$  to  $\Pi'$ , where  $\Gamma$  is the mirror copy of  $\Delta_0 \setminus \Pi$ . The resulting diagram is what we need. Figure 15 illustrates the procedure used in this proof.

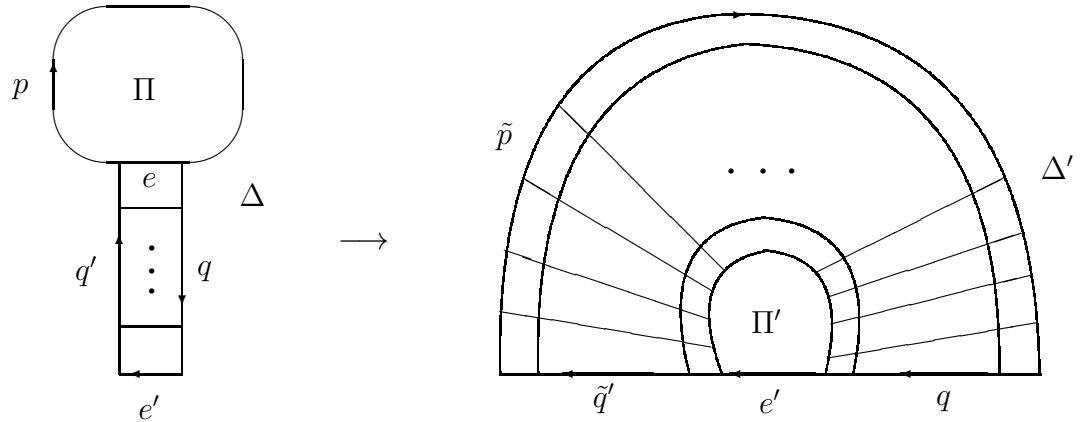

Figure 15.

(2) Indeed, the label of the top path of the connecting  $a$ -band commutes with all letters in  $\mathcal{A}(P_1)$ . Hence we can apply Lemma 3.10 (see also part (iii) of the definition of non-reduced diagrams).



(3) Proving by contradiction, consider the subdiagram  $\Gamma$  bounded by  $\partial(Pi)$  and  $\mathcal{T}$ . It follows from Lemma 3.11, that  $\Gamma$  has no cells except for  $\mathcal{G}$ -cells, and that  $|\mathcal{T}| = 0$ . If  $\Gamma$  contains a  $\mathcal{G}$ -cell, it can be merged with  $\Pi$ . If  $\Gamma$  does not contain cells, we obtain a contradiction with the assumption that the boundary label of  $\Pi$  is cyclically reduced.  $\square$

### 3.6 Shifting indexes

The following lemma utilizes the fact that our  $\mathcal{S}$ -machines work the same way in all parts of words  $\Sigma_{r,i}(w_1, w_2, w_3, w_4)$  between two consecutive  $K_j$ -letters.

Recall that every letter in the list of generators of  $\mathcal{H}$  has the form  $z(r, i)$  or  $a_i(z)$  or  $\theta(\tau, z)$ , or  $x(a_i(z), \tau)$  or is a  $\bar{\phantom{z}}$ -brother of such a letter, where  $z \in \{\bar{L}_j, L_j, P_j, R_j\}$ ,  $j = 1, \dots, N$ ,  $r \in \mathcal{E}$ ,  $i = 1, 2, 3, 4, 5$ . That  $j$  will be called the *index* of the letter. We say that a word  $W$  has index  $j$  if all letters in  $W$  have index  $j$ . If  $W$  has index  $j$  and  $j' = 1, \dots, N$ , then  $\varepsilon_{j'}(W)$  denotes the word  $W$  where the index  $j$  is replaced by  $j'$  in all letters. The word  $\bar{\varepsilon}_{j'}(W)$  coincides with  $\varepsilon_{j'}(W)$  if  $j' \neq 1$  and is obtained from  $\varepsilon_{j'}(W)$  by removing all  $\mathcal{A}$ -letters if  $j' = 1$ .

**Lemma 3.13.** *Suppose an equality  $W = 1$  holds in the group  $\mathcal{H}_1$  where  $W$  has index  $j \neq 1$  and has no  $\bar{\Theta}$ -letters,  $K_l$ -letters and  $\bar{K}_l$ -letters ( $l = 1, \dots, N$ ). Then  $\varepsilon_{j'}(W) = 1$  in  $\mathcal{H}_1$  for any  $j' = 1, \dots, N$ .*

*Proof.* Let  $\Delta$  be a minimal van Kampen diagram with boundary label  $W$ . By Lemma 3.11,  $\Delta$  has no  $\bar{\Theta}$ -edges since its boundary has no  $\bar{\Theta}$ -edges.

Similarly, the diagram  $\Delta$  does not contain  $K_l$ -edges and  $\bar{K}_l$ -edges for any  $l = 1, \dots, N$ , and if  $e$  is a  $z$ -edge in  $\Delta$ ,  $z \in \{L_{j_0}, P_{j_0}, R_{j_0}\}$ , then  $j_0 = j$ . Hence if a maximal  $\mathcal{A}(z)$ -band in  $\Delta$  terminates on a  $\Theta$ -cell inside  $\Delta$ , then  $z \in \{L_j, P_j, R_j\}$ .

Since all  $a$ -edges of the boundary of  $\Delta$  belong to  $\mathcal{A}(z) \cup \bar{\mathcal{A}}(z)$ ,  $z \in \{L_j, P_j, R_j\}$ , all  $a$ -edges inside  $\Delta$  must have labels from  $\mathcal{A}(z) \cup \bar{\mathcal{A}}(z) \cup \mathcal{A}(P_1) \cup \bar{\mathcal{A}}(P_1)$ . If  $\Delta$  contains  $\mathcal{A}(P_1) \cup \bar{\mathcal{A}}(P_1)$ -edges, it must contain  $\mathcal{G}$ -cells. By Lemma 3.12 (3) any  $a$ -band starting on any  $\mathcal{G}$ -cell must end on another  $\mathcal{G}$ -cell which by Lemma 3.12 (2), (3) contradicts minimality of  $\Delta$ . Hence  $\Delta$  does not contain  $\mathcal{G}$ -cells, and all  $a$ -edges of  $\Delta$  are  $\mathcal{A}(z) \cup \bar{\mathcal{A}}(z)$ -edges,  $z \in \{L_j, P_j, R_j\}$ .

Since every  $x$ -cell contains a  $\mathcal{A}$ -letter or a  $z$ -letter,  $z \in \mathcal{K}$  and the indexes of all letters in an  $a$ -cell (resp. a  $z$ -cell,  $z \neq K_l$ ), are the same, all labels of  $x$ -edges in  $\Delta$  have index  $j$ .

Thus the indexes of the labels of all edges in  $\Delta$  are equal to  $j$ . When we replace the index  $j$  by  $j'$  in all letters of  $\Delta$ , we obtain a new diagram  $\Delta'$  with boundary label  $\varepsilon_{j'}(W)$ . Since the  $\varepsilon_{j'}$  takes relations of  $\mathcal{H}_1$  without  $K_l$ -letters,  $\bar{K}_l$ -letters and  $\bar{\Theta}$ -letters to relations of  $\mathcal{H}_1$ , the diagram  $\Delta'$  is a van Kampen diagram over  $\mathcal{H}_1$ , so the equality  $\varepsilon_{j'}(W) = 1$  holds in  $\mathcal{H}_1$  as required.  $\square$

**Lemma 3.14.** *Suppose an equality  $W = 1$  holds in the group  $\mathcal{H}_1$ , where the word  $W$  has index  $j$  for some  $j \neq 1$  and does not contain  $\Theta$ -letters,  $K_l$ -letters, and  $\bar{K}_l$ -letters for any  $l = 1, \dots, N$ . Assume that a reduced van Kampen diagram over  $\mathcal{H}_1$  for the equality  $W = 1$  contains no  $(\mathcal{A}, \mathcal{X})$ -cells. Then  $\bar{\varepsilon}_{j'}(W) = 1$  in  $\mathcal{H}_1$  for any  $j' = 1, \dots, N$ .*

*Proof.* By Lemma 3.11,  $\Delta$  has no  $\bar{K}_l$ -edges and  $K_l$ -edges, since there are no such edges on the boundary of  $\Delta$ . Therefore the indexes of all labels of edges on the contour of every cell in  $\Delta$  are the same. Similarly, it does not contain  $\Theta$ -edges, and the labels of all  $\bar{\Theta}$ -edges in  $\Delta$  have index  $j$ .

Since every  $a$ -band in  $\Delta$  ends either on the boundary of  $\Delta$  or on a  $\bar{\Theta}$ -cell, all  $a$ -edges have index  $j$  and they are  $\bar{A}$ -edges. Similarly all  $x$ -edges in  $\Delta$  (if any) have index  $j$  as well.

Now if  $j' \neq 1$ , when we replace the index of every label in  $\Delta$  by  $j'$ , we get a van Kampen diagram over  $\mathcal{H}_1$  with boundary label  $\bar{\varepsilon}_{j'}(W)$  as required.

Let  $j' = 1$ . It is easy to see that when we apply  $\bar{\varepsilon}_1$  to every defining relation of  $\mathcal{H}_1$  occurring in  $\Delta$ , we get a relation of  $\mathcal{H}_1$  again. Hence if we apply  $\bar{\varepsilon}_1$  to all labels of  $\Delta$ , we obtain a van Kampen diagram over  $\mathcal{H}_1$  with boundary label  $\bar{\varepsilon}_1(W)$ , so  $\bar{\varepsilon}_1(W) = 1$  in  $\mathcal{H}_1$  as required.  $\square$

## 4 The group $\mathcal{H}_2$

Recall that  $\mathcal{H}_2$  is the auxiliary group given by all the  $x$ -,  $k$ -, and  $a$ -generators, and by  $x$ -relations (2.8) and (2.9) (but not (2.7)).

**Lemma 4.1.** *The word problem is solvable for the group  $\mathcal{H}_2$ .*

*Proof.* The group  $\mathcal{H}_2$  is an HNN-extension of the free group generated by  $x$ -letters where non- $x$ -letters are stable. The associated subgroups are either subgroups generated by  $\mathcal{X}(z)$ ,  $z \in \tilde{\mathcal{K}}$ , or subgroups generated by fourth powers of elements from  $\mathcal{X}(z)$ ,  $z \in \tilde{\mathcal{K}}$ . Hence the membership problem is decidable for all associated subgroups. So the claim of the lemma follows from Britton's lemma [LS].  $\square$

We say that a non-empty cyclically reduced word  $w$  is *uniform* if it is written in  $\mathcal{X}(z)$  for some  $z \in \tilde{\mathcal{K}}$ ,  $z \neq P_j$ . Two uniform words  $w_1$  and  $w_2$  are said to be *related* if one of them can be obtained from another one, by a sequence of substitutions of the following two forms, or their inverses:

- (1) Substitution  $x \rightarrow x^4$  applied to every letter of the word;
- (2) Every letter in the word is replaced by the corresponding letter in  $\mathcal{X}(z_-)$  if  $z, z_- \neq P_j$ .

It is obvious that the problem of whether two words in  $\mathcal{X}$  are related is decidable.

**Lemma 4.2.** *Let  $\mathcal{B}$  be an  $a$ - or a  $k$ -band in a diagram over  $\mathcal{H}_2$ . Then the label of the top (bottom) path of  $\mathcal{B}$  is a uniform word. The labels of the top and the bottom paths are related.*

*Proof.* This immediately follows from relations (2.8) and (2.9).  $\square$

**Lemma 4.3.** *Two non-empty cyclically reduced words  $w_1$  and  $w_2$  in  $\mathcal{X}$  are conjugate in  $\mathcal{H}_2$  if and only if one of them is a cyclic permutation of another one, or a cyclic shift of  $w_1$  and a cyclic shift of  $w_2$  are relative uniform words.*

*Proof.* The condition is sufficient for the conjugacy of  $w_1$  and  $w_2$  this follows from the conjugacy relations (2.8) and (2.9) in  $\mathcal{H}_2$ .

Now suppose that  $w_1$  and  $w_2$  are conjugate in  $\mathcal{H}_2$ . Consider a minimal annular diagram  $\Delta$  for the conjugacy of  $w_1$  and  $w_2$ ,  $w_1$  (resp.  $w_2$ ) is the label of the inner (outer) boundary of  $\Delta$ . We may assume that  $w_2$  is not a cyclic shift of  $w_1$ , and so the diagram  $\Delta$  contains cells. These cells belong to concentric  $a$ - and  $k$ -annuli  $\mathcal{B}_1, \dots, \mathcal{B}_d$ , counted where the inner boundary to the outer boundary of  $\Delta$ .

Therefore by Lemma 4.2 each of the words  $w_1, w_2$  must be uniform, being a side label of the annuli  $\mathcal{B}_1$  or of  $\mathcal{B}_d$ . Also by Lemma 4.2, a cyclic shift of  $w_1$  and  $w_2$  are related.  $\square$

**Lemma 4.4.** *The conjugacy problem is solvable in the group  $\mathcal{H}_2$ .*

*Proof.* It suffices to find an effective upper bound for the number of cells in an annular diagram  $\Delta$  over  $\mathcal{H}_2$ , in terms of the sum of lengths of the inner and outer boundaries  $p_1, p_2$  of  $\Delta$ .

By Lemma 4.1, we may assume that the boundary labels  $w_1 = \phi(p_1)$  and  $w_2 = \phi(p_2)$  of  $\Delta$  are non-empty words which have no pinches over the HNN-extension  $\mathcal{H}_2$ . This implies that there is no  $a$ - or  $k$ -band in  $\Delta$ , with both ends lying on  $p_1$  (resp. on  $p_2$ ). Indeed, otherwise there would exist a band  $\mathcal{B}$  with ends  $e_1, e_2$  lying, say, on  $p_1$ , such that, the bottom or the top of  $\mathcal{B}$  is a subpath of  $p_1$  (since each cell of  $\Delta$  belongs to a maximal  $a$ - or  $k$ -band); then label of this side of  $\mathcal{B}$  would be a pinch in  $w_1$ .

Obviously, Lemma 4.3 solves the conjugacy problem for words in  $\mathcal{X}$ . So we can assume that one of the words  $w_1$  or  $w_2$  contains non- $\mathcal{X}$ -letter. Hence every maximal  $a$ - and  $k$ -band of  $\Delta$  connects  $p_1$  with  $p_2$ .

Let us enumerate these ‘‘radial’’ bands cyclically (counter-clockwise):  $\mathcal{B}_1, \dots, \mathcal{B}_d$ . For each  $t = 1, \dots, d$ , the boundary of  $\mathcal{B}_t$  has the form  $e_t \mathbf{top}(\mathcal{B}_t) f_t^{-1} \mathbf{bot}(\mathcal{B}_t)^{-1}$ , where the start edge  $e_t$  belongs to  $p_1$ , the end edge  $f_t$  belongs to  $p_2$ .

Notice that the labels of the paths  $\mathbf{top}(\mathcal{B}_t)$  and  $\mathbf{bot}(\mathcal{B}_t)$  are reduced uniform words in  $\mathcal{X}$  by Lemma 4.2. Notice also that  $\phi(\mathbf{top}(\mathcal{B}_t))$  coincides with  $\phi(\mathbf{bot}(\mathcal{B}_{t+1}))$  (indices are taken modulo  $d$ ) except for some prefixes and suffixes whose total length is bounded from above by a constant  $c_0 = |w_1| + |w_2|$ . Thus, in particular,  $|\mathbf{bot}(\mathcal{B}_{t+1}) - \mathbf{top}(\mathcal{B}_t)| \leq c_0$ .

Relations (2.8) and (2.9) show that for every  $t = 1, \dots, d$  we have

$$|\mathbf{top}(\mathcal{B}_t)| = c_t |\mathbf{bot}(\mathcal{B}_t)|$$

where  $c_t \in \{1/4, 1, 4\}$ . If  $c_t = 1/4$ , we call the band  $\mathcal{B}_t$  *contracting*, if  $c_t = 4$ , we call it *expanding*.

Therefore,  $|\mathbf{top}(\mathcal{B}_{t+1})| = c_{t+1} |\mathbf{top}(\mathcal{B}_t)| + c'_{t+1}$  for some  $c'_{t+1} \leq c_0$ . Hence

$$|\mathbf{top}(\mathcal{B}_{t+2})| = c_{t+2} c_{t+1} |\mathbf{top}(\mathcal{B}_t)| + c_{t+2} c'_{t+1} + c'_{t+2}.$$

Continuing this way, we finally obtain

$$|\mathbf{top}(\mathcal{B}_1)| \leq 4^\sigma |\mathbf{top}(\mathcal{B}_1)| + c$$

where  $\sigma$  is the number of expanding bands minus the number of contracting bands among  $\mathcal{B}_1, \dots, \mathcal{B}_d$ , and  $c$  is some constant which is bounded by  $c_0(1 + 4 + \dots + 4^{d-1}) < c_0 4^d / 2$ .

If  $\sigma \neq 0$ , then  $|\mathbf{top}(\mathcal{B}_1)| \leq c_0 4^d / 2$ . Hence  $\mathbf{top}(\mathcal{B}_1)$  has a recursively bounded length (in terms of  $|w_1| + |w_2|$ ). Cutting  $\Delta$  along  $\mathbf{top}(\mathcal{B}_1)$ , we obtain an (ordinary, simply connected) van Kampen diagram  $\Gamma$  with perimeter recursively bounded in terms of  $|w_1| + |w_2|$ . Clearly,  $\Gamma$  is a minimal diagram over the presentation of  $\mathcal{H}_2$  (otherwise there would be another diagram  $\Gamma'$  with the same boundary label and a smaller type; by gluing together two copies of  $\mathbf{top}(\mathcal{B}_1)$  on the boundary of  $\Gamma'$ , we obtain an annular diagrams  $\Delta'$  with boundary labels  $w_1, w_2$ , whose type is smaller than that of  $\Delta$ , a contradiction). By Lemma 4.1 the number of cells in the diagram  $\Gamma$  is recursively bounded in terms of  $|w_1| + |w_2|$ . Since  $\Gamma$  and  $\Delta$  have the same number of cells, the number of cells in  $\Delta$  is recursively bounded.

Thus we may assume that  $\sigma = 0$ .

Let us choose an arbitrary vertex  $o = o_1$  on the path  $\mathbf{top}(\mathcal{B}_1)$  far enough from the initial and terminal vertices of  $\mathcal{B}_1$ . Here “enough” means “farther than some constant  $C > c_0$  whose value will become clear later”.

Denote by  $l_1 > C$  the distance from  $o_1$  to the initial vertex of  $\mathbf{top}(\mathcal{B}_1)$ . Since  $l_1 > c_0$ , the vertex  $o_1$  can be connected with a vertex  $o_2$  of the path  $\mathbf{top}(\mathcal{B}_2)$  by a path of the length at most 4 (going at most three edges along  $\mathbf{top}(\mathcal{B}_1)$  toward its initial vertex and then across the band  $\mathcal{B}_2$  along a connecting edge). Let  $l_2$  be the distance from  $o_2$  to the initial vertex of  $\mathbf{top}(\mathcal{B}_2)$ . It is clear that  $l_2 = c_2 l_1 + c_2''$  for some recursively bounded constant  $c_2''$ ,  $c_2 \in \{4, 1/4, 1\}$ . We can assume that  $C$  is big enough so that  $l_2 > c_0$ , so we can continue and find a vertex  $o_3$  on  $\mathbf{top}(\mathcal{B}_3)$  connected with  $o_2$  by a path of length at most 4. Thus we can construct a sequence of points  $o_i \in \mathbf{top}(\mathcal{B}_i)$ ,  $i = 1, \dots, d+1$  (where  $\mathcal{B}_{d+1} = \mathcal{B}_1$ ) and a path  $p$  connecting these points such that  $|p| \leq 4d$ , and the distance  $|l_{d+1} - l_1|$  from  $o_{d+1}$  to  $o_1$  on  $\mathbf{top}(\mathcal{B}_1)$  is equal  $4^\sigma l_1 + C'$  for some recursively bounded constant  $C'$  (see Figure 16). Let  $p'$  be the loop obtained by concatenation of  $p$  and a portion of  $\mathbf{top}(\mathcal{B}_1)$  between  $o_1$  and  $o_{d+1}$ . Since  $\sigma = 0$ , the length of  $p'$  is bounded by a constant  $C''$ .

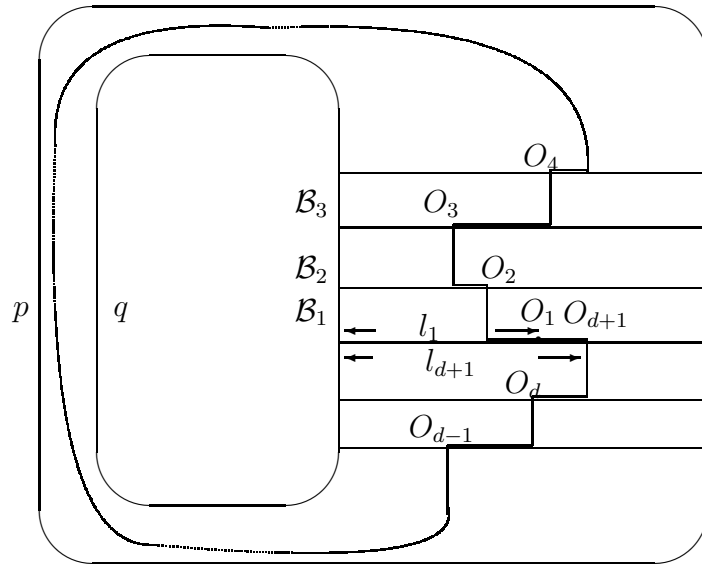

Figure 16.

If the length of  $\mathbf{top}(\mathcal{B}_1)$  is very large, then by choosing different starting points  $o_1$  on  $\mathbf{top}(\mathcal{B}_1)$ , we can build very many loops  $p'$  whose lengths are bounded by  $C''$ . Notice that since the process of building the loop  $p'$  starting at  $o_1$  is deterministic, if two of these loops share a common vertex, they will share all the vertices coming after that one. Hence if we take initial vertices of these loops sufficiently far apart (say, farther than  $2C''$ ), these loops won't intersect. The number of different labels of such loops is recursively bounded since their lengths are bounded. Hence if  $|\mathbf{top}(\mathcal{B}_1)|$  were bigger than that bound, two of the constructed paths would have the same labels. But this would contradict the minimality of  $\Delta$  (in fact  $\Delta$  would not be even reduced). Therefore  $|\mathbf{top}(\mathcal{B}_1)|$  is recursively bounded, and so we again found a cut of  $\Delta$  which has a recursively bounded length and turns  $\Delta$  into a simply connected van Kampen diagram with recursively bounded perimeter.  $\square$

**Lemma 4.5.** *Let  $\Delta$  be a reduced diagram over  $\mathcal{H}_1$  with boundary  $ep_1e'q_1(fp_2f')^{-1}q_2^{-1}$ , and the following conditions hold:*

- (1)  $e, e', f, f'$  are  $\Theta$ -edges,
- (2)  $\phi(p_1), \phi(p_2)$  are reduced words in  $\mathcal{X}$ ,
- (3)  $q_1 = \mathbf{top}(\mathcal{T}_1)$ ,  $q_2 = \mathbf{bot}(\mathcal{T}_2)$  for some  $\Theta$ -bands  $\mathcal{T}_1, \mathcal{T}_2$  without  $k$ - and  $a(P_j)$ -cells,
- (4) The bands  $\mathcal{T}_1, \mathcal{T}_2$  are decomposed as  $\mathcal{T}_1 = \mathcal{T}'_1\mathcal{T}''_1$ ,  $\mathcal{T}_2 = \mathcal{T}'_2\mathcal{T}''_2$  such that the words  $\phi(\mathbf{bot}(\mathcal{T}'_1))_a$ ,  $\phi(\mathbf{bot}(\mathcal{T}''_1))_a^{-1}$ ,  $\phi(\mathbf{top}(\mathcal{T}'_2))_a$  and  $\phi(\mathbf{top}(\mathcal{T}''_2))_a^{-1}$  are positive,
- (5) The diagram  $\Delta \setminus (\mathcal{T}_1 \cup \mathcal{T}_2)$  contains no  $\theta$ -edges.

Then

- (i) the length of every  $a$ -band connecting  $\mathbf{bot}(\mathcal{T}'_1)$  and  $\mathbf{top}(\mathcal{T}'_2)$  is between  $\frac{|p_1|}{6^{|\mathcal{T}'_1|}} - 2$  and  $|p_1|$ ,
- (ii) the length of an  $a$ -band, connecting  $\mathbf{bot}(\mathcal{T}''_1)$  and  $\mathbf{top}(\mathcal{T}''_2)$  is between  $\frac{|p_2|}{6^{|\mathcal{T}''_1|}} - 2$  and  $|p_2|$ .
- (iii)  $|\mathcal{T}'_1| \leq 2|p_1| + 2$ .

*Proof.* Parts (i) and (ii) of the lemma are symmetric so it is enough to prove part (i). Denote by  $q'_1$  (by  $q'_2$ ) the bottom (the top) of  $\mathcal{T}'_1$  (of  $\mathcal{T}'_2$ ). Let  $\mathcal{C}_1, \mathcal{C}_2$  be two neighbor maximal  $a$ -bands in  $\Delta$  corresponding to two consecutive  $a$ -letters in the words  $\phi(q'_1)_a$  and  $\phi(q'_2)_a$ . Denote by  $U_1$  and  $U'_1$  (by  $U_2$  and  $U'_2$ ) the top and bottom labels of  $\mathcal{C}_1$  (of  $\mathcal{C}_2$ ), respectively. By the positiveness condition (4) and the definition of  $\alpha_\tau$ , we have that  $U_1$  is freely equal to  $x^{\pm 1}U'_2(x')^{\pm 1}$  for some  $x$ -letters  $x, x'$ , and  $U'_2$  is obtained from  $U_2$  by replacing all letters by their fourth powers (see relations (2.8)). Hence the length of  $\mathcal{C}_1$  is strictly greater than the length of  $\mathcal{C}_2$  if  $|U_2| \neq 0$ . If  $U_2$  is empty, then  $x \neq x'$  because otherwise the  $\theta$ -cells of  $\mathcal{T}_1$  and  $\mathcal{T}_2$ , connected by  $\mathcal{C}_2$ , correspond to the same rule  $\tau$  (defined by  $x$ ) and form a reducible pair of cells. Hence, in any case  $|\mathcal{C}_1| > |\mathcal{C}_2|$ . Since the length of the first maximal  $a$ -band in  $\Delta$  (counting from  $p_1$ ) is at most  $|p_1|$ , we obtain the upper

estimate in part (i). Also we have from above considerations, that  $|U_1| \leq 6|U_2|$  if  $|U_2| \neq 0$ , and this immediately implies the lower estimate in parts (i) of the lemma.

Part (iii) is obtained as follows. The number of maximal  $a$ -bands starting on  $q'_1$  cannot exceed  $|p_1| + 1$  because the length of the next  $a$ -band is smaller than the length of the previous one. Also the length of  $q'_1$  does not exceed twice the number of  $a$ -edges on  $q'_1$ . Therefore  $|q'_1| \leq 2|p_1| + 2$ .  $\square$

**Lemma 4.6.** *Let  $\Delta$  be a diagram over  $\mathcal{H}_2$  with reduced boundary  $pq_1q_2q_3$ , and for some  $\tau \in \mathcal{S}^+$ ,  $\phi(q_1) = \alpha_{\tau \pm 1}(u)$ ,  $\phi(q_3) = \alpha_{\tau' \pm 1}(v)$  for some reduced words  $u, v$  in  $\mathcal{A}$ , and  $\phi(q_2)$  is a reduced word in  $\mathcal{X}$ . Suppose further that every  $a$ -band that starts on  $q_1$  ends on  $p$ . Then the number of cells in  $\Delta$  and the length of  $|q_1q_2q_3|$  are recursively bounded in terms of  $|p|$ .*

*Proof.* We can assume that there are no  $a$ - or  $k$ -bands starting and ending on  $p$ . Otherwise we could cut off one such band whose side is a subpath of  $p$ , producing a diagram of smaller type satisfying the conditions of the lemma (with side  $p$  replaced by a path  $p'$  whose length is at most  $4|p|$ ).

Thus by Lemma 3.11 we can assume that every cell in  $\Delta$  belongs to an  $a$ -band starting on  $q_1 \cup q_3$  and ending on  $p$ . The number  $l$  of such bands is at most  $|p|$ . Let us number these bands:  $\mathcal{C}_1, \mathcal{C}_2, \dots, \mathcal{C}_{l_1}, \dots, \mathcal{C}_l$  so that  $\mathcal{C}_i$  starts on the  $i$ -th  $a$ -edge of  $q_1 \cup q_3$ ,  $l_1$  is the number of  $a$ -edges on  $q_1$ . Let  $U_i$  be the label of the top side of  $\mathcal{C}_i$  and  $V_i$  be the label of the bottom side of  $\mathcal{C}_i$  (see Figure 17). Without loss of generality we can assume that  $l_1 > 1$ .

Since  $\phi(q_1) = \alpha_{\tau \pm 1}(u)$ ,  $\phi(q_3) = \alpha_{\tau' \pm 1}(v)$ ,  $|U_1|$  is bounded by  $|p| + 1$ ,  $|V_1|$  is at most  $4|U_1|$  (see relations (2.8)),  $U_2$  is bounded by  $2 + |V_1| + |p|$ ,  $|V_2| \leq 4|U_2|$ , etc. Hence the lengths of all bands  $\mathcal{C}_1, \dots, \mathcal{C}_{l_1}$  are recursively bounded in terms of  $|p|$ . Similarly the lengths of all bands  $\mathcal{C}_l, \mathcal{C}_{l-1}, \dots, \mathcal{C}_{l_1+1}$ , which start on  $q_3$ , are recursively bounded in terms of  $|p|$ . Hence indeed, the total number of cells in  $\Delta$  is recursively bounded in terms of  $|p|$ .

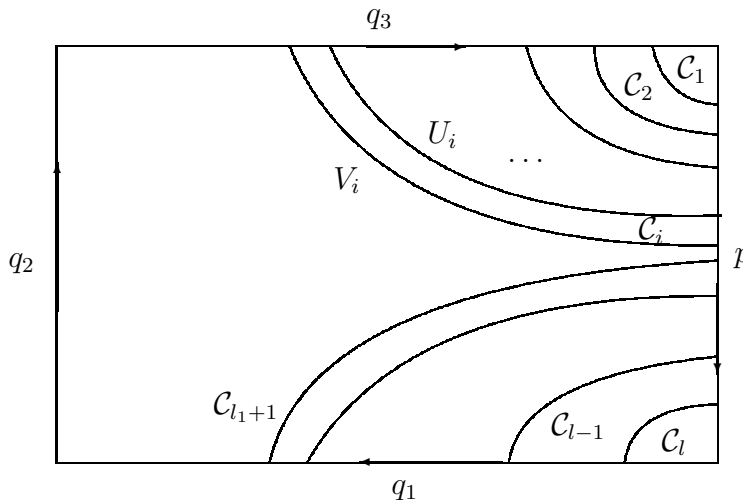

Figure 17.

Since every  $a$ -band in  $\Delta$  ends in  $p$ , the number of double edges of the boundary (i.e. edges which appear twice in the contour of the diagram and do not belong to the

boundaries of cells of the diagram) cannot exceed a constant times  $p$ . Hence the length of the contour of  $\Delta$  does not exceed a constant times the number of cells in  $\Delta$  plus a constant times  $|p|$ . Thus  $|q_1q_2q_3|$  is recursively bounded in terms of  $|p|$ .  $\square$

## 5 The word problem in $\mathcal{H}_1$

Recall that  $\mathcal{H}_1$  denotes the group given by all generators of  $\mathcal{H}$ , by all its defining relations, except for the hub  $\Sigma$ , and by all  $\mathcal{G}$ -relations.

**Lemma 5.1.** *The words problem in  $\mathcal{H}_1$  is decidable.*

*Proof.* It suffices to find an effective upper bound for the number of cells and perimeters of all  $\mathcal{G}$ -cells in a reduced van Kampen diagram  $\Delta$  over  $\mathcal{H}_1$ , depending on the perimeter  $|\partial(\Delta)|$  of  $\Delta$ . Indeed, since  $\mathcal{G}$  is embedded into  $\mathcal{H}$  by Lemma 3.9,  $\mathcal{G}$  is embedded into  $\mathcal{H}_1$  (which satisfies fewer relations than  $\mathcal{H}$  but which does satisfy all  $\mathcal{G}$ -relations. If we know the bound of perimeters of all  $\mathcal{G}$ -cells, we can list them all since the word problem in  $\mathcal{G}$  is decidable. So in order to check if a word  $w$  is equal to 1 in  $\mathcal{H}_1$ , we would have to consider finitely many van Kampen diagrams with perimeter  $|w|$ .

First, arguing as in [SBR] and [OlSa2], we bound the number of non- $\mathcal{H}_2$ -cells in  $\Delta$  as follows.

The number of maximal  $\theta$ -bands of  $\Delta$  is at most  $|\partial(\Delta)|$  since these bands must start and end on the boundary of  $\Delta$  by Lemma 3.11 (1). Similar upper bounds valid for the number of maximal  $k$ -bands, because the diagrams over  $\mathcal{H}_1$  have no hubs. Since every  $(\theta, k)$ -cell is the intersection of a  $\theta$ -band and a  $k$ -band, and two such bands can have at most one intersection by Lemma 3.11 (4), we have a quadratic upper bound (in terms of  $|\partial(\Delta)|$ ) for the number of  $(\theta, k)$ -cells of  $\Delta$ .

Since a maximal  $a$ -band in  $\Delta$  cannot be an annulus by Lemma 3.11(3), and cannot connect two  $\mathcal{G}$ -cells by Lemma 3.12, each maximal  $a$ -band in  $\Delta$  starts or ends either on the boundary of  $\Delta$  or on the boundary of a  $(\theta, k)$ -cell. Hence the number of maximal  $a$ -bands in  $\Delta$  is quadratically bounded in terms of  $|\partial\Delta|$ . Since every  $(a, \theta)$ -cell is an intersection of a  $\theta$ -band and an  $a$ -band, and two such bands can intersect only once (Lemma 3.11 (5)), the number of  $(a, \theta)$ -cells in  $\Delta$  is cubically bounded.

The cubic upper bound is also true for the sum of perimeters of  $\mathcal{G}$ -cells of  $\Delta$ . Indeed, each edge on the boundary of a  $\mathcal{G}$ -cell is the start edge of a  $a$ -band which ends either on the boundary of  $\Delta$  or on the boundary of a  $(\theta, k)$ -cell.

Notice further, that if  $\Gamma$  is a subdiagram of  $\Delta$  bounded by a simple loop without  $\theta$ - and  $\mathcal{A}(P_1)$ -edges, then  $\Gamma$  is a diagram over  $\mathcal{H}_2$ . Indeed,  $\Gamma$  has no  $\theta$ -cells by Lemma 3.11(1). Also  $\Gamma$  has no  $\mathcal{G}$ -cells, because otherwise the boundary of  $\Gamma$  would contain an  $\mathcal{A}(P_1)$ -edge (the end edge of a  $a$ -band starting on the  $\mathcal{G}$ -cell), contrary to the assumption.

This implies that every maximal connected subdiagram  $\Gamma$  of  $\Delta$  without  $\theta$ - and  $\mathcal{A}(P_1)$ -edges on the boundary is simply connected. The maximality of  $\Gamma$  implies that every edge of the contour of  $\Gamma$  belongs either to the contour of  $\Delta$  or to a contour of a non- $\mathcal{H}_2$ -cell.

Hence the sum of perimeters of all such  $\Gamma$  does not exceed the sum of perimeters of all non- $\mathcal{H}_2$ -cells of  $\Delta$  plus the perimeter of  $\Delta$ , i.e. it is effectively bounded. Now we can

apply Lemma 4.1, which provides an effective upper bound for the number of  $\mathcal{H}_2$ -cells in  $\Delta$ .  $\square$

Our main goal is to obtain similar result for the conjugacy problem in  $\mathcal{H}_1$ . In this section, we use Lemma 5.1 for getting some preliminary results.

**Lemma 5.2.** *Let  $\Delta$  be a reduced diagram over the presentation consisting of relations (2.7), (2.8) and  $\mathcal{G}$ -relations with contour  $pq$  where  $\phi(p)$  is reduced a word in  $\mathcal{X}$ . Then  $|p|$  is at most  $2|q|2^{\mu_a(q)}$  where  $\mu_a(q)$  is the number of  $a$ -edges in  $q$ , and the number and perimeters of cells in  $\Delta$  is recursively bounded as function of  $|q|$ .*

*Proof.* By Lemmas 3.11 and 3.12, part (2), every maximal  $a$ -band in  $\Delta$  starts and ends on  $q$  or starts on  $q$  and ends on a  $\mathcal{G}$ -cell. This implies that the number and the total perimeter of all  $\mathcal{G}$ -cells in  $\Delta$  are bounded by  $|q|$ , since an  $a$ -band cannot start and end on  $\mathcal{G}$ -cells by part (iv) of the definition of reduced diagram and Lemma 3.12(3). Using Lemma 3.12, part (1), we can move the  $\mathcal{G}$ -cells along the  $a$ -bands connecting these cells and  $q$ , to  $q$  and then remove them from the diagram increasing the length of  $q$  by at most a factor of 2. So we can assume that  $\Delta$  does not contain  $\mathcal{G}$ -cells, and  $q$  is replaced by  $q_0$  with  $|q_0| \leq 2|q|$  and the number  $n(q_0)$  of  $a$ -edges in  $q_0$  for  $a \notin \mathcal{A}(P_1)$  does not exceed the number of such edges in  $q$ . Thus all maximal  $a$ -bands in  $\Delta$  start and end on  $q_0$ .

Let us use induction on the number  $n_a(q_0)$  to prove that  $|p| \leq |q_0|2^{n(q_0)}$ . If  $n(q_0) = 0$ , then  $\Delta$  contains no cells and the statement is obvious. Since every cell in  $\Delta$  belongs to an  $a$ -band, there exists a maximal  $a$ -band whose side is contained in  $q_0$ . Cutting this  $a$ -band off  $\Delta$ , we get a diagram  $\Delta'$  with boundary  $pq'$  where  $(q') = n(q_0) - 2$ ,  $|q'| < 4|q_0|$ . By the induction hypothesis,

$$|p| \leq |q'|2^{n(q')} < 4|q_0|2^{n(q_0)-2} = |q_0|2^{n(q_0)}.$$

Since we have recursively bounded the number of  $a$ -bands in  $\Delta$  and the length of each  $a$ -band, the number of cells in  $\Delta$  is recursively bounded.  $\square$

**Lemma 5.3.** *Let  $\Delta$  be a reduced diagram over the presentation consisting of relations (2.7), (2.8) and  $\mathcal{G}$ -relations. Suppose  $\partial(\Delta) = pq$  where  $\phi(p)$  is the label of a side of a reduced  $k$ -band (the  $k$ -band is not contained in  $\Delta$ , of course). Suppose also that all  $\theta$ -bands starting on  $p$  end on  $q$ . Then the number and the perimeters of cells in  $\Delta$  are recursively bounded in terms of  $|q|$ .*

*Proof.* Let  $\mathcal{T}_1, \dots, \mathcal{T}_n$  be the maximal  $\theta$ -bands starting on  $p$  (counted from the beginning of  $p$  to the end of  $p$ ). Then  $n \leq |q|$ . Let  $\Delta_0$  be the subdiagram bounded by  $\partial(\Delta)$  and  $\mathbf{bot}(\mathcal{T}_1)$  (the one that does not contain  $\mathcal{T}_1$ ), for every  $i = 1, \dots, n - 1$  let  $\Delta_i$  be the subdiagram bounded by  $\partial(\Delta)$ ,  $\mathbf{top}(\mathcal{T}_i)$  and  $\mathbf{bot}(\mathcal{T}_{i+1})$ . Finally let  $\Delta_n$  be the subdiagram bounded by  $\mathbf{top}(\mathcal{T}_n)$  and  $\partial(\Delta)$ , not containing  $\mathcal{T}_n$ . Then for every  $i = 0, \dots, n$ , the  $a$ -edges on  $\partial(\Delta_i) \cap p$  belong to the initial or terminal segments of  $\partial(\Delta_i) \cap p$  of constant length (not exceeding the length of a relator of the form (2.6)). Hence by Lemma 3.11, all but a constant number of maximal  $a$ -bands in  $\Delta_i$  ( $i = 0, \dots, n$ ) starting on the boundary of  $\mathcal{T}_{i+1}$  ( $i = 0, \dots, n - 1$ ), end either on  $q$  or on a side of  $\mathcal{T}_i$  or on the boundary of a  $\mathcal{G}$ -cell.

Suppose that one of the  $a$ -bands in  $\Delta_i$  starting on a side of  $\mathcal{T}_{i+1}$  ( $i = 0, 1, \dots$ ) ends on the boundary of a  $\mathcal{G}$ -cell. Then the label of an  $a$ -edge of  $\mathcal{T}_{i+1}$  belongs to  $\mathcal{A}(P_1)$ . This



implies that the  $\Theta$ -edges of  $\mathcal{T}_{i+1}$  belong to  $\Theta(P_1)$ . This means that  $p$  is a side of a  $P_1$ - or  $R_1$ -band (see relations (2.6)). Since there are no  $P_1$ - or  $R_1$ -relations of the form (2.9), the length of  $p$  is at most a constant times the number of  $\theta$ -edges in  $p$ , i.e. does not exceed a constant times  $|q|$ . Thus the perimeter of  $\Delta$  is linearly bounded in terms of  $|q|$ , so the statement of the lemma follows from Lemma 5.1.

Thus we can assume that none of the  $a$ -bands in  $\Delta_i$  starting on a side of  $\mathcal{T}_{i+1}$  ends on the boundary of a  $\mathcal{G}$ -cell. Therefore all but a constant number of the  $a$ -bands in  $\Delta_i$  starting on the boundary of  $\mathcal{T}_{i+1}$  end on  $\mathcal{T}_i$  or on  $q$ . Therefore the length of  $\mathcal{T}_1$  is recursively bounded in terms of  $|q|$ , and for each of each  $i = 2, \dots, n$ ,  $|\mathcal{T}_i|$  is recursively bounded in terms of  $|q|$  and  $|\mathcal{T}_{i-1}|$ . Hence the lengths of all  $\mathcal{T}_i$  are recursively bounded in terms of  $|q|$ .

Thus for every  $i = 0, \dots, n$ , the diagram  $\Delta_i$  consists of cells corresponding to relations (2.8), and  $\mathcal{G}$ -relations the word  $\phi(\partial(\Delta_i) \cap p)$  has the form  $uvu'$  where  $u, u'$  have lengths bounded by a constant, and  $v$  is a word in  $\mathcal{X}$ , and the complement of  $\partial(\Delta_i) \cap p$  to  $\partial(\Delta_i)$  has length recursively bounded in terms of  $|q|$ . Therefore by Lemma 5.2, the length of  $\partial(\Delta_i) \cap p$  is also recursively bounded in terms of  $|q|$ , and the number and perimeters of cells in  $\Delta_i$  are also recursively bounded. This implies that  $|p|$  and the number of cells in  $\Delta$  are recursively bounded in terms of  $|q|$ .  $\square$

Let us introduce the following desirable properties of a boundary component  $p$  (inner or outer contour) of an annular diagram  $\Delta$  over  $\mathcal{H}_1$ :

- (R1)  $p$  does not contain the boundary of a  $\mathcal{G}$ -cell as a subpath;
- (R2) no  $a$ -band in  $\Delta$  starts and ends on  $p$ ;
- (R3) no  $\theta$ -band in  $\Delta$  starts and ends on  $p$ ;
- (R4) no  $k$ -band starts and ends on  $p$ .

The next lemma shows that in some cases we can achieve these properties without making too many changes in the diagram.

For every reduced path  $p$  in a diagram over  $\mathcal{H}_1$ , denote by  $\mu_k(p)$  (resp.  $\mu_\theta(p)$ ,  $\mu_a(p)$ ,  $\mu_x(p)$ ) the number of all  $k$ -edges (resp.  $\theta$ -edges,  $a$ -edges,  $x$ -edges) in  $p$ . The vector  $(\mu_k(p), \mu_\theta(p), \mu_a(p), \mu_x(p))$  will be called the *type* of  $p$ . We order types lexicographically.

**Lemma 5.4.** *Let  $\Delta$  be a reduced annular diagram over  $\mathcal{H}_1$  with boundary components  $p$  and  $q$ . Then by removing some cells from  $\Delta$ , one can construct an annular diagram  $\Delta_1$  satisfying condition (R4) with boundary components  $p_1$  and  $q$  where  $p_1$  satisfies condition (R4), such that  $|p_1|$ , the number and perimeters of cells in the diagram  $\Delta \setminus \Delta_1$  are recursively bounded in terms of  $|p|$ .*

*Proof.* Indeed, suppose that  $\Delta$  contains a  $k$ -band starting and ending, say, on  $p$ . Consider such a  $k$ -band  $\mathcal{B}$  which is the closest to  $p$ , so that the subdiagram  $\Gamma$  of  $\Delta$  bounded by  $\mathbf{top}(\mathcal{B})$  and  $p$  contains no  $k$ -bands. By Lemma 3.11, no  $\theta$ -band can start and end on  $\mathcal{B}$ . Therefore, by Lemma 5.3, the number and perimeters of cells in  $\Gamma$  are recursively bounded in terms of  $|p|$ . Removing  $\Gamma$  and  $\mathcal{B}$  we obtain a diagram with smaller number of  $k$ -edges on the boundary. Thus we can continue that operation at most  $|p|$  times and obtain the desired diagram  $\Delta_1$ .  $\square$

**Lemma 5.5.** *Let  $\Delta$  be a reduced annular diagram over  $\mathcal{H}_1$  with a boundary components  $p$  and  $q$ , and  $p$  satisfy the condition (R4). Then there exists another (annular) diagram  $\Delta'$  with contours  $p'$  and  $q$  satisfying (R1), (R2), (R3), (R4) and such that:*

(R0) *The path  $p'$  satisfies the following properties:*

- *The type of  $p'$  is not greater than the type of  $p$ , and  $|p'|$  is recursively bounded in terms of  $|p|$ .*
- *The word  $\phi(p')_\theta$  is freely conjugate of the word  $\phi(p)_\theta$  ;*
- *If  $p$  do not contain  $k$ -edges then the word  $\phi(p')_a$  is conjugate of the word  $\phi(p)_a$  modulo the  $\mathcal{G}$ -relations from  $\Delta$ ;*
- *The words  $\phi(p)$  and  $\phi(p')$  are conjugate modulo relations used in  $\Delta$ . The number and lengths of relations used to deduce these conjugacies are recursively bounded in terms of  $|p|$ ;*

*Proof.* Let us describe three operations which can be applied to  $\Delta$ .

1. If a  $p$  contains a subpath which is the boundary of a  $\mathcal{G}$ -cell, we can remove that cell from  $\Delta$  lowering the length of the boundary. This operation does not increase the number of  $k$ -edges,  $\theta$ -edges or  $a$ -edges on this boundary component of the diagram. The  $\theta$ -projections of the labels of the boundary components of the diagram do not change. Notice that the resulting diagram satisfies (R0).

2. Suppose that an  $a$ -bands  $\mathcal{C}$  in  $\Delta$  starts and ends on  $p$ . Let  $\Delta_1$  be the subdiagram of  $\Delta$  bounded by  $\mathcal{C}$  and  $p$ . It has no  $k$ -edges by property (R4) and Lemma 3.11, because  $\mathcal{C}$  cannot possess a  $k$ -cell. Since the top/bottom of  $\mathcal{C}$  has no  $a$ -edges, we can apply lemma 2.12, as in the proof of Lemma 5.2, and remove all  $\mathcal{G}$ -cells of  $\Delta_1$  increasing the length of the  $p$ -part of its boundary at most twice, but not changing  $\mathcal{C}$ .

Every maximal  $a$ -band in  $\Delta_1$  starts and ends on  $p$  since  $\Delta_1$  has neither  $k$ - nor  $\mathcal{G}$ -cells. Therefore we could find an  $a$ -band  $\mathcal{C}$  that starts and ends on, say,  $p$ , and such that there are no cells between the top path of the band and  $p$ . Then the length of this band would be bounded by  $|p|$ . Notice that the number of  $\theta$ -edges on the top path of an  $a$ -band is equal to the number of  $\theta$ -edges on the bottom path of the band, and the corresponding numbers of  $\mathcal{X}$ -edges can differ at most 4 times. Therefore we could delete that band and reduce the number of  $a$ -edges in  $\partial(\Delta)$  but not increase the number of  $\theta$ -edges there and preserve property (R0) (in particular, since  $\mathcal{C}$  connects two consecutive  $a$ -edges on  $p$ ,  $\phi(p')_a$  is obtained from  $\phi(p)_a$  by removing a subword of the form  $aa^{-1}$ , so  $\phi(p)_a = \phi(p')_a$  in the free group).

3. Suppose that a  $\theta$ -band  $\mathcal{T}$  in  $\Delta$  starts and ends on  $p$ , and there are no  $\theta$ -cells in the simply connected subdiagram  $\Gamma$  of  $\Delta$  between the top side of that band and  $p$ . If  $\mathbf{top}(\mathcal{T})$  is a part of  $p$ , then we can remove  $\mathcal{T}$  as in part 2, reducing the number of  $\theta$ -edges on the boundary of the diagram, cancelling two consecutive mutually inverse  $\theta$ -letters in the cyclic word  $\phi(p)_\theta$ , and not increasing the number of  $k$ -edges there, thus preserving (R0) (notice, in particular, that if there are no  $k$ -edges on  $p$ , then  $\phi(\mathbf{top}(\mathcal{T}))_a \equiv \phi(\mathbf{bot}(\mathcal{T}))_a$ , whence  $\phi(p')_a \equiv \phi(p)_a$ ).

Assume now that there is a  $\mathcal{G}$ -cell  $\Pi$  in  $\Gamma$ , connected with  $\mathcal{T}$  by an  $a$ -band. This  $a$ -band has no cells, since  $\Gamma$  contains no  $\theta$ -cells. Hence the contour  $p_\Pi q_\Pi$  of  $\Pi$  has a common part

$q_\Pi$  of positive length with  $\mathcal{T}$ . Then, by relations (2.7),  $\phi(p_\Gamma)$  and  $\phi(q_\Gamma)$  commute with the  $\theta(P_1)$ -letters labelling the  $\theta$ -edges of the subband  $\mathcal{T}_0$  of  $\mathcal{T}$  with top side  $q_\Pi$ . Therefore one can construct an auxiliary  $\theta$ -band  $\mathcal{T}'$ , whose top label is obtained from that of  $\mathcal{T}$  by replacing the subwords  $\phi(q_\Pi)$  by  $\phi(p_\Pi)$ . Then one can paste  $\mathcal{T}'$  to  $\Gamma \setminus (\Pi \cup \mathcal{T}_0)$  reducing the number of  $\mathcal{G}$ -cells in  $\Gamma$ , but preserving property (R0). Notice that this transformation does not affect the boundary labels of  $\Delta$ .

Hence one may assume further that no  $\mathcal{G}$ -cell of the reduced subdiagram  $\Gamma$  is connected with  $\mathcal{T}$  by an  $a$ -band. Therefore the sum of perimeters of all  $\mathcal{G}$ -cells in  $\Gamma$  is not greater than the length of the  $p$ -part  $p_\Gamma$  of its boundary. Then, as in part 2, one can remove all  $\mathcal{G}$ -cells from  $\Gamma$  increasing the number of  $a$ -edges in  $p_\Gamma$  at most twice and preserving (R0). Thus we may assume that  $\Gamma$  has no  $\mathcal{G}$ -cells.

Let  $\mathcal{B}_1, \dots, \mathcal{B}_r$  be all the maximal  $a$ - and  $k$ -bands in  $\Gamma$  starting on  $p$ , of non-zero length. Each of the bands  $\mathcal{B}_1, \dots, \mathcal{B}_r$  ends either on  $\mathcal{T}$  or on  $p$  (an  $a$ -band  $\mathcal{B}_i$  cannot end on a  $k$ -cell not from  $\mathcal{T}$  because every  $k$ -cell containing an  $a$ -edge also contains a  $\theta$ -edge). Therefore there is one of them (if  $r > 0$ ), say  $\mathcal{B}_1$ , such that the top or bottom side  $p^1$  of  $\mathcal{B}_1$  has no edges in common with the sides of  $\mathcal{B}_2, \dots, \mathcal{B}_r$  and has at most 4 common  $x$ -edges with  $\mathcal{T}$ . ( $\mathcal{T}$  can have at most 2 consecutive  $x$ -letter in its boundary label, as it follows from the form of  $\theta$ -relations.) Since all the edges of  $p^1$  (with at most 4 exceptions) belong to  $p$ , the length of  $\mathcal{B}_1$  is linearly bounded. Removing this band from  $\Gamma$  does not violate property (R0). Considering the diagrams  $\Gamma \setminus \mathcal{B}_1, \Gamma \setminus (\mathcal{B}_1 \cup \mathcal{B}_2) \dots$  we can recursively bound the length of every  $\mathcal{B}_2, \dots, \mathcal{B}_r$ , because the number  $r$  was linearly bounded above, and remove them all from  $\Gamma$ . But the case where  $\Gamma$  has no cells was considered in the beginning.

Now repeating operations 1, 2, 3 recursively bounded (in terms of  $|p|$ ) number of times we will get the desired annular diagram.  $\square$

We call a word  $W$   $\theta$ -minimal if the number of  $\theta$ -letters in  $W$  are not greater than the similar numbers for any word  $W'$  which is a conjugate of  $W$  in  $\mathcal{H}_1$ . Similarly we define  $k$ -minimal words. A word  $W$  is called  $\theta k$ -minimal if it is both  $\theta$ - and  $k$ -minimal. A word  $W$  is said to be  $\theta a$ -minimal, if the number of  $\theta$ -letters and the number of non- $\mathcal{A}(P_1)$   $a$ -letters in  $W$  are not greater than the corresponding numbers for any word  $W'$  which is a conjugate of  $W$  modulo the relations of  $\mathcal{H}_1$  except for  $(\theta, k)$ -relations. A boundary component of an (annular) diagram  $\Delta$  over  $\mathcal{H}_1$  is called minimal if its label is  $\theta k$ -minimal and, if  $\Delta$  has no  $(\theta, k)$ -cells, it is also  $\theta a$ -minimal. Let us consider reduced annular diagrams with boundary labels  $W$  and  $W'$  for various words  $W'$ . The immediate analysis of the transformations used in lemmas 5.4 and 5.5 proves

**Lemma 5.6.** *For any word  $W$  representing an element of  $\mathcal{H}_1$ , there is an annular diagram  $\Delta_0$  over  $\mathcal{H}_1$  with boundary labels  $W$  and  $W_0$ , where  $W_0$  is  $\theta k$ -minimal ( $\theta a$ -minimal, and  $\Delta_0$  has no  $(\theta, k)$ -cells), such that the length of  $W_0$ , the number, and the perimeters of cells in  $\Delta_0$  are recursively bounded as functions of  $|W|$ .*

## 6 Some special diagrams

### 6.1 $\theta$ -bands and trapezia

Let  $W$  be a reduced word in the generators of  $\mathcal{H}$ . The *base* of  $W$  is the projection of  $W$  onto  $\tilde{\mathcal{K}}$ .

Let  $\tau \in \mathcal{S} \cup \bar{\mathcal{S}}$ , and  $W \equiv U_1 z_1 U_2 \dots z_n U_{n+1}$  a word where  $z_1, \dots, z_n$  are basic letters,  $U_1, \dots, U_{n+1}$  are words in  $\mathcal{A} \cup \bar{\mathcal{A}} \cup \mathcal{X}$ . Denote  $z_0 = (z_1)_-$ ,  $z_{n+1} = (z_n)_+$ . For every word  $V$  let  $V_{\setminus x}$  be the word  $V$  with all  $x$ -letters deleted. We say that the word  $W$  is  $\tau$ -regular if

- for every  $i = 1, \dots, n+1$  the word  $z_{i-1}(U_i)_{\setminus x} z_i$  is admissible for  $\mathcal{S} \cup \bar{\mathcal{S}}$  and in the domain of  $\tau$ ;
- if  $\tau \in \mathcal{S}$ , then  $W \equiv \alpha_\tau(W_{\setminus x})$ , and if  $\tau \in \bar{\mathcal{S}}$ , then  $W$  does not contain  $x$ -letters.

Thus for every admissible word  $W$  of  $\mathcal{S}$  to which  $\tau \in \mathcal{S}$  is applicable the word  $\alpha_\tau(W)$  is  $\tau$ -regular, and if  $\tau \in \bar{\mathcal{S}}$  is applicable to an admissible word  $W$  of  $\bar{\mathcal{S}}$  then  $W$  itself is  $\tau$ -regular.

The following lemma immediately follows from the form of  $\theta$ -relations from  $\mathcal{R}'$ .

**Lemma 6.1.** *Let  $\mathcal{B}$  be a reduced  $\Theta(\tau)$ -band for some  $\tau \in \mathcal{S} \cup \bar{\mathcal{S}}$ . Then the reduced labels of the top and the bottom paths of  $\mathcal{B}$  have the same bases which will be called the base of  $\mathcal{B}$ , and are  $\tau$ - or  $\tau^{-1}$ -regular words.*

For future references it is convenient to list all possible 2-letter bases of  $\tau$ -regular words (i.e. 2-letter subwords of  $\tilde{\Sigma}^{\pm 1}$ ).

**Lemma 6.2.** *Let  $yz$  be a 2-letter base of a reduced  $\Theta(\tau)$ -band,  $y, z \in \tilde{\mathcal{K}} \cup \tilde{\mathcal{K}}^{-1}$ . Then  $yz$  or  $(yz)^{-1}$  has one of the following forms:  $\overleftarrow{L}_j L_j, L_j P_j, P_j R_j, R_j \overrightarrow{R}_j, z_j z_j^{-1}, z_j^{-1} z_j$  where  $z \in \{K, L, P, R\}$ ,  $j = 1, \dots, N$ . In addition if  $\tau \in \bar{\mathcal{S}}$ ,  $yz$  cannot have the form  $z_1 z_1^{-1}$  or  $z_1^{-1} z_1$  where  $z \in \{L, R, P\}$ , and it cannot be equal to either  $K_1 K_1^{-1}$  or to  $K_2^{-1} K_2$ . Moreover if  $\tau$  locks  $zz_+$ -sectors then  $yz$  cannot have the form  $zz^{-1}$ .*

*Proof.* Only the ‘‘moreover’’ statement needs explanation. If  $\tau$  locks  $zz_+$ -sectors, then there are no corresponding relations of the form (2.7). Hence if the base has the form  $zz^{-1}$ , the band has two consecutive mirror image  $(\theta, z)$ -cells that cancel. This contradicts the assumption that  $\mathcal{B}$  is reduced.  $\square$

The following lemma immediately follows from relations (2.6), (2.7).

**Lemma 6.3.** *Let  $yz$  be the base of a  $\Theta(\tau)$ -band  $\mathcal{B}$ . Let  $V$  be the label of the top path of  $\mathcal{B}$ ,  $V'$  be the label of the bottom path of  $\mathcal{B}$ . Let  $V = \alpha_{\tau \pm 1}(W_1 y(r, i) W_2 z(r, i) W_3)$ ,  $V' = \alpha_{\tau \mp 1}(W'_1 y(r', i') W'_2 z(r', i') W'_3)$  provided  $\tau \in \mathcal{S}$  and let  $V = W_1 y(r, i) W_2 z(r, i) W_3$ ,  $V' = W'_1 y(r', i') W'_2 z(r', i') W'_3$  provided  $\tau \in \bar{\mathcal{S}}$ . Let  $u(y_-), v(y), u(y), v(z)$  be the words associated with  $\tau$  and defined in Section 2.4. Then, in the free group,  $W'_1 = W_1 v(y_-)$ ,  $W'_2 = u(y) W_2 v(y)$ ,  $W'_3 = u(z) W_3$ .*

A *trapezium* (see Figure 18) is a reduced van Kampen diagram  $\Delta$  over the group  $\mathcal{H}_1$  whose boundary path is factorized as  $p_1p_2p_3p_4$ , where

- (1) the paths  $p_2$  and  $p_4$  have no  $\theta$ -edges;
- (2)  $p_1$  and  $p_3^{-1}$  are sides of  $k$ -bands  $\mathcal{B}$  and  $\mathcal{B}'$  starting on  $p_4$  and ending on  $p_2$  (i.e.  $p_1 = \mathbf{top}(\mathcal{B})$ ,  $p_3^{-1} = \mathbf{bot}(\mathcal{B}')$ ).
- (3) every maximal  $k$ -band in  $\Delta$  contain at least one  $\theta$ -cell and connects  $p_2$  and  $p_4$ .

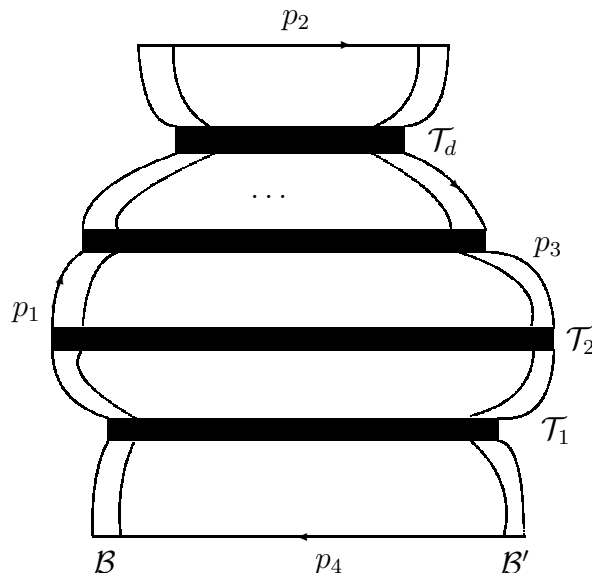

Figure 18.

By definition,  $p_2$  and  $p_4$  are the *top* and the *bottom* of the trapezium, respectively. As follows from Lemma 3.11, every maximal  $\theta$ -band of the trapezium connects  $p_1$  and  $p_3$ . We shall usually enumerate maximal  $\theta$ -bands starting on  $p_1$  from the bottom to the top:  $\mathcal{T}_1, \dots, \mathcal{T}_d$ . The number of them is called the *height* of the trapezium. The paths  $p_1, p_2, p_3, p_4$ , the bands  $\mathcal{B}, \mathcal{B}'$  and  $\mathcal{T}_1, \dots, \mathcal{T}_d$  form the *data* associated with the trapezium. By Lemma 3.11, each of these  $k$ -bands intersects each of the  $\theta$ -bands exactly once. Therefore by Lemma 6.1 the bases of the  $\theta$ -bands  $\mathcal{T}_1, \dots, \mathcal{T}_d$  are the same. Hence the base of the label of the bottom  $p_4$  will be called the *base* of the trapezium (it is equal to the base of each of  $\mathcal{T}_i$ ). Notice that every  $k$ -band is a trapezium with a 1-letter base.

A reduced annular diagram  $\Delta$  is called a *ring* with boundary components  $p_2$  and  $p_4$  if:

- (1) the labels of  $p_2$  and  $p_4$  contain no  $\theta$ -edges;
- (2) the boundaries  $p_2$  and  $p_4$  are minimal;
- (3)  $\Delta$  has at least one  $(k, \theta)$ -cell.

It follows from the definition, that a ring  $\Delta$  contains at least one  $k$ -band having a  $(\theta, k)$ -cell, every maximal  $k$ -band of  $\Delta$  connects  $p_2$  and  $p_4$ , and a ring is obtained from a trapezium by identifying two bands  $\mathcal{B}$  and  $\mathcal{B}'$  (in this case  $\mathcal{B}$  must be a copy of  $\mathcal{B}'$  in the definition of trapezium). The  $\theta$ -bands in a ring are annuli surrounding the hole of the ring. The top and bottom paths of the trapezium turn into the *outer* and *inner* paths of the ring. The base and the height of a ring are defined as for trapezia, but the base is considered as a cyclic word.

If the bands  $\mathcal{B}$  and  $\mathcal{B}'$  from the definition of trapezia are allowed to be  $a$ -bands,  $a \notin \mathcal{A}(P_1)$ , one obtains the definition of *quasitrapezium*.

A *quasiring* is either a ring or a reduced annular diagram with contours  $p$  and  $q$  such that (1)  $\Delta$  contains no  $(\theta, k)$ -cells but contains a  $(\theta, a)$ -cell with  $a \neq \mathcal{A}(P_1)$ ; (2) the labels of the contour  $p$  and  $q$  have neither  $\theta$  nor  $k$ -letters; (3) the boundaries  $p$  and  $q$  are minimal.

The definitions of the base and the history of a quasitrapezium (quasiring) are similar to those for trapezia (ring), but the base of a quasitrapezium can be empty. Of course if the base of a quasiring is not empty then it is a ring.

**Lemma 6.4.** *For any reduced annular diagram  $\Delta$  over  $\mathcal{H}_1$  whose contours  $p$  and  $q$  do not contain  $\theta$ -edges, there exists a ring or a quasiring, or a diagram with minimal boundaries and having no cells,  $\Delta'$  whose contours  $p'$  and  $q'$  satisfy properties (R0)-(R4) of Lemma 5.5, in which the lengths  $p'$  and  $q'$  are recursively bounded in terms  $|p| + |q|$ , and there exists a conjugacy diagram for  $\phi(p)$  (for  $\phi(q)$ ) and  $\phi(p')$  (and  $\phi(q')$ ) with recursively bounded number and perimeters of cells.*

*Proof.* By Lemma 5.6 one can assume that  $p$  is a minimal boundary. We may also assume that  $q$  enjoys the same property.

If we have a  $(\theta, k)$ -cells in  $\Delta$ , then the diagram is a roll. So we assume that there are no  $(\theta, k)$ -cells in it.

If there is a  $k$ -edge in  $\partial\Delta$ , then a maximal  $k$ -band, containing no  $\theta$ -cells, connects  $p$  and  $q$ . Therefore  $\Delta$  has no  $\theta$ -edges by Lemma 3.11. Hence it is a diagram over the free product of the group  $\mathcal{H}_2$  and  $\mathcal{G}$ , and the statement follows from Lemma 4.4.

A reduced diagram cannot possess a  $\theta$ -annulus consisting of  $(a(P_1), \theta)$ -cells (with equal boundary labels). Hence, if  $p$  and  $q$  have neither  $\theta$ - nor  $k$ -edges, then  $\Delta$  is a *quasiring* as desired, or it has no  $\theta$ -cells. If  $\Delta$  has no  $\theta$ -cells, then we can repeat the argument of the previous paragraph.  $\square$

Let  $\mathcal{T}_i$ ,  $i = 1, \dots, d$  be a  $\Theta(\tau_i)$ -band where  $\tau_i \in \mathcal{S} \cup \bar{\mathcal{S}}$ . Then the word  $h = \tau_1\tau_2\dots\tau_d$  is called the *history* of the trapezium (ring). Notice that the length of the history is equal to the height of the trapezium (ring). By Lemma 3.11, the history of any  $k$ -band in a trapezium (ring) is equal to the history of the trapezium (ring).

**Lemma 6.5.** (1) *Let  $y_1 \dots y_s$  be the base of a trapezium  $\Delta$  whose top and bottom labels have no letters from  $\mathcal{A}(P_1)$ . Assume the words  $y_1 \dots y_{s-1}$ ,  $(y_2 \dots y_s)^{-1}$  contain no occurrence of the positive letter  $P_1$ , and the words  $y_2 \dots y_s$ ,  $(y_1 \dots y_{s-1})^{-1}$  contain no occurrence of the positive letter  $R_1$ . Then  $\Delta$  has no  $\mathcal{G}$ -cells.*

(2) *If the base of a quasiring does not contain  $P_1^{\pm 1}$  and  $R_1^{\pm 1}$  and the inner and outer paths of the ring do not contain  $\mathcal{A}(P_1)$ -edges then the ring does not have  $\mathcal{G}$ -cells.*

*Proof.* (1) Indeed, by Lemma 3.12, we can assume that every  $\mathcal{A}(P_1)$ -band starting on a  $\mathcal{G}$ -cell must end either on the boundary of the diagram or on the boundary of a  $P_1$ -cell or on the boundary of a  $R_1$ -cell. The first case would imply that the bottom or the top of the trapezium contains  $\mathcal{A}(P_1)$ -edges. The second case would imply that one of the letters  $y_1, \dots, y_{s-1}, y_2^{-1}, \dots, y_s^{-1}$  is  $P_1$ . The third case would imply that one of the letters  $y_2, \dots, y_s, y_1^{-1}, \dots, y_{s-1}^{-1}$  is  $R_1$ .

Statement (2) is proved similarly.  $\square$

## 6.2 Trapezia with 2-letter bases

Let  $\Delta$  be a trapezium with a 2-letter base  $yz$ . We use the notations from Section 6.1 and from the definition of a trapezium for the data of  $\Delta$ . Let  $V_0 \equiv \phi(p_4^{-1})$ ,  $U_{d+1} \equiv \phi(p_2)$ , and for all  $i = 1, \dots, d$  let  $U_i \equiv \phi(\mathbf{bot}(\mathcal{T}_i))$ ,  $V_i \equiv \phi(\mathbf{top}(\mathcal{T}_i))$ .

For every word  $W$ , we denote the projection  $W_{\mathcal{A} \cup \bar{\mathcal{A}}}$  of  $W$  onto the alphabet  $\mathcal{A} \cup \bar{\mathcal{A}}$  by  $W_a$ . Similarly we denote  $W_{\Theta \cup \bar{\Theta}}$  by  $W_\theta$ .

**Lemma 6.6.** (1) *Suppose that  $\Delta$  does not have  $\mathcal{G}$ -cells. Then  $(U_1)_a = (V_0)_a$ ,  $(V_d)_a = (U_{d+1})_a$  in the free group, and  $(V_i)_a \equiv (U_{i+1})_a$ ,  $i = 1, \dots, d - 1$ .*

(2) *If  $\Delta$  contains  $\mathcal{G}$ -cells then  $(U_1)_a = (V_0)_a$ ,  $(V_d)_a = (U_{d+1})_a$ ,  $(V_i)_a = (U_{i+1})_a$ ,  $i = 1, \dots, d - 1$ , modulo the  $\mathcal{G}$ -relations.*

*Proof.* Let  $\Gamma_0$  be the subdiagram of  $\Delta$  bounded by  $p_1, p_3, p_4, \mathbf{bot}(\mathcal{T}_1)$ ,  $\Gamma_d$  be the subdiagram bounded by  $p_1, p_3, p_2, \mathbf{top}(\mathcal{T}_d)$ , and for every  $i = 1, \dots, d - 1$  let  $\Gamma_i$  be the subdiagram bounded by  $p_1, p_3, \mathbf{top}(\mathcal{T}_i)$  and  $\mathbf{bot}(\mathcal{T}_{i+1})$ .

(1) Suppose that  $\Delta$  does not contain  $\mathcal{G}$ -cells. A maximal  $a$ -band in  $\Gamma_i$  which starts on a side of a  $\theta$ -band cannot end up on the same side because otherwise the top/bottom labels of the  $\theta$ -band would not be reduced. This implies that  $(V_1)_a \equiv (U_2)_a, \dots, (V_{d-1})_a \equiv (U_d)_a$ .

Also every  $a$ -band which starts on  $\mathbf{bot}(\mathcal{T}_1)$  ends on  $p_4$ , every  $a$ -band which starts on  $\mathbf{top}(\mathcal{T}_d)$  ends on  $p_2$ . If an  $a$ -band starts and ends on  $p_4$  (resp.  $p_2$ ) then the label of the  $a$ -path between the start and end edges of that band must be freely equal to 1. Hence  $(V_0)_a = (U_1)_a$  and  $(V_d)_a = (U_{d+1})_a$  in the free group.

(2) Cells in  $\Gamma_i$  do not contain  $\theta$ -edges. Hence they correspond to either relations of the form (2.8) or  $\mathcal{G}$ -relations. If we remove all  $\mathcal{X}$ -letters in relations (2.8), the relations become trivial. Thus if we collapse all  $\mathcal{X}$ -edges in  $\Gamma_i$ ,  $i = 0, \dots, d$ , that diagram becomes a diagram with  $\mathcal{G}$ -cells only. (More precisely, to the boundary label of  $\Gamma_i$ , we apply the homomorphism which preserves letters  $a_i(P_1)$ ,  $1 \leq i \leq m$ , and sends other  $a$ -letters and  $\mathcal{X}$ -letters to 1.) Since the portions of  $p_1$  and  $p_3$  on the contour of  $\Gamma_i$  consist of  $\mathcal{X}$ -edges, these portions collapse to vertices. Now van Kampen lemma implies that  $(U_1)_a = (V_0)_a$ ,  $(V_d)_a = (U_{d+1})_a$ ,  $(V_i)_a = (U_{i+1})_a$ ,  $i = 1, \dots, d - 1$ , modulo the  $\mathcal{G}$ -relations, as required.  $\square$

The following lemma immediately follows from the fact that there are no  $(P_j, \mathcal{X})$ - and  $(R_j, \mathcal{X})$ -relations of the form (2.9).

**Lemma 6.7.** *One of the sides of every  $P_j$ -band ( $R_j$ -band) in a van Kampen diagram over  $\mathcal{H}_1$  contains  $a$ - and  $\theta$ -edges only.*

**Lemma 6.8.** (1) *If the base of a trapezium  $\Delta$  contains a  $P_j$ - or a  $R_j$ -letter, then the history is a reduced word.*

(2) *The history of an arbitrary ring is a reduced word.*

*Proof.* (1) Let  $\tau\tau^{-1}$  be a 2-letter subword of the history of a trapezium  $\Delta$ . Consider the corresponding pair  $\mathcal{T}_i, \mathcal{T}_{i+1}$  of consecutive  $\theta$ -bands in  $\Delta$ . The intersections of these bands with a  $P_j$ - or  $R_j$ -band  $\mathcal{C}$  of  $\Delta$  are two cells  $\pi, \pi'$  which are consecutive cells in  $\mathcal{C}$  by Lemma 6.7. Since  $\pi$  and  $\pi'$  correspond to  $\tau$  and  $\tau^{-1}$ , they form a reducible pair of cells which contradicts the assumption that  $\Delta$  is reduced.

(2) Let  $\Delta$  be a ring. Without loss of generality we can assume that the history of  $\Delta$  is  $\tau\tau^{-1}$ , so  $\Delta$  is of height 2. By (1), we can assume that the base of  $\Delta$  has neither  $P_j$ - nor  $R_j$ -letters. We can also suppose that  $\Delta$  is constructed of two  $\theta$ -bands  $\mathcal{T}_1, \mathcal{T}_2$  and a of the subdiagram  $\Gamma$  bounded by  $\mathbf{top}(\mathcal{T}_1)$  and  $\mathbf{bot}(\mathcal{T}_2)$ , which have no  $\theta$ -cells.

By Lemma 6.5, applied to all subtrapezia of  $\Delta$  with 2-letter bases,  $\Delta$  has no  $\mathcal{G}$ -cells. Therefore, by Lemma 6.6 (1) we have that the words obtained from the labels of  $\mathbf{top}(\mathcal{T}_1)$  and  $\mathbf{bot}(\mathcal{T}_2)$  after deletion of all  $\mathcal{X}$ -letters, are freely equal. The same is true for the labels of  $\mathbf{bot}(\mathcal{T}_1)$  and  $\mathbf{top}(\mathcal{T}_2)$  by Lemma 6.3, since bands  $\mathcal{T}_1$  and  $\mathcal{T}_2$  correspond to mutually inverse rules. Hence  $\phi(\mathbf{bot}(\mathcal{T}_1)) \equiv \phi(\mathbf{top}(\mathcal{T}_2))$  by Lemma 6.1. But this contradicts the assumption that  $\Delta$  is reduced (see part (iv) of the definition of non-reduced diagram).  $\square$

### 6.3 Trapezia simulate the work of $\mathcal{S}$ -machines

The following lemma shows that every trapezium simulates the work of  $\mathcal{S} \cup \bar{\mathcal{S}}$ .

**Lemma 6.9.** *Let  $\Delta$  be a trapezium of height  $d$  with  $\theta$ -bands  $\mathcal{T}_1, \dots, \mathcal{T}_d$ ,  $W$  (resp.  $W'$ ) be the projection of the label of the bottom (resp. top) path of  $\Delta$  onto  $\mathcal{A} \cup \bar{\mathcal{A}} \cup \mathcal{K} \cup \bar{\mathcal{K}}$ ,  $U_i$  (resp.  $V_i$ ),  $i = 1, \dots, d$ , be the projection of  $\phi(\mathbf{bot}(\mathcal{T}_i))$  (resp.  $\phi(\mathbf{top}(\mathcal{T}_i))$ ) on the same set. Let  $h = \tau_1 \cdot \dots \cdot \tau_d$  be the history of  $\Delta$ . Then  $U_i, V_i$ ,  $i = 1, \dots, d$ , are admissible words for  $\mathcal{S} \cup \bar{\mathcal{S}}$ . In addition*

$$W = U_1(\text{mod } \mathcal{G}), V_1 = U_1 \circ \tau_1, U_2 = V_1(\text{mod } \mathcal{G}), \dots, V_d = U_d \circ \tau_d, W' = V_d(\text{mod } \mathcal{G}), \quad (6.1)$$

(here  $\text{mod } \mathcal{G}$  means that the equality is true modulo  $\mathcal{G}$ -relations, other equalities are true in the free group). If  $\Delta$  does not contain  $\mathcal{G}$ -cells then one can remove  $(\text{mod } \mathcal{G})$  from the previous statements. We also have  $||U_i| - |V_i|| \leq Bc$  where  $B$  is the length of the base of  $\Delta$  and  $c$  is the maximum of lengths of words in  $\bar{\mathcal{E}}$ .

*Proof.* Suppose first that  $\Delta$  contains just one  $\theta$ -band  $\mathcal{T}$ . Let  $U$  and  $V$  be the projections of  $\phi(\mathbf{bot}(\mathcal{T}))$  and  $\phi(\mathbf{top}(\mathcal{T}))$  respectively on  $\mathcal{A} \cup \bar{\mathcal{A}} \cup \mathcal{K} \cup \bar{\mathcal{K}}$ . Lemmas 6.1 and 6.3 imply that  $U$  and  $V$  are admissible words for  $\mathcal{S} \cup \bar{\mathcal{S}}$  and  $V = U \circ \tau$ . By Lemma 6.6  $W = U$  and  $W' = V$  in the free group if  $\Delta$  does not have  $\mathcal{G}$ -cells, otherwise these equalities hold modulo  $\mathcal{G}$ -relations. The fact that  $||V_i| - |U_i||$  follows from Lemma 6.3. Now the proof can be finished by a simple induction on the height of  $\Delta$ .  $\square$

We shall call (6.1) the *computation associated with trapezium  $\Delta$* . The *length* of the computation is the height of the trapezium.

**Lemma 6.10.** (1) *Let  $x_1, y_1, x_2, y_2$  be letters in  $\mathcal{X}$ ,  $x_1 \neq y_1^{\pm 1}$ ,  $x_2 \neq y_2^{\pm 1}$ , and let  $U_1, U_2$  be non-empty reduced words which are products of fourth powers of letters from  $\mathcal{X}$ . Then  $U_1 x_1 y_1^{-1} U_2 y_2 x_2^{-1} \neq 1$  in the free group.*

(2) *Let  $x_1, x_2 \in \mathcal{X}^{\pm 1}$ ,  $U$  and  $x_1 U x_2$  are products of fourth powers of letters from  $\mathcal{X}$  then  $x_2 \equiv x_1^{-1}$  and  $U$  is a power of  $x_1$ .*

(3) *Let  $x_1, x_2 \in \mathcal{X}^{\pm 1}$ ,  $U$  is a non-empty power of a letter  $x \in \mathcal{X}$ ,  $x_1 U x_2$  is a product of fourth powers of letters of  $\mathcal{X}$ . Then  $x_1, x_2 \in \{x, x^{-1}\}$ .*



*Proof.* (1) Suppose  $U_1x_2y_2^{-1}U_2y_1x_1^{-1} = 1$  in the free group. Then  $U_1x_2y_2^{-1} = x_1y_1^{-1}U_2^{-1}$ . Since  $U_1$  is a nonempty product of fourth powers of letters, the reduced form of  $U_1x_2y_2^{-1}$  ends with  $x_2^{\pm 1}y_2^{-1}$ . But since  $U_2$  is a non-empty product of fourth powers of letters, the word  $x_1y_1^{-1}U_2$  ends with a third power of a letter, a contradiction.

The other statements of the lemma are proved similarly.  $\square$

A (quasi-)trapezium or a ring  $\Delta$  is of the *first (second, mixed) type* if its history is a word in  $\mathcal{S}$  (resp.  $\bar{\mathcal{S}}, \mathcal{S} \cup \bar{\mathcal{S}}$  but not  $\mathcal{S}$  or  $\bar{\mathcal{S}}$ ).

**Lemma 6.11.** *Let  $\Delta$  be a quasitrapezium of the first or mixed type with history of length 2. Let  $\mathcal{T}_1, \mathcal{T}_2$  be the two maximal  $\theta$ -bands of  $\Delta$  counting from the bottom up. Assume that  $\mathcal{T}_1$  is a  $\Theta$ -band. Let  $V$  be the label of  $\mathbf{top}(\mathcal{T}_1)$ . Then  $V_a$  cannot contain subwords  $a_i(z)^{-1}a_{i'}(z)$  if  $z \in \{K_j, L_j\}$  and it cannot contain subwords  $a_i(z)a_{i'}(z)^{-1}$  if  $z = R_j$ .*

*Proof.* We shall consider only the case  $z = L_j$  because other cases are similar. Suppose that  $V_a$  contains a subword  $a_i(L_j)^{-1}a_{i'}(L_j)$ . Let  $\mathcal{B}_1, \mathcal{B}_2$  be the two neighbor  $a$ -bands starting on  $\mathbf{top}(\mathcal{T}_1)$  and ending on  $\mathbf{bot}(\mathcal{T}_2)$  corresponding to this subword, i.e.  $\mathcal{B}_1$  is a  $a_i(L_j)^{-1}$ -band,  $\mathcal{B}_2$  is a  $a_{i'}(L_j)$ -band.

Let  $\Gamma$  be the subdiagram of  $\Delta$  which is situated between  $\mathcal{B}_1$  and  $\mathcal{B}_2$ , i.e. it is bounded by  $\mathbf{bot}(\mathcal{B}_1)$  and  $\mathbf{top}(\mathcal{B}_2)$ , a portion of  $\mathbf{top}(\mathcal{T}_1)$ , and a portion of  $\mathbf{bot}(\mathcal{T}_2)$ . Let  $\partial(\Gamma) = u_1qu_2p^{-1}$  be the decomposition of the boundary of  $\Gamma$  where  $u_1 = \mathbf{bot}(\mathcal{B}_1)$ ,  $u_2 = \mathbf{top}(\mathcal{B}_2)^{-1}$ .

Notice that the start (end) edges of  $\mathcal{B}_1$  and  $\mathcal{B}_2$  on  $\mathbf{top}(\mathcal{T}_1)$  (resp.  $\mathbf{bot}(\mathcal{T}_2)$ ) belong to two different cells  $\pi_1, \pi'_1$  (resp.  $\pi_2, \pi'_2$ ) because in every  $\theta$ -cells a edges labelled by  $a$ -letters in opposite exponents are always separated by a  $\theta$ -edge: this is obvious for relations (2.7) and relations (2.6) corresponding to rules not from  $\mathcal{S}(34) \cup \bar{\mathcal{S}}(34)$ ; for the remaining relations it follows from the assumption that all words in  $\bar{\mathcal{E}}$  are positive.

Notice also that by definition, the word  $\alpha_{\tau \pm 1}(a_i(z))$  is completely determined by its  $x$ -letter. Suppose that  $|p| \leq 1$ . This means that the two  $x$ -letters in the relations corresponding to the cells  $\pi_1, \pi'_1$  cancel. That implies, by Lemma 6.1, that the labels of the start edges of  $\mathcal{B}_1, \mathcal{B}_2$  must be mutually inverse which contradicts the assumption that  $\phi(\mathbf{top}(\mathcal{T}_1))$  is a reduced word. Hence  $|p| = 2$ ,  $\phi(p) = x_1y_1^{-1}$ ,  $x, y \in \mathcal{X}^{\pm 1}$ ,  $x_1 \neq y_1^{\pm 1}$ . Similarly if  $\mathcal{T}_2$  corresponds to a rule from  $\mathcal{S}$ ,  $|q| = 2$ ,  $\phi(q) = x_2y_2^{-1}$ ,  $x_2, y_2 \in \mathcal{X}^{\pm 1}$ ,  $x_2 \neq y_2^{\pm 1}$ .

Let  $U_1 \equiv \phi(u_1)$ ,  $U_2 \equiv \phi(u_2)$ . Since  $\Gamma$  contains no cells (by Lemma 3.11), the equality  $U_1\phi(q)U_2\phi(p)^{-1} = 1$  must be true in the free group.

**Case 1.** Suppose that  $\mathcal{T}_2$  corresponds to a rule from  $\bar{\mathcal{S}}$ . Then  $U_1U_2y_1x_1^{-1} = 1$  in the free group where  $U_1, U_2$  are reduced products of fourth powers of letters from  $\mathcal{X}^{\pm 1}$ . Considering the homomorphism of the free group onto  $\mathbb{Z}$  which kills all letters except  $x_1$ , we immediately get a contradiction.

**Case 2.** Suppose now that  $\mathcal{T}_2$  corresponds to a rule from  $\mathcal{S}$ . Then the equality  $U_1x_2y_2^{-1}U_2y_1x_1^{-1} = 1$  is true in the free group. Taking the projections on  $\langle x_1 \rangle, \langle x_2 \rangle$  as in Case 1, we deduce that  $x_1 \equiv x_2, y_1 \equiv y_2$ .

**Case 2.1.** Suppose that  $U_1, U_2$  are not empty. Then Lemma 6.10 (1) immediately gives a contradiction.

**Case 2.2.** Suppose that one of the words  $U_1$  or  $U_2$  is empty. Then the other word must be empty as well (these words are freely conjugate and reduced). Notice that the paths  $u_1,$

$u_2$  cannot contain consecutive edges with mutually inverse edges because otherwise the cells containing these edges cancel (they correspond to relations of the form (2.8) with the same  $a$ -letter). Hence the paths  $u_1$  and  $u_2$  are empty. Therefore the cells  $\pi_1$  and  $\pi_2$  have a common  $x$ -edge and a common  $a$ -edge. Since these two cells do not cancel ( $\Delta$  is reduced), one of them corresponds to a relation of the form 2.6 and the other one corresponds to a relation of the form 2.7. (If these cells are both  $k$ -cells, then it is clear from the structure of the  $a$ -bands between  $\pi_1$  and  $\pi_2$ , that  $\mathcal{B}_1$  determines equal occurrences of  $a$ -letters in the boundary labels of  $\pi_1$  and  $\pi_2$ .) Without loss of generality we can assume that  $\pi_1$  corresponds to a relation of the form (2.6) and  $\pi_2$  corresponds to a relation of the form (2.7). The  $\Theta$ -edges on these cells have the same labels (up to the direction) because the label of the  $\Theta$ -edge is encoded in the  $x$ -edges of a relation (2.6) or (2.7). Hence  $\mathcal{T}_1$  and  $\mathcal{T}_2$  correspond to mutually inverse rules of  $\mathcal{S}$ .

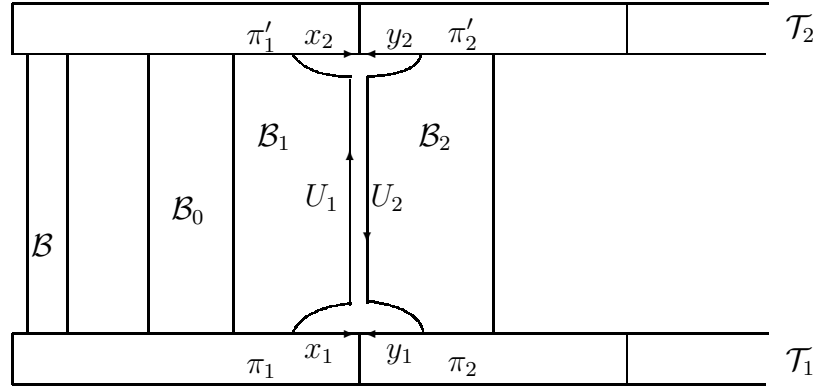

Figure 19.

Let  $\mathcal{B}$  be the  $k$ -band starting on the  $k$ -edge of the cell  $\pi_1$  (that belongs to  $\mathbf{top}(\mathcal{T}_1)$ ) and ends on a  $k$ -edge of  $\mathbf{bot}(\mathcal{T}_2)$ . Assume that there is an  $a$ -band  $\mathcal{B}_0$  connecting  $\mathcal{T}_1$  and  $\mathcal{T}_2$  between  $\mathcal{B}$  and  $\mathcal{B}_1$ . Assume that it is the closest one to  $\mathcal{B}_1$ . Notice that it starts with an edge of  $\mathbf{top}(\mathcal{T}_1)$  labelled by a negative  $a$ -letter, since the all  $a$ -labels of  $a$ -edges of  $\pi_1$ , situated between a  $k$ -edge and a  $\theta$ -edge, are positive or negative simultaneously.

Consider the subdiagram  $\Gamma^0$  between  $\mathcal{B}_0$  and  $\mathcal{B}_1$ . Its contour has decomposition  $u_1^0 q^0 u_2^0 (p^0)^{-1}$  similar to the decomposition  $u_1 q u_2 p^{-1}$  of the contour of  $\Gamma$ . Now we obtain the equality  $U_1^0 x U_2^0 x^{-1} = 1$  in the free group for the boundary label of  $\Gamma^0$ . Here  $U_2^0$  must be empty since the word  $U_1$  was empty. Hence  $U_1^0$  is empty being the product of forth powers of  $x$ -letters. There are fewer maximal  $a$ -bands between  $\mathcal{B}$  and  $\mathcal{B}_0$  than between  $\mathcal{B}$  and  $\mathcal{B}_1$ . Therefore, arguing in this way, we finally conclude that  $\phi(\mathbf{bot}(\mathcal{B}))$  is empty too. But then  $\pi_1$  and  $\pi_2$  must have a common  $k$ -edge, and they cancel because  $\mathcal{T}_1$  and  $\mathcal{T}_2$  correspond to mutual inverse rules of  $\mathcal{S}$ . This contradicts the fact that  $\Delta$  is reducible.  $\square$

If the base of a trapezium  $\Delta$  is a 2-letter word, and its height is equal to 2, then  $\Delta$  is called a *small trapezium*.

**Lemma 6.12.** *Let  $\Delta$  be a small trapezium of the first or mixed type with reduced history. Then the projection of the words  $V_1 = \phi(\mathbf{top}(\mathcal{T}_1))$ ,  $V_2 = \phi(\mathbf{bot}(\mathcal{T}_2))$  onto  $\mathcal{A} \cup \bar{\mathcal{A}} \cup \mathcal{K}$  are admissible words for  $\mathcal{S}$ .*

*Proof.* By Lemma 6.9, we need only check the positivity conditions of the definition of admissible words. Also it is clear that it is enough to prove the statement for  $V_1$ . Indeed, by Lemma 3.11 every  $a$ - and  $k$ -band starting on  $\mathbf{top}(\mathcal{T}_1)$  ends on  $\mathbf{bot}(\mathcal{T}_2)$  and vice versa; so the projections of  $V_1$  and  $V_2$  onto  $\mathcal{A} \cup \bar{\mathcal{A}} \cup \mathcal{K}$  are the same in the free group (in particular they do not contain  $\bar{\mathcal{A}}$ -letters).

Hence it is enough to consider the cases when  $\mathcal{T}_1$  corresponds to a rule from  $\mathcal{S}$ ,  $V_1$  is a  $zL_j$ -,  $zP_j$ - or  $R_jz$ -sector. All three cases are similar, so we consider only one of them when  $V_1$  is a  $zL_j$ -sector. We need to show that the projection of  $V_1$  onto  $\mathcal{A}$  is positive.

Suppose that  $V_1$  contains a negative letter  $a^{-1}$ ,  $a \in \mathcal{A}(\bar{L}_j)$ . First let  $a^{-1}$  be the last  $\mathcal{A}$ -letter of  $V_1$ . Since  $V_1$  and  $V_2$  are reduced, every  $a$ -band starting on  $\mathbf{top}(\mathcal{T}_1)$  ends on  $\mathbf{bot}(\mathcal{T}_2)$  and vice versa. In particular the  $a$ -band  $\mathcal{C}$  starting on the last  $\mathcal{A}$ -edge of  $\mathbf{top}(\mathcal{T}_1)$  ends on the last  $\mathcal{A}$ -edge of  $\mathbf{bot}(\mathcal{T}_2)$ , hence the last  $\mathcal{A}$ -letter of  $V_2$  is also  $a^{-1}$ .

Relations (2.6), (2.7) show that then  $V_1$  ends with  $a^{-1}x$  where  $x = x(b, \tau)^{\pm 1}$ , and  $V_2$  ends with  $a^{-1}x'$  where  $x' = x(c, \tau')^{\pm 1}$ , for some  $b, c \in \mathcal{A}$ . Let  $\Gamma$  be the diagram bounded by  $\mathbf{top}(\mathcal{C})$ ,  $\mathbf{bot}(\mathcal{B}')$ , a portion of  $\mathbf{top}(\mathcal{T}_1)$  and a portion of  $\mathbf{bot}(\mathcal{T}_2)$ . By Lemma 3.11 and 6.5,  $\Gamma$  contains no cells. Both words  $\phi(\mathbf{top}(\mathcal{C}))$  and  $\phi(\mathbf{bot}(\mathcal{B}'))$  are products of fourth powers of letters from  $\mathcal{X}$ , and  $x$  and  $x'$  are not mutually inverse because  $\tau' \neq \tau^{-1}$  by an assumption of the lemma. This immediately leads to a contradiction by Lemma 6.10 (2).

Thus the last  $a$ -letter of  $V_1$  (resp.  $V_2$ ) is positive. Since  $V_1$  contains a negative  $a$ -letter  $a^{-1}$ ,  $(V_1)_a$  must contain a subword of the form  $a^{-1}b$  for some  $b \in \mathcal{A}$ . But this contradicts Lemma 6.11.  $\square$

The next lemma shows how to get rid of  $\mathcal{G}$ -cells in some trapezia.

**Lemma 6.13.** *Let  $\Delta$  be a quasitrapezium of the first type. Suppose that the history of  $\Delta$  does not contain  $\tau \in \mathcal{S}(34) \cup \mathcal{S}(4) \cup \mathcal{S}(45)$  or the base of  $\Delta$  is empty. Then there exists a quasitrapezium  $\Delta'$  of the first type such that*

- $\Delta'$  has the same labels of the bottom, left and right sides as  $\Delta$ ,
- $\phi(\mathbf{top}(\Delta)) = \phi(\mathbf{top}(\Delta'))$  modulo  $\mathcal{G}$ -relations
- $\Delta'$  has no  $\mathcal{G}$ -cells and the type of  $\Delta'$  is not higher than that of  $\Delta$ .

*Proof.* We only consider the case when  $\Delta$  is a trapezium with non-empty base. The other cases are similar.

If  $\Delta$  does not contain  $\mathcal{G}$ -cells then we can take  $\Delta' = \Delta$ , so suppose that  $\Delta$  contain  $\mathcal{G}$ -cells.

Suppose there is a small subtrapezium  $\Gamma$  in  $\Delta$  with base  $yz$  where  $yz$  is one of the words  $(P_1R_1)^{\pm 1}$ ,  $P_1P_1^{-1}$ ,  $R_1^{-1}R_1$ . Assume that  $\Gamma$  is crossed by maximal  $\theta$ -bands  $\mathcal{T}_i$  and  $\mathcal{T}_{t+1}$ . Denote  $q_1 = \mathbf{bot}(\mathcal{T}_i), \dots, q_4 = \mathbf{top}(\mathcal{T}_{t+1})$ . Let  $V_i = \phi(q_i)$ ,  $i = 1, \dots, 4$ . Notice that  $V_2, V_3, V_4$  are words over  $\mathcal{A}(P_1)$  by Lemmas 6.1, 6.3 and  $V_2 = V_3$  modulo  $\mathcal{G}$ -relations by Lemma 6.6.

Denote by  $\Gamma_0$  the subdiagram of  $\Gamma$  with the boundary label  $V \equiv V_2V_3^{-1}$ . Assume  $\Gamma_0$  contains at least one  $\mathcal{G}$ -cell. Then by Lemma 3.9 it has exactly one  $\mathcal{G}$ -cell and no other cells.

Let  $\tau$  be the history of  $\mathcal{T}_{t+1}$ . We cut  $\mathcal{T}_{t+1}$  along a  $\theta(\tau, P_1)$ -edge and the boundary of  $\Gamma_0$  to obtain a closed subpath  $p$  labelled by the word  $\theta(\tau, P_1)^{-1}V\theta(\tau, P_1)$ . It is freely equal to  $\theta(\tau, P_1)^{-1}V\theta(\tau, P_1)V^{-1}V$ . Removing the subdiagram bounded by this loop, we get a hole in the diagram  $\Delta$ .

Recall that  $\theta(\tau, P_1)$  commutes with  $\mathcal{A}(P_1)$ -letters by relations (2.6), since  $\tau$  does not belong to  $\mathcal{S}(34) \cup \mathcal{S}(4) \cup \mathcal{S}(45)$  by the assumptions of the lemma.

Hence there exists a  $\theta$ -band with boundary label  $\theta(\tau, P_1)^{-1}V\theta(\tau, P_1)V^{-1}$ . If we connect a  $\mathcal{G}$ -cell by a vertex to the end of the first  $\theta$ -cell of this band, we get a diagram  $\Gamma_1$  with boundary label freely equal to  $\phi(p)$ . Now we can fill the hole bounded by  $p$  by the diagram  $\Gamma_1$ . As a result the  $\theta$ -bands of  $\Delta$ , except  $\mathcal{T}_{t+1}$  do not change, the band  $\mathcal{T}_{t+1}$  gets longer, and the  $\mathcal{G}$ -cell moves outside  $\Gamma$  toward the top of  $\Delta$ . Let  $\tilde{\Delta}$  be the resulting diagram, and  $\Delta_1$  be the diagram obtained by reducing  $\tilde{\Delta}$ .

Two  $k$ -cells of the same  $k$ - or  $\theta$ -band in  $\tilde{\Delta}$  cannot form a reducible pair of cells (see (ii) in the definition of non-reduced diagram) because otherwise diagram  $\Delta$  were not reduced. Hence  $k$ -cells are not removed in the process of reducing  $\tilde{\Delta}$ .

This implies that  $\Delta_1$  satisfies the definition of a trapezium. The height of  $\Delta_1$  is the same as the height of  $\Delta$ , the diagram between  $\mathcal{T}_1$  and  $\mathcal{T}_{t+1}$  in  $\Delta_1$  contains fewer  $\mathcal{G}$ -cells than the corresponding subdiagram of  $\Delta$ . Hence after a number of such transformations, we get a trapezium  $\Delta_s$  with the same boundary label as  $\Delta$ , and all  $\mathcal{G}$ -cells in  $\Delta_s$  are between  $\mathbf{top}(\mathcal{T}_d)$  and the top path  $p_2$ . Notice that  $\Delta_s$  has the same number of  $k$ - and  $\mathcal{G}$ -cells as  $\Delta$  but possibly bigger number of auxiliary  $(\theta, a)$ -cells.

For every  $\mathcal{G}$ -cell  $\pi$  in  $\Delta_s$ , there exists a path in  $\Delta_s$  which does not cross any  $\theta$ -bands and connects  $\pi$  with  $p_2$ . Hence all  $\mathcal{G}$ -cells in  $\Delta_s$  can be cut off from  $\Delta_s$  without changing the bottom, left and right sides of  $\Delta_s$ . The label of the top side does not change modulo  $\mathcal{G}$ -relations. After we remove all  $\mathcal{G}$ -cells from  $\Delta_s$ , we get a trapezium  $\Delta'$  satisfying the first two of the required conditions. Since  $\Delta$  contains  $\mathcal{G}$ -cells, the type of  $\Delta'$  is smaller than the type of  $\Delta$ : to obtain  $\Delta'$  from  $\Delta$ , we add auxiliary  $\theta$ -cells and remove  $\mathcal{G}$ -cells.  $\square$

**Lemma 6.14.** *For every quasiring  $\Delta$  with empty base and contours  $p$  and  $q$  there exists a quasiring with the same boundary labels and recursively bounded number of cells.*

*Proof.* By Lemma 5.6 we can assume that  $\Delta$  satisfies condition (R1).

By the definition, there is an  $a(z)$ -band, connecting  $p$  and  $q$ , in  $\Delta$ . Since the base of  $\Delta$  is empty, every  $\theta$ -cell of  $\Delta$  must be an  $\mathcal{A}(z)$ -cell, and  $z \neq P_1$  by the definition of a quasiring.

Denote by  $\Delta'$  the minimal annular subdiagram of  $\Delta$  which contains all the  $\theta$ -annuli of  $\Delta$ . It contains no  $\mathcal{G}$ -cells by Lemma 6.5(2). Hence every  $a$ -band starting on  $p$  ends on  $q$  and vice versa. Therefore the length of arbitrary  $\theta$ -annulus is linearly bounded in terms of  $|p|, |q|$ , and we have the bounded number of possibilities for their labels. Since  $\Delta$  is reduced, we conclude that the number of its  $\theta$ -annuli is also recursively bounded. The statement is obtained after the application of Lemma 4.4 to the remaining annular subdiagrams of  $\Delta$  which are diagrams over  $\mathcal{H}_1$ .  $\square$

The following lemma shows that trapezia of the first type simulates the work of  $\mathcal{S}$ . Notice that this lemma does not follow from Lemma 6.9 because admissible words for  $\mathcal{S}$

differ from admissible word for  $\mathcal{S} \cup \bar{\mathcal{S}}$ .

**Lemma 6.15.** *Let  $\Delta$  be a trapezium of the first type with base  $B$  and the reduced history  $h = \tau_1 \cdot \dots \cdot \tau_d$ ,  $\tau_i \in \mathcal{S}$ ,  $d \geq 2$ , with  $\theta$ -bands  $\mathcal{T}_1, \dots, \mathcal{T}_d$ . Let  $W$  (resp.  $W'$ ) be the projection of the label of the bottom (resp. top) path of  $\Delta$  onto  $\mathcal{A} \cup \bar{\mathcal{A}} \cup \mathcal{K} \cup \bar{\mathcal{K}}$ ,  $U_i$  (resp.  $V_i$ ),  $i = 1, \dots, d$ , be the projection of  $\phi(\mathbf{bot}(\mathcal{T}_i))$  (resp.  $\phi(\mathbf{top}(\mathcal{T}_i))$ ) on the same set. Then  $U_2, \dots, U_d, V_1, \dots, V_{d-1}$  are admissible words for  $\mathcal{S}$ . In addition*

$$\begin{aligned} W &= U_1(\text{mod } \mathcal{G}), ||V_1| - |U_1|| \leq c|B|, U_2 = V_1(\text{mod } \mathcal{G}), V_2 = U_2 \circ \tau_2, \\ ||V_2| - |U_2|| &\leq c|B|, \dots, V_{d-1} = U_{d-1} \circ \tau_{d-1}, ||V_{d-1}| - |U_{d-1}|| \leq c|B|, \\ U_d &= V_{d-1}(\text{mod } \mathcal{G}), ||V_d| - |U_d|| \leq c|B|, W' = V_d(\text{mod } \mathcal{G}) \end{aligned}$$

where  $c$  is the maximum of lengths of words in  $\bar{\mathcal{E}}$ . If  $\Delta$  does not contain  $\mathcal{G}$ -cells then one can remove “(mod  $\mathcal{G}$ )” from the previous statement (i.e. all equalities will be true in the free group).

*Proof.* The proof is similar to the proof of Lemma 6.9. The fact that  $U_2, \dots, U_d, V_1, \dots, V_{d-1}$  are admissible words for  $\mathcal{S}$  follows from Lemma 6.12.  $\square$

The definition of admissible words for  $\bar{\mathcal{S}}$  does not have the positivity conditions. This makes analysis of computations of  $\bar{\mathcal{S}}$  different from the analysis of computations of  $\mathcal{S}$ . On the one hand the analysis of computations of  $\bar{\mathcal{S}}$  is more difficult because there are more possible bases of admissible words for  $\bar{\mathcal{S}}$ . On the other hand the following lemma which is an immediate corollary of Lemma 3.3, part 2, allows us to replace any computation of the form  $U \bullet h = V$  of  $\bar{\mathcal{S}}$  by any other computation with the same initial and terminal words. In the case of computations over  $\mathcal{S}$  the possibilities of modifying the computation were very limited: we could only replace  $h$  by a reduced form of  $h$  or we could remove certain subwords of  $h$  (which fix certain admissible words).

We call a computation  $U \bullet h = V$  *reduced* if the word  $h$  is freely reduced.

**Lemma 6.16.** *For every reduced computation  $U \bullet h = V$  of  $\bar{\mathcal{S}}$  there exists a trapezium with top label  $V$ , bottom label  $U$ , and history  $h$ . If  $U = U'z$ ,  $V = V'z_1$  where  $z$  (resp.  $z_1$ ) coincides with the first letter of  $U'$  (resp.  $V'$ ) then for every computation  $U \bullet h = V$  of  $\bar{\mathcal{S}}$  there exists a ring of type 2 with boundary labels  $U'$  and  $V'$ .*

*Proof.* Assume that  $|h| = 1$ , and  $h = \tau \in \mathcal{S}^+$ . We consider a path  $p$  on the plane labelled by  $U$ . To every its  $a$ -edge we attach a cell corresponding to an appropriate  $\bar{\Theta}$ -analog of relation (2.7) which in turn corresponds to the rule  $\tau$ . Similarly, to every  $k$ -edge of  $p$  we attach a cell corresponding to (2.6). Then the  $\bar{\Theta}$ -edges of the neighbor cells should be identified. We get a  $\bar{\Theta}$ -band  $\mathcal{T}$ . (Of course we identify some other labels, if necessarily, to obtain a reduce label of the  $\mathbf{top}(\mathcal{T})$ .) The form of these relations shows that we obtain a band  $\mathcal{T}$  with top label graphically equal to  $V$ .

Two  $k$ -cells of  $\mathcal{T}$  cannot form reducible pair of  $k$ -cells since the admissible words  $U$  and  $V$  have no subwords  $z^{\pm 1}z^{\mp 1}$  for a  $k$ -letter  $z$ . Hence  $\mathcal{T}$  is a reduced diagram.

Similarly, one can construct  $\mathcal{T}$  if  $\tau \in \mathcal{S}^-$ .

If  $|h| = d > 1$ , then we should construct the a diagram  $\Delta$  gluing together  $d$  bands  $\mathcal{T}_1, \dots, \mathcal{T}_n$ , corresponding to the letters of the history  $h$ . Two cells from distinct bands

cannot form a reducible pair since the history  $h$  is reduced. Hence  $\Delta$  is a reduced diagram, and it is the desired trapezium.

To prove the second statement, we notice that in this case the resulting trapezium is bounded by two  $k$ -bands which are copies of each other. Hence we can identify them to get the desired ring (or if the resulting annular diagram is compressible, then there is a ring of smaller type) with the same boundary labels. However we should verify that the words  $U', V'$  are not conjugates in  $\mathcal{H}_1$  of words having fewer occurrences of  $k$ -letters. Assume there is a reduced annular diagram for such a conjugation with contours  $p$  and  $q$  where  $\phi(p) \equiv U$ . Then there must be a  $k$ -band  $\mathcal{B}$  which starts and ends on  $p$  such that there are no  $k$ -bands in the simply connected subdiagram  $\Gamma$  bounded by  $\mathcal{B}$  and  $p$ . The subdiagram  $\Gamma$  contains no  $\theta$ -edges by Lemma 3.11 since  $\phi(p)$  has no  $\theta$ -letters. Therefore the word  $u$  written between corresponding mutual inverse  $k$ -letters of  $U$  is equal to a word having no  $a$ -letters. Hence if  $|u| > 0$ , then there must be an  $a$ -band in  $\Gamma$ , which starts and ends on  $p$ , and gives a cancellation in  $u$ . If  $|u| = 0$  then the  $k$ -letters cancel. In both cases we get a contradiction to the fact that the admissible word  $U$  must be reduced.  $\square$

## 7 Computations of $\mathcal{S} \cup \bar{\mathcal{S}}$

Notice that if we cut a ring along the top side of a  $k$ -band  $\mathcal{B}$ , we get a rectangular van Kampen diagram. If we then attach a copy of  $\mathcal{B}$  along its top side to one of the sides of the rectangle, we get a trapezium  $\Delta$  with boundary  $p_1 p_2 p_3 p_4$  which satisfies one additional property that  $p_1, p_3^{-1}$  are sides of two copies of the same  $k$ -band (the band  $\mathcal{B}$ ). The top and bottom sides of  $\Delta$  are the outer and inner boundary components of the initial ring.

As we know (see Lemma 6.9), with every trapezium  $\Delta$  with bottom label  $U$  and top label  $V$ , we can associate a computation  $U_{\setminus x} = W_0, W_1 = W_0 \circ \sigma_1, \dots, W_n = W_{n-1} \circ \sigma_n = V_{\setminus x}$  of the machine  $\mathcal{S} \cup \bar{\mathcal{S}}$  (modulo  $\mathcal{G}$  if the trapezium contains  $\mathcal{G}$ -cells). Here  $U_{\setminus x}$  and  $V_{\setminus x}$  are obtained from  $U$  and  $V$  by deleting their  $x$ -letters. The words  $W_i$  are the  $\mathcal{A} \cup \bar{\mathcal{A}} \cup \mathcal{K} \cup \bar{\mathcal{K}}$ -projections of the labels of sides of  $\theta$ -bands in  $\Delta$ .

Computations modulo  $\mathcal{G}$  will be called  $\mathcal{G}$ -computations. Previously considered computations will be called *free*. The concept of admissible word  $W$  is defined naturally for  $\mathcal{G}$ -computations: we add to the reducibility of such a word that  $W$  has subwords neither of the form  $P_1 u P_1^{-1}$  nor of the form  $R_1^{-1} u R_1$  for a word  $u$  in  $\mathcal{A}(P_1)$ -letters which is equal to 1 modulo  $\mathcal{G}$ -relations. Locked sectors are defined naturally for  $\mathcal{G}$ -computations as well (if a rule locks a  $zz_+$ -sector then all admissible words in the domain of the rule must have  $zz_+$ -sectors with empty modulo  $\mathcal{G}$ -relations inner parts). Notice that  $\mathcal{G}$ -computations can be viewed as computations of  $\mathcal{S}$ -machines obtained from  $\mathcal{S} \cup \bar{\mathcal{S}}$  by replacing the free product of  $\mathcal{G}$  and the free group over  $\{a_{m+1}(P_1), \dots, a_{\bar{m}}(P_1)\}$  for the free subgroup generated by  $\mathcal{A}(P_1)$  in the hardware.

Notice that if  $U^{\pm 1}$  does not contain  $P_1 z$ - or  $z R_1$ -sectors then free computations and computations modulo  $\mathcal{G}$  are the same. Also any computation of  $\bar{\mathcal{S}}$  is free.

Given a ring  $\Delta$ , by Lemma 6.15, we get a  $\mathcal{G}$ -computation  $U_1 \bullet \sigma_1 \dots \sigma_d = V_d$ . Suppose that we have recursively bounded the number  $d$  in terms of the lengths of the contours of the diagram. If the base of the ring contains  $P_j$  or  $R_j$  for some  $j$  then we can cut the ring along a side of the corresponding  $k$ -band which does not contain  $x$ -edges. This side

is of bounded length, the resulting diagram will be simply connected. Now using Lemma 5.1, we can recursively bound the number of cells in a ring.

If the base does not contain  $P_j$  and  $R_j$  for any  $j$  then, to bound the number of cells in  $\Delta$  from above, we can assume by lemmas 6.4 and 6.5 that the ring does not contain  $\mathcal{G}$ -cells. Therefore the words  $U_i, V_i$  are of recursively bounded lengths. By Lemma 4.4, the number of cells between any two consecutive  $\theta$ -annuli in  $\Delta$  is bounded.

In both cases the history of the the resulting ring coincides with the history of  $\Delta$  because it cannot be shortened by condition (iv) in the definition of a reduced diagram  $\Delta$ . Thus we obtain

**Lemma 7.1.** *If the length of the computation corresponding to a ring  $\Delta$  is recursively bounded, then there exists a ring with the same boundary labels and the same history as  $\Delta$  whose number of cells is recursively bounded in terms of lengths of boundaries of  $\Delta$ .*

If a computation (a  $\mathcal{G}$ -computation) corresponds to a ring we call it a *free ring computation* (a *ring computation*). A ring computation is a reduced computation by Lemma 6.8.

For every word  $h$  and every natural  $t \leq |h|$  we denote the prefix of  $h$  of length  $t$  by  $h[t]$ .

**Lemma 7.2.** *If  $U \bullet h = V$  is a ring computation then  $U \bullet h[t]$  is also a ring computation for every  $t = 1, \dots, |h|$ .*

*Proof.* The computation  $U \bullet h[t]$  corresponds to a subring of the ring corresponding to  $U \bullet h = V$  containing the first  $t$   $\theta$ -bands of that ring.  $\square$

By definition the *base of a computation* is the base of the starting word  $U$  (which is the same as the base of  $V$ ), and the *history of computation*  $U \bullet h$  is  $h$ . This agrees with the definitions of the base and the history of a trapezium.

**Remark 7.1.** When we cut a ring to make a trapezium, we can choose any of the  $k$ -bands of the ring. Thus any letter of the base of the ring can be chosen to be the first letter (and the last letter) of the base of the computation. Also by taking a mirror image of a trapezium, we get a trapezium with inverse base. For simplicity let us always assume that if the base of a ring computation contains a letter  $K_1^{\pm 1}$ , then the base starts and ends with  $K_1$ .

Here is a translation of Lemma 6.13 into the language of computations. We leave it as an exercise to the reader to translate the proof of Lemma 6.13 as well.

**Lemma 7.3.** *Let  $U \bullet h = V$  be a ring computation of  $\mathcal{S}$ . Suppose that  $h$  does not contain letters from  $\mathcal{S}(34) \cup \mathcal{S}(4) \cup \mathcal{S}(45)$ . Then there exists a free ring computation  $U \bullet h = V'$  where  $V = V'$  modulo  $\mathcal{G}$ .*

## 7.1 Brief history

**Lemma 7.4.** *Let  $U \bullet h = V$  be a reduced free computation of  $\mathcal{S}(g)$  or of  $\bar{\mathcal{S}}(g)$ ,  $g = 1, \dots, 5$ , with  $|h| = 2$ ,  $h = \sigma_1 \sigma_2$ . Suppose that  $U$  is a  $zz_+$ -sector. Then inequalities  $|U| < |U \circ \sigma_1| > |V|$  cannot happen simultaneously.*

*Proof.* Indeed, the definition of  $\mathcal{S} \cup \bar{\mathcal{S}}$  shows that if  $|U| < |U \circ \sigma_1|$ ,  $\sigma_1 \in \mathcal{S} \cup \bar{\mathcal{S}}$ , then, depending on  $g$ ,  $(U \circ \sigma_1)_a = U_ab$ , or  $(U \circ \sigma_1)_a = bU_a$ ,  $b \in \mathcal{A} \cup \bar{\mathcal{A}}$ , where  $U_ab$  (resp.  $bU_a$ ) is a freely reduced word, and  $\sigma_1$  is completely determined (by Lemma 2.6 among the rules from  $\mathcal{S}(g)$  by the letter  $b$ ). If in addition  $|V| < |U \circ \sigma_1|$ , then  $V_a = U_ab b^{-1}$  (resp.  $V_a = b^{-1}bU_a$ ) since  $V = (U \circ \sigma_1) \circ \sigma_2$ . Therefore  $\sigma_2 = \sigma_1^{-1}$ , a contradiction with the assumption that the computation  $U \bullet h = V$  is reduced.  $\square$

Lemma 7.4 immediately implies the following

**Lemma 7.5.** *Let  $U \bullet h = V$  be a reduced free computation of  $\mathcal{S}(g)$  or of  $\bar{\mathcal{S}}(g)$ ,  $g = 1, \dots, 5$ , and  $U$  is a  $zz_+$ -sector. Suppose that rules of  $\mathcal{S}(g)$  are active with respect to  $zz_+$ -sectors. Then the length  $|h|$  is at most  $|U| + |V|$ .*

Let  $U \bullet h = V$  be a computation. A maximal nonempty subword of  $h$  consisting of rules from  $\mathcal{S}(\omega)$  for a given  $\omega \in \Omega = \{1, 2, 3, 4, 5\}$  will be called an *age* of  $(\omega)$  in the computation. The word  $h$  has a unique decomposition  $g_1 h_1 g_2 h_2 \dots$  where  $g_i$  are transition rules ( $g_1$  may be missing) and  $h_i$  are ages ( $i = 1, 2, \dots$ ). If  $g_i \in \mathcal{S}(\omega'_i)$ ,  $h_i$  is an age of  $\omega_i$ ,  $i = 1, 2, \dots$ , then the word  $(\omega'_1)(\omega_1)(\omega'_2)(\omega_2) \dots$  will be called the *brief history* of the computation  $U \bullet h = V$  and is denoted by  $br(h)$ .

**Lemma 7.6.** *Let  $U \bullet h = V$  be a free reduced computation of  $\mathcal{S}$  or  $\bar{\mathcal{S}}$ . Suppose that  $U$  is a  $zz_+$ -sector, and for some  $\omega, \omega' \in \Omega$ , rules from  $\mathcal{S}(\omega)$  lock  $zz_+$ -sectors and rules from  $\mathcal{S}(\omega')$  are active with respect to  $zz_+$ -sectors. Then the brief history  $br(h)$  does not contain subwords  $(\omega)(\omega')(\omega)$ .*

*Proof.* Suppose that  $br(h) = \beta_1(\omega)(\omega')(\omega)\beta_2$  for some prefix  $\beta_1$  and some suffix  $\beta_2$ . Let  $h = h_1 h_2 h_3 h_4 h_5$  be the corresponding decomposition of  $h$ . Since rules from  $\mathcal{S}(\omega)$  lock  $zz_+$ -sectors, we have that the words  $(U \circ h_1 h_2)_a$  and  $(U \circ h_1 h_2 h_3 h_4)_a$  are empty. Since rules from  $h_3$  are active with respect to  $zz_+$ -sectors, and are from the same  $\mathcal{S}(\omega')$ , there exists a word  $u$  in  $\mathcal{A} \cup \bar{\mathcal{A}}$  such that  $(U \circ h_1 h_2 \sigma_3)_a$  is freely equal to either  $(U \circ h_1 h_2)_a u$  or  $u(U \circ h_1 h_2)_a$ . Hence  $u$  is freely equal to 1. Since by Lemma 2.6 each letter in  $u$  and  $\omega'$  uniquely determines a rule in  $\mathcal{S}$  (or  $\bar{\mathcal{S}}$ ), we conclude that  $h_3$  is not freely reduced or empty, a contradiction.  $\square$

Consider a brief history of the form  $h \equiv (12)(2)(23)(3)(34)(4)(45)(5)(51)$ . Any word of the form  $h^{\pm 1}$  will be called a *historical period*. (We set here  $(1)^{-1} = (1)$ ,  $(12)^{-1} = (12), \dots$ , though one can prefer formula  $(12)^{-1} = (21)$ .)

**Lemma 7.7.** *Suppose that the base of a free reduced computation  $U \bullet h = V$  of  $\mathcal{S}$  or  $\bar{\mathcal{S}}$  contains a subword  $\overleftarrow{L}_j \overleftarrow{L}_j P_j \overleftarrow{R}_j \overleftarrow{R}_j$  for  $j \neq 1$ . Then  $br(h)$  is a subword of a word of the form*

$$f_0 h_1 f_1 \dots h_s f_s$$

where  $h_1, \dots, h_s$  are historical periods and each of (possibly empty) words  $f_0, \dots, f_s$  are ages of (1).



*Proof.* Indeed, notice that for every  $g = 2, 3, 4, 5$  rules in  $\mathcal{S}(g)$  are active with respect to  $zz_+$ -sectors for at least two letters  $z$  occurring in  $\overleftarrow{L}_j L_j P_j R_j \overrightarrow{R}_j$ , and each rule from  $\mathcal{S}(gg') \cup \bar{\mathcal{S}}(gg') \cup \mathcal{S}(g'g) \cup \bar{\mathcal{S}}(g'g)$  locks one of these two sectors. Now using Lemma 7.6, we can conclude that  $\text{br}(h)$  does not contain subwords of the form  $(g'g)(g)(g'g)$  for any  $g$ . This immediately implies that  $\text{br}(h)$  has the desired form.  $\square$

**Lemma 7.8.** *Let  $U \bullet h = V$  be a ring computation of  $\mathcal{S}$  (and the first and the last letters of the base  $B$  of  $U$  the same). Then  $\text{br}(h)$  does not contain subwords  $(12)(2)(12)$ ,  $(23)(2)(23)$ ,  $(23)(3)(23)$ ,  $(34)(4)(34)$ ,  $(45)(4)(45)$ , and  $(51)(5)(51)$ .*

*Proof.* Notice that since the first and the last letters in the base  $B$  are the same, for every letter  $z$  occurring in  $B$ ,  $U$  contains a  $zz'$ -sector (for some  $z'$ ).

Let  $\text{br}(h)$  contain a subword  $(12)(2)(12)$ . First assume that the base  $B$  contains  $L_j$  or  $\overleftarrow{L}_j$  for some  $j$ . Since  $\text{br}(h)$  contains  $(12)$  and rules from  $\mathcal{S}(12)$  lock  $zL_j$ -sectors, we can conclude that  $B$  contains a subword  $\overleftarrow{L}_j L_j$  (here we use the assumption that the first and the last letters in  $B$  are the same, otherwise we could have  $L_j$  as the first letter in  $B$ , and  $B$  could contain no copies of  $\overleftarrow{L}_j L_j$ ). Since rules of  $\mathcal{S}(2)$  are active with respect to  $\overleftarrow{L}_j L_j$ -sectors, we get a contradiction with Lemma 7.6. Therefore we can assume that  $B$  contains neither  $L_j$  nor  $\overleftarrow{L}_j$ . By passing to a subcomputation, we can assume that  $\text{br}(h) = (12)(2)(12)$ .

Notice that the rules from  $\mathcal{S}(12) \cup \mathcal{S}(2)$  do not change modulo  $\mathcal{G}$  the  $a$ -projections of admissible words without  $zL_j$ - and  $L_j z$ -sectors. Hence the  $a$ -projections of corresponding sectors in  $U$  and  $V$  are the same modulo  $\mathcal{G}$ . The  $\mathcal{E}$  and  $\Omega$ -coordinates of  $U$  and  $V$  are  $(1, \emptyset)$ . Hence  $U$  and  $V$  are equal modulo  $\mathcal{G}$ , and the labels of the corresponding  $\theta$ -annuli of the ring are equal modulo  $\mathcal{G}$ -relations too by Lemma 6.1. Hence the ring is not reduced (see condition (iv) in the definition of reduced diagram), a contradiction.

The other five statements can be proved by contradiction quite analogously.  $\square$

## 7.2 Standard computations

A computation  $U \bullet h = V$  of  $\mathcal{S}$  (of  $\bar{\mathcal{S}}$ ) is said to be *standard* or  *$j$ -standard* computation if its base has the form  $(\overleftarrow{L}_j L_j P_j R_j \overrightarrow{R}_j)^{\pm 1}$  and the computation is reduced. If  $U$  is an admissible word with this base then for each  $z \in \{\overleftarrow{L}_j, L_j, P_j, R_j\}$  let  $z(U)$  be the  $a$ -projection of the  $zz_+$ -sector in  $U$ .

**Lemma 7.9.** *Let  $U \bullet h = V$  be a reduced free computation of  $\mathcal{S}(g)$ ,  $g \in \{2, 3, 4, 5\}$ . Suppose that the base of the computation is  $\overleftarrow{L}_j L_j P_j$ ,*

(1) *The equality*

$$|\overleftarrow{L}_j(U)| + |L_j(U)| = |\overleftarrow{L}_j(U \circ h[t])| + |L_j(U \circ h[t])|$$

*holds for every  $t = 1, \dots, |h|$ .*

(2) *Let  $z \in \{\overleftarrow{L}_j, L_j\}$ . Then the sequence of lengths  $|z(U \circ h[t])|$ ,  $t = 0, 1, \dots$  is monotone.*

*Proof.* Indeed, since all words  $U \circ h[t]$  are admissible for  $\mathcal{S}$ , the words  $\overleftarrow{L}_j(U \circ h[t])$  and  $L_j(U \circ h[t])$  are positive for  $t = 1, \dots, |h|$ . If  $g \neq 2, 4$  then the rules  $\tau \in \mathcal{S}(g)$  are not active

with respect to  $\overleftarrow{L}_j L_j$ - and  $L_j P_j$ -sectors. Hence in that case the words  $U \circ h[t]$  are all the same ( $t = 1, \dots, |h|$ ) which proves (1) and (2).

If  $g \in \{2, 4\}$  then by Lemma 2.6 for every rule  $\tau \in \mathcal{S}(g)$  there exist two  $a$ -letters  $b_1 = b_1(\tau), b_2 = b_2(\tau)$  such that for every admissible word  $W$ , with base  $\overleftarrow{L}_j L_j P_j$ ,  $\overleftarrow{L}_j(W \circ \tau) = \overleftarrow{L}_j(W) b_1$ ,  $L_j(W \circ \tau) = b_2 L_j(W)$  and the rule  $\tau$  is completely determined by each of the letters  $b_1, b_2$ . Moreover  $b_1$  is a positive letter if and only if  $b_2$  is a negative letter. Since the words  $\overleftarrow{L}_j(U \circ h[t]), L_j(U \circ h[t])$  are always positive and  $h$  is reduced, we see that either for all  $\tau$  in  $h$  the letter  $b_1(\tau)$  is positive and the letter  $b_2(\tau)$  is negative, or for all letters  $\tau$  of  $h$ ,  $b_1(\tau)$  is negative and  $b_2(\tau)$  is positive. Therefore either for every  $t = 1, \dots, |h| - 1$ ,  $|\overleftarrow{L}_j(U \circ h[t+1])| = |\overleftarrow{L}_j(U \circ h[t])| + 1$  and  $|L_j(U \circ h[t+1])| = |L_j(U \circ h[t])| - 1$  or for every  $t = 1, \dots, |h| - 1$ ,  $|\overleftarrow{L}_j(U \circ h[t+1])| = |\overleftarrow{L}_j(U \circ h[t])| - 1$  and  $|L_j(U \circ h[t+1])| = |L_j(U \circ h[t])| + 1$ . This implies parts (1) and (2) again.  $\square$

For every word  $W$ , we denote by  $\text{diff}(W)$  the difference between the number of positive, and the number of negative occurrences of  $a$ -letters in a word  $W$ . Also let, as before,  $c$  be the maximal length of relations in  $\bar{\mathcal{E}}$ .

Let  $h$  be a word over  $\mathcal{S}$ . For every  $t \leq |h|$  let  $s(t)$  be the number of occurrences of rules from  $\mathcal{S}(34)$  in  $h[t]$ .

**Lemma 7.10.** *Let  $U \bullet h = V$  be a  $j$ -standard computation of  $\mathcal{S}$ ,  $j \neq 1$ . Suppose that for some  $z \in \{\overleftarrow{L}_j, L_j, R_j\}$ , and some  $t \leq |h|$*

$$|z(U \circ h[t])| > s(t)c + |U|. \quad (7.1)$$

*Then, for every  $d \geq t$ ,*

*(a) the  $d$ -th rule of  $h$  does not belong to  $\mathcal{S}(12) \cup \mathcal{S}(1) \cup \mathcal{S}(34) \cup \mathcal{S}(51)$  if  $z \in \{\overleftarrow{L}_j, R_j\}$  and the  $d$ -th rule of  $h$  does not belong to  $\mathcal{S}(34)$  if  $z = L_j$ ,*

*(b) if  $z \in \{\overleftarrow{L}_j, R_j\}$  then the word  $z(U \circ h[d])$  is not empty; if  $z = L_j$  then at least one of the words  $\overleftarrow{L}_j(U \circ h[d])$  or  $L_j(U \circ h[d])$  is not empty,*

*(c)  $|U \circ h[d]| \geq d - t$ .*

*Proof.* We may assume that the base of  $U$  has the form  $\overleftarrow{L}_j L_j P_j R_j \overrightarrow{R}_j$  because otherwise we can replace  $U$  by  $U^{-1}$ .

**Case 1.** Suppose that  $z = \overleftarrow{L}_j$ . Without loss of generality we can assume that  $t$  is the minimal number such that (7.1) holds. From (7.1), we have that  $t > 0$ .

Then the  $t$ -th rule of  $h$  belongs to  $\mathcal{S}(2) \cup \mathcal{S}(34) \cup \mathcal{S}(4)$  because otherwise  $\overleftarrow{L}_j(U \circ h[t-1]) = \overleftarrow{L}_j(U \circ h[t])$  which contradicts the minimality of  $t$ . Similarly this rule cannot belong to  $\mathcal{S}(34)$  because in that case  $s(t-1) = s(t) - 1$  and

$$|\overleftarrow{L}_j(U \circ h[t-1])| \geq |\overleftarrow{L}_j(U \circ h[t])| - c > s(t)c - c + |U| \geq s(t-1)c + |U|$$

contrary to the minimality of  $t$ .

Furthermore, the minimality of  $t$  and the form of the rules from  $\mathcal{S}(2) \cup \mathcal{S}(4)$  imply that  $|\overleftarrow{L}_j(U \circ h[t])| = |\overleftarrow{L}_j(U \circ h[t-1])| + 1$ .

**Case 1.1.** Suppose first that the  $t$ -th rule in  $h$  belongs to  $\mathcal{S}(2)$ . If for every  $t' \geq t$  the  $t'$ -rule in  $h$  is from  $\mathcal{S}(2)$  then

$$|\overleftarrow{L}_j(U \circ h[t])| < |\overleftarrow{L}_j(U \circ h[t+1])| < \dots < |\overleftarrow{L}_j(U \circ h)|$$

by Lemma 7.4. (The series increases because of the minimality of  $t$ .) This implies parts (a), (b), (c) of the conclusion of the lemma since  $\mathcal{S}(12)$  locks  $\overleftarrow{L}_j$ -sector.

Suppose that for some  $t' > t$  the  $t'$ -th rule in  $h$  is not from  $\mathcal{S}(2)$ . Let  $t'$  be the first such number. Then by Lemma 7.7 the  $t'$ -th rule in  $h$  belongs to  $\mathcal{S}(12) \cup \mathcal{S}(23)$ . Since rules from  $\mathcal{S}(12)$  lock  $\overleftarrow{L}_j L_j$ -sectors, the  $t'$ -th rule in  $h$  cannot belong to  $\mathcal{S}(12)$  by Lemma 7.4. So it belongs to  $\mathcal{S}(23)$ .

Clearly the claims of the lemma are true if  $t' = |h|$ .

Suppose that  $t' < |h|$ . Then by Lemma 7.7  $h \equiv h[t']h'h''$  where  $h'$  is a maximal subword of  $h$  consisting of rules from  $\mathcal{S}(3)$ . We will show that  $h''$  is empty.

Indeed, suppose that  $h''$  is not empty. Then by Lemma 7.7,  $h''$  starts with a rule  $\tau$  from  $\mathcal{S}(34)$ . Let  $U' = U \circ h[t']h'$ . Since  $\tau$  locks  $P_j R_j$ -sectors, and since all words  $U \circ h[u]$  are admissible for  $\mathcal{S}$  ( $u = 0, 1, \dots, |h|$ ), we have that  $P_j(U') = \emptyset$  and the words  $\overleftarrow{L}_j(U')$ ,  $L_j(U')$  and  $R_j(U')$  are positive.

Therefore, by Lemma 7.9,

$$\text{diff}(U') = |U'_a| \geq |\overleftarrow{L}_j(U')| = |\overleftarrow{L}_j(U \circ h[t'])| \geq |\overleftarrow{L}_j(U \circ h[t])| + (t' - t) > s(t)c + |U_a| + (t' - t). \quad (7.2)$$

But it is easy to see that for every rule  $\tau$  in  $\mathcal{S} \setminus \mathcal{S}(34)$  and for every admissible word  $W$  in the domain of  $\tau$ ,  $\text{diff}(W) = \text{diff}(W \circ \tau)$ , and for every  $\tau \in \mathcal{S}(34)$ ,  $\text{diff}(W \circ \tau) \leq \text{diff}(W) + c$ . Since there are at most  $s(t)$  rules from  $\mathcal{S}(34)$  in  $h[t']h'$ , we can conclude that

$$\text{diff}(U') \leq \text{diff}(U) + s(t)c \leq |U_a| + s(t)c, \quad (7.3)$$

a contradiction with (7.2).

Thus  $h''$  is empty, and part (a) of the lemma is established. Since rules from  $\mathcal{S}(3)$  are not active with respect to  $\overleftarrow{L}_j L_j$ -sectors, and  $\overleftarrow{L}_j(U \circ h[t])$  is not empty, part (b) follows as well.

Recall that  $h'$  is not empty because  $t' \neq |h|$ . Notice that the  $R_j \overrightarrow{R}_j$ -sector  $W$  of  $U \circ h[t']$  is in the domain of  $h'$ . By Lemma 7.5 applied to the computation  $W \bullet h'$ , we have

$$|h'| = |h| - t' \leq |R_j(W)| + |R_j(W \circ h')| = |R_j(U \circ h[t'])| + |R_j(U \circ h)|. \quad (7.4)$$

Notice that rules in  $\mathcal{S}(23)$  lock  $R_j \overrightarrow{R}_j$ -sectors, so  $|R_j(U \circ h[t'])| = 0$  (since the last rule in  $h[t']$  is from  $\mathcal{S}(23)$ ), and therefore  $|R_j(U \circ h)| \geq d - t'$  by (7.4). Notice also that  $|\overleftarrow{L}_j(U \circ h[d])| \geq |\overleftarrow{L}_j(U \circ h[t])| + t' - t$  by (7.2) and the equality  $\overleftarrow{L}_j(U \circ h[d]) = \overleftarrow{L}_j(U \circ h[t'])$ . Hence for every  $d \geq t'$

$$\begin{aligned} |U \circ h[d]| &> |\overleftarrow{L}_j(U \circ h[d])| + |R_j(U \circ h[d])| \geq \\ &(|\overleftarrow{L}_j(U \circ h[t])| + t' - t) + (d - t') \geq s(t)c + d - t + |U| \geq d - t, \end{aligned}$$

which proves part (c).

**Case 1.2.** The case when the  $t$ -th rule in  $h$  belongs to  $\mathcal{S}(4)$  is similar. Let  $h = h[t]h'$ . Then the brief history of  $h'$  cannot start with (4)(45) by Lemma 7.4 since rules from  $\mathcal{S}(45)$  lock  $\overleftarrow{L}_j L_j$ -sectors.

The brief history also cannot start with (4)(34). Indeed, suppose that  $h' = h''\tau h'''$  where  $h''$  is a word over  $\mathcal{S}(4)$ ,  $\tau \in \mathcal{S}(34)$ . Then as in Case 1.1, we denote  $U' = U \circ h[t]h''$ . Then we can use the fact that  $\tau$  locks  $P_j R_j$ -sectors, and that words  $\overleftarrow{L}_j(U')$  and  $R_j(U')$  are positive, we deduce inequalities

$$\text{diff}(U') = |U'_a| \geq |\overleftarrow{L}_j(U')| = |\overleftarrow{L}(U \circ h[t]h'')| \geq |\overleftarrow{L}(U \circ h[t])| + |h''| > s(t)c + |U_a| + |h''|. \quad (7.5)$$

On the other hand we have the inequality (7.3) as in Case 1.1, a contradiction with (7.5).

**Case 2.** The case when  $z = R_j$  is completely similar to Case 1.

**Case 3.** Let  $z = L_j$ . As in Case 1, we assume  $t$  being minimal. Then the  $t$ -th rule in  $h$  belongs to  $\mathcal{S}(2) \cup \mathcal{S}(4) \cup \mathcal{S}(1)$ .

**Case 3.1.** Suppose the  $t$ -th rule in  $h$  belongs to  $\mathcal{S}(2)$ . Let  $h = h[t]h_1$ . If all rules in  $h_1$  belong to  $\mathcal{S}(2)$ , we prove the statement as in Case 1.

If  $h_1 = h_2\tau h_3$  where  $h_2$  is a word over  $\mathcal{S}(2)$ ,  $\tau \in \mathcal{S}(23)$  then by Lemma 7.4  $|L_j(U \circ h[t-1])| < |L_j(U \circ h[t]h_2)|$  which is impossible since  $|L_j(U \circ h[t]h_2)| = 0$  (because rules from  $\mathcal{S}(23)$  lock  $L_j P_j$ -sectors).

Hence we can assume that  $\tau \in \mathcal{S}(12)$ .

**Case 3.1.1.** Assume that  $h[t]h_2$  is not a word in  $\mathcal{S}(2)$ . Then it contains a rule from  $\mathcal{S}(12)$  or from  $\mathcal{S}(23)$ . The first option is impossible by Lemma 7.7. Hence  $h[t] = h[q]\tau' h'$  where  $\tau' \in \mathcal{S}(23)$ ,  $h'$  is a word in  $\mathcal{S}(2)$ .

By Lemma 7.4, the value  $|\overleftarrow{L}_j(U \circ h[p])|$  must decrease when  $p$  runs from  $q$  to  $t + |h_2|$  because  $|\overleftarrow{L}_j(U \circ h[t]h_2)| = 0$  (since  $\tau$  locks  $\overleftarrow{L}_j L_j$ -sectors). Hence the sum  $|\overleftarrow{L}_j(U \circ h[p])| + |L_j(U \circ h[p])|$  cannot increase. Therefore  $|\overleftarrow{L}_j(U \circ h[q])| \geq |L_j(U \circ h[t])| > s(t)c + |U|$  since  $|L_j(U \circ h[t]h_2)| = 0$  ( $\tau'$  locks  $L_j P_j$ -sectors).

Since  $s(q) \leq s(t)$ , the number  $q$  satisfies the hypothesis of the lemma for  $z = \overleftarrow{L}_j$  (Case 1 of the proof). But this contradicts part (a) of the lemma which we already proved in Case 1 (by this part, in Case 1, the brief history of the suffix of  $h$  that starts after  $h[q]$  cannot contain (12)).

**Case 3.1.2.** Now assume that  $h[t]h_2$  is a word in  $\mathcal{S}(2)$ . Hence  $s(t) = 0$  (since  $h[t]$  does not contain rules from  $\mathcal{S}[34]$ ). By the assumption of the lemma

$$|\overleftarrow{L}_j(U \circ h[t])| + |L_j(U \circ h[t])| \geq |L_j(U \circ h[t])| > |U| \geq |\overleftarrow{L}_j(U)| + |L_j(U)|.$$

The strict inequality means that  $|\overleftarrow{L}(U \circ h[p])|$  cannot monotonically decrease when  $p$  runs from 0 to  $t + |h_2|$  (an age of (2)). Hence  $|\overleftarrow{L}_j(U \circ h_t h_2)| > 0$  by Lemma 7.4. But this contradicts the fact that  $\tau$  (as every rule in  $\mathcal{S}(12)$ ) locks  $\overleftarrow{L}_j L_j$ -sectors. This contradiction completes Case 3.1.

**Case 3.2.** The case when the  $t$ -th rule in  $h$  belongs to  $\mathcal{S}(4)$  is similar, but we need to substitute  $\mathcal{S}(4)$ ,  $\mathcal{S}(45)$ ,  $\mathcal{S}(34)$  for  $\mathcal{S}(2)$ ,  $\mathcal{S}(12)$ ,  $\mathcal{S}(23)$ .

**Case 3.3.** Suppose that the  $t$ -th rule in  $h$  belongs to  $\mathcal{S}(1)$ . Let  $h = h[t]h'$ . If all rules in  $h'$  belong to  $\mathcal{S}(1)$  then we can argue as in Case 1, apply Lemma 7.4, and deduce parts (a), (b) of the conclusion of the lemma, and the inequality

$$|L_j(U \circ h[d])| \geq |L_j(U \circ h[t])| + (d - t)$$

for every  $d \geq t$  which implies part (c).

**Case 3.3.1.** Assume that the letter (1) in the brief history of  $h'$  is followed by (12). Let  $h' = h'[t']h_1$  where  $h'[t']$  is the maximal prefix of  $h'$  which is a word over  $\mathcal{S}(1)$ . Since  $|h_1| > 0$ ,  $d \geq t + t' + 1$ . As above, we obtain by Lemma 7.4,

$$|L_j(U \circ h[t+t'+1])| = |L_j(U \circ h[t+t'])| = |L_j(U \circ h[t])| + t' \geq |U| + s(t)c + t' + 1 \geq t' + 1 > 0, \quad (7.6)$$

and all three parts of the statement of the lemma are true if  $d = t + t' + 1$ . So suppose that  $t + t' + 1 < d$ .

Then

$$\text{diff}(U \circ h[t + t' + 1]) > |U_a| + s(t)c + t' - |P_j(U \circ h[t + t' + 1])|,$$

but  $\text{diff}(U \circ h[t + t' + 1]) \leq |U_a| + s(t)c$  by the same argument as in Case 1. Therefore

$$|P_j(U \circ h[t + t' + 1])| \geq t' + 1. \quad (7.7)$$

Then, by Lemma 7.7, the brief history of  $h_1$  starts with (12)(2) (it cannot start with (12)(23) since  $|L_j(U \circ h[t + t' + 1])| > 0$  by (7.6)). Let  $h_1 = h_1[t_1]h_2$  where  $h_1[t_1]$  is the maximal prefix of  $h_1$  with brief history (12)(2).

**Case 3.3.1.1.** Suppose that  $h_2$  is empty. Then part (a) of the lemma is obviously true. Part (b) is also true because  $|\overleftarrow{L}_j(h[q])| + |L_j(h[q])|$  stays the same for all  $q \geq t + t' + 1$  (Lemma 7.9 (1)), and  $|L_j(U \circ h[t + t' + 1])| > 0$  by (7.6).

In order to prove part (c), notice that by Lemma 7.9 (2) the sequences  $|L_j(U \circ h[p])|$ ,  $p = t + t' + 1, t + t' + 2, \dots$ , is monotonically decreasing. Therefore  $d - t - t' \leq |L_j(U \circ h[t + t' + 1])|$ . Therefore by Lemma 7.9 (1) and by (7.7)

$$\begin{aligned} |U \circ h[d]| &= \\ &|U \circ h[t + t' + 1]| > |L_j(U \circ h[t + t' + 1])| + |P_j(U \circ h[t + t' + 1])| \geq \\ &(d - t - t') + (t' + 1) \geq \\ &d - t + 1 \end{aligned} \quad (7.8)$$

which proves part (c).

**Case 3.3.1.2.** Now suppose that  $h_2$  is not empty, and  $d > t + t' + t_1$ . If  $|h_2| = 1$  then  $h_2 \in \mathcal{S}(23)$  and parts (a), (b) follow from Case 3.3.1.1, part (c) follows from (7.8). So suppose that  $|h_2| > 1$ ,  $h_2 = h_2[t_2]h_3$  where  $h_2[t_2]$  is the maximal prefix of  $h_2$  with brief history (23)(3).

Since the brief history of  $h_2$  starts with (23) and rules of  $\mathcal{S}(23)$  lock  $L_j P_j$ -sectors,  $|L_j(U \circ h[t + t' + 1 + t_1])| = 0$ . As in Case 3.3.1.1 we have that  $|\overleftarrow{L}_j(U \circ h[t + t' + 1 + t_1])| \neq 0$ . Since rules from  $\mathcal{S}(3)$  are not active for  $\overleftarrow{L}_j$ -sectors, the length  $|\overleftarrow{L}_j(U \circ h[q])|$  stays the same (and  $> 0$ ) while  $q$  runs from  $t + t' + 1 + t_1$  to  $t + t' + 1 + t_1 + t_2$ .

Suppose that  $h_3$  is not empty, then it starts with a rule in  $\mathcal{S}(34)$ . Since rules in  $\mathcal{S}(34)$  lock  $P_j R_j$ -sectors,  $P_j(U \circ h[t + t' + 1 + t_1 + t_2])$  is empty.

Therefore we obtain by Lemma 7.9

$$\begin{aligned} s(t)c + |U| &< \\ &|\overleftarrow{L}_j(U \circ h[t])| + |L_j(U \circ h[t])| \leq |\overleftarrow{L}_j(U \circ h[t + t' + 1])| + |L_j(U \circ h[t + t' + 1])| = \\ &|\overleftarrow{L}_j(U \circ h[t + t' + 1 + t_1 + t_2])| + |L_j(U \circ h[t + t' + 1 + t_1 + t_2])| \leq \\ &\text{diff}(U \circ h[t + t' + 1 + t_1 + t_2]). \end{aligned}$$

But, as in Case 1,  $\text{diff}(U \circ h[t + t' + 1 + t_1 + t_2]) \leq \text{diff}(U) + s(t)c$ , a contradiction.

Thus  $h_3$  is empty. Parts (a) and (b) of the lemma follow as in Case 3.3.1.1. Also notice that since rules in  $\mathcal{S}(3)$  lock  $L_j P_j$ -sectors, we have

$$|U \circ h[d]| \geq |\overleftarrow{L}_j(U \circ h[d])| + |P_j(U \circ h[d])|. \quad (7.9)$$

Since rules in  $\mathcal{S}(3)$  are not active for  $\overleftarrow{L}_j L_j$ -sectors,

$$|\overleftarrow{L}_j(V)| = |\overleftarrow{L}_j(U \circ h[t + t' + 1 + t_1])|.$$

By Lemma 7.9, since rules in  $\mathcal{S}(12)$  lock  $\overleftarrow{L}_j L_j$ -sectors and rules in  $\mathcal{S}(23)$  lock  $L_j P_j$ -sectors, we have

$$|\overleftarrow{L}_j(U \circ h[t + t' + 1 + t_1])| = |L_j(U \circ h[t + t' + 1])| \geq |L_j(U \circ h[t])| + t' > |U| + s(t)c + t'.$$

Hence

$$|\overleftarrow{L}_j(U \circ h[d])| > |U| + s(t)c + t'. \quad (7.10)$$

Also notice that by Lemma 7.4,

$$|\overleftarrow{L}_j(U \circ h[d])| = t_1 - 1. \quad (7.11)$$

By Lemma 7.4, since rules of  $\mathcal{S}(2) \cup \mathcal{S}(23)$  lock  $R_j \overrightarrow{R}_j$ -sectors, we have that

$$R_j(U \circ h[d]) = |h_2| - 1 = d - t - t' - t_1 - 1. \quad (7.12)$$

Also notice that

$$|\overleftarrow{L}_j(U \circ h[d])| + |R_j(U \circ h[d])| - |P_j(U \circ h[d])| \leq \text{diff}(U \circ h[d]) = \text{diff}(U \circ h[t]) \leq \text{diff}(U) + s(t)c.$$

Hence, by (7.10) and (7.12),

$$\begin{aligned} |P_j(U \circ h[d])| &\geq \\ &(|\overleftarrow{L}_j(U \circ h[d])| - s(t)c - \text{diff}(U)) + |R_j(U \circ h[d])| \geq \\ &t' + d - t - t' - t_1 - 1 + |U| - \text{diff}(U) \geq \\ &d - t - t_1 + 1. \end{aligned} \quad (7.13)$$

Now using (7.11) and (7.13), we get

$$|U \circ h[d]| \geq |\overleftarrow{L}_j(U \circ h[d])| + |P_j(U \circ h[d])| \geq (t_1 - 1) + d - t - t_1 + 1 = d - t$$

as required.

**Case 3.3.2.** The remaining case is when the letter (1) in the brief history of  $h$  is followed by (51). This case can be analyzed as above, but the analysis is shorter, because the longest possible suffix of the brief history under consideration now is (1)(51)(5) (instead of (1)(12)(2)(23)(3) in Case 3.3.1). This subword cannot be followed by (45) by the same argument as in Case 3.3.1.2 (see the argument showing that the subword (1)(12)(2)(23)(3) cannot precede the letter (34)) because rules from  $\mathcal{S}(45)$  lock  $P_j R_j$ -sectors. The lemma is proved.  $\square$

**Lemma 7.11.** *Let  $U \bullet h = V$  be a  $j$ -standard computation of  $\mathcal{S}$ ,  $j \neq 1$ . Then*

- (1) *if  $h$  contains a letter from  $\mathcal{S}(34)$  then such a letter occurs in the prefix  $h[30(|U|+c)]$ .*
- (2) *if  $|h| \geq |V| + 30(|U| + c)$  then  $h[30(|U| + c)]$  contains a subword starting with a rule from  $\mathcal{S}(34)$  and ending with a rule from  $\mathcal{S}(12) \cup \mathcal{S}(51)$ .*

*Proof.* (1) Suppose that  $h$  contains rules from  $\mathcal{S}(34)$ . Let  $l = 30(|U| + c)$ . Suppose, by contradiction, that  $h[l]$  does not contain a rule from  $\mathcal{S}(34)$ .

If there exists  $t \leq l$  that satisfies the conditions of Lemma 7.10 (for some  $z \in \{\overleftarrow{L}_j, L_j, R_j\}$ ) then  $s(t) = 0$ , and by Lemma 7.10  $h$  does not contain letters from  $\mathcal{S}(34)$ , a contradiction.

Therefore for every  $t = 1, \dots, l$ ,

$$|z(U \circ h[t])| \leq |U|$$

for every  $z \in \{\overleftarrow{L}_j, L_j, R_j\}$ . Then by Lemma 7.5, the length of an arbitrary subword of  $h[l]$  over  $\mathcal{S}(g)$ ,  $g \in \{1, 2, 3, 4, 5\}$  is at most  $2|U|$ . Since (34) is not in the brief history of  $h[l]$ , the brief history of  $h[l]$  contains at most 5 occurrences of  $g \in \{1, 2, 3, 4, 5\}$  by Lemma 7.7. Thus the length  $l$  of  $h[l]$  does not exceed  $10|U| + 4 < 30(|U| + c)$  contrary to the definition of  $l$ .

(2) If there are two letters from  $\mathcal{S}(34)$  in  $h[l]$  then there is a letter from  $\mathcal{S}(12)$  and a letter from  $\mathcal{S}(51)$  between them by Lemma 7.7, and the claim of the lemma is true.

Therefore, we will suppose that  $h[l]$  contains exactly one letter from  $\mathcal{S}(34)$ . By Lemma 7.7, the length of the brief history of  $h[l]$  is at most 19, and the brief history contains at most 10 maximal subwords over  $\mathcal{S}(1) \cup \dots \cup \mathcal{S}(5)$ .

Suppose that some number  $t \leq |h|$  satisfies an assumption of Lemma 7.10 for some  $z \in \{\overleftarrow{L}_j, L_j, R_j\}$ , and  $s(t) = 1$ . Take the minimal  $t$  with this property. Then  $|z(U \circ h[p])| \leq c + |U|$  for  $p < t$ , for any  $z \in \{\overleftarrow{L}_j, L_j, R_j\}$ .

Then, as in the proof of part (1),  $t - 1 \leq 10(2|U| + 2c) + 9 < 30(|U| + c)$  because the number of ages of (1), (2),  $\dots$  (5) is at most 10 in the history of  $h[t - 1]$ . This inequality together with the inequality  $|U \circ h| \geq |h| - t$  given by Lemma 7.10 (part (c)) implies that  $|h| \leq |U \circ h| + 30(|U| + c)$  contrary to the assumption of part (2).

Hence there is no number  $t$  between 1 and  $|h|$  such that  $|z(U \circ h[t])| \geq c + |U|$  for some  $z \in \{\overleftarrow{L}_j, L_j, R_j\}$ . Then, as in (1), Lemmas 7.5 and 7.7 provide us with the inequality  $|h| \leq 10(2|U| + 2c) + 9 < 30(|U| + c)$  contrary to the assumption of the lemma. The lemma is proved.  $\square$

**Lemma 7.12.** *Let  $U \bullet h = V$  be a  $j$ -standard computation of  $\mathcal{S}$  and  $j \neq 1$  or a  $j$ -standard computation of  $\bar{\mathcal{S}}$  (for any  $j$ ).*

*Assume that  $h$  contains an occurrence of a rule  $\tau_1$  from  $\mathcal{S}(34) \cup \bar{\mathcal{S}}(34)$  preceding an occurrence of a rule  $\tau_2$  from  $\mathcal{S}(12) \cup \mathcal{S}(51) \cup \bar{\mathcal{S}}(12) \cup \bar{\mathcal{S}}(51)$ :  $h = h_1\tau_1h_2\tau_2h_3$ . Then the words  $z(U \circ h_1\tau_1h_2)$ ,  $z \in \{L_j, P_j\}$ , and  $z(U \circ h_1)$ ,  $z \in \{\overleftarrow{L}_j, R_j\}$  are completely determined by the word  $\tau_1h_2$ .*

*Proof.* If  $j = 1$  and  $h$  is a word over  $\bar{\mathcal{S}}$ , then all the words listed in the formulation of the lemma are empty, so the statement is trivially true.

Suppose that  $j \neq 1$ . We may suppose that  $h_2$  does not contain rules from  $\mathcal{S}(34) \cup \mathcal{S}(12) \cup \mathcal{S}(51) \cup \bar{\mathcal{S}}(34) \cup \bar{\mathcal{S}}(12) \cup \bar{\mathcal{S}}(51)$ . By Lemma 7.7, the brief history of  $\tau_1 h_2 \tau_2$  is either  $(34)(3)(23)(2)(12)$  or  $(34)(4)(45)(5)(51)$ . These cases are similar, so let the brief history be equal to  $(34)(3)(23)(2)(12)$ .

Let  $h_2 = h' \tau h''$  where  $\tau \in \mathcal{S}(23)$  (or  $\tau \in \bar{\mathcal{S}}(23)$ ). Since rules from  $\mathcal{S}(23)$  lock  $L_j P_j$ -sectors, and each rule  $\tau(2, r, i)^{\pm 1}$  of  $\mathcal{S}(2)$  (of  $\bar{\mathcal{S}}(2)$ ) multiplies inner parts of the  $L_j P_j$ -sectors of admissible words by the letter  $a_i(L_j)^{\mp 1}$  (resp. by  $\bar{a}_i(L_j)^{\mp 1}$ ) on the left (Lemma 2.6), the word  $L_j(U \circ h' \tau h'')$  is a copy of  $h''$  written from right to left. Therefore the word  $L_j(U \circ h_1 \tau h_2)$  is completely determined by  $h_2$ . Similarly, the word  $P_j(U \circ h_1 \tau h_2)$  is completely determined by  $h'$  (and, in turn, by  $h_2$ ) because rules from  $\mathcal{S}(34)$  lock  $P_j R_j$ -sectors, rules from  $\mathcal{S}(3)$  are active with respect to  $P_j R_j$ -sectors, and rules from  $\mathcal{S}(23) \cup \mathcal{S}(2)$  are not active with respect to these sectors.

Similarly, since  $\tau_2$  (as all rules from  $\mathcal{S}(12)$ ) locks  $\overleftarrow{L}_j$ -sectors and  $R_j$ -sectors, rules from  $\mathcal{S}(2)$  are active with respect to these sectors, and rules from  $\mathcal{S}(3) \cup \mathcal{S}(23)$  are not active with respect to these sectors, the word  $\overleftarrow{L}_j(U \circ h_1)$  (resp.  $R_j(U \circ h_1)$ ) is completely determined by  $\tau_1 h_2$ .  $\square$

**Lemma 7.13.** *Let  $U \bullet h = V$  be a  $j$ -standard computation of  $\mathcal{S}$  and  $j \neq 1$ . Suppose that  $|h| \geq |V| + 30(|U| + c)$ . Then  $h[30(|U| + c)]$  can be decomposed as  $h[30(|U| + c)] = h_1 \tau_1 h_2 \tau_2 h_3$  where  $\tau_1 \in \mathcal{S}(34)$ ,  $\tau_2 \in \mathcal{S}(12) \cup \mathcal{S}(51)$ ,  $h_2$  contains no letters from  $\mathcal{S}(34) \cup \mathcal{S}(12) \cup \mathcal{S}(51)$ . Moreover the word  $P_j(U \circ h_1 \tau_1 h_2 \tau_2)$  is positive for any such decomposition of  $h[30(|U| + c)]$ .*

*Proof.* By Lemma 7.11 there exists a decomposition  $h[30(|U| + c)] = h_1 \tau_1 h_2 \tau_2 h_3$  where  $\tau_1 \in \mathcal{S}(34)$ ,  $\tau_2 \in \mathcal{S}(12) \cup \mathcal{S}(51)$ . Taking  $h_2$  of minimal length, we can assume that  $h_2$  contains no letters from  $\mathcal{S}(34) \cup \mathcal{S}(12) \cup \mathcal{S}(51) \cup \mathcal{S}(1)$ . So we only need to show that  $P_j(U \circ h_1 \tau_1 h_2 \tau_2)$  is positive. Consider the homomorphism  $\gamma$  from the free group generated by  $\mathcal{A} \cup \mathcal{K}$  into the free group generated by  $\{a_1, \dots, a_m\}$  which maps  $a_i(z)$  into  $a_i$  for every  $z$ , and maps all other letters to 1. It is clear that for every rule  $\tau \in \mathcal{S} \setminus \mathcal{S}(34)$ , and every admissible word  $W$  in the domain of  $\tau$ ,  $\gamma(W \circ \tau) = \gamma(W)$ . Let  $U'$  be the subword of  $U$  starting with a  $P_j$ -letter and ending with a  $\overrightarrow{R}_j$ -letter. Then  $U' \circ h = V'$  where  $V'$  is the corresponding subword in  $V$ . Moreover for every  $t$  between 1 and  $|h|$ , and  $z \in \{P_j, R_j\}$ , the  $z z_+$ -sector in  $U' \circ h[t]$  coincides with the  $z z_+$ -sector in  $U \circ h[t]$ . Since rules in  $\mathcal{S}(34)$  lock  $P_j R_j$ -sectors,

$$\gamma(U' \circ h_1 \tau_1) = \gamma(R_j(U' \circ h_1 \tau_1)).$$

The word in the right hand side of this equality is a copy of  $R_j(U' \circ h_1 \tau_1)$  and is positive by definition of admissible words. Hence  $\gamma(U' \circ h_1 \tau_1 h_2) = \gamma(R_j(U' \circ h_1 \tau_1))$  (we use here that  $h$  does not contain rules from  $\mathcal{S}(1)$ ) is a positive word. But the rules in  $\mathcal{S}(12) \cup \mathcal{S}(51)$  lock  $R_j \overrightarrow{R}_j$ -sectors, so  $\gamma(U' \circ h_1 \tau_1 h_2)$  is a copy of  $P_j(U' \circ h_1 \tau_1 h_2) = P_j(U \circ h_1 \tau_1 h_2)$ . Hence  $P_j(U \circ h_1 \tau_1 h_2)$  is a positive word as required.  $\square$

To formulate the next lemma, we introduce a natural homomorphism  $\lambda$  from the free group  $F_0$  with basis  $\mathcal{A} \cup \bar{\mathcal{A}}$  onto the factor group  $H_0$  of  $F_0$  over the normal closure of all  $\mathcal{G}$ -relations. Thus  $H_0$  is the free product of a copy of  $\mathcal{G}$  generated by  $a_1(P_1), \dots, a_m(P_1)$  and a free group generated by all other  $a$ -letters.



**Lemma 7.14.** *Let  $U \bullet h = V$  be a 1-standard  $\mathcal{G}$ -computation of  $\mathcal{S}$ . Suppose that  $h = h_1\tau_1h_2\tau_2h_3$  where  $\tau_1 \in \mathcal{S}(34)$ ,  $\tau_2 \in \mathcal{S}(12) \cup \mathcal{S}(51)$ . Assume that  $h$  satisfy the conclusion of Lemma 7.7. Then the words  $z(U \circ h_1\tau_1)$ ,  $z \in \{\overleftarrow{L}_1, R_1\}$ ,  $L_1(U \circ h_1\tau_1h_2)$  and the  $\lambda$ -image of  $P_1(U \circ h_1\tau_1h_2)$  are determined by the word  $\tau_1h_2\tau_2$ .*

*Proof.* The proof of the assertion about  $z(U \circ h_1\tau_1)$ ,  $z \in \{\overleftarrow{L}_1, R_1\}$  and  $L_1(U \circ h_1\tau_1h_2)$  coincides with the corresponding proof in Lemma 7.12. Let  $U'$  be the  $P_1R_1$ -sector in  $U$ . Then  $P_1(U \circ h[t]) = P_1(U' \circ h[t])$  for every  $t$ . Notice also that  $P_1(U' \circ h_1)$  is equal to 1 modulo  $\mathcal{G}$  because rules from  $\mathcal{S}(34)$  lock the  $P_1R_1$ -sectors. Hence, modulo  $\mathcal{G}$ ,  $U' \circ h_1$  is a 2-letter word over  $\mathcal{K}$ . Therefore  $U' \circ h_1\tau_1h_2 = (U' \circ h_1\tau_1) \circ h_2$  is determined by  $h_2$  modulo  $\mathcal{G}$  as desired. Hence the  $\lambda$ -image of  $P_1(U \circ h_1\tau_1)$  is determined by the word  $\tau_1h_2\tau_2$ .  $\square$

### 7.3 Tame and wild computations

Recall that for every positive word  $w$  in  $\{a_1, \dots, a_{\bar{m}}\}$  we have defined a word  $\Sigma(w)$  in (2.3) which has the base  $\tilde{\Sigma}$  defined in (2.2).

Let  $U$  be an admissible word for  $\mathcal{S}$  with a base  $\tilde{\Sigma}^s K_1$ . Then the word  $U$  and any ring computation  $U \bullet h = V$  over  $\mathcal{S} \cup \bar{\mathcal{S}}$  will be called *tame*. All non-tame admissible words  $U$  whose bases start and end with the same letter will be called *wild*. If  $U$  is a wild admissible word then any ring computation  $U \bullet h = V$  will be called *wild* as well.

Recall that every admissible word for  $\mathcal{S} \cup \bar{\mathcal{S}}$  has an  $\bar{\mathcal{E}}$ -coordinate and an  $\Omega$ -coordinate. All  $k$ -letters in an admissible word  $U$  have the same coordinates  $r, i$ , so we can write  $U = U'(r, i)$  where  $U'$  is the word  $U$  with  $(\bar{\mathcal{E}}, \Omega)$ -coordinates removed from all  $k$ -letters.

**Lemma 7.15.** *Let  $U \bullet h = V$  be a tame computation of  $\mathcal{S}$ , with the base  $U = \tilde{\Sigma}^s K_1$ . Suppose that  $|h| \geq |V| + 30(|U| + c)$ . Then the prefix  $h[30(|U| + c)]$  has the form  $h_1\tau h_2$  where  $\tau \in \mathcal{S}(12) \cup \mathcal{S}(51)$  and  $U \circ h_1$  or  $U \circ h_1\tau$  has the form  $\Sigma(u, v)^s K_1$  where  $u$  and  $v$  are positive words over  $\{a_1, \dots, a_{\bar{m}}\}$ , and  $\Sigma(u, v)$  is an admissible word of the following form*

$$\left(\prod_{j=1}^{sN/2} K_{2j-1} L_{2j-1} v_{2j-1} P_{2j-1} u_{2j-1} R_{2j-1} K_{2j}^{-1} R_{2j}^{-1} u_{2j}^{-1} P_{2j}^{-1} v_{2j}^{-1} L_{2j}^{-1}\right)(\emptyset, 1) \quad (7.14)$$

where  $v_k, u_{k'}$  are copies of  $v$  and  $u$  under the substitutions  $a_i \mapsto a_i(L_k)$ ,  $a_i \mapsto a_i(P_{k'})$  for every  $k$  and for  $k' \neq 1 \pmod{N}$ ;  $u_{1+Nl}$  is equal to a copy of  $u$  modulo  $\mathcal{G}$ .

*Proof.* Let  $U'$  be any admissible subword of  $U$  with base  $\overleftarrow{L}_j L_j P_j R_j \overrightarrow{R}_j$ . Let  $V'$  be the corresponding subword in  $V$ . Then  $U' \bullet h = V'$  is a  $j$ -standard computation, and we can apply Lemma 7.13. This gives us the desired occurrence of  $\tau \in \mathcal{S}(12) \cup \mathcal{S}(51)$  in the prefix  $h[30(|U| + c)]$ . Then, depending on whether  $\tau \in \mathcal{S}^-(12) \cup \mathcal{S}^+(51)$  or  $\tau \in \mathcal{S}^+(12) \cup \mathcal{S}^-(51)$ , either  $U \circ h_1\tau$  or  $U \circ h_1$  has the form (7.14). The fact that all words  $u_i$  are copies of each other and all words  $v_i$  are copies of each other follows from Lemmas 7.12 and 7.14 (in case  $j = 1$ ) since the histories of the  $j$ -standard computations are all equal to  $h$  (notice that Lemma 7.14 can be applied because  $h$  satisfies the conclusion of Lemma 7.7 since there exists a  $j$ -standard computation  $U' \bullet h = V'$  for  $j \neq 1$ ). The fact that  $u_i$  and  $v_i$  are positive words follows from Lemma 7.13 and from the fact that words  $U \circ h[t]$  are admissible for  $\mathcal{S}$ .  $\square$

**Lemma 7.16.** *Let  $|\mathcal{S}|$  be the number of rules in  $\mathcal{S}$ . Let  $U \bullet h = V$  be a wild ring computation of  $\mathcal{S}$ . Suppose that  $|h| \geq |\mathcal{S}| + 1$ ,  $h$  contains a rule from  $\mathcal{S}(34)$ . Then  $U^{\pm 1}$  contains an admissible subword with base  $\overleftarrow{L}_j L_j P_j R_j \overrightarrow{R}_j$  for some  $j \geq 1$ . If in addition the brief history of  $h$  contains one of the letters  $(1), (12), (2), (23), (45), (5), (51)$ , then  $U$  contains such an admissible subword with base  $\overleftarrow{L}_j L_j P_j R_j \overrightarrow{R}_j$  for some  $j > 1$ .*

*Proof.* If the base of  $U$  does not contain  $L$ -,  $P$ - and  $R$ -letters, then the words  $U \circ h[t]$ ,  $t = 1, \dots, |h|$  differ only by the  $(\bar{\mathcal{E}}, \Omega)$ -coordinates (since rules of  $\mathcal{S}$  do not change  $K_j K_j^{-1}$ - and  $K_j^{-1} K_j$ -sectors of admissible words). Since the computation  $U \bullet h = V$  is a ring computation, the labels of the annuli of the ring, which correspond to words  $U \circ h[t]$ ,  $U \circ h[t']$  ( $t \neq t'$ ) can not be equal modulo  $\mathcal{G}$ -relations. Then lemma 6.1 shows that the number of the annuli cannot be greater than the number of rules of  $\mathcal{S}$ . Hence  $|h|$  does not exceed  $|\mathcal{S}| + 1$ .

Assume now that the base contains  $L_j$ -,  $P_j$ - or  $R_j$ -letter for some  $j$ . Then since rules from  $\mathcal{S}(34)$  lock  $L_j P_j$  and  $P_j R_j$ -sectors, the base of  $U^{\pm 1}$  must contain a subword  $L_j P_j R_j$ . By Lemma 2.2 this subword must be inside a subword of the form  $\overleftarrow{L}_j L_j P_j R_j \overrightarrow{R}_j$  and the first claim of the lemma true.

Suppose that  $j = 1$ . Notice that  $\overrightarrow{R}_1 = \overrightarrow{R}_2^{-1}$ . Now if the brief history of  $h$  contains letter from  $\{(1), (12), (2), (23), (51)\}$  then the corresponding rules in  $h$  lock  $R_2 \overrightarrow{R}_2$ -sectors. Therefore the base of  $U^{\pm 1}$  contains  $R_2^{-1}$  which implies, as before, that it contains a subword of the form  $\overleftarrow{L}_2 L_2 P_2 R_2 \overrightarrow{R}_2$ , as required.

Similarly notice that  $\overleftarrow{L}_1 = \overleftarrow{L}_N$ , and rules from  $\mathcal{S}(45) \cup \mathcal{S}(5)$  lock  $\overleftarrow{L}_j L_j$ -sectors for every  $j$ . So if the brief history of  $h$  contains  $(45)$  or  $(5)$  then the base of  $U^{\pm 1}$  contains the subword  $\overleftarrow{L}_N L_N P_N R_N \overrightarrow{R}_N$ .  $\square$

**Lemma 7.17.** *Let  $U \bullet h = V$  be a wild or tame ring computation of  $\mathcal{S}$ ,  $|h|$  exceeds  $|\mathcal{S}| + 1$ . Suppose that  $h$  contains a rule from  $\mathcal{S}(34)$  and a rule from  $\mathcal{S}(1) \cup \mathcal{S}(12) \cup \mathcal{S}(51)$ . Then the computation is tame.*

*Proof.* The presence of a rule locking  $\overleftarrow{L}_j L_j$ -sector (locking  $R_j \overrightarrow{R}_j$ -sector), implies that the letter  $\overleftarrow{L}_j$  (letter  $\overrightarrow{R}_j$ ) can occur in the base of  $U$  only in subwords  $(\overleftarrow{L}_j L_j)^{\pm 1}$  (resp. in subwords  $(R_j \overrightarrow{R}_j)^{\pm 1}$ ). Together with the argument from the proof of Lemma 7.16, this implies that arbitrary letter of the base of  $U$  has a uniquely determined right neighbor, which coincides with the right neighbor of this letter in the base of a tame ring.  $\square$

**Lemma 7.18.** *Let  $U \bullet h = V$  be a wild ring computation of  $\mathcal{S}$ ,  $h$  contains a rule from  $\mathcal{S}(34)$ . Then  $|h|$  is bounded by a linear function in  $|U| + |V|$ .*

*Proof.* By Lemma 7.17, we may assume that the brief history  $\text{br}(h)$  of  $h$  does not contain the letters  $(12)$  and  $(51)$ . Suppose in the beginning, that  $\text{br}(h)$  has at least one of the letters  $(1), (2), (23), (45), (5)$ . Then, applying Lemmas 7.16 and 7.11, we conclude that  $|h|$  is bounded by a linear function in  $|U| + |V|$ .

So, we may assume that  $\text{br}(h)$  contains no letters from the list

$$\{(1), (12), (2), (23), (45), (5), (51)\},$$

i.e. it is a word in letters (3), (34), (4). By Lemma 7.8 it has no subwords (34)(4)(34). Thus, we may suppose that  $\text{br}(h)$  is a subword of (4)(34)(3)(34)(4). Hence

$$h = h_{(4)}h_{(34)}h_{(3)}h'_{(34)}h'_{(4)}$$

where  $h_\alpha$  is a word in  $\mathcal{S}(\alpha)$  (the first and the last few subwords in this decomposition of  $h$  may be empty),  $|h_{(34)}|, |h'_{(34)}| \leq 1$ .

By Lemma 7.16, we may assume that  $U^{\pm 1}$  contains an admissible subword  $U'$  with the base  $\overleftarrow{L}_j L_j P_j R_j \overrightarrow{R}_j$  for some  $j$ . Consider the computation  $U' \bullet h = V'$ . By Lemma 7.5 applied to the  $L_j P_j$ -sector  $U''$  of  $U'$ ,  $|h_{(4)}|$  is bounded by  $|U| + |V|$  since  $L_j(U'' \circ h_{(4)})$  is empty.

The same is true for  $|h'_{(4)}|$ . Hence  $|U \circ h_{(4)}|$  and  $|U \circ h_{(4)}h_{(34)}h_{(3)}|$  are bounded by a linear function in  $|U| + |V|$  (the application of every rule can increase the length of an admissible word with a given base only by a constant). Now again by Lemma 7.5  $|h_{(3)}|$  is bounded by a linear function in  $|U| + |V|$ .  $\square$

**Lemma 7.19.** *Let  $U \bullet h = V$  be a wild computation of  $\mathcal{S}$ . Suppose that  $h$  does not contain rules from  $\mathcal{S}(34)$ . Then  $|h|$  is bounded by a linear function in  $|U| + |V|$ .*

*Proof.* Lemma 7.8 (and the absence of (34)-letters in the brief history  $B$  of  $h$ ) shows that  $\text{br}(h)$  does not have any of the six prohibited words mentioned in Lemma 7.8 and also (34)(3)(34). Therefore one can apply the argument of Lemma 7.7, and conclude that  $\text{br}(h)$  must be obtained by removing some letters in one of the following four words:

- (i) (4)(45)(5)(45)(4),
- (ii) (3)(23)(2)(12)(1)(12)(2)(23)(3),
- (iii) ((3)(23)(2)(12)(1)(51)(5)(45)(4))^{\pm 1},
- (iv) (4)(45)(5)(51)(1)(51)(5)(45)(4)

**Case (i).** In this case, as above, we have the following decomposition:

$$h = h_{(4)}h_{(45)}h_{(5)}h'_{(45)}h'_{(4)}$$

where some of the factors can be empty.

Suppose that the base of  $U$  does not contain  $L$ -letters. Since rules in  $\mathcal{S}(4)$  are not active with respect to  $zz'$ -sectors where  $z, z' \neq L_j$ , every rule in  $\mathcal{S}(4)$  fixes  $U$ . Therefore the words  $h_{(4)}$  and  $h'_{(4)}$  are empty (otherwise we get a contradiction with the assumption that the computation  $U \bullet h = V$  is a ring computation (rings are incompressible), so all words  $U \circ h[t]$ ,  $t = 0, 1, \dots, |h|$  are supposed to be different).

If the base of  $U$  contains  $L_j$  then it contains  $\overleftarrow{L}_j L_j$  by Lemma 2.2. By Lemma 7.5, this gives a linear upper bound for the lengths of  $h_{(4)}$  and  $h'_{(4)}$  in terms of the lengths of  $U$  and  $V$  by the locking argument for  $\mathcal{S}(34)$ .

If the base of  $U$  contains  $R_j$  then it contains a subword  $R_j \overrightarrow{R}_j$  and the length of  $h_{(5)}$  is also linearly bounded from above by Lemma 7.5. Otherwise  $|h_{(5)}| = 0$  because the

computation is absolutely reduced. Thus all five subwords in the decomposition of  $h$  have linearly bounded length.

**Case (ii).** By Lemma 7.3, we can turn  $U \bullet h = V(\text{mod } \mathcal{G})$  into a free computation  $U \bullet h = V'$  where  $V' = V(\text{mod } \mathcal{G})$ . All sectors in  $V'$  but the  $P_1R_1$ -sector are freely equal to the corresponding sectors in  $V$ . Using Lemma 7.5 to the computations  $z(U) \bullet h = z(V')$ ,  $z \in \{\overleftarrow{L}_j, L_j, R_j\}$ , we linearly bound the lengths of maximal subwords of  $h$  over  $\mathcal{S}(g)$  ( $g = 1, 2, 3$ ) in terms of  $|z(U)| + |z(V')| \leq |U| + |V|$ . For example, if  $g = 1$ ,  $z = L_j$ , etc.

**Cases (iii),(iv)** are similar to cases (1) and (ii).  $\square$

**Lemma 7.20.** *Let  $U \bullet h = V$  be a wild ring computation of  $\mathcal{S}$ . Then  $|h|$  is bounded by a linear function in  $|U| + |V|$ .*

*Proof.* The statement follows from lemmas 7.18 and 7.19.  $\square$

We call an admissible word  $U$  for  $\bar{\mathcal{S}}$  (resp.  $\mathcal{S}$ ) *accepted* by  $\bar{\mathcal{S}}$  (by  $\mathcal{S}$ ) if there exists a ring computation of the form  $U \circ h = \Sigma^s(w)K_1(\emptyset, 1)$ ,  $s \neq 0$ , of  $\bar{\mathcal{S}}$  (resp. of  $\mathcal{S} \text{ mod } \mathcal{G}$ ) for some (for some positive) word  $w$ .

**Lemma 7.21.** (1) *If a tame admissible word  $U$  whose base starts and ends with the same letter is not accepted by  $\mathcal{S}$  then the length of the brief history of any ring computation  $U \bullet h = V$  of  $\mathcal{S}$  is at most  $|\mathcal{S}| + 20$ .*

(2) *If  $U$  is accepted by  $\mathcal{S}$ , then the length  $d$  of any ring computation*

$$U \circ h = \Sigma^s(w)K_1(\emptyset, 1),$$

*such that  $U \circ h[d'] \neq \Sigma^s(w')K_1(\emptyset, 1)$  for a word  $w'$  and  $d' < d$ , is recursively bounded in terms of  $|U|$ .*

*Proof.* (1) Suppose that the word  $U$  is not accepted but the length of the brief history of some ring computation  $U \bullet h$  is  $> |\mathcal{S}| + 20$ . Then by Lemma 7.7  $\text{br}(h)$  contains an occurrence of (34) and one of the letters (1), (12), (2), (23), (45), (5), (51). Since the computation is tame, the base of  $U$  is  $\tilde{\Sigma}^s K_1$  for some  $s \neq 0$ . Then by Lemma 7.7, the  $\text{br}(h)$  contains two occurrences of (34), and an occurrence of (12) or (51) between them:  $h = h_1\tau_1h_2\tau_2h_3$  where  $\tau_1 \in \mathcal{S}(34)$ ,  $\tau_2 \in \mathcal{S}(12) \cup \mathcal{S}(51)$ . Then by Lemmas 7.12 and Lemma 7.14, we conclude that all sectors of  $U \circ h_1\tau_1h_2\tau_2$  are determined by  $\tau_1h_2$ , so they are copies of each other (or, in the case of  $P_1z$ -sectors, copies modulo  $\mathcal{G}$ ). Therefore, depending on whether  $\tau_2 \in \mathcal{S}^+(12)$  or  $\tau_2 \in \mathcal{S}^-(12)$ , the word  $U \circ h_1\tau_1h_2$  or  $U \circ h_1\tau_1h_2\tau_2$  has the form  $\Sigma_{\emptyset,1}(\emptyset, u, v, \emptyset)K_1(\emptyset, 1)$  (see Definition 3.1) where  $u$  and  $v$  are positive words by Lemma 7.13. Let us denote this word by  $U'$ .

By Lemma 3.5, part a) (for  $i = 1$ ), there exists a ring computation

$$U' \bullet h' = \Sigma_{\emptyset,1}(\emptyset, \emptyset, uv, \emptyset)^s K_1(\emptyset, 1) = \Sigma(uv)^s K_1(\emptyset, 1)$$

of  $\mathcal{S}(1)$  and, by lemmas 3.4 and 6.1, the corresponding ring can be united with the ring which corresponds to  $U \bullet h_1\tau_1h_2$  or  $U \bullet h_1\tau_1h_2\tau_2$ . Now by Lemma 7.2, the computation  $U \bullet h_1\tau_1h_2h'$  or  $U \bullet h_1\tau_1h_2\tau_2h'$  (or another computation if the corresponding annular diagram is compressible) is a ring computation accepting  $U$ , a contradiction.

(2) First we need to check if  $U$  is tame. If it is not tame, it cannot be accepted. So assume that  $U$  is tame. By the proof of part (1) (and the definitions of compressible and reduced diagrams), in order to check if a tame word  $U$  is accepted, one needs to check only computations  $U \bullet h$  whose brief history does not contain two occurrences of (34) and an occurrence of (12) or (51) between them. By Lemma 7.7,  $|\text{br}(h)| \leq 19$ . If for some  $z \in \{\overleftarrow{L}_j, L_j, R_j\}$ ,  $j \neq 1$ , and some  $t \leq |h|$ , the length  $|z(U \circ h[t])|$  exceeds  $c + |U|$  then by Lemma 7.10, part (b), one of the words  $\overleftarrow{L}_j(U \circ h[d])$ ,  $L_j(U \circ h[d])$  or  $R_j(U \circ h[d])$  is not empty for every  $d \geq t$ . Since the words  $\overleftarrow{L}_j(\Sigma^s(w)K(\emptyset, 1))$ ,  $L_j(\Sigma^s(w)K(\emptyset, 1))$  or  $R_j(\Sigma^s(w)K(\emptyset, 1))$  are empty, we can consider only computations where  $|z(U \circ h[t])| \leq c + |U|$ . By Lemma 7.5, the length of every subword of  $h$  over  $\mathcal{S}(g)$ ,  $g \in \{1, 2, 3, 4, 5\}$  is bounded by  $2|U| + c$ . This gives a bound on the length of  $h$ .  $\square$

**Lemma 7.22.** *There exists an algorithm to check, given two admissible words  $U, V$  for  $\mathcal{S}$ , if there exists a ring computation  $U \bullet h = V$  of  $\mathcal{S}$ . The length of arbitrary such ring computation is recursively bounded in terms of  $|U| + |V|$ .*

*Proof.* By lemmas 7.20 and 7.1, we have a linear bound for any wild ring computation of  $\mathcal{S}$  which can connect  $U$  and  $V$ .

Let us assume that there is a tame ring computation connecting  $U$  and  $V$ . By Lemmas 7.15 and 7.1, we can assume that  $U$  and  $V$  have the form (7.14) for some  $s \neq 0$ . Let us use the notation from Lemma 7.15. Since the word problem in  $\mathcal{G}$  is decidable,  $u_{1+Ni}$ ,  $l = 1, \dots, s$ , is a copy of  $u$  modulo  $\mathcal{G}$ , we can assume that  $u_{1+Ni}$  is a copy of  $u$  in the free group. (Clearly if  $U' = U \pmod{\mathcal{G}}$ , then a computation  $U \bullet h = V$  exists if and only if a computation  $U' \bullet h = V$  exists, and the corresponding rings differ only in a  $\mathcal{G}$ -cell attached to the boundary of one of them.) Furthermore we may suppose that the words  $U$  and  $V$  are accepted by  $\mathcal{S}$  (see the proof of Lemma 7.21), so we can assume by Lemma 7.21, part (2), that  $U \equiv \Sigma(w)^s K_1(\emptyset, 1)$ ,  $V \equiv \Sigma(w')^s K_1(\emptyset, 1)$ .

Notice that for every rule  $\tau \in \mathcal{S}$  and every admissible word  $U'$  with the base  $W_j = \overleftarrow{L}_j L_j P_j R_j \overrightarrow{R}_j$  which is in the domain of  $\tau$ ,  $\delta(U') = \delta(U' \circ \tau)$  for the homomorphism  $\delta$  introduced before Lemma 3.1. By Lemma 3.9, we have similar equality for a ring computation (which compute modulo  $\mathcal{G}$ ) of arbitrary length. Therefore if  $\delta(w') \neq \delta(w)$ , there could be no computation of  $\mathcal{S}$  connecting  $U$  and  $V$ .

Assume that  $\delta(w') = \delta(w)$ . Then a ring computation  $U \bullet h = V$  of  $\mathcal{S}$  does exist by lemmas 2.1 and 3.6. Since the equality  $\delta(w) = \delta(w')$  is effectively verifiable (the word problem in  $\mathcal{G}$  is decidable), we can effectively verify (using Lemma 7.1) if there exists a ring computation of  $\mathcal{S}$  connecting  $U$  and  $V$ . By Lemma 6.1, all rings of the first type corresponding to computations  $U \bullet h' = V$  for some  $h'$ , have boundary labels  $U$  and  $V$ . (These boundary labels have no  $x$ -letters by Lemma 6.1 since  $U \equiv \Sigma(w)^s K_1(\emptyset, 1)$ ,  $V \equiv \Sigma(w')^s K_1(\emptyset, 1)$ .) It follows from the definition of compressible and reduced diagrams, that the heights of all of these rings must be equal. This height is recursively bounded. Indeed, the above construction recursively bounds the number of  $\mathcal{S}(34)$ -rules in any ring computation connected  $U$  and  $V$ , because there are no  $(\theta, k)$ -cells which are higher than those corresponding to rules from  $\mathcal{S}(34)$ . Then arguing as in the proof of Lemma 7.21, we get a recursive upper bound for the length of the history. The lemma is proved.  $\square$

## 7.4 Computations of $\bar{\mathcal{S}}$

**Lemma 7.23.** *For any  $s \geq 1$ , and any two admissible words  $U, V$  of  $\bar{\mathcal{S}}$  there is an algorithm to decide whether there exists a computation  $U \bullet h = V$  of  $\bar{\mathcal{S}}$ , and  $br(h)$  is of length  $\leq s$ . The lengths of all ring computations of this form are recursively bounded by a function of  $|U| + |V|$ .*

*Proof.* If  $U$  and  $V$  have different bases then there is no computation connecting  $U$  and  $V$ . So we can assume that  $U$  and  $V$  have the same bases.

We can assume that  $h$  is reduced and write it as  $h \equiv h_1 \dots h_s$  where  $h_i$  are words over  $\bar{\mathcal{S}}(\omega_i)$ ,  $\omega_i \in \{1, 12, \dots, 51\}$ ,  $i = 1, \dots, s$ . There are only finitely many choices for the sequence  $\omega_1, \dots, \omega_s$ . So we can fix one of them. We can also assume that if  $\mathcal{S}(\omega_i)$  consists of transition rules then  $h_i$  is of length 1, so there are finitely many choices for such  $h_i$ . Fix one of these choices.

By Lemma 2.7, for each of the other  $h_i$ ,  $i = 1, \dots, s$ , there exist two sequences of numbers  $\{\varepsilon_{i,z}, \delta_{i,z} \in \{-1, 0, 1\} \mid z \in \tilde{\mathcal{K}}\}$ , such that for every admissible word  $W$  of the form  $V(g, r)$ , and any group word  $w_i$  in  $\{a_1, \dots, a_{\bar{m}}\}$  there exists a word  $h_i$  in  $\bar{\mathcal{S}}(g)$  satisfying the following properties:

1.  $h_i$  is a copy of  $w_i$ ;
2.  $W$  is in the domain of  $h_i$ ;
3.  $W \circ h_i$  is obtained from  $W$  by all replacements of the form

$$\bar{z}(r, g) \rightarrow w_i(z_-)^{\varepsilon_{i,z}} \bar{z}(r, g) w_i(z)^{\delta_{i,z}},$$

where  $z$  runs over all letters in the base of  $W$ ,  $\varepsilon_{i,z} \in \{-1, 1\}$ .

Thus, by Lemmas 2.6 and 2.7, applying  $h$  to  $U$  results in multiplying the interior of each sector of  $U$  on the left and the right by products of copies of unknown words  $w_i(z)$ , their inverses, and constant words corresponding to the transition rules. The result of this multiplication should be the interior of the corresponding sector in  $V$ . Hence the existence of  $h$  such that  $U \circ h = V$  is equivalent to the existence of a solution of one of a finite systems of equations in the free group (each system corresponds to the choice of the brief history of  $h$  and the choice of transition rules in  $h$ ; the equations correspond to the ages in the brief history and the unknowns are the words  $w_i(z)$ ).

It remains to apply a theorem of Makanin [Mak] saying that there exists an algorithm checking if a system of equations over a free group has a solution. The heights of all ring computations of this form must be equal by the definition of compressible and reduced diagrams. This height is recursively bounded by Lemma 6.16, because the above construction gives the list of computations (if any exists) with arbitrary distribution of at most  $s$  transition rules; and this allows us to effectively select those whose rings are incompressible. The lemma is proved.  $\square$

**Lemma 7.24.** (1) *If a tame word  $U$  is not accepted by  $\bar{\mathcal{S}}$  then the length of the brief history of any ring computation  $U \bullet h = V$  of  $\bar{\mathcal{S}}$  is at less than 19 with at most one occurrence of (34).*

(2) There is an algorithm which checks whether a given admissible word is accepted by  $\bar{\mathcal{S}}$ , this algorithm also finds an accepting computation if it exists.

*Proof.* (1) Let the base of  $U$  be  $\tilde{\Sigma}^l K_1$  for some  $l \neq 0$ . Then using Lemma 7.7 as in the proof of Lemma 7.21, if the length of the brief history of a computation  $U \bullet h$  is bigger than 19 or if the number of occurrences of (34) in the brief history is at least 2, there exists  $t$  between 1 and  $|h|$  such that

$$U \circ h[t] = \bar{\Sigma}_{\emptyset,1}(\emptyset, u, v, \emptyset)^l \bar{K}_1(\emptyset, 1) = \Sigma_{\emptyset,1}(\emptyset, u, v, \emptyset)^l K_1(\emptyset, 1).$$

By Lemma 3.8, part b), there exists a computation  $U \bullet h[t]h' = \Sigma(uv)^l K_1(\emptyset, 1)$ . By Lemma 6.16, this computation (or another computation if the corresponding annular diagram is not reduced) is a ring computation, so  $U$  is accepted. This contradiction proves the first part of the lemma.

(2) By Part 1 of the lemma and Lemma 7.7, we can restrict ourselves to computations  $U \bullet h$  with  $\text{br}(h)$  containing at most one occurrence of (34) and  $|\text{br}(h)| \leq 19$ .

Suppose that  $U$  is accepted,  $U \circ h = \Sigma(w)^l K_1$  be the corresponding computation. As in Lemma 7.13, introduce a homomorphism  $\gamma$  of the free group with basis  $\bar{\mathcal{A}} \cup \bar{\mathcal{K}}$  onto free group over  $\{a_1, \dots, a_m\}$ , by the rule  $\bar{a}_i(z) \mapsto a_i$ ,  $z \rightarrow 1$ ,  $z \in \bar{\mathcal{K}}$ . Then for every  $t = 0, \dots, |h| - 1$ ,  $\gamma(U \circ h[t]) = \gamma(U \circ h[t+1])$  if  $h[t+1]$  does not end with a rule from  $\mathcal{S}(34)$ . Otherwise

$$||\gamma(U \circ h[t])| - |\gamma(U \circ h[t+1])|| \leq cl.$$

Hence the length of  $w^l = \gamma(\Sigma(w)^l K_1(\emptyset, 1))$  is bounded by  $|U| + cl$  (since  $h$  contains only one rule from  $\mathcal{S}(34)$ ). Hence  $|w| \leq |U| + cl$ . Therefore  $|\Sigma(w)^l K_1(\emptyset, 1)|$  does not exceed  $l(|U| + lc) + 4N$ . Now Lemma 7.23 gives us an algorithm to check if an accepting ring computation exists.  $\square$

**Lemma 7.25.** *Assume  $U \bullet h$  be a wild ring computation of  $\bar{\mathcal{S}}$ . Then  $|\text{br}(h)| \leq 13$ .*

*Proof.* We examine several cases taking into account Lemma 6.2. Let  $B$  be the base of  $U$ .

**Case 1.** Suppose that  $B$  contains letter  $P_j^{\pm 1}$  for some  $j \neq 1$ .

**Case 1.1.** Suppose that  $B$  contains no letters except  $P_j^{\pm 1}$ . Since rules from  $\bar{\mathcal{S}}(\omega)$ ,  $\omega \in \{(23), (3), (34), (4), (45)\}$  lock  $P_j R_j$ -sectors, these rule cannot occur in  $h$ . Rules from  $\bar{\mathcal{S}}(2) \cup \bar{\mathcal{S}}(5)$  are not active for  $P_j P_j^{-1}$ - and  $P_j^{-1} P_j$ -sectors, so existence of these rules in  $h$  would contradict the assumption that we have a ring computation. Hence  $\text{br}(h)$  does not contain (2) and (5). This implies that  $\text{br}(h)$  cannot be longer than the words (51)(1)(12), (51)(1)(51) and (12)(1)(12),  $|\text{br}(h)| \leq 3$ .

**Case 1.2..** Suppose that  $B$  contains a subword  $yz$  where  $y$  (or  $z$ ) is equal to  $P_j^{\pm 1}$  but  $z$  (resp.  $y$ ) is not  $P_j^{\pm 1}$ . We can assume that the exponent of  $P_j^{\pm 1}$  in  $yz$  is 1 (otherwise we can switch from  $U$  to  $U^{-1}$ ). Therefore by Lemma 6.2,  $yz$  is equal to either  $L_j P_j$  or  $P_j R_j$ .

**Case 1.2.1.** Let  $yz \equiv L_j P_j$ ,  $j \neq 1$ . Then by Lemma 6.2, since  $B$  starts and ends with the same letter, there are two possibilities: either  $B$  has a subword  $L_j P_j P_j^{-1}$  or it contains  $L_j P_j R_j$ .

**Case 1.2.1.1.** Suppose there is a subword  $L_j P_j P_j^{-1}$  in  $B$  for  $j \neq 1$ . Then there are no letters from  $\{(34), (4), (45)\}$  in  $\text{br}(h)$  since the corresponding rules lock  $P_j R_j$ -sectors.

The word  $B$  also has no subwords (23)(2)(23) by Lemma 7.6. If  $B$  contains a subword  $L_j^{-1}L_jP_jP_j^{-1}$ , then  $\text{br}(h)$  cannot have letters (12) or (51) since the corresponding rules lock  $\overleftarrow{L}_jL_j$ -sectors. If  $B$  has a subword  $\overleftarrow{L}_jL_jP_jP_j^{-1}$ , then  $\text{br}(h)$  cannot have subwords (12)(2)(12), by Lemma 7.6. Thus, in any case, subwords (12)(2)(12) do not occur in  $\text{br}(h)$ . Consider two subcases.

**Case 1.2.1.1.1.** Suppose that  $B$  does not contain  $R_p$  for  $p \neq 1$ . Then  $\text{br}(h)$  contains neither (3) nor (5) because  $U \bullet h$  is a ring computation. This implies that  $\text{br}(h)$  cannot be longer than the words (23)(2)(12)(1)(12)(2)(23) or (51)(1)(12)(2)(23),  $|\text{br}(h)| \leq 7$ .

**Case 1.2.1.1.2.** Suppose that  $B$  contains  $R_p$ ,  $p \neq 1$ . If  $B$  has no subwords  $R_p\overrightarrow{R}_p$ , then letters (1), (12), (2), (23), (51) do not occur in  $\text{br}(h)$  (the locking argument again). Recall that by Case 1.2.1.1, (45) does not occur in  $\text{br}(h)$ .

If  $B$  has a subword  $R_p\overrightarrow{R}_p$ ,  $p \neq 1$ , then  $\text{br}(h)$  cannot contain a subwords (51)(5)(51) or (23)(3)(23) by Lemma 7.6. In view of the previous restrictions, the longest possible brief history cannot be longer than the word (3)(23)(2)(12)(1)(12)(2)(23)(3),  $|\text{br}(h)| \leq 9$ .

**Case 1.2.1.2.** Suppose that there exists a subword  $L_jP_jR_j$  in  $B$ ,  $j \neq 1$ . Then  $\text{br}(h)$  has no subwords (23)(2)(23), (34)(3)(34), (34)(4)(34) and (45)(5)(45) by Lemma 7.6. The subwords (12)(2)(12) and (45)(4)(45) can be excluded as in Case 1.2.1.1. The subwords (23)(3)(23) and (51)(5)(51) are impossible by a similar reason (but one has to consider the alternative whether  $R_j\overrightarrow{R}_j$  occurs in the base or not).

The restrictions we have obtained show that there is one of the letters (12), (51) in  $\text{br}(h)$  if the length of the brief history is at least 8. Therefore  $B$  has a subword  $\overleftarrow{L}_jL_jP_jR_j$  by the locking argument. Similarly, if the length of  $\text{br}(h)$  is at least 6, it has one of the letters (12), (23), (51), and so  $B$  contain subword  $\overleftarrow{L}_jL_jP_jR_j\overrightarrow{R}_j$ . Continuing the extension of the subword of the base using the locking argument and Lemma 6.2, we see that the computation is tame if the length of  $\text{br}(h)$  is at least 8, contrary the assumption of the lemma.

**Case 1.2.2.** Let  $yz \equiv P_jR_j$ . Then by Lemma 6.2, one can assume that  $B$  has a subword  $P_j^{-1}P_jR_j$  (otherwise we have Case 1.2.1.2). Hence  $\text{br}(h)$  has neither of the letters (23), (3), (34) (the locking argument). This brief history cannot contain subwords (51)(5)(51) by Lemma 7.6.

If there are no letters  $L_p$  in  $B$  for  $p \neq 1$ , then there are no letters (2), (4) in  $\text{br}(h)$  because rules from  $\overline{\mathcal{S}}(2) \cup \overline{\mathcal{S}}(4)$  are not active with respect to  $zz'$ -sectors if  $z, z' \neq L_p$ . Otherwise there are no subwords (12)(2)(12) or (45)(4)(45) in  $\text{br}(h)$  by Lemma 7.6. Therefore such subwords are absent in any case. Hence  $\text{br}(h)$  cannot be longer than words (2)(12)(1)(51)(5)(45)(4), (2)(12)(1)(12)(2), (4)(45)(5)(51)(1)(51)(5)(45)(4),  $|\text{br}(h)| \leq 9$ .

**Case 2.** Suppose now that  $B$  does not contain  $P_j$  for  $j \neq 1$ . Since the computation is a ring computation,  $\text{br}(h)$  does not contain (1).

If there are nether  $L_j$ - nor  $R_j$ -letters in  $B$  for  $j \neq 1$ , then  $\text{br}(h)$  contains no letters from  $\{(1), \dots, (5)\}$ . Therefore  $\text{br}(h)$  must be a subword of a product of several factors of the form (12)(23)(34)(45)(51) or (51)(45)(34)(23)(12) because the history of the computation is reduced. However  $\text{br}(h)$  cannot contain two occurrences of (12) or (51) otherwise the computation is not a ring computation. Indeed the transition rules not from  $\mathcal{S}(34)$  change only  $(\mathcal{E}, \Omega)$ -coordinates of the words, rules from  $\mathcal{S}(34)$  also change only  $(\mathcal{E}, \Omega)$ -coordinates in admissible words without  $L_j$  in their bases. Hence if  $\text{br}(h)$  contains two occurrences of



(12) or (51), the corresponding ring is not reduced. Thus, the length of  $\text{br}(h)$  is at most 13 in this case. Hence, one may assume further that there is either  $L_j$ - or  $R_j$ -letter in  $B$  for some  $j \neq 1$ .

**Case 2.1.** Suppose that  $B$  contains  $L_j$ ,  $j \neq 1$ . Then the locking argument shows that  $\text{br}(h)$  contains no letters from  $\{(23), (3), (34)\}$ . Then the standard application of Lemma 7.6 shows that  $\text{br}(h)$  cannot contain either (12)(2)(12) or (45)(4)(45).

If  $B$  has no letter  $R_j$  with  $j \neq 1$  then  $\text{br}(h)$  has no letter (5) (otherwise the computation is a ring computation since the corresponding diagram is compressible). Hence by Lemma 7.6,  $\text{br}(h)$  has no subwords (51)(5)(51) whether  $B$  contains  $R_j$  or not. Hence  $\text{br}(h)$  cannot be longer than the words

$$(2)(12)(1)(51)(5)(45)(4), (2)(12)(1)(12)(2), (4)(45)(5)(51)(1)(51)(5)(45)(4),$$

$$|\text{br}(h)| \leq 9.$$

**Case 2.2.** Suppose that  $B$  contains  $R_j$ ,  $j \neq 1$ , but  $L_p$  does not occur in  $B$  if  $p \neq 1$ . Then  $\text{br}(h)$  cannot contain letters (34), (4), (45) since  $P_j R_j$  is not a subword of  $B$ . Besides  $\text{br}(h)$  has no letters (2), (4) since otherwise the computation is not a ring computation. The subwords (23)(3)(23), (51)(5)(51) are impossible by Lemma 7.6. Hence  $\text{br}(h)$  cannot be longer than the words (3)(23)(12)(1)(51)(5), (3)(23)(12)(1)(12)(23)(3), (5)(51)(1)(51)(5),  $|\text{br}(h)| \leq 7$ .

The lemma is proved.  $\square$

**Lemma 7.26.** *There exists an algorithm to check, given two admissible words  $U, V$  for  $\bar{\mathcal{S}}$ , if there exist a ring computation  $U \bullet h = V$  of  $\bar{\mathcal{S}}$ . The length of  $|h|$  is recursively bounded in terms of  $|U| + |V|$ .*

*Proof.* We can assume that the bases of  $U$  and  $V$  are the same, the first and the last letters of that base coincide.

First we check, using Lemma 7.24, if both words are acceptable by  $\bar{\mathcal{S}}$ .

**Case 1.** Suppose that the answer is “yes”. Let  $U \bullet h_1 = \Sigma(w_1)^s K_1(\emptyset, 1)$  and  $V \bullet h_2 = \Sigma(w_2)^s K_1(\emptyset, 1)$  be accepting computations.

Let  $\delta$  be the homomorphism  $\mathcal{H} \rightarrow \bar{\mathcal{G}}$  from Lemma 3.1. By Lemma 3.7 and Lemma 6.9, if  $\delta(w_1)$  and  $\delta(w_2)$  are equal in  $\bar{\mathcal{G}}$  then there exists a computation  $\Sigma(w_1)^s K_1(\emptyset, 1) \bullet h_3 = \Sigma(w_2)^s K_1(\emptyset, 1)$ . Then  $U \bullet h_1 h_3 h_2^{-1} = V$  (or another computation if the corresponding annular diagram is not reduced) is a ring computation (by Lemma 6.16).

Suppose that  $\delta(w_1) \neq \delta(w_2)$  in  $\bar{\mathcal{G}}$ . Then by Lemma 3.2 there exist no computations connecting  $\Sigma(w_1)^s K_1(\emptyset, 1)$  and  $\Sigma(w_2)^s K_1(\emptyset, 1)$ . Hence there is no computation connecting  $U$  and  $V$ . Since the word problem in  $\bar{\mathcal{G}}$  is decidable, we deduce that, in Case 1, we can check if  $U$  and  $V$  are connected by a computation of  $\bar{\mathcal{S}}$ .

**Case 2.** Suppose that  $U$  or  $V$  are not accepted by  $\bar{\mathcal{S}}$ . Then we can assume that both are not accepted (otherwise  $U$  and  $V$  obvious cannot be connected by a computation). Then by Lemmas 7.25 and 7.24, one has to check only computations whose brief histories have lengths at most 13 (if  $U$  is wild) or 19 if  $U$  is tame. This can be done by Lemma 7.23.

In both cases we obtain a computation (if it exists) of recursively bounded length. Thus the number of transition rules is bounded for every ring computation which connect  $U$  and  $V$ . Then Lemma 7.23 helps us to effectively select a desired ring computation.  $\square$

## 7.5 All ring computations

**Lemma 7.27.** *Let  $U \bullet h = V$  be a ring computation of  $\mathcal{S} \cup \bar{\mathcal{S}}$ . Then*

- (1)  $h = h_1 h_2 h_3$  where  $h_1, h_3$  are words in  $\mathcal{S}$ ,  $h_2$  is a word in  $\bar{\mathcal{S}}$ .
- (2) If  $h_2$  is not empty, then  $|\text{br}(h_1)|, |\text{br}(h_3)|$  are recursively bounded in terms of  $|U|, |V|$ .

*Proof.* (1) Suppose  $h = h' h_0 h''$  where non-empty word  $h_0$  is over  $\mathcal{S}$ ,  $h'$  ends and  $h''$  starts with a rule from  $\bar{\mathcal{S}}$ . Let  $U' = U \bullet h'$ , and consider the computation  $U' \bullet h_0$ . Denote by  $\Delta$  the ring corresponding to the computation  $U \bullet h$ . Notice that a rule of  $\mathcal{S}$  as well as a rule from  $\bar{\mathcal{S}}$  can be applied to  $U'$  and to  $U' \circ h_0$ . Hence there are no  $a$ -letters in  $U'$  except for  $a(P_j)$ -letters. Therefore the subring  $\Delta_0$  of  $\Delta$ , which correspond to  $U' \bullet h_0$  has no  $\mathcal{X}$ -letters by Lemma 6.1.

Notice that by definition of  $\bar{\mathcal{S}}$  if in every rule  $\tau$  of  $\mathcal{S}$ , we remove  $a$ -letters in subrules  $z \rightarrow uz'v$  where  $z \in \{K_1, L_1, P_1, R_1\}$  and put  $\bar{\phantom{x}}$  over every letter of the rule, we get a rule  $\bar{\tau}$  from  $\bar{\mathcal{S}}$ . Moreover, if for any admissible word  $W$  in the domain of  $\tau$ , we remove  $a$ -letters from  $zz'$ -sectors where  $z, z' \in \{K_1, L_1, P_1, R_1, K_2\}$ , and add  $\bar{\phantom{x}}$  to every letter, we get an admissible word  $\bar{W}$  for  $\bar{\mathcal{S}}$ , and

$$\bar{W} \circ \bar{\tau} = \overline{W \circ \tau}.$$

Since the words  $U'$  and  $U' \circ h_0$  are in domains of rules from both  $\bar{\mathcal{S}}$  and  $\mathcal{S}$ ,  $\overleftarrow{L}_j z, L_j z-, R_j z-$  sectors of these words do not contain  $a$ -letters, for any  $j$ , the  $\overleftarrow{L}_1-, L_1 z-, P_1 z-, R_1 z-$  sectors do not contain  $a$ -letters, the  $a$ -letters in  $P_j z$ -sectors are from  $\{a_1(P_1), \dots, a_m(P_1)\} = \{\bar{a}_1(P_1), \dots, \bar{a}_m(P_1)\}$ , and the  $(\bar{\mathcal{E}}, \Omega)$ -coordinates of these words are  $(\emptyset, 1)$ . Hence  $\bar{U}' = U$  and  $\bar{U}' \circ \bar{h}_0 = U' \circ h_0$ . Therefore we can replace  $h_0$  by a word  $\bar{h}_0$  over  $\bar{\mathcal{S}}$  so that  $U' \circ \bar{h}_0 = U' \circ h_0$ . By Lemmas 6.16 and 7.2 and the lack of the  $\mathcal{X}$ -edges in the boundary of  $\Delta_0$ , the computation  $U \bullet h' \bar{h}_0 h'' = V$  or another computation if the corresponding ring diagram is not reduced, is a ring computation, but some  $\Theta$ -letters of  $h$  are replaced by  $\bar{\Theta}$ -letters in  $h' \bar{h}_0 h''$ . This contradicts the definition of reduced and compressible diagrams, because  $(\Theta, k)$ -cells are higher than  $(\bar{\Theta}, k)$ -cells.

(2) Assume  $h_2$  is non-empty and consider, for instance,  $\text{br}(h_1)$ . If  $U$  is wild and there are no letters (34) in  $\text{br}(h_1)$ , then the forms (i) - (iv) from the proof of Lemma 7.19 show that  $|\text{br}(h_1)| \leq 9$ . If  $U$  is wild, and  $\text{br}(h_1)$  contains (34) and one of the letter (1), (12), (2), (23), (45), (5), (51), then, by Lemma 7.16, we can assume that  $U^{\pm 1}$  contains an admissible subword with base  $\overleftarrow{L}_j L_j P_j R_j \overrightarrow{R}_j$  for some  $j \neq 1$ . If  $U$  is wild, and every letter of  $\text{br}(h_1)$  belongs to  $\{(3), (34), (4)\}$ , then  $|\text{br}(h_1)| \leq 5$  as this was shown in the proof of Lemma 7.18. Thus, we may assume further that the base of  $U^{\pm 1}$  contains an admissible subword with base  $\overleftarrow{L}_j L_j P_j R_j \overrightarrow{R}_j$  for some  $j \neq 1$ .

By Lemma 7.7, we may assume that  $\text{br}(h_1)$  contains each of the letters (12), (23), (34), (45), (51). Using the locking argument as in Lemma 7.17, we conclude that  $U$  is tame. Then we may assume by Lemma 7.24(1), that  $U$  is accepted by  $\mathcal{S}$ :  $U \circ g_1 = \Sigma^s(w) K_1(0, 1)$  for some ring computation  $U \bullet g_1$  of  $\mathcal{S}$ .

Let  $U_1$  be an admissible subword of the tame word  $U^{\pm 1}$  with base  $K_1 L_1 P_1 R_1 K_2^{-1}$ . Then the standard application of the homomorphism  $\delta$  (introduced before Lemma 3.1) to  $U_1 \bullet g_1$  shows that  $\delta(U_1) = \delta(w)$  in the group  $\bar{\mathcal{G}}$ . The same homomorphism applied to

$U_1 \bullet h_1$  shows that  $\delta(U_1) = 1$  in  $\bar{\mathcal{G}}$  since the  $\bar{\mathcal{S}}$ -rules of  $h_2$  lock  $K_1L_1^-$ ,  $L_1P_1^-$ ,  $P_1R_1^-$  and  $R_1K_2^{-1}$ -sectors. Hence the positive word  $w$  represents the identity of  $\bar{\mathcal{G}}$ .

Now, by lemmas 2.1 and 3.6, there exists a ring computation  $(U \circ g_1) \bullet g_2 = \tilde{\Sigma}$  of  $\mathcal{S}$ . Set  $g = g_1g_2$ , then the length of the ring computation  $U \bullet g = \tilde{\Sigma}$  (or of some other ring computation if the annular diagram, corresponding to  $U \bullet g$  is not reduced) is recursively bounded as function of  $|U|$ . (Since we already know that such a computation exists, and the number of its  $\mathcal{S}(34)$ -rules is bounded, we get an upper bound for its length as in the proof of Lemma 7.21(2).)

The computation  $U \bullet gg^{-1}h_1$  corresponds to a diagram consisting of three reduced rings. It contains the subcomputation  $\tilde{\Sigma} \bullet (g^{-1}h_1) = U \circ h_1$ . Since  $\tilde{\Sigma} \equiv \tilde{\Sigma}$  and  $U \circ h_1$  is in the domain of  $h_2$ , we have, as in part (1) of the proof, a ring computation of  $\bar{\mathcal{S}}$ :  $\tilde{\Sigma} \bullet f = U \circ h_1$ . Hence the ring computation  $U \bullet h'$  can be replaced by the computation  $U \bullet g(fh_2)h_3$  with recursively bounded length of  $\text{br}(g)$  where computation  $(U \circ g) \bullet fh_2$  is a computation of  $\mathcal{S}$ ). Therefore the number of rules from  $\mathcal{S}(34)$  is also recursively bounded in  $h_1$  since otherwise  $\Delta$  were compressible. Then, by Lemma 7.7, we have a recursive upper bound for the length of  $\text{br}(h_1)$ . (Again  $U \circ$ )  $\bullet fh_2$  can be replaced by a ring computation if the corresponding annular diagram is not reduced.)  $\square$

According to Lemma 7.27, we will consider ring computations of the form  $U \bullet h_1h_2h_3 = V$  where  $h_1, h_3$  are words over  $\mathcal{S}$ ,  $h_2$  is a word over  $\bar{\mathcal{S}}$ , and if  $h_2$  is not empty, then  $|\text{br}(h_1)|, |\text{br}(h_3)|$  are recursively bounded in terms of  $|U|$  and  $|V|$ . We fix this notation for the next two lemmas.

**Lemma 7.28.** *Assume the word  $h_2$  is non-empty. Then the words  $h_1$  and  $h_3$  have lengths bounded by a recursive function of  $|U|$  and  $|V|$  respectively.*

*Proof.* Consider the computation  $U \bullet h_1$  (the computation  $V \bullet h_3^{-1}$  is similar).

**Case 1.** First suppose that the base of the computation contains the  $j$ -standard base  $\overleftarrow{L}_jL_jP_jR_j\overrightarrow{R}_j$ ,  $j \neq 1$ . Then we can consider the restriction of the computation to a subword of  $U$  with the  $j$ -standard base. We know that the length of  $\text{br}(h_1)$  is recursively bounded. Therefore the number of occurrences of (34) in  $h$  is also bounded. Notice also that since  $U \circ h_1$  is in the domain of a rule of  $\bar{\mathcal{S}}$ , the  $\overleftarrow{L}_jL_j^-, L_jP_j, R_j\overrightarrow{R}_j$ -sectors of  $U \circ h_1$  do not contain  $a$ -letters. Therefore, by Lemma 7.10(b),  $|\overleftarrow{L}_j(U \circ h_1[t])| + |L_j(U \circ h_1[t])| + |R_j(U \circ h_1[t])|$ ,  $t = 1, \dots, |h_1|$  is bounded by a recursive function in  $|U|$ . Then Lemma 7.5 gives a recursive upper bound for lengths of arbitrary maximal subword of  $h_1$  over  $\mathcal{S}(g)$ ,  $g = 1, \dots, 5$ . Since the number of such subwords is recursively bounded, we get a recursive bound for  $|h_1|$  in terms of  $|U|$  and the claim is proved.

**Case 2.** Assume now that the base of  $U^{\pm 1}$  does not contain  $W_j = \overleftarrow{L}_jL_jP_jR_j\overrightarrow{R}_j$  as a subword for any  $j \neq 1$ .

Notice, however, that since  $U \circ h_1$  is in the domain of a rule from  $\mathcal{S}$  and a rule from  $\bar{\mathcal{S}}$ , the word  $U \circ h_1$  does not contain letters from  $\mathcal{A}(K_j) \cup \bar{\mathcal{A}}(K_j) \cup \mathcal{A}(L_j) \cup \bar{\mathcal{A}}(L_j) \cup \mathcal{A}(R_j) \cup \bar{\mathcal{A}}(R_j)$  since such letters does not belong to  $\mathcal{A} \cap \bar{\mathcal{A}}$ . Therefore, by Lemma 2.2, every  $\overleftarrow{L}_j^-$ ,  $L_j^-$ ,  $P_j^-$ ,  $R_j^-$  and  $\overrightarrow{R}_j$ -letter in the base of  $U$  must occur in subwords of the form  $(\overleftarrow{L}_jL_j)^{\pm 1}$ ,  $(R_j\overrightarrow{R}_j)^{\pm 1}$ ,  $(L_jP_j)^{\pm 1}$ . Hence, by Lemma 6.2 the base of the corresponding ring  $\Delta$  must contain a letter  $L_j$  or a letter  $R_j$  for  $j \neq 1$ .

Let us consider only the first case, because one can apply the same argument to the second one. In this case, subword  $(P_j R_j)^{\pm 1}$  cannot be a neighbor in the base to the occurrence of  $L_j^{\pm 1}$ , since otherwise we get a subword  $W_j$  in the base of  $U$ . Consequently,  $\text{br}(h_1)$  does not contain the letter (34) (because rules from  $\mathcal{S}(34) \cup \bar{\mathcal{S}}(34)$  lock  $L_j P_j$ - and  $P_j R_j$ -sectors) and the base of  $U^{\pm 1}$  contains a subword  $W'_j = \overleftarrow{L}_j L_j P_j P_j^{-1} L_j^{-1} (\overleftarrow{L}_j)^{-1}$ . Let  $U'$  be a subword of  $U$  with base  $W'_j$ .

Consider the computation  $U' \bullet h_1$ . The word  $U' \circ h_1$  has the form

$$(\overleftarrow{L}_j L_j P_j v P_j^{-1} L_j^{-1} \overleftarrow{L}_j^{-1})(r, i)$$

$((r, i)$  are the  $(\bar{\mathcal{E}}, \Omega)$ -coordinates), where  $v$  is a word in  $\{a_1(P_j), \dots, a_m(P_j)\}$ . (Recall that  $a_i(P_j)$  is identified with a  $\bar{a}_i(P_j)$  only if  $i \leq m$ .)

Let  $\gamma$  be the homomorphism defined in the proof of Lemma 7.13. Then  $|\gamma(v)| \leq |U'|$ . This means that we have a linear bound of  $|U' \circ h_1|$  in terms of  $|U'|$ . Since this argument works for every subword of  $U^{\pm 1}$  with base  $W'_j$ ,  $j \neq 1$ , and  $U \circ h_1$  contains no  $a$ -letters except letters from  $\mathcal{A}(P_j) \cup \bar{\mathcal{A}}(P_j)$ ,  $j \neq 1$ , we obtain a linear bound for  $|U \circ h_1|$  in terms of  $|U|$ . It remains to apply Lemma 7.20.  $\square$

**Lemma 7.29.** *There is an algorithm to check whether, given two admissible words  $U, V$  for  $\mathcal{S} \cup \bar{\mathcal{S}}$ , there exists a ring computation  $U \bullet h = V$ . The length of the history  $h$  is recursively bounded in terms  $|U|, |V|$  for arbitrary such ring computation.*

*Proof.* By Lemma 7.22, we can assume that there are no computations of  $\mathcal{S}$  connecting  $U$  and  $V$ . By Lemma 7.26, we can assume that there is no ring computation of  $\bar{\mathcal{S}}$  connecting  $U$  and  $V$ . (Recall that all ring computations  $U \bullet f = V$  of  $\mathcal{S} \cup \bar{\mathcal{S}}$  must have equal length  $|f|$  depending on  $U$  and  $V$ , by the definition of a reduced diagram.)

Hence, by Lemma 7.27, we have to analyze only the “mixed” situation when  $h_2$  is not empty and  $h_1$  or  $h_3$  is not empty (see notations introduced before Lemma 7.28).

The sum  $|h_1| + |h_3|$  is recursively bounded by Lemma 7.28. Therefore the lengths  $|U \circ h_1|$  and  $|U \circ h_1 h_2|$  are recursively bounded modulo  $\mathcal{G}$ -relations (i.e., if we substitute the subwords in  $\mathcal{A}(P_1)$  by equal modulo  $\mathcal{G}$  shorter subwords). Therefore by Lemma 7.26, we can recursively bound  $|h_2|$ . Hence we can recursively bound the sum  $|h| = |h_1| + |h_2| + |h_3|$ .  $\square$

**Lemma 7.30.** *Let  $\Delta$  be any annular diagram over  $\Delta$  whose contours  $p, q$  do not contain  $\theta$ -edges. Then there exists another annular diagram  $\Delta'$  with the same boundary labels and recursively bounded number of cells (in terms of  $|p| + |q|$ ). Moreover,  $\Delta'$  and  $\Delta$  have equal histories if  $\Delta$  is a ring.*

*Proof.* By Lemma 6.4, we can assume that  $\Delta$  is a ring or a quasiring. Lemma 6.14 treats the quasiring case, so we can assume that  $\Delta$  is a ring. By Lemma 7.29, we can bound the size of the corresponding ring computation. Finally Lemma 7.1 bounds the number of cells in  $\Delta$ .  $\square$

## 8 Spirals

We need the following properties of words in a free group  $F$ .

**Lemma 8.1.** *For arbitrary elements  $u, v, w$  of  $F$  and any integer  $d \geq 0$ , the length of arbitrary product  $u^t w v^t$  in  $F$  is not greater than  $|u| + |v| + |w| + |u^d w v^d|$  provided  $0 \leq t \leq d$ . Furthermore, either equality  $u^t w v^t = w$  is true in  $F$  for every  $t$  or  $|u^t w v^t| \geq t - (|u| + |v| + |w|)$ .*

*Proof.* Since, for any word  $U$ , a power  $U^s$  is freely equal to  $YU_0^s Y^{-1}$  where  $U_0$  is the cyclically reduced form of  $U$  and  $|Y| \leq |U|$ , it suffices to assume that the words  $u$  and  $v$  are cyclically reduced. Moreover one of them can be assumed to be non-empty, and words  $u$  and  $v$  can be assumed to be not equal to proper powers of some non-trivial elements of  $F$ .

Of course, there may be cancellations in the words  $u^t w v^t$ .

Suppose first, that the cancellations are not substantial in the following sense: the length of the suffix (resp. prefix) of  $u^t w$  (resp.  $w v^t$ ) that is cancelled in the product  $u^t w v^t$  does not exceed  $|w| + |u| + |v|$  for every  $t$ . Then the sequence of lengths  $|u^t w v^t|$  increases linearly with the slope  $\geq |u| + |v| \geq 1$  for  $t \geq |w| + |u| + |v|$ . Hence  $|u^t w v^t| \leq |u| + |v| + |w| + |u^d w v^d|$ , as desired.

Now suppose that there exists a substantial cancellation in the above mentioned sense. Then both words  $u^t$  and  $v^{-t}$  contain a common subword  $T$  with  $|T| \geq |u| + |v|$ . This implies (see, e.g. [FW]) that  $u$  and  $v^{-1}$  coincide up to a cyclic shift:  $v^{-1} \equiv u_2 u_1$  and  $u \equiv u_1 u_2$  for some words  $u_1, u_2$ . Furthermore the word  $w u_1^{-1}$  must be freely equal to a power  $u^l$  for some  $l$ . Therefore  $u^t w v^t = u^t u^l u_1^{-1-t} u_2^{-1} = u^{l+t} u_2^{-1} = w u_1^{-1} u_1 u_2 u_2^{-1} = w$  in  $F$  for arbitrary  $t$ . The lemma is proved.  $\square$

By Britton's lemma, every  $x$ -letter has infinite order in the group  $\mathcal{H}_2$ . It is also convenient to introduce auxiliary letters  $x^{1/4}, x^{1/16}, \dots$  for every letter  $x \in \mathcal{X}$ . In other words, we embed our group  $\mathcal{H}_2$  into the multiple amalgamated product of  $\mathcal{H}_2$  and infinite cyclic groups  $C_{x,i} = \langle x^{\frac{1}{4^i}}, x \in \mathcal{X} \rangle, i = 0, 1, 2, \dots$  where  $C_{x,0} = \langle x \rangle, x \in \mathcal{X}$ , and for every  $i \geq 1, C_{x,i}$  is identified with the subgroup of  $C_{x,i+1}$  generated by  $(x^{\frac{1}{4^{i+1}}})^4$ . Letters  $x^{\frac{1}{4^n}}$  will be called *fractional letters*, words in these letters will be called *fractional words*.

**Lemma 8.2.** *Let  $\Delta$  be a quasitrapezium with the standard decomposition of the boundary  $p_1 p_2 p_3 p_4$ . Assume that the height of  $\Delta$  is 2,  $\Delta$  has no  $\mathcal{G}$ -cells and  $w_1, w_3$  are maximal subwords in the alphabet  $\mathcal{X}$  of  $\phi(p_1), \phi(p_3^{-1})$ , respectively. (Recall that  $p_1 = \mathbf{top}(\mathcal{B}), p_3^{-1} = \mathbf{bot}(\mathcal{B}')$  as in the definition of trapezium or quasitrapezium.) Then  $w_3$  is freely equal to  $u w'_1 v$  where  $w'_1$  is obtained from  $w_1$  by an injective substitution of the form  $x \mapsto (x')^{4^c}$  ( $x, x' \in \mathcal{X}$ ), the integer  $c$  (same for all  $x \in \mathcal{X}$ ) and the fractional words  $u, v$  depend recursively only on the boundary labels of the maximal  $\theta$ -bands  $\mathcal{T}_1, \mathcal{T}_2$  of  $\Delta$ .*

*Proof.* Consider the subdiagram  $\Gamma$  of  $\Delta$  bounded by  $\mathbf{top}(\mathcal{T}_1)$  and  $\mathbf{bot}(\mathcal{T}_2)$ . Let  $\bar{p}_1 \bar{p}_2 \bar{p}_3 \bar{p}_4$  be its boundary, where  $\phi(\bar{p}_1) \equiv w_1$  and  $\phi(\bar{p}_3)^{-1} \equiv w_3$ . Consider the maximal system of maximal  $z$ -bands  $\mathcal{B}_1, \dots, \mathcal{B}_n$  which start on  $\bar{p}_4$  and end on  $\bar{p}_2$ , where  $z$  is one of  $k$ - or  $a$ -letters. In particular,  $\mathcal{B}_1$  and  $\mathcal{B}_n$  are subbands of  $\mathcal{B}$  and  $\mathcal{B}'$  respectively. Let  $p_1^i p_2^j p_3^k p_4^l$  be the standard decomposition of the boundary  $\partial(\mathcal{B}_i)$ , where  $p_2^j, p_4^l$  are edges from the

paths  $\bar{p}_2$  and  $\bar{p}_4$ , respectively, and the labels  $w_1^{(i)}, w_3^{(i)}$  of  $p_1^i, (p_3^i)^{-1}$  are some words in  $\mathcal{X}$ . In particular,  $w_1^{(1)} \equiv w_1$  and  $w_3^{(n)} \equiv w_3$ . The words  $w_1^{(i)}, w_3^{(i)}$  are empty if  $\mathcal{B}_i$  is a  $P_j$ - or  $R_j$ -band, since there are no  $(P_j, x)$ - or  $(R_j, x)$ -relations of the form (2.9).

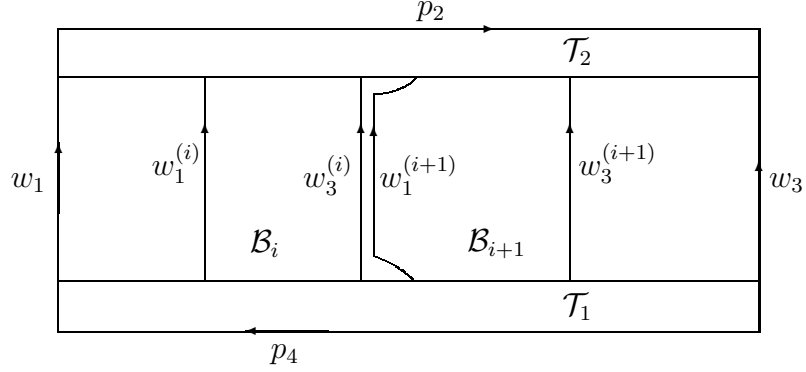

Fig. 20.

Notice, that by  $x$ -relations (2.8) and (2.9), the word  $w_3^{(i)}$  is obtained from the word  $w_1^{(i)}$  by an injective substitution of the form  $x \mapsto (x')^l$  on the set of  $x$ -letters of the word  $w_1^{(i)}$  where  $l \in \{1, 4, 1/4\}$ ,  $l$  does not depend on an  $x$ -letter  $x$ .

There are no cells of  $\Gamma$  in the maximal subdiagram of  $\Delta$  whose boundary consists of  $x$ -edges, and which is situated between  $\mathcal{B}_i$  and  $\mathcal{B}_{i+1}$ . Indeed, by Lemma 3.11, otherwise any non- $\mathcal{G}$ -cell would be included in an annulus, and there are at most two edges of  $\bar{p}_2$  ( $x$ -edges) between  $p_2^i$  and  $p_2^{i+1}$  and at most 2 edges of  $\bar{p}_4$  between  $p_4^i$  and  $p_4^{i+1}$  (it follows from Lemma 6.1). Hence the word  $w_1^{(i+1)}$  is freely equal to  $u_i w_3^{(i)} v_i$  for  $|u_i|, |v_i| \leq 2$ , and  $w_1^{(i+1)}$  is obtained from  $w_1^{(i)}$  by the above mentioned substitution  $x \mapsto (x')^l$  and multiplication by the words  $u_i, v_i$  which depend only on the bands  $\mathcal{T}_1, \mathcal{T}_2$ . The obvious induction on  $i \leq n$ , shows that  $w_3$  is freely equal to  $u w_1' v$  where  $w'$  is obtained from  $w_1$  by a substitution of the form  $x \mapsto (x')^{4^c}$  with  $|c| \leq n$  ( $c$  depends on the bands  $\mathcal{T}_1, \mathcal{T}_2$ ), and  $u, v$  are fractional words which can be effectively calculated given  $\mathcal{T}_1, \mathcal{T}_2$ .  $\square$

Let  $\Delta$  be a trapezium with at least 2-letter base. Suppose that the side bands  $\mathcal{B}$  and  $\mathcal{B}'$  of  $\Delta$  are partitioned into subbands  $\mathcal{B}_1, \mathcal{B}_2$  and  $\mathcal{B}'_1, \mathcal{B}'_2$  respectively, such that the band  $\mathcal{B}_1$  is the copy of  $\mathcal{B}'_2$  (or  $\mathcal{B}_2$  is the copy of  $\mathcal{B}'_1$ ), and each of the subbands  $\mathcal{B}_1, \mathcal{B}_2, \mathcal{B}'_1, \mathcal{B}'_2$  has a positive number of  $(\theta, k)$ -cells.

We can identify  $\mathcal{B}_1$  with  $\mathcal{B}'_2$  (or  $\mathcal{B}_2$  with  $\mathcal{B}'_1$ ). If the resulting annular diagram  $\Gamma$  is reduced and has minimal boundaries, it is called a *spiral* (see Figure 21).

Thus, a spiral  $\Gamma$  contains a  $k$ -band  $\mathcal{B}''$ , which connects its inner contour  $q$  with the outer contour  $p$ ; this band  $\mathcal{B}''$  is obtained from  $\mathcal{B}$  and  $\mathcal{B}'$  by the partial identification. The  $k$ -band  $\mathcal{B}''$  will be called the *main  $k$ -band* of the spiral. Notice that the length of the identified portion of the bands  $\mathcal{B}$  and  $\mathcal{B}'$  does not exceed the lengths of the contours of the spiral. Our goal will be to estimate the number of cells in a spiral with the given boundary labels in terms of the lengths of the contours.

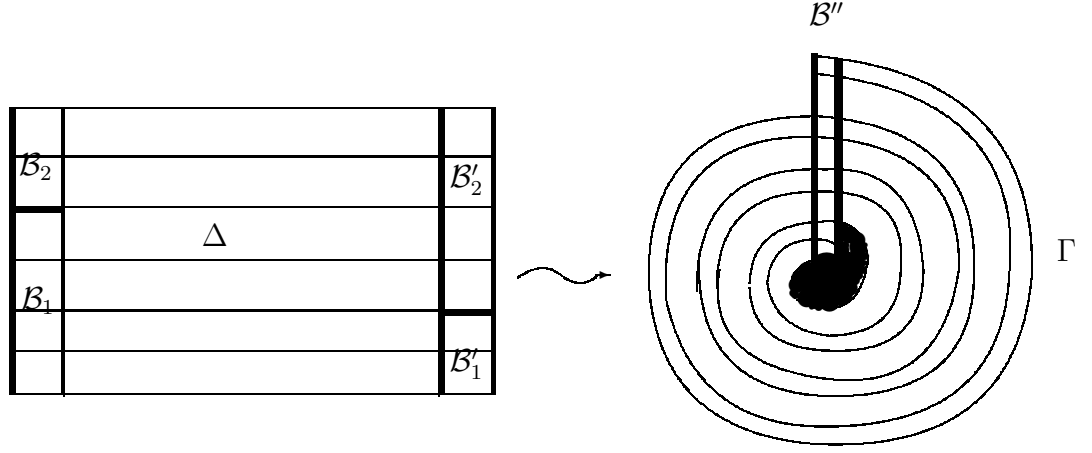

Figure 21.

It is easy to see that every maximal  $\theta$ -band of  $\Gamma$  is a union of  $\theta$ -bands of  $\Delta$ , it starts on the inner contour  $q$  of  $\Gamma$  and ends on the outer contour  $p$ . It may intersect the  $k$ -band of  $\Gamma$  many times, and looks like a spiral. (However it can intersect every  $k$ -band of  $\Gamma$  only in one direction: this follows from Lemma 3.11.) Hence the number of maximal  $\theta$ -bands of the spiral is at most  $\min(|q|, |p|)$ .

Let  $h_1, h_2$  be the histories of the bands  $\mathcal{B}_1, \mathcal{B}_2$ . Then  $\mathcal{B}$  and  $\mathcal{B}'$  have the history  $h_1h_2$ . On the other hand  $h_2$  is a prefix of the history of  $\mathcal{B}'$ . Hence  $h_1h_2 = h_2h_3$  for some  $h_3$ . If  $|h_1| > |h_2|$ , then this immediately implies that  $h_1h_2$  is a periodic word with period  $h_2$  (i.e.  $h_1h_2$  is a subword of  $h_2^l$  for some  $l > 0$ ). Notice that  $|h_2|$  does not exceed the length of the inner contour of the spiral. So  $|h_1h_2| < 2|h_2| \leq |q| + |p|$  if  $|h_1| \leq |h_2|$ , because every  $\theta$ -band in  $\Gamma$  connects  $q$  with  $p$ . Hence in any case, the history of  $\Delta$  is a periodic word whose period does not exceed  $|q| + |p|$ .

*Quasispirals* are defined like spirals when one takes a quasitrapezium with empty base as the original diagram instead of a trapezium.

**Lemma 8.3.** *Let  $\Delta$  be a reduced annular diagram over  $\mathcal{H}_1$  with minimal boundaries, whose labels contain at least one and a  $k$ - or  $a$ -edge,  $a \notin \mathcal{A}(P_1)$ . Let the corresponding maximal  $k$ - or  $a$ -band  $\mathcal{C}$  have recursively bounded (in terms of  $|p| + |q|$ ) number of  $\theta$ -cells. Then either (1) there exists a reduced annular diagram  $\Delta'$  over  $\mathcal{H}_1$  with the same boundary labels as  $\Delta$  and with recursively bounded (in terms of  $|p| + |q|$ ) number and perimeters of cells, or (2) there is a reduced annular diagram  $\Delta'$  without  $\mathcal{G}$ -cells and with minimal boundaries  $p'$  and  $q'$  which are at most twice longer than  $p$  and  $q$  respectively, and  $\phi(p)$  and  $\phi(p')$  (resp.  $\phi(q), \phi(q')$ ) are conjugate and the number and lengths of relations needed to deduce these conjugacies are recursively bounded.*

*Proof.* By Lemma 5.6, we can assume that  $\Delta$  has minimal boundaries. If there exists an  $a$ -band starting on a  $\mathcal{G}$ -cell in  $\Delta$  and ending on a  $k$ -band of  $\Delta$  then this must be a  $P_1$ - or an  $R_1$ -band, and so we would be able to turn  $\Delta$  into a simply connected van Kampen diagram by cutting along a side of this  $k$ -band. The length of this cut is recursively bounded as this follows from the lemma assumption and the lack of  $x$ -cells in  $P_1$ - and  $R_1$ -bands. After that we could apply Lemma 5.1. Thus we can assume that every  $a$ -band

starting on a  $\mathcal{G}$ -cell of  $\Delta$  ends on  $p$  or  $q$ . Therefore by Lemma 3.12, parts (1), (2), we can remove all the  $\mathcal{G}$ -cells from  $\Delta$  increasing the length of the boundary at most by a factor of 2. The total perimeter of all  $\mathcal{G}$ -cells that we remove is bounded by  $|p| + |q|$ .  $\square$

**Lemma 8.4.** *Let  $\Delta$  be a reduced annular diagram over  $\mathcal{H}_1$  with minimal boundaries  $p$  and  $q$  having a  $\theta$ -band  $\mathcal{T}$  and at least one  $k$ - or  $a$ -edge for an  $a$ -letter  $a \in (\mathcal{A} \cup \bar{\mathcal{A}}) \setminus \mathcal{A}(P_1)$ . Let  $\mathcal{C}$  be corresponding  $k$  or  $a$ -band connecting the contours  $q$  and  $p$ . Then there exists a diagram  $\Delta'$  with the same boundary label as  $\Delta$ , and such that  $\Delta' = \Delta_1 \cup \Delta_2 \cup \Delta_3$  where the number and perimeters of cells in  $\Delta_1, \Delta_3$  are recursively bounded and  $\Delta_2$  is either empty or a spiral, or a quasispiral.*

*Proof.* By Lemmas 5.4, 5.5, we can obtain a minimal diagram  $\Delta'$  satisfying (R1). Then all maximal  $\theta$ -bands in  $\Delta$  connect  $p$  and  $q$ , so their number does not exceed  $|p| + |q|$ . Also all maximal  $k$ -bands in  $\Delta'$  connect  $p$  and  $q$ . If there are no  $k$ -bands, then every  $a$ -band, for  $a \notin \mathcal{A}(P_1)$ , connects  $p$  and  $q$ .

All maximal  $a$ -bands starting on  $p$  or  $q$  end either on  $q$  and  $p$  respectively, or on a  $k$ -band or on a  $\mathcal{G}$ -cell (recall that different  $a$ -bands cannot cross and different  $k$ -bands cannot cross).

Suppose first that every  $\theta$ -band in  $\Delta$  intersects every  $k$ -band and every  $a$ -band,  $a \notin \mathcal{A}(P_1)$ , in  $\Delta$  at most twice. Since the number of maximal  $\theta$ -bands in  $\Delta$  is bounded by  $|p| + |q|$ , the number of  $\theta$ -cells in  $\mathcal{C}$  is at most  $2(|p| + |q|)$ . By Lemma 8.3 we can assume that  $\Delta$  does not contain  $\mathcal{G}$ -cells. Since the number of maximal  $k$ -bands in  $\Delta$  is bounded by  $|p| + |q|$ , the number of  $\theta$ -cells in  $k$ -bands of  $\Delta$  is bounded by  $2(|p| + |q|)^2$ . Therefore the number of maximal  $a$ -bands in  $\Delta$  is bounded by  $2(|p| + |q|)^2 + (|p| + |q|) < 3(|p| + |q|)^2$ . Since each of the  $a$ -bands intersects each of the  $\theta$ -bands at most twice, the number of  $\theta$ -cells in each of them is bounded by  $2(|p| + |q|)$ . Therefore the total number of  $\theta$ -cells in  $\Delta$  is bounded by  $6(|p| + |q|)^3 + 2(|p| + |q|)^2$ . Therefore the  $\theta$ -band  $\mathcal{T}$  has a recursively bounded length. Thus we can cut  $\Delta$  along a side of  $\mathcal{T}$ , obtain a simply connected van Kampen diagram with perimeter recursively bounded in terms of  $|p| + |q|$ , and use Lemma 5.1 to bound the number of cells in  $\Delta$ .

Notice that if a  $\theta$ -band intersects an  $a$ - or  $k$ -band  $\mathcal{C}'$  three times then by Lemma 3.11 it must go around the hole of the diagram twice and so by Jordan's lemma it intersects the  $a$ - or  $k$ -band  $\mathcal{C}$  connecting  $p$  and  $q$  at least twice.

Thus we can assume that the  $\theta$ -band  $\mathcal{T}$  in  $\Delta$  intersects  $\mathcal{C}$  twice. Moreover we can conclude that there is a subband  $\mathcal{C}_0$  of  $\mathcal{C}$  with linearly (in terms of  $|p| + |q|$ ) bounded number of  $\theta$ -cells in  $\mathcal{C} \setminus \mathcal{C}_0$ , such that for every  $\theta$ -cell  $\pi$  of  $\mathcal{C}_0$  there is a  $\theta$ -band  $\mathcal{T}_\pi$  which starts with  $\pi$  and whose last cell  $\pi'$  (and no other cell) also belongs to  $\mathcal{C}$ ,  $\pi' \neq \pi$ . These bands  $\mathcal{T}_\pi$ , for  $\pi \in \mathcal{C}_0$ , (and the auxiliary cells between them) form a subdiagram  $\Delta_2$  which is a spiral or a quasispiral with main band  $\mathcal{C}_0$  by the construction and the assumptions on  $p$  and  $q$ . If there exists a  $\mathcal{G}$ -cell in  $\Delta$  outside  $\Delta_2$  and an  $a$ -band connecting it with the boundary of  $\Delta_2$ , we can use Lemma 3.12, move the  $\mathcal{G}$ -cell to the boundary of  $\Delta_2$ , and then include that cell in  $\Delta_2$ . Thus we can assume that there are no  $\mathcal{G}$ -cells in  $\Delta$  outside  $\Delta_2$  which are connected with the boundary of  $\Delta_2$  by an  $a$ -band.



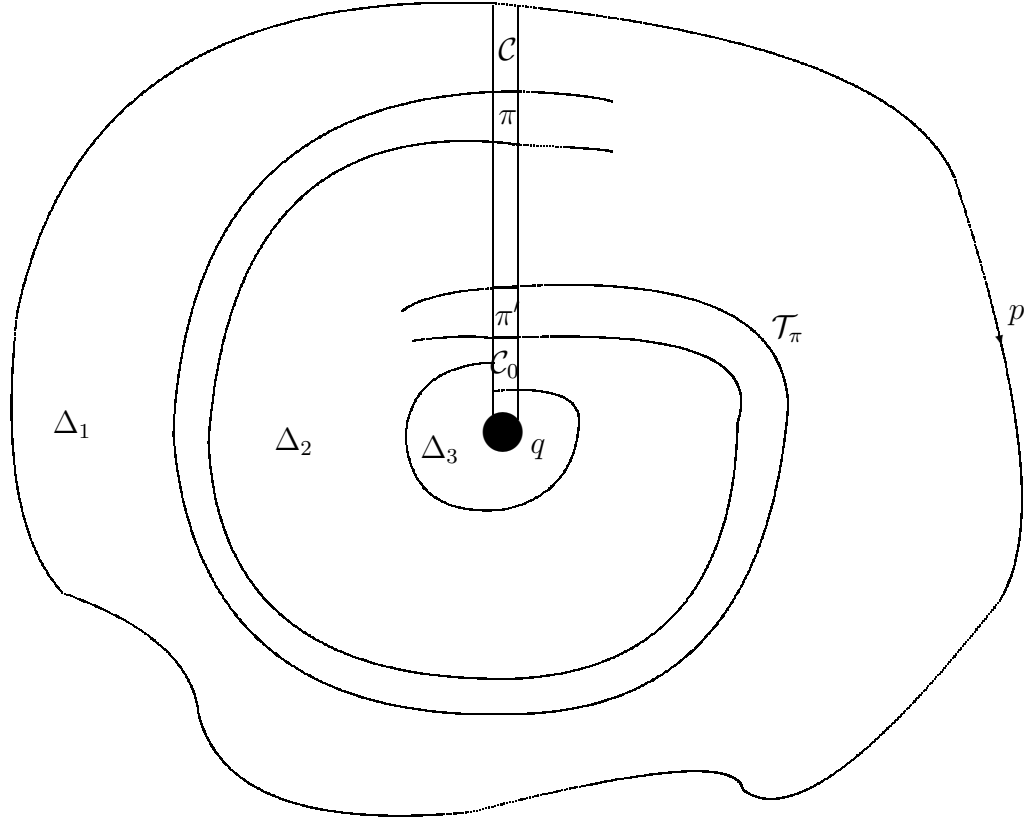

Fig. 22.

The diagram  $\Delta$  is a union of  $\Delta_2$  and two annular diagrams  $\Delta_1$ ,  $\Delta_3$  which are situated between  $\Delta_2$  and  $p$  and between  $\Delta_2$  and  $q$  respectively.

Our purpose is to obtain a recursive upper bound for the number of cells in  $\Delta_1$  and  $\Delta_3$  as a function in  $|p|, |q|$ . We will consider only the diagram  $\Delta_1$  ( $\Delta_3$  is similar).

By the choice of  $\mathcal{C}_0$ , each of the maximal  $\theta$ -bands in  $\Delta$  has linearly bounded (in terms of  $|p| + |q|$ ) number of intersections outside  $\Delta_2$  with every maximal  $a$ - or  $k$ -band of  $\Delta$ . Notice also that an  $a$ -band of  $\Delta_1$  which has at least one  $\theta$ -cell, cannot start and end on the boundary of  $\Delta_2$  by Lemma 3.11. Hence every maximal  $a$ -band of  $\Delta_1$  must start and end on  $p$  or on a  $(k, \theta)$ -cell, and therefore the number of  $\theta$ -cells in  $\Delta_1$  is recursively bounded in terms of  $|p| + |q|$ . By our assumption, every  $a$ -band starting on a  $\mathcal{G}$ -cell of  $\Delta_1$  ends on  $p$  or on a  $\theta$ -cell of  $\Delta_1$ . Therefore the total perimeter of all  $\mathcal{G}$ -cells in  $\Delta_1$  is recursively bounded.

Since  $\theta$ -cells of  $\Delta_1$  are arranged in  $\theta$ -bands starting on  $p$ , we may delete all (recursively bounded number) of them from  $\Delta_1$  (the result will be again an annular diagram) and assume that every cell of  $\Delta_1$  is an  $(a, x)$ -cell or a  $(k, x)$ -cell corresponding to the relations (2.8), (2.9), or a  $\mathcal{G}$ -cell. Then the  $\mathcal{G}$ -cells can also be deleted from  $\Delta_1$  by Lemma 3.12 (and such transformations do not change the boundary of  $\Delta_2$ ).

Since there are no  $a$ -,  $k$ -,  $(a, \theta)$ -,  $(k, \theta)$ -annuli in  $\Delta$  by Lemma 3.11, all cells of  $\Delta_1$  belong to maximal  $a$ - and  $k$ -bands  $\mathcal{C}_1, \mathcal{C}_2, \dots$  starting on  $p$  (and ending on the other boundary

component of  $\Delta_1$ ). Hence it suffices to bound the length of each of these  $a$ - and  $k$ -bands in  $\Delta_1$ .

Notice that the common boundary component, say  $u$ , of  $\Delta_1$  and  $\Delta_2$  is the boundary component of a spiral (or quasispiral). By the above construction of  $\Delta_2$ , we have  $u = u_1u_2$  where  $u_1$  belongs to the boundary of  $\mathcal{C}_0$ , the last edge of  $u_1$  is a  $\theta$ -edge, and the label of  $u_2$  is the label of a  $\theta$ -band (modulo  $\mathcal{G}$ ).

Suppose that there is a band  $\mathcal{C}_i$  among  $\mathcal{C}_1, \mathcal{C}_2, \dots$ , which ends on  $u_2$ . We may assume that  $i$  is chosen so that the end of  $\mathcal{C}_i$  is the nearest to the beginning of  $u_2$  among all  $\mathcal{C}_j$  ending on  $u_2$ . Then  $\mathbf{bot}(\mathcal{C}_i)$  cannot have common edges with any  $\mathcal{C}_j$  since the last edge of  $u_1$  is a  $\theta$ -edge, which also belong to  $p$ . (Recall that now we have no  $\theta$ -cells in  $\Delta_1$ .) The bottom of  $\mathcal{C}_i$  has at most 2 common edges with  $u_2$  because  $u_2$  can have at most 2 consecutive  $x$ -letter in its boundary label by Lemma 6.1. Hence the length of  $\mathcal{C}_i$  is recursively bounded by  $|p|$ .

Then suppose that there is a band  $\mathcal{C}_i$  ending on  $u_1$  (and so  $\mathcal{C}$  is a  $k$ -band). It is clear from the form of  $(k, \theta)$ -relations that there is a subpath  $evf$  of  $u_1^{\pm 1}$  such that  $e$  is the end of  $\mathcal{C}_i$ ,  $f$  is a  $\theta$ -edge, and  $v$  contains no two consecutive  $x$ -letters in its label. We may assume that no  $\mathcal{C}_j$  ends on  $v$ . Then, as in the first case, the length of  $\mathcal{C}_i$  is recursively bounded by  $p$ .

Thus, in any case, there is a band, say  $\mathcal{C}_1$ , whose perimeter and whose number of cells are linearly bounded in terms of  $|p|$ . We delete  $\mathcal{C}_1$  from  $\Delta_1$  and then choose a band in the remaining subdiagram of  $\Delta_1$ , whose perimeter and whose number of cells are recursively bounded as well. Then we delete  $\mathcal{C}_2$ , etc. Since the number of  $a$ -,  $k$ -bands  $\mathcal{C}_1, \dots$  is recursively bounded, we conclude that there is a recursive bound for the number of cells in  $\Delta_1$ , and the lemma is proved.  $\square$

**Remark 8.1.** The proof of Lemma 8.4 shows that for every maximal  $k$ -band  $\mathcal{C}$  in a spiral  $\Delta$ , one can obtain another spiral  $\Delta'$  with contours  $p'$  and  $q'$ , such that (a) the words  $\phi(p)$  and  $\phi(p')$  ( $\phi(q)$  and  $\phi(q')$ ) are conjugate modulo relations used in  $\Delta$ ; (b) the number and lengths of relations used to deduce these conjugacies are recursively bounded in terms of  $|p| + |q|$ ; (c) the set of  $\theta$ -cells of the main band of  $\Delta'$  is a subset of the set of cells of the band  $\mathcal{C}$ . Thus if the base of a spiral has letters  $P_j$  or  $R_j$  we shall always assume that the main  $k$ -band of the spiral is a  $P_j$ - or a  $R_j$ -band.

**Lemma 8.5.** *Let  $h$  be a periodic word in  $\mathcal{S} \cup \bar{\mathcal{S}}$  with period  $h_0$  and let  $W \bullet h = W'$  be a free computation of  $\mathcal{S} \cup \bar{\mathcal{S}}$ . Then the number of different words among  $W \circ h[t]$ ,  $t = 1, \dots, |h|$  is recursively bounded in terms of  $|h_0| + |W| + |W'|$ .*

*Proof.* By lemma 2.6, for every  $zz'$ -sector of  $W$  there exist two words  $u$  and  $v$  depending on  $h_0$  whose size is linearly bounded in terms of  $|h_0|$ , such that the inner part of the corresponding  $zz'$ -sector in each  $W \circ h_0^t$  is equal in the free group to  $u^t W_{zz'} v^t$  where  $W_{zz'}$  is the inner part of the  $zz'$ -sector of  $W$ ,  $t = 1, \dots, s$ . By Lemma 8.1, we can assume that  $s$  is big enough so that  $s - |u| - |v| > |W'|$ , so  $u^t W_{zz'} v^t = W_{zz'}$  for every  $t = 1, \dots, s$ . Hence  $W = W \circ h_0 = W \circ h_0^2 = \dots$ . Replacing  $W$  by  $W \circ h'$  for any prefix  $h'$  of  $h_0$ , we get that  $W \circ h' = W \circ hh' = W \circ h^2h' = \dots$ . Therefore the number of different words in the computation associated with  $\Delta$  is recursively bounded in terms of  $|W| + |W'|$  and  $|h_0|$ .  $\square$

**Lemma 8.6.** *Let a minimal diagram  $\Gamma$  be a spiral obtained from a trapezium  $\Delta$ . Then the minimum of lengths of all the maximal  $k$ -bands of  $\Gamma$  is bounded by a recursive function of  $|q| + |p|$ , where  $q, p$  are inner and outer contours of  $\Gamma$ .*

*Proof.* Let  $W$  be the projection of the label of the bottom side of the trapezium  $\Delta$  corresponding to the spiral  $\Gamma$  onto  $\mathcal{A}\cup\bar{\mathcal{A}}\cup\mathcal{K}\cup\bar{\mathcal{K}}$ , and let  $h$  be the history of  $\Delta$  corresponding to  $\Gamma$ . Notice that  $h = h_0^s h'$  for some  $s$  and some prefix  $h'$  of  $h_0$ , and  $|W|, |h_0| \leq |q| + |p|$ . We need to bound  $s$  in terms of  $|q| + |p|$ . Indeed, suppose we have bounded  $s$ . Suppose the spiral contains a  $\mathcal{G}$ -cells. If there exists  $a$ -band starting on a  $\mathcal{G}$ -cell there ends on a  $P_1$ - or  $R_1$ -band, and the spiral has a cut of a recursively bounded length along a side of that band since it has no  $\mathcal{X}$ -cells. Thus we can assume, by Lemma 3.12, that all  $a$ -bands starting on  $\mathcal{G}$ -cells end on the boundary of the spiral, in which case the total perimeter of these cells is recursively bounded, and we can move these cells out of the spiral using Lemma 3.12. Therefore we can assume that the spiral does not contain  $\mathcal{G}$ -cells. Since the number of  $k$ -cells is recursively bounded in terms of  $|h|$  and  $|q| + |p|$ , we have that the number of maximal  $a$ -bands is bounded too. Hence the length of  $\theta$ -bands in  $\Delta$  are bounded as well, because every such a band has recursively bounded number of intersections with every  $a$ -band. Therefore there is a cut of  $\Delta$  with recursively bounded length, which makes possible to apply Lemma 5.1.

Let us assume that  $s > |q| + |p|$ .

Let us enumerate  $k$ -bands in  $\Gamma$  clockwise:  $\mathcal{B}_1, \dots, \mathcal{B}_c$ . Let  $\mathcal{T}$  be a maximal  $\theta$ -band of  $\Gamma$ . We can decompose  $\mathcal{T}$  into several subbands  $\mathcal{T}(1), \mathcal{T}(2), \dots, \mathcal{T}(r_c)$  such that every  $\mathcal{T}(l)$  (with possible exception  $\mathcal{T}(1)$ ) starts with a cell of the band  $\mathcal{B}_1$  and contains at most one common cell with each of the  $k$ -bands  $\mathcal{B}_1, \dots, \mathcal{B}_c$ . The bands  $\mathcal{T}(2), \mathcal{T}(3), \dots$  will be called the *turns* of  $\mathcal{T}$ . For every  $l = 2, \dots$  there is a path  $t(l)$  going along  $\mathcal{B}_1$ , which connect the initial vertex of the top  $p(l)$  of the turn  $\mathcal{T}(l)$  with that of the top of of  $\mathcal{T}(l+1)$ . Notice that  $p(l+1)_- = p(l)_+$ . Denote by  $q(l)$  the loop  $t(l)p(l)^{-1}$  associated with  $\mathcal{T}(l)$ . Notice also that for every  $l = 1, 2, \dots$  words  $\phi(p(l))_{\mathcal{A}\cup\bar{\mathcal{A}}\cup\mathcal{K}\cup\bar{\mathcal{K}}}$  coincides for some  $i$ , with the word  $W \circ h[i]$  with omitted the last  $k$ -letter  $z$ . The label of  $t(l)$  consists of at most  $|h_0|$   $\theta$ -letters and a number of  $x$ -letters.

Consider several cases.

**Case 1.** There is a  $P_j$ - or  $R_j$ -letter in the base of  $\Delta$ .

Then we assume that  $\mathcal{B}_1$  is a  $P_j$ - or a  $R_j$ -band by Remark 8.1. We have the following alternative.

**Case 1.1.** Suppose that the history of  $\Delta$  contains a rule from  $\bar{\mathcal{S}} \cup \mathcal{S}(34) \cup \mathcal{S}(4) \cup \mathcal{S}(45)$ .

Then we can assume that  $\mathcal{T}$  corresponds to one of these rules  $\tau$ . Let  $W_{zz'}$  be a sector of  $W$  which is not a  $P_1 R_1$ -,  $P_1 P_1^{-1}$ - or  $R_1^{-1} R_1$ -sector. Then the computation  $W_{zz'} \bullet h$  is a free computation and, by Lemma 8.5, the number of different words among  $W_{zz'} \circ h[i]$ ,  $i = 1, 2, \dots$  is recursively bounded in terms of  $|q| + |p|$ . Notice that the rule  $\tau$  locks  $P_1 R_1$ -sectors. Hence the  $P_1 z$ - and  $z R_1$ -sectors of  $\phi(p(l))_{\mathcal{A}\cup\bar{\mathcal{A}}\cup\mathcal{K}\cup\bar{\mathcal{K}}} z$  are of length 2. Therefore by Lemma 6.1, the number of different words among  $\phi(p(l))$ ,  $l = 1, 2, \dots$ , is recursively bounded.

Since the sides of  $P_j$ -, and  $R_j$ -bands do not contain  $x$ -edges, the lengths of the paths  $t(l)$ ,  $l = 1, 2, \dots$  do not exceed  $|h_0| \leq |q| + |p|$ .

Therefore the number of different labels of the loops  $t(l)p(l)^{-1}$ ,  $l = 1, 2, \dots$  is recursively bounded in terms of  $|q| + |p|$ . Notice that for different  $l$ 's these loops do not intersect each other. Since  $\Gamma$  is minimal, it cannot contain two non-intersecting loops with the same labels. Hence  $|h|$  is recursively bounded in terms of  $|q| + |p|$ . Hence the length of  $\mathcal{B}_1$  is recursively bounded, as desired.

**Case 1.2.** Suppose that no rules from  $\bar{\mathcal{S}} \cup \mathcal{S}(34) \cup \mathcal{S}(4) \cup \mathcal{S}(45)$  occur in  $h$ .

The history  $h$  is reduced by Lemma 6.8. By Lemma 6.12, then  $W \bullet h$  is a computation of  $\mathcal{S}$  and  $W$  is an admissible word for  $\mathcal{S}$ . Then one can apply Lemma 7.3 to the computation  $W \bullet h = W'(\text{mod } \mathcal{G})$  corresponding to the trapezium  $\Delta$  and obtain a free computation  $W \bullet h = W''$  where  $W'' = W'(\text{mod } \mathcal{G})$ . Notice any two  $P_j$ -bands (resp.  $R_j$ -bands) which have the same histories consist of the same cells since there are no  $(P_j, x)$ - and  $(R_j, x)$ -relations of the form (2.9). Therefore since  $W$  starts and ends with the same  $P_j$ - or  $R_j$ -letter, the free computation  $W \bullet h$  corresponds to a spiral whose inner contour has the same label as the inner contour of  $\Gamma$  and the outer contour has the same label mod  $\mathcal{G}$  as the outer contour of  $\Gamma$ . Therefore the inner parts of non- $P_1z$ - and non  $zR_1$ -sectors of  $W \circ h$  coincide with the corresponding subwords of  $W'$ . We would be able to apply the same argument as in Case 1.1 to the spiral corresponding to the free computation  $W \bullet h$  if we bound the sizes of  $P_1z$ - and  $zR_1$ -sectors of the word  $W \circ h$ .

Let us prove that these sizes are recursively bounded. We can certainly assume by Remark 8.1, that the base  $W^{\pm 1}$  starts and ends on  $P_1$  or  $R_1$ . If the base of  $W^{\pm 1}$  contains both  $P_1$  and  $R_1$ , we can assume that it starts with  $P_1$ .

By Lemma 2.2 there are the following possibilities for the base of  $W^{\pm 1}$ :

- the base of  $W^{\pm 1}$  has a prefix  $P_1R_1K_2$  and suffix  $K_1L_1P_1$ ;
- the base of  $W^{\pm 1}$  has a prefix  $P_1P_1^{-1}$  and suffix  $K_1L_1P_1$ ;
- the base of  $W^{\pm 1}$  has a prefix  $R_1^{-1}R_1K_2$ .

These three cases are completely similar, so let us consider only the first one. Then  $W^{\pm 1}$  has the form  $P_1V_1R_1V_2K_2\dots K_1V_3L_1V_4P_1$  where  $V_1$  (resp  $V_2, V_3, V_4$ ) is a word in  $\mathcal{A}(P_1)$  (resp.  $\mathcal{A}(R_1), \mathcal{A}(K_1), \mathcal{A}(L_1)$ ). By Lemma 2.6 there exist words  $u(L_1, h_0), v(L_1, h_0), u(P_1, h_0), v(P_1, h_0), u(R_1, h_0), v(R_1, h_0)$  such that

$$\begin{aligned} \beta(u(L_1, h_0)) &\equiv \beta(v(L_1, h_0))^{-1}, \\ \beta(u(P_1, h_0)) &\equiv \beta(v(P_1, h_0))^{-1}, \beta(u(R_1, h_0)) \equiv \beta(v(R_1, h_0))^{-1} \end{aligned} \tag{8.1}$$

and for every  $t = 1, \dots, s$

$$\begin{aligned} W \circ h_0^t &= \\ P_1u(P_1, h_0)^tV_1v(R_1, h_0)^tR_1u(R_1, h_0)^tV_2K_2^{-1}\dots K_1V_3v(L_1, h_0)^tL_1u(L_1, h_0)^tV_4v(P_1, h_0)^tP_1. \end{aligned}$$

Since we assumed that  $s > |q| + |p|$ ,  $|V_3| < |q|$  and  $V_3v(L_1, h_0)^t \leq |p|$ , we must have  $v(L_1, h_0) = 1$  in the free group. Hence by (8.1)  $u(L_1, h_0) = 1$  in the free group. Since  $|V_4| < |q|$  and  $|V_4v(P_1, h_0)^s| < |p|$ , we have that  $v(P_1, h_0) = 1$  in the free group. Then  $u(P_1, h_0)$  is freely equal to 1. Similarly, considering the words  $V_2$  and  $v(R_1, h_0)^sV_2$ , we conclude that  $v(R_1, h_0) = 1$  in the free group. Hence  $u(R_1, h_0)$  is freely trivial. But

then  $|u(P_1, h_0)^s V_1 v(R_1, h_0)^s| = |V_1| < |q|$ , and we have a (linear) bound of the size of the  $P_1 R_1$ -sector of the word  $W \circ h$  as desired.

**Case 2.** Suppose now that there are neither  $P_j$ - nor  $R_j$ -letters in the base of  $\Delta$ .

Then the trapezium  $\Delta$  has no  $\mathcal{G}$ -cells by Lemma 6.5. Again, it suffices to give a recursive upper bound for the length of the loops  $q(l)$ , because this would give a recursive estimate for the number of their labels. As in Case 1, we can bound the sizes of the paths  $p(l)$ . Since the history of  $\Delta$  is periodic and the lengths of the words  $\phi(p(l))$  (whose  $(k, a)$ -projections are the intermediate words, without the last letter, of the corresponding computation) are bounded, the words  $\phi(p(l))$  form a periodic sequence whose period  $n$  is recursively bounded in terms of  $|q| + |p|$ .

Thus it remains to obtain an upper bound for the lengths of the paths  $t(l)$ . Since the number of  $\theta$ -edges in  $t(l)$  is at most  $\min(|q|, |p|)$ , it suffices to obtain an upper estimate for the length of each of the  $x$ -subpaths  $t_{ij}$  of  $t(l)$  connecting neighbor  $\theta$ -bands of  $\Delta$ .

The  $\theta$ -bands in  $\Gamma$  subdivide this diagram into several (at most  $|q|$ ) subdiagrams  $\Gamma_i$  containing no  $\theta$ -cells. The path  $t_{ij}$  is a side of one of the  $k$ -bands in one of the subdiagrams  $\Gamma_i$ . Thus it is to show that  $k$ - and  $a$ -bands in  $\Gamma_i$  have bounded lengths. Notice that the boundary of the van Kampen diagram  $\Gamma_i$  has the form  $q^1 q^2 q^3 q^4$  where  $\phi(q^1)$  and  $\phi(q^3)$  are subwords in  $\mathcal{X}$  of the boundary labels of  $\Delta$  and  $\phi(q^2), \phi(q^4)$  are subwords of the top and the bottom labels of  $\theta$ -bands in  $\Gamma$ .

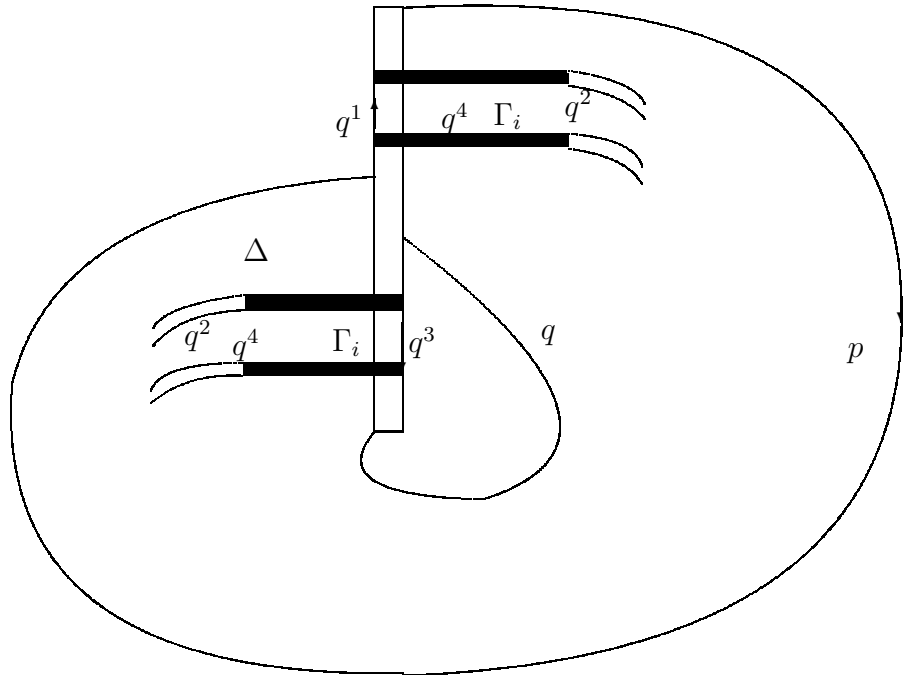

Fig. 23.

The words  $\phi(q^2), \phi(q^4)$  are periodic with the length of the period bounded in terms of  $n$ . Hence  $\Gamma_i$  can be cut by its  $k$ - or  $a$ -bands into subdiagrams  $\Psi_1, \Psi_2, \dots, \Psi_r$  with contours  $q_i^1 q_i^2 q_i^3 q_i^4$  where  $q_i^1, q_i^3$  are words in  $\mathcal{X}$ ,  $q_i^2$  (or  $q_i^4$ ) have the same labels of length  $n$  for all  $i$ , with the possible exception for  $q_r^2, q_r^4$  whose lengths are recursively bounded in terms of

$n$ . By Lemma 8.2, the subdiagram  $\Psi_r$  has bounded number of cells and can be ignored. Also Lemma 8.2 implies that it suffices to bound  $|q_i^1|$  for all  $i$  in terms of  $|q_1^1|, |q_{r-1}^1|$ .

Let  $w_i \equiv \phi(q_i^1)$ . By Lemma 8.2 for  $\Psi_i$ , we have that  $w_{i+1}$  is freely equal to  $uw'_i v$  where the fractional words  $u, v$  depend on  $\phi(q_i^2), \phi(q_i^A)$ , and therefore, do not depend on  $i$ , and so they belong to some finite effectively determined set of words;  $w'_i$  results from  $w_i$  after a substitution of the form  $x \mapsto (x')^{4^d}$  for a recursively bounded  $d$ .

If  $d = 0$ , then we have, by the obvious induction, that  $w_i$  is freely equal to a copy of  $u^{i-1}w_1v^{i-1}$ . Then, by Lemma 8.1,  $|w_i|$  is effectively bounded by  $|w_1| + |w_{z-1}|$ , as desired. Hence we may assume that  $d \geq 1$ . (We would interchange the top and the bottom of the spiral if  $d \leq -1$ .)

Since  $d \geq 1$ ,  $|w_{i+1}| \geq 4|w_i| - C$  where  $C = |u| + |v|$ . Then either  $|w_i| \leq C$  for every  $i$ , or, if  $|w_i| > C$  for some  $i$ , the series  $|w_i|, |w_{i+1}|, \dots$  monotonically increases, and so  $|w_i| \leq |w_{z-1}|$ .

In any case the lengths of the words  $w_i$  are recursively bounded in terms of  $|q| + |p|$  and the lemma is proved.  $\square$

**Lemma 8.7.** *Let a minimal diagram  $\Delta$  be a quasispiral having no  $k$ -cells. Then the length of a shortest  $a$ -band of  $\Delta$ , which connects  $p$  and  $q$  is bounded by a recursive function of  $|q| + |p|$ , where  $q, p$  are the inner and the outer contours of  $\Delta$ .*

*Proof.* One can define turns of the quasispiral as for spirals (in the beginning of the proof of Lemma 8.6 (but one should choose a maximal  $a$ -band instead of  $\mathcal{B}_k$ ). All the turns have equal boundary labels since every maximal  $a$ -band has one common cell with every turn. (Recall that there are no terminal cells for  $a$ -bands in  $\Delta$ , because the base of  $\Delta$  is empty.) Then one can apply Lemma 8.2 exactly as in Case 2 of the proof of Lemma 8.6 to complete the proof.  $\square$

## 9 Rolls

A reduced annular diagram  $\Delta$  over the group  $\mathcal{H}_1$  is said to be a *roll* if its inner contour  $q$  and its outer contour  $p$  are minimal boundaries and have no  $k$ -letters (see Figure 24).

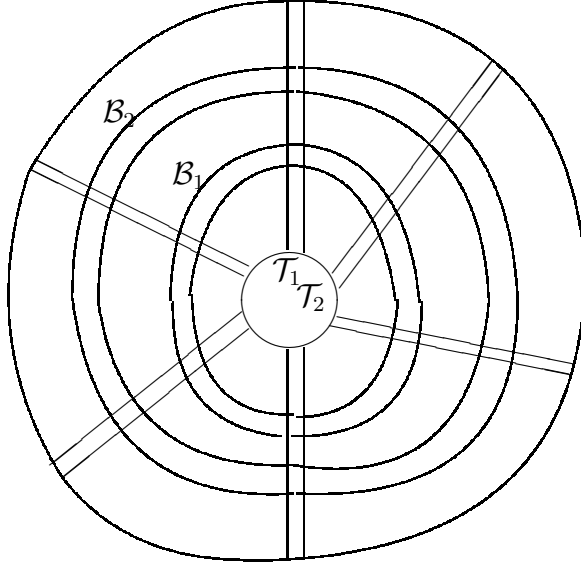

Figure 24.

It follows that every maximal  $\theta$ -band of a roll  $\Delta$  connects its inner boundary  $q$  and outer boundary  $p$ . The cyclic *history* of a roll is the projection of  $\phi(p)$  on  $\mathcal{S} \cup \bar{\mathcal{S}}$  (it is equal to the projection of  $\phi(q)$  on  $\mathcal{S} \cup \bar{\mathcal{S}}$ ). Clearly (by Lemma 3.11) maximal  $k$ -bands of a roll  $\Delta$  form concentric annuli surrounding the hole of the diagram. It follows from the definition that arbitrary annular subdiagram of a roll bounded by some sides of  $k$ - or  $a$ -annuli is a roll if it contains a  $(\theta, k)$ -cell. In any case it is a roll if it is bounded by sides of two  $a$ -annuli, since there are no  $a$ -edges on these sides.

We count the  $k$ -annuli of  $\Delta$  from  $q$  to  $p$ :  $\mathcal{B}_1, \dots, \mathcal{B}_r$ . The bases of  $\mathcal{B}_1, \dots, \mathcal{B}_r$  form the *base* of the roll  $\Delta$ .

Our goal is to replace every roll by a roll with the same boundary labels and recursively bounded number of cells (in terms of  $|p| + |q|$ ).

## 9.1 Rolls without a base

Let  $z \in \tilde{\mathcal{K}}$ . We say that an  $x$ -edge ( $a$ -edge,  $\theta$ -edge)  $e$  is of *type*  $z$  if the label of  $e^{\pm 1}$  belongs to the set  $\mathcal{X}(z)$  (to  $\mathcal{A}(z) \cup \bar{\mathcal{A}}(z)$ , to  $\Theta(z) \cup \bar{\Theta}(z)$ ).

**Lemma 9.1.** *Let  $\Delta$  be a roll with empty base. Suppose that either*  
(1) *the contours  $p$  and  $q$  are simple loops without common vertices or*  
(2) *all edges in  $p \cup q$  are of the same type  $z$  for some  $z \in \tilde{\mathcal{K}}$ .*  
*Then the labels of all edges in  $\Delta$  are of the same type.*

*Proof.* It is clear from the list of relations of  $\mathcal{H}_1$ , that all edges of a non- $k$ -cell have the same type. We say that two cells of  $\Delta$  are neighbor if they have a common edge. It follows that the transitive closure of this relation is an equivalence, and all edges of the cells of an equivalence class  $\Gamma$  are of the same type.

Let  $\Gamma_1, \dots, \Gamma_s$  be all the classes of  $\Delta$ . If  $s > 1$ , then the deletion of finitely many vertices from  $\cup_{i=1}^s \Gamma_i$  makes  $\Delta$  disconnected, a contradiction in case (1). Hence  $s = 1$  in

this case, and the statement is true because every edge of  $p \cup q$  must belong to a cell of  $\Gamma_1$ . In case (2) the statement follows from the observation that any boundary edge of each of the components  $\Gamma_1, \dots, \Gamma_s$  must lie on  $p \cup q$ . □

**Lemma 9.2.** *There is a recursive function  $f$  with the following property.*

*Let  $\Delta$  be a roll with an empty base. Then there exists a roll  $\Delta'$  with the same boundary labels as  $\Delta$ , which has a path of length at most  $f(|p| + |q|)$ , connecting the components  $p$  and  $q$  of the boundary of  $\Delta'$ .*

*Proof.* We can assume that  $\Delta$  contains  $\theta$ -edges since otherwise one can refer to Lemma 4.4. By Lemma 5.5, we can assume that  $\Delta$  satisfies properties (R1) - (R4).

**Case 1:** Assume that there is at least one  $\mathcal{A}(P_1) \cup \bar{\mathcal{A}}(P_1)$ -edge in  $\Delta$ . By lemmas 9.1 and 5.1, we can assume that all  $a$ -edges in  $\Delta$  belong to  $\mathcal{A}(P_1) \cup \bar{\mathcal{A}}(P_1)$ , all  $\theta$ -edges belong to  $\Theta(P_1) \cup \bar{\Theta}(P_1)$ . Since the set  $\mathcal{X}(P_1)$  does not exist,  $\Delta$  does not have  $x$ -edges.

Thus all cells in  $\Delta$  correspond to the commutativity relations of the form (2.7) and  $\mathcal{G}$ -relations. Therefore  $\Delta$  is a diagram over the direct product of the free group generated by  $\Theta$  and the free product of the copy of  $\mathcal{G}$  generated by  $\mathcal{A}(P_1)$  and the free group with basis  $\{a_{m+1}, \dots, a_{\bar{m}}\}$ . Since the conjugacy problem is decidable in both factors of this direct product, we can replace  $\Delta$  by a diagram with the same boundary label which has a path, connecting the inner and outer contours, of length bounded by a recursive function in  $|p| + |q|$ , as required.

**Case 2.** Suppose that  $\Delta$  has no  $\mathcal{A}(P_1)$ -edges.

Again by Lemma 9.1, for some  $z \in \tilde{\mathcal{K}}$ ,  $z \neq P_1$ , all edges from  $\Delta$  are of type  $z$ .

**Case 2.1.** First we consider the case where  $p$  and  $q$  have no  $a$ -edges. By Lemma 3.11,  $\Delta$  is a union of concentric  $a$ -annuli  $\mathcal{C}^1, \mathcal{C}^2, \dots$ . If we find a recursive upper bound for the lengths of the  $a$ -annuli, we recursively bound their number because if the sides of two such annuli have equal labels, we can remove the annuli and all the cells between them to obtain a smaller roll. Since all the  $a$ -annuli have equal numbers of  $\theta$ -cells (each of them intersects each of the  $\theta$ -bands only once), it suffices to bound the lengths of the subbands of  $\mathcal{C}^i$  between any two neighbor maximal  $\theta$ -bands  $\mathcal{T}$  and  $\mathcal{T}'$ . Let  $\Gamma$  be the subdiagram situated between  $\mathcal{T}$  and  $\mathcal{T}'$ . Clearly all cells in  $\Gamma$  correspond to the relations (2.8).

We can assume that  $z \neq P_j$  for any  $j$  since there are no auxiliary  $(\mathcal{A}(P_j), x)$ -relations (2.8). Hence  $z \in \{K_j, L_j, R_j\}$  for some  $j$ .

We consider only the first of these cases because all other cases are similar. Thus assume that  $z = K_j$  for some  $j$ .

The bands  $\mathcal{T}$  and  $\mathcal{T}'$  are reduced, and so  $\Gamma$  has boundary label of the form  $U_1 V_1 U_2 V_2$  where  $V_1$  and  $V_2$  are labels of sides of  $\mathcal{T}$  and  $\mathcal{T}'$ , and  $U_1$  and  $U_2$  are words in  $\mathcal{X}$ . Clearly the  $a$ -projections of  $V_1$  and  $V_2^{-1}$  are graphically the same since every  $a$ -band starting on  $\mathcal{T}$  ends on  $\mathcal{T}'$  and vice versa. Let  $V = (V_1)_a$ .

Lemma 6.11 can be applied to a minimal subdiagram  $\Gamma'$  of  $\Gamma$ , containing two neighbor  $a$ -bands. It implies that the word  $V$  is a product  $V'(V'')^{-1}$  for some positive words  $V', V''$ . Now Lemma 6.3 implies that all conditions of Lemma 4.5 hold for the union of  $\Gamma'$  and the corresponding portions of the  $\theta$ -bands  $\mathcal{T}, \mathcal{T}'$ . Lemma 4.5 gives the desired recursive bound for the lengths of  $a$ -bands in  $\Gamma$  in terms  $|U_1|, |U_2|$ .



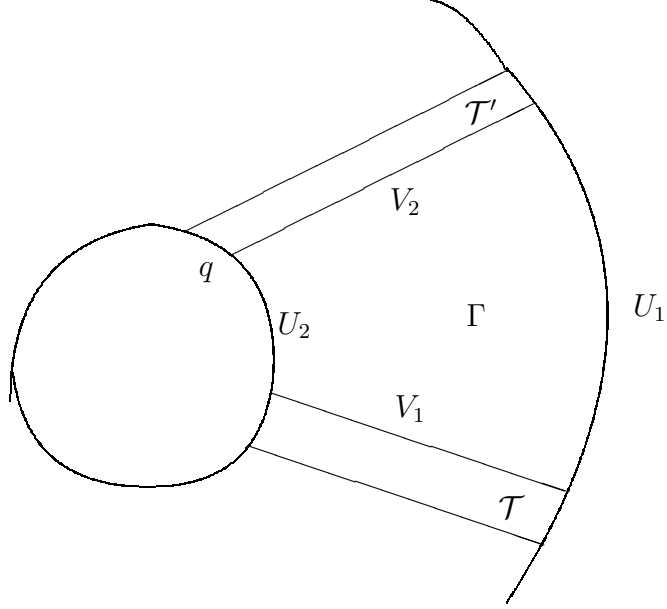

Fig. 25.

**Case 2.2** Now let us consider the case when  $\partial(\Delta)$  contains  $a$ -edges. In this case, there is an  $a$ -band  $\mathcal{C}$  starting on  $p$  and ending on  $q$  since  $\Delta$  satisfies (R2). So we can apply Lemma 8.4 and represent  $\Delta$  as a union of a quasispiral, and two subdiagrams with recursively bounded number of cells. Then the sub-quasispiral of  $\Delta$  will have a recursively bounded perimeter, and we can apply Lemma 8.7.  $\square$

**Lemma 9.3.** *Let  $\Delta$  be a roll with the empty base, satisfying (R3), which has no  $\mathcal{G}$ -cells. Let  $p$  and  $q$  be the outer and inner components of  $\partial(\Delta)$  and  $\phi(p)_a$  freely equal to the empty word. Then either there is an  $a$ -annulus between  $p$  and  $q$  surrounding the hole of  $\Delta$ , or the lengths of the  $\theta$ -bands of  $\Delta$  are recursively bounded in terms of the number of  $a$ -letters in  $\phi(p)$  and  $\phi(q)$ .*

*Proof.* By Lemma 5.5, we can assume that no  $a$ -bands in  $\Delta$  start and end on  $p$  (resp.  $q$ ). Therefore we can assume that all  $a$ -bands in  $\Delta$  connect  $p$  and  $q$  (otherwise it would contain an  $a$ -annulus).

Since the  $a$ -projection of  $\phi(p)$  is freely trivial, there is a subpath  $p'$  of  $p$  which starts with an edge  $e$ , ends with  $e'$  and  $\phi(e) = \phi(e')^{-1} \in \mathcal{A} \cup \bar{\mathcal{A}}$ , and there are no  $a$ -edges in  $p'$  between  $e$  and  $e'$ . Consider the  $a$ -bands  $\mathcal{C}$  and  $\mathcal{C}'$  starting on  $e$  and  $e'$  respectively. Suppose that both bands intersect the same  $\theta$ -band  $\mathcal{T}$ . Then the intersection cells  $\mathcal{C} \cap \mathcal{T}$  and  $\mathcal{C}' \cap \mathcal{T}$  must have a common  $\theta$ -edge, and their  $a$ -edges must have mutually inverse labels. Thus these cells cancel, a contradiction. Hence, say,  $\mathcal{C}$  does not intersect all maximal  $\theta$ -bands in  $\Delta$ . This and the Jordan lemma implies that none of the  $a$ -bands in  $\Delta$  intersects any of the maximal  $\theta$ -bands there more than ones. Therefore by Lemma 3.11 each  $a$ -band intersects each  $\theta$ -band in  $\Delta$  at most once. Hence the length of each  $\theta$ -band in  $\Delta$  does not exceed the number of  $a$ -edges on  $p$ .  $\square$

## 9.2 Rolls with $L$ -annuli

**Lemma 9.4.** *Let a reduced annular diagram  $\Delta$  be an  $L_j$ -annulus with an outer boundary  $p$  and inner boundary  $q$ , whose cyclic history is a word of the form  $\tau\tau^{-1}\tau\tau^{-1}\dots$  for some  $\tau \in \mathcal{S}^+(2) \cup \mathcal{S}^+(4)$ . Assume that all  $x$ -edges of  $p$  are labelled by the same letter  $x = x(a, \tau)$ ,  $a \in \mathcal{A}(L_j)$ . Then there exists an annular diagram  $\Delta'$  which contains no  $k$ -cells with the outer path  $p'$  and inner path  $q'$ , where  $\phi(p') \equiv \phi(p)$  and  $\phi(q')$  can be obtained from  $\phi(q)$  by replacing every  $a$ -,  $x$ -, and  $\theta$ -letter by its brother in  $\mathcal{A}(L_j) \cup \mathcal{X}(L_j) \cup \Theta(L_j)$ . Similarly there also exists an annular diagram  $\Delta''$  with outer contour  $p''$  and inner contour  $q''$ , without  $k$ -cells where all  $a$ -,  $x$ -, and  $\theta$ -labels of the boundary belong to  $\mathcal{A}(\overleftarrow{L}_j) \cup \mathcal{X}(\overleftarrow{L}_j) \cup \Theta(\overleftarrow{L}_j)$ ,  $\phi(q'') \equiv \phi(q)$ ,  $\phi(p'')$  is a copy of  $\phi(p)$ .*

*Proof.* Assume that  $\tau \in \mathcal{S}^+(2)$  (the other case is similar). Consider an  $(L_j, \theta)$ -cell  $\Pi$  of  $\Delta$  with boundary label of the form

$$\theta_1^{-1}L_j\theta_2x^{-1}aL_j^{-1}(a')^{-1}x'$$

(see relations (2.6)) where  $a \in \mathcal{A}(L_j)$ ,  $a' \in \mathcal{A}(\overleftarrow{L}_j)$ ,  $x \in \mathcal{X}(L_j)$ ,  $x' \in \mathcal{X}(\overleftarrow{L}_j)$ . We substitute the occurrence  $L_j$  by  $x'a'$ , the occurrence  $L_j^{-1}$  by  $(a')^{-1}x'$ , the letter  $\theta_2$  by its copy  $\theta_1$ , the letter  $a$  by  $a'$  and  $x$  by  $x'$ . Then we obtain a relation of the form (2.7). We can substitute the  $k$ -cell  $\Pi$  by the new cell  $\Pi'$  without  $k$ -edges.

Then, for every  $(L_j, x)$ -cell  $\pi$  (see relations (2.9)), situated between  $(L_j, \theta)$ -cells  $\Pi_1$  and  $\Pi_2$ , we change the letters  $L_j$  in its label by  $x'a'$  if the subtrapezium, which includes  $\Pi_1$  and  $\Pi_2$ , has history  $\tau^{-1}\tau$ , or by  $(x')^{-1}a'$  if the history is  $\tau\tau^{-1}$ . The letter  $x$  in the boundary label of  $\pi$  will be replaced by  $x'$ . We obtain the boundary label of the form  $(x')^4(x')^{\pm 1}a'(x')^{-1}(a')^{-1}x'^{\mp 1}$  which is equal to 1 modulo relations (2.8).

Since the cells of  $\Delta$  were glued in the  $L_j$ -band along  $L_j$ -edges, the substitutions we have just described provide us with the desired diagram  $\Delta'$ .  $\square$

**Lemma 9.5.** *Let a roll  $\Delta$  with base  $L_jL_j^{-1}$  or  $L_j^{-1}L_j$  be bounded by two  $L_j$ -annuli  $\mathcal{B}_1$  and  $\mathcal{B}_2$ . Assume that the non-empty history of the roll is  $\tau\tau^{-1}\tau\tau^{-1}\dots$  for some  $\tau \in \mathcal{S}^+(2) \cup \mathcal{S}^+(4)$ . Suppose that all  $x$ -edges of the inner boundary of  $\mathcal{B}_1$  have the same labels and all  $x$ -edges of the outer boundary of  $\mathcal{B}_2$  have the same labels  $x(a, \tau)$  (for some  $a$ ). Then there exists a roll  $\Delta'$  which has no  $k$ -cells and the same boundary labels as  $\Delta$ .*

*Proof.* By Lemma 3.11, every  $\theta$ -band of  $\Delta$  crosses each of  $\mathcal{B}_1$ ,  $\mathcal{B}_2$  only once. Therefore one can apply Lemma 6.5 (part 2) to conclude that  $\Delta$  contains no  $\mathcal{G}$ -cells. Besides, by Lemma 9.1 (assumption 2 of Lemma 9.1 holds), the subroll with trivial base bounded by  $\mathcal{B}_1$  and  $\mathcal{B}_2$ , consists of  $\mathcal{A}(L_j)$ -cells or it consists of  $\mathcal{A}(\overleftarrow{L}_j)$ -cells. Notice that for every  $\mathcal{A}(L_j)$ -cell, can be constructed its  $\mathcal{A}(\overleftarrow{L}_j)$ -copy, and vice versa (see relations (2.7), (2.8) and the definition of the mapping  $\alpha_\tau$ ). Then one can change all these cells by their  $\mathcal{A}(\overleftarrow{L}_j)$ -copies or, respectively, by their  $\mathcal{A}(L_j)$ -copies and simultaneously transform the bands  $\mathcal{B}_1$  and  $\mathcal{B}_2$  according to Lemma 9.4. Reducing the resulting diagram, we obtain the desired roll  $\Delta'$ .  $\square$

**Lemma 9.6.** *Let  $\Delta$  be a roll with a non-empty history  $h$  which is a word in  $\mathcal{S}(2) \cup \mathcal{S}(4)$ . Assume that the base of  $\Delta$  is  $L_j^{-1}L_j$  for some  $j$ , and  $\Delta$  is bounded by two  $L_j$ -annuli  $\mathcal{B}_1$  and*

$\mathcal{B}_2$ . Then  $h$  is a word of the form  $\tau\tau^{-1}\tau\dots$  for some  $\tau \in \mathcal{S}$ , all  $x$ -edges in the boundaries  $p$  or  $q$  are labelled by the same letter  $x = x(a, \tau)^{\pm 1}$ , and all  $x$ -edges not in  $p \cup q$  are also labelled by the same letter  $x' = x(a', \tau)^{\pm 1}$ .

*Proof.* Assume that the history  $h$ , as a cyclic word, has two neighbor letters  $\tau, \tau'$  which are not mutually inverse. Consider the small subtrapezium  $\Gamma$  of  $\Delta$  with history  $\tau\tau'$  and a two-letter base. Since the history of  $\Gamma$  is reduced, by Lemma 6.12, the projection of the label of the bottom of the trapezium  $\Gamma$  on  $\mathcal{A} \cup \mathcal{K}$  is an admissible word for  $\mathcal{S}$ . But this contradicts Lemma 2.2 (an admissible word for  $\mathcal{S}$  cannot have base  $L_j^{-1}L_j$ ). Hence  $h$  does not have a reduced subword of length 2, whence it has the form  $\tau\tau^{-1}\tau\dots$  for some  $\tau$ .

Let  $\Delta'$  be the roll with empty base obtained by removing  $\mathcal{B}_1, \mathcal{B}_2$ . Since the history of the roll has the form  $\tau\tau^{-1}\dots$ , there exists  $i$  such that all  $a$ -edges on the boundary of the roll have labels  $a_i(z)^{\pm 1}$  for some  $i$  where  $z = \overleftarrow{L}_j$ . By Lemma 9.1(2), all edges of  $\Delta'$  are of type  $\overleftarrow{L}_j$ .

Let  $\Gamma$  be a small subtrapezium of  $\Delta$  bounded by two maximal  $\Theta$ -bands  $\mathcal{T}_1, \mathcal{T}_2$  of  $\Delta$  starting on  $q$  and ending on  $p$ . Denote  $\pi_1 = \mathcal{T}_1 \cap \mathcal{B}_1$  and  $\pi_2 = \mathcal{T}_2 \cup \mathcal{B}_1$ .

We assume that  $\mathcal{T}_2$  follows  $\mathcal{T}_1$  in the clockwise order. Let  $V \equiv \phi(\mathbf{bot}(\mathcal{T}_1)), V' \equiv \phi(\mathbf{top}(\mathcal{T}_2))$ . Since every maximal  $a$ -band of  $\Gamma$  starting on  $\mathbf{top}(\mathcal{T}_1)$  ends on  $\mathbf{bot}(\mathcal{T}_2)$ , the  $a$ -projections  $V_a$  and  $V'_a$  are identical and each of these words contains a letter  $b^{\pm 1} = \in \mathcal{A}(\overleftarrow{L}_j)^{\pm 1}$ .

Suppose that the first  $a$ -letter of the word  $V_a$  is negative and the last one is positive. Then  $V_a$  has a subword of the form  $a_1^{-1}a_2$  which is ruled out by Lemma 6.11.

Therefore either the first letter of  $V_a$  is positive or the last letter is negative. These two cases are similar (one can be obtained from the other one by interchanging of  $p$  and  $q$ ).

Thus we may assume that the first letter of  $V_a$  is positive. Hence by Lemma 6.11,  $V = V_1V_2$  where  $(V_1)_a$  is a non-empty positive word and  $(V_2)_a$  is a negative word.

Again, we consider the first  $a_s(\overleftarrow{L}_j)$ -band  $\mathcal{C}$  in  $\Gamma$ , counting from  $q$ , connecting  $\mathbf{bot}(\mathcal{T}_1)$  and  $\mathbf{top}(\mathcal{T}_2)$ . Let  $\Psi$  be the diagram containing  $\mathcal{C}$  and bounded by a part of  $\mathbf{bot}(\mathcal{T}_1)$ ,  $\mathbf{bot}(\mathcal{C})$ , a part of  $\mathbf{top}(\mathcal{T}_2)$  and a part of the outer contour of  $\mathcal{B}_1$ .

The boundary label of  $\Psi$  is of the form  $W \equiv U_1a_s(\overleftarrow{L}_j)^{-1}x^{\pm 1}U_2x^{\mp 1}a_s(\overleftarrow{L}_j)$ , where  $U_1$  and  $U_2$  are some words in  $\mathcal{X}$ ,  $U_1$  is the top label of the  $a_s(\overleftarrow{L}_j)$ -band  $\mathcal{C}$  and  $U_2$  is read on the outer contour of  $\mathcal{B}_1$  between two  $L_j$ -cells. Hence the word  $U_2$  is freely equal to a product of fourth powers of  $x$ -letters labelling  $x$ -edges of the outer side of  $\mathcal{B}_1$  (by relations (2.9)). This word cannot be empty, because otherwise the two  $L_j$ -cells  $\pi_1, \pi_2$  would form a reducible pair. The letter  $x$  labels either an  $x$ -edge of the  $L_j$ -cell  $\pi_1$  (where  $\mathcal{T}_1$  starts) or an  $x$ -edge of an auxiliary  $\theta$ -cell  $\pi$  of  $\mathcal{T}_1$  (that could happen either if the cell  $\pi_1$  has no  $a$ -edges on its top side, or if the first auxiliary cell in  $\mathcal{T}_1$  shares its  $x$ -edge with  $\pi_1$ ). We shall refer to these possibilities as **Cases 1** and **2**.

Notice that the letter  $x$  labels an  $x$ -edge of a  $\theta$ -cell. Therefore it corresponds to the  $a$ -letter appearing as a label of an  $a$ -edge of this cell and the  $S$ -rule  $\tau$ . We shall prove that all  $x$ -edges in  $\Delta'$  are labelled by  $x^{\pm 1}$ , and that all  $a$ -edges on the sides of the  $\theta$ -bands of  $\Delta'$  are labelled by  $a_s(\overleftarrow{L}_j)^{\pm 1}$ . Then we shall prove that  $s = i$ . This would imply that all  $x$ -edges on the boundary of  $\Delta$  have the same label.

The word  $x^{\pm 1}U_2x^{\mp 1}$  is freely inverse of the bottom label  $U'_1$  of  $\mathcal{C}$ . Therefore, by Lemma 6.10(2),  $U_2 = x^{4d}$  for some  $d \neq 0$ . In particular, the letter  $a_s(\overleftarrow{L}_j)$  is determined by the  $x$ -letter  $x'$  such that  $x$  is a copy of  $x'$  and  $(x')^d$  is read on  $p$  between  $\pi_1$  and  $\pi_2$ . Thus,  $U_1 = x^{-d}$ .

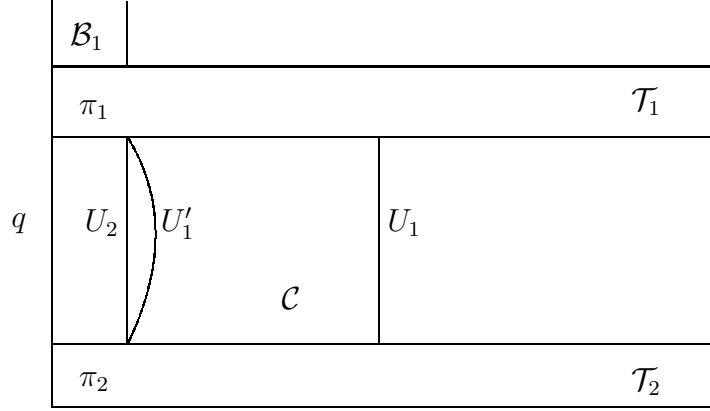

Fig. 26.

If  $|(V_1)_a| \geq 2$ , one can almost repeat the argument (but applying now part (3) of Lemma 6.10 instead of part (2)) and conclude that the next to the first  $a$ -letter  $a_{s'}(\overleftarrow{L}_j)$  of  $(V'')_a$  is determined by  $x$ , and so  $s' = s$ . Hence  $(V_1)_a$  is a power of  $a_s(\overleftarrow{L}_j)$  and all  $x$ -edges of the  $a$ -bands starting on the portion of  $\mathbf{bot}(\mathcal{T}_1)$  labelled by  $V_1$  have the same label  $x$ . Similarly, if  $(V_2)_a$  is non-empty, it must be a power of some  $a_{s'}(\overleftarrow{L}_j)$ , and all  $x$ -edges on  $a$ -bands starting on the part of  $\mathbf{bot}(\mathcal{T}_1)$  labelled by  $V_2$  have the same label  $x''$ . The neighbor  $a_s(\overleftarrow{L}_j)$ - and  $a_{s'}(\overleftarrow{L}_j)$ -bands, connecting  $\mathbf{bot}(\mathcal{T}_1)$  and  $\mathbf{top}(\mathcal{T}_2)$ , have a common boundary sections labelled by non-empty  $x^{t_1} \equiv (x'')^{t_2}$ , because otherwise a cell of  $\mathcal{T}_1$  and a cell of  $\mathcal{T}_2$  would form a reducible pair. We conclude that  $x \equiv x''$  and hence  $s = s'$ . Therefore  $V_2$  is empty. Similarly  $\phi(\mathbf{top}(\mathcal{T}_2))_a$  is a power of  $a_s(\overleftarrow{L}_j)$ .

Considering the next (in the clockwise order) small subtrapezium  $\Gamma'$  of  $\Delta'$ , the small subtrapezium after that, and so on, we conclude that all  $a$ -edges on the (reduced) top and bottom sides of all  $\theta$ -bands in  $\Delta'$  have the same label  $a_s(\overleftarrow{L}_j)$  and all  $x$ -edges in all small subtrapezia of  $\Delta'$  are labelled by  $x$ .

It remains to show that  $s = i$ . Indeed, if Case 1 holds, that is if  $\pi_1$  does not share its  $x$ -edge with the first auxiliary cell  $\pi$  of  $\mathcal{T}_1$ , then the first  $a$ -edge of  $\mathbf{bot}(\mathcal{T}_1)$  is an edge of  $\pi_1$ , and so  $s = i$ . Suppose that Case 2 holds. Then the  $a$ -edges of  $\pi$  are labelled by  $a_i(\overleftarrow{L}_j)^{\pm 1}$ .

The bottom side of  $\pi_1$  (considered as a  $\theta$ -band) consists of one  $L_j$ -edge (see relations (2.6)), so the bottom side of  $\pi$  does not have common edges with the bottom side of  $\pi_1$ . Therefore the  $a$ -edge of the bottom side of  $\pi$  appears on the (reduced) bottom path of  $\mathcal{T}_1$ . Therefore, again,  $s = i$ . This completes the proof of the lemma.  $\square$

**Lemma 9.7.** *Let  $\Delta$  be a roll with non-empty base whose history is a word over  $\mathcal{S}(2) \cup \mathcal{S}(4) \cup \bar{\mathcal{S}}$ . Then either all rules in the history belong to  $\bar{\mathcal{S}}$  or all of these rules are from  $\mathcal{S}(2) \cup \mathcal{S}(4)$ .*

*Proof.* Indeed, consider a  $k$ -annulus  $\mathcal{B}$  of  $\Delta$ . If the history of  $\Delta$  contains rules both from  $\bar{\mathcal{S}}$  and from  $\mathcal{S}(2) \cup \mathcal{S}(4)$  then there exist two neighbor cells in  $\mathcal{B}$ , one corresponding to a rule in  $\bar{\mathcal{S}}$  and the other corresponding to a rule from  $\mathcal{S}(2) \cup \mathcal{S}(4)$ . But this is impossible since rules from  $\mathcal{S}(2) \cup \mathcal{S}(4)$  do not change the  $\Omega$ -coordinate of the base letters, and letters in  $\mathcal{K} \cap \bar{\mathcal{K}}$  have  $\Omega$ -coordinates 1.  $\square$

**Lemma 9.8.** *Let  $\Delta$  be a roll with base  $L_j^{-1}L_j$  for some  $j$ . Assume that the non-empty history  $h$  of  $\Delta$  is a word in  $\mathcal{S}(2) \cup \mathcal{S}(4) \cup \bar{\mathcal{S}}$ . Then there exists a roll  $\Delta'$  with an empty base, having the same boundary labels as  $\Delta$ .*

*Proof.* One may assume that  $\Delta$  is bounded by two  $L_j$ -annuli  $\mathcal{B}_1$  and  $\mathcal{B}_2$ . By Lemma 9.7, there are two possibilities: either all rules in the history of  $\Delta$  are from  $\bar{\mathcal{S}}$  or all of them are from  $\mathcal{S}(2) \cup \mathcal{S}(4)$ .

In the first case the inner side of  $\mathcal{B}_1$  has the same label as the outer side of  $\mathcal{B}_2$  since there exists no  $(\bar{a}, x)$ -cells. Hence the role  $\Delta$  can be replaced by an empty roll.

In the second case, one can apply Lemma 9.6 and then Lemma 9.5.  $\square$

**Lemma 9.9.** *Let  $\Delta$  be a roll. Assume that the history  $h$  of  $\Delta$  is non-empty and the base of  $\Delta$  is either (a) equal to  $L_j^{-1}L_j$  or (b) equal to  $L_jL_j^{-1}$  or (c) equal to  $L_j$  or for some  $j$ . Then there exists a roll  $\Delta'$  with the same boundary labels as  $\Delta$ , whose base is obtained from the base of  $\Delta$  by removing some (or none) letters, and the number and perimeters of cells are recursively bounded in terms of lengths of the boundary components  $|p|, |q|$  (as usual,  $p$  is the outer and  $q$  is the inner boundary components).*

*Proof.* 1. By Lemma 5.5 we can assume that the roll  $\Delta$  satisfies the conditions (R1) and (R2) of that lemma. We assume that  $\Delta$  has the lowest possible number of  $L_j$ -annuli and the lowest type among all rolls satisfying the conditions of the lemma, plus conditions (R1), (R2), and having the same boundary labels as  $\Delta$ .

If we remove the  $L_j$ -bands from  $\Delta$ , we get two or three rolls with empty bases. Two of these rolls, say,  $\Delta_1$  and  $\Delta_2$  are bounded by an  $L_j$ -annulus and  $q$  and an  $L_j$ -annulus and  $p$ , respectively, and the third roll  $\Delta_3$  (if exists) is bounded by two  $L_j$ -annuli.

Notice that it is enough to be able to replace  $\Delta$  by a roll with the same boundary labels and recursively bounded lengths of  $L_j$ -bands. Indeed in that case we would be able to apply Lemma 9.2 to the subrolls  $\Delta_1, \Delta_2, \Delta_3$ .

2. Fix a big enough recursive function  $f(x)$ . From what follows it will be clear how big  $f(x)$  should be:  $f(x)$  has to satisfy certain (finite) number of inequalities of the form  $f(x) > g(x)$  where  $g(x)$  is a recursive function.

3. Suppose that one can connect the boundary components of  $\Delta_i$ ,  $i = 1, 2$ , by a path of length  $\leq f(|p| + |q|)$ . Then by Lemma 5.3, the number of cells in  $\Delta_i$  is recursively bounded in terms of  $|p|, |q|$ . Thus we can remove one of the subrolls  $\Delta_1$  or  $\Delta_2$  and one of the  $L_j$ -annuli from  $\Delta$  and reduce the problem to the same problem about a roll with fewer  $L_j$ -annuli.

Thus we can assume that there are no paths of length  $\leq f(|p| + |q|)$  connecting the boundary components of  $\Delta_i$ ,  $i = 1, 2$  (if  $\Delta_i$  does exist). By Lemma 5.1, we may also assume that  $p$  and  $q$  are simple loops. By Lemma 9.1, we conclude that for some

$z \in \{L_j, \overleftarrow{L_j}\}$ , all edges of the diagram  $\Delta_i$  are of the same type  $z$ . In particular,  $\Delta$  does not contain  $\mathcal{G}$ -cells.

4. As a consequence of 3, we can deduce that the lengths of maximal  $\theta$ -bands in  $\Delta_1$  and  $\Delta_2$  are bigger than 1 (since  $f(x) > 1$ ). Hence for every  $\tau$  in the history of  $\Delta$  there exist relations of the form (2.7) containing a letter from  $\Theta(\overleftarrow{L_j}) \cup \bar{\Theta}(\overleftarrow{L_j})$ . This implies that  $\tau$  does not lock  $(zL_j)$ -sectors and  $(L_jz)$ -sectors. So every rule  $\tau$  in the history of  $\Delta$  belongs to  $\mathcal{S}(2) \cup \mathcal{S}(4) \cup \bar{\mathcal{S}}(2) \cup \bar{\mathcal{S}}(4)$ . Hence if one of the rules in that history belongs to  $\bar{\mathcal{S}}$ , all of them belong to  $\bar{\mathcal{S}}$ , which implies that  $\Delta_i$  ( $i = 1, 2$ ) does not contain  $x$ -edges at all (there are no letters in  $\mathcal{X}$  that correspond to  $\bar{\mathcal{A}}$ -letters). This, in turn, would imply that the lengths of the  $L_j$ -annuli in  $\Delta$  equal the number of maximal  $\theta$ -bands starting on  $p$  and ending on  $q$ , hence the lengths of  $L_j$ -annuli in  $\Delta$  are bounded in terms of  $|p|, |q|$ , as desired. Hence we can assume that all rules  $\tau$  in the history of  $\Delta$  belong to  $\mathcal{S}(2)$  or  $\mathcal{S}(4)$ .

5. Now if the base of  $\Delta$  is  $L_j^{-1}L_j$  (as in case (a) of the lemma), we can apply Lemma 9.8 (to obtain a roll with the same boundary labels as  $\Delta$  but with empty base) and then use Lemma 9.2.

6. Thus suppose that the base of  $\Delta$  is  $L_j$  or  $L_jL_j^{-1}$ . Then  $z_1 = K_s^{\pm 1}$  for some  $s$ .

Consider two arbitrary consecutive (in the clockwise order) maximal  $\theta$ -bands  $\mathcal{T}_1$  and  $\mathcal{T}_2$  in  $\Delta_1 \cup \mathcal{B}_1$  starting on the inner contour  $q$ . Let  $\Gamma$  be the subdiagram of  $\Delta_1 \cup \mathcal{B}_1$  bounded by  $\mathbf{bot}(\mathcal{T}_1)$  and  $\mathbf{top}(\mathcal{T}_2)$ . Fewer than  $|q|$  of the maximal  $a$ -bands in  $\Gamma$  that start on  $\mathbf{top}(\mathcal{T}_1)$  end on  $q$ . The total number of cells in these bands is recursively bounded (we can remove these bands one by one starting with the band which shares one of its sides with  $q$ ). Thus we can remove these cells from  $\Delta$ . Similar operation can be performed on all other subdiagrams of  $\Delta_1$  situated between two consecutive  $\theta$ -bands, since the number of such diagrams is at most  $|q|$ . Thus we can assume that every maximal  $a$ -band in  $\Gamma$  starting on  $\mathbf{bot}(\mathcal{T}_1)$  ends on  $\mathbf{top}(\mathcal{T}_2)$ . Let  $\mathcal{C}$  be the first of these  $a$ -bands (counting from  $q$  to  $\mathcal{B}_1$ ). Then the bottom side of  $\mathcal{C}$  is a part of  $q$ .

Note that the rules of  $\mathcal{S}(2) \cup \mathcal{S}(4)$  have the form  $[\dots, K_s \rightarrow K_s, \dots]$ . Therefore the corresponding relations 2.6 are of the form

$$\theta(\tau, (K_s)_-)^{-1}K_s(r, \omega)\theta(\tau, K_s) = K_s(r, \omega)$$

where  $\omega \in \{2, 4\}$ ,  $r \in \bar{\mathcal{E}}$ . Using cells corresponding to these relations and relations of the form (2.9), we can build a  $K_s$ -band  $\mathcal{B}$  whose top side has the same label as the bottom side of  $\mathcal{C}$ . Then we can attach  $\mathcal{B}$  to the bottom side of  $\mathcal{C}$  and obtain a small trapezium  $\tilde{\Gamma} = \Gamma \cup \mathcal{B}$ .

7. Suppose that the history of  $\tilde{\Gamma}$  (= the history of  $\Gamma$ ) is reduced. Then by Lemma 6.12, the labels of the top and bottom paths of  $\tilde{\Gamma}$  are admissible words. In particular it means that the  $a$ -projection of the word  $V$  (resp.  $V'$ ) written on the bottom (resp. top) path of the trapezium  $\tilde{\Gamma}$  is positive. But then Lemma 4.5 (iii) implies that the length of  $\mathcal{T}_1$  does not exceed  $2|\mathcal{C}| + 2$ . This contradicts our assumption that it is greater than  $f(|p| + |q|)$ .

Hence the history of  $\Gamma$  is not reduced. Since  $\Gamma$  was chosen arbitrarily, we deduce that the history of  $\Delta$  has the form  $\tau\tau^{-1}\dots$  for some  $\tau \in \mathcal{S}(2) \cup \mathcal{S}(4)$ .

8. Let  $V = \phi(\mathbf{bot}(\mathcal{T}_1))$ . By Lemma 6.11, the word the  $a$ -projection  $V_a$  is equal to  $V'V''$  where  $V'$  is positive, and  $V''$  is negative. Accordingly, we can subdivide  $\mathcal{T}_i$  ( $i = 1, 2$ )

into two subbands  $\mathcal{T}'_i$  and  $\mathcal{T}''_i$  such that

$$\phi(\mathbf{top}(\mathcal{T}'_1))_a = \phi(\mathbf{bot}(\mathcal{T}'_2))_a = V', \phi(\mathbf{top}(\mathcal{T}''_1))_a = \phi(\mathbf{bot}(\mathcal{T}''_2))_a = V'',$$

and we can subdivide  $\Gamma$  into two subdiagrams  $\Gamma'$  and  $\Gamma''$  where  $\Gamma'$  is formed by the maximal  $a$ -bands of  $\Gamma$  starting on  $\mathbf{top}(\mathcal{T}'_1)$ . Notice that by Lemma 4.5, the length of each of the  $a$ -bands in  $\Gamma'$  is recursively bounded in terms of  $|q|$ , and the number of these  $a$ -bands is recursively bounded as well. Hence the number of cells in  $\Gamma'$  is recursively bounded, and we can assume that  $\Gamma = \Gamma''$  (and that the same is true for all other subdiagrams of  $\Delta_1$  situated between two consecutive  $\theta$ -bands).

9. As in the proof of Lemma 9.6, we can deduce that the  $x$ -edges in  $\Delta_1$  have the same labels and the word  $V'$  is a power of some letter  $a = a_i(\overline{L}_j)$ . Notice that the letter  $a$  does not depend on the choice of  $\Gamma$ . Thus for every maximal  $\theta$ -band  $\mathcal{T}$  of  $\Delta_1$ ,  $\phi(\mathbf{bot}(\mathcal{T}))_a = a^k$  or some negative  $k$ ,  $|k| > f(|p| + |q|)$  depending on  $\mathcal{T}$ . By Lemma 9.3, there exists an  $a$ -annulus  $\mathcal{C}$  in  $\Delta_1$  such that the number of cells between  $\mathcal{C}$  and  $q$  is recursively bounded. Without loss of generality, we can assume that  $q$  is the inner contour of  $\mathcal{C}$ . Since  $k \gg 1$ , there exist one more  $a$ -annulus  $\mathcal{C}_1$  such that the inner contour of  $\mathcal{C}_1$  is the outer contour of  $\mathcal{C}$ .

10. Now suppose that the condition (b) of the lemma holds, that is the base of  $\Delta$  is  $L_j L_j^{-1}$ . Then we can repeat the above argument for  $\Delta_2$  and conclude that all  $x$ -edges of each side of the second  $L_j$ -annulus in  $\Delta$  have the same labels. This allows us to apply Lemma 9.5, eliminate the  $L_j$ -annuli from  $\Delta$ , and then use Lemma 9.2.

11. Finally suppose that the base of  $\Delta$  is  $L_j$  as in case (c) of the lemma.

Notice that the label of the inner boundary of  $\mathcal{B}_1$  has the form

$$\theta(x^{-1}a)x^{4k_1}(x^{-1}a)^{-1}\theta^{-1}x^{4k_2}\theta(x^{-1}a)\dots x^{4k_l} = \theta x^{-1} a x^{4k_1} a^{-1} x \theta^{-1} x^{4k_2} \theta x^{-1} a \dots x^{4k_l}$$

for some integers  $k_1, \dots, k_l$  where  $a \in \mathcal{A}(z_1)$ ,  $x = x(a, \tau)$ . The label of the outer boundary of  $\mathcal{B}_1$  is freely equal to

$$\theta'(x')^{-1} a' (x')^{k_1} (a')^{-1} x' \theta'^{-1} (x')^{k_2} \theta' (x')^{-1} a' \dots (x')^{k_l}$$

where  $\theta'$  is the “brother” of  $\theta$ ,  $a'$  is a “brother” of  $a$ ,  $x' = x(a', \tau)$ . Notice that for every choice of parameters  $k_1, \dots, k_l$  there exists an  $L_j$ -annulus with boundary labels as above.

Modulo relations (2.8) any word of the form  $ax(a, \tau)^t a^{-1}$  is equivalent to  $x(a, \tau)^{4t}$ . Therefore for every integers  $s_1, \dots, s_l$  divisible by 16 there exists a roll with base  $L_j^{-1}$  and without  $a$ -annuli with outer boundary label

$$\theta x^{s_1} \theta^{-1} x^{s_2} \theta x^{s_3} \dots x^{s_l}$$

and inner boundary label

$$\theta'(x')^{s_1/4} \theta'(x')^{s_2/4} \theta' x^{s_3/4} \dots x^{s_l/4}.$$

Let us denote this roll by  $\Psi(s_1, \dots, s_l)$ . The “inverse” roll, that is the roll obtained from  $\Psi(s_1, \dots, s_l)$  by switching the inner and outer contours, will be denoted by  $\Psi^{-1}(s_1, \dots, s_l)$ . The base of the inverse role is  $L_j$ .

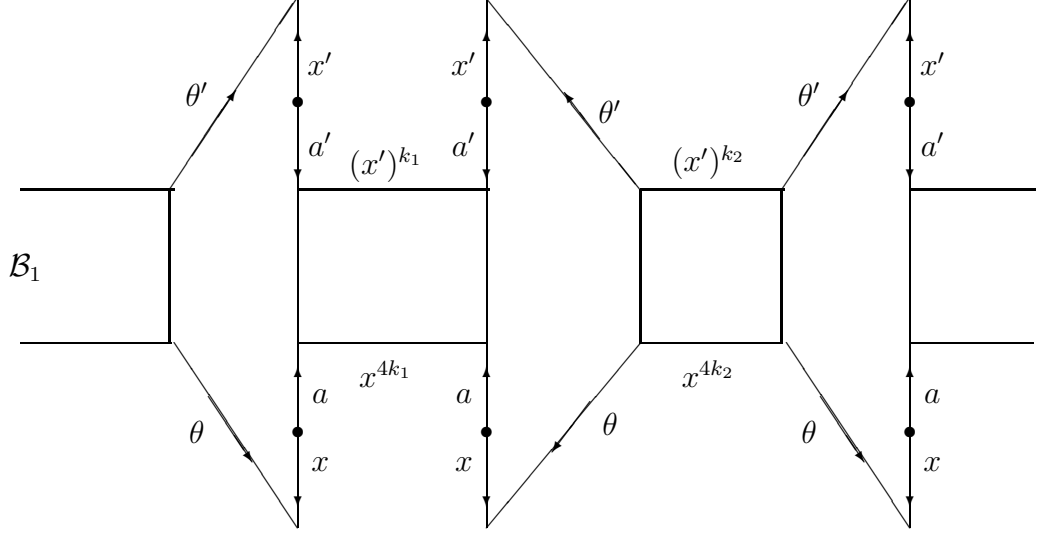

Fig. 27.

Notice that for some integers  $s_1, \dots, s_l$  divisible by 16 the label of the inner contour of  $\Psi^{-1}(s_1, \dots, s_l)$  coincides with the label of the outer contour of  $\mathcal{C}_1$ . Therefore we can do the following surgery: cut the roll  $\Delta$  along the outer contour of  $\mathcal{C}_1$ , insert in the hole a copy of  $\Psi(s_1, \dots, s_l)$  and  $\Psi^{-1}(s_1, \dots, s_l)$  (the resulting non-reduced “roll” will have the base  $L_j L_j^{-1} L_j$ ). Now reduce the smallest subroll  $\Delta'$  of the resulting diagram with the base  $L_j^{-1} L_j$ .

There are two possibilities. Either after the reduction, the base becomes  $L_j$  and only the  $L_j$ -annulus of  $\Psi^{-1}(s_1, \dots, s_l)$  will remain, or the base of the new (still non-reduced diagram will be  $L_j L_j^{-1} L_j$  but the smallest subroll with base  $L_j^{-1} L_j$  will be reduced. Applying Lemma 9.8 to that subroll, we can get back to the first possibility.

Thus we can construct another roll  $\Delta''$  with base  $L_j$  with the same boundary labels as  $\Delta$ , such that there are at most two  $a$ -annuli between the  $L_j$ -annulus of  $\Delta''$  and the inner contour of  $\Delta''$ . By Lemma 9.3 this means that the number of cells between the  $L_j$ -annulus of  $\Delta''$  and the inner contour is recursively bounded. This implies that the length of the  $L_j$ -annulus is recursively bounded in terms of  $|q|$ , which completes the proof.  $\square$

### 9.3 Rolls with base $L_{j-1}^{-1} K_j L_j$

A cyclic freely trivial word will be called a Dyck word. If  $W$  is a Dyck word in the alphabet  $\{z_1^{\pm 1}, z_2^{\pm 1}, \dots\}$  then for every scheme of cancellation of  $W$ , we can associate a pairing of letters of  $W$  (i.e. a selection of some pairs of letters in  $W$ , each letter occurring in one pair), and a placement of parentheses in  $W$  which show in which order we should cancel the letters. This pairing will be called *cancellation pairing* in  $W$ . For example, a pairing in the cyclic word  $b^{-1} a b b^{-1} a^{-1} b$  is represented as  $b^{-1} (a (b b^{-1}) a^{-1}) (b)$ . Each open parenthesis corresponds to unique closed parenthesis. A pair of open and closed parentheses corresponding to each other will be called *connected*. It is be convenient to draw the word on the boundary of a disc on the plane (we always read cyclic words in the



clockwise direction): One can connect the letters of each pair drawn on the disk boundary, by arcs situated on the plane, say, outside the disk, without intersections of these arcs.

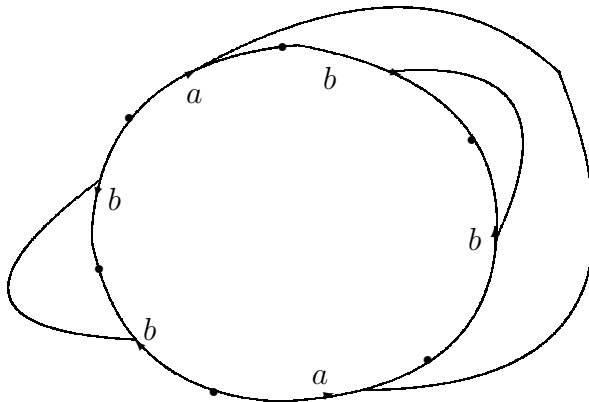

Fig. 28.

Then it is clear when a connected pair of parentheses or letters is *inside* another pair of parentheses (letters) or, vice versa, is *outside*, i.e. *contains* it. From the definition of a cancellation pairing, it is clear that no two open (resp. closed) parentheses can stay next to each other because no letter can cancel twice during the process of cancellation. Thus there is a letter next in the clockwise (counterclockwise) direction of every open (closed) parenthesis. If two parentheses are connected then we call the corresponding letters *connected*.

Let us call a pair of connected letters  $(z_i^{\pm 1}, z_i^{\mp 1})$  *normal*, if every pair of connected letters containing this pair consists of different occurrences of the same letter  $z_i^{\pm 1}$ .

For every cancellation pairing in a cyclic Dyck word  $W$ , a pair of connected letters of the form  $(z_i^{-1}, z_i)$  will be called *minus pair*, a pair of the form  $(z_i, z_i^{-1})$  will be called a *plus pair*. We call a Dyck word  $W$  a *minus word* if for some pairing (called *minus pairing*) every pair of connected letters is a minus pair. Similarly one can define a plus pairing and a plus word.

For example the cyclic word  $abb^{-1}a^{-1}abb^{-1}a^{-1}$  is both a plus word:

$$(a(bb^{-1})a^{-1})(a(bb^{-1})a^{-1})$$

and a minus word:

$$a)b(b^{-1}(a^{-1}a)b)(b^{-1}(a^{-1},$$

but it does not have a pairing where every connected pair of letters is normal.

**Lemma 9.10.** *If a minus word  $W$  contains a subword of the form  $z_i^{-1}z_j$ , then  $i = j$ , and the two letters of this subword are connected in any minus-pairing of  $W$ .*

*Proof.* If these two letters are not connected in a given minus pairing then they would be separated by a parenthesis. It is clear that in any minus pairing a negative (positive) letter stays next in the clockwise (resp. counterclockwise) direction of any open (resp.

closed) parenthesis. Therefore the parenthesis separating  $z_i^{-1}z_j$  must be both open and closed, a contradiction.  $\square$

Let  $A$  and  $B$  be alphabets and let  $\phi : A \rightarrow B \cup \{1\}$  be a map. Let  $W$  be any cyclic group word in the alphabet  $A$ . Then any pairing  $\mathcal{C}$  in  $\phi(W)$  induces a pairing of some letters in  $W$ : we simply pull the arrangement of parentheses in  $\phi(W)$  to  $W$ . Notice that some letters can be not pored in  $W$ , and the paired letters can be not mutual inverse, and, in general, the induced pairing is not a cancellation pairing.

Let  $h$  be a word over  $\mathcal{S} \cup \bar{\mathcal{S}}$ . The projection  $h_0$  of  $h$  on  $\mathcal{S}(2) \cup \mathcal{S}(4)$  will be called the  $(2, 4)$ -projection of  $h$ . If we further identify in  $h_0$  rules corresponding to the same letter  $a_i$ ,  $i = 1, \dots, \bar{m}$  (such rules will be called  $a$ -similar), then we get a word  $h_1$ . If  $h_1$  is a Dyck word then any cancellation pairing in  $h_1$  induces a pairing of letters in  $h$ . That pairing will be called a  $(2, 4)$ -pairing in  $h$ . The  $(2, 4)$ -pairing in  $h$  will be called  $z$ -good for some  $z \in \tilde{\mathcal{K}}$  if no rule locking  $zz_+$ -sectors occurs inside a pair of connected parentheses. A pairing is called  $z$ -best if no rule locking  $zz_+$ -sectors occurs in  $h$ . Further, consider any word  $W = X_1\theta_1X_2\theta_2\dots X_s$  where  $\theta_i \in \Theta(z)$ ,  $z \in \{\overleftarrow{L}_j, L_j\}$  for some  $j$ , the words  $X_1, \dots, X_s$  do not contain  $\theta$ -letters. Let  $h$  be a history of this word that is the projection of  $\theta_1\dots\theta_{s-1}$  onto  $\mathcal{S} \cup \bar{\mathcal{S}}$ . Then any  $(2, 4)$ -pairing in  $h$  induces a pairing in  $W$ . This pairing in  $W$  will be called  $z$ -good ( $z$ -best) if it is induced by a  $z$ -good ( $z$ -best) pairing in  $h$ .

**Lemma 9.11.** *Let  $z \in \{\overleftarrow{L}_j, L_j\}$  and*

$$w \equiv X_0\theta_1X_1\dots\theta_sX_s \quad (9.1)$$

for some  $s$ , where  $\theta_i^{\pm 1}$  are letters of the form  $\theta(\tau, z)$  for some  $z$ , where  $\tau$  does not lock  $zz_+$ -sectors,  $X_j$  are words in  $\mathcal{X}(z)$ . Let  $a = a_i(z)$  for some  $i \in \{1, \dots, \bar{m}\}$ . Then:

(1) Modulo relations (2.7) and (2.8), we have  $awa^{-1} = w'$  where

$$w' \equiv X'_0\theta_1X'_1\dots\theta_sX'_s,$$

$X'_0, \dots, X'_s$  are words in  $\mathcal{X}(z)$ . The number of applications of relations (2.7) in the derivation of this equality does not exceed  $s$ . If in addition  $\theta_t = \theta_{t+1}^{-1} = \theta(\tau, z)^{-1}$  for some index  $t$ , and  $X_t$  is a power of a letter  $x = x(a, \tau)$  then  $X'_t$  is again a power of  $x$ .

(2) If  $\theta_1$  is a negative letter and  $\theta_s$  is a positive letter then, modulo relations (2.7) and (2.8) the word  $w$  is equal to the word

$$w_1 = Y_0(a^{-1}x\theta_1)Y_1\theta_2Y_2\dots\theta_{s-1}Y_{s-1}(\theta_s(x')^{-1}a)Y_s,$$

where  $Y_0, \dots, Y_s$  are words in  $\mathcal{X}(z)$ ,  $x = x(a, \tau')$  where  $\theta_1^{-1} = \theta(\tau', z)$  and  $x' = x(a, \tau'')$  where  $\theta_s = \theta(\tau'', z)$ . The number of applications of relations (2.7) in the derivation of this equality is at most  $s$ . If  $\theta_t \equiv \theta_{t+1}^{-1} \equiv \theta_l(\tau, z)^{-1}$ , and  $X_t$  is a power of  $x = x(a, \tau)$ , then  $Y_t$  is again a power of  $x$ .

*Proof.* (1) By (2.8)  $ax = x^4a$  for  $x \in \mathcal{X}(z)$ . Furthermore

$$a\theta(\tau, z)^{\pm 1}a^{-1} = x^{\mp 1}\theta(\tau, z)^{\pm 1}x^{\mp 1}$$

by relations (2.7). These relations allow us to move the letter  $a$  in  $awa^{-1}$  to the right until it cancels with  $a^{-1}$ . The additional condition for  $X'_t$  can be obtained just as immediately.

(2) First make two insertions which do not change the value of  $w$  in the free group:

$$w = X_0 a^{-1} (a \theta_1 X_1 \dots \theta_s a^{-1}) a X_s.$$

Now apply part (1) of the lemma to the word  $v$  in parentheses, utilizing the fact that  $a\theta(\tau, z)^{-1} = x\theta(\tau, z)^{-1}xa$  by (2.7). As a result, we obtain a word in the desired form.  $\square$

**Lemma 9.12.** *Let  $\Delta$  be a roll with base  $K_j L_j$  or  $K_j^{-1} L_{j-1}$  whose history is a word over  $\mathcal{S}$ . Suppose that the inner contour  $q$  of  $\Delta$  coincides with the inner side  $q$  of the  $K_j$ -annulus  $\mathcal{B}'$  and the outer contour of  $\Delta$  coincides with the outer contour  $p$  of the  $L_j$ -annulus  $\mathcal{B}$ . Then:*

- (1) *Each maximal  $a$ -band in  $\Delta$  starting on  $\mathcal{B}$  ends on  $\mathcal{B}$ .*
- (2) *If  $U$  is the label of the inner contour  $p_0$  of  $\mathcal{B}$  then  $U_a$  is a Dyck word and the maximal  $a$ -bands in  $\Delta$  determine a cancellation pairing of  $U_a$ .*
- (3) *If an  $a$ -band  $\mathcal{C}$  determines a minus pair of letters  $(a^{-1}, a)$  in  $U_a$  then  $(a^{-1}, a)$  are consecutive letters in  $U_a$ , and a subband of  $\mathcal{C}$  connects two consecutive  $\theta$ -cells  $\pi_1, \pi_2$  in  $\mathcal{B}$ . The corresponding subword in the history of the roll is  $\tau^{-1}\tau$  where  $\tau \in \mathcal{S}^+(2) \cup \mathcal{S}^+(4)$ .*
- (4) *Let  $\Gamma$  be a small subtrapezium in  $\Delta$  with history  $\tau^{-1}\tau$  from part (3). Let  $\mathcal{T}_1$  and  $\mathcal{T}_2$  be two  $\theta$ -bands containing the cells  $\pi_1, \pi_2$ . Then the maximal subword in  $\mathcal{X}$  written on  $p_0$  (see part (2)) between  $\mathcal{T}_1$  and  $\mathcal{T}_2$  is a power of a letter  $x(a, \tau)$ .*

*Proof.* We consider only the case when the base is  $K_j L_j$  (the other case is similar).

- (1) The statement is obvious since the sides of the  $K_j$ -band do not have  $a$ -edges.
- (2) If an  $a$ -band starts on an edge  $e$  of the path  $p_0$ ,  $\phi(e) = a^{\pm 1}$  then it ends on an edge of  $p_0$  with label  $a^{\mp 1}$ . Since the maximal  $a$ -bands do not intersect, they determine a pairing in  $U_a$ .
- (3) Let  $\Delta_0$  be the van Kampen subdiagram of  $\Delta$  bounded by  $\mathcal{C}$  and a part of  $p_0$  (and including  $\mathcal{C}$ ). Suppose that  $\Delta_0$  contains another maximal  $a$ -band  $\mathcal{C}'$  corresponding a plus pair. Then we should be able to find a small subtrapezium  $\Gamma$ , whose  $\theta$ -bands  $\mathcal{T}_1, \mathcal{T}_2$  are connected by a subband of  $\mathcal{C}$  and by a subband of  $\mathcal{C}'$ . Then consider the label  $V$  of a part of a side of  $\mathcal{T}_1$  from  $\mathcal{B}'$  to  $\mathcal{B}$ . When we read the word  $V$  from left to right (from  $\mathcal{B}'$  to  $\mathcal{B}$ ) then we first read a negative  $a$ -letter (since  $\mathcal{C}$  corresponds to a minus pair) and then a positive  $a$ -letter since  $\mathcal{C}'$  corresponds to a plus pair. But this contradicts Lemma 6.11. Hence the  $a$ -band  $\mathcal{C}'$  does not exist.

It is clear from the form of relations (2.7) that the  $a$ -band  $\mathcal{C}$  connects two  $\theta$ -cells  $\pi_1$  and  $\pi_2$  corresponding to rules  $\tau_1^{-1}$  and  $\tau_2$  where the rules  $\tau_1, \tau_2 \in \mathcal{S}^+(2) \cup \mathcal{S}^+(4)$  are similar. If in the corresponding subword  $h = \tau_1^{-1} \dots \tau_2$  of the history of  $\Delta$ , there exists a reduced subword of length 2 then there exists a small subtrapezium  $\Gamma$  with reduced history, such that  $\mathcal{C}$  crosses  $\Gamma$ . Therefore the word  $V_0$  defined for  $\Gamma$  like the word  $V$  in the previous paragraph, contains a negative  $a$ -letter. But this contradicts Lemma 6.12.

Therefore  $h \equiv \tau^{-1}\tau\tau^{-1}\tau \dots$ . As we have proved before, all pair of edges on  $p_0$  defined by  $a$ -bands in  $\Delta_0$  are minus pairs. Obviously it is possible only if  $h \equiv \tau^{-1}\tau$ .

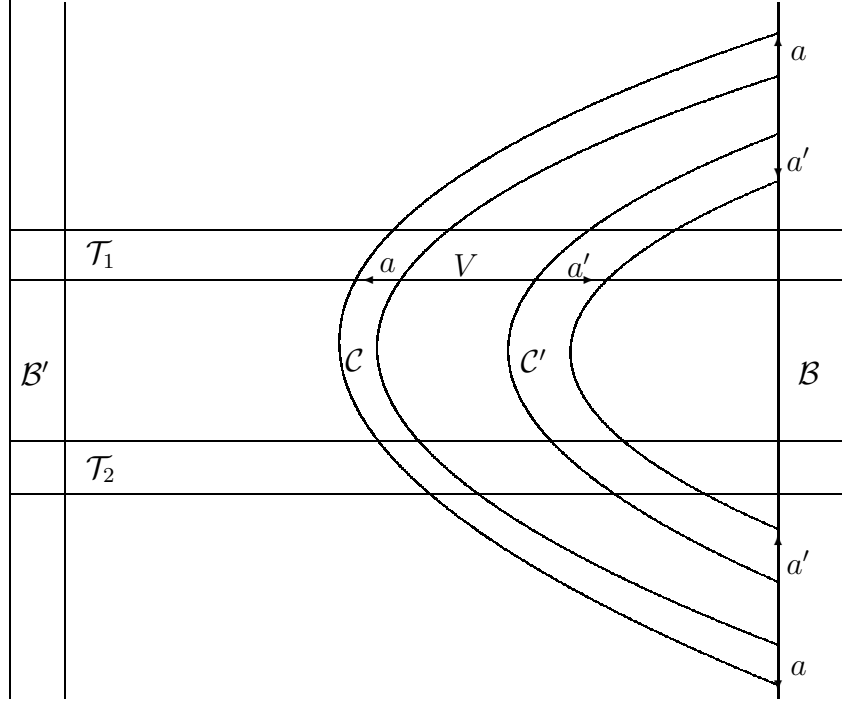

Fig. 29.

(4) By part (3), a subband  $\mathcal{C}_0$  of  $\mathcal{C}$  connects two  $a$ -edges which are the closest  $a$ -edges to the  $L_j$ -edges of sides of  $\mathcal{T}_1$  and  $\mathcal{T}_2$ . Since  $\mathcal{C}$  defines a minus pair in  $U_a$ , the word  $W$  over  $\mathcal{X}$  written on the side of  $\mathcal{C}_0$  which is closer to  $\mathcal{B}$  is a product of fourth powers (see relations (2.8)). The word  $W'$  written on  $p_0$  between  $\mathcal{T}_1$  and  $\mathcal{T}_2$  is also a product of fourth powers. Then by Lemma 6.1, we have the equality  $W' = xWx^{-1}$  in the free group. By Lemma 6.10 (part (4)), it follows that both  $W$  and  $W'$  are powers of  $x$ .

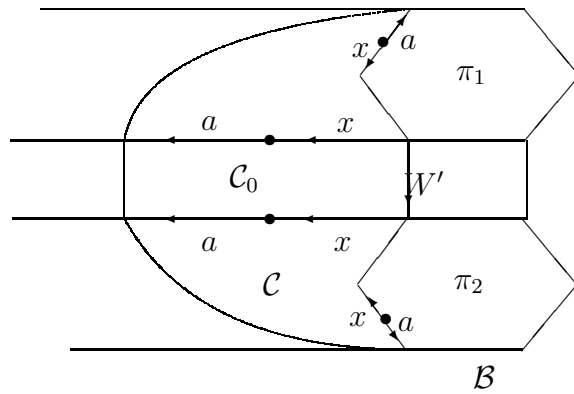

Fig. 30.

□

**Lemma 9.13.** *Let  $\Delta$  be a roll with base  $L_j$ , bounded by the inner contour  $q$  of an  $L_j$ -annulus, and the outer contour  $p$  of an  $a$ -annulus. Let  $\mathcal{T}$  and  $\mathcal{T}'$  be two consecutive (clockwise)  $\theta$ -bands connecting  $q$  and  $p$ . Let  $\Gamma$  be the subdiagram containing  $\mathcal{T}$  and  $\mathcal{T}'$  and all cells between them. Let  $V$  be the label of  $\mathbf{bot}(\mathcal{T})$ . By Lemma 6.11,  $V \equiv V_1V_2$  where  $(V_1)_a$  is positive and  $(V_2)_a$  is negative. We claim that either  $|V_a| \leq 2|p|$  or  $|(V_1)_a| > |p|$ .*

*Proof.* By contradiction, assume that  $|(V_2)_a| > |p|$ . Let  $\mathcal{C}_1, \dots, \mathcal{C}_{|p|+1}$  be a series of consecutive  $a$ -bands connecting  $\mathcal{T}$  and  $\mathcal{T}'$  enumerated from  $q$  to  $p$ , so  $\mathcal{C}_{|p|+1}$  is a subband of  $\mathcal{C}$ . Then the length of the  $U_1$ , over  $\mathcal{X}$  written on the bottom side of  $\mathcal{C}_1$  and the length of the word  $U'_1$  written on the top of  $\mathcal{C}_1$  are related by the equality  $|U'_1| = 4|U_1|$  (see relations (2.8)) because the word  $(V_2)_a$  is negative.

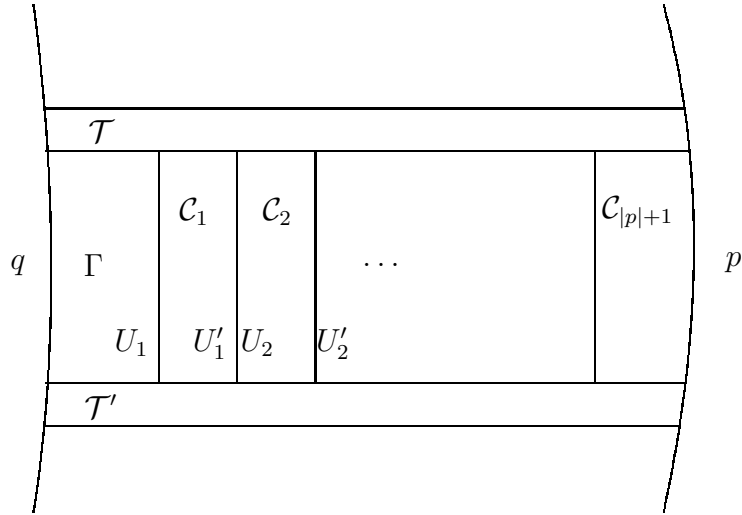

Fig. 31.

Let us introduce similar notation  $U_2, U'_2$  for words over  $\mathcal{X}$  on the bottom and top sides  $\mathcal{C}_2$ . Then as in Lemma 9.12 (4), we have  $U_2 = x^{\pm 1}U'_2y^{\pm 1}$  for some  $x$ -letters  $x$  and  $y$ . Notice that either  $U_1$  is not empty or  $x^{\pm 1} \neq y^{\mp 1}$  because otherwise the  $(\theta, a)$ -cells connected by  $\mathcal{C}_2$  would form a reducible pair of cells. Therefore  $|U_2| > |U_1|$ . Similarly  $|U_2| < |U_3| < \dots < |U_{|p|+1}|$ . But then  $|U'_{|p|+1}| \geq 4|U_{|p|+1}| \geq 4(|p|)$ , a contradiction since the definition of  $A_{|p|+1}$  implies that  $|U'_{|p|+1}| \leq |p|$ .  $\square$

**Lemma 9.14.** *In the notation of Lemma 9.13, let the label  $X$  of the subpath  $\Gamma \cap q$  be a power of a letter  $x \in \mathcal{X}$ , and  $\mathcal{C}$  be an arbitrary  $a_i(L_j)$ -band between  $\mathcal{T}$  and  $\mathcal{T}'$  starting on the “positive” subpath of a side of  $\mathcal{T}$  with label  $V_1$ . Then the words in  $\mathcal{X}$  on  $\partial(\mathcal{C})$  are powers of  $x' = x(a_i(L_j), \tau)$ , and all  $a$ -bands  $\mathcal{C}_1, \dots, \mathcal{C}_r = \mathcal{C}$  between the  $L_j$ -annulus  $\mathcal{B}$  and  $\mathcal{C}$ , connecting  $\mathcal{T}$  and  $\mathcal{T}'$  correspond to the same  $a$ -letter  $a_i(L_j)$ .*

*Proof.* Let  $X'$  be a word in  $\mathcal{X}$  written from  $\mathcal{T}$  to  $\mathcal{T}'$  on the top of the subband  $\bar{\mathcal{B}}$  of the  $L_j$ -annulus  $\mathcal{B}$  whose bottom side is labelled by  $X$ . Then relations (2.9) imply that  $X'$  is a power of a letter from  $\mathcal{X}$ . Let  $Y_i$  and  $Y'_i$  are words in  $\mathcal{X}$  written respectively on the bottom side (the side that is closer to  $\mathcal{B}$ ) and the top side of the  $a$ -band  $\mathcal{C}_i$ . Then  $x_1^{\pm 1}Y_1x_2^{\pm 1} = X'$

for some  $x$ -letters  $x_1, x_2$  since the word  $(V_1)_a$  is positive (see Lemma 6.1). Besides  $Y_1$  is a product of fourth powers according to the relations (2.8). This immediately implies that both  $Y_1$  and  $Y_2$  are powers of a letter  $x'$  (the assumption that  $Y_1$  is empty and  $x_1^{\pm 1}$  and  $x_2^{\pm 1}$  are mutually inverse implies that two  $\theta$ -cells in  $\mathcal{T}, \mathcal{T}'$  that are connected by  $\mathcal{C}_1$  cancel). The letters  $x_1$  and  $x_2$  also must coincide with  $(x')^{\pm 1}$ . Therefore  $Y_1$  is an  $a$ -band where  $a$  is determined by the letter  $x'$  (see relations (2.7)). Repeating this argument leads to the same conclusion for  $x$ -subwords written on the sides of  $a$ -bands  $\mathcal{C}_2, \dots, \mathcal{C}_r = \mathcal{C}$ , so all these  $a$ -bands correspond to the same letter from  $\mathcal{A}$  determined by the  $x$ -letter  $x'$ .  $\square$

**Lemma 9.15.** *Let a reduced annular diagram  $\Delta$  consists of one  $a$ -annulus with inner side  $q$  and outer side  $p$ , and the edges with positive labels  $a = a_i(L_j)$  cut the diagram from  $q$  to  $p$  (that is the edges with positive  $a$ -labels are oriented outward). Let the word  $w \equiv \phi(q)$  have the form (9.1) from Lemma 9.11 for  $z = L_j$  and  $s > 0$ . Suppose that the cyclic word  $w$  admits two  $(2, 4)$ -pairings, a  $L_j$ -best pairing  $I$  and a  $\overleftarrow{L}_j$ -good pairing  $II$ , such that  $I$  is a minus pairing, and in  $II$ , all minus pairs correspond to occurrences of subwords  $\theta^{-1}X\theta$  where  $X$  is a power of a letter  $x = x(a, \tau)$ ,  $\theta = \theta(\tau, L_j)$ . Suppose further that the minus pairs of  $II$  are normal pairs for  $I$ . Then there exists an annular diagram  $\Delta'$  with the labels of contours  $w, w'$  where  $w'$  also has the form (9.1) but for  $z = \overleftarrow{L}_j$  and possibly with different  $x$ -subwords than  $w$ ; the diagram  $\Delta'$  has one  $L_j$ -annulus  $\mathcal{B}_0$  surrounding the hole of  $\Delta'$ , other cells in  $\Delta'$  correspond to relations (2.7) and (2.8), and the number of  $\theta$ -cells in  $\Delta'$  is less than  $s^2$ .*

*Proof.* By Lemma 9.11 (2), using the pairing  $I$  we can replace each pair of connected letters  $\dots\theta^{-1}\dots\theta'\dots$  in the cyclic word  $w$  by a pair of subwords  $\dots(a^{-1}x\theta^{-1})\dots(\theta'x'^{-1}a)\dots$  (starting with the outermost pairs in  $I$ ). The number of  $(\theta, a)$ -relations used in the transition to the new word  $w_1$  is less than  $s^2/2$ . The form of the word  $w_1$  given in Lemma 9.11 (2) and the form of relations (2.6) corresponding to rules from  $\mathcal{S}(2) \cup \mathcal{S}(4)$ , and relations (2.7) allows us to glue an  $L_j$ -annulus  $\mathcal{B}_0$  to the annular diagram of conjugacy of  $w$  and  $w_1$  along the path with label  $w_1$  (the top side of  $\mathcal{B}_0$ ).

In the transition from  $w$  to  $w_1$ , we do not change the  $\theta$ -letters. Suppose that an occurrence of a subword of the form  $\theta^{-1}X\theta$  corresponds to a minus pair in  $II$ . By Lemma 9.10 this pair is connected in  $I$  as well. This pair is normal in  $I$  by the assumption of the lemma. Therefore in the subword  $(a^{-1}x\theta^{-1})Y(\theta x^{-1}a)$  of the word  $w_1$  obtained by Lemma 9.11 (2) from the subword  $\theta^{-1}X\theta$  of  $w$ , the word  $Y$  is a power of the same letter  $x$ .

Let  $w_2$  be the word written on the bottom side of our  $L_j$ -annulus  $\mathcal{B}_0$ . The subword of  $w_1$  discussed in the previous paragraph corresponds to the subword of the form  $(a^{-1}x_{-}\theta^{-1})Y_{-}^4(\theta_{-}x_{-}^{-1}a_{-})$  in  $w_2$  (see relations (2.9) and (2.6)) where the minus sign in the subscript means that we replace  $L_j$  by  $\overleftarrow{L}_j$  in  $a_i(L_j)$ ,  $x(a_i(L_j), \tau)$  and  $\theta(\tau, L_j)$ . Since we have a fourth power in the middle of this word, we can transform this occurrence into  $\theta^{-1}Y_{-}\theta_{-}$  without  $a$ -letters applying relations (2.8) and two relations (2.7).

In the resulting word  $w_3$ ,  $a$ -letters occur only in subwords of the form  $(\theta x^{-1}a)^{\pm 1}$ , where the letter  $\theta$  occurs in a plus pair of the pairing  $II$ . These  $a$ -letters can be removed using relations (2.7) and (2.8) by Lemma 9.11 (1). As a result, we get a word  $w_4 = w'$  and the diagram  $\Delta'$  consists of a  $L_j$ -annulus  $\mathcal{B}_0$  and other cells described above. This diagram satisfies all the conditions of the lemma.  $\square$

**Lemma 9.16.** *Let  $\Delta$  be a roll with base  $K_j L_j$  or  $K_j^{-1} L_{j-1}$  ( $j$  is odd), whose history is not empty and does not contain rules from  $\mathcal{S}$ . Suppose the outer contour  $p$  of the roll is the outer contour of some  $a_i(L_j)$ -annulus. Then either between the  $L_j$ -annulus  $\mathcal{B}$  and  $p$ , there exists an  $a$ -annulus  $\mathcal{C}$  satisfying the conditions of Lemma 9.15 and the length of every  $\theta$ -band connecting  $\mathcal{B}$  and  $\mathcal{C}$  is at least  $|p|$  or  $\mathcal{B}$  and  $p$  are connected by a  $\theta$ -band of length  $\leq 2|p|$ .*

*Proof.* We can consider only the case when the base is  $K_j L_j$ . Let  $\Delta_1$  be the annular subdiagram in  $\Delta$  bounded by  $\mathcal{B}$  and  $p$ . By Lemma 9.13 we can assume that for every two consequent  $\theta$ -bands  $\mathcal{T}$  and  $\mathcal{T}'$  connecting  $\mathcal{B}$  and  $p$ ,  $|V_1|_a > |p|$  in the notation of Lemma 9.13. If we enumerate all  $a$ -annuli between  $\mathcal{B}$  and  $p$  from  $\mathcal{B}$  to  $p$ :  $\mathcal{C}_1, \mathcal{C}_2, \dots$ , then we can let  $\mathcal{C}$  be the first  $a$ -annulus which cannot be connected with  $\mathcal{B}$  by any  $\theta$ -band of length  $< |p|$ .

Since  $\Delta_1$  has an  $a$ -annulus by the lemma assumption, we have that every maximal  $a$ -band  $\mathcal{C}'$  in  $\Delta_1$  that starts on  $\mathcal{B}$ , ends on  $\mathcal{B}$ , and we obtain a pairing in the word  $U'_a$  where  $U'$  is written on the top side of  $\mathcal{B}$ .

Since the  $a$ -letters in a relation (2.6) corresponding to rules from  $\mathcal{S}(2) \cup \mathcal{S}(4)$  determine the rule up to the similarity relation, we have a  $(2, 4)$ -pairing  $I$  in the word  $U'$ .

Any  $a$ -band  $\mathcal{C}'$  of  $\Delta_1$ , starting and ending on  $\mathcal{B}$  has a subband connecting a pair of consecutive  $\theta$ -bands  $\mathcal{T}$  and  $\mathcal{T}'$ . Moreover  $\mathcal{C}'$  must intersect the path labelled by  $V_1$  (in the above notation) because between  $\mathcal{C}'$  and  $\mathcal{T}$  there are less than  $|p|$  maximal  $a$ -bands and  $|V_1|_a \geq |p|$ . Since  $(V_1)_a$  is a positive word,  $\mathcal{C}'$  determines a minus pair of  $a$ -letters. Therefore  $I$  is a minus-pairing. Notice that this pairing is  $L_j$ -best. Indeed, every maximal  $\theta$ -band in  $\Delta$  intersects the annulus  $\mathcal{C}$ . Hence for each  $\theta$ -letter on the outer contour of  $\mathcal{B}$ , there exists a  $(\theta, a)$ -relation of the form (2.7) containing  $\theta$ . Thus the corresponding rule from  $\mathcal{S}$  does not lock  $L_j P_j$ -sectors.

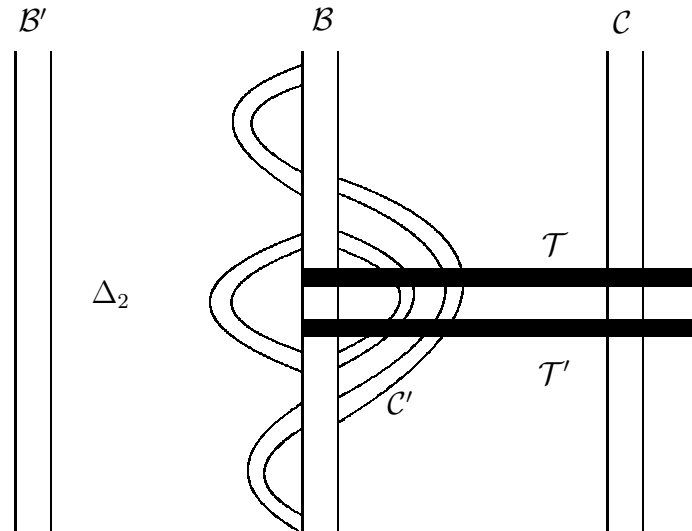

Fig. 32.

Now consider the subroll  $\Delta_2$  bounded by  $\mathcal{B}$  and the  $K_j$ -annulus  $\mathcal{B}'$ . Lemma 9.12 (2) gives a pairing in the word  $U_a$  where  $U$  is the label of the bottom of  $\mathcal{B}$ . This automatically

gives a  $(2, 4)$ -pairing in the word  $U$  which we shall denote by  $II$ . This pairing is  $K_j$ -good because an  $a$ -band that connects two edges on the inner contour of  $\mathcal{B}$  cannot cross a  $\theta$ -band corresponding to a rule locking  $K_j L_j$ -sectors (see relations (2.7)). By Lemma 9.12 (3,4) every minus pair of  $\theta$ -letters of  $II$  corresponds to an occurrence of a subword  $\theta^{-1}Y\theta$  in  $U$  where  $Y$  is a power of an  $x$ -letter  $x = x(a, \tau)$  ( $a$  is obviously determined by  $\theta$  by the relations (2.6)). By Lemma 9.10 the same pair of letters must be connected in the pairing  $I$ , and by Lemma 9.14 for  $\Delta_1$  the corresponding occurrence in  $\phi(p)$  also has the form  $\theta^{-1}X\theta$  where  $X$  is a power of the letter  $x(a', \tau)$  where  $a'$  is the “brother” of  $a$ . The normality condition of the bottom of  $\mathcal{C}$  follows from Lemma 9.14 and the choice of  $\mathcal{C}$ .  $\square$

**Lemma 9.17.** *Let  $\Delta$  be a roll with base  $L_{j-1}^{-1}K_j L_j$  for some  $j$  and history  $h$ ,  $|h| > 0$ . Let the outer contour  $p$  of  $\Delta$  be the outer contour of some  $a$ -annulus, and  $h$  does not contain rules from  $\bar{\mathcal{S}}$ . Then there exists a roll  $\bar{\Delta}$  with the same boundary labels and the same base as  $\Delta$  where the  $L_j$ -annulus can be connected with  $p$  by a  $\theta$ -band of length  $\leq 2|p|$ .*

*Proof.* By Lemma 9.16 applied to the subroll with base  $K_j L_j$  we can assume that there exists an  $a$ -annulus  $\mathcal{C}$  between the  $L_j$ -annulus  $\mathcal{B}$  and  $p$  satisfying the conditions of Lemmas 9.16 and 9.15. Hence the number of  $(\theta, a)$ -cells between  $\mathcal{B}$  and  $\mathcal{C}$  is at least  $|p|s$  which, in turn, at least  $s^2$  where  $s$  is the length of the history of the roll.

Consider the auxiliary diagram  $\Delta'$  corresponding to  $\mathcal{C}$  as in the conclusion of Lemma 9.15. Let  $\Delta''$  be the diagram obtained from  $\Delta'$  by first taking the mirror image and then changing the indexes  $L_j$  to  $L_{j-1}$ , and  $K_j$  to  $K_j^{-1}$  in all labels (Lemma 3.13 allows us to do that). Lemma 9.15 and the form of relations (2.6) corresponding to  $K_j$  imply that there exists a  $K_j$ -band  $\mathcal{B}'$  whose outer contour coincides with the inner contour of  $\Delta'$  and whose inner contour coincides with the outer contour of  $\Delta''$ . The diagram  $\Delta_0$  obtained by gluing these three diagrams ( $\Delta'$ ,  $\mathcal{B}'$  and  $\Delta''$ ) has outer contour  $q_0$  labelled by  $w$  (same as  $\mathcal{C}$ ) and inner contour labelled by the word  $w''$  obtained from  $w$  by replacing the index  $L_j$  with  $L_{j-1}$  in all letters.

Therefore we can do the following transformation with  $\Delta$ . First cut  $\Delta$  along  $q_0$  (the inner contour of  $\mathcal{C}$ ), along the outer contour  $p_1$  of the  $K_j$ -annulus  $\mathcal{B}''$  of  $\Delta$ , and along the inner contour  $q_1$  of this annulus. We get three annular diagrams  $\Delta_1, \Delta_2$  and  $\Delta_3$  where  $\Delta_1$  is bounded by  $p$  and  $q_0$ ,  $\Delta_2$  is bounded by  $q_0$  and  $p_0$  and  $\Delta_3$  is bounded by  $q_1$  and  $q$ . Then change index  $K_j$  to  $L_{j-1}^{-1}$ ,  $L_j$  by  $L_{j-1}$  in all labels of edges of  $\Delta_2$ . Let  $\Delta'_2$  be the resulting diagram. The label of the outer contour of  $\Delta'_2$  is identical with the label of the inner contour of  $\Delta_0$  and the label of the inner contour of  $\Delta'_2$  coincides with the label of  $q_1$  as follows from the form of  $K_j$ -relations (2.6) and (2.9). Let  $\bar{\Delta}$  be the result of gluing  $\Delta_1, \Delta_0, \Delta'_2$ , and  $\Delta_3$  and reducing the resulting diagram. By Lemma 9.15, the number of  $(\theta, a)$ -cells between the  $L_j$ -annulus of  $\bar{\Delta}$  and  $p$  is smaller than the similar number for  $\Delta$ . So our transformation moved the  $L_j$ -annulus “closer” to  $p$ .

The base of  $\bar{\Delta}$  before reducing was  $L_{j-1}^{-1}L_{j-1}L_{j-1}^{-1}K_j L_j$  (one  $L_{j-1}$ -band comes from  $\Delta_1$ , and two from  $\Delta_0$ ). After reducing two of the  $L_{j-1}$ -bands can disappear.

If this does not happen then the history of  $\bar{\Delta}$  is a word over  $\mathcal{S}(2) \cup \mathcal{S}(4)$  (since other rules lock  $L_{j-1}^{-1}K_j$ -sectors or  $P_{j-1}^{-1}L_{j-1}^{-1}$ -sectors). Hence we can apply Lemma 9.8 and remove two of the  $L_{j-1}$ -annuli from  $\bar{\Delta}$ .



Thus after the transformations described above we get a roll with the same base, same labels of the contours as  $\Delta$  but with the  $L_j$ -annulus closer to  $p$  than in  $\Delta$ . Moving the  $L_j$ -annulus further toward  $p$ , we obtain the desired roll  $\bar{\Delta}$ .  $\square$

## 9.4 Arbitrary rolls

**Lemma 9.18.** *Let  $\Delta$  be a roll with contours  $p$  and  $q$ . Then there exists a roll  $\Delta'$  with the same boundary labels as  $\Delta$ , which contains a path  $t$  connecting the two contours of  $\Delta'$ , whose length is recursively bounded in terms of  $|p| + |q|$ .*

*Proof.* By Lemma 5.5, we can assume that  $\Delta$  satisfies (R1) and (R2).

If the history of  $\Delta$  is empty then  $\Delta$  contains only  $\mathcal{G}$ -cells and auxiliary cells corresponding to relations (2.8). Moreover, a  $\mathcal{G}$ -cell cannot have common edges with the  $(\mathcal{A}, \mathcal{X})$ -cells. Thus  $\Delta$  must be a union of  $\mathcal{G}$ -cells and diagrams over  $\mathcal{H}_2$ , and different components of this union do not have common edges, i.e.,  $\Delta$  is the diagram over the free product of groups. Hence the statement of the lemma in that case follows from the solvability of the conjugacy problem in  $\mathcal{G}$  and the conjugacy problem in  $\mathcal{H}_2$  (Lemma 4.4).

Hence we can assume that the history of  $\Delta$  is not empty. Let  $\mathcal{T}_1, \mathcal{T}_2, \dots$  be the maximal  $\theta$ -bands in  $\Delta$  connecting  $q$  and  $p$ .

Denote by  $\mathcal{B}_1, \dots, \mathcal{B}_r$  the basic annuli of the roll  $\Delta$  counted from  $q$  to  $p$ . We are going to recursively bound the number  $r$  as function of  $|p|, |q|$  in  $\Delta$  or in a roll with the same boundary labels and to use induction on  $r$ . The case  $r = 0$  has been treated in Lemma 9.2.

Recall that there are no auxiliary  $x$ -cells in  $P$ - or  $R$ -bands. Hence the length of every  $P$ - or  $R$ -annulus in  $\Delta$  is at most  $\min(|p|, |q|)$ . One may assume that there are no such distinct bands with equal boundary labels, because this would allow us to delete an annular subdiagram of  $\Delta$  and to reduce the number of  $k$ -annuli in  $\Delta$ . Since the number and the lengths of  $P$ - and  $R$ -annuli are recursively bounded, our task is reduced to rolls having neither  $P$ - nor  $R$ -annuli.

Assume that there is a  $K_j$ -annulus  $\mathcal{B}_s$  and a  $K_{j'}$ -annulus  $\mathcal{B}_{s'}$  where  $s' > s$ . We choose  $s'$  so that  $s' - s$  is minimal possible. Since there are neither  $P$ - nor  $R$ -annuli among  $\mathcal{B}_s, \mathcal{B}_{s+1}, \dots, \mathcal{B}_{s'}$ , we have  $j' = j$  by Lemma 6.2, and the base of the subroll  $\Delta'$  of  $\Delta$  bounded by  $\mathcal{B}_s$  and  $\mathcal{B}_{s'}$  has one of the forms:

$$K_j L_j L_j^{-1} L_j \dots L_j^{-1} K_j^{-1}, \quad (9.2)$$

or

$$K_j^{-1} L_{j-1} L_{j-1}^{-1} \dots K_j, \quad (9.3)$$

if  $j$  is odd, or

$$K_j K_j^{-1} \text{ or } K_j^{-1} K_j \quad (9.4)$$

if  $j$  is even.

We shall assume that  $j$  is odd, the other case is similar. By Lemma 6.2 none of the rules in the history of the roll locks  $L_j P_j$ -sectors if the base of  $\Delta'$  has the form (9.2), and none of them locks  $L_{j-1} P_{j-1}$ -sectors if the base has the form (9.3). In particular, if the history of the roll contains rules from  $\bar{\mathcal{S}}$ , then  $j \neq 1$  in the (9.2) case. In addition, if there

is a  $\bar{\Theta}$ -band in  $\Delta'$ , then there are no  $\Theta$ -bands, because a common admissible word for  $\mathcal{S}$  and  $\bar{\mathcal{S}}$  have no  $a(L_j)$ -letters, and so, for any  $j$ , it has no subwords with base  $L_j L_j^{-1}$ .

The subroll bounded by  $\mathcal{B}_s$  and  $\mathcal{B}_{s'}$  has no  $\mathcal{G}$ -cells by Lemma 6.1 and by Lemma 6.5 applied to the small subtrapezia of  $\Delta'$ . By Lemma 9.1, all  $a$ -edges in the subroll between  $\mathcal{B}_t$  and  $\mathcal{B}_{t+1}$ ,  $s \leq t \leq s' - 1$  have labels from  $\mathcal{A}(z) \cup \bar{\mathcal{A}}(z)$  where  $z = z(t)$  depends on  $t$  only ( $z$  is either  $K_j$  or  $L_j$  if the base of  $\Delta'$  has the form (9.2) and  $z$  is either  $K_j^{-1}$  or  $L_{j-1}$  if the base has the form (9.3)).

We are going to show how to eliminate the two  $K_j$ -annuli from  $\Delta$  without changing the boundary labels of  $\Delta$ . Suppose that the base has the form (9.2). Recall that by Lemma 6.2, there are no  $\bar{\Theta}$ -cells in  $\Delta'$  if  $j = 1$ . Therefore every auxiliary relation involving letters from  $\mathcal{A}(K_j) \cup \bar{\mathcal{A}}(K_j) \cup \Theta(K_j) \cup \bar{\Theta}(K_j) \cup \mathcal{X}(K_j)$  and involved in  $\Delta'$ , has a copy involving letters from  $\mathcal{A}(L_{j-1}^{-1}) \cup \bar{\mathcal{A}}(L_{j-1}^{-1}) \cup \Theta(L_{j-1}^{-1}) \cup \bar{\Theta}(L_{j-1}^{-1}) \cup \mathcal{X}(L_{j-1}^{-1})$ , every  $L_j$ -cell has a copy  $L_{j-1}$ -cell, and every auxiliary relation involving letters from  $\mathcal{A}(L_j) \cup \bar{\mathcal{A}}(L_j) \cup \Theta(L_j) \cup \bar{\Theta}(L_j) \cup \mathcal{X}(L_j)$  (and involved in  $\Delta'$ ) has a copy involving letters from  $\mathcal{A}(L_{j-1}) \cup \bar{\mathcal{A}}(L_{j-1}) \cup \Theta(L_{j-1}) \cup \bar{\Theta}(L_{j-1}) \cup \mathcal{X}(L_{j-1})$ . Notice that the labels of the inner and outer side of a  $K_j$ -band become identical after a substitution of each letter from  $\Theta(K_j) \cup \bar{\Theta}(K_j) \cup \mathcal{X}(K_j)$  by its “brother” in  $\Theta(L_{j-1}^{-1}) \cup \bar{\Theta}(L_{j-1}^{-1}) \cup \mathcal{X}(L_{j-1}^{-1})$  (see Lemma 3.13).

Let us replace every label in the subroll of  $\Delta$ , bounded by the outer side of  $\mathcal{B}_s$  and the inner side of  $\mathcal{B}_{s'}$ , by its copy in the sense of the previous paragraph. Then we obtain a roll whose boundary labels coincide with the boundary labels of the subroll  $\Delta'$ . Hence we can replace  $\Delta'$  in  $\Delta$  by a subroll with fewer  $K_j$ -annuli, as desired. Let us call this operation *the operation of removing  $K_j$ -annuli*.

In the case when the base has the form (9.3) the procedure of removing  $K_j$ -bands is similar. The only exception is the case when  $j = 1$ . In that case  $(L_{j-1}, \bar{\Theta})$ -cells do not have  $L_1$ -copies. But then all  $\theta$ -cells of  $\Delta'$  are  $\bar{\Theta}$ -cells, as we noticed earlier. So we need to apply the homomorphism that kills  $(a)K_j^{-1}$ - and  $\bar{a}(L_{j-1})$ -letters. This homomorphism sends relations to relations, so the construction carries out without other changes.

Hence  $\Delta$  contains at most one  $K_j$ -annulus. Suppose  $\Delta$  does not have  $K_j$ -annuli and the base of  $\Delta$  has at least 3 letters. Then the history of  $\Delta$  is a words in  $\mathcal{S}(2) \cup \mathcal{S}(4) \cup \bar{\mathcal{S}}$  since other rules lock either  $L_j P_j$ - or  $L_j^{-1} \bar{L}_j^{-1}$ -sectors. In this case the base can be shorten by Lemma 9.8. If there are  $K_j$ -annuli in  $\Delta$  and its base has at most two letters, then we can complete the proof by applying Lemma 9.9. So let us assume that  $\Delta$  contains exactly one  $K_j$ -annulus  $\mathcal{B}_s$ . Thus (up to an inside-out transformation of the roll) the base of  $\Delta$  has the form  $\dots L_{j-1} L_{j-1}^{-1} K_j L_j L_j^{-1} \dots$  if  $j$  is odd or  $K_j$  if  $j$  is even (the  $L_j$ 's may be absent even if  $j$  is odd).

If the base of  $\Delta$  contains a subwords  $L_s L_s^{-1}$  and  $L_s^{-1} L_s$  then none of the rules in the history of  $\Delta$  locks  $L_s^{-1} z$ - or  $L_s$ -sectors. Hence the history of  $\Delta$  is a word in  $\mathcal{S}(2) \cup \mathcal{S}(4) \cup \bar{\mathcal{S}}$ . By Lemma 9.8, every subroll with base  $L_s^{-1} L_s$  can be replaced by a subroll with an empty base. Hence we can assume that the base of  $\Delta$  does not contain subwords  $L_s^{-1} L_s$ . Therefore the base of  $\Delta$  has length at most 5.

Thus  $k$ -annuli of  $\Delta$  divide  $\Delta$  into at most six subrolls with empty bases. Let us number these subrolls  $\Delta_1, \Delta_2, \dots, \Delta_{r+1}$ ,  $r \leq 5$ , counting from  $q$  to  $p$ . As in Lemma 9.9, let us fix a “big enough” recursive function  $f(x)$ , it will be clear later, how big this function should be.

If  $\Delta_1$  or  $\Delta_{r+1}$  has a path of length  $\leq f(|p| + |q|)$  connecting its boundary components then using Lemma 5.3, we can show that the number of cells in  $\Delta_1$  or  $\Delta_{r+1}$  is recursively bounded in terms of  $|p| + |q|$ , and we can remove these subrolls and  $\mathcal{B}_1$  or  $\mathcal{B}_{t-1}$  from  $\Delta$  reducing the number of  $k$ -annuli in  $\Delta$ . Thus we can assume that  $\Delta_1$  and  $\Delta_{r+1}$  have no short cuts.

Suppose that the base of  $\Delta$  starts with  $K_j$ . By Lemma 9.3, the roll  $\Delta_1$  contains an  $a$ -annulus  $\mathcal{C}$ . It is easy to see that one can build a  $K_j$ -annulus  $\mathcal{B}'$  whose outer side label coincides with a inner side label of  $\mathcal{C}$ . Now cut the roll  $\Delta$  along that side of  $\mathcal{C}$ , and insert in the hole the  $K_j$ -band  $\mathcal{B}'$  and its inverse (so that the two  $K_j$ -bands cancel each other). As a result we get a non-reduced annular diagram with three  $K_j$ -annuli. Using the operation of removing  $K_j$ -annuli, we can now remove the bands  $\mathcal{B}_1, \mathcal{B}'$ . After reducing the new annular diagram, we get a roll with the same boundary labels and the same base as  $\Delta$  but with the  $K_j$ -band closer to  $q$  than in  $\Delta$ . Let us call this operation *the operation of moving a  $K_j$ -band*. We can use this operation to move the  $K_j$ -band towards  $q$  until there are no more  $a$ -annuli between it and  $q$ . By Lemma 9.3, if that was the case then the number of cells between this  $K_j$ -band and  $q$  is recursively bounded, so we would be able to remove the subroll bounded by the  $K_j$ -band and  $q$  from  $\Delta$ , and then apply Lemma 9.9. Similarly we can treat the case when the base of the roll ends with  $K_j$ .

Suppose that the base of  $\Delta$  starts with  $L_{j-1}L_{j-1}^{-1}K_j$ . Then again by Lemma 9.3  $\Delta_1$  contains an  $a$ -annulus  $\mathcal{C}$  whose inner side label is the outer side label of some  $K_j$ -band. Hence we can do the operation of removing a  $K_j$ -band. As a result of this operation we obtain a roll whose base starts with  $K_j$  (and contains only one occurrence of  $K_j^{\pm 1}$ ), so we reduce the problem to the previous case. Similarly we can argue when the base of  $\Delta$  ends with  $L_jL_j^{-1}$ .

Hence we can assume that the base of  $\Delta$  has the form  $L_{j-1}^{-1}K_jL_j$ . As before, we can assume that the number of  $a$ -annuli in  $\Delta$  between  $p$  and the  $L_j$ -annulus, and between  $q$  and the  $L_{j-1}$ -annulus is big enough (in particular,  $> 1$ ). This implies that the history of the roll cannot contain rules that lock  $L_jP_j$ -sectors. The history of  $\Delta$  cannot contain both rules from  $\mathcal{S}$  and rules from  $\bar{\mathcal{S}}$  because no  $a$ -letters are both of the form  $a_i(L_j)$  and  $\bar{a}(L_j)$ . If the history is a word over  $\mathcal{S}$ , we can apply Lemma 9.17 and move the  $L_j$ -annulus within a recursive distance from  $p$ , and then eliminate this annulus from the diagram reducing the base.

Hence we can assume that the history is a word in  $\bar{\mathcal{S}}$ . Since there exist no  $(\bar{a}, x)$ -relations, every  $a$ -annulus of  $\Delta$  does not contain  $x$ -edges, and the label of the outer side of it consists of  $\theta$ -edges. Hence the lengths of all  $a$ -annuli in  $\Delta$  are bounded by  $|p| + |q|$ . Hence if the number of  $a$ -annuli in  $\Delta$  is big enough, there exist two  $a$ -annuli with the same labels of outer contours. Then we can reduce the number of  $a$ -annuli by removing the one of the two  $a$ -annuli and all cells between them.  $\square$

## 10 Arrangement of hubs

**Lemma 10.1.** *Let a reduced diagram  $\Delta$  has exactly one hub  $\Pi$ . Assume that a  $K_j$ -band  $\mathcal{B}_j$  and a  $K_{j+1}$ -band  $\mathcal{B}_{j+1}$  start on  $\Delta$  for  $j \neq 1$ , and a  $\theta$ -band  $\mathcal{T}$  cross these  $K$ -bands and does not cross any other  $K$ -bands. Assume further that  $\partial\Delta = p(j)q(j)t(j)q'(j)$  where  $p(j)$*

is a subpath of  $\partial\Pi$ ,  $q(j)$  and  $q'(j)$  are top or bottom paths of  $\mathcal{B}_j$  and  $\mathcal{B}_{j+1}$ , respectively, and  $t(j)$  is the top of  $\mathcal{T}$ .

Then one can attach a diagram over  $\mathcal{H}_1$  to  $\Delta$  along  $q'(j)tq(j)$  and obtain a diagram  $\Delta'$  whose perimeter is bounded from above by a linear function of the length of  $\mathcal{T}$ . In addition,  $\phi(\partial\Delta') \equiv \Sigma$  if  $\phi(t(j))_a$  is empty.

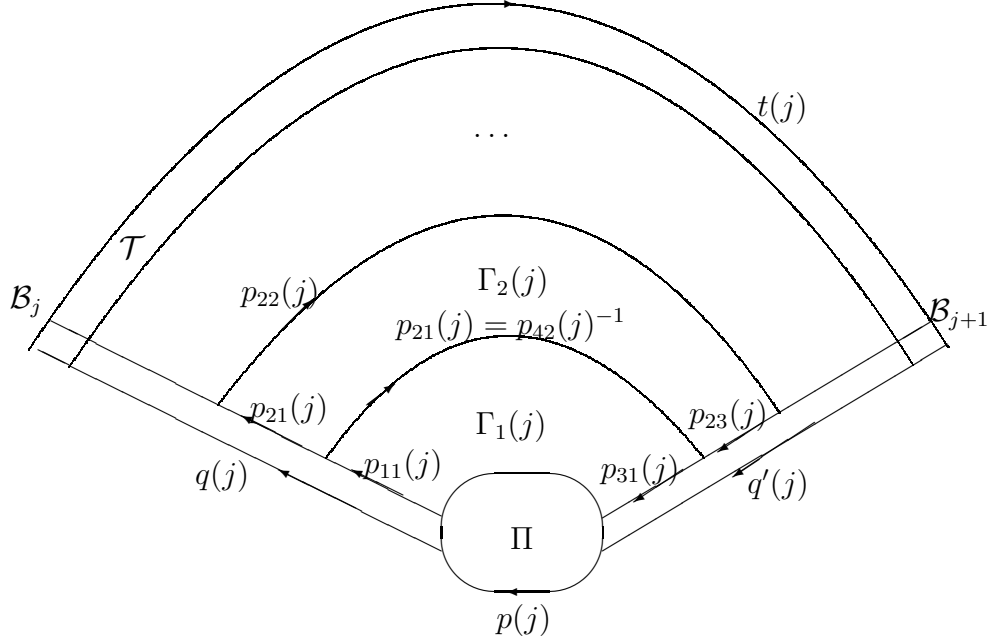

Fig. 33.

*Proof.* Let  $\bar{\Delta}$  be a diagram obtained from  $\Delta$  after deleting of the hub  $\Pi$ . Obviously,  $\bar{\Delta}$  is a trapezium with base  $\overleftarrow{L}_j L_j P_j R_j \overrightarrow{R}_j$ . If we delete  $\mathcal{B}_j$  and  $\mathcal{B}_{j+1}$  from  $\bar{\Delta}$ , we obtain a diagram  $\Gamma(j)$  with contour  $p_{\Gamma(j)} q_{\Gamma(j)} t_{\Gamma(j)} q'_{\Gamma(j)}$  where  $q_{\Gamma(j)}$  ( $q'_{\Gamma(j)}$ ) is a the inner top/bottom of  $\mathcal{B}_j$  (of  $\mathcal{B}_{j+1}$ ),  $p_{\Gamma(j)}$  is a subpath of  $\partial\Pi$  and  $t_{\Gamma(j)}$  is a subpath of  $t(j)$ . Our goal is to construct similar diagrams  $\Gamma(j')$  for other indices  $j'$  so that the labels of  $p_{\Gamma(j')}$ ,  $q_{\Gamma(j')}$  and  $q'_{\Gamma(j')}$  have index  $j'$  and they are the copies of the labels of  $p_{\Gamma(j)}$ ,  $q_{\Gamma(j)}$  and  $q'_{\Gamma(j)}$ , respectively, and  $|t_{\Gamma(j')}| \leq |t_{\Gamma(j)}|$ . Then we can attach every such  $\Gamma(j')$  (or its mirror copy if  $j' - j$  is odd) to  $\Delta$  and insert copies of  $\mathcal{B}_j$  (if  $j' - j$  is even) or of  $\mathcal{B}_{j+1}$  (if  $j' - j$  is odd) between the copies of  $\Gamma(j)$ . Then we obtain the desired diagram  $\Delta'$ .

To construct  $\Gamma(j')$  we subdivide the trapezium  $\bar{\Delta}$  into subtrapezia  $\Delta_1, \Delta_2, \dots$  of the first and the second types by making cuts along the boundaries of the maximal  $\bar{\Theta}$ -bands of  $\bar{\Delta}$  so that the subtrapezia of the first and the second types alternate in  $\bar{\Delta}$ . The same cuts partition  $\Gamma(j)$  into subdiagrams  $\Gamma_1(j), \Gamma_2(j), \dots$ , when counting from  $\Pi$  to  $t$ . The boundary of  $\Gamma_s(j)$  is of the form  $p_{1s}(j)p_{2s}(j)p_{3s}(j)p_{4s}(j)$  where  $p_{2s}(j) = p_{4,s+1}(j)^{-1}$  and the paths  $p_{1s}(j)$  (the paths  $p_{3s}(j)$ ) are subpaths of  $q_{\Gamma(j)}$  (of  $q'_{\Gamma(j)}$ ).

Notice that  $a(\overleftarrow{L}_j)$ -,  $a(L_j)$ - or  $a(R_j)$ -bands of a subtrapezia  $\Delta_s$  of the second type cannot start on the boundary of  $\Delta_s$  because the common letters of  $\mathcal{A}$  and  $\bar{\mathcal{A}}$  belong to  $\cup_j \mathcal{A}(P_j)$ . Hence such bands contain only  $\bar{a}$ -edges, and consequently,  $\Delta_s$  has no  $(a, x)$ -cells.

Since the boundary label of every  $\Gamma_s(j)$  obviously has index  $j$ , we can apply Lemma 3.13 or Lemma 3.14, (depending on the type of trapezia  $\Delta_s$ ) and obtain diagrams  $\Gamma_s(j')$  whose boundaries  $p_{1s}(j')p_{2s}(j')p_{3s}(j')p_{4s}(j')$  are labelled by words having index  $j'$ ; the labels of  $p_{1s}(j')$  and  $p_{3s}(j')$  are copies of the labels of  $p_{1s}(j)$  and  $p_{3s}(j)$ , respectively. The lengths of  $p_{2s}(j')$  and  $p_{4s}(j')$  are not greater of those for index  $j$ , but to construct the desired diagram  $\Gamma(j')$  from  $\Gamma_s(j')$ ,  $s = 1, 2, \dots$  (and from some auxiliary cells) we have to compare the labels of the  $p_{2s}(j')$  and  $p_{4,s+1}(j')$  for  $j' = 1$ . (They are equal for  $j' \neq 1$ .) We will assume that  $s = 1$ , and  $\Delta_1$  is of the first type, because other comparisons are similar.

The word  $\phi(p_{21}(1))$  is the copy of  $V \equiv \phi(p_{21}(j)) \equiv \phi(p_{42}(j)^{-1})$  by the definition of the mapping  $\varepsilon_1$ , and  $\phi(p_{42}(1))$  is obtained from  $V$  by deleting all  $a$ -letters. However, all  $a$ -letters of  $V$  are contained in the subword  $U$  in  $\bar{a}_1, \dots, \bar{a}_m$  written between the  $P_j$ - and the  $R_j$ -letters of  $V$  (see lemma 6.1) because  $\mathcal{A}$  and  $\bar{\mathcal{A}}$  have no other common letters with index  $j$ . We are going to prove that  $U = 1$  modulo  $\mathcal{G}$ -relations. This will allow us to construct an auxiliary intermediate diagram consisting of  $\mathcal{G}$ -cells and having the boundary label  $p_{21}(1)p_{42}(1)$ . Thus the desired diagram  $\Gamma(1)$  will be built from  $\Gamma_1(1), \Gamma_2(1), \dots$  and the intermediate diagrams consisting of  $\mathcal{G}$ -cells.

It remains to show that  $U = 1 \pmod{\mathcal{G}}$ . For this purpose we apply homomorphism  $\delta$  from Lemma 3.1 to the boundary label  $W_1$  of  $\Gamma_1(j)$ . Since the all  $a$ -letters of  $W_1$  occur in the subword  $U$ , we have  $U = 1$  in  $\bar{\mathcal{G}}$ . By Lemma 3.9,  $U = 1$  modulo  $\mathcal{G}$ -relations as desired. (When arguing in this way on a diagram  $\Gamma_s(j)$ ,  $s > 1$ , we have to induct on  $s$  and take into account that, by the inductive hypothesis,  $\delta$  sends the complement of  $U$  in the boundary label  $W_s$  of  $\Gamma_s(j)$  to 1.)

The last statement of the lemma clearly follows from the construction of  $\Delta'$ . □

**Lemma 10.2.** *Assume that a Van Kampen or an annular diagram  $\Delta$  over the group  $\mathcal{H}$  contains two hubs,  $\Pi_1$  and  $\Pi_2$ , and two bands, a  $K_j$ -band  $\mathcal{B}_1$  and a  $K_{j+1}$ -band  $\mathcal{B}_2$  connecting the hubs where  $j \neq 1$ . Suppose that the diagram bounded by the two  $k$ -bands and the boundaries of  $\Pi_1, \Pi_2$  does not contain any other hubs and does not contain the hole of the diagram (in the annular case). Then the diagram  $\Delta$  is not minimal: one can decrease the number of hubs by 2 while preserving the boundary label.*

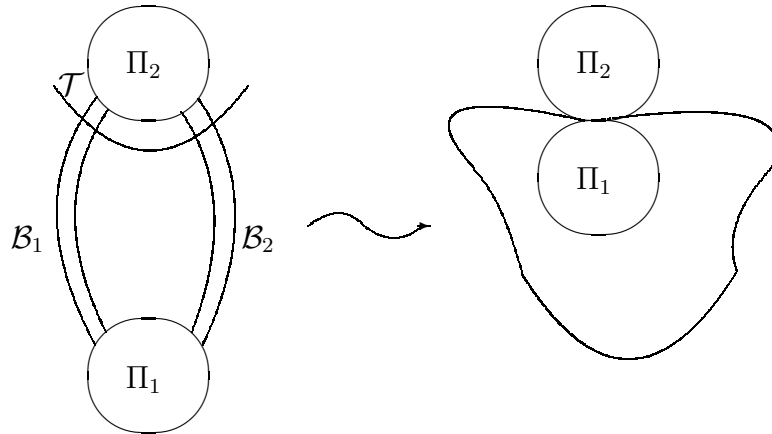

Fig. 34.

*Proof.* We can assume that there are no cells in  $\Delta$  distinct from the hubs, the cells of the two  $k$ -bands, and the cells entirely lying between the two  $k$ -bands. In particular,  $\Delta$  is simply connected. We can assume also that the subdiagram  $\Delta_0$  that consists of the same cells with the exception of the hubs is minimal.

It is clear that  $\Delta_0$  is a trapezium with base  $\overleftarrow{L}_j L_j P_j R_j \overrightarrow{R}_j$  or it has no  $\theta$ -cells. In the last case the  $P_j$ -edges of  $\Pi_1$  and  $\Pi_2$  must coincide. Thus  $\Pi_1$  and  $\Pi_2$  cancel as desired.

Otherwise we consider the nearest  $\theta$ -band  $\mathcal{T}$  to  $\Pi_2$ . Its top has no  $a$ -edges because otherwise an  $a$ -band starting on  $\mathcal{T}$  must end on the hub  $\Pi_2$ , a contradiction. Then we apply Lemma 10.1 to the diagram bounded by  $\Pi_1, \mathcal{B}_1, \mathcal{B}_2$  and  $\mathcal{T}$ . It says the, preserving the boundary label, we can change  $\Delta$  by a subdiagram with two hubs (see the last statement of Lemma 10.1) which have a common  $P_j$ -edge. Then we cancel them as in the first case.  $\square$

We extend the notion of  $l$ -graph as compared with [Ol,97], [SBR], [BORS], [OlSa2], [OlSa1], because here we need such planar graphs not only in a plane but also in an annulus. In the annular case, we have to introduce 2 exterior vertices  $v_0$  and  $v^0$  lying respectively in the outer and in the inner plane components of the complement of the annulus. By definition of  $l$ -graph  $\Gamma$ , each of interior vertices  $v_1, \dots, v_n$  is of degree at least  $l$ , where  $l \geq 6$ ,  $n \geq 1$ , and  $\Gamma$  has neither loops nor 2-gons which both vertices are interior.

As in [Ol2], [SBR], [BORS] one easily obtains the following corollary of the Euler formula for planar graphs.

**Lemma 10.3.** *For every  $l$ -graph  $\Gamma$  there exists an interior vertex  $o$  of degree  $d \geq l$  connected with  $v_0$  by  $d_0$  successive edges (such that there are no vertices of  $\Gamma$  between them) and with  $v^0$  by  $d^0$  successive edges where  $d_0 + d^0 \geq d - 3$ . The number of vertices  $n$  does not exceed the sum of degrees of  $v_0$  and  $v^0$  if  $l \geq 7$ .*

Lemma 10.3 can be applied to the hub graph  $\Gamma(\Delta)$  of a minimal diagram  $\Delta$  which contains hubs. By definition each the interior vertices of  $\Gamma(\Delta)$  are chosen inside all hubs, and the exterior vertex (vertices) are chosen in the connected components of the complement of  $\Delta$  (one vertex per component) on the plane. The medians of all the  $K_j$ -bands of  $\Delta$  ( $j \neq 1$ ) starting on hubs serve as the edges of  $\Gamma(\Delta)$ .

The next Lemma is similar to Lemma 11.4 in [SBR], Lemma 9.4 [Ol2] and Lemma 4.23 in [BORS]. It immediately follows from Lemma 10.2.

**Lemma 10.4.** *If a minimal diagram over  $\mathcal{H}$  contains hubs, then the graph  $\Gamma(\Delta)$  is an  $(N - 1)$ -graph.*

**Lemma 10.5.** *Let  $\Delta$  be an annular diagram over  $\mathcal{H}$  with contours  $p$  and  $p'$  or a van Kampen diagram with contour  $p$ . Assume  $\Delta$  contains a hub  $\Pi$  with the following properties.*

1. *There exists a  $K_j$ -band  $\mathcal{B}$  and a  $K_{j+1}$ -band  $\mathcal{B}'$  connecting  $\partial(\Pi)$  with  $p$ ,  $j \neq 1$ .*
2. *The van Kampen subdiagram  $\Gamma$ , which is bounded by  $p$ ,  $\Pi$  and  $\mathcal{B}, \mathcal{B}'$  and includes  $\mathcal{B}, \mathcal{B}'$  is reduced and contains no hubs.*

*Then the lengths of the closest to  $p$   $\theta$ -band  $\mathcal{T}$  that crosses both  $\mathcal{B}$  and  $\mathcal{B}'$  (if any exists) is  $O(|p|^2)$ , and there is a path  $t$  of length  $O(|p|)$  in  $\Gamma$  connecting the  $P_j$ -edge of  $\mathcal{T}$  (or the  $P_j$ -edge of  $\Pi$  if the  $\theta$ -band  $\mathcal{T}$  does not exist) with  $p$ .*

*Proof.* Let  $\Gamma'$  be the subdiagram of  $\Gamma$  bounded by  $\text{top}(\mathcal{T})$  (or by  $\Pi$  if there is no such  $\mathcal{T}$ ), by  $\mathcal{B}$ ,  $\mathcal{B}'$  and  $p$ . By Lemma 3.11 and by conditions 2,3, all maximal  $\theta$ -band of  $\Gamma'$  must start or end on  $p$ . Hence the number of such bands is at most  $|p|$ . There exist at most  $|p|$  maximal  $k$ -bands in  $\Gamma'$  by Lemma 3.11. Since there exist no  $(k, \theta)$ -annuli by Lemma 3.11, the number of  $(k, \theta)$ -cells in  $\Gamma'$  is  $O(|p|^2)$ . Since  $j \neq 1$ , the band  $\mathcal{T}$  has no  $a(P_1)$ -cells. Hence every maximal  $a$ -band starting on  $\mathcal{T}$  must end on a  $(k, \theta)$ -cell or on  $p$ . Then Lemma 6.1 gives the desired upper bound for the length of  $\mathcal{T}$ .

The maximal  $P_j$ -band  $\mathcal{B}_1$ , that starts on the hub, must end on  $p$  and intersect  $\mathcal{T}$  (if  $\mathcal{T}$  exists). It consists of  $(P_j, \theta)$ -cells only. Since any two of these cells cannot belong to the same  $\theta$ -band (by Lemma 3.11), the length of  $\mathcal{B}_1$  (or of its part belonging to  $\Gamma'$ ) is bounded by the number ( $O(|p|)$ ) of maximal  $\theta$ -bands in  $\Gamma'$ . Hence a subpath of a side of  $\mathcal{B}_1$  is the path  $t$  that connects  $\mathcal{T}$  (or  $\partial(\Pi)$ ) and  $p$  and has length  $O(|p|)$ .  $\square$

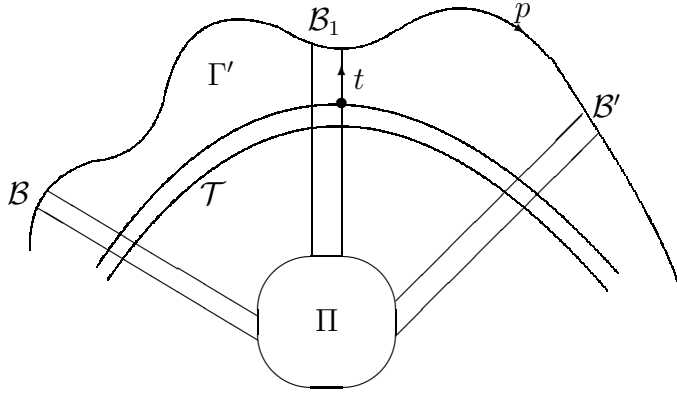

Fig. 35.

**Lemma 10.6.** *Let  $V$  and  $V'$  be two words which are conjugate in the group  $\mathcal{H}$ , and a reduced annular diagram  $\Delta$  for this conjugacy, contains hubs. Then there is a word  $U$  of length  $O((|V| + |V'|)^2)$  such that (a)  $U = 1$  in  $\mathcal{H}$ , and a minimal diagram for this equality contains one hub, (b) a minimal diagram for conjugacy of  $VU$  and  $V'$ , or  $V$  and  $V'U$ , has fewer hubs than  $\Delta$ .*

*Proof.* Let  $p$  and  $p'$  be contours of  $\Delta$  labelled by  $V$  and  $V'$ . Assume  $\Pi$  is a hub given by lemmas 10.3 and 10.4. Since  $N \geq 8$ , the hub is connected with one of contours  $p$ ,  $q$  by a pair of consecutive  $K$ -bands  $\mathcal{B}$  and  $\mathcal{B}'$  which are not  $K_1$ -bands. Without loss of generality, we assume that these two bands ends on  $p$ . Besides, there are no other hubs between these  $k$ -bands. Denote by  $\Gamma$  the subdiagram bounded by  $\Pi$ , by  $p$  and by these two  $k$ -bands.

Let  $\mathcal{T}$  be the closest to  $p$  maximal  $\theta$ -band of  $\Gamma$ . It is of length  $O(|p|^2)$  (if  $\mathcal{T}$  exists) by Lemma 10.6 and the  $P_j$ -edge of  $\mathcal{T}$  (or of  $\Pi$ ) can be connected with  $p$  by a path  $t$  of length  $O(|p|)$ . Lemma 10.1 says that preserving the subdiagram  $\Gamma'$  of  $\Gamma$  which is bounded by  $\mathcal{T}$  and  $p$ , we can insert a number of non-hub cells (and their mirror images) in  $\Delta$ , and obtain a diagram  $\tilde{\Delta}$  (with the same boundary label as  $\Delta$ ) containing a subdiagram  $\Delta'$

which (1) attached to  $\Gamma'$  along the top of  $\mathcal{T}$ ; (2) contains exactly one hub; (3) has linearly bounded perimeter as function of  $|\mathcal{T}|$ , and therefore as function of  $|V|$ , since  $|V| = |p|$ .

Then we consider the path  $t$ , given by Lemma 10.5, and the boundary path  $y$  of  $\Delta'$ . One may suppose that initial vertices of the paths  $y$  and  $t$  coincide. Let  $p_1$  is a cyclic permutation of  $p$ , starting with the terminal vertex of  $t$ . Then the length of the null-homotopic path  $t^{-1}yt$  is  $O(|p|^2)$ , and the path  $p_1ty^{\pm 1}t^{-1}$  bounds an annular diagram with smaller number of hubs than  $\Delta$ . Thus, to prove the lemma, we just denote the label of  $p_0ty^{\pm 1}t^{-1}p_0^{-1}$  by  $U$  where  $p_0$  connects the initial vertices of  $p$  and  $t$ .  $\square$

## 11 The end of the proof

**Lemma 11.1.** *The conjugacy problem is decidable for  $\mathcal{H}_1$ .*

*Proof.* Let  $\Delta$  is any annular diagram over  $\mathcal{H}_1$ . We need to find another diagram with the same boundary labels and recursively bounded number of cells. By Lemma 5.6, we can assume that  $\Delta$  is reduced and has minimal boundaries.

By Lemma 7.30, we can assume that the boundary of  $\Delta$  contains  $\theta$ -edges. Now if  $\partial(\Delta)$  contains no  $k$ -edges then  $\Delta$  is a roll and we can refer to Lemma 9.18. Otherwise  $\Delta$  is a union of a spiral and a recursively bounded number of cells with recursively bounded perimeters (by Lemma 8.4), and we can refer to Lemma 8.6.  $\square$

**Lemma 11.2.** *The conjugacy problem is decidable for  $\mathcal{H}$ .*

*Proof.* It suffices to prove that there is an annular diagram over  $\mathcal{H}$  for the conjugacy of any two given conjugated words  $w_1$  and  $w_2$ , whose number of cells and perimeters of cells are recursively bounded as function of  $|w_1| + |w_2|$ . Consider a minimal annular diagram  $\Delta$  for such a conjugacy. The hub graph  $\Gamma(\Delta)$  is a  $N - 1$  graph by Lemma 10.4. By Lemma 10.3, the number of hubs in  $\Delta$  does not exceed the number of edges of  $\Gamma(\Delta)$ , which are incident with the two exterior vertices of  $\Gamma(\Delta)$  because  $N \geq 8$ , that is, the number of hubs is at most the sum of the lengths of boundary paths  $p$  and  $q$  of  $\Delta$ .

Then Lemma 10.6 reduces the problem to the conjugacy problem for the group  $\mathcal{H}_1$  because the words  $U$  from that lemma are conjugate in  $\mathcal{H}_1$  of the hub. Thus, the statement follows from Lemma 11.1.  $\square$

The next lemma completes the proof of Theorem 1.1

**Lemma 11.3.** *The embedding of  $\mathcal{G}$  into  $\mathcal{H}$  is a Frattini embedding.*

*Proof.* Let  $u, v$  be reduced words over  $a_1(P_1), \dots, a_m(P_1)$  (the generators of the copy of  $\mathcal{G}$  in  $\mathcal{H}$  by Lemma 3.9). Suppose that  $u$  and  $v$  are conjugate in  $\mathcal{H}$ . Consider a minimal conjugacy diagram  $\Delta$  with boundary labels  $u$  and  $v$ . Since  $u$  and  $v$  do not contain  $k$ -letters, by Lemmas 10.3 and 10.4,  $\Delta$  contains no hubs, so  $\Delta$  is a diagram over  $\mathcal{H}_1$ .

Without loss of generality we can assume that there are no  $\mathcal{G}$ -cells which have common edges with the boundary of  $\Delta$ . Indeed, otherwise we can remove these cells, replacing  $u$  (resp.  $v$ ) by words that are conjugates of  $u$  (resp.  $v$ ) in  $\mathcal{G}$ .

Suppose that  $\Delta$  contains  $k$ -edges. Then by Lemma 3.11,  $\Delta$  would contain  $k$ -annuli surrounding the hole of  $\Delta$ . Since the boundary of  $\Delta$  contains no  $\theta$ -edges, the  $k$ -annuli



contain no  $\theta$ -cells by Lemma 3.11. Therefore its boundary label is a word in  $\mathcal{X}$ . By Lemma 3.1 the  $\delta$ -images of  $u$  and  $v$  are trivial in  $\bar{\mathcal{G}}$ . Hence they are trivial in  $\mathcal{G}$  by Lemma 3.9.

Suppose that  $\Delta$  contains  $\theta$ -edges. Then  $\Delta$  contains a  $\theta$ -annulus  $\mathcal{T}$  surrounding the hole of  $\Delta$ . Since  $\Delta$  does not contain  $k$ -edges, all  $\theta$ -edges belong to the same set  $\Theta(z)$  or  $\bar{\Theta}(z)$ . If  $z \neq P_1$  then the  $a$ -bands starting on a side of  $\mathcal{T}$  cannot end on the boundary of  $\Delta$  or on  $\mathcal{G}$ -cells. Therefore they must cross  $\mathcal{T}$  twice, which contradicts Lemma 3.11. Therefore  $z = P_1$ . But then all cells in  $\mathcal{T}$  are commutativity cells corresponding to relations (2.7). Therefore the labels of the sides of  $\mathcal{T}$  coincide and we can remove  $\mathcal{T}$  from  $\Delta$  reducing the number of  $\theta$ -cells in  $\Delta$ . This contradicts to the minimality of  $\Delta$ . Thus  $\Delta$  contains no  $\theta$ -edges.

But this means that there are no cells in  $\Delta$  that have common edges with the contours of  $\Delta$ . Thus  $\Delta$  has no cells, and  $u$  is a cyclic shift of  $v$  (since  $u, v$  are reduced). Hence  $u$  and  $v$  are conjugate in  $\mathcal{G}$ .  $\square$

As we mentioned before, the **proof of Theorem 1.2** proceeds in almost the same way. We need to show that the conjugacy problem in  $\mathcal{H}$  is Turing reducible to the conjugacy problem in  $\mathcal{G}$ . Thus we have to expand the class of recursive functions by the characteristic function of the set of pairs of words  $(u, v)$  which are conjugate in  $\mathcal{G}$  to the set of elementary recursive functions, and then apply the usual operators used to produce all recursive functions [Mal]. Let us call such functions  $\mathcal{G}$ -recursive. For example, the word problem in  $\mathcal{G}$  is  $\mathcal{G}$ -recursive, by Clapham's theorem [Cla] the word problem in  $\bar{\mathcal{G}}$  is also  $\mathcal{G}$ -recursive and so on. The reader can check that all the lemmas in this paper remain true if we replace the word "recursive" in their formulations by " $\mathcal{G}$ -recursive". It is easy to see that this modification turns the proof of Theorem 1.1 into a proof of Theorem 1.2.

## References

- [AC] S. Aanderaa, D.E. Cohen. Modular machines and the Higman-Clapham-Valiev embedding theorem. Word problems, II (Conf. on Decision Problems in Algebra, Oxford, 1976), pp. 17–28, Stud. Logic Foundations Math., 95, North-Holland, Amsterdam-New York, 1980.
- [BORS] J. C. Birget, A.Yu. Ol'shanskii, E.Rips, M. V. Sapir. Isoperimetric functions of groups and computational complexity of the word problem. Annals of Mathematics, 156, 2 (2002), 467-518
- [Bo] W. W. Boone. Certain simple unsolvable problems in group theory . *Proc. Kon. ned. akad. Wetensch. A*, (I) 57 (1954), 231–237, (II) 57 (1954), 492–497, (III) 58 (1955), 252–256, (IV) 58 (1955), 571–577, (V) 60 (1957), 22–27, (VI) 60 (1957), 222–232.
- [Cla] C. R. J. Clapham. An embedding theorem for finitely generated groups", Proc. London. Math. Soc. (3), 17, 1967, 419-430.

- [Col] Donald J. Collins. Conjugacy and the Higman embedding theorem. Word problems, II (Conf. on Decision Problems in Algebra, Oxford, 1976), pp. 81–85, Stud. Logic Foundations Math., 95, North-Holland, Amsterdam-New York, 1980.
- [CM] D. J. Collins, C. F. Miller III. The conjugacy problem and subgroups of finite index. Proc. London Math. Soc. (3) 34 (1977), no. 3, 535–556.
- [FW] N.J.Fine and H.S.Wilf, Uniqueness theorems for periodic functions, Proc. AMS 16 (1965), 109-114
- [GK] A.V. Gorjaga, A.S. Kirkinskiĭ. The decidability of the conjugacy problem cannot be transferred to finite extensions of groups. (Russian) Algebra i Logika 14 (1975), no. 4, 393–406.
- [Hi] G. Higman. Subgroups of finitely presented groups. Proc. Roy. Soc. Ser. A, 262 (1961), 455–475.
- [Kal] K.A. Kalorkoti. Decision problems in group theory. Proc. London Math. Soc. (3) 44 (1982), no. 2, 312–332.
- [KS] O. G. Kharlampovich and M.V. Sapir. Algorithmic problems in varieties. Internat. J. Algebra Comput. 5 (1995), no. 4-5, 379–602.
- [KT] *Kourovka Notebook*. Unsolved Problems in Group Theory. 5th edition, Novosibirsk, 1976.
- [LS] Roger Lyndon and Paul Schupp. *Combinatorial group theory*. Springer-Verlag, 1977.
- [Mak] G. S. Makanin. Equations in a free group. (Russian) Izv. Akad. Nauk SSSR Ser. Mat. 46 (1982), no. 6, 1199–1273, 1344.
- [Mal] A.I. Mal’cev. Algorithms and recursive functions. Translated from the first Russian edition by Leo F. Boron, with the collaboration of Luis E. Sanchis, John Stillwell and Kiyoshi Iski Wolters-Noordhoff Publishing, Groningen 1970.
- [Ma] Yu. I. Manin. The computable and the non-computable. (Vychislimoe i nevychislimoe). (Russian) [B] Kibernetika. Moskva: ”Sovetskoe Radio”.
- [Mil] Charles F. Miller III. On group-theoretic decision problems and their classification. Annals of Mathematics Studies, No. 68. Princeton University Press, Princeton, N.J.; University of Tokyo Press, Tokyo, 1971.
- [Nov] P.S. Novikov, On the algorithmic insolvability of the word problem in group theory. American Mathematical Society Translations, Ser 2, Vol. 9, pp. 1–122
- [OI1] A. Yu. Ol’shanskii. *The geometry of defining relations in groups*, Nauka, Moscow, 1989.
- [OI2] A. Yu. Ol’shanskii. On distortion of subgroups in finitely presented groups. Mat. Sb., 1997, V.188, N 11, 51-98.

- [OISa1] A. Yu. Ol'shanskii, M. V. Sapir. Embeddings of relatively free groups into finitely presented groups. *Contemp. Math.*, 264, 2000, 23-47.
- [OISa2] A.Yu. Ol'shanskii, M. V. Sapir. Length and area functions on groups and quasi-isometric Higman embeddings. *Internat. J. Algebra Comput.* 11 (2001), no. 2, 137–170.
- [OISa3] A.Yu. Olshanskii, M.V. Sapir. Non-amenable finitely presented torsion-by cyclic groups, *Publications of IHES*, # 96, 2002.
- [OISa4] A.Yu. Olshanskii, M.V. Sapir. Word, power, order and conjugacy problems in groups. (in preparation)
- [Rot] J. Rotman. *An Introduction to the Theory of Groups*. Allyn & Bacon, third edition, 1984.
- [SBR] M. V. Sapir, J. C. Birget, E. Rips. Isoperimetric and isodiametric functions of groups, *Annals of Mathematics*, 157, 2 (2002), 345-466.
- [Tho] R. J. Thompson. Embeddings into finitely generated simple groups which preserve the word problem. *Word problems, II* (Conf. on Decision Problems in Algebra, Oxford, 1976), pp. 401–441, *Stud. Logic Foundations Math.*, 95, North-Holland, Amsterdam-New York, 1980.
- [Va] M.K.Valiev. On polynomial reducibility of the word problem under embedding of recursively presented groups in finitely presented groups. *Mathematical foundations of computer science 1975* (Fourth Sympos., Marinsk Lzně, 1975), pp. 432–438. *Lecture Notes in Comput. Sci.*, Vol. 32, Springer, Berlin, 1975.

## Subject index

- Accepted word 68
- Admissible words of an  $S$ -machines 10
- Admissible words of the  $S$ -machine  $\mathcal{S}$  12
- Admissible words of the  $S$ -machines  $\bar{\mathcal{S}}$  and  $\mathcal{S} \cup \bar{\mathcal{S}}$  17
- Age of  $\omega$  56
- Annular (Schupp) diagram 21
- Annulus 28
- Auxiliary relations 19
- Band 27
- $k$ -,  $\theta$ -,  $a$ -bands 27
- Base of a  $\theta$ -band 44
- Base of an admissible word 12
- Base of a computation 55
- Base of a roll 87
- Base of a trapezium 45
- Basic letters 11
- $z$ -best pairing 98
- Bottom path of a band 29
- Bottom path of a trapezium 45
- Boundary of a band 29
- Brief history of a computation 56
- Cancellation pairing 96
- $(a, x)$ -,  $(k, x)$ -,  $(\theta, a)$ -,  $(\theta, k)$ -cell 25
- $\mathcal{G}$ -cell 25
- Compressible diagram 26
- Computation associated with a trapezium 48
- $\mathcal{G}$ -computation 54
- Conditions (R1)-(R4) 41
- Connected pair of parentheses 96
- Connected pair of letters 97
- Contracting (expanding) bands 35
- $\bar{\mathcal{E}}$ -coordinate 12
- $\Omega$ -coordinate 12
- Data associated with a trapezium 45
- $a$ -,  $k$ -,  $\theta$ -,  $x$ -edge (letter, cell) 25
- Empty band 27
- Fractional letters (words) 77
- Fratini embedding 3
- Free computation 54
- Graded presentation 25
- $z$ -good pairing 98
- $l$ -graph 110
- Height of a trapezium 45
- Historical period 56
- History of a computation 55
- History of a roll 87
- History of a trapezium (ring) 46
- Hub 12
- Inner diagram of an annulus 29
- Inner part of a sector 12
- Inverse rule 10
- Locked sectors (by a rule) 13
- $S$ -machine 10
- Main  $k$ -band of a spiral 78
- Main relations 19
- Maximal band 29
- Minimal boundary 43
- Minimal diagram 26
- Minimal word 43
- Minus pair of letters 97
- Minus pairing 97
- Minus word 97
- Normal pair of letters 97
- Operation of moving  $K_j$ -annuli 107
- Operation of removing  $K_j$ -annuli 106
- $(2, 4)$ -pairing 98
- Plus pair of letters 97
- Positive rule 13
- $(2, 4)$ -projection of a word 98
- Quasiring 46
- Quasispiral 79
- Quasitrapezium 46
- Rank of a cell 25
- Reduced computation 53
- Reduced or non-reduced diagram 26
- Reducible pair of cells 26
- $\tau$ -regular word 44
- Related uniform words 34
- $(a, x)$ -,  $(k, x)$ -,  $(\theta, a)$ -,  $(\theta, k)$ -relations 20
- $\mathcal{G}$ -relations 25
- Ring 45
- Ring computation 55
- Roll 86
- $S$ -rule 10
- $S$ -rule active with respect to a sector 18
- $S$ -rule applicable to a word 13

Sector of an admissible word 12	$\overleftarrow{L}_j$ 12
$a$ -similar rules 98	$\overleftarrow{R}_j$ 12
Small trapezium 50	$\Sigma$ 12
Spiral 77	$\tilde{\Sigma}$ 12
Standard computation 57	$\Sigma(w)$ 16
State letters 10	$\Sigma(w_1, w_2, w_3, w_4)$ 22
Tame computation 65	$\tilde{\Sigma}(w_1, w_2, w_3, w_4)$ 22
Tape letters 12	$\Sigma_{r,i}(w_1, w_2, w_3, w_4)$ 22
Top path of a band 29	$\tilde{\Sigma}_{r,i}(w_1, w_2, w_3, w_4)$ 22
Top path of a trapezium 45	$\mathcal{S}(\omega)$ 13
Transition rules 15	$\Theta$ 19
Trapezium 45	$\Theta(\tau)$ 19
Trapezium of the first (second, mixed) type	$\Theta(z)$ 19
49	$\bar{\Theta}$ 20
Type of a diagram 26	<b>top</b> (.) 29
Type of a path 41	$U(r, i)$ 12
Uniform word 34	$\mathcal{X}$ 18
van Kampen diagram 21	$\mathcal{X}(\tau)$ 19
Wild computation 65	$\mathcal{X}(z)$ 19
	$\mathcal{X}(z, \tau)$ 18
	$z_-$ 12
	$z_+$ 12
$\xrightarrow{\ell}$ 13	
$\equiv$ 12	
$\mathcal{A}$ 12	
$\mathcal{A}(z)$ 12	
$\bar{\mathcal{A}}$ 17	
$\alpha_\tau$ 19	
$\beta$ 18	
<b>bot</b> (.) 29	
<b>br</b> (.) 56	
$\delta$ 21	
<b>diff</b> (.) 58	
$\mathcal{E}$ 4	
$\bar{\mathcal{E}}$ 11	
$\mathcal{G}$ 11	
$\bar{\mathcal{G}}$ 11	
$\gamma$ 64	
$\mathcal{H}$ 21	
$\mathcal{H}_0$ 24	
$\mathcal{H}_1$ 25	
$\mathcal{H}_2$ 31	
$\mathcal{K}$ 11	
$\tilde{\mathcal{K}}$ 11	
$\bar{\mathcal{K}}$ 17	
$\tilde{\bar{\mathcal{K}}}$ 17	

Alexander Yu. Ol'shanskii  
Department of Mathematics  
Vanderbilt University  
alexander.olshanskiy@vanderbilt.edu  
and  
Department of Higher Algebra  
MEHMAT  
Moscow State University  
olshan@shabol.math.msu.su

Mark V. Sapir  
Department of Mathematics  
Vanderbilt University  
msapir@math.vanderbilt.edu