

A singularity at the criticality for the free energy in percolation

Dedicated to Harry Kesten for his contributions to percolation theory

Yu Zhang

March 3, 2020

Abstract

Consider percolation on the triangular lattices. Let $\kappa(p)$ be the free energy at the zero field. We show that

$$|\kappa'''(p)| \leq |p - p_c|^{-1/3+o(1)} \text{ if } p \neq p_c.$$

Furthermore, we show that there is a sequence $\epsilon_n \downarrow 0$ such that

$$|\kappa'''(p_c \pm \epsilon_n)| \geq \epsilon_n^{-1/3+o(1)}.$$

The last inequality implies that $\kappa(p)$ is not third differentiable. This answers affirmatively a conjecture, asked by Sykes and Essam in 1964, whether $\kappa(p)$ has a singularity at the criticality.

1 Introduction and statement of results.

Consider site percolation on the triangular lattice. We may realize the triangular lattice with vertex set \mathbf{Z}^2 . For a given $(x, y) \in \mathbf{Z}^2$, its nearest six neighbors are defined as $(x \pm 1, y)$, $(x, y \pm 1)$, $(x + 1, y + 1)$, and $(x - 1, y - 1)$. Edges between neighboring or adjacent vertices therefore correspond to vertical or horizontal displacements of one unit, or diagonal displacements between the two nearest vertices along lines making angles $\pi/4$ and $5\pi/4$ with the positive X -axis. Note that each site is the center of a hexagon in its dual graph. Each site or hexagon is independently *occupied* with probability p and *vacant* with probability $1 - p$. The corresponding probability measure on the configurations of occupied and vacant vertices is denoted by P_p . We also denote by E_p the expectation with respect to P_p . A path from u to v is a sequence $(v_0, \dots, v_i, v_{i+1}, \dots, v_n)$ with adjacent vertices v_i and v_{i+1} or hexagons sharing an edge ($0 \leq i \leq n - 1$) such that $v_0 = u$ and $v_n = v$. A circuit is a path with distinct vertices v_i ($1 \leq i \leq n$) except $v_0 = v_n$. A path is called occupied or vacant if all of its vertices or hexagons are occupied or vacant. The occupied cluster of the vertex x , $\mathbf{C}(x)$, consists of all vertices or hexagons that are connected to x by an occupied path. $\mathbf{C}(x)$ is an empty set if x is vacant. For any collection A of vertices, $|A|$ denotes the cardinality of A . We choose $\mathbf{0}$ as the origin. The *percolation probability* is

$$\theta(p) = P_p(|\mathbf{C}(\mathbf{0})| = \infty),$$

and the critical probability is

$$p_c = \sup\{p : \theta(p) = 0\}.$$

AMS classification: 60K35.

Key words and phrases: percolation, free energy, singularity, power laws, critical exponents.

We may also consider site or bond percolation on a periodic two dimensional lattice (see Kesten (1982) Chapters 1-3 for a precise description of terminology). It has been proved (see chapter 3 in Kesten (1982)) that for site percolation on the triangular lattice

$$p_c = 0.5. \tag{1.1}$$

We denote the cluster distribution by

$$\theta_n(p) = P_p(|\mathbf{C}(\mathbf{0})| = n).$$

By analogy with the Ising model, we introduce the *magnetization function* as

$$M(p, h) = 1 - \sum_{n=0}^{\infty} \theta_n(p) e^{-nh} \text{ for } h \geq 0.$$

By setting $h = 0$ in the magnetization function,

$$M(p, 0) = \theta(p).$$

Using term-by-term differentiation, we also have

$$\lim_{h \rightarrow 0^+} \frac{\partial M(p, h)}{\partial h} = E_p(|\mathbf{C}(\mathbf{0})|; |\mathbf{C}(\mathbf{0})| < \infty) = \chi^f(p).$$

$\chi^f(p)$ is called the *mean cluster size*. The *free energy* $F(p, h)$ is defined by

$$F(p, h) = h(1 - \theta_0(p)) + \sum_{n=1}^{\infty} \frac{1}{n} \theta_n(p) e^{-hn} \text{ for } h > 0.$$

If we differentiate with respect to h , we find

$$\frac{\partial F(p, h)}{\partial h} = M(p, h).$$

For $h > 0$, the free energy is infinitely differentiable with respect to p . The zero-field free energy $F(p, 0)$ is a more interesting subject of study. By our definition,

$$F(p, 0) = E_p(|\mathbf{C}(\mathbf{0})|^{-1}; |\mathbf{C}(\mathbf{0})| > 0). \tag{1.2}$$

Grimmett (1981) discovered that the zero-field free energy also coincides with the *number of clusters per vertex*. Let us define the number of clusters per vertex as follows. Note that any two vertices $x, y \in B(n) = [-n, n]^2$ are said to be connected in $B(n)$ if either $x = y$ or there exists an occupied path γ in $B(n)$ connecting x and y . Let M_n be the number of occupied clusters in $B(n)$. By a standard ergodic theorem (see Theorem 4.2 in Grimmett (1999)), the limit

$$\lim_{n \rightarrow \infty} \frac{1}{|B(n)|} M_n = \kappa(p) \text{ a.s. and } L_1 \tag{1.3}$$

exists for all $0 \leq p \leq 1$. Let $K_n = E_p(M_n)$. Thus,

$$\lim_{n \rightarrow \infty} \frac{1}{|B(n)|} K_n(p) = \kappa(p).$$

$\kappa(p)$ is called the number of clusters per vertex. Grimmett (1981) proved that

$$\kappa(p) = F(p, 0). \tag{1.4}$$

Sykes and Essam were perhaps the first to introduce the number of clusters per vertex in 1964, and they tried to use it to compute p_c . They explored a beautiful geometric argument in their paper to show

$$\kappa(p) - \kappa(1 - p) = p - 3p^2 + 2p^3. \tag{1.5}$$

Sykes and Essam argued that phase transition in percolation must be manifested by a singularity at the critical value p_c . If p_c is indeed the only singularity of $\kappa(p)$, then (1.5) implies that $p_c = 0.5$. For many years, the singularity criterion of Sykes and Essam has offered a tantalizing approach to the famous problem that $p_c = 0.5$. Kesten used another method in 1980 to show that $p_c = 0.5$ (see Kesten (1982)). However, until the present paper, there was no proof of a singularity at p_c for the free energy function.

We would like to mention some progress for $\kappa(p)$ throughout the years. It has been ruled out that $\kappa(p)$ has another singularity on p for $p \neq p_c$. In other words, $\kappa(p)$ is analytic for $p \neq p_c$ (see chapter 9 in Kesten (1982)). On the other hand, it has also been proved (see chapter 9 in Kesten (1982)) that $\kappa(p)$ is twice differentiable at p_c . This tells us that $\kappa(p)$ is a very smooth function. Indeed, the smoothness of $\kappa(p_c)$ might tell us why the singularity at p_c is difficult to prove. The main result obtained here is to understand the behavior of κ at the critical point. If p_c is indeed a singularity of $\kappa(p)$, then it is natural to ask about the behavior of the singularity. Physicists believe that the zero-field free energy is not third differentiable. It is believed that the behavior of percolation functions can be described in terms of critical exponents as p approaches p_c . For $\kappa(p)$, it is conjectured that there exists an exponent α such that

$$\kappa'''(p) \approx |p - p_c|^{-1-\alpha}. \tag{1.6}$$

It is not known how strong one expects such an asymptotic “ \approx ” relation to be, and it is for this reason that we shall use the logarithmic relation. More precisely, $f(p) \approx g(p)$ or $f_n \approx g_n$ means

$$\log g(p) / \log f(p) \rightarrow 1 \text{ or } g(p) = f^{1+o(1)}(p) \text{ as } p \rightarrow p_c, \text{ or } \log f_n / \log g_n \rightarrow 1 \text{ or } f_n = g_n^{1+o(1)} \text{ as } n \rightarrow \infty.$$

The exponent α is called the *heat exponent*, and (1.6) is called the *power law* for the free energy. Numerical computations indicate $\alpha = -2/3$. In addition to this power law, it is also widely believed that the exponents satisfy the following so-called *scaling laws*. To be more specific, we need to introduce all the other critical exponents and power laws. We denote the *correlation length* by

$$\xi^{-1}(p) = \lim_{n \rightarrow \infty} \left\{ -\frac{1}{n} \log P_p(\mathbf{0} \rightarrow \partial B(n), |\mathbf{C}(\mathbf{0})| < \infty) \right\} \text{ if } p \neq p_c,$$

and the *probability on the tail* of $|\mathbf{C}(\mathbf{0})|$ at p_c by

$$\pi(n) = P_{p_c}(n \leq |\mathbf{C}(\mathbf{0})| < \infty),$$

where $\partial B(n)$ is the surface of the box $B(n)$ and $A \rightarrow B$ means that there exists an occupied path from some vertex of A to some vertex of B for any sets A and B .

The power laws are introduced as follows:

$$\theta(p) \approx (p - p_c)^\beta \text{ for } p > p_c,$$

$$\begin{aligned}\chi^f(p) &\approx (p_c - p)^{-\gamma} \text{ for } p \neq p_c, \\ \xi(p) &\approx |p_c - p|^{-\nu} \text{ for } p \neq p_c,\end{aligned}\tag{1.7}$$

$$\pi(n) \approx n^{-1/\rho} \text{ for } n \geq 1,\tag{1.8}$$

$$\kappa'''(p) \approx |p - p_c|^{-1-\alpha} \text{ for } p \neq p_c.\tag{1.9}$$

Numerical computations indicate that

$$\beta = \frac{5}{36}, \gamma = \frac{43}{18}, \nu = \frac{4}{3}, \rho = \frac{91}{5}.$$

In addition to the power laws, it is also widely believed that the exponents satisfy the following so-called scaling laws:

$$\alpha = 2 - 2\nu,\tag{1.10}$$

$$\beta = \frac{2\nu}{\rho + 1},\tag{1.11}$$

$$\gamma = 2\nu \frac{\rho - 1}{\rho + 1}.\tag{1.12}$$

In particular, (1.10) is called a *hyper scaling* relation. Moreover, let us introduce k -arm paths. Consider the annulus

$$A(m, n) = \{B(n) \setminus B(m)\} \cup \{\partial B(m)\} \text{ for } m < n.$$

Let $\mathcal{Q}_k(b, m, n)$ be the event that there exist i disjoint occupied paths and j disjoint vacant paths with $i + j = k$ for all $i, j \geq 1$ from $b + \partial B(m)$ to $b + \partial B(n)$ inside $b + A(m, n)$. We call them k -arm paths. For simplicity, let $\mathcal{Q}_k(m, n) = \mathcal{Q}_k(\mathbf{0}, m, n)$. If $b \in B(n)$, let $\mathcal{Q}_k(b, n)$ be the k -arm paths from b to $\partial B(n)$. Let $\mathcal{Q}_4(n) = \mathcal{Q}_4(\mathbf{0}, n)$ for simplicity. It is believed by Aizenman, Dulpantier, and Alharony (1999) that

$$P_{0.5}(\mathcal{Q}_k(m, n)) = \left(\frac{m}{n}\right)^{(k^2-1)/12+o(1)}\tag{1.13}$$

for fixed m as $n \rightarrow \infty$ and for $k > 1$. In fact, it is more important to show (1.13) when $k = 1$ and $k = 4$. Fortunately, by using the Schramm-Loewner evolution (SLE) argument and Smirnov's scaling limit on the triangular lattice (2001), (1.13) was proved (see Lawler, Schramm, and Werner (2001) and Smirnov and Werner's Theorem 4 (2001)) for $k = 1$ and $k = 4$. More precisely, on the triangular lattice,

$$P_{0.5}(\mathcal{Q}_4(m, n)) = \left(\frac{m}{n}\right)^{5/4+o(1)} \text{ and } P_{0.5}(\mathcal{Q}_1(m, n)) = \left(\frac{m}{n}\right)^{5/48+o(1)}.\tag{1.14}$$

For the other two-dimensional lattices, it has been shown that there exists $\delta > 0$ such that

$$P_{0.5}(\mathcal{Q}_4(m, n)) \leq \left(\frac{m}{n}\right)^{1+\delta} \text{ and } P_{0.5}(\mathcal{Q}_1(m, n)) \leq \left(\frac{m}{n}\right)^\delta.\tag{1.15}$$

In particular, Kesten, Sidoravicius, and Zhang (1998) showed that (1.14) holds for $k = 5$ for all the two-dimensional lattices without using an SLE approach. Indeed, they showed that there exist C_1 and C_2 such that

$$C_1 \left(\frac{m}{n}\right)^2 \leq P_{0.5}(\mathcal{Q}_5(m, n)) \leq C_2 \left(\frac{m}{n}\right)^2.\tag{1.16}$$

In this paper, C and C_i are positive constants independent of n , m , and k and p . They also change from appearance to appearance. We sometimes use $O(n)$ for $C_1 n \leq O(n) \leq C_2 n$. When we need to indicate that C depends on a particular parameter, for example, α , we will write $C = C(\alpha)$.

It is interesting to point out that $(k^2 - 1)/12$ is always a positive integer if $k \geq 5$ is a prime number. However, not only prime number k satisfies that $(k^2 - 1)/12$ is an integer. For example, if $k = 35$, then $(k^2 - 1)/12$ is an integer. It might be easier to show (1.13) when $(k^2 - 1)/12$ is an integer as Kesten, Sidoravicius, and Zhang did in (1.16). Note that if $k \geq 6$, then the critical exponent is larger than 2. Thus, we can barely see the six arm paths in $[-n, n]^2$ for large n . On the other hand, two-arm path and three-arm path power laws in the half space are well understood. Let $\mathcal{H}_k(m, n)$ be the event that there are i -disjoint occupied paths and j disjoint vacant paths in the upper half space with $i + j = k$ from $\partial B(m)$ to $\partial B(n)$ for $i, j \geq 1$. It is believed that

$$P_{0.5}(\mathcal{H}_k(m, n)) = \left(\frac{m}{n}\right)^{k(k+1)/6+o(1)}. \quad (1.17)$$

It has been proved (see Higuchi, Takei, and Zhang (2012)) that (1.17) holds for $k = 2$ and $k = 3$ and for all the two-dimensional lattices. We know that (1.14) together with an argument of Kesten (see Corollaries 1 and 2 in Kesten (1987)) imply that all the power laws and scaling relations hold except possibly for (1.6). Here we will give the following theorem to discuss the power laws concerning for the free energy function.

Theorem. *For percolation on the triangular lattice,*

$$|\kappa'''(p)| \leq |p - p_c|^{-1/3+o(1)} \text{ if } p \neq p_c.$$

Furthermore, we show that there is a sequence $\epsilon_n \downarrow 0$ such that

$$|\kappa'''(p_c \pm \epsilon_n)| \geq \epsilon_n^{-1/3+o(1)}.$$

Remarks. 1. For percolation on the triangular lattice, the last inequality of the Theorem implies that $\kappa(p)$ is not third differentiable. This answers affirmatively a conjecture, asked by Sykes and Essam in 1964, whether $\kappa(p)$ has a singularity at the criticality for the triangular lattice.

2. (1.13) for $k = 4$ was only shown to hold for the triangular lattice. If one can show (1.13) for the other lattices, then the Theorem will work on those lattices. In fact, the topology of the derivatives for $\kappa(p)$ in the site or bond percolation for the square lattice is easy to handle, since there are four neighbors for each vertex rather than six neighbors. We are unable to prove the lower bound in the Theorem for any sequence $\epsilon_n \downarrow 0$.

Acknowledgments. The author would like to thank Harry Kesten for many fruitful conversations, and he would also like to thank Geoffrey Grimmett for his many comments.

2 Preliminaries.

In this section, we introduce a few basic properties and estimates of site percolation in the triangular lattice. Most results are obtained from Kesten (1982) and (1987). For any $u = (u_1, u_2) \in \mathbf{Z}^2$, let $\|u\|$ be

the distance from the origin to u . For $u, v \in \mathbf{Z}^2$, let $d(u, v) = \|u - v\|$. For any two vertex sets A and B , we denote the *distance* of them by

$$d(A, B) = \min_{x \in A, y \in B} \|x - y\|.$$

We can also define the distance of two edge sets if we consider the vertices of them. Given a finite connected graph G , as we defined in section 1, a vertex $u \notin G$ but adjacent to G is called the *boundary vertex* of G . We denote by ∂G the boundary vertices of G . If a vertex $v \in \partial G$, and there is an infinite path from v without using G , then v is called the *exterior boundary* vertex. We denote by ΔG all the exterior boundary vertices of G . We introduce a topology result (see Lemma 2.23 in Kesten (1982) or Proposition 11.2 in Grimmett (1999)).

Lemma 2.1. *If G is a finite cluster, then $\Delta(G)$ is a circuit containing G in its interior. Furthermore, $\Delta(G)$ is the smallest vacant circuit containing G in its interior if G is occupied.*

Now we define occupied and vacant crossings in a box. A left-right (respectively, top-bottom) occupied crossing of $B(n)$ is an occupied path in $B(n)$ that joins some vertex on the left (respectively upper) side of $B(n)$ to some vertex on the right (respectively lower) side of $B(n)$ but uses no vertices in the boundary of $B(n)$. Similarly, we may define a vacant crossing on $B(n)$. We denote the occupied and the vacant crossing probabilities of $B(n)$ by

$$\begin{aligned} \sigma(p, n) &= P_p(\exists \text{ a left-right occupied crossing of } B(n)) \text{ and} \\ \sigma^*(p, n) &= P_p(\exists \text{ a top-bottom vacant crossing of } B(n)). \end{aligned}$$

We need to show that the vacant crossing and occupied crossing probabilities of squares are bounded away from zero when p is near p_c . To make this precise, we first define (see (1.21) in Kesten (1987))

$$L(p) = \min\{n : \sigma(p, n) \geq 1 - \epsilon_0\} \text{ for } p > p_c \text{ and } L(p) = \min\{n : \sigma^*(p, n) \geq \epsilon_0\} \text{ for } p < p_c, \quad (2.1)$$

where ϵ_0 is some small but strictly positive number whose precise value is not important. The important property is that ϵ_0 can be chosen such that there exists a constant δ for which

$$\sigma(p, n) \geq \delta \text{ and } \sigma^*(p, n) \geq \delta$$

uniformly in $n \leq L(p)$. $L(p)$ is also called the correlation length, and it is proved (see Corollary 2 in Kesten (1987)) that

$$L(p) \asymp \xi(p), \quad (2.2)$$

where $f(p) \asymp g(p)$ or $f_n \asymp g_n$ means

$$f(p)/g(p) = O(1) \text{ and } f_n/g_n = O(1).$$

By (1.14) and Kesten's Corollaries 1 and 2, for all $p \neq 0.5$,

$$L(p) \asymp \xi(p) \approx |0.5 - p|^{-4/3}. \quad (2.3)$$

On the other hand, it is known (see chapter 11 in Grimmett (1999)) that for any n there exists $C > 0$ such that

$$\sigma(0.5, n) \asymp \sigma^*(0.5, n) \asymp C.$$

If $p \neq 0.5$ and $n \leq L(p)$, Kesten's Theorem 1 and Lemma 8 (1987) show that $P_p(\mathcal{Q}_l(n))$ has the same decay rate as $P_{0.5}(\mathcal{Q}_l(n))$ for $l = 1$ and $l = 4$. We want to remark that two occupied paths are separated by two vacant paths in the four arm paths of $\mathcal{Q}_4(n)$ in Kesten's Theorem 1 and Lemma 8 (1987). In other words, if we remove the origin, there is no occupied path connecting two occupied paths in $\mathcal{Q}_4(n)$. Later, we always consider these four arm paths. Together with his Lemmas 4 and 7 (1987), it shows that $P_p(\mathcal{Q}_l(m, n))$ has the same decay rate as $P_{0.5}(\mathcal{Q}_l(m, n))$ for $l = 1$ and $l = 4$. Here we summarize his results as the following Lemma.

Lemma 2.2 (Kesten (1987)). *If $m \leq n \leq L(p)$,*

$$P_p(\mathcal{Q}_1(m, n)) \asymp P_{0.5}(\mathcal{Q}_1(m, n)) \text{ and } P_p(\mathcal{Q}_4(m, n)) \asymp P_{0.5}(\mathcal{Q}_4(m, n)).$$

It is well known that the size of an occupied cluster decays exponentially (see Theorem 6.10 in Grimmett (1999)) when $p < p_c$:

$$C_1 n^{-1} \exp(-\xi^{-1}(p)n) \leq P_p(\mathbf{0} \rightarrow \partial B(n)) \leq C_2 n \exp(-\xi^{-1}(p)n).$$

By using (2.1) and (2.2), we obtain the following better estimate.

Lemma 2.3. *If $p < p_c$, then there exist C_i for $i = 1, 2$ such that for any $n \geq L(p)$,*

$$C_1 \frac{L(p)}{n} \exp(-L^{-1}(p)n) \leq P_p(\mathbf{0} \rightarrow \partial B(n)) \leq C_2 \frac{n}{L(p)} \exp(-L^{-1}(p)n).$$

Proof. Let $\beta(n) = P_p(\mathbf{0} \rightarrow \partial B(n))$. For $m \geq L(p)$, we may divide the parameter of $\partial B(m)$ into $m/L(p)$ segments such that each one has a length $L(p)$. For each segment, by using (2.1) and the RSW lemma, there is an occupied circuit surrounding it with a positive probability. Then we use the exact proof of (6.21) in Grimmett (1999) to show

$$\beta(n+m) \leq C_1(m/L(p))\beta(m)\beta(n). \tag{2.4}$$

The same method, together with (6.27) in Grimmett (1999), implies that

$$\beta(n+m) \geq C_2(L(p)/m)\beta(m)\beta(n). \tag{2.5}$$

So together with (2.2), Lemma 2.3 follows from (2.4),(2.5), and the same proof of Theorem 5.10 in Grimmett (1999). \square

By Lemmas 2.2 and 2.4, if $p \leq 0.5$, for all $m < n$,

$$P_p(\mathcal{Q}_4(m, n)) \leq \left(\frac{m}{n}\right)^{5/4+o(1)}. \tag{2.6}$$

By (2.24) in Kesten (1987), we have for a large M ,

$$P_p(B(L(p)) \rightarrow \partial B(ML(p))) \leq C \exp(-C_1 M). \tag{2.7}$$

By using (2.7), we have the following lemma.

Lemma 2.4. *If $p < 0.5$, for $m \geq 1$,*

$$\sum_{i \geq mL(p)} i P_p(B(L(p)) \rightarrow \partial B(i)) \leq CL^2(p) \exp(-C_1 m).$$

Proof. By (2.7),

$$\begin{aligned} \sum_{i \geq mL(p)} i P_p(B(L(p)) \rightarrow \partial B(i)) &\leq \sum_{k=m}^{\infty} \sum_{kL(p) \leq i \leq (k+1)L(p)} i P_p(B(L(p)) \rightarrow \partial B(i)) \\ &\leq 4CL^2(p) \sum_{k=m}^{\infty} (k+1)^2 \exp(-C_1 k) \leq C_2 L^2(p) m^2 \exp(-C_1 m) \leq C_2 L^2(p) \exp(-C_3 m). \end{aligned}$$

Lemma 2.4 follows. \square

Kesten in his Lemma 8 (1987) showed the following estimate:

$$L^2(p) P_p(\mathcal{Q}_4(L(p))) \asymp (0.5 - p)^{-1}. \quad (2.8)$$

For convenience, we reselect $L(p)$ such that

$$L^2(p) P_p(\mathcal{Q}_4(L(p))) = (0.5 - p)^{-1}. \quad (2.9)$$

In the following sections, we always assume that (2.9) holds for $L(p)$. Given four-arm paths in a square $B(n)$ and four-arm paths in an annulus $A(n, m)$ for $n < m$, one of major estimates (see Lemma 4 and Lemma 6 in Kesten (1987)) is to reconnect them by costing a constant probability independent of n and m . It is a more general argument than the RSW lemma since the RSW only reconnects the occupied or vacant paths. This connection is called the *reconnection lemma*.

Reconnection lemma. (Kesten (1987)). *If $n \leq L(p)$ and $n \leq m$ for $p \leq 0.5$, there exists C (independent of n, m) such that*

$$P_p(\mathcal{Q}_4(n)) P_p(\mathcal{Q}_4(n, m)) \leq C P_p(\mathcal{Q}_4(m)).$$

Remark 3. The original proof of the reconnection lemma in Kesten's paper is involved and long. However, if we use the later developed three arm path estimate in (1.17), we should have an easier proof (see Morrow and Zhang (2005)).

Another lemma (see Kesten's Lemma 7 (2.58) (1987)) as the following lemma is useful when we estimate the pivotal vertices in a square box.

Lemma 2.6. (Kesten (1987)). *For $p < 0.5$ and for j with $2^{j+1} \leq 2^k \leq L(p)$, there exists $\xi > 0$ (independent of p) such that*

$$2^{2j} P_p(\mathcal{Q}_4(2^j)) \asymp \sum_{b \in B(2^{j-1})} P_p(\mathcal{Q}_4(b, B(2^j))) \leq C(0.5 - p)^{-1} 2^{-\xi(k-j)}.$$

With Lemma 2.4 and Lemma 2.6, we have the following lemma.

Lemma 2.7. *If $p < 0.5$, there exists C (independent of p) such that*

$$\sum_{j=1}^{\infty} jP_p(Q_4(j)) \leq C(0.5 - p)^{-1}.$$

Furthermore, if $p < 0.5$, there exists C_i for $i = 1, 2$ (independent of m and p) such that

$$\sum_{j \geq mL(p)}^{\infty} jP_p(Q_4(j)) \leq C_1 e^{-C_2 m} (0.5 - p)^{-1}.$$

3 Derivative of $K_n(p)$ by finding its pivotal sites.

The derivative of $K_n(p)$ in the triangular lattice is much more complicated than the derivative in the square lattice (see Zhang (2011)) since each vertex has six neighbors. Let us define for $v \in B(n)$, $N_n(v)$ as the number of distinct occupied clusters in $B(n)$, obtained after setting v to be vacant, which contains a neighbor of v . It follows from (5.5) in Aizenman, Kesten, and Newman (1987) or Theorem 4.3 in Grimmett (1981) that

$$\frac{dK_n(p)}{dp} = \sum_{v \in B(n)} E_p(1 - N_n(v)). \quad (3.1)$$

Note that there is no infinite occupied cluster in $[0, 0.5]$, so by (3.1) and a standard ergodic theorem (see Dunford and Schwartz Theorem VIII 6.9 (1958)),

$$\kappa'(p) = \lim_{n \rightarrow \infty} |B(n)|^{-1} \frac{dK_n(p)}{dp} = 1 - \lim_{n \rightarrow \infty} E_p(N_n(\mathbf{0})). \quad (3.2)$$

Note also that $N_n(\mathbf{0})$ is neither increasing nor decreasing, so to take another derivative, we simply need to fix the configurations of vertices adjacent to the origin. There are six vertices, denoted by b_i for $i = 1, 2, 3, 4, 5, 6$, adjacent to the origin. We will try to fix the configurations of these six vertices. Let \mathcal{E} be the event that there are at least two occupied vertices in $\{b_1, b_2, b_3, b_4, b_5, b_6\}$, and they are separated by vacant vertices. For example, b_1 and b_3 are occupied and the others are vacant. On \mathcal{E}^C , $N_n(\mathbf{0})$ (either zero or one) does not depend on the configurations outside of $\{\mathbf{0}, b_1, b_2, b_3, b_4, b_5, b_6\}$. We may divide \mathcal{E}^C into \mathcal{E}_0^C or \mathcal{E}_1^C : all $\{b_1, b_2, b_3, b_4, b_5, b_6\}$ are vacant or only one connected occupied cluster is among them, respectively. Thus,

$$E_p(N_n(\mathbf{0}); \mathcal{E}^C) = P_p(\mathcal{E}_1^C) = f(p) \quad (3.3)$$

for a polynomial $f(p)$ with a degree not more than 6.

We divide \mathcal{E} into a few disjoint configurations. We denote by \mathcal{E}_{AB} the event, for $A, B \subset \{b_1, b_2, b_3, b_4, b_5, b_6\}$, that A and B are occupied vertex sets separated by two vacant vertex sets A' and B' in $\{b_1, b_2, b_3, b_4, b_5, b_6\}$. In addition, A, B, A', B' are adjacent individually in vertices $\{b_1, b_2, b_3, b_4, b_5, b_6\}$. For example, $A = \{b_1\}$, $A' = \{b_2, b_3\}$, $B = \{b_4, b_5\}$, and $B' = \{b_6\}$. We also denote by $\mathcal{E}_{1,3,5}$ or $\mathcal{E}_{2,4,6}$ the events that b_1, b_3 , and

b_5 , or b_2 , b_4 , and b_6 are occupied and the others are vacant, respectively. Thus, by (3.3) and symmetry,

$$\begin{aligned}
& E_p(N_n(\mathbf{0})) \\
= & \sum_{A,B} E_p(N_n(\mathbf{0}) \mid \mathcal{E}_{AB}) f_{AB}(p) + E_p(N_n(\mathbf{0}) \mid \mathcal{E}_{1,3,5}) f_{1,3,5}(p) + E_p(N_n(\mathbf{0}) \mid \mathcal{E}_{2,4,6}) f_{2,4,6}(p) + f(p) \\
= & \sum_{A,B} E_p(N_n(\mathbf{0}) \mid \mathcal{E}_{AB}) f_{AB}(p) + 2E_p(N_n(\mathbf{0}) \mid \mathcal{E}_{1,3,5}) f_{1,3,5}(p) + f(p),
\end{aligned}$$

where the first sum takes all possible A and B and $f_{AB}(p) = P_p(\mathcal{E}_{AB})$, $f_{1,3,5}(p) = P_p(\mathcal{E}_{1,3,5})$, and $f_{2,4,6}(p) = P_p(\mathcal{E}_{2,4,6})$ are polynomials with degrees less than 6. Therefore,

$$\begin{aligned}
\frac{dE_p(N_n(\mathbf{0}))}{dp} &= \sum_{A,B} \frac{dE_p(N_n(\mathbf{0}) \mid \mathcal{E}_{AB})}{dp} f_{AB}(p) + \sum_{A,B} E_p(N_n(\mathbf{0}) \mid \mathcal{E}_{AB}) f'_{AB}(p) \\
&+ 2 \frac{dE_p(N_n(\mathbf{0}) \mid \mathcal{E}_{1,3,5})}{dp} f_{1,3,5}(p) + 2E_p(N_n(\mathbf{0}) \mid \mathcal{E}_{1,3,5}) f'_{1,3,5}(p) + f'(p). \tag{3.4}
\end{aligned}$$

After taking this derivative, the first sum and the third term in the right side of (3.4) play the most important roles. Let us focus on a term in the first sum in the right side of (3.4): $dE_p(N_n(\mathbf{0}) \mid \mathcal{E}_{AB})/dp$ for fixed sets A and B . Note that

$$E_p(N_n(\mathbf{0}) \mid \mathcal{E}_{AB}) = P_p(N_n(\mathbf{0}) \geq 2 \mid \mathcal{E}_{AB}) + P_p(N_n(\mathbf{0}) \geq 1 \mid \mathcal{E}_{AB}) = P_p(N_n(\mathbf{0}) = 2 \mid \mathcal{E}_{AB}) + 1$$

and $\{N_n(\mathbf{0}) \geq 2 \mid \mathcal{E}_{AB}\} = \{N_n(\mathbf{0}) = 2 \mid \mathcal{E}_{AB}\}$ is a decreasing event for the configurations on $B(n)$ except for the origin and its neighbors. By Russo's formula, if $\{N_n(\mathbf{0}) = 2 \mid \mathcal{E}_{AB}\}(b)$ is the event that b is a pivotal vertex (see Fig. 1.1 and the definition for a pivotal vertex in Kesten (1982)), then

$$\begin{aligned}
\frac{dE_p(N_n(\mathbf{0}) \mid \mathcal{E}_{AB})}{dp} &= - \sum_{b \in B(n), b \not\sim \mathbf{0}} P_p(\{N_n(\mathbf{0}) = 2 \mid \mathcal{E}_{AB}\}(b)) \\
= & - \sum_{b \in B(n), b \not\sim \mathbf{0}} P_p(\{N_n(\mathbf{0}) = 1 \text{ or } 2 \text{ if } b \text{ is occupied or vacant}\} \mid \mathcal{E}_{AB}), \tag{3.5}
\end{aligned}$$

where $b \not\sim \mathbf{0}$ means that $b \neq \mathbf{0}$ is not adjacent to $\mathbf{0}$. Let $\mathbf{C}_n(A)$ be the occupied cluster by assuming A is occupied in $B(n) \setminus \{\mathbf{0}\}$ on \mathcal{E}_{AB} , and let $\Delta \mathbf{C}_n(A)$ be the sites of the exterior boundary of $\mathbf{C}_n(A)$. We can rewrite $\{N_n(\mathbf{0}) = 1 \text{ or } 2 \text{ if } b \text{ is occupied or vacant} \mid \mathcal{E}_{AB}\}$ as

$$\mathcal{D}_{AB}(b, n) = \{\mathbf{C}_n(A) \cap \mathbf{C}_n(B) = \emptyset, b \in \Delta \mathbf{C}_n(A) \cap \Delta \mathbf{C}_n(B)\}. \tag{3.6}$$

Now we need to write $\mathcal{D}_{AB}(b, n)$ into occupied and vacant paths. Let (see Fig. 1.5 and Fig. 1.6)

$$\begin{aligned}
& \bar{\mathcal{R}}_{AB}(b, n) = \\
& \{\exists \text{ disjoint occupied paths } r_2 \text{ and } r_4 \text{ in } B(n) \setminus \mathbf{0} \text{ from } A \text{ and } B \text{ to two neighbors of } b; \\
& \quad \exists \text{ a vacant } r_3 \text{ on } B(n) \setminus \mathbf{0} \text{ inside } S(r_2, r_4, b) \text{ from } A' \text{ or } B' \text{ to a neighbor of } b; \exists \text{ a vacant path } \\
& \quad r_1 \text{ inside } B(n) \setminus \mathbf{0} \text{ from } B' \text{ or } A' \text{ to a neighbor of } b \text{ but outside the closure of } S(r_2, r_4, b) \text{ or} \\
& \quad \exists \text{ disjoint vacant paths } r_5 \text{ and } r_6 \text{ inside } B(n) \setminus \mathbf{0} \text{ from } B' \text{ and from a neighbor of } b \text{ to } \partial B(n), \\
& \quad \text{but outside the closure of } S(r_2, r_4, b), \text{ and } \exists \text{ an occupied path from } r_2 \text{ or } r_4 \text{ to } \partial B(n)\},
\end{aligned}$$

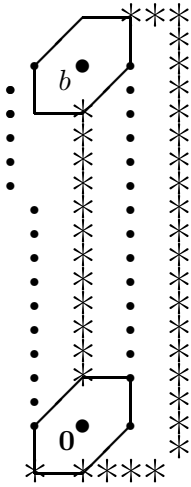

Fig. 1.1

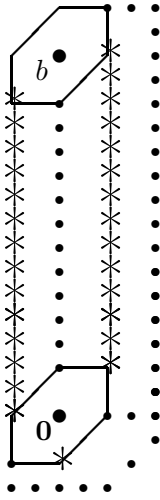

Fig. 1.2

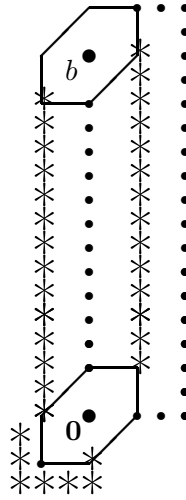

Fig. 1.3

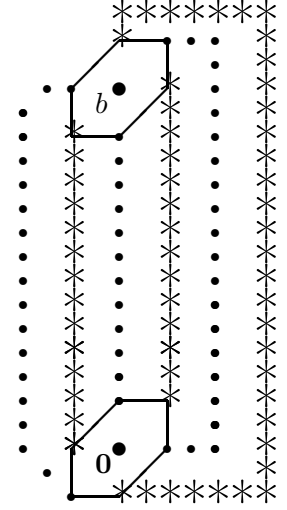

Fig. 1.4

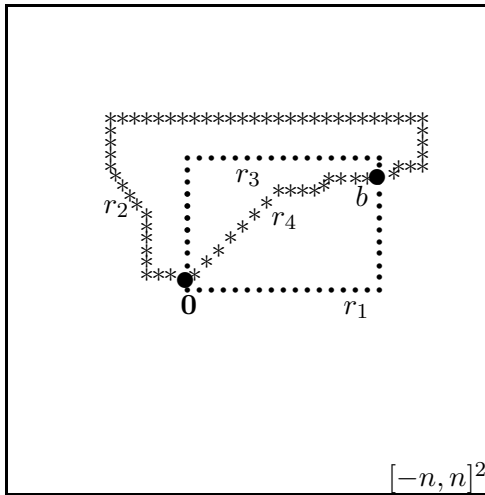

Fig. 1.5

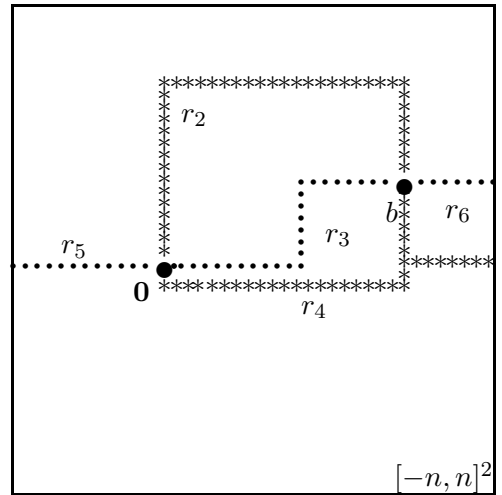

Fig. 1.6

Figure 1: Fig. 1.5 is event $\mathcal{R}(b, n)$. Fig. 1.5 and Fig. 1.6 are the two situations of $\bar{\mathcal{R}}(b, n)$. In Fig. 1.6, since r_1 does not exist, we have an occupied path separating r_5 and r_6 . Fig. 1.1 shows that b is a pivotal vertex for $P_p(N(\mathbf{0}) = 2 \mid \mathcal{E}_{AB})$. Fig. 1.2 and Fig. 1.4 show that b is a pivotal vertex for $P_p(N(\mathbf{0}) = 3 \mid \mathcal{E}_{1,3,5})$. Figs. 1.2, 1.3, and Fig. 1.4 show that b is a pivotal vertex for $P_p(N(\mathbf{0}) \geq 2 \mid \mathcal{E}_{1,3,5})$. The solid dotted-paths are vacant, and the $*$ -paths are occupied.

where $S(r_2, r_4, b)$ is the open set enclosed by the circuit $r_2 \cup \mathbf{0} \cup r_4 \cup b$ and a path from A means the path starting from a neighbor of A .

A pivotal vertex for a positive or a negative event related to four-arm paths around the pivotal vertex is well understood (see Lemma 8 in Kesten (1987)). The following lemma is a pure topology argument to tell the relation between the right side of (3.5) and the occupied and vacant paths in $\bar{\mathcal{R}}_{AB}(b, n)$. It is easy to be convinced by graphs (see Figs. 1.1–1.6), but it is tedious to show it. So we omit the proof.

Lemma 3.1. *For a fixed disjoint A and B in $\{b_1, b_2, b_3, b_4, b_5, b_6\}$ and $b \not\sim \mathbf{0}$,*

$$\{N_n(\mathbf{0}) = 1 \text{ or } 2 \text{ if } b \text{ is occupied or vacant} \mid \mathcal{E}_{AB}\} = \bar{\mathcal{R}}_{AB}(b, n).$$

Let

$$P_{p,AB}(\cdot) = P_p(\cdot \mid \mathcal{E}_{AB}) \text{ and } P_{p,1,3,5}(\cdot) = P_p(\cdot \mid \mathcal{E}_{1,3,5}).$$

Note that $\bar{\mathcal{R}}_{AB}(b, n)$ does not depend on the configurations of $\mathbf{0}$, A , A' , B , and B' , so it follows from Lemma 3.1 that

$$\frac{dE_p(N_n(\mathbf{0}) \mid \mathcal{E}_{AB})}{dp} = - \sum_{b \in B(n), b \not\sim \mathbf{0}} P_{p,AB}(\bar{\mathcal{R}}_{AB}(b, n)) = - \sum_{b \in B(n), b \not\sim \mathbf{0}} P_p(\bar{\mathcal{R}}_{AB}(b, n)). \quad (3.7)$$

When we estimate the upper bound of the third derivative of $\kappa(p)$, we only need to deal with the following simpler event (see Fig. 1.1 and Fig. 1.5). For fixed vertex b inside $B(n)$, let

$$\begin{aligned} \mathcal{R}_{AB}(b, n) = & \\ & \{\exists \text{ disjoint occupied paths } r_2 \text{ and } r_4 \text{ in } B(n) \text{ from } A \text{ and } B \text{ to two neighbors of } b; \\ & \exists \text{ a vacant path } r_3 \text{ on } B(n) \text{ inside } S(r_2, r_4, b) \text{ from } A' \text{ or } B' \text{ to a neighbor of } b; \\ & \exists \text{ path } r_1 \text{ inside } B(n) \text{ from } B' \text{ or } A' \text{ to a neighbor of } b \text{ but outside the closure of } S(r_2, r_4, b)\}. \end{aligned}$$

For each n , let

$$R_{AB}(p, n) = \sum_{b \in B(n), b \not\sim \mathbf{0}} P_p(\mathcal{R}_{AB}(b, n)).$$

Since there is no infinite occupied cluster, the existence of an occupied path from the origin to $\partial B(n)$ is unlikely to occur. In other words, we can use $\mathcal{R}_{AB}(b, n)$ to replace $\bar{\mathcal{R}}_{AB}(b, n)$ without losing too much. We may also consider $\mathcal{R}_{AB}(b, \infty)$ if all the paths in $\mathcal{R}_{AB}(b, n)$ are in \mathbf{Z}^2 . More precisely, we show the following lemma.

Lemma 3.2. *For each A and B , $\frac{dE_p(N_n(\mathbf{0}) \mid \mathcal{E}_{AB})}{dp}$ and $R_{AB}(p, n)$ converge uniformly on $[0, 0.5]$ such that*

$$- \lim_{n \rightarrow \infty} \frac{dE_p(N_n(\mathbf{0}) \mid \mathcal{E}_{AB})}{dp} = \lim_{n \rightarrow \infty} R_{AB}(p, n). \quad (3.8)$$

Furthermore, if $p_0 < 0.5$, for $i \geq 2$

$$- \lim_{n \rightarrow \infty} \frac{d^i E_p(N_n(\mathbf{0}) \mid \mathcal{E}_{AB})}{dp^i} = \lim_{n \rightarrow \infty} \frac{d^{i-1} R_{AB}(p, n)}{dp^{i-1}} \text{ converges uniformly on } [0, p_0]. \quad (3.9)$$

Proof. We first show that $\sum_{b \in B(n), b \neq \mathbf{0}} P_p(\bar{\mathcal{R}}_n(b, n))$ converges uniformly on $[0, 0.5]$. For each A and B ,

$$\begin{aligned} \sum_{b \in B(n), b \neq \mathbf{0}} P_p(\bar{\mathcal{R}}_{AB}(b, n)) &\leq \sum_{i=1}^{n+1} \sum_{\substack{b \in B(n), \\ \|b\|=i}} P_p(\bar{\mathcal{R}}_{AB}(b, n)) \\ &= \sum_{i=1}^{n/2} \sum_{\substack{b \in B(n), \\ \|b\|=i}} P_p(\bar{\mathcal{R}}_{AB}(b, n)) + \sum_{i=n/2}^{n+1} \sum_{\substack{b \in B(n), \\ \|b\|=i}} P_p(\bar{\mathcal{R}}_{AB}(b, n)). \end{aligned}$$

We denote by I and II the two sums above. We estimate I first. By the definition of $\bar{\mathcal{R}}_{AB}(b, n)$, we know that if $\{\bar{\mathcal{R}}_{AB}(b, n)\}$ occurs for $i \leq n/2$, then $\mathcal{Q}_4(\mathbf{0}, 2, i/4)$ and $\mathcal{Q}_4(b, 0, i/4)$ occur independently (see Figs. 1.5 and 1.6). By (2.6), note that there are at most Ci choices for b when $\|b\| = i$, so

$$I = \sum_{i=1}^{n/2} \sum_{\substack{b \in B(n), \\ \|b\|=i}} P_p(\bar{\mathcal{R}}_{AB}(b, n)) \leq C \sum_{i=1}^{n/2} ii^{-5/2+o(1)}. \quad (3.10)$$

Therefore, I converges uniformly on $[0, 0.5]$. Now we estimate II . If $\{\bar{\mathcal{R}}_{AB}(b, n)\}$ occurs for $n \geq i \geq n/2$, then $\mathcal{Q}_4(\mathbf{0}, 2, n/4)$ and $\mathcal{Q}_4(b, 0, (n-i)/4)$ occur independently. By (2.6),

$$II \leq \sum_{i=n/2}^n \sum_{\substack{b \in B(n), \\ \|b\|=i}} P_p(\bar{\mathcal{R}}_{AB}(b, n)) \leq \sum_{i=n/2}^n nCn^{-5/4+o(1)}(n-i)^{-5/4+o(1)}. \quad (3.11)$$

Thus, by using the integral test, II goes to zero as $n \rightarrow \infty$ uniformly on $[0, 0.5]$. Therefore, by (3.7) and the estimates for I and II above,

$$\frac{dE_p(N_n(\mathbf{0}) \mid \mathcal{E}_{AB})}{dp} \text{ converges uniformly on } [0, 0.5]. \quad (3.12)$$

Note that for $p \leq 0.5$ and a fixed b ,

$$R_{AB}(p, n) \leq \sum_{b \in B(n), b \neq \mathbf{0}} P_p(\bar{\mathcal{R}}_{AB}(b, n)) \text{ and } \lim_{n \rightarrow \infty} P_p(\mathcal{R}_{AB}(b, n)) = \lim_{n \rightarrow \infty} P_p(\bar{\mathcal{R}}_{AB}(b, n)), \quad (3.13)$$

so for A and B , by (3.7) and the estimates for I and II above, $R_{AB}(p, n)$ converges uniformly and (3.8) holds.

It remains to show (3.9). For a finite n , $R_{AB}(p, n)$ is i -th differentiable for any $i \geq 1$ and $p \leq p_0 < 0.5$. By the definition of $\mathcal{R}_{AB}(b, n)$, on $\mathcal{R}_{AB}(b, n)$, there is an occupied path from A to b . By Lemma 2.3 and the same proof of (6.108) in Grimmett (1999),

$$\frac{d^{i-1} \sum_{b \in B(n)} P_p(\mathcal{R}_{AB}(b, n))}{dp^{i-1}} \text{ converges uniformly on } [0, p_0]. \quad (3.14)$$

By (3.14), $R_{AB}^{(i-1)}(p, n)$ converges uniformly on $[0, p_0]$ for $p \leq p_0 < 0.5$ and for $i \geq 2$. Thus, (3.9) follows. \square

We will introduce a few estimates for $R_{AB}(p, n)$ as the following proposition.

Proposition 1. For any A and B , if $p \leq 0.5$, $m = L(p)$ and $n \geq 2m$, then

$$CL^{-2}(p)(0.5 - p)^{-2} \asymp R_{AB}(p, n) - R_{AB}(p, m). \quad (3.15)$$

In particular, if $\delta L(p) = m$ and $n \geq 2m$ for a small $\delta > 0$, then there exists C independent of δ , p , m , and n such that

$$R_{AB}(p, n) - R_{AB}(p, m) \geq C\delta^{-1/2}L^{-2}(p)(0.5 - p)^{-2}. \quad (3.16)$$

Furthermore, if $m = ML(p)$ and $n \geq 2m$ for a large $M \geq 1$, then there exist C_1 and C_2 independent of p , M , m , and n such that

$$R_{AB}(p, n) - R_{AB}(p, m) \leq C_1 \exp(-C_2 M)L^{-2}(p)(0.5 - p)^{-2}. \quad (3.17)$$

Proof. Note that event \mathcal{E}_{AB} only depends on the configurations of A , A' , B , and B' , so

$$P_{p,AB}(\mathcal{Q}_4(i) \mid \mathcal{E}_{AB}) = P_{p,AB}(\mathcal{Q}_4(i)) \asymp P_p(\mathcal{Q}_4(i)). \quad (3.18)$$

By (3.18), and the reconnection lemma, if $\|b\| = i$, then

$$P_p^2(\mathcal{Q}_4(i/4)) \asymp P_{p,AB}^2(\mathcal{Q}_4(i/4)) \asymp P_{p,AB}(\mathcal{Q}_4(i/4) \cap \mathcal{Q}_4(b, 0, i/4)) \asymp P_p(\mathcal{R}_{AB}(b, i)).$$

Thus,

$$P_p(\mathcal{R}_{AB}(b, i)) \asymp P_p^2(\mathcal{Q}_4(i/4)). \quad (3.19)$$

Note that $R_{AB}(p, n)$ converges in n uniformly for p , so by (3.19), (2.9), and, the reconnection lemma, if $m = L(p)$, then by summing all b with $\|b\| = i \geq L(p)$ and all $i \leq 2L(p)$,

$$R_{AB}(p, n) - R_{AB}(p, m) \asymp \sum_{i=L(p)}^{2L(p)} iP_p^2(\mathcal{Q}_4(i)) \asymp L^2(p)P_p^2(\mathcal{Q}_4(L(p))) \asymp L^{-2}(p)(0.5 - p)^{-2}. \quad (3.20)$$

So (3.15) in Proposition 1 is proved.

If $m = \delta L(p)$,

$$R_{AB}(p, n) - R_{AB}(p, m) = \sum_{m \leq \|b\| \leq L(p)} \mathcal{R}_{AB}(b, n) + \sum_{L(p) \leq \|b\|} \mathcal{R}_{AB}(b, n). \quad (3.21)$$

By the same estimate of (3.20) and Lemma 2.4,

$$\sum_{L(p) \leq \|b\|} \mathcal{R}_{AB}(b, n) \leq CP_p^2(\mathcal{Q}_4(L(p))) \sum_{i \geq L(p)} iP_p(B(L(p)) \rightarrow B(i)) \asymp L^{-2}(p)(0.5 - p)^{-2}. \quad (3.22)$$

If $m = \delta L(p)$, then the first sum in the right side of (3.21) satisfies that

$$\sum_{m \leq \|b\| \leq L(p)} \mathcal{R}_{AB}(b, n) \asymp \sum_{k=1}^{\delta-1} \sum_{km \leq i \leq (k+1)m} iP_p^2(\mathcal{Q}_4(i)) \asymp \sum_{k=1}^{\delta-1} m^2(k+1)P_p^2(\mathcal{Q}_4(km)). \quad (3.23)$$

By using the reconnection lemma to extend four-arm paths in $\mathcal{Q}_4(km)$ to the boundary of $B(L(p))$ in (3.23) and by (2.9),

$$\sum_{m \leq \|b\| \leq L(p)} \mathcal{R}_{AB}(b, n) \asymp \delta^{-1/2} L^2(p) P_p^2(\mathcal{Q}_4(L(p))) \sum_{k=1}^{\infty} (k+1) k^{-5/2+o(1)} \asymp \delta^{-1/2} L^{-2}(p) (0.5-p)^{-2}. \quad (3.24)$$

If δ is small, then (3.16) in Proposition 1 follows from (3.23) and (3.24).

Now we show (3.17) in Proposition 1. If $\|b\| \geq ML(p)$, by the same estimate of (3.24),

$$R_{AB}(p, n) - R_{AB}(p, m) \leq C P_p^2(\mathcal{Q}_4(L(p))) \sum_{i=ML(p)}^{\infty} i P_p(\partial B(L(p))) \rightarrow \partial B(i). \quad (3.25)$$

Applying Lemma 2.4 and (2.9) in (3.25),

$$R_{AB}(p, n) - R_{AB}(p, m) \leq C_1 \exp(-C_2 M) L^{-2}(p) (0.5-p)^2. \quad (3.26)$$

Therefore, (3.17) follows from (3.26). \square

Now we focus on the third term in the right side of (3.4). Note that

$$\begin{aligned} E_p(N_n(\mathbf{0}) \mid \mathcal{E}_{1,3,5}) &= P_p(N_n(\mathbf{0}) \geq 3 \mid \mathcal{E}_{1,3,5}) + P_p(N_n(\mathbf{0}) \geq 2 \mid \mathcal{E}_{1,3,5}) + P_p(N_n(\mathbf{0}) \geq 1 \mid \mathcal{E}_{1,3,5}) \\ &= P_p(N_n(\mathbf{0}) = 3 \mid \mathcal{E}_{1,3,5}) + P_p(N_n(\mathbf{0}) \geq 2 \mid \mathcal{E}_{1,3,5}) + 1, \end{aligned} \quad (3.27)$$

so

$$\frac{dE_p(N_n(\mathbf{0}) \mid \mathcal{E}_{1,3,5})}{dp} = \frac{dP_p(N_n(\mathbf{0}) = 3 \mid \mathcal{E}_{1,3,5})}{dp} + \frac{dP_p(N_n(\mathbf{0}) \geq 2 \mid \mathcal{E}_{1,3,5})}{dp}. \quad (3.28)$$

For each $b \in B(n)$ with $b \not\sim \mathbf{0}$ (on b_1, b_2, b_3 , which are occupied), let (see Fig. 1.2 and Fig. 1.4)

$$\begin{aligned} \mathcal{R}_3(b, n) &= \\ &\{\exists \text{ disjoint occupied paths } r_2 \text{ and } r_4 \text{ in } B(n) \text{ from } b_1 \text{ and } b_3, \text{ or } b_1 \text{ and } b_5, \text{ or } b_3 \text{ and } b_5 \\ &\text{to neighbors of } b, \exists \text{ a vacant path } r_1 \text{ from } b_2, \text{ or } b_6, \text{ or } b_4 \text{ to a neighbor of } b, \text{ and } \exists \text{ a vacant} \\ &\text{path } r_3 \text{ from } b_4 \text{ and } b_6, \text{ or } b_2 \text{ and } b_4, \text{ or } b_2 \text{ and } b_6 \text{ to a neighbor of } b; \text{ or } \exists \text{ three occupied} \\ &\text{and three vacant paths from } b_1, b_2, b_3 \text{ and } b_2, b_4, b_6 \text{ to neighbors of } b, \text{ all paths in } B(n) \setminus \mathbf{0}\}, \end{aligned}$$

and (see Figures 1.3-1.4)

$$\begin{aligned} \mathcal{R}_2(b, n) &= \\ &\{\exists \text{ disjoint vacant paths } r_1 \text{ and } r_3 \text{ from } b_2 \text{ and } b_6, \text{ or } b_2 \text{ and } b_4, \text{ or } b_4 \text{ and } b_6 \\ &\text{to neighbors of } b, \exists \text{ an occupied path } r_2 \text{ from } b_1, \text{ or } b_3, \text{ or } b_5 \text{ to a neighbor of } b, \text{ and} \\ &\exists \text{ an occupied path } r_4 \text{ from } b_3 \text{ and } b_5, \text{ or } b_1 \text{ and } b_5, \text{ or } b_1 \text{ and } b_3 \text{ to a neighbor of } b; \text{ or} \\ &\exists \text{ three vacant paths from } b_1, b_2, b_3 \text{ and } b_2, b_4, b_6 \text{ to neighbors of } b, \text{ all paths in } B(n) \setminus \mathbf{0}\}. \end{aligned}$$

We also let

$$R_2(p, n) = \sum_{b \in B(n), b \not\sim \mathbf{0}} P_p(\mathcal{R}_2(b, n)) \text{ and } R_3(p, n) = \sum_{b \in B(n), b \not\sim \mathbf{0}} P_p(\mathcal{R}_3(b, n)). \quad (3.29)$$

Comparing $\mathcal{R}_{AB}(b, n)$ with $\mathcal{R}_2(b, n)$ and $\mathcal{R}_3(b, n)$ (comparing Fig. 1.1 with Fig. 1.2, Fig. 1.3, and Fig. 1.4), there are at least four-arm paths from both $\mathbf{0}$ and b among these three events. In fact, if there are six-arm paths from both $\mathbf{0}$ and b in Fig. 1.4, the probability estimate is much smaller than the four-arm case when p is near 0.5. Thus, the four-arm case dominates the six-arm case. With this observation, when we take a higher derivative for $E_p(N_n(\mathbf{0}))$, we can always do the same computations in the analysis of $\mathcal{R}_{AB}(b, n)$, $\mathcal{R}_2(b, n)$, and $\mathcal{R}_3(b, n)$. Therefore, to avoid repeating the similar proofs many times later, we would rather only deal with the detailed estimates for the higher derivative for $P_p(\mathcal{R}_{AB}(b, n))$, but omit the detailed proofs for the others.

Using the same arguments in Lemma 3.1, (3.5), (3.7), and in Lemma 3.2, we can show that

$$\lim_{n \rightarrow \infty} \frac{-dP_p(N_n(\mathbf{0}) = 3 \mid \mathcal{E}_{1,3,5})}{dp} = \lim_{n \rightarrow \infty} R_3(p, n) \text{ and } \lim_{n \rightarrow \infty} \frac{-dP_p(N_n(\mathbf{0}) \geq 2 \mid \mathcal{E}_{1,3,5})}{dp} = \lim_{n \rightarrow \infty} R_2(p, n) \quad (3.30)$$

and both limits in (3.30) converge uniformly on $[0, 0.5]$. Thus, by (3.30),

$$\lim_{n \rightarrow \infty} \frac{dE_p(N_n(\mathbf{0}) \mid \mathcal{E}_{1,3,5})}{dp} = - \lim_{n \rightarrow \infty} [R_2(p, n) + R_3(p, n)], \quad (3.31)$$

and the limit converges uniformly on $[0, 0.5]$. By (3.2), (3.4), Lemma 3.2, and (3.31) for all $p \in [0, 0.5]$,

$$\begin{aligned} \kappa''(p) &= - \lim_{n \rightarrow \infty} \frac{dE_p(N_n)}{dp} \\ &= - \lim_{n \rightarrow \infty} \sum_{A,B} \frac{dE_p(N_n(\mathbf{0}) \mid \mathcal{E}_{AB})}{dp} f_{AB}(p) - \lim_{n \rightarrow \infty} \sum_{A,B} E_p(N_n(\mathbf{0}) \mid \mathcal{E}_{AB}) f'_{AB}(p) \\ &\quad - \lim_{n \rightarrow \infty} 2 \frac{dE_p(N_n(\mathbf{0}) \mid \mathcal{E}_{1,3,5})}{dp} f_{1,3,5}(p) - \lim_{n \rightarrow \infty} 2E_p(N_n(\mathbf{0}) \mid \mathcal{E}_{1,3,5}) f'_{1,3,5}(p) - f''(p) \\ &= \lim_{n \rightarrow \infty} \left[\sum_{A,B} f_{AB}(p) R_{AB}(b, n) + 2f_{1,3,5}(p) \sum_{i=2,3} R_i(p, n) \right] \\ &\quad - \lim_{n \rightarrow \infty} \left[\sum_{A,B} E_p(N_n(\mathbf{0}) \mid \mathcal{E}_{AB}) f'_{AB}(p) + 2E_p(N_n(\mathbf{0}) \mid \mathcal{E}_{1,3,5}) f'_{1,3,5}(p) \right] - f''(p). \end{aligned} \quad (3.32)$$

For simplicity, let

$$\begin{aligned} G_p(n) &= \left[\sum_{A,B} f_{AB}(p) R_{AB}(p, n) + 2f_{1,2,3}(p) \sum_{i=2,3} R_i(p, n) \right] \\ &\quad - \left[\sum_{A,B} E_p(N_n(\mathbf{0}) \mid \mathcal{E}_{AB}) f'_{AB}(p) + 2E_p(N_n(\mathbf{0}) \mid \mathcal{E}_{1,3,5}) f'_{1,3,5}(p) \right] - f''(p). \end{aligned}$$

Thus, by Lemma 3.2, (3.31), and (3.32),

$$\lim_{n \rightarrow \infty} G_n(p) = \kappa''(p) \text{ converges uniformly on } [0, 0.5]. \quad (3.33)$$

Furthermore, by the same argument of the estimate in Lemma 3.2, if $p \leq p_0 < 0.5$, for $i \geq 2$, then

$$- \lim_{n \rightarrow \infty} \frac{d^i E_p(N_n(\mathbf{0}) \mid \mathcal{E}_{1,3,5})}{dp^i} = \lim_{n \rightarrow \infty} [R_2^{(i-1)}(p, n) + R_3^{(i-1)}(p, n)] \text{ converges uniformly on } [0, p_0]. \quad (3.34)$$

By Lemma 3.2 and (3.34),

$$\kappa^{(i)}(p) = \lim_{n \rightarrow \infty} G_p^{(i-2)}(n) \text{ uniformly on } [0, p_0]. \quad (3.35)$$

By the same argument of Proposition 1, if $m = L(p)$ and $n \geq 2m$, then for $j = 2, 3$

$$CL^{-2}(p)(0.5 - p)^{-2} \leq R_j(p, n) - R_j(p, m). \quad (3.36)$$

Similarly to (3.16) and (3.17) for $R_{AB}(p, n) - R_{AB}(p, m)$, if $m = \delta L(p)$ and $n \geq 2m$, then for $j = 2, 3$

$$R_j(p, n) - R_j(p, m) \geq C\delta^{-1/2+o(1)}L^{-2}(p)(0.5 - p)^{-2}, \quad (3.37)$$

and if $m = ML(p)$, then for $j = 2, 3$,

$$R_j(p, n) - R_j(p, m) \leq C \exp(-C_1 M)L^{-2}(p)(0.5 - p)^{-2}. \quad (3.38)$$

By the definition (see Fig 1.1–Fig. 1.4), if $n \geq m \asymp L(p)$ on \mathcal{E}_{AB} , then $N_n(\mathbf{0}) - N_m(\mathbf{0}) \geq 1$ implies that there are four-arm paths from A, A', B, B' to $\partial B(m)$. Similarly, on $\mathcal{E}_{1,3,5}$, there are also four-arm paths from the origin to $\partial B(m)$. By this observation, (2.3), and (1.14),

$$\begin{aligned} & \left| \sum_{A,B} E_p(N_n(\mathbf{0}) \mid \mathcal{E}_{AB}) f'_{AB}(p) - \sum_{A,B} E_p(N_m(\mathbf{0}) \mid \mathcal{E}_{AB}) f'_{AB}(p) \right| \\ & + 2 \left| E_p(N_n(\mathbf{0}) \mid \mathcal{E}_{1,3,5}) f'_{1,3,5}(p) - E_p(N_m(\mathbf{0}) \mid \mathcal{E}_{1,3,5}) f'_{1,3,5}(p) \right| \\ & \leq CP_p(\mathcal{Q}_4(L(p))) \leq C(0.5 - p)^{5/3+o(1)}. \end{aligned} \quad (3.39)$$

Note that $(0.5 - p)^{5/3+o(1)}$ is much smaller than $L^{-2}(p)(0.5 - p)^{-2}$, so by using Proposition 1, (3.36), and (3.39) for $G_n(p)$, if $m = L(p)$ for p near 0.5 from below, then for all $n \geq 2m$, there exists a constant C such that

$$CL^{-2}(p)(0.5 - p)^{-2} \leq G_n(p) - G_m(p). \quad (3.40)$$

If $m = \delta L(p)$ and $n \geq 2m$, by using Proposition 1, (3.37), and (3.39), there exists a constant C independent of δ such that

$$G_p(n) - G_p(m) \geq C\delta^{-1/2}L^{-2}(p)(0.5 - p)^{-2}. \quad (3.41)$$

If $m = ML(p)$ and $n \geq m$, by Proposition 1, (3.38), and (3.39), there are C and C_1 independent of M such that

$$G_p(n) - G_p(m) \leq C \exp(-C_1 M)L^{-2}(p)(0.5 - p)^{-2}. \quad (3.42)$$

4 Higher derivatives of $\kappa(p)$.

In this section, we will estimate the third and higher derivatives for $\kappa(p)$. By (3.32) and (3.33) for any $p < 0.5$,

$$\begin{aligned} \kappa'''(p) &= \lim_{n \rightarrow \infty} G'_p(n) \\ &= \lim_{n \rightarrow \infty} \left[\sum_{A,B} f_{AB}(p) R'_{AB}(p, n) + 2f_{1,2,3}(p) \sum_{i=2,3} R'_i(p, n) \right] \end{aligned}$$

$$\begin{aligned}
& + \lim_{n \rightarrow \infty} \left[2 \sum_{A,B} f'_{AB}(p) R_{AB}(p, n) + 4f'_{1,2,3}(p) \sum_{i=2,3} R_i(p, n) \right] \\
& - \lim_{n \rightarrow \infty} \left[\sum_{A,B} E_p(N_n(\mathbf{0}) \mid \mathcal{E}_{AB}) f''_{AB}(p) + 2E_p(N_n(\mathbf{0}) \mid \mathcal{E}_{1,3,5}) f''_{1,3,5}(p) \right] - f'''(p). \tag{4.1}
\end{aligned}$$

It follows from Lemma 3.2 that for all $p \leq 0.5$ that

$$\begin{aligned}
& \left| 2 \sum_{A,B} f'_{AB}(p) R_{AB}(p, n) + 4f'_{1,2,3}(p) \sum_{i=2,3} R_i(p, n) \right| + \\
& \left| \sum_{A,B} E_p(N_n(\mathbf{0}) \mid \mathcal{E}_{AB}) f''_{AB}(p) + 2E_p(N_n(\mathbf{0}) \mid \mathcal{E}_{1,3,5}) f''_{1,3,5}(p) \right| + f'''(p) \text{ is uniformly bounded.} \tag{4.2}
\end{aligned}$$

So we only need to take care the first two sums in the right side of (4.1).

We first focus on $R'_{AB}(p, n)$ for fixed A and B . Note that $\mathcal{R}_{AB}(b, n)$ is neither increasing nor decreasing, so we have to introduce the following more general Russo's formula. If \mathcal{A} is increasing and \mathcal{B} is decreasing, then (see Lemma 1 in Kesten (1987))

$$\begin{aligned}
\frac{dP_p(\mathcal{A} \cap \mathcal{B})}{dp} &= \sum_u P_p(u \text{ is pivotal for } \mathcal{A} \text{ not for } \mathcal{B}, \text{ and } \mathcal{B} \text{ occurs}) \\
&\quad - \sum_u P_p(u \text{ is pivotal for } \mathcal{B} \text{ not for } \mathcal{A}, \text{ and } \mathcal{A} \text{ occurs}). \tag{4.3}
\end{aligned}$$

We need to divide $\mathcal{R}_{AB}(b, n)$ into the intersection of an increasing and a decreasing events. We denote by $\mathcal{R}_{AB}^+(b, n)$ the event that there are two disjoint occupied paths r_2 and r_4 from the two vertices of A and B to two neighbor vertices of b , respectively. We also denote by $\mathcal{R}_{AB}^-(b, n)$ the event that there are two disjoint vacant dual paths r_1 and r_3 from the two vertices of A' and B' to the two neighbor vertices of b , respectively. We decompose

$$\mathcal{R}_{AB}(b, n) = \mathcal{R}_{AB}^+(b, n) \cap \mathcal{R}_{AB}^-(b, n). \tag{4.4}$$

By the new Russo's formula (see Fig. 2),

$$\begin{aligned}
R'_{AB}(p, n) &= \sum_b \sum_f P_p(f \text{ is pivotal for } \mathcal{R}_{AB}^+(b, n) \text{ not for } \mathcal{R}_{AB}^-(b, n), \text{ and } \mathcal{R}_{AB}^-(b, n) \text{ occurs}) \\
&\quad - \sum_b \sum_f P_p(f \text{ is pivotal for } \mathcal{R}_{AB}^-(b, n) \text{ not for } \mathcal{R}_{AB}^+(b, n), \text{ and } \mathcal{R}_{AB}^+(b, n) \text{ occurs}) \\
&= \sum_b \sum_f P_p(\mathcal{R}_{AB}^+(b, f, n)) - \sum_b \sum_f P_p(\mathcal{R}_{AB}^-(b, f, n)) = R'_{AB}^+(p, n) - R'_{AB}^-(p, n), \tag{4.5}
\end{aligned}$$

where the first sum above is taken over all sites $b \in B(n)$ for $b \not\sim \mathbf{0}$, and the second one is taken over all sites f for $f \neq b$ and $f \not\sim \mathbf{0}$ in $B(n)$, and

$$\begin{aligned}
\mathcal{R}_{AB}^+(b, f, n) &= \{f \text{ is pivotal for } \mathcal{R}_{AB}^+(b, n) \text{ not for } \mathcal{R}_{AB}^-(b, n), \text{ and } \mathcal{R}_{AB}^-(b, n) \text{ occurs}\}, \\
\mathcal{R}_{AB}^-(b, f, n) &= \{f \text{ is pivotal for } \mathcal{R}_{AB}^-(b, n) \text{ not for } \mathcal{R}_{AB}^+(b, n), \text{ and } \mathcal{R}_{AB}^+(b, n) \text{ occurs}\}. \tag{4.6}
\end{aligned}$$

We call them the *positive part* and the *negative part* of $R'_{AB}(p, n)$, respectively.

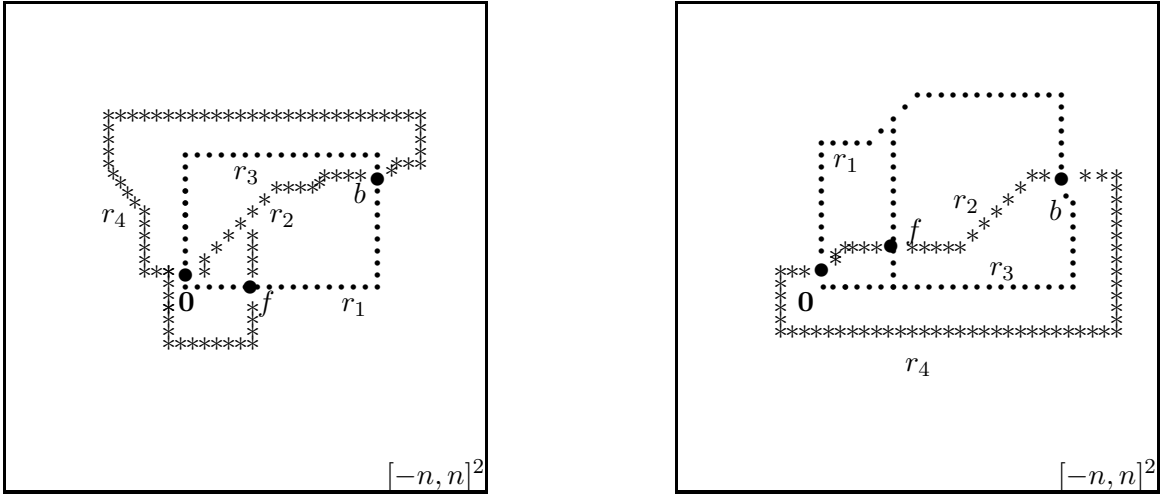

Figure 2: The left figure shows that f is a pivotal vertex for $\mathcal{R}_{AB}^-(b, n)$, and the right one shows that f is a pivotal vertex for $\mathcal{R}_{AB}^+(b, n)$, where the $*$ -paths are occupied and the solid circle-paths are vacant.

Let us focus on $R_{AB}^+(p, n)$. For $p < 0.5$, we sum b, f with $\|b\| \leq n/2$ and $\|f\| \leq n/2$. We denote by

$$R_{AB}^+(p, n/2, n) = \sum_{b, \|b\| \leq n/2} \sum_{f, \|f\| \leq n/2} P_p(\mathcal{R}_{AB}^+(b, f, n)).$$

We need to point out that $R_{AB}^+(p, n/2, n)$ is not a derivative of $R_{AB}^+(p, n)$, but the derivative of $R_{AB}(p, n)$ with restricted pivotal sites of $b, f \in [-n/2, n/2]^2$. By the same proof of Lemma 3.2, if $p < 0.5$,

$$\lim_{n \rightarrow \infty} R_{AB}^+(p, n/2, n) = \lim_{n \rightarrow \infty} \sum_{b, \|b\| \leq n/2} \sum_{f, \|f\| \leq n/2} P_p(\mathcal{R}_{AB}^+(b, f, n)) = \lim_{n \rightarrow \infty} \sum_b \sum_f P_p(\mathcal{R}_{AB}^+(b, f, n)). \quad (4.7)$$

On $\mathcal{R}_{AB}^+(b, f, n)$ with $\|b\| \leq n/2$ and $\|f\| \leq n/2$, there are either two vacant paths r_5 and r_6 from the two neighbors of f to r_1 and r_3 (see the right graph of Fig. 2), or there is at least an occupied path from $\mathbf{0}$ or b to $\partial B(n)$. Similarly, on $\mathcal{R}_{AB}^-(b, f, n)$, there are either two occupied paths r_7 and r_8 from the two neighbors of f to r_2 and r_4 (see the left graph of Fig. 2), or there is at least an occupied path from f to $\partial B(n)$. We may also consider $\mathcal{R}_{AB}^\pm(b, f, \infty)$ if all the paths above are in \mathbf{Z}^2 . By (4.7) and Lemma 3.2, if $p < 0.5$, then

$$\lim_{n \rightarrow \infty} \sum_{b, \|b\| \leq n/2} \sum_{f, \|f\| \leq n/2} P_p(\mathcal{R}_{AB}^\pm(b, f, n)) = \lim_{n \rightarrow \infty} \sum_b \sum_f P_p(\mathcal{R}_{AB}^\pm(b, f, n)) = R_{AB}^{\pm}(p, \infty). \quad (4.8)$$

Now we focus on $b, f \in B(n)$ with $\|b\| \leq n/2$ and $\|f\| \leq n/2$. As we discussed above or in Lemma 3.1 (see Fig. 2), there are four-arm paths from $\mathbf{0}$ to $\partial B(r)$ if $b, f \notin B(r)$ for any $0 < r < n$. Similarly, there are four paths around b and f , respectively. We call the *pivotal property*. Note that if we do not restrict $b, f \in B(n)$ with $\|b\| \leq n/2$ and $\|f\| \leq n/2$, then there are no four-arm paths when b or f is near the boundary of $B(n)$. We may still use three-arm paths in the half space to hand it (see Morrow and Zhang (2005)), but it needs more notations and different computations. We also use the

notations $dR_i^+(p, n/2, n)/dp$, $dR_{AB}^-(p, n/2, n)/dp$, and $dR_i^-(p, n/2, n)/dp$ for the corresponding sums with $\|b\|, \|f\| \leq n/2$, respectively. Similarly, for $i = 2, 3$,

$$\lim_{n \rightarrow \infty} dR_i^\pm(p, n)/dp = \lim_{n \rightarrow \infty} \sum_{b, f, \|b\| \leq n/2, \|f\| \leq n/2} P_p(\mathcal{R}_i^\pm(b, f, \infty)) = dR_i^\pm(p, \infty)/dp. \quad (4.9)$$

We also let

$$\begin{aligned} dG_p^+(n)/dp &= \sum_{A, B} f_{AB}(p) dR_{AB}^+(p, n)/dp + 2f_{1,2,3}(p) \sum_{i=2,3} dR_i^+(p, n)/dp \\ &+ 2 \sum_{A, B} f'_{AB}(p) R_{AB}(p, n) + 4f'_{1,2,3}(p) \sum_{i=2,3} R_i(p, n) + 2E_p(N_n(\mathbf{0}) \mid \mathcal{E}_{1,3,5}) f''_{1,3,5}(p). \end{aligned}$$

and

$$dG_p^-(n)/dp = \sum_{A, B} f_{AB}(p) dR_{AB}^-(p, n)/dp + 2f_{1,2,3}(p) \sum_{i=2,3} dR_i^-(p, n)/dp + \sum_{A, B} E_p(N_n(\mathbf{0}) \mid \mathcal{E}_{AB}) f''_{AB}(p) + f'''(p).$$

Thus,

$$G'_p(n) = dG_p^+(n)/dp - dG_p^-(n)/dp.$$

Similarly, if we replace $dR_{AB}^\pm(p, n)/dp$ and $dR_i^\pm(p, n)/dp$ by $dR_{AB}^\pm(p, n/2, n)/dp$ and $dR_i^\pm(p, n/2, n)/dp$ in $dG_p^\pm(n)/dp$, then we have $dG_p^\pm(n/2, n)/dp$. By (3.33), if $p < 0.5$, $\lim_n dG_p^\pm(n)/dp$ exists. In addition, by (4.7), (4.8), and (4.9),

$$\lim_{n \rightarrow \infty} dG_p^\pm(n)/dp = \lim_{n \rightarrow \infty} dG_p^\pm(n/2, n)/dp \stackrel{D}{=} d^3 \kappa^\pm(p)/dp^3. \quad (4.10)$$

With these observations and (4.1), if $p < 0.5$,

$$\kappa'''(p) = d^3 \kappa^+(p)/dp^3 - d^3 \kappa^-(p)/dp^3. \quad (4.11)$$

We may take the second derivative of $G_p(n)$ for $p < 0.5$ to have

$$\begin{aligned} G''_p(n) &= \sum_{A, B} f_{AB}(p) R''_{AB}(p, n) + 2f_{1,2,3}(p) \sum_{i=2,3} R''_i(p, n) + 3 \sum_{A, B} f'_{AB}(p) R'_{AB}(p, n) + 6f'_{1,2,3}(p) \sum_{i=2,3} R'_i(p, n) \\ &+ 3 \sum_{A, B} f''_{AB}(p) R_{AB}(p, n) + 6f''_{1,2,3}(p) \sum_{i=2,3} R_i(p, n) \\ &- \sum_{A, B} E_p(N_n(\mathbf{0}) \mid \mathcal{E}_{AB}) f'''_{AB}(p) - 2E_p(N_n(\mathbf{0}) \mid \mathcal{E}_{1,3,5}) f'''_{1,3,5}(p) - f''''(p) \\ &= \sum_{A, B} f_{AB}(p) R''_{AB}(p, n) + 2f_{1,2,3}(p) \sum_{i=2,3} R''_i(p, n) \\ &+ 3 \sum_{A, B} f'_{AB}(p) R'_{AB}(p, n) + 6f'_{1,2,3}(p) \sum_{i=2,3} R'_i(p, n) + h_4(p, n), \end{aligned} \quad (4.12)$$

where $h_4(p, n)$ is a differentiable function on $(0, 1)$ and convergent uniformly in n . By (3.34), if $p < 0.5$, then

$$\lim_{n \rightarrow \infty} G''_p(n) = \kappa''''(p). \quad (4.13)$$

We continue to take the k -th derivative. Before taking the k -derivative, we need to simplify the notations. By Lemma 3.1 and (4.1), for any $p < 0.5$, using the same discussion in (4.2), we only need to estimate

$d^k R_{AB}(p, n)/dp^k$ and $d^k R_i(p, n)/dp^k$ for all possible A, B and for $i = 2, 3$. Without loss of generality, as we did before, we only estimate $dR_{AB}^k(p, n)/dp^k$. For fixed A and B , by the definition of (4.5),

$$dR_{AB}(p, n)/dp = \sum_b \sum_{f_1} P_p(\mathcal{R}_{AB}^+(b, f_1, n)) - \sum_b \sum_{f_1} P_p(\mathcal{R}_{AB}^-(b, f_1, n)). \quad (4.14)$$

We need to make notations simpler. Let I_1 be a sign variable taking $+$ or $-$. We can rewrite (4.14) as

$$dR_{AB}(p, n)/dp = \sum_b \sum_{I_1} \sum_{f_1^{I_1}} I_1 P_p(\mathcal{R}_{AB}(b, f_1^{I_1}, n)), \quad (4.15)$$

where the above second and third sums take $I_1 = +$ or $I_1 = -$, and f_1^+ and f_1^- . If we continue to take another derivative, then

$$d^2 R_{AB}(p, n)/dp^2 = \sum_b \sum_{I_1} \sum_{f_1^{I_1}} I_1 \frac{dP_p(\mathcal{R}_{AB}(b, f_1^{I_1}, n))}{dp}. \quad (4.16)$$

Let us work on $dP_p(\mathcal{R}_{AB}(b, f_1^{I_1}, n))/dp$. Since the topology is similar to Proposition 1, but needed many pages to prove, we just state these topology results in (4.17) without proofs. These topology results can also be convinced by Fig. 3. We divide $\mathcal{R}_{AB}(b, f_1^{I_1}, n)$ into the intersection of an increasing event and a decreasing event. More precisely, we collect all the necessary occupied paths connecting $\mathbf{0}$, b and $f_1^{I_1}$ as an increasing event and all the necessary vacant paths connecting $\mathbf{0}$, b and $f_1^{I_1}$ as a decreasing event, where these occupied and vacant paths make $\mathcal{R}(b, f_1^{I_1}, n)$ to occur (see Fig. 3). We then use the new Russo's formula for positive and negative events separately. Besides of $\mathbf{0}$, b and $f_1^{I_1}$, we need to handle a pivotal vertex $f_2^{I_1, +}$ for occupied paths and a pivotal vertex $f_2^{I_1, -}$ for vacant paths. Thus, we can use the sign notation I_2 to write

$$d^2 R_{AB}(p, n)/dp^2 = \sum_b \sum_{I_1, I_2} \sum_{f_1^{I_1}, f_2^{I_1, I_2}} I_1 I_2 P_p(\mathcal{R}_{AB}(b, f_1^{I_1}, f_2^{I_1, I_2}, n)) \quad (4.17)$$

to present the probabilities of these four pivotal vertices f_1^\pm and $f_2^{\pm, \pm}$, where $I_1 I_2 = +$ if $I_1 = \pm$ and $I_2 = \pm$, otherwise $I_1 I_2 = -$. By using our new notations, we have the following k -th derivative:

$$d^k R_{AB}(p, n)/dp^k = \sum_{I_1, \dots, I_k} \sum_{b, f_1^{I_1}, f_2^{I_1, I_2}, \dots, f_k^{I_1, I_2, \dots, I_k}} I_1 I_2 \cdots I_k P_p(\mathcal{R}_{AB}(b, f_1^{I_1}, f_2^{I_1, I_2}, \dots, f_k^{I_1, \dots, I_k}, n)), \quad (4.18)$$

where the first sum takes all possible signs $I_j = \pm$ for $1 \leq j \leq k$, the second sum takes all possible pivotal vertices $\{b, f_1^{I_1}, f_2^{I_1, I_2}, \dots, f_k^{I_1, I_2, \dots, I_k}\}$ in event $\mathcal{R}_{AB}(b, f_1^{I_1}, f_2^{I_1, I_2}, \dots, f_k^{I_1, \dots, I_k}, n)$ and $I_1 I_2 \cdots I_k = +$ if there are even number of I_j 's taking negative signs, otherwise; it is negative. Similarly, we can define $d^k R_i(p, n)/dp^k$ for $i = 2, 3$. If we continue to differentiate $G_p''(n)$ for $k - 2$ times in (4.12), then by using its definition and (3.33), we have

$$\begin{aligned} & d^k G_p(n)/dp^k \\ = & \sum_{A, B} f_{AB}(p) d^k R_{AB}(p, n)/dp^k + 2f_{1,2,3}(p) \sum_{i=2,3} d^k R_i(p, n)/dp^k + \\ & + \left[\sum_{j=1}^{k-1} \sum_{AB} [f_{AB,j}(p) d^j R_{AB}(p, n)/dp^j + \sum_{j=1}^{k-1} g_j(p) \sum_{i=2,3} d^j R_i(p, n)/dp^j] + h_k(p, n), \right] \end{aligned} \quad (4.19)$$

where $f_{AB}(p)$, $f_{1,2,3}(p)$, $f_{AB,j}(p)$ and $g_j(p)$ are some polynomials with degrees less than 6, and $h_k(p, n)$ is a differentiable function on $(0, 1)$ and convergent uniformly for n . As we did for $k = 1$, we denote by

$$d^k R_{AB}(p, n/2, n)/dp^k = \sum_{I_1, \dots, I_k} \sum_{b, f_1^{I_1}, f_2^{I_1, I_2}, \dots, f_k^{I_1, \dots, I_k}} I_1 I_2 \cdots I_k P_p(\mathcal{R}_{AB}(b, f_1^{I_1}, f_2^{I_1, I_2}, \dots, f_k^{I_1, \dots, I_k}, n))$$

for

$$\{b, f_1^{I_1}, f_2^{I_1, I_2}, \dots, f_k^{I_1, \dots, I_k}\} \subset [-n/2, n/2]^2.$$

As mentioned before, the above equation is not the k -th derivative of $R_{AB}(p, n/2, n)$, but the pivotal sites of $d^k R_{AB}(p, n)/dp^k$ restricted in $[-n/2, n/2]^2$. Similarly, we can define $d^k R_i(p, n/2, n)/dp^k$ for $i = 2, 3$ and $d^k G_p(n/2, n)/dp^k$ by replacing $R_{AB}(p, n)$ and $R_i(p, n)$ by $R_{AB}(p, n/2, n)$ and $R_i(p, n/2, n)$.

Now we try to decompose $\mathcal{R}_{AB}(b, f_1^{I_1}, f_2^{I_1, I_2}, \dots, f_k^{I_1, \dots, I_k}, n)$ into four arm paths in disjoint squares (see Fig. 3). We fix signs I_1, I_2, \dots, I_k . For simplicity, we write $f_0 = b$ and $f_j^{I_1, \dots, I_j} = f_j$. We need to work on the topology of these pivotal vertices as the same as we analyzed in (4.6) by using occupied paths and vacant paths from these pivotal vertices $\{\mathbf{0}, f_0, f_1, f_2, \dots, f_k\}$. For each pivotal vertex

$$f \in \{f_0, f_1, f_2, \dots, f_k\} \subset [-n/2, n/2]^2,$$

as we discussed for $\mathcal{R}_{AB}(b, f, n)$, if there are no other pivotal vertices in $f + B(r)$, then $\mathcal{Q}_4(f, 0, r/2)$ occurs for $0 < r < n$. In other words, we still have the pivotal property (see Fig. 3 for $k = 3$) for each vertex f_j for $j = 0, 1, 2, \dots, k$.

For fixed $\{f_0, \dots, f_k\} \subset [-n/2, n/2]^2$, we construct a graph with k edges by using vertices $\{f_0, \dots, f_k\}$. Let $v_0, v'_0 \in \{f_0, \dots, f_k\}$ with

$$\|v_0 - v'_0\| = R_0 = \min_{i, j \leq k} \|f_i - f_j\|.$$

There might be many pairs in $\{f_0, \dots, f_k\}$ with the same value $\|v_0 - v'_0\|$, so we simply select one pair in a unique way. We call edge e_0 with vertices v_0, v'_0 and $B(v_0, R_0/2)$ is called a v_0 -square. Since there are no other vertices of $\{f_0, \dots, f_k\}$ in v_0 -square (v'_0 -square) except v_0 (v'_0) itself, on $\mathcal{R}_{AB}(f_0, \dots, f_k, n)$, by the pivotal property (see Fig. 3),

$$\mathcal{Q}_4(v_0, 0, R_0/4) \text{ and } \mathcal{Q}_4(v'_0, 0, R_0/4) \text{ occur disjointly on } v_0\text{- and } v'_0\text{-squares.} \quad (4.20)$$

In other words, four arm paths in v_0 - and v'_0 - squares are disjoint, respectively. We denote by

$$\mathcal{T}_k(v_0, v'_0) = \mathcal{Q}_4(v_0, 0, R_0/4) \cap \mathcal{Q}_4(v'_0, 0, R_0/4).$$

We then construct another edge $e_1 \neq e_0$ with two vertices v_1, v'_1 such that

$$\|v_1 - v'_1\| = R_1 = \min_{i, j \leq k} \|f_i - f_j\|.$$

There might be many pairs in $\{f_0, \dots, f_k\}$ with the same value $\|v_1 - v'_1\|$, so we simply select one pair in a unique way. Now there are two possible cases. Case I_1 : e_0 and e_1 are adjacent (with a common vertex), or case II_1 : case I_1 does not occur. In case II_1 , on $\mathcal{R}_{AB}(f_0, \dots, f_k, n)$, since there are no other pivotal vertices in v_i -square (v'_i -square) except v_i (v'_i) itself for $i = 0, 1$, by the pivotal property,

$$\mathcal{Q}_4(v_0, 0, R_0/4), \mathcal{Q}_4(v'_0, 0, R_0/4), \mathcal{Q}_4(v_1, 0, R_1/4), \mathcal{Q}_4(v'_1, 0, R_1/4) \text{ occur disjointly} \quad (4.21)$$

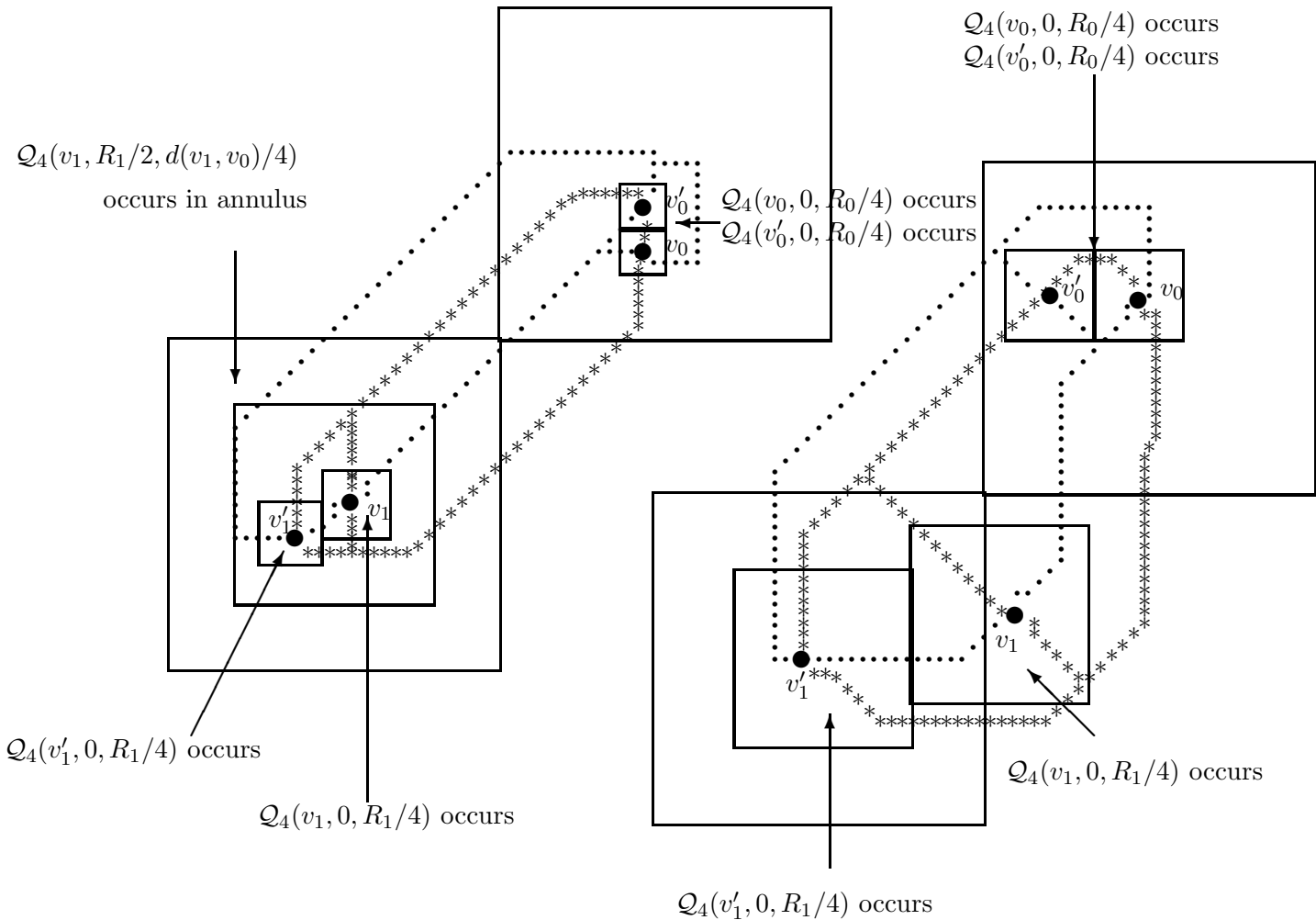

Figure 3: The left figure shows case $II_1(b)$. e_0 and e_1 are the edges adjacent v_0 and v'_0 , and v_1 , and v'_1 , respectively. In this case, $d(e_0, e_1) > 2R_1 = 2\|v_1 - v'_1\|$. $\mathcal{Q}_4(v_0, 0, R_0/4)$, $\mathcal{Q}_4(v'_0, 0, R_0/4)$, $\mathcal{Q}_4(v_1, 0, R_1/4)$, $\mathcal{Q}_4(v'_1, 0, R_1/4)$, $\mathcal{Q}_4(v_1, R_1/2, d(v_1, v_0)/4)$ occur disjointly. The right figure shows case $II_1(a)$. In this case, $d(e_0, e_1) \leq 2R_1$. $\mathcal{Q}_4(v_0, 0, R_0/4)$, $\mathcal{Q}_4(v'_0, 0, R_0/4)$, $\mathcal{Q}_4(v_1, 0, R_1/4)$, $\mathcal{Q}_4(v'_1, 0, R_1/4)$ occur disjointly. The $*$ -paths are occupied and the solid dotted-paths are vacant.

on v_i - and v'_i -squares for $i = 1, 2$. In other words, four arm paths in v_i - and v'_i - squares, for $i = 1, 2$, are disjoint, respectively. We always say that a group of four arm paths occur disjointly later if they occur in different squares. If $d(e_0, e_1) \leq 2R_1$, called case $II_1(a)$ (see the right graph in Fig. 3), then we just keep the events in (4.21). If $d(e_0, e_1) > 2R_1$, called case $II_1(b)$, then by the pivotal property,

$$\mathcal{Q}_4(v_0, 0, R_0/4), \mathcal{Q}_4(v'_0, 0, R_0/4), \mathcal{Q}_4(v_1, 0, R_1/4), \mathcal{Q}_4(v'_1, 0, R_1/4), \mathcal{Q}_4(v_1, R_1/2, d(e_0, e_1)/4) \quad (4.22)$$

occur disjointly (see the left graph in Fig. 3). In both case $II_1(a)$ and case $II_1(b)$, we select v_1 such that it is nearer e_0 than v'_1 .

In case I_1 , we know that e_0 and e_1 are adjacent. We select v_1 adjacent to e_0 , so $v_1 \in \{v_0, v'_0\}$ such that $\|v'_1 - v_1\| = R_1$. Thus,

$$\mathcal{Q}_4(v_0, 0, R_0/4), \mathcal{Q}_4(v'_0, 0, R_0/4), \mathcal{Q}_4(v'_1, 0, R_1/4), \text{ occur disjointly} \quad (4.23)$$

on v_0 - and v'_0 - and v'_1 -squares, respectively. We denote by

$$\begin{aligned} \mathcal{T}_k(v_0, v'_0, v_1, v'_1) = & \\ & \{\mathcal{Q}_4(v_0, 0, R_0/4), \mathcal{Q}_4(v'_0, 0, R_0/4), \mathcal{Q}_4(v'_1, 0, R_1/4) \text{ in case } I_1\} \\ & \bigcup \{\mathcal{Q}_4(v_0, 0, R_0/4), \mathcal{Q}_4(v'_0, 0, R_0/4), \mathcal{Q}_4(v_1, 0, R_1/4), \mathcal{Q}_4(v'_1, 0, R_1/4) \text{ in case } II_1(a)\} \\ & \bigcup \{\mathcal{Q}_4(v_0, 0, R_0/4), \mathcal{Q}_4(v'_0, 0, R_0/4), \mathcal{Q}_4(v_1, 0, R_1/4), \mathcal{Q}_4(v'_1, 0, R_1/4), \mathcal{Q}_4(v_1, R_1/2, d(e_0, e_1)/4) \text{ in case } II_1(b)\}. \end{aligned} \quad (4.24)$$

Suppose that we have edges $\{e_0, \dots, e_j, \dots, e_i\}$ with vertices $\{(v_0, v'_0), \dots, (v_j, v'_j), \dots, (v_i, v'_i)\}$ and $\mathcal{T}_k(v_0, v'_0, \dots, v_i, v'_i)$ occurs. We continue to find the edge $e_{i+1} \neq e_j$ for $j = 0, \dots, i$ with vertices v_{i+1}, v'_{i+1} such that

$$\|v_{i+1} - v'_{i+1}\| = \min_{i, j \leq k} \|f_i - f_j\| = R_{i+1}.$$

Similarly to case I_1 and case II_1 in (4.20)-(4.24), we have case I_{i+1} : e_{i+1} is adjacent to $\{e_0, \dots, e_i\}$ or case II_{i+1} : case I_{i+1} does not occur. In case I_{i+1} , we select $v_{i+1} \in \{v_0, v'_0, \dots, v_i, v'_i\}$. Thus,

$$\mathcal{T}_k(v_0, v'_0, \dots, v_i, v'_i), \mathcal{Q}_4(v'_{i+1}, 0, R_{i+1}/4) \text{ occur disjointly.} \quad (4.25)$$

Now we consider case II_{i+1} : e_{i+1} is not adjacent to $\{e_0, \dots, e_i\}$. If

$$d(e_{i+1}, \{v_0, v'_0, \dots, v_i, v'_i\}) = d(e_{i+1}, x_i) \leq 2R_{i+1}, \text{ called case } II_{i+1}(a), \text{ for } x_i \in \{v_0, v'_0, \dots, v_i, v'_i\}, \quad (4.26)$$

note that there are no other pivotal vertices in $v_{i+1} + B(R_{i+1}/4)$ ($v'_{i+1} + B(R_{i+1}/4)$) except v_{i+1} (v'_{i+1}), so

$$\mathcal{T}_k(v_0, v'_0, \dots, v_i, v'_i), \mathcal{Q}_4(v_{i+1}, 0, R_{i+1}/4), \mathcal{Q}_4(v'_{i+1}, 0, R_{i+1}/4) \text{ occur disjointly.} \quad (4.27)$$

If

$$d(e_{i+1}, \{v_0, v'_0, \dots, v_i, v'_i\}) = d(e_{i+1}, x_i) > 2R_{i+1}, \text{ called case } II_{i+1}(b), \text{ for } x_i \in \{v_0, v'_0, \dots, v_i, v'_i\}, \quad (4.28)$$

then in addition to events in (4.27), there are extra four arm paths in $v_{i+1} + A(R_{i+1}/2, d(e_{i+1}, x_i)/4)$. Thus,

$$\mathcal{T}_k(v_0, v'_0, \dots, v_i, v'_i), \mathcal{Q}_4(v_{i+1}, 0, R_{i+1}/4), \mathcal{Q}_4(v'_{i+1}, 0, R_{i+1}/4), \mathcal{Q}_4(v_{i+1}, R_{i+1}/2, d(e_{i+1}, x_i)/4) \quad (4.29)$$

occur disjointly. In case $II_{i+1}(\text{a})$ and $II_{i+1}(\text{b})$, we select v_{i+1} such that it is nearer $\{e_0, \dots, e_i\}$ than v'_{i+1} . Note that if $\{f_0, \dots, f_k\}$ are fixed, then $\{v_0, v'_0, \dots, v_{i+1}, v'_{i+1}\}$, and u are also fixed. We denote by

$$\begin{aligned} \mathcal{T}_k(v_0, v'_0, \dots, v_{i+1}, v'_{i+1}) &= \mathcal{T}_k(v_0, v'_0, \dots, v_i, v'_i) \cap \\ &\{[\mathcal{Q}_4(v_{i+1}, 0, R_{i+1}/4) \text{ in case } I_{i+1}] \cup [\mathcal{Q}_4(v_{i+1}, 0, R_{i+1}/4), \mathcal{Q}_4(v'_{i+1}, 0, R_{i+1}/4) \text{ in case } II_{i+1}(\text{a})] \\ &\cup [\mathcal{Q}_4(v_{i+1}, 0, R_{i+1}/4), \mathcal{Q}_4(v'_{i+1}, 0, R_{i+1}/4), \mathcal{Q}_4(v_{i+1}, R_{i+1}/2, d(e_{i+1}, x_i)/4) \text{ in case } II_{i+1}(\text{b})]\}. \end{aligned}$$

We continue this way to find all pairs $\{(v_0, v'_0) \dots, (v_k, v'_k)\}$ with edges $\{e_0 = (v_0, v'_0), \dots, e_k = (v_k, v'_k)\}$ such that $\mathcal{T}_k(v_0, v'_0, \dots, v_k, v'_k)$ occurs. For fixed signs I_1, I_2, \dots, I_k , note that if $\{f_0, \dots, f_k\}$ are fixed, then $\{v_0, v'_0, \dots, v_k, v'_k\}$ are uniquely determined, and

$$\mathcal{R}_{AB}(f_0, f_1, f_2, \dots, f_k, n) \subset \mathcal{T}_k(v_0, v_0, \dots, v_k, v'_k),$$

so

$$\sum_{f_0, \dots, f_k} P_p(\mathcal{R}_{AB}(f_0, f_1, f_2, \dots, f_k, n)) \leq \sum_{v_0, v_0, \dots, v_k, v'_k} P_p(\mathcal{T}_k(v_0, v_0, \dots, v_k, v'_k)). \quad (4.30)$$

We point out that some of v_i or v'_i is the origin. We just do not need to sum it in (4.30) if it is the origin. For convenience, by translation invariance, if we move in parallel the configurations in $\mathcal{T}_k(v_0, v'_0, \dots, v_k, v'_k)$ from v_0 to the origin, then

$$\sum_{v_0, v'_0, \dots, v_k, v'_k} P_p(\mathcal{T}_k(v_0, v'_0, \dots, v_k, v'_k)) \leq \sum_{v'_0, \dots, v_k, v'_k} P_p(\mathcal{T}_k(\mathbf{0}, v'_0, \dots, v_k, v'_k)), \quad (4.31)$$

where the sum in the right of (4.31) takes all possible $v_i, v'_i \in B(n)$ with $v_0 = \mathbf{0}$.

On the other hand, we know that v_i and v_j may or may not be same for $i \neq j$. To avoid this problem, we select $u_0 = \mathbf{0}$, $u_1 = v'_0$, $u_2 = v_1$ if $v_1 \notin \{v_0, v'_0\}$ or $u_2 = v'_1$ if $v_1 \in \{v_0, v'_0\}$. If $u_i = v_j$ for some j , then $u_{i+1} = v'_j$. Continuously, if $u_i = v'_j$ for some j , then $u_{i+1} = v_{j+1}$ when $v_{j+1} \notin \{\mathbf{0}, v'_0, \dots, v_j, v'_j\}$ or $u_{i+1} = v'_{j+1}$ when $v_{j+1} \in \{\mathbf{0}, v'_0, \dots, v_j, v'_j\}$. We continue to find all the different vertices $\{u_0, u_1, \dots, u_k\}$. Thus, $\mathcal{T}_k(\mathbf{0}, v'_0, \dots, v_k, v'_k) \subset \mathcal{T}_k(\mathbf{0}, u_1, \dots, u_k)$ with $u_i \neq u_j$ for $i \neq j$ for $\{u_1, \dots, u_k\} \subset [-2n, 2n]^2$. On the other hand, $\{\mathbf{0}, v'_1, \dots, v_k, v'_k\} = \{\mathbf{0}, u_1, \dots, u_k\}$. Thus,

$$\sum_{v'_0, \dots, v_k, v'_k} P_p(\mathcal{T}_k(\mathbf{0}, v'_0, \dots, v_k, v'_k)) \leq \sum_{u_1, \dots, u_k} P_p(\mathcal{T}_k(\mathbf{0}, u_1, \dots, u_k)). \quad (4.32)$$

With the vertices $\{u_0, \dots, u_k\}$, we have the edges $\{e_0, e_1, \dots, e_k\}$ connecting these vertices. These edges together with $\{u_0, \dots, u_k\}$ consist of a few clusters (possible only one). If there are more than one clusters, we first consider the cluster containing the origin with vertices $\{\mathbf{0}, v'_0, \dots, v_i, v'_i\}$ for $i < k$. We then find the cluster, denoted by $\{v_j, v'_j, \dots, v_l, v'_l\}$, such that the distance T_1 from its vertices and $\{\mathbf{0}, v'_0, \dots, v_i, v'_i\}$ is the shortest. If there are two or more different clusters also with the same distance T_1 from $\{\mathbf{0}, v'_0, \dots, v_i, v'_i\}$, we simply select one uniquely. We pick the two vertices from these two clusters such that the distance between these vertices equal to T_1 . We simply add an extra edge e'_1 connecting these selected vertices. The added edge is called *extra edge*. It follows from this construction that

$$R_i \leq R_j \leq R_l \leq T_1. \quad (4.33)$$

With the new edge e'_1 , we get a larger cluster containing the origin. By using the same way to expand, all the clusters are connected to be one cluster, denoted by \mathcal{G}_k . For simplicity, , we still use $\{e_j\}$ to denote

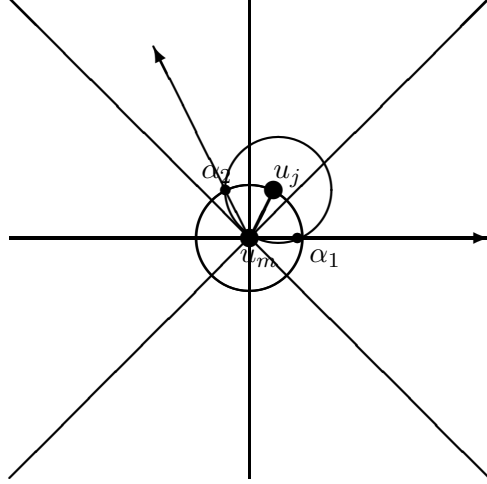

Figure 4: Edge $(u_m, u_j) \in \{e_j\}$. Two disks $u_m + D(\|u_m - u_j\|)$ and $u_j + D(\|u_m - u_j\|)$ intersect at α_1 and α_2 , respectively. Two rays from u_m passing through α_i to ∞ for $i = 1, 2$ consisting of cone Δ_m . The angle between two boundaries of the cone is $2\pi/3$. By the constructions of the pivotal sites, there is no edge adjacent to u_m in $\Delta_m \cap (u_m + D(\|u_m - u_j\|))$ except (u_m, u_j) . On the other hand, note that any vertex in $\Delta_m \setminus (u_m + D(\|u_m - u_j\|))$ is nearer u_j than u_m , so there are no vertices in $\Delta_m \setminus (u_m + D(\|u_m - u_j\|))$ adjacent to u_m as the edges of $\{e_j\}$. In other words, (u_m, u_j) is the only edge adjacent to u_m in the cone. There are 8 equal cones starting from u_m . Each of them contains at most only one edge in $\{e_j\}$ adjacent to u_m .

all the edges of \mathcal{G}_k . For each vertex u_m , we consider the edges of $\{e_j\}$ adjacent to u_m (see Fig. 4). By our constructions, there is at most one edge from u_m adjacent to $\{u_1, \dots, u_{m-1}\}$. On the other hand, we also consider the edges $\{u_j\}$ adjacent to u_m for $j \geq m$. Suppose that u_j is one of these edges for $j > m$ adjacent to u_m . Let $u + D(r)$ be the disk with the center at u and with a radius r . Let the intersections of two disks $u_m + D(\|u_m - u_j\|)$ and $u_j + D(\|u_m - u_j\|)$ be α_1 and α_2 (see Fig. 4). We consider the rays from u_m passing through α_i to ∞ for $i = 1, 2$ and the cone Δ_m with boundaries of these two rays (see Fig. 4). By our constructions for $\{u_0, \dots, u_k\}$, if (u_m, u_j) is not an extra edge, then Δ_m contains only edge (u_m, u_j) in its domain. We call the *isolated* property for u_m . If (u_m, u_j) is an extra edge, by (4.33), we still have the isolated property for u_m . Thus, we may say that \mathcal{G}_j has the isolated property for each of its vertices. We consider the 8 rays including the horizontal -axis starting from u_m to ∞ such that the angle between any two rays is $\pi/4$ (see Fig. 4). Thus, there are 8 equal cones with the boundaries of these rays. We order them by corn 1, \dots , corn 8. By the isolated property, there are at most one edge (u_m, u_j) of \mathcal{G}_k adjacent to u_m in each corn. We call this *single edge* property. Since they are just elementary geometry arguments, we do not precisely prove these isolated and single edge properties, but give explanations in Fig. 4. Thus, there are at most 8 edges adjacent to u_m for each vertex u_m in \mathcal{G}_k . On the other hand, \mathcal{G}_k does not have a loop path by the construction of \mathcal{G}_k . We summarize these results as the following statement.

$$\mathcal{G}_k \text{ is connected without a loop path and the degree of each of its vertices is less than 8.} \quad (4.34)$$

We consider any two clusters G_k , and \bar{G}_k with edges $\{e_j\}$ and vertices $\{u_0 = \mathbf{0}, u_1, \dots, u_k\} \subset \mathbf{Z}^2$, and edges $\{\bar{e}_j\}$ and vertices $\{\bar{u}_0 = \mathbf{0}, \bar{u}_1, \dots, \bar{u}_k\} \subset \mathbf{Z}^2$, respectively. We want to point out that the above vertices are in \mathbf{Z}^2 ordered from u_0, \dots, u_k for both groups. We say that the two clusters are *similar*, denoted by $G_k \sim \bar{G}_k$, if u_i is only adjacent to u_{j_1}, \dots, u_{j_l} , and \bar{u}_i is also only adjacent to $\bar{u}_{j_1}, \dots, \bar{u}_{j_l}$ for each $0 \leq i \leq k$. In other words, if $G_k \sim \bar{G}_k$, then the situations of the connections of the two clusters are the same, but the locations of u_i and \bar{u}_i in the two clusters may not be the same. From now we only consider a cluster with k vertices on \mathbf{Z}^2 and with the single edge property. We can decompose all such the clusters into similar groups $\langle G_k \rangle$, where each G_k is one of the selected cluster in a group. We would like to account how many such groups. We consider a regular tree \mathbf{T} with a degree 8 and a root at the origin. Let A_k be an *animal* defined to be a finite connected subgraph of \mathbf{T} containing the root with k vertices. Let a_k be the number of such animals of A_k . By a standard graph estimate (see (4.24) in Grimmett (1999)),

$$a_k \leq 7^{8k}. \quad (4.35)$$

For each cluster of G_k , it is similar to an animal A_k in \mathbf{T} and two non similar clusters G'_k and G''_k are also corresponding two non similar animals A'_k and A''_k in \mathbf{T} , respectively. Thus, we can find at least one-many-map from G_k to A_k . By (4.35),

$$\text{the number of similar cluster groups in } \langle G_k \rangle \text{ is less than } 7^{8k}. \quad (4.36)$$

With this decomposition,

$$\sum_{u_1, \dots, u_k} P_p(\mathcal{T}_k(\mathbf{0}, u_1, \dots, u_k)) = \sum_{G_k} \sum_{u_1, \dots, u_k} P_p(\mathcal{T}_k(\mathbf{0}, u_1, \dots, u_k), \mathcal{G}_k \sim G_k),$$

where the first sum in the right side takes over all possible similar cluster groups $\langle G_k \rangle$. With these definitions, we show the following lemma.

Lemma 4.1. *If $p < 0.5$, and $k \geq 2$, then for each selected $G_k \in \langle G_k \rangle$ and for all large $n > k$, there exists C independent of k , n and p such that*

$$\sum_{u_1, \dots, u_k} P_p(\mathcal{T}_k(\mathbf{0}, u_1, \dots, u_k), \mathcal{G}_k \sim G_k) \leq C(0.5 - p)^{-1} \sum_{u_1, \dots, u_{k-1}} P_p(\mathcal{T}_{k-1}(\mathbf{0}, u_1, \dots, u_{k-1}), \mathcal{G}_{k-1} \sim G_{k-1}),$$

where $\{u_1, \dots, u_k\} \subset [-2n, 2n]^2$.

Proof. On $\mathcal{G}_k \sim G_k$ for a selected and fixed G_k . Recall that we divided into two cases I_k , II_k (a) and II_k (b). Thus,

$$\begin{aligned} & \sum_{u_1, \dots, u_k} P_p(\mathcal{T}_k(\mathbf{0}, u_1, \dots, u_k), \mathcal{G}_k \sim G_k) = \sum_{u_1, \dots, u_k} P_p(\mathcal{T}_k(\mathbf{0}, u_1, \dots, u_k), \text{case } I_k, \mathcal{G}_k \sim G_k) \\ & + \sum_{u_1, \dots, u_k} P_p(\mathcal{T}_k(\mathbf{0}, u_1, \dots, u_k), \text{case } II_k(\text{a}), \mathcal{G}_k \sim G_k) \\ & + \sum_{u_1, \dots, u_k} P_p(\mathcal{T}_k(\mathbf{0}, u_1, \dots, u_k), \text{case } II_k(\text{b}), \mathcal{G}_k \sim G_k), \end{aligned} \quad (4.37)$$

where cases I_k , II_k (a) and II_k (b) are the connecting situations of edge e_k from u_k to the other pivotal sites. We first focus on the first sum in the right side of (4.37). In case I_k , e_k is adjacent to $\{e_0, \dots, e_{k-1}\}$.

Thus, $u_{k-1} = v_k \in \{\mathbf{0}, v'_0, \dots, v_{k-1}, v'_{k-1}\}$ and $u_k = v'_k$. If u_1, \dots, u_k are fixed, then these disjoint squares constructed in event $\mathcal{T}_k(\mathbf{0}, u_1, \dots, u_k)$ are fixed and disjoint. Thus, these four arm paths occur independently on these disjoint squares. By this observation and using (4.25) for $i + 1 = k$, we have

$$\mathcal{T}_k(\mathbf{0}, u_1, \dots, u_{k-1}), \mathcal{Q}_4(u_k, 0, R_k/4) \text{ occur independently.} \quad (4.38)$$

Since $\mathcal{G}_k \sim G_k$ for a fixed G_k , then e_k is the edge from u_k to $u_i \in \{u_0, \dots, u_{k-1}\}$ for a fixed i . To sum $\{u_1, \dots, u_k\}$, we may first sum all possible $\{u_k\}$ for fixing $\{u_1, \dots, u_{k-1}\}$, and then sum all possible $\{u_1, \dots, u_{k-1}\}$. We fix $\{u_1, \dots, u_{k-1}\}$ and sum all possible u_k . Since the above i is fixed, u_i is fixed. So we sum all u_k from u_i with $\|u_i - u_k\| = l$ for a fixed u_i and sum all l . Moreover, if $\mathcal{G}_k \sim G_k$, after removing u_k and e_k , \mathcal{G}_k and G_k will be \mathcal{G}_{k-1} and G_{k-1} , respectively and $\mathcal{G}_{k-1} \sim G_{k-1}$. With these observations together with (4.38) and Lemma 2.7, there exists C such that

$$\begin{aligned} & \sum_{u_1, \dots, u_k} P_p(\mathcal{T}_k(\mathbf{0}, u_1, \dots, u_k), \mathcal{G}_k \sim G_k, \text{case } I_k) = \sum_{u_1, \dots, u_{k-1}} \sum_{u_k} P_p(\mathcal{T}_k(\mathbf{0}, u_1, \dots, u_k), \mathcal{G}_k \sim G_k, \text{case } I_k) \\ & \leq \sum_{u_1, \dots, u_{k-1}} P_p(\mathcal{T}_k(\mathbf{0}, u_1, \dots, u_{k-1}), \mathcal{G}_{k-1} \sim G_{k-1}) \sum_{l=1}^{\infty} l P_p(\mathcal{Q}_4(l/4)) \\ & \leq C(0.5 - p)^{-1} \sum_{u_1, \dots, u_{k-1}} P_p(\mathcal{T}_k(\mathbf{0}, u_1, \dots, u_{k-1}), \mathcal{G}_{k-1} \sim G_{k-1}), \end{aligned} \quad (4.39)$$

where G_{k-1} is a cluster with vertices $\{u_0, \dots, u_{k-1}\}$ and with $\{e_j\} \setminus e_k$. For each subset $\{e_0, \dots, e_{k-1}\}$ of $\{e_0, \dots, e_{k-1}, e_k\}$, it is just a subset of $\{e_0, \dots, e_{k-1}\}$ itself. Thus,

$$\begin{aligned} & \sum_{u_1, \dots, u_k} P_p(\mathcal{T}_k(\mathbf{0}, u_1, \dots, u_k), \text{case } I_k, \mathcal{G}_k \sim G_k) \\ & \leq C(0.5 - p)^{-1} \sum_{u_1, \dots, u_{k-1}} P_p(\mathcal{T}_{k-1}(\mathbf{0}, u_1, \dots, u_{k-1}), \mathcal{G}_{k-1} \sim G_{k-1}). \end{aligned} \quad (4.40)$$

In case $II_k(a)$, e_k is not adjacent to $\{e_0, \dots, e_{k-1}\}$, but there is an extra edge e' connecting u_i and e_k for a fixed $u_i \in \{u_0, \dots, u_{k-2}\}$, since G_k is fixed. Thus, $u_k = v'_k$, $u_{k-1} = v_k$, and $v_k \notin \{\mathbf{0}, v'_0, \dots, v_{k-1}, v'_{k-1}\}$. By (4.27) for $i + 1 = k$ and the same argument in (4.38), for fixed $\{u_1, \dots, u_k\}$,

$$\mathcal{T}_k(\mathbf{0}, u_1, \dots, u_{k-2}), \mathcal{Q}_4(u_{k-1}, 0, R_k/4), \text{ and } \mathcal{Q}_4(u_k, 0, R_k/4) \text{ occur independently.}$$

By the assumption of case II (a),

$$\mathcal{T}_k(\mathbf{0}, u_1, \dots, u_{k-2}) \cap \mathcal{Q}_4(u_{k-1}, 0, R_k/4) \subset \mathcal{T}_k(\mathbf{0}, u_1, \dots, u_{k-1}). \quad (4.41)$$

With these observations, if we use the same proofs of (4.39) and (4.40) to sum u_k , then

$$\begin{aligned} & \sum_{u_1, \dots, u_k} P_p(\mathcal{T}_k(\mathbf{0}, u_1, \dots, u_k), \text{case } II_k(a), \mathcal{G}_k \sim G_k) \\ & \leq \sum_{u_1, \dots, u_{k-1}} P_p(\mathcal{T}_k(\mathbf{0}, u_1, \dots, u_{k-2}), \mathcal{Q}_4(u_{k-1}, 0, R_k/4), \mathcal{G}_{k-1} \sim G_{k-1}) \sum_{l=1}^{\infty} l P_p(\mathcal{Q}_4(l/4)) \\ & \leq \sum_{u_1, \dots, u_{k-1}} P_p(\mathcal{T}_k(\mathbf{0}, u_1, \dots, u_{k-1}), \mathcal{G}_{k-1} \sim G_{k-1}) \sum_{l=1}^{\infty} l P_p(\mathcal{Q}_4(l/4)) \\ & \leq C(0.5 - p)^{-1} \sum_{u_1, \dots, u_{k-1}} P_p(\mathcal{T}_{k-1}(\mathbf{0}, u_1, \dots, u_{k-1}), \mathcal{G}_{k-1} \sim G_{k-1}). \end{aligned} \quad (4.42)$$

Finally, we work on case $II_k(\text{b})$. We find the same u_i and e' in case $II_k(\text{a})$ for a fixed $u_i \in \{u_0, \dots, u_{k-1}\}$. By (4.29) for $i + 1 = k$,

$$\mathcal{T}(\mathbf{0}, u_1, \dots, u_{k-1}), \mathcal{Q}_4(u_{k-1}, 0, R_k/4), \mathcal{Q}_4(u_k, 0, R_k/4), \mathcal{Q}_4(u_{k-1}, R_k/2, d(u_i, e_k)/4) \text{ occur disjointly.} \quad (4.43)$$

Thus, by using the disjoint property in (4.43), the reconnection lemma, and the same estimate in (4.42), there exists C_1 such that

$$\begin{aligned} & \sum_{u_1, \dots, u_k} P_p(\mathcal{T}_k(\mathbf{0}, u_1, \dots, u_k), \mathcal{G}_k \sim G_k, \text{case } II_k(\text{b})) \\ & \leq \sum_{u_1, \dots, u_{k-1}} P_p(\mathcal{T}_k(\mathbf{0}, u_1, \dots, u_{k-2}), \mathcal{Q}_4(u_{k-1}, 0, R_k/4), \mathcal{Q}_4(u_i, R_k/2, d(e_k, u_i)/4), \mathcal{G}_{k-1} \sim G_{k-1}) \\ & \quad \times \sum_{l=1} P_p(\mathcal{Q}_4(l/4)) \\ & \leq C(0.5 - p)^{-1} \sum_{u_1, \dots, u_{k-1}} P_p(\mathcal{T}_k(\mathbf{0}, u_1, \dots, u_{k-2}), \mathcal{Q}_4(u_{k-1}, 0, d(e_k, u_i)/4), \mathcal{G}_{k-1} \sim G_{k-1}) \\ & \leq C_1(0.5 - p)^{-1} \sum_{u_1, \dots, u_{k-1}} P_p(\mathcal{T}_{k-1}(\mathbf{0}, u_1, \dots, u_{k-1}), \mathcal{G}_{k-1} \sim G_{k-1}). \end{aligned} \quad (4.44)$$

Thus, Lemma 4.1 follows from (4.40), (4.42) and (4.44). \square

With Lemma 4.1, we show the following proposition for higher derivatives of $\kappa(p)$.

Proposition 2. *If $p < 0.5$, then for any integers n and $n > k \geq 1$, there exists C independent of k , n and p such that*

$$|d^k G_p(n/2, n)/dp^k| \leq C^k L^{-2}(p)(0.5 - p)^{-k-2}$$

and

$$|d^{k+2} \kappa(p)/dp^{k+2}| \leq C^k L^{-2}(p)(0.5 - p)^{-k-2}.$$

Remark 4. In the proof of Proposition 2, k is finite independent of p and n , but large in order to control the constants in Propositions 1-2. By using the same estimate of Morrow and Zhang (2005), one can show that

$$|d^{k+2} \kappa(p)/dp^{k+2}| \leq C(k) L^{-2}(p)(0.5 - p)^{-k-2}$$

for some constant $C(k)$ depending on k , but this is not good enough to show the Theorem. We need a better upper bound $C^k L^{-2}(p)(0.5 - p)^{-k-2}$.

Proof of Proposition 2. By using Lemma 4.1, for each selected $G_k \in \langle G_k \rangle$, we iterate

$$\sum_{u_1, \dots, u_k} P_p(\mathcal{T}_k(\mathbf{0}, u_1, \dots, u_k), \mathcal{G}_k \sim G_k)$$

in $(k - 1)$ times for fixed signs I_1, \dots, I_k and for $\{u_1, \dots, u_k\} \subset [-2n, 2n]^2$ to show

$$\sum_{u_1, \dots, u_k} P_p(\mathcal{T}_k(\mathbf{0}, u_1, \dots, u_k), \mathcal{G}_k \sim G_k) \leq C^{k-1}(0.5 - p)^{-k+1} \sum_{u_1} P_p(\mathcal{T}_2(\mathbf{0}, u_1)). \quad (4.45)$$

By using Proposition 1 in the right side of (4.45), if $\{u_1, \dots, u_k\} \subset [-2n, 2n]^2$, then

$$\sum_{u_1, \dots, u_k} P_p(\mathcal{T}_k(\mathbf{0}, u_1, \dots, u_k), \mathcal{G}_k \sim G_k) \leq C_1^k (0.5 - p)^{-k-2} L^{-2}(p). \quad (4.46)$$

By (4.35), (4.36), and (4.46),

$$\begin{aligned} & \sum_{u_1, \dots, u_k} P_p(\mathcal{T}_k(\mathbf{0}, u_1, \dots, u_k)) \\ = & \sum_{G_k} \sum_{u_1, \dots, u_k} P_p(\mathcal{T}_k(\mathbf{0}, u_1, \dots, u_k), \mathcal{G}_k \sim G_k) \leq 7^{8k} C_1^k (0.5 - p)^{-k-2} L^{-2}(p). \end{aligned} \quad (4.47)$$

By (4.30)-(4.31) and (4.47), note that each sign I_j only has two choices, so there exists C_2 independent of k , p and n such that

$$|d^k R_{AB}(p, n/2, n)/dp^k| \leq 2^k \sum_{b, f_1, f_2, \dots, f_k} P_p(\mathcal{R}_{AB}(b, f_1, f_2, \dots, f_k, n)) \leq C_2^k (0.5 - p)^{-k-2} L^{-2}(p). \quad (4.48)$$

Similarly, we can work on $|d^k R_i(p, n)/dp^k|$ for $i = 2, 3$ to have the same upper bound in (4.48).

Thus, by using (4.48) and the same upper bound of (4.48) for $|d^k R_i(p, n)/dp^k|$ in (4.19) but with $R_{AB}(p, n/2, n)$ and $R_i(p, n/2, n)$ instead, there exists C independent of p , k and n such that

$$|d^k G_p(n/2, n)/dp^k| \leq C^k L^{-2}(p) (0.5 - p)^{-k-2}. \quad (4.49)$$

If we let $n \rightarrow \infty$ in (4.49), by (3.35),

$$|d^{k+2} \kappa(p)/dp^{k+2}| = \lim_{n \rightarrow \infty} |d^k G_p(n)/dp^k| = \lim_{n \rightarrow \infty} |d^k G_p(n/2, n)/dp^k| \leq C^k L^{-2}(p) (0.5 - p)^{-k-2}. \quad (4.50)$$

Proposition 2 follows from (4.49) and (4.50). \square

Now we show the following proposition for an estimate of a convergent rate of $d^k G_p(n)/dp^k$ to $d^{k+2} \kappa(p)/dp^{k+2}$.

Proposition 3. *If $p < 0.5$ and $n \geq 2mL(p)$ for a large $m \geq k^3$ and for a large k , then there exists C independent of k , m and p such that*

$$|d^k G_p(n)/dp^k - d^{k+2} \kappa(p)/dp^{k+2}| \leq e^{-Cm/k} L^{-2}(p) (0.5 - p)^{-k-2}.$$

Remark 5. The estimate in Proposition 3 is not optimal, but it is good enough to show the Theorem. We also want to point out that m is large, but independent of p . In other words, the upper bound in the inequality of Proposition 3 is large for p near 0.5.

Proof of Proposition 3. We work on $\mathcal{T}_k(\mathbf{0}, u_1, \dots, u_k)$ for $\{u_1, \dots, u_k\} \subset [-n, n]^2$. Let $Y_j = R_1 + \dots + R_j$ for $R_j = \|v_j - v'_j\|$ defined before. Note that \mathcal{G}_k is a connected graph as we discussed before, so if $\{u_1, \dots, u_k\} \not\subset [-2mL(p), 2mL(p)]^2$, then

$$Y_k \geq mL(p).$$

For a fixed G_k , we decompose $\mathcal{T}_k(\mathbf{0}, u_1, \dots, u_k)$ by using Y_j to have

$$\sum_{u_1, \dots, u_k} P_p(\mathcal{T}_k(\mathbf{0}, u_1, \dots, u_k), \mathcal{G}_k \sim G_k, Y_k \geq mL(p)) = \sum_{mL(p) \leq l} \sum_{u_1, \dots, u_k} P_p(\mathcal{T}_k(\mathbf{0}, u_1, \dots, u_k), \mathcal{G}_k \sim G_k, Y_k = l).$$

On $Y_k = l$, note that $R_k \geq R_{k-1} \geq \dots \geq R_1$, so $R_k \geq l/k$. By the same proof of Lemma 4.1 to discuss the cases I_k , II_k (a) and (b), if we sum all possible u_k with $R_k \geq l/k$, then there exists C in Lemma 4.1 such that

$$\begin{aligned} & \sum_{mL(p) \leq l} \sum_{u_1, \dots, u_k} P_p(\mathcal{T}_k(\mathbf{0}, u_1, \dots, u_k), \mathcal{G}_k \sim G_k, Y_k = l) \\ & \leq C \sum_{u_1, \dots, u_{k-1}} P_p(\mathcal{T}_k(\mathbf{0}, u_1, \dots, u_{k-1}), \mathcal{G}_{k-1} \sim G_{k-1}) \sum_{l \geq mL(p)/k} l P_p(\mathcal{Q}_4(l/4k)). \end{aligned} \quad (4.51)$$

By Lemma 2.7, there exist C_i for $i = 1, 2, 3, 4$ independent of k and p such that

$$\sum_{l \geq mL(p)/k} l P_p(\mathcal{Q}_4(l/4)) \leq C_1 (0.5 - p)^{-1} \sum_{l \geq mL(p)/k} e^{-C_2 l/k} \leq C_3 e^{C_4 m/l} (0.5 - p)^{-1}. \quad (4.52)$$

By using Proposition 2 for the second sum and using (4.52) for the third sum in the right side of (4.51), there exists C_5 independent of p , k and n such that

$$\sum_{G_k} \sum_{m \leq l} \sum_{u_1, \dots, u_k} P_p(\mathcal{T}_k(\mathbf{0}, u_1, \dots, u_k), \mathcal{G}_k \sim G_k, Y_k = l) \leq C_5^k L^{-2}(p) (0.5 - p)^{-k-2} e^{-C_4 m/k}. \quad (4.53)$$

Thus, by (4.35), (4.51), and (4.53), if $m \geq k^3$ for a large k , there exists C independent of p and k such that

$$\sum_{u_1, \dots, u_k} P_p(\mathcal{T}_k(\mathbf{0}, u_1, \dots, u_k), Y_k \geq mL(p)) \leq \exp(-Cm/k) L^{-2}(p) (0.5 - p)^{-k-2}. \quad (4.54)$$

By (4.18),

$$d^k R_{AB}(p, n/2, n)/dp^k = \sum_{I_1, \dots, I_k} \sum_{b, f_1^{I_1}, f_2^{I_1, I_2}, \dots, f_k^{I_1, I_2, \dots, I_k}} I_1 I_2 \dots I_k P_p(\mathcal{R}_{AB}(b, f_1^{I_1}, f_2^{I_1, I_2}, \dots, f_k^{I_1, \dots, I_k}, n)). \quad (4.55)$$

For fixed I_1, \dots, I_k , let

$$d^k R_{AB}(p, n, I_1, \dots, I_k)/dp^k = \sum_{b, f_1^{I_1}, f_2^{I_1, I_2}, \dots, f_k^{I_1, I_2, \dots, I_k}} P_p(\mathcal{R}_{AB}(b, f_1^{I_1}, f_2^{I_1, I_2}, \dots, f_k^{I_1, \dots, I_k}, n)). \quad (4.56)$$

If $\{b, f_1^{I_1}, f_2^{I_1, I_2}, \dots, f_k^{I_1, I_2, \dots, I_k}\} \subset [-n/2, n/2]^2$, then let

$$d^k R_{AB}(p, n/2, n, I_1, \dots, I_k)/dp^k = \sum_{b, f_1^{I_1}, f_2^{I_1, I_2}, \dots, f_k^{I_1, I_2, \dots, I_k}} P_p(\mathcal{R}_{AB}(b, f_1^{I_1}, f_2^{I_1, I_2}, \dots, f_k^{I_1, \dots, I_k}, n)). \quad (4.57)$$

We can also define in the same ways for $d^k R_i(p, n, I_1, \dots, I_k)/dp^k$ and $d^k R_i(p, n/2, n, I_1, \dots, I_k)/dp^k$ for $i = 2, 3$, respectively. By Lemma 3.2, if $p < 0.5$, note that there is no infinite occupied cluster, so the following limit exists:

$$\begin{aligned} & \lim_{n \rightarrow \infty} d^k R_{AB}(p, n/2, n, I_1, \dots, I_k)/dp^k = \lim_{n \rightarrow \infty} d^k R_{AB}(p, n, I_1, \dots, I_k)/dp^k \\ & = \lim_{n \rightarrow \infty} \sum_{b, f_1^{I_1}, f_2^{I_1, I_2}, \dots, f_k^{I_1, I_2, \dots, I_k}} P_p(\mathcal{R}_{AB}(b, f_1^{I_1}, f_2^{I_1, I_2}, \dots, f_k^{I_1, \dots, I_k}, n)) = d^k R_{AB}(p, \infty, I_1, \dots, I_k)/dp^k. \end{aligned} \quad (4.58)$$

If one of pivotal satisfies $\|f_j^{I_1, \dots, I_j}\| \geq 2mL(p)$, then $\|u_i\| \geq 2mL(p)$ for some i . Thus,

$$\begin{aligned} & P_p(\mathcal{R}_{AB}(b, f_1^{I_1}, f_2^{I_1, I_2}, \dots, f_k^{I_1, \dots, I_k}, n) \text{ with } \|f_j^{I_1, \dots, I_j}\| \geq 2mL(p) \text{ for some } j) \\ & \leq P_p(\mathcal{T}_k(\mathbf{0}, u_1, \dots, u_k) \text{ with } \|u_i\| \geq 2mL(p) \text{ for some } i) \end{aligned} \quad (4.59)$$

for $\{b, f_1^{I_1}, f_2^{I_1, I_2}, \dots, f_k^{I_1, I_2, \dots, I_k}\} \subset [-n/2, n/2]^2$. By (4.58), (4.59), and (4.54), if $n \geq 2mL(p)$ for $m \geq k^3$, then there exists C independent of k , n , and p such that

$$\begin{aligned} & d^k R_{AB}(p, \infty, I_1, \dots, I_k)/dp^k - \exp(-C(m/k))L^{-2}(p)(0.5 - p)^{-k-2} \\ & \leq d^k R_{AB}(p, n/2, n, I_1, \dots, I_k)/dp^k \leq d^k R_{AB}(p, \infty, I_1, \dots, I_k)/dp^k. \end{aligned} \quad (4.60)$$

Similarly, if $n \geq 2mL(p)$ for $m \geq k^3$, then

$$\begin{aligned} & d^k R_i(p, \infty, I_1, \dots, I_k)/dp^k - \exp(-C(m/k))L^{-2}(p)(0.5 - p)^{-k-2} \\ & \leq d^k R_i(p, n/2, n, I_1, \dots, I_k)/dp^k \leq d^k R_i(p, \infty, I_1, \dots, I_k)/dp^k. \end{aligned} \quad (4.61)$$

It follows from (4.18) and the definition of $R_{AB}(p, n/2, n)$ that for any fixed I_1, \dots, I_k ,

$$d^k R_{AB}(p, n/2, n, I_1, \dots, I_k)dp^k \leq d^k R_{AB}(p, n, I_1, \dots, I_k)/dp^k \leq d^k R_{AB}(p, \infty, I_1, \dots, I_k)/dp^k. \quad (4.62)$$

By (4.60)-(4.62), and (4.58),

$$\begin{aligned} & d^k R_{AB}(p, \infty, I_1, \dots, I_k)/dp^k - \exp(-C(m/k))L^{-2}(p)(0.5 - p)^{-k-2} \\ & \leq d^k R_{AB}(p, n, I_1, \dots, I_k)/dp^k \leq d^k R_{AB}(p, \infty, I_1, \dots, I_k)/dp^k, \end{aligned} \quad (4.63)$$

and

$$\begin{aligned} & d^k R_i(p, \infty, I_1, \dots, I_k)/dp^k - \exp(-C(m/k))L^{-2}(p)(0.5 - p)^{-k-2} \\ & \leq d^k R_i(p, n, I_1, \dots, I_k)/dp^k \leq d^k R_i(p, \infty, I_1, \dots, I_k)/dp^k. \end{aligned} \quad (4.64)$$

Note that each I_j only has two choices, so by (4.63)-(4.64), so if $m \geq k^3$ for a large k , there exists C independent of p and k and n such that for A, B ,

$$|d^k R_{AB}(p, \infty)/dp^k - d^k R_{AB}(p, n)/dp^k| \leq \exp(-C(m/k))L^{-2}(p)(0.5 - p)^{-k-2}. \quad (4.65)$$

and for $i = 2, 3$

$$|d^k R_i(p, \infty)/dp^k - d^k R_i(p, n)/dp^k| \leq \exp(-C(m/k))L^{-2}(p)(0.5 - p)^{-k-2}. \quad (4.66)$$

With these observations, we are ready to show Proposition 3. Note that by (4.19),

$$\begin{aligned} & d^k \kappa(p)/dp^k = \lim_{n \rightarrow \infty} d^k G_p(n)/dp^k \\ & = \sum_{j=1}^{k-1} \sum_{A, B} f_{AB}(p) d^k R_{AB}(p, \infty)/dp^k + 2f_{1,2,3}(p) \sum_{i=2,3} d^k R_i(p, \infty)/dp^k + \\ & + \left[\sum_{j=1}^{k-1} [f_j(p) d^j R_{AB}(p, \infty)/dp^j + \sum_{j=1}^{k-1} g_j(p) \sum_{i=2,3} d^j R_i(p, \infty)/dp^j] + h_k(p, \infty) \right]. \end{aligned} \quad (4.67)$$

If $m \geq k^3$ for a large m , but independent of p and n , for $n \geq 2mL(p)$, by (4.19), and (4.65)-(4.67), there exists C independent of k and p and n such that

$$\begin{aligned} |d^k \kappa(p)/dp^k - d^k G_p(n)/dp^k| &\leq 4k \exp(-C_4 m/k) L^{-2}(p) (0.5 - p)^{-k-2} + h_k(p, \infty) \\ &\leq \exp(-C(m/k)) L^{-2}(p) (0.5 - p)^{-k-2} + h_k(p, \infty). \end{aligned} \quad (4.68)$$

As we mentioned in Remark 5, $h_k(p, \infty)$ is uniformly bounded and $\exp(-C(m/k)) L^{-2}(p) (0.5 - p)^{-k-2}$ is large for p near 0.5, so Proposition 3 follows from (4.68). \square .

5 An estimate for $G_{p_2}(L(p_2)) - G_{p_1}(L(p_2))$.

Recall the definition of $G_p(n)$ in section 3. We know that $G_p(n)$ converges uniformly to $\kappa''(p)$ on $[0, 0.5]$. We select a sequence $\{p_j\}$ for $j = 1, 2, \dots$ such that $p_j \uparrow 0.5$. In addition, p_1 is selected for a large $L(p_1)$ and p_j is selected such that for some large $M > 2$,

$$\iota(0.5 - p_j) \leq p_{j+1} - p_j \text{ and } \frac{L(p_{j+1})}{L(p_j)} = M, \quad (5.1)$$

where ι is a positive constant independent of for all p_j and M . The existence of such a sequence in (5.1) can be proved as follows. In fact, by the reconnection lemma, Lemma 2.2, (1.14), and (2.9), we have

$$(0.5 - p_j) = (0.5 - p_{j+1}) M^{3/4+o(1)}. \quad (5.2)$$

So

$$(0.5 - p_j)(1 - M^{-3/4+o(1)}) = (p_{j+1} - p_j). \quad (5.3)$$

By (5.3), ι in (5.1) exists uniformly for all p_j and M . Now we show the following proposition.

Proposition 4. *For $\delta = 0.1$ and a fixed large $M > 0$ defined in (5.1), there exists $\alpha = \alpha(M)$ independent of $\{p_j\}$ defined in (5.1) such that for any p_j either*

$$(a) \quad d^{i+2} \kappa(p_{j-1})/dp_{j-1}^{i+2} \leq -\alpha L^{-2}(p_{j-1}) (0.5 - p_{j-1})^{-i-2} \text{ for some } 1 \leq i \leq \log M,$$

or

$$(b) \quad G_{p_{j-1}}(L(p_j)) - G_{p_j}(L(p_j)) \leq -M^{-\delta/2+o(1)} L(p_{j-1}) (0.5 - p_{j-1})^{-2}.$$

Proof. We take $\epsilon = M^{-1+\delta}$. We decompose

$$\begin{aligned} G_{p_{t-1}}(L(p_t)) - G_{p_t}(L(p_t)) &= [G_{p_{t-1}}(L(p_t)) - G_{p_{t-1}}(\epsilon L(p_t))] + [G_{p_{t-1}}(\epsilon L(p_t)) - G_{p_t}(\epsilon L(p_t))] \\ &\quad [-G_{p_t}(L(p_t)) + G_{p_t}(\epsilon L(p_t))] = I + II + III, \end{aligned} \quad (5.4)$$

where I, II, III are the differences in the three square brackets in (5.4). By (3.42), if $\epsilon = M^{-1+\delta}$, then there exists C_1 independent of M and p_t such that

$$\begin{aligned} I &= [G_{p_{t-1}}(L(p_t)) - G_{p_{t-1}}(\epsilon L(p_t))] = [G_{p_{t-1}}(L(p_t)) - G_{p_{t-1}}(M^\delta L(p_{t-1}))] \\ &\leq \exp(-C_1 M^\delta) L^{-2}(p_{t-1}) (0.5 - p_{t-1})^{-2}. \end{aligned} \quad (5.5)$$

By (3.41), (5.1), and (5.2), if $\epsilon = M^{-1+\delta}$, then

$$\begin{aligned} III &= [-G_{p_t}(L(p_t)) + G_{p_t}(\epsilon L(p_t))] \\ &\leq -\epsilon^{-1/2} M^{-1/2+o(1)} L^{-2}(p_{t-1})(0.5 - p_{t-1})^{-2} \leq -M^{-\delta/2+o(1)} L^{-2}(p_{t-1})(0.5 - p_{t-1})^{-2}. \end{aligned} \quad (5.6)$$

We now work on II. For each large M , let $(i_0!)^{1/4} = M$. Thus, for a large M , by using Stirling's formula,

$$i_0 \leq \log M. \quad (5.7)$$

By Proposition 2, if we choose a large i_0 but fixed and for $i \geq i_0$ such that

$$(i!)^{1/2} M^\delta \geq (i!)^{1/4} \geq C^i \text{ for the } C \text{ in Proposition 2,}$$

then

$$d^i G_{p_{t-1}}(\epsilon L(p_t)) / dp_{t-1}^i \geq -(i!)^{1/2} M^{-\delta} L^{-2}(p_{t-1})(p_t - p_{t-1})^{-i-2}. \quad (5.8)$$

For $1 \leq i \leq i_0 \leq (\log M)$, we first assume that

$$d^i G_{p_{t-1}}(\epsilon L(p_t)) / dp_{t-1}^i \geq -(i!)^{1/4} M^{-\delta+o(1)} L^{-2}(p_{t-1})(p_t - p_{t-1})^{-i-2}, \quad (5.9)$$

for each $1 \leq i \leq i_0 - 1$ with a large M . By Taylor's theorem, there exists $\xi \in (p_{t-1}, p_t)$ such that

$$G_{p_t}(\epsilon L(p_t)) - G_{p_{t-1}}(\epsilon L(p_t)) = \sum_{k=1}^{K-1} (p_t - p_{t-1})^k \frac{d^k(G_{p_{t-1}}(\epsilon L(p_t)))}{k! dp_{t-1}^k} + (p_t - p_{t-1})^K \frac{d^K(G_\xi(\epsilon L(p_t)))}{K! d\xi^K}. \quad (5.10)$$

By (5.8) and the assumption (5.9), for a large $K > M$,

$$\sum_{k=1}^{K-1} (p_t - p_{t-1})^k \frac{d^k(G_{p_{t-1}}(\epsilon L(p_t)))}{k! dp_{t-1}^k} \geq -M^{-\delta+o(1)} L^{-2}(p_{t-1})(0.5 - p_{t-1})^{-2} \sum_{k=1}^{K-1} (k!)^{-1/2+o(1)}.$$

Thus,

$$\sum_{k=1}^{K-1} (p_t - p_{t-1})^k \frac{d^k(G_{p_{t-1}}(\epsilon L(p_t)))}{k! dp_{t-1}^k} \geq -M^{-\delta+o(1)} L^{-2}(p_{t-1})(0.5 - p_{t-1})^{-2}. \quad (5.11)$$

Let us work on the remainder in (5.10). By Proposition 2, (5.1)-(5.3), and Stirling's formula, note that $\delta = 0.1 \leq 1/2$, so for large K and for the C in Proposition 2,

$$\begin{aligned} (p_t - p_{t-1})^K \left| \frac{d^K(G_\xi(\epsilon L(p_t)))}{K! d\xi^K} \right| &\leq C^K (p_t - p_{t-1})^K L^{-2}(\xi)(0.5 - \xi)^{-K-2}/K! \\ &\leq C^K e^K M^{3K/4} L^{-2}(p_{t-1})(0.5 - p_{t-1})^{-2}/K! \leq (eCM/K)^K L^{-2}(p_{t-1})(0.5 - p_{t-1})^{-2}. \end{aligned} \quad (5.12)$$

By taking K large in (5.12),

$$(p_t - p_{t-1})^K \left| \frac{d^K(G_\xi(\epsilon L(p_t)))}{K! d\xi^K} \right| \leq M^{-2\delta+o(1)} L(p_{t-1})(0.5 - p_{t-1})^{-2}. \quad (5.13)$$

By substituting (5.12) and (5.13) into (5.10), for a large M

$$G_{p_t}(\epsilon L(p_t)) - G_{p_{t-1}}(\epsilon L(p_t)) \geq -M^{-\delta+o(1)} L^{-2}(p_{t-1})(0.5 - p_{t-1})^{-2}. \quad (5.14)$$

Thus, by (5.14) for a large M ,

$$II = G_{p_{t-1}}(\epsilon L(p_t)) - G_{p_t}(\epsilon L(p_t)) \leq M^{-\delta+o(1)} L^{-2}(p_{t-1})(0.5 - p_{t-1})^{-2}. \quad (5.15)$$

If we use the estimates in (5.5), (5.6) and (5.15) together for a large M in (5.4), III dominates in (5.4). So Proposition 4 (b) follows.

We now assume that (5.9) does not hold. In other words, for some $1 \leq i \leq i_0 \leq \log M$,

$$d^i G_{p_{t-1}}(\epsilon L(p_t))/dp_{t-1}^i < -(i!)^{1/4} M^{-\delta+o(1)} L^{-2}(p_{t-1})(p_t - p_{t-1})^{-i-2}. \quad (5.16)$$

It remains to show that (5.16) implies Proposition 4 (a). Note that $\epsilon L(p_t) = M^{\delta+o(1)} L(p_{t-1})$ and $i \leq i_0 \leq \log M$, so by Proposition 3 and (5.16) for a large M with $M^\delta > i^3$,

$$\begin{aligned} d^{i+2} \kappa(p_{t-1})/dp_{t-1}^{i+2} &\leq d^i G_{p_{t-1}}(\epsilon L(p_t))/dp_{t-1}^i + \exp(-M^{\delta+o(1)}/i) L^{-2}(p_{t-1})(0.5 - p_{t-1})^{-i-2} \\ &\leq \left(-(i!)^{1/4+o(1)} M^{-\delta+o(1)} + \exp(-M^{\delta/2+o(1)}) \right) L^{-2}(p_{t-1})(0.5 - p_{t-1})^{-i-2} \\ &\leq -(i!)^{1/4+o(1)} M^{-\delta+o(1)} L^{-2}(p_{t-1})(0.5 - p_{t-1})^{-i-2}. \end{aligned} \quad (5.17)$$

Thus, there exist $1 \leq i \leq i_0$ and $\alpha = \alpha(M)$ such that

$$d^{i+2} \kappa(p_{t-1})/dp_{t-1}^{i+2} \leq -\alpha L^{-2}(p_{t-1})(0.5 - p_{t-1})^{-i-2}. \quad (5.18)$$

(5.18) indeed implies Proposition 4 (a). Therefore, Proposition 4 follows. \square .

6 Proof of theorem.

6.1 Proof of the upper bound of the theorem.

If $p < 0.5$, then by Proposition 2 and (2.3), there exists C independent of p such that

$$|\kappa'''(p)| \leq CL^{-2}(p)(0.5 - p)^{-3} \leq (0.5 - p)^{-1/3+o(1)}. \quad (6.1)$$

If $p > 0.5$, by (1.5), we still have (6.1).

6.2 Proof of the lower bound of the theorem.

We use the sequence $\{p_j\}$ in (5.1) for large M such that

$$\iota(0.5 - p_j) \leq p_{j+1} - p_j \text{ and } \frac{L(p_{j+1})}{L(p_j)} = M. \quad (6.2)$$

By Proposition 4, for given M and $K = \log M$, there exist $C = C(M)$ independent of p_j such that either

$$d^{i+2} \kappa(p_{j-1})/dp_{j-1}^{i+2} \leq -CL^{-2}(p_{j-1})(p_j - p_{j-1})^{-i-2} = -(p_j - p_{j-1})^{-i+2/3+o(1)} \text{ for some } 1 \leq i \leq K, \quad (6.3)$$

or

$$G_{p_j}(L(p_j)) - G_{p_{j-1}}(L(p_j)) \geq M^{-\delta/2+o(1)} L(p_{j-1})(0.5 - p_{j-1})^{-2}. \quad (6.4)$$

We assume that (6.4) holds. By (3.33), we take $n \geq L^2(p_j)$ large such that

$$\left| \kappa''(p_j) - G_{p_j}(n) \right| \leq \exp(-L(p_j)) \text{ and } \left| \kappa''(p_{j-1}) - G_{p_{j-1}}(n) \right| \leq \exp(-L(p_j)). \quad (6.5)$$

Thus,

$$\begin{aligned}
& \kappa''(p_j) - \kappa''(p_{j-1}) = \\
& \left[\kappa''(p_j) - G_{p_j}(n) \right] + \left[G_{p_{j-1}}(n) - \kappa''(p_{j-1}) \right] + \left[G_{p_j}(n) - G_{p_j}(L(p_j)) \right] \\
& + \left[G_{p_j}(L(p_j)) - G_{p_{j-1}}(L(p_j)) \right] + \left[-G_{p_{j-1}}(n) + G_{p_{j-1}}(L(p_j)) \right] \\
& = I + II + III + IV + V,
\end{aligned} \tag{6.6}$$

where I, II, III, IV, V are the differences in the five square brackets in (6.6). By (6.5) and (2.3),

$$|I| \leq (0.5 - p_j)^2 \text{ and } |II| \leq (0.5 - p_j)^2. \tag{6.7}$$

By (3.40), (6.2) and (5.2), there exists C_1 independent of M such that

$$III = G_{p_j}(n) - G_{p_j}(L(p_j)) \geq C_1 L^{-2}(p_j)(0.5 - p_j)^{-2} \geq M^{-1/2+o(1)} L^{-2}(p_{j-1})(0.5 - p_{j-1})^{-2}. \tag{6.8}$$

By (6.4),

$$IV = G_{p_j}(L(p_j)) - G_{p_{j-1}}(L(p_j)) \geq M^{-\delta/2+o(1)} L^{-2}(p_{j-1})(0.5 - p_{j-1})^{-2}. \tag{6.9}$$

By (3.42) and (5.1), there exist C_2 and C_3 independent of M such that

$$|V| \leq C_2 \exp(-C_3 M) L^{-2}(p_{j-1})(0.5 - p_{j-1})^{-2}. \tag{6.10}$$

Thus, III and IV will dominate the others in (6.6) for a large M . Together with (6.7)–(6.10), if M is large, but a fixed number, then

$$\kappa''(p_j) - \kappa''(p_{j-1}) \geq M^{-\delta/2+o(1)} L^{-2}(p_{j-1})(0.5 - p_{j-1})^{-2}. \tag{6.11}$$

We want to remark that M is selected large depending only on C_1, C_2 , and C_3 in (6.9) and (6.10) such that (6.11) holds. This selection of M is uniformly for all $\{p_j\}$. Thus, $K = \log M$ is also a fixed number uniformly for all $\{p_j\}$ in (6.3). By the mean value theorem, (6.11), (5.3), and (2.3), there exist $\xi_j \in (p_{j-1}, p_j)$ and $C_4 = C_4(M)$ independent of ξ such that

$$\begin{aligned}
& \kappa'''(\xi_j) \geq M^{-\delta/2+o(1)} L^{-2}(p_{j-1})(0.5 - p_{j-1})^{-2} (p_j - p_{j-1})^{-1} \\
& \geq M^{-\delta/2+o(1)} L^{-2}(p_{j-1})(0.5 - p_{j-1})^{-3} \geq M^{-3/4-\delta/2+o(1)} L^{-2}(p_j)(0.5 - p_j)^{-3} \\
& \geq M^{-3/4-\delta/2+o(1)} (0.5 - \xi_j)^{-1/3+o(1)} \geq C_4 (0.5 - \xi_j)^{-1/3+o(1)}.
\end{aligned} \tag{6.12}$$

Now we assume that (6.3) holds. For the sequence $\{p_j\}$ defined in (5.1), there exists $C_5 = C_5(M)$ for the $M = \log K$ defined in Proposition 4 such that

$$|d^{i+2} \kappa(p_j) / dp_j^{i+2}| \geq C_5 L^{-2}(p_j)(0.5 - p_j)^{-i-2} \text{ for some } 1 \leq i \leq K. \tag{6.13}$$

(6.12) and (6.13) show that $\kappa(p)$ has a singularity at 0.5. Moreover, together with (6.12), we want to show that $\kappa(p)$ is not third differentiable. We only need to discuss that $i \geq 2$ and show (6.13) to hold for $i + 1$. Let $f_i(p) = d^i \kappa(p) / d^i p$. We show that if (6.13) does not hold for $i + 1$, then there would be a contradiction. We assume that there is $\epsilon > 0$ such that for $p \in [p_j - \epsilon(p_j - p_{j-1}), p_j]$,

$$|f_{i+1}(p)| \leq \epsilon (C_5/8) L^{-2}(p_j)(0.5 - p_j)^{-i-1}. \tag{6.14}$$

By (6.14), we take $x = p_j - \epsilon(p_j - p_{j-1})/2$ and $y = p_j - \epsilon(p_j - p_{j-1})$ such that

$$|f_{i+1}(y)| \leq \epsilon(C_5/8)L^{-2}(p_j)(0.5 - p_j)^{-i-1} \text{ and } |f_{i+1}(x)| \leq \epsilon(C_5/8)L^{-2}(p_j)(0.5 - p_j)^{-i-1}. \quad (6.15)$$

If we use the mean value theorem for $f_{i+1}(p)$ at y and x , then by (5.3) there exists $z \in (p_j - \epsilon(p_j - p_{j-1}), p_j - \epsilon(p_j - p_{j-1})/2)$ such that

$$|d^{i+2}\kappa(z)/dz^{i+2}| \leq (C_5/2)L^{-2}(p_j)(0.5 - p_j)^{-i-2}. \quad (6.16)$$

If we use the mean value theorem again for $f_{i+2}(p)$ at z and p_j , then by (5.1), (6.13), and (6.16), there exists $\beta \in (p_j - \epsilon(p_j - p_{j-1}), p_j)$ such that

$$\left| \frac{d^{i+3}\kappa(\beta)}{d\beta^{i+3}} \right| \geq (C_5/2)L^{-2}(p_j)(0.5 - p_j)^{-i-2}\epsilon^{-1}(p_j - p_{j-1})^{-1} \geq (C_5/2)M^{-1}L^{-2}(\beta)(0.5 - \beta)^{-i-3}\epsilon^{-1}. \quad (6.17)$$

By taking $\epsilon = (C_5/4)^{-1}M^{-1}C^i$ in (6.17) for the C defined in Proposition 2,

$$|d^{i+3}\kappa(\beta)/d\beta^{i+3}| \geq 2C^iL^{-2}(\beta)(0.5 - \beta)^{-i-3}. \quad (6.18)$$

On the other hand, by Proposition 2,

$$|d^{i+3}\kappa(\beta)/d\beta^{i+3}| \leq C^iL^{-2}(\beta)(0.5 - \beta)^{-i-3}. \quad (6.19)$$

(6.18) and (6.19) cannot hold together, so (6.14) cannot hold. Thus, for $i \geq 2$, there exists $\alpha \in (p_j - \epsilon(p_j - p_{j-1}), p_j)$ such that

$$|d^{i+1}\kappa(\alpha)/d\alpha^{i+1}| \geq \epsilon(C_5/8)L^{-2}(p_j)(0.5 - p_j)^{-i-1} \geq \epsilon(C_5/8)L^{-2}(\alpha)(0.5 - \alpha)^{-i-1}. \quad (6.20)$$

Thus, there exist $\alpha \in (p_{j-1}, p_j)$ and $C_6 = C_6(M, K)$ such that

$$|d^{i+1}\kappa(\alpha)/d\alpha^{i+1}| \geq C_6L^{-2}(\alpha)(0.5 - \alpha)^{-i-1}. \quad (6.21)$$

We continue this way for $i - 1$ times to show that there is $\alpha \in (p_{j-1}, p_j)$ such that

$$|d^3\kappa(\alpha)/d\alpha^3| \geq C_7L^{-2}(\alpha)(0.5 - \alpha)^{-3} \text{ for some } C_7 = C_7(M). \quad (6.22)$$

Therefore, the lower bound of the Theorem follows from (6.12) and (6.22) for $p < 0.5$. If $p > 0.5$, the lower bound of the Theorem follows from (1.5), (6.12) and (6.22). \square

References

- Aizenman, M., Dulantier, B. and Alharony, A. (1999). Path-crossing exponents and the external perimeter in 2D percolation. *Phy. Rev. Lett.* **63**, 817–835.
- Dunford, N. and Schwartz, T. (1958). *Linear operators*. **1**, Wiley-Interscience, New York.
- Grimmett, G. (1981). On the differentiability of the number of clusters per vertex in percolation model. *J. Lond. Math. Soc.* (2) **23**, 372–384.
- Grimmett, G. (1999). *Percolation*. Springer-Verlag, New York.
- Higuchi, Y., Takei, M. and Zhang, Y. (2012). Scaling relations for two-dimensional Ising percolation. *J.*

Stat. Phys. **148**, 777–799.

Kesten, H. (1982). *Percolation Theory for Mathematicians*. Birkhauser, Boston.

Kesten, H. (1987). Scaling relations for 2D-percolation. *Comm. Math. Phys.* **109**, 109–156.

Kesten, H., Sidoravicius, V. and Zhang, Y. (1998). Almost all words are seen in critical site percolation on the triangular lattice. *Electron. J. Probab.* **3** no. 10, 75pp.

Lawler, G. F., Schramm, O. and Werner, W. (2002) One-arm exponent for critical 2D percolation. *Electron. J. Probab.* **7**, 13pp.

Morrow, G. J. and Zhang, Y. (2005). The sizes of the pioneering, lowest crossing and pivotal sites in critical percolation on the triangular lattice. *Ann. Appl. Probab.* **5**, 1832–1886.

Smirnov, S. (2001). Critical percolation in the plane: conformal invariance, Cardy’s formula, scaling limits. *CR. Acad. Sci. I-Math.* **333**, 239–244.

Smirnov, S. and Werner, W. (2001). Critical exponent for two dimensional percolation. *Math. Res. Lett.* **8**, 729–744.

Sykes, M. F., and Essam, J. W. (1964). Exact critical percolation probabilities for site and bond problems in two dimensions. *J. Math. Phys.* **5**, 1117–1127.

Zhang, Y. (2011). A derivative formula for the free energy function *J. Stat. Phys.* **146**, 466–473.

Yu Zhang

Department of Mathematics

University of Colorado

Colorado Springs, CO 80933

yzhang3@uccs.edu