

# THE DEHN FILLING SPACE OF A CERTAIN HYPERBOLIC 3-ORBIFOLD

SADAYOSHI KOJIMA AND SHIGERU MIZUSHIMA

ABSTRACT. We construct the first example of a “one-cusped” hyperbolic 3-orbifold for which we see the true shape of the space of hyperbolic Dehn fillings.

## 1. INTRODUCTION

The hyperbolic Dehn filling theory was established by W. Thurston in his original note [8]. Besides the general theory, he extensively analyzed the space of Dehn fillings of the figure eight knot complement in terms of the decomposition by two ideal tetrahedra. The analysis led us to extremely fascinated research activities on Dehn fillings in the last 25 years.

One of unsolved problems in his analysis was to determine the global shape of the Dehn filling space. Since then, there have been many deep researches such as [4, 2] discussing this problem in fact, however it is still mysterious. Even, though W. Neumann and A. Reid [7] have determined the true shape for the Whitehead link complement with one cusp component being complete, there seems to be no concrete examples of “one-cusped” hyperbolic manifolds or orbifolds for which we see the true shape of the Dehn filling space. In this paper, we construct hopefully the first such example of an orbifold, regretfully rather than a manifold.

The example we present here is topologically  $\mathbb{Z}_2 \times \mathbb{Z}_2$ -covered as an orbifold by the complement of a seven component link in the connected sum of three copies of  $\mathbf{S}^2 \times \mathbf{S}^1$ . Based on the study of one-circle packings on complex affine tori by the second author in [6], we construct the example, which we will denote by  $N$ , and its all possible Dehn filling deformations in the following three sections. Then using careful analysis of deformations of such tori in [6] again, we determine the global shape of the Dehn filling space of  $N$  in subsequent two sections.

## 2. CONSTRUCTION

We start with the *hexagonal packing*  $\mathcal{P}$  on the complex plane  $\mathbb{C}$  by equi-radii circles, see Figure 1. The set of euclidean translations which leave  $\mathcal{P}$  invariant forms a group  $\Gamma$  acting freely on  $\mathbb{C}$ . It is isomorphic to  $\mathbb{Z} \times \mathbb{Z}$  and the quotient is a particular euclidean torus admitting a cyclic symmetry of order 6, which we call the *hexagonal torus*.  $\mathcal{P}$  then descends to what we call a one-circle packing on the hexagonal torus.

Let us regard the complex plane  $\mathbb{C}$  as the boundary of the upper half space model  $\mathbb{H}^3$  of the hyperbolic 3-space.  $\mathcal{P}$  together with the dual packing  $\mathcal{P}^*$  which consists

---

2000 *Mathematics Subject Classification.* Primary 57M50; Secondary 52C15, 30F99.  
*Key words and phrases.* hyperbolic 3-manifold, orbifold, cone-manifold, Dehn filling.  
 The first author was supported in part by JSPS Grant 12440015.

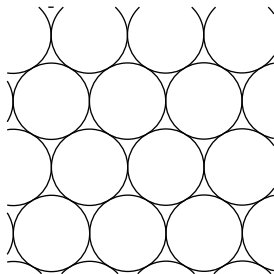

FIGURE 1. Hexagonal packing

of circumscribed circles of interstices in  $\mathcal{P}$  fills  $\mathbb{C}$ . Each member of both  $\mathcal{P}$  and  $\mathcal{P}^*$  bounds a hemisphere in  $\mathbb{H}^3$  and such a hemisphere bounds a hemiball facing  $\mathbb{C}$ . Cutting off those hemiballs from  $\mathbb{H}^3$ , we obtain a region  $L$  with ideal polygonal boundary in  $\mathbb{H}^3$ . The intersections of  $\mathcal{P}$  and  $\mathcal{P}^*$  correspond to ideal vertices of  $L$  with rectangular section.

The group  $\Gamma$  acts properly discontinuously on  $\mathbb{H}^3$  by the Poincaré extensions and the region  $L$  is invariant under the action. Hence taking quotient, we obtain a hyperbolic 3-manifold  $N$  with ideal polygonal boundary and a cusp. The polygonal boundary consists of two ideal triangles and one ideal hexagon, where they intersect orthogonally.

Take the double of  $N$  along triangular faces, and then take again the double of the result along the boundary which now consists of two ideal hexagons. This double doubling construction gives us a hyperbolic 3-manifold  $M$  with seven cusps among which 4 are old and 3 new. It is obvious by the construction that  $M$  admits a  $\mathbb{Z}_2 \times \mathbb{Z}_2$ -symmetry generated by two reflections associated to the doubling.  $N$  is the quotient of  $M$  by this symmetry and therefore we regard  $N$  as an orbifold from now on, and study its Dehn filling deformations as an orbifold.

Topologically  $N$  is a solid torus with a core loop and three points on the boundary removed. To see the effect on the first double, stretch the removed vertices on  $\partial N$  to arcs appropriately so that they become circles after doubling. Then by first doubling, we obtain a genus 3 handle body with two core loops and three loops on the boundary removed. This is depicted in Figure 2, where the shaded disks represent triangular faces along which we took the double.

A framed link representation of  $M$ , the double of Figure 2, can be immediately described by Figure 3.

### 3. CIRCLE PACKINGS ON COMPLEX AFFINE TORI

We will construct Dehn filling deformations of  $N$  using deformations of the hexagonal packing on  $\mathbb{C}$  with the same combinatorial type. The hexagonal packing descends to a one-circle packing on the hexagonal torus. Conversely, a one-circle packing on the torus combinatorially equivalent to one on the hexagonal torus is universal covered by a packing on the plane equivalent to the hexagonal packing. However since the hexagonal packing is rigid in euclidean geometry, there are no other one-circle packings on euclidean tori than one on the hexagonal torus. Hence to get deformations, we will work with one-circle packings not on euclidean but

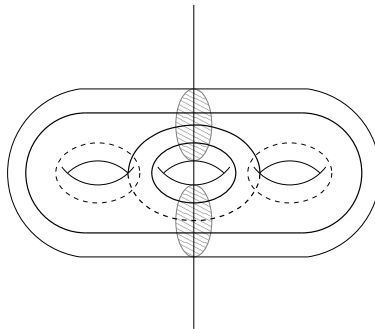
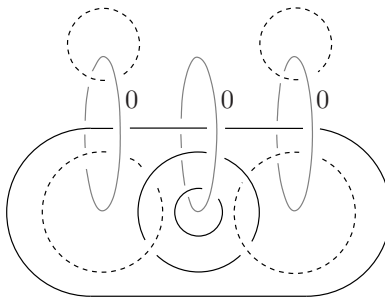

FIGURE 2. First double

FIGURE 3. Framed link representation of  $M$ 

rather on complex affine tori. This section is to review what has been known about complex affine tori and circle packings on them according to [3, 6].

A *complex affine structure* on the torus is by definition a collection of local charts on  $\mathbb{C}$  whose transition function is a restriction of a complex affine transformation, so in particular it defines a complex structure. The uniformization assigning the conformal class to each affine torus defines a map of the space  $\mathcal{A}$  of marked complex affine tori to the Teichmüller space  $\mathcal{H}$  of the torus. It is a natural complex line bundle projection, where the fiber is parameterized by explicit description of developing maps of affine structures under some normalization as we will see below.  $\mathcal{H}$  is identified with the upper half plane  $\mathbb{H}^2$  in  $\mathbb{C}$  and hence  $\mathcal{A}$  is homeomorphic to the product  $\mathbb{H}^2 \times \mathbb{C}$ . We call the first factor a *Teichmüller parameter*  $\omega \in \mathbb{H}^2$  and the second an *affine parameter*  $c \in \mathbb{C}$ . Complex affine tori sharing the same  $\omega$  are conformally equivalent. We denote by  $T_{\omega,c}$  the marked complex affine torus associated to  $(\omega, c) \in \mathbb{H}^2 \times \mathbb{C}$ . Also we denote by  $\alpha, \beta$  specified simple closed curves generating the fundamental group of the torus for marking.

The zero section of the line bundle  $\mathbb{H}^2 \times \mathbb{C} \rightarrow \mathbb{H}^2$  precisely consists of euclidean structures. In this case, the developing map

$$\text{dev} : \tilde{T}_{\omega,0} \rightarrow \mathbb{C},$$

is a homeomorphism, and the images of  $\alpha$  and  $\beta$  by the holonomy  $\rho$  are translations defined for each  $z \in \mathbb{C}$  by

$$\begin{cases} \rho(\alpha) : z \mapsto z + 1 \\ \rho(\beta) : z \mapsto z + \omega \end{cases}$$

after appropriate normalization.

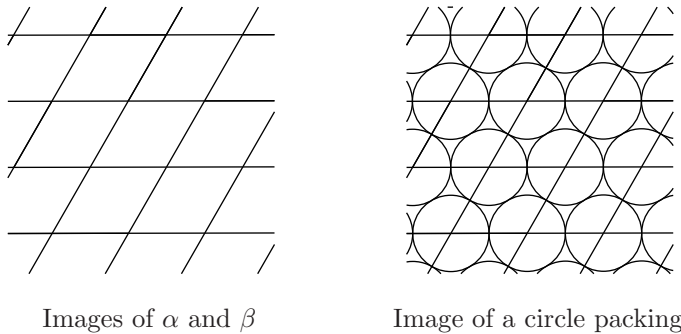

FIGURE 4. Developed image of torus with euclidean structure

In affine but non-euclidean case, identifying the universal cover  $\tilde{T}_{\omega,c}$  with  $\tilde{T}_{\omega,0} \cong \mathbb{C}$  by the uniformization, the developing map is described by an exponential map

$$\text{dev} : z \mapsto e^{cz}$$

under the identification of  $\mathcal{A}$  with  $\mathbb{H}^2 \times \mathbb{C}$ . Here  $\omega$  and  $c$  are the Teichmüller and affine parameters of the complex affine torus in question. The images of  $\alpha, \beta$  by the holonomy  $\rho$  are obviously similarities

$$\begin{cases} \rho(\alpha) : z \mapsto e^c z \\ \rho(\beta) : z \mapsto e^{c\omega} z \end{cases}$$

which fix the origin.

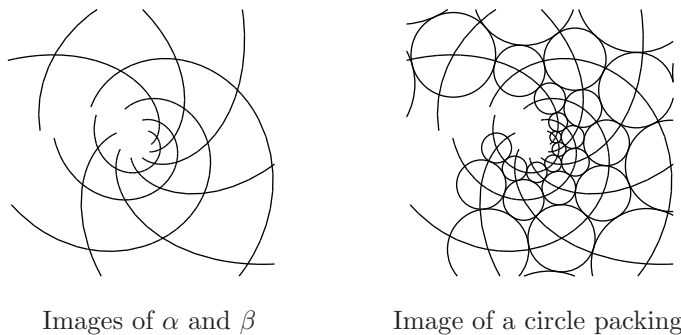

FIGURE 5. Developed image of torus with complex affine structure

Since a complex affine transformation is a similarity, it sends a circle on  $\mathbb{C}$  to a circle. Hence we can still discuss about circle packings on complex affine tori. The second author showed in [6] that the set of complex affine tori which admit

a one-circle packing forms a real two-dimensional moduli space  $\mathcal{M}$  in  $\mathbb{H}^2 \times \mathbb{C}$ . In constructing the moduli space, the marking for the packing was specified so that the edges of the nerve of the packing are homotopic to  $\alpha$ ,  $\beta$  and  $\beta\alpha^{-1}$ . The moduli space  $\mathcal{M}$  contains only one euclidean torus associated to  $\omega_0 = e^{\pi i/3}$ , which is the hexagonal one. Moreover, the restriction of the uniformization  $\mathbb{H}^2 \times \mathbb{C} \rightarrow \mathbb{H}^2$  to  $\mathcal{M}$  is onto and two to one except at the hexagonal torus. The affine parameters of a generic fiber consist of nonzero  $c$  and its negative  $-c$ .

#### 4. DEFORMATIONS

To each pair  $(\omega, c)$  on the moduli space  $\mathcal{M}' = \mathcal{M} - \{(\omega_0, 0)\}$ , we construct a Dehn filling deformation of  $N$  as an orbifold based on the construction of  $N$ . To see this, we start with a complex affine torus  $T_{\omega, c}$  packed by one circle combinatorially equivalent to the one-circle packing on  $T_{\omega_0, 0}$ . The developing map of  $T_{\omega, c}$  is an exponential map and  $\mathbb{Z}$ -covers  $\mathbb{C} - \{0\}$ . Thus if we let  $X$  be the universal cover of  $\mathbb{C} - \{0\}$ , it canonically lifts to a homeomorphism  $\tilde{T}_{\omega, c} \rightarrow X$ . By mapping a circle packing on  $\tilde{T}_{\omega, c}$  to  $X$ , we obtain a circle packing  $\mathcal{P}_{\omega, c}$  on  $X$  combinatorially equivalent to the hexagonal packing on  $\mathbb{C}$ . Also the holonomy lifts uniquely to an injective homomorphism of  $\pi_1(T_{\omega, c}) \cong \mathbb{Z} \times \mathbb{Z}$  to the group of transformations of  $X$ . We denote its image by  $\Gamma_{\omega, c}$ .

Then we let  $\ell$  denote the geodesic in  $\mathbb{H}^3$  joining 0 and  $\infty$ . The universal cover  $Y$  of  $\mathbb{H}^3 - \ell$  will be a substitution of  $\mathbb{H}^3$  in the euclidean case. In fact, cutting off hemiballs in  $Y$  bounded by the members of a deformed hexagonal packing  $\mathcal{P}_{\omega, c}$  and its dual  $\mathcal{P}_{\omega, c}^*$  on  $X$ , we obtain a region  $L_{\omega, c}$  with ideal polygonal boundary in  $Y$ . Also since the action of  $\Gamma_{\omega, c}$  on  $X$  extends to a properly discontinuous action on  $Y$  which leaves  $L_{\omega, c}$  invariant, by taking a quotient we obtain a hyperbolic 3-manifold with ideal polygonal boundary and incomplete end near  $\ell$ . We denote its completion by  $N_{\omega, c}$ . It carries a Dehn surgery type singularity by definition, see [8], and we thus obtain to each  $(\omega, c)$  in  $\mathcal{M}'$  a Dehn filling deformation of  $N = N_{\omega_0, 0}$ .

On the other hand, let  $N_*$  be a Dehn filled deformation of  $N$  as an orbifold and  $R$  a manifold obtained from  $N_*$  by removing the points attached by the completion.  $R$  is homeomorphic to the torus times  $[0, 1)$  with three points on the boundary removed. The boundary of  $R$  consists of two ideal triangles and one ideal hexagon, where they intersect orthogonally. Choose a developing map  $D$  of  $R$  so that a neighborhood of an incomplete end winds  $\ell$  in  $\mathbb{H}^3$ . By this normalization, the holonomy of  $R$  maps  $\pi_1(R) \cong \mathbb{Z} \times \mathbb{Z}$  to transformations fixing 0 and  $\infty$ , the image of the holonomy contains an element of infinite order by the definition of the Dehn filling deformation.

$R$  is not complete, but not so wild. Let  $U$  be an equidistant neighborhood of an incomplete end and  $B$  its complement. It is obvious that any point in  $R$  admits the unique shortest path to  $\partial U = \partial B$ . Thus  $U$  is developed to an equidistant neighborhood of  $\ell$  and  $B$  its complement. In particular, the image of the developing map  $D$  misses  $\ell$ , and  $D$  is in fact a map of the universal cover  $\tilde{R}$  into  $\mathbb{H}^3 - \ell$ . Then  $D$  lifts to a map  $\tilde{D}$  of the universal cover  $\tilde{R}$  to  $Y$ , the universal cover of  $\mathbb{H}^3 - \ell$ . Accordingly, the holonomy of  $R$  lifts to a homomorphism to the group of transformations of  $Y$ . We denote its image by  $\Gamma_*$ .

Let  $Z$  be the preimage of the boundary of the equidistant neighborhood of  $\ell$  in  $Y$ .  $\Gamma_*$  acts properly discontinuously and freely on  $Z$  by the definition of the Dehn filling deformation, and  $Z$  bijectively corresponds to the preimage of  $Z$  by  $\tilde{D}$ . This

shows that  $\tilde{D}$  is injective at least on a neighborhood of the preimage of  $Z$  by  $\tilde{D}$ . We will show that  $\tilde{D}$  is globally injective. Suppose we have two points in  $\tilde{R}$  mapped by  $\tilde{D}$  to a point  $y \in Y$ .  $y$  admits the unique shortest path to the point  $y_0$  on  $Z$ . Since the preimage of  $Z$  by  $\tilde{D}$  bijectively corresponds to the preimage of  $\partial U = \partial B$  in  $\tilde{R}$ , the preimage of  $y_0$  consists of a single point  $n_0$ . Hence two points in question lie on the orthogonal path to the preimage of  $\partial U = \partial B$  through  $n_0$  on the same side with the same distance to  $n_0$ . Thus they must be the same.

Then the ideal hexagonal faces on the boundary of  $\tilde{R}$  in the developed image define a packing on  $X$ , the universal cover of  $\mathbb{C} - \{0\}$ , combinatorially equivalent to the hexagonal one. Moreover the packing is invariant under the induced action of  $\Gamma_*$  on  $X$ . Hence it descends to a one-circle packing on some affine torus  $T_{\omega,c}$  parameterized by some pair  $(\omega, c) \in \mathcal{M}'$ , and  $N_*$  is isometric to  $N_{\omega,c}$ .

## 5. DEHN FILLING COEFFICIENTS

Following [6], we review how to find a pair  $(\omega, c)$  lying on the moduli space  $\mathcal{M}'$ . If  $(\omega, c)$  lies on  $\mathcal{M}'$ , a simple observation shows that  $\omega$  and  $c$  must satisfy the identities,

$$(5.1) \quad \frac{\cos \operatorname{Im}(c/2)}{\cosh \operatorname{Re}(c/2)} = \frac{\cos \operatorname{Im}(c\omega/2)}{\cosh \operatorname{Re}(c\omega/2)} = \frac{\cos \operatorname{Im}(c(\omega-1)/2)}{\cosh \operatorname{Re}(c(\omega-1)/2)}.$$

Moreover, the inequalities

$$|\operatorname{Im}(c)| < \pi, \quad |\operatorname{Im}(c\omega)| < \pi, \quad |\operatorname{Im}(c(\omega-1))| < \pi$$

must be satisfied by obvious reason. Let  $f : \mathbb{C} \rightarrow [0, 1)$  be a smooth function defined by

$$f(z) = 1 - \frac{\cos \operatorname{Im}(z/2)}{\cosh \operatorname{Re}(z/2)},$$

where

$$\mathcal{C} = \{z \in \mathbb{C} \mid |\operatorname{Im}(z)| < \pi\}$$

is the largest possible region for  $c$  to vary in  $\mathcal{M}$ . The identity (5.1) shows that  $c$ ,  $c\omega$  and  $c(\omega-1)$  lie on the same level set  $L_s = \{z \in \mathcal{C} \mid f(z) = s\}$ . When  $s = 0$ ,  $L_0$  consists of a single point corresponding to the hexagonal torus by simple computation. For each  $0 < s < 1$ ,  $L_s$  is topologically a simple loop around the origin, has symmetries about the real and imaginary axis, and bounds a strictly convex interior.

For  $c \in \mathcal{C}' = \mathcal{C} - \{0\}$ , the origin  $0$ ,  $c$ ,  $c\omega$  and  $c(\omega-1)$  form a parallelogram by obvious reason in plane geometry. Conversely, if  $c \in \mathcal{C}'$  is given and let  $L_s$  be the level set on which  $c$  lies, then there are unique two points  $c_1, c_2$  on  $L_s$  so that  $c, c_1, c_2$  lie in counterclockwise order on  $L_s$ , and they together with the origin form a parallelogram. Then we obtain a pair  $(\omega, c)$  in the moduli space  $\mathcal{M}'$  by letting  $\omega = c_1/c$ . Hence  $c \in \mathcal{C}'$  determines  $\omega$ . In view of this fact, we identify the moduli space  $\mathcal{M}'$  with the region  $\mathcal{C}'$ .

In the level set  $L_s$  for  $0 < s < 1$ , there are twelve special points depicted in Figure 6 which give rise to pairs on  $\mathcal{M}'$  rather obviously. Here,  $p_1$  and  $p_7$  are intersections with the real axis. Similarly  $p_4, p_{10}$  lie on the imaginary axis.  $p_i$  for  $i = 2, 3, 5, 6, 8, 9, 11, 12$  are points such that  $p_3p_{11}, p_5p_9, p_2p_6$  and  $p_8p_{12}$  are the bisectors of the segments  $0p_1, 0p_4, 0p_7$  and  $0p_{10}$  where  $0$  is the origin in  $\mathcal{C} \subset \mathbb{C}$ . Three points  $p_i, p_{i+2}, p_{i+4} \pmod{12}$  together with the origin  $0$  form a parallelogram

and give rise to a pair on  $\mathcal{M}'$ . As  $s$  decreases from 1 toward 0, an ellipselike closed curve  $L_s$  shrinks down to a point  $L_0$ , however the order of  $p_i$ 's on the level set never changes. Hence the trace of  $p_j$  defines a locus  $l_j$  in the region  $\mathcal{C}$ , and  $\mathcal{C}$  is divided by these loci into twelve regions denoted by  $C_1, \dots, C_{12}$  as in Figure 7.

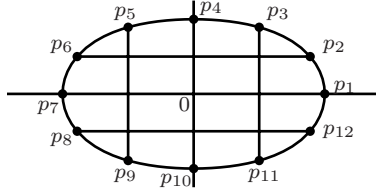

FIGURE 6.

 12 points on  $L_s$ 

FIGURE 7.

 12 regions on  $\mathcal{C}$ 

To each pair  $(\omega, c)$  on the moduli space  $\mathcal{M}'$ , we choose four points  $0, c, c\omega, c(\omega-1)$  which form a parallelogram. Choosing the origin and the third and fourth vertices  $c\omega, c(\omega-1)$ , and adding the negative of the second one at the end, we obtain a next parallelogram spanned by  $0, c\omega, c(\omega-1), -c$ . Doing the same shift twice, we obtain parallelograms spanned by  $0, c(\omega-1), -c, -c\omega$  and  $0, -c, -c\omega, -c(\omega-1)$ . The last one is symmetric to the original parallelogram about the origin. This shows that the moduli space  $\mathcal{M}' = \mathcal{C}'$  has a rotational symmetry of order 6. On the other hand, the complex conjugation gives an orientation reversing involutive symmetry. Thus by these all together, the moduli space  $\mathcal{M}' = \mathcal{C}'$  admits a dihedral symmetry of order 12.

Regarding  $\alpha, \beta$  as a meridian-longitude pair for  $N$ , we discuss the hyperbolic Dehn filling coefficients of  $N_{\omega, c}$ . Recall that  $\rho(\alpha)$  is a similarity defined by  $z \mapsto e^c z$  and  $\rho(\beta)$  by  $z \mapsto e^{c\omega} z$  for nonzero  $c$ . Then the Dehn filling coefficients  $(\mu, \lambda) \in \mathbb{R}^2$  for  $N_{\omega, c}$  is by definition, see [8], a continuous solution of the equation

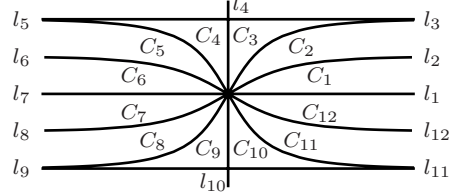
$$\rho(\alpha)^\mu \rho(\beta)^\lambda = \text{rotation by } \pm 2\pi$$

under the normalization that  $\rho(\alpha), \rho(\beta)$  go to the identity when the structure approaches the complete one. More precisely for our choice of  $c$  and  $\omega$ , the Dehn filling coefficient  $(\mu, \lambda)$  of  $N_{\omega, c}$  is a solution of the linear equation

$$(5.2) \quad \mu c + \lambda c\omega = \pm 2\pi i.$$

Note that a pair  $(\omega, c)$  corresponds to  $\pm(\mu, \lambda)$  and conversely a pair  $(\mu, \lambda)$  to  $(\omega, \pm c)$ . We define  $(\mu, \lambda)$  for  $c = 0$  as  $(\infty, \infty)$ .

To each finite Dehn filling coefficient  $(\mu, \lambda)$ , we assign a slopelike number  $t = \mu/(\mu + \lambda)$ , where the slope is  $\mu/\lambda$  by definition. Though  $(\omega, c)$  corresponds to coordinates  $\pm(\mu, \lambda)$ , the unique  $t$  is assigned for them. Dividing (5.2) on both sides by  $\mu + \lambda$  and taking the real parts, we obtain an obvious identity,

$$\operatorname{Re}(tc + (1-t)c\omega) = 0,$$

which shows how to read off  $t$  with respect to the Dehn filling coefficient of  $N_{\omega, c}$  by an elementary plane geometry in  $\mathbb{C}$  as follows.  $c$  and  $c\omega$  lie on the same level set of  $f$  in  $\mathcal{C}'$ . Here we draw the straight line through  $c$  and  $c\omega$ . Then the intersection of the line with the imaginary axis is the point which divides the segment connecting  $c$  and  $c\omega$  in  $1-t$  to  $t$ .

For our convenience, we define a function  $T : \mathcal{C}' \rightarrow \mathbb{R} \cup \{\infty\}$  by assigning  $t = \mu/(\mu + \lambda)$  to each  $c \in \mathcal{C}' = \mathcal{M}'$ . It is easy to see that the level set of  $T$  at  $t = -1, 0, 1/2, 1, 2, \infty$  coincide with the union of  $l_1$  and  $l_7$ , the union of  $l_2$  and  $l_8, \dots$ , the union of  $l_6$  and  $l_{12}$ . When  $c$  moves along the level set of  $f$  in counterclockwise direction,  $c\omega$  does the same. Hence  $T$  is strictly increasing along a counterclockwise move on the level set of  $f$  except a gap at  $t = \infty$ .

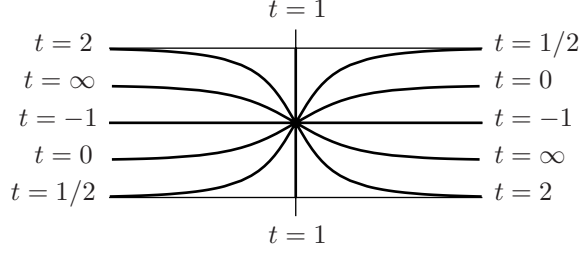

FIGURE 8.

Choose a point  $c$  in the region  $C_3$ , then  $t$  assigned lies in  $(1/2, 1)$ . When  $c$  moves along the level set of  $T$  toward the boundary of  $\mathcal{C}$ ,  $c\omega$  must move along the level set of  $T$  in  $C_5$ . Since  $\text{Re}(c\omega)$  goes to  $-\infty$  and  $\text{Re}(tc + (1-t)c\omega)$  remains zero,  $\text{Re}(c)$  must go to  $\infty$ . The limit of the curve  $l_3$  is  $\infty + \pi i$ , and this gives  $\text{Im}(c) \rightarrow \pi$ . On the other hand, by (5.1),  $\cos \text{Im}(c\omega/2) = \cos \text{Im}(c(\omega - 1)/2) \cosh \text{Re}(c\omega/2) / \cosh \text{Re}(c(\omega - 1)/2)$ . Since  $\cos \text{Im}(c(\omega - 1)/2)$  is bounded and  $\cosh \text{Re}(c\omega/2) / \cosh \text{Re}(c(\omega - 1)/2)$  is asymptotically  $e^{-\text{Re}c/2}$ ,  $\cos \text{Im}(c\omega/2)$  converges to 0 and the limit of  $\text{Im}(c\omega)$  is  $\pi$ . Thus,  $tc + (1-t)c\omega \rightarrow \pi i$ , and we have

$$2tc + 2(1-t)c\omega \rightarrow 2\pi i.$$

This shows that  $(\mu, \lambda) \rightarrow \pm(2t, 2(1-t))$  and  $\mu + \lambda \rightarrow \pm 2$ .

By the dihedral symmetry of the moduli space, we can calculate the limit for other  $t$ . The image of the Dehn filling coefficients  $(\mu, \lambda)$  parameterized by the moduli space  $\mathcal{M} = \mathcal{C}$  then covers the shaded region  $\mathcal{D}$  in Figure 9, and the boundary consists of a hexagon as follows:

$$\begin{aligned} & \{(\mu, \lambda) \mid \mu + \lambda = 2, \mu \geq 0, \lambda \geq 0\} \cup \{(\mu, \lambda) \mid \mu = 2, -2 \leq \lambda \leq 0\} \\ & \cup \{(\mu, \lambda) \mid \lambda = -2, 0 \leq \mu \leq 2\} \cup \{(\mu, \lambda) \mid \mu + \lambda = -2, \mu \leq 0, \lambda \leq 0\} \\ & \cup \{(\mu, \lambda) \mid \mu = -2, 0 \leq \lambda \leq 2\} \cup \{(\mu, \lambda) \mid \lambda = 2, -2 \leq \mu \leq 0\}. \end{aligned}$$

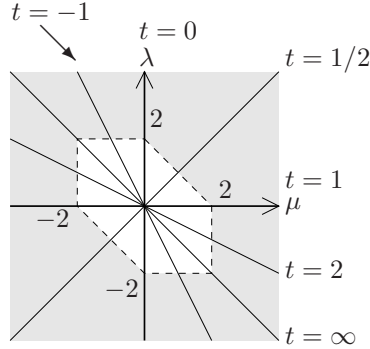

FIGURE 9. Dehn filling space



## 6. DEGENERATIONS

We check how the degeneration occurs when they approach the boundary.

We first think of the deformations along the path defined by the level set of  $T$  at  $t = 1$ . Then the deformations are realized by hyperbolic cone-manifolds and the meridian loop  $\alpha$  bounds a disk hitting the cone singularity. See [1] for details about cone-manifolds. Since

$$|\operatorname{Im}(c)| \rightarrow \pi \quad \text{and} \quad |\operatorname{Re}(c\omega)| \rightarrow \infty,$$

the cone angle converges to  $\pi$  and the length of the singular locus diverges. In fact, the Dehn filled manifold splits along an euclidean sub cone-manifold, a disk with two corner of angle  $\pi/2$  and a cone point of cone angle  $\pi$ , at the limit. The same result holds when  $t = 0$  and  $t = \infty$  because of the dihedral symmetry.

More generally, choose coprime integers  $p$  and  $q$  and think of the deformations of  $N$  along the path on the level set of  $T$  at  $t = p/(p+q)$ . Then again the deformations are realized by cone-manifolds and a loop homotopic to  $\alpha^p\beta^q$  bounds a disk hitting the cone singularity. For  $t \in (0, 1)$ , the level set of  $T$  lies in  $C_2 \cup I_3 \cup C_3$ . When the deformations approach the boundary along this path,  $\operatorname{Re}(c) \rightarrow \infty$ ,  $\operatorname{Im}(c) \rightarrow \pi$ ,  $\operatorname{Re}(c\omega) \rightarrow -\infty$  and  $\operatorname{Im}(c\omega) \rightarrow \pi$ . The calculation similar to one in the previous section shows that

$$|\operatorname{Im}(pc + qc\omega)| \rightarrow |(p+q)\pi|,$$

and hence the cone angle converges to  $(p+q)\pi$ . To see the length of the singular locus, we choose integers  $r$  and  $s$  such that  $ps - qr = 1$ . Then,  $\alpha^r\beta^s$  represents a curve which intersects  $\alpha^p\beta^q$  once and hence the translation factor of  $\rho(\alpha^r\beta^s)$ , or equivalently  $\operatorname{Re}(rc + sc\omega)$  represents the length of the singular locus. Making use of the property  $\operatorname{Re}(pc + qc\omega) = 0$ , we have

$$|\operatorname{Re}(rc + sc\omega)| = \left| \frac{rq - ps}{q} \operatorname{Re}(c) \right| \rightarrow \infty,$$

which implies that the length of the singular locus diverges and a corresponding cone-manifold splits as before. We can see similar facts for other rational  $t$  by the dihedral symmetry. In fact, the cone angle approaches  $|p|\pi$  if  $t > 1$  and  $|q|\pi$  if  $t < 0$ . In either case, the length of the singular locus diverges.

## 7. REMARK

If we relax the complex affine structure modeled on  $\mathbb{C}$  to the complex projective structure modeled on the Riemann sphere, the relaxation defines the involution  $\tau$  on  $\mathbb{H}^2 \times \mathbb{C}$  which sends  $(\omega, c)$  to  $(\omega, -c)$ . The moduli space  $\mathcal{M}_*$  of complex projective tori admitting a one-circle packing is the quotient of  $\mathcal{M}$  by  $\tau$ . This space is studied in [5] by the cross ratio parameters and represented as a semi algebraic set by

$$\mathcal{M}_* = \{(x, y, z) \mid xyz - x - y - z = 0, x, y, z > 0\},$$

see the appendix in [5].

Assigning the holonomy representation to each projective structure, we obtain a map

$$\mathcal{M}_* \rightarrow \mathbb{H}^2 \times \mathbb{C}/\tau \rightarrow X(\pi_1),$$

of  $\mathcal{M}_*$  to the space  $X(\pi_1)$  of representations of the fundamental group of the torus in  $\operatorname{PGL}(2, \mathbb{C})$  up to conjugation. It is a regular map with respect to the algebraic structures on the source and target, and easily seen to be a proper injective

homeomorphism by concrete computation in [5]. This in particular implies also that the boundary we described here is the true one since holonomy representations diverge at the boundary.

## REFERENCES

- [1] D. Cooper, C. Hodgson and S. Kerckhoff: *Three-dimensional orbifolds and cone-manifolds*, MSJ Memoirs, **5** (2000).
- [2] J. Dowty: *Orthlength and hyperbolic Dehn surgery*, Ph.D. thesis, Melbourne Univ., 2001.
- [3] R. C. Gunning: *Affine and projective structures on Riemann surfaces*, Riemann surfaces and related topics: Ann. of Math. Stud., **97** (1981), 225-244.
- [4] C. Hodgson: *Degeneration and regeneration of geometric structures on three-manifolds*, Ph.D. thesis, Princeton Univ., 1986.
- [5] S. Kojima, S. Mizushima and S. P. Tan: *Circle packings on surfaces with projective structures*, preprint. Available at <http://www.arXiv.org/abs/math.GT/0111214>.
- [6] S. Mizushima: *Circle packings on complex affine tori*, Osaka J.Math., **37** (2000), 873-881.
- [7] W. D. Neumann and A. Reid: *Arithmetic of hyperbolic manifolds*, Topology '90, ed. by B. Apanasov et al, de Gruyter, (1992), 273-310.
- [8] W. P. Thurston: *The geometry and topology of 3-manifolds*, Lecture Notes, Princeton Univ., 1977/78.

DEPARTMENT OF MATHEMATICAL AND COMPUTING SCIENCES, TOKYO INSTITUTE OF TECHNOLOGY, MEGURO, TOKYO 152-8552 JAPAN

*E-mail address:* `sadayosi@is.titech.ac.jp`

DEPARTMENT OF MATHEMATICAL AND COMPUTING SCIENCES, TOKYO INSTITUTE OF TECHNOLOGY, MEGURO, TOKYO 152-8552 JAPAN

*E-mail address:* `mizusima@is.titech.ac.jp`