

Complexity of geometric three-manifolds

Bruno MARTELLI

Carlo PETRONIO

July 26, 2021

Abstract

We compute for all orientable irreducible geometric 3-manifolds certain complexity functions that approximate from above Matveev's natural complexity, known to be equal to the minimal number of tetrahedra in a triangulation. We can show that the upper bounds on Matveev's complexity implied by our computations are sharp for thousands of manifolds, and we conjecture they are for infinitely many, including all Seifert manifolds. Our computations and estimates apply to all the Dehn fillings of $M6_1^3$ (the complement of the three-component chain-link, conjectured to be the smallest triply cusped hyperbolic manifold), whence to infinitely many among the smallest closed hyperbolic manifolds. Our computations are based on the machinery of the decomposition into 'bricks' of irreducible manifolds, developed in a previous paper. As an application of our results we completely describe the geometry of all 3-manifolds of complexity up to 9.

MSC (2000): 57M27 (primary), 57M50 (secondary).

Contents

1	Complexity computations	4
2	Decomposition of manifolds into bricks	12
3	Slopes and θ-graphs on the torus	17
4	Complexity of atoroidal manifolds: generalities and Seifert case	24
5	Complexity of hyperbolic manifolds	37
6	Complexity of Seifert manifolds and torus bundles	46
7	Tables of small manifolds	56

Introduction

The complexity $c(M)$ of a closed orientable 3-manifold M was defined in [11] as the minimal number of vertices of a simple spine of M . In the same paper it was shown that c is additive under connected sum and that, if M is irreducible, $c(M)$ equals the minimal number of tetrahedra in a triangulation of M , unless M is S^3 , \mathbb{RP}^3 , or $L_{3,1}$. This means that indeed $c(M)$ is a very natural measure of how complicated M is. Despite this fact, $c(M)$ is only known for a finite number of M 's. In this paper we give upper bounds for the complexity of a wide class of M 's, including many of the smallest known hyperbolic manifolds, all Seifert manifolds, and all torus bundles over the circle. To be more precise we will introduce a sequence $(c_n)_{n=0}^{\infty}$ of functions with values in $\mathbb{N} \cup \{\infty\}$ such that, given M , the sequence $(c_n(M))_{n=0}^{\infty}$ is non-increasing and has constant value $c(M)$ for $n \gg 0$. We will then explicitly compute c_n for $n \leq 9$ on all *geometric* manifolds, *i.e.* on those carrying one of the eight locally homogeneous model geometries [14]. The upper estimate on $c(M)$ given by the knowledge of $c_9(M)$ is known to be sharp for many M 's, and we conjecture it to be sharp for all torus bundles and all Seifert manifolds, except for certain very special ones fibred over the sphere with three exceptional fibres (a better estimate c^* is defined for them). It also allows to compute the complexity of 16 of the smallest known closed orientable hyperbolic manifolds.

This paper is based on the theory developed in [8] and reviewed below in Section 2. We roughly sketch this theory here to give the reader an idea of what c_n is. We define a *marking* for a torus T to be an embedding in T of a θ -graph such that $T \setminus \theta$ is a disc, where the embedding is viewed up to isotopy. We then call *manifold with marked boundary* an orientable, connected and compact 3-manifold with (possibly empty) boundary consisting of tori, with a marking fixed on each boundary torus. Using simple polyhedra we have defined in [8] a complexity $c(M)$ for every manifold M with marked boundary. When M is closed $c(M)$ equals Matveev's complexity, and the natural properties of c extend from the closed to the marked-boundary case. Moreover, given two manifolds with marked boundary M and M' , we can *assemble* them by taking two tori $T \subset \partial M$ and $T' \subset \partial M'$ and gluing them via a map that matches their markings (for the sake of simplicity we do not mention here the operation of self-assembling, see Section 2). The complexity c turns out to be subadditive under assemblings, so we have called *sharp* an assembling under which c is additive. Finally, we have called *brick* a manifold with marked boundary that cannot be split as a sharp assembling: it is then quite easy to show that every closed irreducible manifold can be sharply split into bricks. Using a computer, we have found that up to complexity 9 there are precisely 11 bricks with boundary, and 19 closed ones (that cannot be assembled at all).

Adding to the 19 closed bricks the assemblings of the 11 bounded ones we get all

the 1901 closed irreducible manifolds of complexity at most 9, and infinitely many other manifolds of bigger complexity. We can then define $c_n(M)$ as the smallest sum of complexities over the expressions of M as an assembling of bricks having complexity up to n , with $c_n(M) = \infty$ if no such expression exists. The precise computation of c_n for $n \leq 9$ on Seifert and hyperbolic manifolds is too complicated to be reproduced here (see Theorems 1.11 and 1.15 below), but there is one aspect that makes it remarkable and we can state now. Of course $c_9(M)$ gives a better or equal upper estimate for $c(M)$ than $c_0(M), \dots, c_8(M)$, but from the computation one sees that, at least for most Seifert manifolds and all torus bundles, the non-increasing sequence $(c_n(M))_{n=0}^9$ actually stabilizes very early (namely at $n = 1$ for lens spaces and torus bundles, and at $n = 3$ for all other Seifert manifolds, except some atoroidal ones). This seems to suggest that this stabilized value actually equals $c(M)$ for these M 's.

One of the key ingredients of our results is the complete classification established in [10] of all non-hyperbolic manifolds obtained by Dehn surgery on the chain-link with three components (denoted by 6_1^3 in [13]). These manifolds are relevant to the theory because two of our bricks are homeomorphic to the complement of 6_1^3 (itself denoted by $M6_1^3$ in [5]), with appropriate markings.

This paper is structured as follows. Since the precise definition of c_n requires some details from [8], we have deferred it to Section 2, collecting in Section 1 all our statements, organized so to be readable even without a complete understanding of what c_n is. Section 1 also contains the definition of two complexity functions (one for coprime pairs of integers and one for invertible 2×2 integer matrices) necessary to state our results. Section 2 then contains the exact definitions of brick and c_n , together with the preliminary constructions and results needed for these definitions. In Section 3 we discuss the spaces of slopes and θ -graphs on a given torus, and we prove various properties of the auxiliary complexity functions introduced in Section 1. In Section 4 we start setting up the combinatorial machine that we employ to compute c_n , beginning with the atoroidal case. Our main result here is that this case essentially reduces to the understanding of the Dehn fillings of the bricks, rather than more elaborate assemblings. This fact is used in Section 4 itself to compute c_n on atoroidal Seifert manifolds, and later in Section 5 for the Dehn fillings of our hyperbolic bricks. Section 6 concludes the paper, with the computation of c_n for non-hyperbolic but geometric 3-manifolds. This computation is based on the extension to manifolds with marked boundary of the notion of Seifert fibration and Euler number. In Section 7 we provide a description of all the closed, irreducible, and orientable manifolds of complexity up to 9.

1 Complexity computations

As briefly mentioned in the introduction, our theory of decomposition of irreducible 3-manifolds into bricks allows to define a non-increasing sequence $(c_n)_{n=0}^\infty$ of approximated complexity functions such that, for any given M , we have $c_n(M) = c(M)$ for $n \gg 0$. Deferring the precise definition of c_n to Section 2, we state here all the results we can show about it. We need to begin with some terminology and some preliminaries.

Terminology for 3-manifolds All the manifolds we will consider are compact, connected, 3-dimensional, and orientable (but mostly unoriented). We call *lens space* any genus-1 manifold distinct from \mathbb{RP}^3 , and *Seifert manifold* any total space of a Seifert fibration over a surface, possibly with boundary. We say that a Seifert manifold is *genuine* when it is not S^3 , \mathbb{RP}^3 , a lens space, $T \times I$, the solid torus \mathbf{T} , or a torus bundle over S^1 . For $A \in \mathrm{SL}_2(\mathbb{Z})$ we denote by T_A the total space of the torus bundle over S^1 with monodromy A . Later we will employ the labels of the Callahan-Hildebrand-Weeks census [5] for cusped hyperbolic manifolds. Namely, we denote by Mi_j^k the j -th manifold among those having an ideal triangulation with i tetrahedra and k cusps, ordered by increasing volume.

We explain now the notation we use for the parameters of a Seifert manifold. Let F be surface, t be an integer, and $\{(p_i, q_i)\}_{i=1}^k$ be coprime pairs of integers with $|p_i| \geq 2$. We denote by $(F, (p_1, q_1), \dots, (p_k, q_k), t)$ the oriented Seifert manifold obtained from either $F \times S^1$ or $F \tilde{\times} S^1$ (depending on orientability of F) by drilling $k + 1$ trivially fibred solid tori and Dehn filling the resulting boundary components along the slopes $p_1 a_1 + q_1 b_1, \dots, p_k a_k + q_k b_k, a_{k+1} + t b_{k+1}$, where the a_i 's are contained in a section of the bundle, the b_i 's are fibres, and each (a_i, b_i) is a positive basis in homology. Recall [6] that for $i \leq k$ the i -th filling gives rise to an exceptional fibre with ‘‘orbital type’’ $(|p_i|, r_i)$, where $0 < r_i < |p_i|$ and $q_i r_i \equiv p_i / |p_i| \pmod{|p_i|}$, but we will never use the orbital type, only the ‘‘filling type’’ (p_i, q_i) . In addition, the Euler number of the Seifert fibration is given by $t + \sum q_i / p_i$, but we will never use the Euler number itself, only the ‘‘twisting number’’ t .

The Seifert parameters are called *normalized* if $p_i > q_i > 0$ for all i . Any set of Seifert parameters can be promoted to a normalized one by replacing each (p_i, q_i) by $(|p_i|, q'_i)$, where $0 < q'_i < |p_i|$, $q'_i \equiv q_i p_i / |p_i| \pmod{|p_i|}$, and t by $t + \sum (q_i / p_i - q'_i / |p_i|)$. The next result, deduced from [6] and often needed below, shows that normalized parameters with an extra assumption correspond almost bijectively to genuine Seifert manifolds:

Proposition 1.1. *Let M be a closed and oriented Seifert manifold.*

- If M is genuine and atoroidal then it can be expressed uniquely as

$$(S^2, (p_1, q_1), (p_2, q_2), (p_3, q_3), t)$$

with $p_i > q_i > 0$ for all i , and $t \in \mathbb{Z}$. The only such expressions that do not define atoroidal genuine Seifert manifolds are the following torus bundles:

$$\begin{aligned} (S^2, (2, 1), (3, 1), (6, 1), -1) &= T_{\begin{pmatrix} 0 & 1 \\ -1 & 1 \end{pmatrix}} \\ (S^2, (2, 1), (4, 1), (4, 1), -1) &= T_{\begin{pmatrix} 0 & 1 \\ -1 & 0 \end{pmatrix}} \\ (S^2, (3, 1), (3, 1), (3, 1), -1) &= T_{\begin{pmatrix} 0 & 1 \\ -1 & -1 \end{pmatrix}}. \end{aligned}$$

- If M is genuine and toroidal then it can be expressed uniquely as

$$(F, (p_1, q_1), \dots, (p_k, q_k), t)$$

with $k - \chi(F) > 0$, $p_i > q_i > 0$ for all i , and $t \in \mathbb{Z}$. The only such expressions that do not define toroidal genuine Seifert manifolds are those with $F = S^2$ and $k = 3$, and the following one:

$$(S^2, (2, 1), (2, 1), (2, 1), (2, 1), -2) = T_{\begin{pmatrix} -1 & 0 \\ 0 & -1 \end{pmatrix}}.$$

- The expression of $-M$ is obtained from that of M by replacing t by $-t - k$ and each q_i by $p_i - q_i$.

Remark 1.2. When a closed Seifert manifold $(F, (p_1, q_1), \dots, (p_k, q_k), t)$ is viewed as an orientable but unoriented manifold, we can assume by the last point of the previous proposition that $t \geq -k/2$, but this expression can fail to be unique when the value of t is precisely $-k/2$.

In addition to the standard terminology, we define now \mathcal{M}^* to be the class of all genuine atoroidal Seifert manifolds of type $(S^2, (2, 1), (n, 1), (m, 1), -1)$, that is

$$\mathcal{M}^* = \{(S^2, (2, 1), (n, 1), (m, 1), -1) : 2 \leq n \leq m, (n, m) \neq (3, 6), (4, 4)\}. \quad (1)$$

Coprime pairs and integer matrices Our statements involve notions of complexity for coprime pairs of integers and for invertible 2×2 integer matrices. These notions first appeared in [12] and [2].

Definition 1.3. We recursively define an \mathbb{N} -valued function $|\cdot, \cdot|$ on pairs of coprime integers by setting $|\pm 1, 0| = |0, \pm 1| = |1, 1| = 0$ and

$$|p, q| = 1 + \begin{cases} |p, q - p| & \text{if } q > p > 0, \\ |p - q, q| & \text{if } p > q > 0. \end{cases}$$

If $p > 0 > q$ we define $|p, q| = |p, -q| + 1$. If $p < 0 \neq q$ we define $|p, q|$ as $|-p, -q|$.

A direct method for computing $|p, q|$ will be described in Proposition 3.3. The following proposition will also be proved in Section 3. It implies in particular that $|p, q|$ is a well-defined function for a lens space $L_{p,q}$.

Proposition 1.4. 1. $|p, q| = |q, p|$ for all coprime p, q ;

2. If $0 < q < p$ then $|p, p - q| = |p, q|$;

3. If $0 < q, q' < p$ and $q \cdot q' \equiv \pm 1 \pmod{p}$ then $|p, q| = |p, q'|$.

Let us now consider the following matrices:

$$S_1 = \begin{pmatrix} 1 & -1 \\ 0 & -1 \end{pmatrix}, \quad S_2 = \begin{pmatrix} -1 & 0 \\ -1 & 1 \end{pmatrix}, \quad S_3 = \begin{pmatrix} 0 & 1 \\ 1 & 0 \end{pmatrix}, \quad J = \begin{pmatrix} -1 & 0 \\ 0 & 1 \end{pmatrix}.$$

The following proposition will be proved in Section 3.

Proposition 1.5. Every $A \in \text{GL}_2(\mathbb{Z})$ can be written in a unique way as

$$A = \varepsilon \cdot S_{i_0} \cdot J \cdot S_{i_1} \cdot J \cdots S_{i_{n-1}} \cdot J \cdot S_{i_n} \cdot S_1^m$$

with $n \geq 0$, $\varepsilon \in \{\pm 1\}$, $i_0, i_n \in \{1, 2, 3\}$, $i_1, \dots, i_{n-1} \in \{1, 2\}$, and $m \in \{0, 1\}$.

Remark 1.6. Since $\det(A) = (-1)^{m+1}$, uniqueness of m in this expression is obvious. Existence, and uniqueness of the other indices, will be harder to show.

Definition 1.7. For $A \in \text{GL}_2(\mathbb{Z})$ we define $|A| \in \mathbb{N}$ as the number n of J 's appearing in the expression of A just described. Moreover we define $\|A\|$ to be the minimum of $|BAB^{-1}|$ as B varies in $\text{GL}_2(\mathbb{Z})$.

Remark 1.8. Since $J^{-1} = J$ and $S_i^{-1} = S_i$ for $i = 1, 2, 3$, one readily sees from the definition that $|A^{-1}| = |A|$ when $\det(A) = -1$. The same equality can actually be checked also for $\det(A) = +1$, using also the relations

$$S_1 \cdot S_i = S_{(13)(i)} \cdot S_3, \quad S_3 \cdot J = -J \cdot S_3, \quad S_3 \cdot S_i = S_{(12)(i)} \cdot S_3, \quad S_3 \cdot S_i = S_{(13)(i)} \cdot S_1.$$

In particular we have $\|A^{-1}\| = \|A\|$ for all A .

Remark 1.9. Given a certain $A \in \text{GL}_2(\mathbb{Z})$, it is in general very difficult to compute $|A|$ and $\|A\|$ using the definition directly. A practical method to compute them will be given in Corollary 3.5.

Finiteness of c_n We now state our main results, starting from finiteness of our approximated complexity functions. Recall that a special list \mathcal{M}^* of Seifert manifolds was introduced above in (1).

Theorem 1.10. *Let M be a closed, orientable, and irreducible 3-manifold. If $M \notin \mathcal{M}^*$ we have*

$$c_0(M) \geq c_1(M) = c_2(M) \geq c_3(M) = \dots = c_7(M) \geq c_8(M) \geq c_9(M).$$

Moreover:

- $c_0(M) < +\infty$ if and only if $M \in \{S^3, \mathbb{RP}^3, L_{3,1}\}$ or $M = T_A$ with $\|A\| \leq 1$;
- $c_1(M) < +\infty$ if and only if M is either S^3 , or \mathbb{RP}^3 , or a lens space, or a torus bundle over S^1 ;
- $c_3(M) < +\infty$ if and only if M splits along some tori into Seifert manifolds;
- $c_8(M) < +\infty$ if and only if M splits along some tori into Seifert manifolds and/or copies of $M2_2^1$;
- $c_9(M) < +\infty$ if and only if M splits along some tori into Seifert manifolds and/or copies of $M6_1^3$.

Since a solid torus is a Seifert manifold, every Dehn filling of $M6_1^3$ has finite c_9 . The manifold $M2_2^1$ is the figure-8 knot sister, and it is a filling of $M6_1^3$.

Computation of c_n : Seifert case We will now be much more precise on the values of the c_n 's on torus bundles, on Seifert manifolds, and on hyperbolic manifolds. Concerning non-geometric manifolds, we only mention here that the general computation of c_n would make an essential use of the notion of complexity $|A|$ introduced above for a matrix A (see Lemma 5.3).

We start with torus bundles and Seifert manifolds, using the “almost unique” normalized parameters described in Proposition 1.1 and Remark 1.2, and leaving to the reader to check that the formula for c_n is unchanged when a Seifert manifold admits two normalized expressions.

Theorem 1.11. *Let M be a closed, orientable, and irreducible 3-manifold.*

- If $M \in \{S^3, \mathbb{RP}^3, L_{3,1}\}$ then $c_n(M) = 0$ for $n = 0, \dots, 9$;
- If $M = T_A$ then:
 - If $\|A\| \leq 1$ then $c_n(M) = 6$ for all n ;

– If $\|A\| \geq 2$ then $c_0(M) = +\infty$ and $c_n(M) = \|A\| + 5$ for $n = 1, \dots, 9$;

- If M is a lens space $L_{p,q}$ different from $L_{3,1}$ then $c_0(M) = +\infty$ and $c_n(M) = |p, q| - 2$ for $n = 1, \dots, 9$;
- If M is a genuine Seifert manifold $(F, (p_1, q_1), \dots, (p_k, q_k), t)$ with $k - \chi(F) > 0$, $p_i > q_i > 0$ for all i and $t \geq -k/2$, but M is neither a member of \mathcal{M}^* nor of the form $(S^2, (2, 1), (3, 1), (p, q), -1)$ with $p/q > 5$, then $c_n(M) = +\infty$ for $n = 0, 1, 2$ and

$$c_n(M) = \max\{0, t - 1 + \chi(F)\} - 6(\chi(F) - 1) + \sum_{i=1}^k (|p_i, q_i| + 2)$$

for $n = 3, \dots, 9$;

- If $M = (S^2, (2, 1), (3, 1), (p, q), -1)$ with $p/q > 5$ and $p/q \notin \mathbb{Z}$, then $c_n(M) = +\infty$ for $n = 0, 1, 2$, $c_n(M) = |p, q| + 3$ for $n = 3, \dots, 7$, and $c_n(M) = |p, q| + 2$ for $n = 8, 9$.

Remark 1.12. The only Seifert manifolds to which the previous result does not apply are the members of \mathcal{M}^* . Another estimate c^* , defined in Section 2, seems to be more appropriate for them.

Fillings of $M6_1^3$ By Theorem 1.10, an atoroidal M with $c_9(M) < +\infty$ is either a small Seifert manifold or a Dehn filling of $M6_1^3$. In [10] we have completely classified all non-hyperbolic Dehn fillings of $M6_1^3$. We provide here only a simplified version of this result. To state it, we recall again that $M6_1^3$ is the complement of a link in S^3 , and we fix on each boundary component the natural meridian-longitude homology basis. Using this basis, we identify the set of slopes on each component to $\mathbb{Q} \cup \{\infty\}$.

Theorem 1.13. *Let M be a (closed or partial) Dehn filling of $M6_1^3$. Then M is hyperbolic except if one of the following occurs:*

- one of the filling coefficients belongs to $\{\infty, -3, -2, -1, 0\}$;
- a pair of filling coefficients belongs to $\{\{1, 1\}, \{-4, -1/2\}, \{-3/2, -5/2\}\}$;
- the triple of filling coefficients belongs to the following list:

$$\begin{aligned} & \{-5, -5, -1/2\}, \{-4, -4, -2/3\}, \{-4, -3/2, -3/2\}, \\ & \{-4, -1/3, 1\}, \{-8/3, -3/2, -3/2\}, \{-5/2, -5/2, -4/3\}, \\ & \{-5/2, -5/3, -5/3\}, \{-7/3, -7/3, -3/2\}, \{1, 2, 2\}, \\ & \{1, 2, 3\}, \{1, 2, 4\}, \{1, 2, 5\}, \{1, 3, 3\}, \{2, 2, 2\}. \end{aligned}$$

Since $M2_2^1$ is the $\{-1, 4\}$ filling of $M6_1^3$, we also deduce:

Corollary 1.14. *A p/q -Dehn filling of $M2_2^1$ is hyperbolic unless*

$$p/q \in \{\infty, -3, -2, -1, -1/2, -1/3, 0, 1\}.$$

Computation of c_n : hyperbolic case Now we turn to the exact computation of c_8 and c_9 on the hyperbolic Dehn fillings of $M6_1^3$. To do so we need to introduce a certain numerical complexity h for triples of rational numbers. Namely, we define:

$$h(p/q, r/s, t/u) = g + |p + 2q, q| + |r + 2s, s| + |t + 2u, u|$$

where

$$g = \begin{cases} 6 & \text{if } p/q, r/s, t/u \text{ are all different from 1 and greater than } -2, \\ 4 & \text{if } p/q = 1, r/s \in \{-4, -5\}, \text{ and } t/u < -1 \text{ up to permutation,} \\ 2 & \text{if } p/q = 1, r/s \in \{-4, -5\}, \text{ and } t/u > -1 \text{ up to permutation,} \\ 5 & \text{in all other cases.} \end{cases}$$

Theorem 1.15. • *If M is a hyperbolic Dehn filling of $M2_2^1$ then $c_8(M)$ is the minimum of $7 + |p, -q|$ over all realizations of M as a p/q -filling of $M2_2^1$;*

- *If M is a hyperbolic Dehn filling of $M6_1^3$ then $c_9(M)$ is the minimum of $h(p/q, r/s, t/u)$ over all realizations of M as a $(p/q, r/s, t/u)$ -filling of $M6_1^3$.*

The somewhat implicit form of the previous statement is due to the fact that very little is known about manifolds arising as different Dehn fillings of the same cusped hyperbolic manifold (see [4] for a careful discussion of the one-cusped case). We have however shown in [10] that the following repetitions occur among the fillings of $M6_1^3$ and, after extensive experiments carried out with SnapPea, we put forward the conjecture that this is actually the complete list of repetitions (up to permutation of the filling coefficients):

Proposition 1.16. *Let $N_{p/q, r/s, t/u}$ be the closed Dehn filling of $N = M6_1^3$ with coefficients $\{p/q, r/s, t/u\}$. Then, for all p/q and r/s in $\mathbb{Q} \cup \infty$,*

$$N_{-\frac{3}{2}, \frac{p}{q}, \frac{r}{s}} = N_{-4, \frac{q}{p+2q}-1, -\frac{r}{s}-3} \quad (2)$$

$$N_{-\frac{3}{2}, \frac{p}{q}, \frac{r}{s}} = N_{-\frac{3}{2}, -\frac{q}{p+2q}-2, -\frac{s}{r+2s}-2} \quad (3)$$

$$N_{-\frac{5}{2}, \frac{p}{q}, \frac{r}{s}} = N_{-\frac{5}{2}, -\frac{q}{p+2q}-1, -\frac{s}{r+s}-2} \quad (4)$$

$$N_{-\frac{1}{2}, \frac{p}{q}, \frac{r}{s}} = N_{-\frac{1}{2}, -\frac{p}{q}-4, -\frac{r}{s}-4} \quad (5)$$

$$N_{1, 2, \frac{p}{q}} = N_{1, 2, -\frac{p}{q}+2} \quad (6)$$

$$N_{1, -4, \frac{p}{q}} = N_{1, -4, \frac{q}{p}}. \quad (7)$$

Slopes	Volume	Num	Homology
$\{-4, -3/2, 1\}$	0.942707362777	1	$\mathbb{Z}_5 + \mathbb{Z}_5$
$\{-4, 1, 2\}$	0.981368828892	2	\mathbb{Z}_5
$\{-5, -1/2, 1\}$	1.01494160641	3	$\mathbb{Z}_3 + \mathbb{Z}_6$
$\{-3/2, -3/2, 1\}$	1.26370923866	4	$\mathbb{Z}_5 + \mathbb{Z}_5$

Table 1: The closed orientable hyperbolic manifolds of complexity up to 9.

Hyperbolic manifolds up to complexity 10 Combining Theorems 1.13 and 1.15 it is now quite easy to give the complete list of all closed hyperbolic manifolds of complexity up to 9, and a partial list of those of complexity 10. The first list is obtained by enumerating the triples $\{p/q, r/s, t/u\}$ such that $h(p/q, r/s, t/u) \leq 9$, discarding those listed in Theorem 1.13, and taking into account relations (2) to (7) to eliminate duplicates. This process leads to the following four triples:

$$\{-4, -3/2, 1\}, \quad \{-4, 1, 2\}, \quad \{-5, -1/2, 1\}, \quad \{-3/2, -3/2, 1\},$$

which indeed give distinct manifolds, all having complexity 9. More importantly, these manifolds are precisely the four smallest known closed orientable hyperbolic manifolds, listed in Table 1. (Both in this table and in the next one, Num is the position in the list of known closed orientable hyperbolic manifolds, ordered by increasing volume: the first 10 are in [7], a longer list is distributed with SnapPea).

The partial list of closed hyperbolic manifolds having complexity 10 is obtained by the same method, except that we must consider the triples $\{p/q, r/s, t/u\}$ such that $h(p/q, r/s, t/u) = 10$, and discard those giving one of the manifolds of Table 1. The result is described in Table 2. The fact that all the triples in the tables contain slope 1 implies that all the manifolds listed are actually obtained by Dehn surgery on the Whitehead link.

Geometric census Using Theorems 1.11 and 1.15 we have been able to refine the main result of [8] and determine the exact list and the geometry of all manifolds up to complexity 9. Our census is summarized in Table 3, explained in greater detail in Section 7, and publicly available from [18]. The three manifolds of complexity 0, *i.e.* S^3 , \mathbb{RP}^3 , and $L_{3,1}$, do not appear in Table 3. The number of manifolds with complexity 9 is 1155: the wrong number 1156 in [8] was the result of a list containing the same graph manifold twice.

Slopes	Volume	Num	Homology
$\{-5, 1, 2\}$	1.28448530047	5	\mathbb{Z}_6
$\{-5, 1/2, 1\}$	1.41406104417	7	\mathbb{Z}_6
$\{-4, 1, 3\}$	1.41406104417	8	\mathbb{Z}_{10}
$\{-4, -4/3, 1\}$	1.42361190029	9	\mathbb{Z}_{35}
$\{-4, -5/2, 1\}$	1.54356891147	13	\mathbb{Z}_{35}
$\{-4, -5/3, 1\}$	1.58316666062	15	\mathbb{Z}_{40}
$\{-5, -3/2, 1\}$	1.5886466393	17	\mathbb{Z}_{30}
$\{-3/2, -1/2, 1\}$	1.64960971581	19	\mathbb{Z}_{15}
$\{-5, -1/3, 1\}$	1.83193118835	23	$\mathbb{Z}_2 + \mathbb{Z}_{12}$
$\{-5/3, -3/2, 1\}$	1.88541472555	31	\mathbb{Z}_{40}
$\{-5, -2/3, 1\}$	1.91084379309	34	\mathbb{Z}_{30}
$\{-3/2, -4/3, 1\}$	1.95370831542	39	\mathbb{Z}_{35}

Table 2: A partial list of closed orientable hyperbolic manifolds of complexity 10.

complexity	1	2	3	4	5	6	7	8	9
lens	2	3	6	10	20	36	72	136	272
other elliptic	.	1	1	4	11	25	45	78	142
flat	6	.	.	.
Nil	7	10	14	15
$\mathbb{H}^2 \times S^1$	2	.
SL_2	39	162	514
Sol	5	9	23
hyperbolic	4
non-geometric	4	35	185
total	2	4	7	14	31	74	175	436	1155

Table 3: Number of manifolds per complexity and geometry

2 Decomposition of manifolds into bricks

In this section we provide the details needed below of the theory developed in [8] (see also [9] for the non-orientable version). In the whole paper our manifolds will be 3-dimensional, compact, orientable, and connected by default, and they will be viewed up to homeomorphism.

Manifolds with marked boundary As mentioned in the introduction, our theory deals with manifolds M bounded by tori and endowed with a fixed *marking* of the boundary, *i.e.* a collection of θ -graphs in ∂M whose complement in ∂M consists of discs. Note that ∂M can be empty. As we will see in Section 3, the same manifold can be marked in infinitely many distinct ways. The easiest way to change the marking of a boundary torus is to perform a *flip*, as shown in Fig. 1-left.

Now we describe two fundamental operations on the set of manifolds with marked boundary. The first one, already defined in the introduction, is binary: if M and M' are two such objects, take two tori $T \subset \partial M, T' \subset \partial M'$ marked by $\theta \subset T, \theta' \subset T'$ and a homeomorphism $\psi : T \rightarrow T'$ such that $\psi(\theta) = \theta'$. Gluing M and M' along ψ we get a new 3-manifold with marked boundary. We call this operation (and its result) an *assembling*. Note that, although there are infinitely many non-isotopic maps between two tori, only finitely many of them send one marking to the other, so there is a finite number of non-equivalent assemblies of M and M' .

Let us describe the second operation. Let M be a manifold with marked boundary, and T, T' be distinct components of ∂M , with markings $\theta \subset T$ and $\theta' \subset T'$. Let $\psi : T \rightarrow T'$ be a homeomorphism such that $\psi(\theta)$ equals either θ' or a θ -graph obtained from θ' via a flip. The new manifold with marked boundary obtained from M by gluing T and T' along ψ is called a *self-assembling* of M . (There is a technical reason for loosening the natural requirement that $\psi(\theta) = \theta'$, mentioned later.) There is only a finite number of non-equivalent self-assemblies of a given M .

Skeleta A compact 2-dimensional polyhedron P is said to be *simple* if the link of every point in P is contained in the 1-skeleton K of the tetrahedron. A point, a compact graph, a compact surface are thus simple. A point having the whole of K as a link is called a *vertex*. The set $V(P)$ of the vertices of P consists of isolated points, so it is finite. Points, graphs and surfaces of course do not contain vertices.

A sub-polyhedron P of a 3-manifold M with marked boundary is called a *skeleton* of M if $P \cup \partial M$ is simple, $M \setminus (P \cup \partial M)$ is an open ball and $P \cap \partial M$ is the union of the θ -graphs marking ∂M . Note that if M has one boundary component then P is a *spine* of M , that is M collapses onto P . Moreover, if M is closed, then P is a spine of M minus a point. It is easy to prove that every 3-manifold with marked boundary has a skeleton.

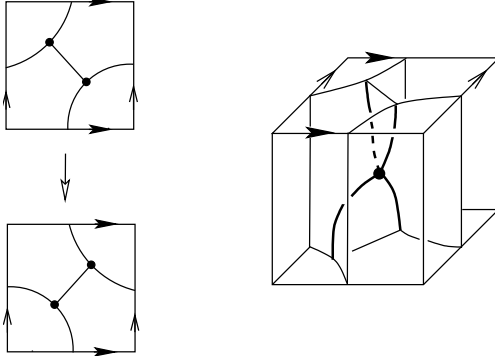

Figure 1: A flip on a θ -graph in the torus, and a skeleton for B_3 .

Complexity The *complexity* $c(M)$ of a 3-manifold with marked boundary M is defined as the minimal number of vertices of a simple skeleton of M . When M is closed, this definition coincides with Matveev's [11]. Note that $c(M)$ depends on the topology of M and on the marking. In particular, if $T = \partial M$ is one torus then every (isotopy class of a) θ -graph on T gives a distinct complexity for M . Two properties extend from the closed case to the case with marked boundary: complexity is still additive on connected sums, and it is finite-to-one on orientable irreducible manifolds with marked boundary [8].

Examples Let T be the torus. Consider $M = T \times I$, the boundary being marked by $\theta_0 \subset T \times \{0\}$ and $\theta_1 \subset T \times \{1\}$. If θ_0 and θ_1 are isotopic, the resulting manifold with marked boundary is called B_0 . If θ_0 and θ_1 are related by a flip, we call the resulting manifold with marked boundary B_3 . A skeleton for B_0 is $\theta_0 \times I$, while a skeleton for B_3 is shown in Fig. 1-right. The skeleton of B_0 has no vertices, so $c(B_0) = 0$. The skeleton of B_3 has 1 vertex, and it can be shown [8] that there is no skeleton for B_3 without vertices, so $c(B_3) = 1$.

Two distinct marked solid tori are shown in Fig. 2 and denoted by B_1 and B_2 . The same figure shows skeleta of B_1 and B_2 without vertices, so $c(B_1) = c(B_2) = 0$. Note that the skeleton of B_1 has a 1-dimensional portion. All the other skeleta we will meet in this paper are fully 2-dimensional.

The first irreducible orientable manifold with more than two marked boundary components has complexity 3 and is denoted by B_4 . It is a marked $D_2 \times S^1$, where D_2 is the disc with two holes. To describe the markings of B_4 , we note that on each of the three boundary tori we have a natural figure-eight graph, obtained by choosing basepoints in the factors of the product $(\partial D_2) \times S^1$. There are two possible

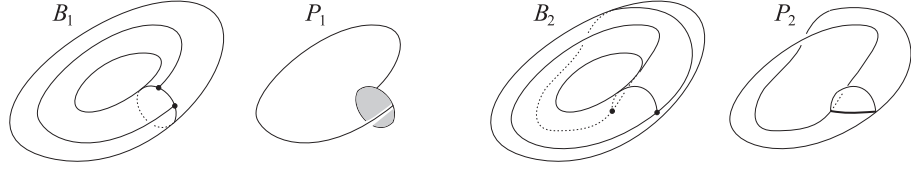

Figure 2: The solid tori with marked boundary B_1 and B_2 , and skeleta for them.

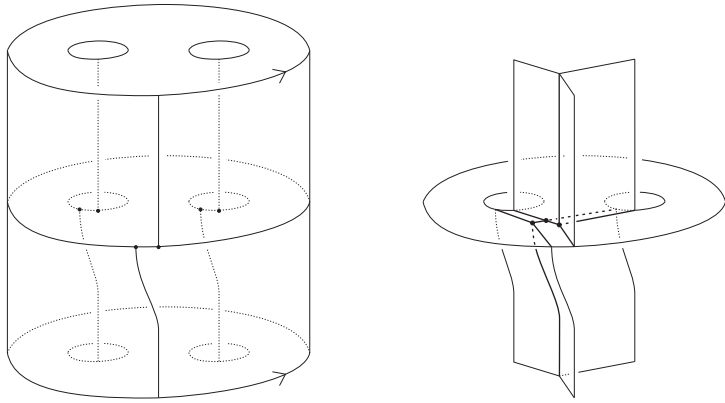

Figure 3: The manifold with marked boundary B_4 (left) and a skeleton for it (right).

resolutions of the 4-valent vertex of the graph, yielding θ -graphs related by a flip. The resolutions giving our B_4 are shown in Fig. 3-left. A skeleton with 3 vertices of B_4 is shown in Fig. 3-right. It can be proved [8] that B_4 has no skeleton with fewer vertices, so $c(B_4) = 3$, and that a different choice of marking would give higher complexity.

Subadditivity under assembling Let M, M' be manifolds with marked boundary, and P, P' be two corresponding skeleta. An assembling of M and M' is given by a map ψ that matches the θ -graphs, so $P \cup_\psi P'$ is a simple polyhedron inside $M \cup_\psi M'$. Moreover $P \cup_\psi P'$ is a skeleton of the assembling $M \cup_\psi M'$, because gluing two balls along a boundary disc one gets a ball. If P, P' have n, n' vertices, then $P \cup_\psi P'$ has $n + n'$, therefore $c(M \cup_\psi M') \leq c(M) + c(M')$.

A similar construction works for self-assemblings and motivates its definition. Let M' be obtained by self-assembling M along $\psi : T \rightarrow T'$. By definition $\psi(\theta)$ either equals θ' or is obtained from θ' via a flip. In any case, it is possible to

isotope ψ to ψ' so that $\psi'(\theta)$ and θ' intersect each other transversely in 2 points. We can now suppose M' to be constructed using ψ' rather than ψ , and note that $P' = P \cup T$ is a skeleton of M' . Since P' has at most 6 vertices more than P , we have $c(M') \leq c(M) + 6$.

Bricks The theory culminates in a decomposition theorem. An assembling is called *sharp* if the complexity is additive and both manifolds with marked boundary are irreducible and distinct from B_0 , and a self-assembling is *sharp* if the complexity of the new manifold is the complexity of the old one plus 6. An irreducible orientable manifold with marked boundary is a *brick* if it is not the result of a sharp assembling or self-assembling of other irreducible manifolds with marked boundary. The proof of the following result is clear: if an irreducible manifold with marked boundary is not a brick, then it can be de-assembled. Then we repeat the analysis on each new piece. Since the sum of the complexities of all pieces does not increase (and since the only possible pieces with complexity 0 are known to be B_1 and B_2), this iteration must stop after finite time.

Theorem 2.1. *Every irreducible orientable manifold with marked boundary can be obtained from some bricks via a combination of sharp assemblies and sharp self-assemblies.*

The practical relevance of this result depends on the fact that the set $\mathcal{B}_{\leq n}$ of all bricks having complexity up to n is much smaller and easier to determine than the set of all manifolds up to the same complexity. We will soon describe $\mathcal{B}_{\leq 9}$, but we first note that closed bricks play a special (and marginal) rôle in the theory, because they cannot be assembled at all.

Approximated complexity We can now formally introduce the functions c_n to the study of which the present paper is devoted. Let M be a manifold with marked boundary. If M is prime we define $c_n(M)$ as the minimum of $\sum_{i=1}^h c(B^{(i)}) + 6m$ over all realizations of M as an assembling of bricks $B^{(1)}, \dots, B^{(h)} \in \mathcal{B}_{\leq n}$ followed by m self-assemblies. As usual, the minimum over an empty list is taken to be $+\infty$. If M is not prime we define $c_n(M)$ as the sum of c_n over the prime connected summands of M . The next result is a direct consequence of Theorem 2.1 and additivity of c under connected sum [8]:

Proposition 2.2. *For any M , the sequence $\{c_n(M)\}_{n=0}^{\infty}$ is monotonic non-increasing. Moreover $c_n(M) = c(M)$ for $n \geq c(M)$.*

Small bricks with boundary We have shown in [8] that there are 11 non-closed bricks in $\mathcal{B}_{\leq 9}$, namely the B_0, \dots, B_4 introduced above, and certain other

B_5, \dots, B_{10} . The brick B_5 is the last Seifert one in our list, being a marked $(D, (2, 1), (3, 1))$, where D is the disc. The other bricks B_6, \dots, B_{10} are (suitably marked) cusped hyperbolic manifolds. Using as above the labels of [5], we have that B_6, B_7 , and B_8 are $M2_2^1, M3_4^1$, and $M4_1^2$ respectively. Both B_9 and B_{10} are $M6_1^3$, with different markings on the boundary. We describe the markings of B_5, \dots, B_{10} in Sections 4 and 5. Note that $M2_2^1, M3_4^1$, and $M4_1^2$ can be obtained from the chain-link complement $M6_1^3$ via appropriate Dehn fillings. Concerning complexity, we already know that $c(B_i) = 0$ for $i = 0, 1, 2$, $c(B_3) = 1$, and $c(B_4) = 3$. In addition, $c(B_i) = 8$ for $i = 5, 6$ and $c(B_i) = 9$ for $i = 7, \dots, 10$.

Minimal skeleta A skeleton P of M is *minimal* if it has $c(M)$ vertices and $P \cup \partial M$ cannot be collapsed onto a proper subpolyhedron. The next technical result is used below. It was also crucial for the computer program [8] which classified $\mathcal{B}_{\leq 9}$.

Theorem 2.3. *Let B be a brick with $c(B) \geq 4$. Assume B has k boundary components and P is a minimal skeleton of B . For $i = 1, \dots, k$ let e_1^i, e_2^i, e_3^i be the edges of the θ -graph which marks the i -th component of ∂M . Then:*

- for $i = 1, \dots, k$ and $j = 1, 2, 3$ there is a 2-cell σ_j^i of P incident to e_j^i ;
- for $i = 1, \dots, k$ there are vertices v_1^i, v_2^i of P such that σ_j^i is incident to both of them for $j = 1, 2, 3$;
- the $2k$ vertices $\{v_\ell^i\}$ are all distinct from each other.

Small closed bricks Given integers $i > 0, j > 0, k \geq 0$ we employ the normalized parameters for Seifert manifolds (Proposition 1.1) to define

$$\begin{aligned} E_k &= (S^2, (2, 1), (3, 1), (5 + k, 1), -1), \\ C_{i,j} &= (S^2, (2, 1), (1 + i, 1), (1 + j, 1), -1). \end{aligned}$$

In [8] we have described a systematic way to construct skeleta of E_k and $C_{i,j}$, with $5 + k$ and $i + j$ vertices respectively. The following topological result is easy:

Proposition 2.4. *The set \mathcal{M}^* of manifolds listed in equation (1) coincides with the following one:*

$$\begin{aligned} &\{E_k : k \geq 0, k \neq 1\} \\ &\cup \{C_{i,j} : 1 \leq i \leq j, (i, j) \neq (3, 3), \text{ and } j \in \{2, 3\} \text{ if } i = 2\}. \end{aligned} \tag{8}$$

Both lists (1) and (8) contain no repetitions.

For $M \in \mathcal{M}^*$ define now $c^*(M)$ to be $5 + k$ or $i + j$ depending on the type of M . In [8] we have shown that the closed bricks in $\mathcal{B}_{\leq 9}$ are precisely the 19 elements of \mathcal{M}^* such that $c^*(M) \leq 9$.

Results on \mathcal{M}^* and closed bricks By definition if M is a brick then $c_n(M)$ is strictly bigger than $c(M)$ for all $n < c(M)$. In particular, the upper estimate $c_9(M)$ will never give $c(M)$ on a closed brick M , except on the first 19 ones (those such that $c(M) \leq 9$). A complete understanding of all closed bricks would therefore be very desirable, and we will now state some conjectures we have, starting from the result which motivates them. (Notation is as above, points 1 and 2 were proved in [8], and point 3 is proved below.)

Theorem 2.5. 1. $c(M) \leq c^*(M)$ for all $M \in \mathcal{M}^*$;

2. If $c^*(M) \leq 9$ then $c(M) = c^*(M)$;

3. if $c^*(M) > 9$ then $c_9(M) = c^*(M) + 1$.

This result suggests that all the elements of \mathcal{M}^* are bricks, and that $c^*(M)$ is precisely the complexity of M for $M \in \mathcal{M}^*$, and indeed we believe this is true. With a slightly smaller degree of confidence, we also believe that the only closed Seifert bricks are those in \mathcal{M}^* . However, we do not risk a prediction on whether geometrically toroidal or closed hyperbolic bricks exist in complexity greater than 9. Our experience with high complexity is too limited to even make a conjecture. We are planning to investigate manifolds and bricks of complexity 10 in the close future, and we hope that the experimental data will provide some insight to these matters.

3 Slopes and θ -graphs on the torus

Our computation of c_n will be based, among other things, on a convenient and unified geometric encoding for simple closed curves and θ -graphs on the torus. Our encoding uses the so-called Farey tessellation and its dual graph, and it was partially inspired by [1]. This approach leads to a very direct proof of the fact, previously established in [2], that any two θ -graphs on the torus can be transformed into each other by a unique minimal sequence of flips. Quite surprisingly, it also leads to geometric proofs of Propositions 1.4 and 1.5 (algebraic proofs are also possible but quite awkward, so we have opted for the geometric approach).

Slopes as points at infinity in hyperbolic plane Let us fix for the rest of the section a torus T , and let us denote by $\mathcal{S}(T)$ the set of *slopes* on T , *i.e.* the isotopy classes of non-contractible simple closed curves (without orientation) on T . It is well-known that, given a basis $\mathfrak{b} = (a, b)$ of $H_1(T)$, we have a bijection $\Phi_{\mathfrak{b}} : \mathcal{S}(T) \rightarrow \mathbb{Q} \cup \{\infty\}$, where $\Phi_{\mathfrak{b}}(\gamma) = p/q$ if the homology class of γ is $\pm(p \cdot a + q \cdot b)$. We note now that $\mathbb{Q} \cup \{\infty\}$ is a subset of the boundary $\mathbb{R} \cup \{\infty\}$ of the upper

half-plane model of hyperbolic plane \mathbb{H}^2 , and for this reason we will denote it by $\partial_{\mathbb{Q}}\mathbb{H}^2$. In the sequel it will be convenient to freely switch from the half-plane to the Poincaré disc model of \mathbb{H}^2 without changing notation. We do this by fixing once and forever an isometry from the half-plane to the disc, namely the orientation-preserving isometry that maps ∞ to i and $\{\infty, 0, 1\}$ to the vertices of a (Euclidean) equilateral triangle.

It is now appropriate to recall that $\mathrm{GL}_2(\mathbb{Z})$ acts on \mathbb{H}^2 , using the half-plane model, by fractional linear or anti-linear transformations (depending on the sign of the determinant). This action extends to $\partial\mathbb{H}^2$ and leaves $\partial_{\mathbb{Q}}\mathbb{H}^2$ invariant. On the other hand, given a basis \mathfrak{b} of $H_1(T)$, we also have an action of $\mathrm{GL}_2(\mathbb{Z})$ on $\mathcal{S}(T)$, because every $A \in \mathrm{GL}_2(\mathbb{Z})$ determines up to isotopy precisely one automorphism f of T such that $f_* : H_1(T) \rightarrow H_1(T)$ has matrix A with respect to \mathfrak{b} . It is now a routine matter to show that these actions of $\mathrm{GL}_2(\mathbb{Z})$ are equivariant with respect to the bijection $\Phi_{\mathfrak{b}} : \mathcal{S}(T) \rightarrow \partial_{\mathbb{Q}}\mathbb{H}^2$.

The Farey tessellation We denote now by \mathcal{L} the set of lines in \mathbb{H}^2 joining two points $\Phi_{\mathfrak{b}}(\gamma), \Phi_{\mathfrak{b}}(\gamma') \in \partial_{\mathbb{Q}}\mathbb{H}^2$ whenever γ and γ' intersect each other transversely in only one point (up to isotopy). Using the $\mathbb{Q} \cup \{\infty\}$ model of $\partial_{\mathbb{Q}}\mathbb{H}^2$ we see that there is a line from p/q to s/t precisely if $|p \cdot t - s \cdot q| = 1$, so indeed \mathcal{L} is independent of \mathfrak{b} . Moreover \mathcal{L} is invariant under the action of $\mathrm{GL}_2(\mathbb{Z})$ on \mathbb{H}^2 .

- Lemma 3.1.**
1. *The lines in \mathcal{L} are pairwise disjoint (except at their ends);*
 2. *For all $\ell \in \mathcal{L}$ there exist precisely two points of $\partial_{\mathbb{Q}}\mathbb{H}^2$ which are joined by lines of \mathcal{L} to both the ends of ℓ ;*
 3. *\mathcal{L} is the 1-skeleton of an ideal triangulation of \mathbb{H}^2 .*

The ideal triangulation whose 1-skeleton is \mathcal{L} is usually called the *Farey tessellation* [3, 15], and it is shown in Fig. 4. For the sake of simplicity our pictures of \mathcal{L} will always be only combinatorially correct, because metrically correct pictures would be harder to understand.

Proof of 3.1. For point 1, let $\ell, \ell' \in \mathcal{L}$. If ℓ and ℓ' have a common end then they do not meet in \mathbb{H}^2 . So we can assume they have distinct ends. Using the fact that $\mathrm{GL}_2(\mathbb{Z})$ acts in a triply transitive way on $\partial_{\mathbb{Q}}\mathbb{H}^2$, we can now assume in the half-space model that ℓ joins 0 to 1 and ℓ' has one end at ∞ . The other end of ℓ' is then an integer, and point 1 follows. Point 2 is particularly easy to show using the bijection between $\partial_{\mathbb{Q}}\mathbb{H}^2$ and $\mathcal{S}(T)$: the ends of ℓ represent two slopes a and b having geometric intersection 1, and we must show that there are precisely two other slopes having intersection 1 with both a and b . If we choose orientations on a and b we get a basis

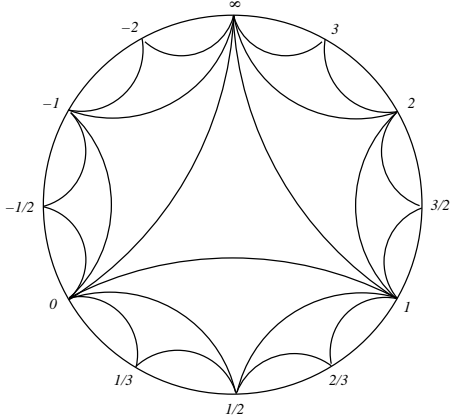

Figure 4: The Farey tessellation: an ideal triangulation of the Poincaré disc.

of $H_1(T)$, and the two other slopes we are looking for are $\pm(a + b)$ and $\pm(a - b)$. Point 3 now follows from points 1 and 2, and the density of $\partial_{\mathbb{Q}}\mathbb{H}^2$ in $\partial\mathbb{H}^2$. \square

θ -graphs as vertices of the dual tree Let us denote now by $\Theta(T)$ the set of isotopy classes of θ -graphs in T having a disc as a complement. It is not hard to see that the elements of $\Theta(T)$ correspond bijectively to the unordered triples of elements of $\mathcal{S}(T)$ having pairwise geometric intersection 1, the three slopes corresponding to a given $\theta \in \Theta(T)$ being those contained in θ (up to isotopy). So a triple $\{\gamma, \gamma', \gamma''\}$ defines a θ -graph if and only if $\Phi_{\mathfrak{b}}(\gamma), \Phi_{\mathfrak{b}}(\gamma'), \Phi_{\mathfrak{b}}(\gamma'')$ are the vertices of a triangle of the Farey triangulation of \mathbb{H}^2 . Therefore, if we denote by \mathcal{T} the graph dual to the Farey triangulation, we get a bijection $\Psi_{\mathfrak{b}}$ from $\Theta(T)$ to the set $\mathcal{T}^{(0)}$ of vertices of \mathcal{T} . Note that \mathcal{T} is a tree embedded in \mathbb{H}^2 , see Fig. 5.

The correspondence between $\Theta(T)$ and $\mathcal{T}^{(0)}$ has a geometric consequence. Note first that \mathcal{T} is trivalent, *i.e.* there are precisely three θ -graphs joined to a given $\theta \in \Theta(T)$ by a single edge of \mathcal{T} . Now one sees quite easily that these three θ -graphs are precisely those obtained from θ by the elementary transformation called *flip* and described above in Fig. 1-left. So we deduce:

Proposition 3.2. *Given distinct $\theta, \theta' \in \Theta(T)$ there exists a unique sequence $\{\theta_i\}_{i=0}^n \subset \Theta(T)$ of pairwise distinct θ -graphs such that $\theta_0 = \theta$, $\theta_n = \theta'$, and θ_i is obtained from θ_{i-1} by a flip, for $i = 1, \dots, n$.*

Distance between slopes and θ -graphs Let us endow $\mathcal{T}^{(0)}$ with the distance defined as usual for the vertices of a graph. Namely, given $v, v' \in \mathcal{T}^{(0)}$, their distance

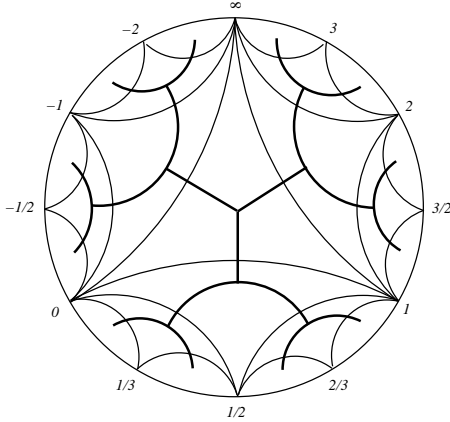

Figure 5: The trivalent tree dual to the Farey triangulation of \mathbb{H}^2 .

$d(v, v')$ is the number of edges of the only simple path in \mathcal{T} that joins v to v' (this path is unique because \mathcal{T} is a tree). Using $\Psi_{\mathfrak{b}}$ we deduce a distance on $\Theta(T)$, again denoted by d . This distance is independent of \mathfrak{b} , because $d(\theta, \theta')$ is intrinsically interpreted as the number of flips required to transform θ into θ' .

We will need in the sequel a notion of “distance” between a slope $\gamma \in \mathcal{S}(T)$ and a θ -graph $\theta \in \Theta(T)$. We define $d(\gamma, \theta)$ to be $n - 1$, where n is the number of lines in \mathcal{L} intersected by the half-line in \mathbb{H}^2 that joins $\Psi_{\mathfrak{b}}(\theta)$ to $\Phi_{\mathfrak{b}}(\gamma)$. Independence of \mathfrak{b} is easy and left to the reader. Of course our function d is not quite a distance, because $d(\gamma, \theta) = -1$ if γ is contained in θ up to isotopy.

Action of $\mathrm{GL}_2(\mathbb{Z})$ on θ -graphs As above for slopes, we have now two different ways to define an action of $\mathrm{GL}_2(\mathbb{Z})$ on θ -graphs. On one hand, we can use the basis \mathfrak{b} to associate an automorphism of T to a given matrix, and then we can let this automorphism act on $\Theta(T)$. On the other hand, the matrix acts by fractional linear or anti-linear transformation on \mathbb{H}^2 leaving $\mathcal{T}^{(0)}$ invariant, so we have an action defined through the bijection $\Psi_{\mathfrak{b}} : \Theta(T) \rightarrow \mathcal{T}^{(0)}$. The reader is invited to check that these actions of $\mathrm{GL}_2(\mathbb{Z})$ actually coincide.

Our next results concern a relation between the distance function on the Farey tessellation and the complexity $|p, q|$ for a coprime pair (p, q) defined in Section 1. To state the relation we introduce a notation repeatedly used below, namely for $i \in \mathbb{Z}$ we denote by $\theta^{(i)} \in \mathcal{T}^{(0)}$ the centre of the triangle with vertices at $i, i + 1$, and ∞ . Note that $\theta^{(0)}$ is the centre of the disc model of \mathbb{H}^2 .

Proposition 3.3. *Let (p, q) be a pair of coprime integers. Consider the point cor-*

responding to p/q in $\partial_{\mathbb{Q}}\mathbb{H}^2$. Then $|p, q|$ equals the number of lines in \mathcal{L} met by the half-line that starts at $\theta^{(0)}$ and ends at p/q . Any other path from $\theta^{(0)}$ to p/q meets at least $|p, q|$ lines of \mathcal{L} .

Proof. For $\alpha, \alpha' \in \mathcal{T}^{(0)} \cup \partial_{\mathbb{Q}}\mathbb{H}^2$ let $\ell(\alpha, \alpha')$ be the geodesic segment, line, or half-line with ends at α and α' , and let $n(\alpha, \alpha')$ be the number of intersections of $\ell(\alpha, \alpha')$ with the lines of \mathcal{L} .

We must show that $|p, q| = n(p/q, \theta^{(0)})$. We proceed by induction on $|p, q|$ and note that the equality is obvious when $|p, q| = 0$, namely for $p/q \in \{0, 1, \infty\}$. Let us then consider the case $|p, q| > 0$. Suppose first that $p > q > 0$. Let f be the automorphism of \mathbb{H}^2 associated to $\begin{pmatrix} 1 & -1 \\ 0 & 1 \end{pmatrix}$. Then $f(\mathcal{L}) = \mathcal{L}$, $f(p/q) = (p - q)/q$, and $f(\theta^{(0)}) = \theta^{(-1)}$, so $n(p/q, \theta^{(0)}) = n((p - q)/q, \theta^{(-1)})$. Now we note that $\ell(\theta^{(0)}, \theta^{(-1)})$ only meets $\ell(0, \infty)$, and $\ell(0, \infty)$ cuts the closed disc in two parts, leaving $(p - q)/q$ and $\theta^{(0)}$ on one side and $\theta^{(-1)}$ on the other side. So

$$n((p - q)/q, \theta^{(-1)}) = n((p - q)/q, \theta^{(0)}) + 1.$$

Since $|p - q, q| = |p, q| - 1 < |p, q|$, the induction assumption now implies that $n((p - q)/q, \theta^{(0)}) = |p, q| - 1$, whence the conclusion.

If $q > p > 0$ we proceed similarly, using the automorphism $\begin{pmatrix} 1 & 0 \\ -1 & 1 \end{pmatrix}$. If $p > 0 > q$ we use the automorphism $\begin{pmatrix} 1 & -1 \\ 0 & -1 \end{pmatrix}$, which fixes $\theta^{(0)}$ and maps p/q to $(p - q)/(-q)$. So $n(p/q, \theta^{(0)}) = n((p - q)/(-q), \theta^{(0)})$, and $n((p - q)/(-q), \theta^{(0)}) = |p - q, -q|$ by the cases already discussed. By definition of $|\cdot, \cdot|$ we now have $|p - q, -q| = |p, -q| + 1 = |p, q|$, whence the conclusion also in this case. For $p < 0$ we simply note that $p/q = (-p)/(-q)$ and $|p, q| = |-p, -q|$ by definition. The first assertion of the statement is now proved, and the second one is easy, because if a line ℓ of \mathcal{L} meets $\ell(p/q, \theta^{(0)})$ then it leaves $\theta^{(0)}$ and p/q on opposite sides, so any path joining $\theta^{(0)}$ to p/q must meet ℓ . \square

Corollary 3.4. *If p and q are coprime then $d(p/q, \theta^{(i)}) = |p - iq, q| - 1$.*

Proof. The case $i = 0$ follows from Proposition 3.3. The other cases follow using the automorphism $\begin{pmatrix} 1 & -i \\ 0 & 1 \end{pmatrix}$ of \mathbb{H}^2 that sends $\theta^{(i)}$ to $\theta^{(0)}$ and p/q to $(p - iq)/q$. \square

With the geometric tools we have developed we can now establish the two technical results stated without proof in Section 1.

Proof of 1.4. If $p, q \geq 1$ then $|p, q|$ is the number of operations required to reach (p, q) from $(1, 1)$ by either adding the left coordinate to the right one, or the right coordinate to the left one. Since in $(1, 1)$ left and right are the same, point 1 follows for $p, q \geq 1$. The same assertion for $p \leq 0$ or $q \leq 0$ is now easy and left to the reader.

Using point 1 we can now very easily establish point 2: $|p, q| = |p - q, q| + 1 = |q, p - q| + 1 = |p, p - q|$.

Let us prove point 3. By point 2 we can suppose $qq' \equiv 1 \pmod{p}$. By Proposition 3.3 and point 1, to prove that $|p, q| = |p, q'|$ it is now sufficient to show that

$$d(\theta^{(0)}, p/q) = d(\theta^{(0)}, q'/p). \quad (9)$$

We also note that the desired equality is obvious if $q = 1$, so we proceed assuming p/q is not an integer.

For $r \in \partial_{\mathbb{Q}}\mathbb{H}^2$ we denote now by θ_r the θ -graph closest to $\theta^{(0)}$ among those that contain r . So $d(r, \theta^{(0)}) = d(\theta_r, \theta^{(0)}) - 1$. Moreover, if r is neither an integer nor ∞ , one sees that θ_r can be characterized as the only θ -graph which contains r and two other slopes r' and r'' such that $r' < r < r''$ with respect to the linear order of \mathbb{Q} .

Now let $s > 0$ be such that $qq' = sp + 1$ and consider the following triples of slopes:

$$\left(\frac{p - q'}{q - s}, \frac{p}{q}, \frac{q'}{s} \right), \quad \left(\frac{s}{q}, \frac{q'}{p}, \frac{q' - s}{p - q} \right).$$

Using the relation $qq' = sp + 1$ one readily sees that in both triples the slopes intersect pairwise in a single point, so the triples define θ -graphs. The same relation and its immediate consequence that $q > s$ also easily imply that in both triples the slopes are arranged in increasing order. This proves that the triples define $\theta_{p/q}$ and $\theta_{q'/p}$ respectively. Consider now the automorphism f corresponding to $\begin{pmatrix} p & -q' \\ q & -s \end{pmatrix}$. Then $f(\theta^{(0)}) = \theta_{p/q}$ and $f(\theta_{q'/p}) = \theta^{(0)}$. Since f acts isometrically on $\mathcal{T}^{(0)}$, relation (9) follows immediately, and the proof is complete. \square

Proof of 1.5. Our argument is based on the action of $\mathrm{GL}_2(\mathbb{Z})$ on $\mathcal{T}^{(0)}$, that we analyze having in mind the correspondence between $\mathcal{T}^{(0)}$ and the set of θ -graphs on a torus with fixed homology basis. We begin by providing an alternative description of $\mathcal{T}^{(0)}$ that allows to understand the action of $\mathrm{GL}_2(\mathbb{Z})$ better. We do this by noting that a θ -graph can be viewed as a triple of slopes intersecting pairwise once. So $\mathcal{T}^{(0)}$ can be identified to the quotient of the set of 2×3 integer matrices such that all three 2×2 submatrices are invertible over the integers, where two matrices are identified if they are obtained from each other by reordering and sign-switching of columns. With this description of $\mathcal{T}^{(0)}$, a matrix $A \in \mathrm{GL}_2(\mathbb{Z})$ acts on $[B] \in \mathcal{T}^{(0)}$ giving just $[A \cdot B]$. In addition, $[B]$ and $[B']$ are adjacent in \mathcal{T} (*i.e.* they are joined by an edge) if and only if they share two columns (up to sign). We prove now a series of claims which eventually will lead to the conclusion of the proof.

Claim 1: The matrices S_1, S_2, S_3 generate a subgroup of $\mathrm{GL}_2(\mathbb{Z})$ isomorphic to \mathfrak{S}_3 , in which they play the rôle of the generating transpositions. The relations $S_i^2 = I$ for $i = 1, 2, 3$ and $S_{i_1}S_{i_2}S_{i_1} = S_{i_3}$ for $\{i_1, i_2, i_3\} = \{1, 2, 3\}$ are proved by direct inspection and imply the conclusion.

Claim 2: The stabilizer of $\theta^{(0)}$ in $\text{GL}_2(\mathbb{Z})$ is generated by $-I, S_1, S_2, S_3$ and isomorphic to $(\mathbb{Z}/2) \times \mathfrak{S}_3$. This is established very easily noting that

$$\theta^{(0)} = \begin{bmatrix} 1 & 0 & 1 \\ 0 & 1 & 1 \end{bmatrix}.$$

Claim 3: If $A \in \text{GL}_2(\mathbb{Z})$ and $A(\theta^{(0)}) = \theta^{(0)}$ then A can be written in a unique way as $A = \varepsilon \cdot S_i \cdot S_1^m$ with $\varepsilon \in \{\pm 1\}$, $m \in \{0, 1\}$, and $i \in \{1, 2, 3\}$. This is a direct consequence of the previous claims.

Claim 4: Given $A \in \text{GL}_2(\mathbb{Z})$, the three θ -graphs in $\mathcal{T}^{(0)}$ adjacent to $A(\theta^{(0)})$ are the following ones:

$$(A \cdot S_1 \cdot J)(\theta^{(0)}), \quad (A \cdot S_2 \cdot J)(\theta^{(0)}), \quad (A \cdot S_3 \cdot J)(\theta^{(0)}) = (A \cdot J)(\theta^{(0)}).$$

The action of A on $\mathcal{T}^{(0)}$, being the restriction of one on \mathcal{T} , preserves adjacency of θ -graphs. So it is sufficient to check the claim with $A = I$. A straight-forward computation shows that

$$(S_1 \cdot J)(\theta^{(0)}) = \begin{bmatrix} 1 & 1 & 2 \\ 0 & 1 & 1 \end{bmatrix}, \quad (S_2 \cdot J)(\theta^{(0)}) = \begin{bmatrix} 0 & 1 & 1 \\ 1 & 1 & 2 \end{bmatrix},$$

$$(S_3 \cdot J)(\theta^{(0)}) = J(\theta^{(0)}) = \begin{bmatrix} 1 & 0 & 1 \\ 0 & 1 & -1 \end{bmatrix}$$

whence the conclusion.

Claim 5: Given $n \geq 1$, $i_0 \in \{1, 2, 3\}$, and $i_1, \dots, i_{n-1} \in \{1, 2\}$, the sequence of θ -graphs

$$\begin{aligned} \theta_0 &= \theta^{(0)} \\ \theta_1 &= (S_{i_0} \cdot J)(\theta^{(0)}) \\ \theta_2 &= ((S_{i_0} \cdot J) \cdot (S_{i_1} \cdot J))(\theta^{(0)}) \\ &\dots \\ \theta_n &= ((S_{i_0} \cdot J) \cdot (S_{i_1} \cdot J) \cdots (S_{i_{n-1}} \cdot J))(\theta^{(0)}) \end{aligned}$$

is the sequence of vertices of a simple simplicial path in \mathcal{T} . Using Claim 4 with $A = I$, this is obvious for $n = 1$. Using Claim 4 again we only have to show for $n > 1$ that $\theta_n \neq \theta_{n-2}$. Define A so that $\theta_{n-2} = A(\theta^{(0)})$, whence $\theta_{n-1} = (A \cdot (S_{i_{n-2}} \cdot J))(\theta^{(0)})$ and $\theta_n = (A \cdot (S_{i_{n-2}} \cdot J) \cdot (S_{i_{n-1}} \cdot J))(\theta^{(0)})$. We know that there will exist precisely one $i \in \{1, 2, 3\}$ such that $(A \cdot (S_{i_{n-2}} \cdot J) \cdot (S_i \cdot J))(\theta^{(0)}) = \theta_{n-2}$. If we show that this is the case for $i = 3$, knowing that $i_{n-1} \in \{1, 2\}$, we get the desired conclusion. And, indeed:

$$\begin{aligned} (A \cdot (S_{i_{n-2}} \cdot J) \cdot (S_3 \cdot J))(\theta^{(0)}) &= (A \cdot (S_{i_{n-2}} \cdot J) \cdot J)(\theta^{(0)}) \\ &= (A \cdot S_{i_{n-2}})(\theta^{(0)}) = A(\theta^{(0)}) = \theta_{n-2}. \end{aligned}$$

Claim 6: Given a length- n simple simplicial path in \mathcal{T} starting from $\theta^{(0)}$, the sequence of its vertices arises as in Claim 5 from a unique choice of $i_0 \in \{1, 2, 3\}$ and $i_1, \dots, i_{n-1} \in \{1, 2\}$. This is a by-product of the previous argument.

Conclusion. Now let $A \in \text{GL}_2(\mathbb{Z})$ and choose $i_0 \in \{1, 2, 3\}$ and $i_1, \dots, i_{n-1} \in \{1, 2\}$ to describe the only simple path in \mathcal{T} from $\theta^{(0)}$ to $A(\theta^{(0)})$. So $A = S_{i_0} \cdot J \cdot S_{i_1} \cdot J \cdots J \cdot S_{i_{n-1}} \cdot A'$ for some A' in the stabilizer of $\theta^{(0)}$. Claims 3 and 6 now readily imply the conclusion. \square

Using the notation of the proof just completed, we note that the same argument combined with the transitivity of the action of $\text{GL}_2(\mathbb{Z})$ on $\mathcal{T}^{(0)}$ shows the following:

Corollary 3.5. *Given $A \in \text{GL}_2(\mathbb{Z})$, if $|A|$ and $\|A\|$ are the functions defined in Section 1 and d is the graph distance on $\mathcal{T}^{(0)}$, we have*

$$|A| = d(\theta^{(0)}, A(\theta^{(0)})), \quad \|A\| = \min_{\theta \in \mathcal{T}^{(0)}} d(\theta, A(\theta)).$$

4 Complexity of atoroidal manifolds: generalities and the Seifert case

The computation of c_n for atoroidal manifolds with marked boundary is considerably easier than for general ones. One reason is that we do not have to consider self-assemblings. More reasons will be clear soon.

Effect of small bricks We begin by describing the effect of the assembling with one of the smallest bricks B_0, \dots, B_3 . The proof is immediate.

Proposition 4.1. *Let M be a manifold with marked boundary. Let T be a component of ∂M , marked by some θ . For $0 \leq i \leq 3$, the effect of assembling B_i to M along T is as follows:*

- if $i = 0$ then M remains unaffected;
- if $i = 1$, a Dehn filling is performed on M that kills one of the three slopes contained in θ , i.e. a slope having distance -1 from θ ; all such fillings can be realized by an assembling of B_1 with an appropriate map;
- if $i = 2$, a Dehn filling is performed on M that kills one of the three slopes having distance 0 from θ ; all such fillings can be realized by an assembling of B_2 with an appropriate map;
- if $i = 3$, the graph θ gets replaced by one of the three θ -graphs having distance 1 from θ ; all such replacements can be realized by an assembling of B_3 with an appropriate map.

We note here that the result just stated, together with the knowledge of $\mathcal{B}_{\leq 9}$, readily implies Theorem 1.10.

Assemblings with a centre If B is a brick, let us call *assembling with centre B* an assembling of B (the centre) with some copies of B_2 and B_3 . We will prove in this paragraph that $c_n(M)$ is realized by an assembling with centre whenever M is atoroidal and $n \leq 9$. This result will be crucial in the sequel. Its proof relies on the following experimental evidence, that we have checked for $n \leq 9$: *the value of c_n equals that of c_1 for marked \mathbf{T} 's or $T \times I$'s*. We formalize this evidence as follows:

Definition 4.2. An integer $n \geq 1$ is said to be *well-behaved on tori* if $c_n(M)$ equals $c_1(M)$ whenever M is a marked \mathbf{T} or $T \times I$.

Conjecture 4.3. *All $n \geq 1$ are well-behaved on tori. That is, $c_1(M) = c(M)$ whenever M is a marked \mathbf{T} or $T \times I$.*

Remark 4.4. If n is well-behaved on tori, then all integers smaller than n also are.

We will prove below that $n = 9$ is well-behaved on tori. To show the main result of this paragraph we start with the following:

Lemma 4.5. *Let B be a brick of complexity at most n and let M be the result of an assembling of B with h copies of B_1 . Then*

$$c_n(M) \leq \max\{c(B) - 2h, 0\}.$$

If $B \notin \{B_0, \dots, B_4\}$, then $c(B) - 2h \geq 0$. If $B \in \{B_1, \dots, B_4\}$, then either $c_n(M) \leq c(B) - h$ or M is closed and $c(M) = 0$.

Proof. Of course we may well assume that $c(B) = n$. The assumptions imply that $c(M) \leq n$, so $c_n(M) = c(M)$. Therefore it is sufficient to prove the inequalities for $c(M)$ instead of $c_n(M)$.

Let us assume first that B is distinct from B_0, \dots, B_4 . Let P be a minimal skeleton of B . Recall that a minimal skeleton for B_1 consists of a meridional disc and an arc on the boundary, as shown in Fig. 2. A skeleton Q for M is then obtained as follows: for each component T_i of ∂M to which a B_1 is assembled, a disc is glued to P along a loop γ contained in the corresponding marking $\theta_i \subset T_i$. Therefore $\theta_i \setminus \gamma$ is an edge of θ_i , and Theorem 2.3 implies that there is a 2-cell of P incident to it. In Q this cell has a free edge, so it can be collapsed. Since we are assuming that $B \notin \{B_0, \dots, B_4\}$, Theorem 2.3 again implies that collapsing this face one eliminates two vertices from Q , and that the $2h$ vertices thus eliminated are all distinct, whence $c(M) \leq c(B) - 2h$, as required.

Let us prove now the first assertion for $B \in \{B_0, \dots, B_4\}$. For $B \in \{B_0, B_1, B_2\}$ the conclusion is obvious because $c(M) = 0$. For $B = B_3$ and $B = B_4$ one checks by hand, looking at the singular set of the skeleton of B , that at least $\min\{2h, c(B)\}$ distinct vertices get eliminated when collapsing Q .

We are left to prove the last assertion for $B \in \{B_1, \dots, B_4\}$. Note that B has at most $c(B) + 1$ boundary components. Assuming $c(M) > c(B) - h$ we deduce that $c(M) = 0$ by the first assertion, so $h > c(B)$. Then $h = c(B) + 1$ and M is closed. \square

Proposition 4.6. *Let $n \geq 1$ be well-behaved on tori and M be a manifold with marked boundary. Assume M is irreducible and atoroidal, $c(M) > 0$, and $c_n(M) < \infty$. Then there is an assembling with centre realizing $c_n(M)$.*

Proof. Let us fix an assembling realizing $c_n(M)$ with a minimal number $p \geq 0$ of bricks different from B_2 and B_3 . We must show that $p \leq 1$, so we assume by contradiction that two bricks $B^{(1)}$ and $B^{(2)}$ are different from B_2 and B_3 . Let us concentrate on the boundary component T of $B^{(1)}$ that leaves $B^{(1)}$ and $B^{(2)}$ on opposite sides. Since M is irreducible and atoroidal, one of the following holds: (i) T bounds a solid torus in M ; (ii) T is parallel to a component of ∂M ; (iii) T is contained in a ball. Using the fact that each brick in the assembling is irreducible one easily sees that if (iii) holds then (i) also does. This implies that there is a sub-assembling involving either $B^{(1)}$ or $B^{(2)}$ and giving a marked \mathbf{T} or $T \times I$, which we denote by N . Since n is well-behaved on tori, we can replace the sub-assembling with one which still realizes $c_n(N)$ and involves B_0, B_1, B_2 , and B_3 only. We can then dismiss the B_0 's. Moreover, Proposition 4.5 and relation $c_n(M) \geq c(M) > 0$ imply that no B_1 is present, whence the conclusion. \square

Complexity of Dehn fillings Let N be a manifold with $\partial N = T_1 \sqcup \dots \sqcup T_k$. Consider a k -tuple $\alpha_1, \dots, \alpha_k$ where $\alpha_i \in \mathcal{S}(T_i) \cup \Theta(T_i)$, namely α_i is either a slope or a θ -graph in T_i . We define a manifold with marked boundary $N_{\alpha_1, \dots, \alpha_k}$ obtained as follows from N : when $\alpha_i \in \Theta(T_i)$, we mark T_i with the θ -graph α_i ; when $\alpha_i \in \mathcal{S}(T_i)$, we perform on T_i the Dehn filling that kills α_i . We will use the notation N_θ with the same meaning, when $\theta = \{\theta_1, \dots, \theta_k\}$ contains θ -graphs only.

Recall now that we have defined in Section 3 a distance $d(\alpha, \alpha')$ when α is either a slope or a θ -graph and α' is a θ -graph on a given torus. Given tori T_1, \dots, T_k and two k -tuples $\alpha = \{\alpha_1, \dots, \alpha_k\}$ and $\alpha' = \{\alpha'_1, \dots, \alpha'_k\}$, where α_i is either a slope or a θ -graph and α' is a θ -graph on T_i , we now set $d(\alpha, \alpha') = \sum_{i=1}^k d(\alpha_i, \alpha'_i)$.

Proposition 4.7. *Let $n \geq 1$ be well-behaved on tori and M be a manifold with marked boundary. Assume M is irreducible and atoroidal, and $c(M) > 0$. Then*

$c_n(M)$ equals the minimum of $c(N_\theta) + d(\alpha, \theta)$ over all realizations of M as N_α and all $N_\theta \in \mathcal{B}_{\leq n} \setminus \{B_1, B_3\}$, with $N_\theta \neq B_0$ if M is not a marked $T \times I$.

Proof. We first prove inequality \geq , so we suppose $c_n(M) < \infty$. Proposition 4.6 implies that there exists an assembling that realizes $c_n(M)$ involving one $B \in \mathcal{B}_{\leq n}$ together with some B_2 's and B_3 's. We have $B \neq B_1$ by Lemma 4.5. If $B = B_3$ and $M \neq T \times I$, at least one B_2 must occur in the assembling, and we redefine B as one of these B_2 's. If $B = B_3$ and $M = T \times I$, we can insert one B_0 and redefine B to be this B_0 . So in the assembling realizing $c_n(M)$ with centre B we can actually assume that $B \in \mathcal{B}_{\leq n} \setminus \{B_1, B_3\}$ and $B = B_0$ only if $M = T \times I$.

Now let h be the number of copies of B_3 appearing in our assembling, so that $c_n(M) = c(B) + h$. Let $B = N_\theta$, with $\theta = \{\theta_1, \dots, \theta_k\}$. Proposition 4.1 shows that a successive assembling along a component T_i of ∂N of some j copies of B_3 corresponds to replacing θ_i by some θ'_i with $d(\theta_i, \theta'_i) \leq j$. The same proposition implies that if we first assemble j copies of B_3 and then a copy of B_2 then M gets filled along a slope α_i with $d(\alpha_i, \theta_i) \leq j$. This shows that $M = N_\alpha$ with $d(\alpha, \theta) \leq h$, whence $c_n(M) \geq c(B) + d(\alpha, \theta)$, and inequality \geq follows.

Turning to inequality \leq , suppose the right-hand side equals $c(N_\theta) + d(\alpha, \theta)$ for some brick $N_\theta \in \mathcal{B}_{\leq n} \setminus \{B_1, B_3\}$ and some realization $M = N_\alpha$. Suppose $\partial N = T_1 \sqcup \dots \sqcup T_k$, $\theta = \{\theta_1, \dots, \theta_k\}$, $\alpha = \{\alpha_1, \dots, \alpha_k\}$. We can now associate to the realization N_α of M an assembling yielding M . When $\alpha_i \in \Theta(T_i)$ we assemble $d(\alpha_i, \theta_i)$ copies of B_3 , following the unique simple path in $\Theta(T_i)$ from θ_i to α_i . When $\alpha_i \in \mathcal{S}(T_i)$ and $d(\alpha_i, \theta_i) \geq 0$ we assemble $d(\alpha_i, \theta_i)$ copies of B_3 and one of B_2 . When $\alpha_i \in \mathcal{S}(T_i)$ and $d(\alpha_i, \theta_i) = -1$ we assemble one copy of B_1 . Now we deduce from the last assertion of Lemma 4.5 that the partial assembling of N with the B_1 's only has complexity c_n at most $c(N) - h$, where h is the number of B_1 's. Adding also the B_2 's and B_3 's we then get $c_n(M) \leq c(N_\theta) + d(\alpha, \theta)$, whence the conclusion. \square

Let N_θ be a brick of complexity $n \geq 1$. From Proposition 4.7 we know that $c_n(N_\alpha) \leq n + d(\alpha, \theta)$ for any k -tuple α . We then say that α is *degenerate* if $c_n(N_\alpha) < n + d(\alpha, \theta)$ or $c(N_\alpha) = 0$. If S is a set of slopes lying on pairwise distinct components of ∂N , we add to S the $(\#\theta) - (\#S)$ θ -graphs of θ on the tori that S does not intersect, and we call S *degenerate* if the resulting k -tuple is.

Proposition 4.8. *Let N_θ be a brick of complexity n , with $\partial N = T_1 \sqcup \dots \sqcup T_k$.*

1. *If $n \geq 1$ then every slope $s_i \in \mathcal{S}(T_i)$ with $d(s_i, \theta_i) = -1$ is degenerate;*
2. *If $n \geq 2$ then any k -tuple containing a degenerate set of slopes is degenerate.*

Proof. The first assertion follows from Lemma 4.5 and Proposition 4.1. To prove the second one, let $\alpha_1, \dots, \alpha_k$ be a k -tuple where $\{\alpha_1, \dots, \alpha_j\}$ is a degenerate set of slopes for some $1 \leq j \leq k$. Namely, one of the following holds:

$$\begin{aligned} c_n(N_{\alpha_1, \dots, \alpha_j, \theta_{j+1}, \dots, \theta_k}) &= 0, \quad \text{or} \\ c_n(N_{\alpha_1, \dots, \alpha_j, \theta_{j+1}, \dots, \theta_k}) &< n + \sum_{i=1}^j d(\alpha_i, \theta_i). \end{aligned}$$

If the second relation does not hold, so the first does, we deduce that $n \leq k$, whence $n \leq 3$ by Theorem 2.3. But $n \geq 2$, so $N_\theta = B_4$ and $k = j = 3$, and we have nothing to prove. So we can proceed assuming the second relation holds. Now Lemma 4.5 and Proposition 4.1 again imply that either $c_n(N_{\alpha_1, \dots, \alpha_k}) = 0$ or

$$c_n(N_{\alpha_1, \dots, \alpha_k}) \leq c_n(N_{\alpha_1, \dots, \alpha_j, \theta_{j+1}, \dots, \theta_k}) + \sum_{i=j+1}^k d(\alpha_i, \theta_i),$$

so $c_n(N_{\alpha_1, \dots, \alpha_k}) < n + d(\alpha, \theta)$. □

The following result will be used later in this section and in Section 5 to show that n is well-behaved on tori for $n \leq 9$.

Proposition 4.9. *Let $n > 1$ and assume the following holds for every brick B with $1 < c(B) \leq n$:*

- *B is not a marked \mathbf{T} or $T \times I$;*
- *If α is a non-empty set of slopes on ∂B and B_α is a marked \mathbf{T} or $T \times I$ then α is degenerate.*

Then n is well-behaved on tori.

Proof. Assume n is not well-behaved on tori. An argument similar to the proof of Proposition 4.6 shows that there is a marked \mathbf{T} or $T \times I$, which we denote by M , and an assembling with centre B realizing $c_n(M) < c_1(M)$. Of course $1 < c(B) \leq n$. Then, as in the proof of Proposition 4.7, one shows that there is a k -tuple β such that $B_\beta = M$ and β is non-degenerate. Let α be obtained from β by dismissing the θ -graphs and keeping the slopes. Then B_α is also a marked \mathbf{T} or $T \times I$, so α is non-empty and degenerate by assumption. But β contains α , which contradicts Proposition 4.8-(2). □

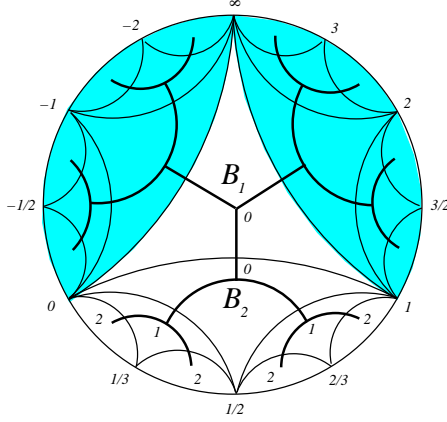

Figure 6: Marked solid tori and their complexity.

Remark 4.10. We emphasize that the set α in the previous statement consists of slopes only, not of θ -graphs too. We also recall that that none of the bricks of complexity between 2 and 9 is a marked \mathbf{T} or $T \times I$. Moreover, of the non-closed bricks B_4, \dots, B_{10} , we know that B_5, B_6, B_7 have only one boundary component. Therefore, to conclude that $n = 9$ is well-behaved on tori, we will only need to show that all the fillings of B_4, B_8, B_9, B_{10} giving $T \times I$ or \mathbf{T} are degenerate. Moreover B_4 alone already suffices for n up to 8.

Computation of c_1 We start by computing $c_n(M)$ for $n = 1$ and any irreducible and atoroidal marked M . For $n \geq 3$ we will confine ourselves to the closed case. The bricks of complexity 0 and 1 are marked $T \times I$'s and \mathbf{T} 's, so $c_1(M) < \infty$ precisely when M is $T \times I$, \mathbf{T} , a lens space, S^3 , or \mathbb{RP}^3 . And of course $c_1(S^3) = c_1(\mathbb{RP}^3) = 0$.

We now establish two results that will be used to compute c_1 on torus bundles and lens spaces respectively. Here and in the sequel we will denote by $f : \Theta(T \times \{0\}) \rightarrow \Theta(T \times \{1\})$ the obvious map given by the product structure of $T \times I$.

Proposition 4.11. *If θ_i marks $T \times \{i\}$ then $c_1((T \times I)_{\theta_0, \theta_1}) = d(f(\theta_0), \theta_1)$.*

Proof. Set $M = (T \times I)_{\theta_0, \theta_1}$. Proposition 4.7 implies that $c_1(M)$ equals the minimum of $d(\theta'_0, \theta) + d(\theta'_1, f(\theta))$ over all realizations of M as $(T \times I)_{\theta'_0, \theta'_1}$, where θ'_0 and θ'_1 vary and θ is fixed. Now $d(\theta'_0, \theta) + d(\theta'_1, f(\theta)) \geq d(f(\theta'_0), \theta'_1)$. Moreover $d(f(\theta'_0), \theta'_1) = d(f(\theta_0), \theta_1)$, and it is possible to realize M with $\theta'_0 = \theta$, whence the equality. \square

Proposition 4.12. *There is a natural correspondence between the set of oriented marked solid tori and the vertices in the non-shadowed region of Fig. 6. If d denotes the distance induced by this correspondence then $c_1(\mathbf{T}_\theta) = d(\mathbf{T}_\theta, B_2)$ for every marked \mathbf{T}_θ distinct from B_1 .*

Proof. Choosing a meridian-longitude basis \mathfrak{b} for $H_1(\partial\mathbf{T})$, we can identify the space of marked solid tori up to orientation-preserving homeomorphism to the quotient of $\Theta(\partial\mathbf{T})$ under the action of the subgroup of $\mathrm{SL}_2(\mathbb{Z})$ consisting of upper triangular matrices. Via the map $\Psi_{\mathfrak{b}}$ of Section 3 we can also identify $\Theta(\partial\mathbf{T})$ to the set of vertices of the graph \mathcal{T} dual to the Farey tessellation of \mathbb{H}^2 . Upper triangular matrices in $\mathrm{SL}_2(\mathbb{Z})$ act on \mathbb{H}^2 as parabolic isometries fixing point $\infty \in \partial_{\mathbb{Q}}\mathbb{H}^2$, and a fundamental domain is delimited by two consecutive lines of \mathcal{L} ending at ∞ . Finally, Proposition 4.7 implies that if $c(\mathbf{T}) > 0$ then $c_1(\mathbf{T})$ equals $d(\mathbf{T}, B_2)$. \square

Figure 6 shows the positions of B_1 and B_2 and some values of c_1 . Orientation-reversal corresponds in the figure to the reflection in the vertical axis, which explains why the values of c_1 are symmetric with respect to it.

Turning to lens spaces, we have:

Proposition 4.13. *Let $L_{p,q}$ be a lens space. Then $c_1(L_{p,q}) = |p, q| - 2$.*

Proof. We have $L_{p,q} = \mathbf{T}_\alpha$ with a slope α having coordinates (q, p) with respect to a meridian-longitude basis. Figure 6 and Proposition 3.3 now imply that the distance between α and the θ -graph of B_2 is $|q, p| - 2$. Our result follows from Proposition 4.7, since $|q, p| = |p, q|$ by Proposition 1.4-(2). \square

Note that by convention we view $L_{p,q}$ as a honest lens space precisely when $|p, q| \geq 2$.

A preview on torus bundles Even if this section is devoted to atoroidal manifolds, to proceed we need to state the (easy) computation of c_1 on torus bundles. Proposition 6.8 will show that c_n equals c_1 on these manifolds for $n = 2, \dots, 9$.

Proposition 4.14. *If $A \in \mathrm{SL}_2(\mathbb{Z})$ and T_A is the torus bundle over the circle with monodromy A then:*

- $c_0(T_A)$ equals 6 if $\|A\| \leq 1$ and ∞ otherwise;
- $c_1(T_A) = \max\{\|A\| + 5, 6\}$.

Proof. The only way to obtain a torus bundle T_A using bricks having complexity 0 is to do a self-assembling of $B_0 = (T \times I)_{\theta, f(\theta)}$ along a map ψ acting as (a matrix conjugate to) A on homology. Recall that $\psi(\theta)$ has distance at most 1 from $f(\theta)$. It

follows from Corollary 3.5 that we can realize precisely those bundles T_A such that $\|A\| \leq 1$, and $c_0 = 6$ on them. This shows the first assertion.

If we also allow bricks of complexity 1, we can realize T_A only as a self-assembling along a ψ as above of some $(T \times I)_{\theta_0, \theta_1}$, which is itself either B_0 or an assembling of copies of B_3 . Moreover $c_1((T \times I)_{\theta_0, \theta_1}) = d(f(\theta_0), \theta_1)$ by Proposition 4.11. So, viewing A as a fixed map from $T \times \{0\}$ to $T \times \{1\}$, we have

$$c_1(T_A) = 6 + \min \{d(f(\theta_0), \theta_1) : \theta_i \in \Theta(T \times i), d(A\theta_0, \theta_1) \leq 1\}.$$

Corollary 3.5 then shows that $c_1(T_A) = 6 + \max\{0, \|A\| - 1\}$, and the second assertion is proved. \square

Computation of c_3 The brick B_4 is a marked $D_2 \times S^1$, where D_2 is the disc with two holes. Let us now fix a canonical homology basis (a_i, b_i) on the i -th component of $\partial(D_2 \times S^1)$, where a_i is a component of ∂D_2 with induced orientation, b_i is a copy of the fibre S^1 , and the basis is positive. Using these bases we will henceforth use rational numbers or ∞ to describe slopes. Recalling also that we are denoting by $\theta^{(i)}$ the θ -graph containing the slopes $i, i + 1$, and ∞ , it is now easy to see from Fig. 3 that

$$B_4 = (D_2 \times S^1)_{\theta^{(0)}, \theta^{(0)}, \theta^{(-1)}}.$$

Using Remark 4.10, the next result shows that $n = 8$ is well-behaved on tori.

Proposition 4.15. *1. If α consists of some slopes on $\partial(D_2 \times S^1)$ and $(D_2 \times S^1)_\alpha$ is T or $T \times I$ then α contains a slope 0 or $1/q$ for $q \in \mathbb{Z}$;*

2. All slopes 0 and $1/q$ for $q \in \mathbb{Z}$ on any component of ∂B_4 are degenerate;

3. A filling of B_4 along a non-degenerate triple of slopes is either a genuine closed atoroidal Seifert manifold or $T \begin{pmatrix} 0 & 1 \\ -1 & -1 \end{pmatrix}$;

4. If $0 < q_i < p_i$ for $i = 1, 2, 3$ and $t \geq -1$ then

$$c_3(S^2, (p_1, q_1), (p_2, q_2), (p_3, q_3), t) = |p_1, q_1| + |p_2, q_2| + |p_3, q_3| + t + 1 \quad (10)$$

except when $t = -1, q_1 = q_2 = q_3 = 1$ and $\{p_1, p_2, p_3\}$ equals either $\{2, 2, 2\}$, or $\{2, 2, 3\}$, or $\{2, 3, 6\}$, or $\{2, 4, 4\}$. For these cases the value of c_3 is respectively 2, 3, 6, and 6.

Remark 4.16. Let us explain why there are four special manifolds excluded from the range of applicability of (10), but $(S^2, (3, 1), (3, 1), (3, 1), -1) = T \begin{pmatrix} 0 & 1 \\ -1 & -1 \end{pmatrix}$, which is also quite special, is not excluded. The first two manifolds excluded are the two

closed bricks having complexity at most 3 (denoted by $C_{1,1}$ and $C_{1,2}$ in Proposition 2.4). Their complexity is 2 and 3 respectively, and (10) is incorrect for them, because it would give 3 and 4 respectively. Turning to the torus bundles

$$T_{\begin{pmatrix} 0 & 1 \\ -1 & 1 \end{pmatrix}}, \quad T_{\begin{pmatrix} 0 & 1 \\ -1 & 0 \end{pmatrix}}, \quad T_{\begin{pmatrix} 0 & 1 \\ -1 & -1 \end{pmatrix}}$$

(see Proposition 1.1), we know [8, 11] that their complexity is 6, and we have seen in Proposition 4.14 that c_1 already equals 6 on them, while formula (10) gives 8, 7, and 6 respectively. This means that the formula is incorrect for the first two of them, but it is correct for the last one. It also means that $T_{\begin{pmatrix} 0 & 1 \\ -1 & -1 \end{pmatrix}}$ can be expressed both as a sharp self-assembling of one B_0 , and as a sharp assembling of one B_4 and three B_2 's. We have here one of the (not many) instances we know of non-uniqueness in Theorem 2.1.

Proof of 4.15. If all slopes in α are different from 0 and $1/q$ then $(D_2 \times S^1)_\alpha$ is Seifert fibred with $\#\alpha$ exceptional fibres, and point 1 easily follows. Let us turn to point 2. The slope 0 is degenerate on each boundary component by Proposition 4.8-(1), because it is contained in both $\theta^{(0)}$ and $\theta^{(-1)}$. Let us prove that a slope $1/q$ on the j -th boundary component is degenerate. If we perform a $1/q$ -Dehn filling on the j -th component we get some $(T \times I)_{\theta_0, \theta_1}$. It is now easy to prove that:

$$\begin{aligned} d(f(\theta_0), \theta_1) &= \begin{cases} |q| & \text{if } j = 1, 2 \\ |q - 1| & \text{if } j = 3 \end{cases} \\ d(1/q, \theta^{(i)}) &= \begin{cases} \max\{q - 2, -q - 1\} & \text{if } i = 0 \\ \max\{q - 1, -q - 2\} & \text{if } i = -1 \end{cases} \end{aligned}$$

(see also Corollary 3.4). In all cases we get

$$c_1(T \times I, \{\theta_0, \theta_1\}) = d(f(\theta_0), \theta_1) < 3 + d(1/q, \theta^{(i)})$$

by Proposition 4.11, and point 2 is proved.

To prove point 3, let us take a triple α of slopes not containing 0's and $1/q$'s. Then $(B_4)_\alpha$ is Seifert fibred over S^2 with three exceptional fibres, so it is either genuine and atoroidal or one of the three exceptional torus bundles of Proposition 1.1-(1). We will show together with point 4 that α is degenerate when $(B_4)_\alpha$ is $T_{\begin{pmatrix} 0 & 1 \\ -1 & 1 \end{pmatrix}}$ or $T_{\begin{pmatrix} 0 & 1 \\ -1 & 0 \end{pmatrix}}$, and it is not when $(B_4)_\alpha$ is $T_{\begin{pmatrix} 0 & 1 \\ -1 & -1 \end{pmatrix}}$.

So we turn to point 4, treating first the case of a genuine atoroidal manifold

$$M = (S^2, (p_1, q_1), (p_2, q_2), (p_3, q_3), t).$$

The shape of B_0, \dots, B_3 and the knowledge of the closed bricks of small complexity show that only for $M = C_{1,1}$ and $M = C_{1,2}$ it is possible to realize M as an assembling of bricks with complexity at most 3 but without B_4 's. Of course $c_3(M) = c(M)$ for $M = C_{1,1}$ and $M = C_{1,2}$, so we exclude these two cases. By Proposition 4.7 the conclusion will now follow as soon as we prove that the minimum of

$$3 + d(\alpha_1, \theta^{(0)}) + d(\alpha_2, \theta^{(0)}) + d(\alpha_3, \theta^{(-1)})$$

over all realizations of M as $(D_2 \times S^1)_{\alpha_1, \alpha_2, \alpha_3}$ is $|p_1, q_1| + |p_2, q_2| + |p_3, q_3| + t + 1$. It is well-known that, up to permutation, the choices of $\alpha_1, \alpha_2, \alpha_3$ leading to one such realization are precisely those of the form

$$(\alpha_1, \alpha_2, \alpha_3) = (sp_1/(q_1 + k_1 \cdot p_1), sp_2/(q_2 + k_2 \cdot p_2), sp_3/(q_3 + k_3 \cdot p_3))$$

for $s \in \{1, -1\}$ and integers k_1, k_2, k_3 such that $k_1 + k_2 + k_3 = t$.

Before computing the minimum we recall that $d(p/q, \theta^{(0)}) = |p, q| - 1$ and $d(p/q, \theta^{(-1)}) = |p, p + q| - 1$ by Corollary 3.4. Moreover if $0 < q < p$ we have $|p, q - p| = |p, q|$ by Proposition 1.4-(2). So, using the definition of $|\cdot, \cdot|$ we have for $h > 0$ that

$$\begin{aligned} |p, q + hp| &= |p, q| + h, \\ |p, q - hp| &= 1 + |p, hp - q| = 1 + (h - 1) + |p, p - q| = |p, q| + h, \\ \Rightarrow |p, q + k \cdot p| &= |p, q| + |k| \quad \forall k \in \mathbb{Z}. \end{aligned}$$

Similarly:

$$\begin{aligned} |p, -q - hp| &= 1 + |p, q + hp| = 1 + h + |p, q|, \\ |p, -q + hp| &= h - 1 + |p, p - q| = -1 + h + |p, q|, \\ \Rightarrow |p, -q - k \cdot p| &= |p, q| + |k + 1| \quad \forall k \in \mathbb{Z}. \end{aligned}$$

Back to our minimum, let us first compute it over realizations with $s = 1$. From the previous discussion we have

$$\begin{aligned} 3 &+ d(\alpha_1, \theta^{(0)}) + d(\alpha_2, \theta^{(0)}) + d(\alpha_3, \theta^{(-1)}) \\ &= |p_1, q_1 + k_1 \cdot p_1| + |p_2, q_2 + k_2 \cdot p_2| + |p_3, q_3 + (1 + k_3) \cdot p_3| \\ &= |k_1| + |k_2| + |1 + k_3| + \sum_{i=1}^3 |p_i, q_i| \end{aligned}$$

therefore the minimum is attained when $k_1 = k_2 = 0$ and $k_3 = t$, and its value is $\sum_i |p_i, q_i| + t + 1$. Note that this value is unchanged under reordering of the p_i/q_i 's, and that the assumption $t \geq -1$ is used here.

Let us now consider the realizations with $s = -1$. From the properties of $|\cdot, \cdot|$ shown above we deduce that

$$\begin{aligned}
3 &+ d(\alpha_1, \theta^{(0)}) + d(\alpha_2, \theta^{(0)}) + d(\alpha_3, \theta^{(-1)}) \\
&= |p_1, -q_1 - k_1 \cdot p_1| + |p_2, -q_2 - k_2 \cdot p_2| + |p_3, -q_3 - (k_3 - 1) \cdot p_3| \\
&= |1 + k_1| + |1 + k_2| + |k_3| + \sum_{i=1}^3 |p_i, q_i|
\end{aligned}$$

so the minimum is attained when $k_1 = k_2 = -1$ and $k_3 = t + 2$, and its value is $\sum_i |p_i, q_i| + t + 2$. Again this value is invariant under reordering, and the conclusion of point 3 easily follows.

We are left to consider the three Seifert manifolds which are not genuine and atoroidal because they can also be described as torus bundles. For these manifolds c_1 equals 6 by Proposition 4.14. Now suppose there is an assembling which realizes $c_3(T_A)$ and includes some copy of B_4 . Then $c_3(T_A)$ is computed just as above in the atoroidal case, taking a minimum over all fillings of B_4 that give T_A . This minimum is respectively 8, 7, and 6 when A is $\begin{pmatrix} 1 & -1 \\ 1 & 0 \end{pmatrix}$, $\begin{pmatrix} 0 & 1 \\ -1 & 0 \end{pmatrix}$, and $\begin{pmatrix} 0 & 1 \\ -1 & -1 \end{pmatrix}$. In the first two cases, we deduce that the triple giving T_A is degenerate. In the last case, the triple is non-degenerate. \square

Computation of c_8 and c_9 Recall that there are two bricks B_5 and B_6 having complexity 8, and four B_7, \dots, B_{10} having complexity 9. The bricks B_6, \dots, B_{10} are hyperbolic, and it will follow from Propositions 5.4 and 5.5 that they give no contribution to the values of c_8 and c_9 for non-hyperbolic manifolds (see Proposition 6.7). Therefore we have $c_8 = c_9$ on Seifert manifolds, and we conclude this section by studying the contribution of the brick B_5 to $c_8 = c_9$ on the atoroidal ones. Let us first describe B_5 . We take $D_2 \times S^1$ with the basis on the boundary defined above for B_4 , and again we use the rationals to denote slopes. Then $B_5 = (D_2 \times S^1)_{2,3,\theta}$ where θ is the θ -graph containing the slopes $-1, -6/5, -5/4$.

Proposition 4.17. *1. A slope α on B_5 is non-degenerate if and only if $-5/4 < \alpha < -1$ and $\alpha \notin \{-6/5, -7/6, -8/7\}$;*

2. The fillings of B_5 along non-degenerate slopes are precisely the Seifert manifolds of the form $(S^2, (2, 1), (3, 1), (p, q), -1)$ with $p/q > 5$, $p/q \notin \{6, 7, 8\}$.

3. For $p/q > 5, p/q \notin \{6, 7, 8\}$ we have $c_8(S^2, (2, 1), (3, 1), (p, q), -1) = |p, q| + 2$.

Remark 4.18. • The formula for c_8 in point 3 indeed does not apply for $p/q \in \{6, 7, 8\}$, because it would give $p/q + 1$, but we can actually show that c_8

equals p/q in these three cases: for $p/q = 6$ the corresponding manifold is $T_{\begin{pmatrix} 0 & 1 \\ -1 & 1 \end{pmatrix}}$, whose complexity is 6, so c_8 and c_9 also are 6 (and we have seen in Proposition 4.14 that c_1 already is 6). For $p/q = 7, 8$ we get the closed bricks $E_2, E_3 \in \mathcal{M}^*$, having complexity 7 and 8 respectively.

- Comparison with Proposition 4.15 shows that $c_8 = c_3 - 1$ on manifolds of the form $(S^2, (2, 1), (3, 1), (p, q), -1)$ for $p/q > 5$, $p/q \notin \{6, 7, 8\}$.

Proof of 4.17. We first show that the slopes outside $(-5/4, -1)$ are degenerate. Later we will prove that the slopes inside $(-5/4, -1)$, except $-6/5, -7/6, -8/7$, are non-degenerate, and at the same we will describe the fillings they determine and the complexity c_8 of these fillings.

Let us then fix $\alpha \in \partial_{\mathbb{Q}}\mathbb{H}^2$ and define $M = (B_5)_{\alpha}$, *i.e.* $M = (D_2 \times S^1)_{2,3,\alpha}$. We recall that $B_4 = (D_2 \times S^1)_{\theta(0),\theta(0),\theta(-1)}$ and $c(B_4) = 3$. Hence, by Proposition 4.7,

$$c_8(M) \leq 3 + 0 + 1 + d(\alpha, \theta^{(-1)}).$$

A sufficient condition for α to be degenerate is then that

$$4 + d(\alpha, \theta^{(-1)}) < 8 + d(\alpha, \theta) \tag{11}$$

(where θ is the θ -graph on ∂B_5). Figure 7, which uses an alternative embedding of the Farey tessellation, easily proves that (11) holds if $\alpha \notin [-5/4, -1)$. So all the slopes outside $[-5/4, -1)$ are degenerate, but $-5/4$ also is, because it is contained in θ (see Proposition 4.8), and our first task is accomplished.

We can now concentrate on the slopes inside $(-5/4, -1)$, which are precisely those of the form $p/(q-p)$ for $0 < q < p$ and $p/q > 5$. Note that M is then given by

$$M = (S^2, (2, 1), (3, 1), (p, q-p)) = (S^2, (2, 1), (3, 1), (p, q), -1)$$

and the latter expression is the unique normalized one. Now $\alpha = -6/5$ is degenerate because it is contained in θ . For $\alpha = -7/6$ we get $M = E_2$ and $c(M) = 7 < 8 = 8 + d(\alpha, \theta)$, so α is again degenerate. For $\alpha = -8/7$ we get $M = E_3$ and $c(M) = 8$, and α is degenerate for the same reason.

Now take α in $(-5/4, -1) \setminus \{-6/5, -7/6, -8/7\}$. Then M is not a closed brick of complexity up to 8. Hence, by Propositions 4.7 and 4.15 we have

$$c_8(M) = \min\{c_3(M), c(B_5) + d(\alpha, \theta)\} = \min\{3 + |p, q|, 8 + d(\alpha, \theta)\}$$

where $\alpha = p/(q-p)$. Corollary 3.4 gives $3 + |p, q| = 4 + d(\alpha, \theta^{(-1)})$ and Fig. 7 gives $d(\alpha, \theta) = d(\alpha, \theta^{(-1)}) - 5$, hence $c_8(M) = c_3(M) - 1 = |p, q| + 2$, and our argument is complete. \square

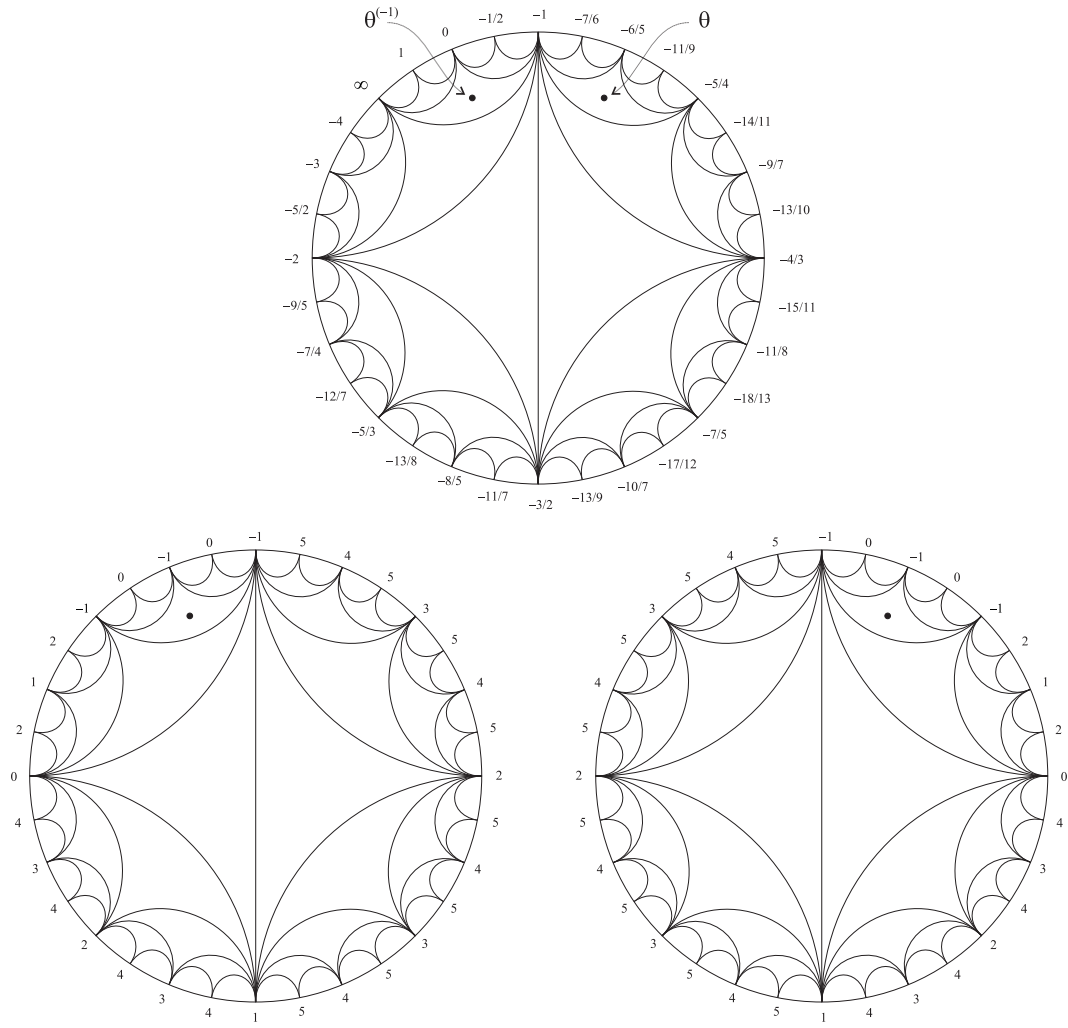

Figure 7: Position of $\theta^{(-1)}$ and θ , and computation of $d(\alpha, \theta^{(-1)})$ and $d(\alpha, \theta)$.

5 Complexity of hyperbolic manifolds

As we know from Theorem 1.10, for a closed hyperbolic M we have $c_9(M) < \infty$ if and only if M is a Dehn filling of $M6_1^3$. We denote in this section this manifold by N , and we carefully analyze the complexity of its fillings. In particular, we compute c_8 and c_9 on the hyperbolic fillings (proving Theorem 1.15) and we show that all the other fillings are degenerate. The latter result will be used in Section 6 to conclude the computation of c_n on Seifert manifolds.

Recall that N is a link complement in S^3 and that the slopes on ∂N are described by rational numbers or ∞ using the meridian-longitude homology bases.

Computation of c_8 The non-closed bricks of complexity 8 are the Seifert brick B_5 already discussed above and $B_6 = N_{1,-4,\theta(-1)}$, a marking of the “figure-8 knot sister” $N_{1,-4} = M2_2^1$. We start with the following easy result, which implies the first half of Theorem 1.15:

Proposition 5.1. *Let M be closed hyperbolic. Then $c_8(M)$ equals the minimum of $7 + |p, -q|$ over all realizations of M as $N_{1,-4,p/q}$.*

Proof. By Proposition 4.7, $c_8(M)$ is the minimum of $c(M'_\theta) + d(\alpha, \theta)$ with $M'_\theta \in \mathcal{B}_{\leq 8}$ and $M = M'_\alpha$. Since no filling of a Seifert manifold is hyperbolic, we deduce that M'_θ must be B_6 . So $c_8(M)$ is the minimum of $8 + d(p/q, \theta^{(-1)})$ over all realizations of M as $N_{1,-4,p/q}$. Now $d(p/q, \theta^{(-1)}) = |p + q, q| - 1$ by Corollary 3.4, and it is easy to see that $|p + q, q| = |p, -q|$, using Proposition 3.3 and the matrix S_1 of Section 1, which fixes $\theta^{(0)}$ and maps $(p + q)/q$ to $-p/q$. \square

Special fillings There is one more crucial ingredient that we must introduce before computing c_9 and characterizing the degenerate fillings of B_6, \dots, B_{10} . This ingredient is the complete classification, established in [10] and highlighted in Theorem 1.13 above, of the closed non-hyperbolic fillings of N . We need here only a simplified version of [10, Theorem 1.3], which is Proposition 5.2 below. Later we will need to refer to [10, Theorem 1.3] only for the 14 exceptional filling triples listed in the last point of Theorem 1.13.

Before proceeding we must introduce some notation. As we did before the statement of Proposition 4.15 for $i = 2$, we denote by D_i the disc with i holes, and we take product positive homology bases on the components of $\partial(D_i \times S^1)$. We use these bases to describe the filling coefficients on $D_i \times S^1$ as rational numbers or ∞ , and to describe gluing maps of boundary tori as matrices in $\text{GL}_2(\mathbb{Z})$.

Proposition 5.2 ([10]). *The following homeomorphisms hold:*

$$N_{\infty, \frac{r}{s}, \frac{t}{u}} = (D_1 \times S^1)_{\frac{r}{s}, -\frac{u}{t}} \quad (12)$$

$$N_{-3, \frac{r}{s}, \frac{t}{u}} = (D_2 \times S^1)_{2, \frac{r+s}{r+2s}} \bigcup_{\begin{pmatrix} 1 & 1 \\ 0 & -1 \end{pmatrix}} (D_2 \times S^1)_{2, \frac{t+u}{t+2u}} \quad (13)$$

$$N_{-2, \frac{r}{s}, \frac{t}{u}} = (D_2 \times S^1)_{\frac{3}{2}, -2-\frac{r}{s}, -2-\frac{t}{u}} \quad (14)$$

$$N_{-1, \frac{r}{s}, \frac{t}{u}} = (D_2 \times S^1)_{2, -3-\frac{r}{s}, -3-\frac{t}{u}} \quad (15)$$

$$N_{0, \frac{r}{s}, \frac{t}{u}} = (D_2 \times S^1)_{\frac{s}{r+2s}, \frac{u}{t+2u}} \bigcup_{\begin{pmatrix} 0 & -1 \\ 1 & 1 \end{pmatrix}} (D_2 \times S^1)_{2,3} \quad (16)$$

$$N_{1,1, \frac{t}{u}} = (D_2 \times S^1)_{-\frac{u}{t+2u}} \bigg/ \begin{pmatrix} 1 & -1 \\ -1 & 0 \end{pmatrix}. \quad (17)$$

Complexity estimates We prove now certain complexity estimates needed below. Our statement involves the norm $|A|$ defined in Section 1 for $A \in \text{GL}_2(\mathbb{Z})$.

Lemma 5.3. *1. If α_1 and α_2 are slopes or θ -graphs on distinct boundary components of $D_2 \times S^1$ then*

$$c_3((D_2 \times S^1)_{\alpha_1, \alpha_2, \theta^{(-1)}}) \leq 3 + d(\theta^{(0)}, \alpha_1) + d(\theta^{(0)}, \alpha_2).$$

2. Let $\begin{pmatrix} i & j \\ h & k \end{pmatrix} \in \text{GL}_2(\mathbb{Z})$. Assume (α_1, α_2) and (α_3, α_4) are pairs as in the previous point. Then:

$$c_3 \left((D_2 \times S^1)_{\alpha_1, \alpha_2} \bigcup_{\begin{pmatrix} i & j \\ h & k \end{pmatrix}} (D_2 \times S^1)_{\alpha_3, \alpha_4} \right) \leq 6 + \sum_{l=1}^4 d(\alpha_l, \theta^{(0)}) + \left| \begin{pmatrix} i & -j \\ -h & k \end{pmatrix} \right|.$$

3. If α is a slope or a θ -graph on $\partial(D_2 \times S^1)$ then

$$c_3 \left((D_2 \times S^1)_{\alpha} \bigg/ \begin{pmatrix} 1 & -1 \\ -1 & 0 \end{pmatrix} \right) \leq 9 + d(\alpha, \theta^{(-1)}).$$

Proof. Point 1 readily follows from Proposition 4.1, using $B_4 = (D_2 \times S^1)_{\theta^{(0)}, \theta^{(0)}, \theta^{(-1)}}$, because $c(B_4) = 3$.

For point 2 we apply the inequality of point 1 to both the blocks involved, and we change the homology bases on the boundary of both blocks, performing a change of type $(a, b) \mapsto (-a, b)$. In the new basis the old θ -graph $\theta^{(-1)}$ is transformed into $\theta^{(0)}$, and the gluing matrix becomes $A = \begin{pmatrix} i & -j \\ -h & k \end{pmatrix}$. Now Proposition 4.1 implies that the gluing matching $\theta^{(0)}$ to $A\theta^{(0)}$ can be realized by insertion of $d(\theta^{(0)}, A\theta^{(0)})$ copies

of B_3 and assembling. But $d(\theta^{(0)}, A\theta^{(0)}) = |A|$ by Corollary 3.5 and the conclusion follows.

Turning to point 3, we note that $c_3(D_2 \times S^1)_{\alpha, \theta^{(0)}, \theta^{(0)}} \leq 3 + d(\alpha, \theta^{(-1)})$, again from Proposition 4.1 applied to B_4 . Now the gluing map with matrix $\begin{pmatrix} 1 & -1 \\ -1 & 0 \end{pmatrix}$ matches $\theta^{(0)}$ to $\theta^{(-1)}$, and $d(\theta^{(0)}, \theta^{(-1)}) = 1$, so the map can be realized via a self-assembling. We deduce the upper bound $6 + 3 + d(\alpha, \theta^{(-1)})$ on c_3 , and the proof is complete. \square

Degenerate fillings of B_6 Now we turn to the discussion of non-hyperbolic fillings of $N_{1,-4}$. The following result will be used in Propositions 6.7 and 6.8 to show that B_6 gives no contribution to $c_8(M)$ if M is a Seifert manifold or a torus bundle.

Proposition 5.4. *Every slope on $B_6 = N_{1,-4, \theta^{(-1)}}$ producing a non-hyperbolic manifold is degenerate.*

Proof. Corollary 1.14 shows that the slopes that we must prove to be degenerate are precisely $\infty, -3, -2, -1, -1/2, -1/3, 0, 1$. The slopes $\infty, -1, 0$ are degenerate by Proposition 4.8-(1). It follows from (7) and (13) that

$$N_{1,-4,-3} = N_{1,-4,-1/3} = (D_2 \times S^1)_{2,2} \bigcup_{\begin{pmatrix} 0 & 1 \\ -1 & -1 \end{pmatrix}} (D_2 \times S^1)_{2,3}.$$

Lemma 5.3-(2) then implies that

$$\begin{aligned} c_3(N_{1,-4,-3}) &= c_3(N_{1,-4,-1/3}) \leq 6 + 0 + 0 + 0 + 1 + 0 = 7 \\ &< 9 = c(B_6) + d(-3, \theta^{(-1)}) = c(B_6) + d(-1/3, \theta^{(-1)}) \end{aligned} \quad (18)$$

so -3 and $-1/3$ are degenerate. For the slopes -2 and $-1/2$ we use the following equality, again deduced from (7) and (14) or [10, Theorem 1.3]:

$$N_{1,-4,-2} = N_{1,-4,-1/2} = (S^2, (3, 2), (3, 2), (2, 1), -1).$$

We can then apply Proposition 4.15-(4) to see that

$$c_3(N_{1,-4,-2}) = c_3(N_{1,-4,-1/2}) = 2 + 2 + 1 + (-1) + 1 = 5 < 8 = c(B_6).$$

Therefore -2 and $-1/2$ are also degenerate. We are left to deal with the slope 1. By (17) or [10, Theorem 1.3] we have $N_{1,-4,1} = T_A$ with $A = \begin{pmatrix} -3 & -1 \\ 1 & 0 \end{pmatrix}$. Now $\|A\| \leq d(\theta^{(-1)}, A\theta^{(-1)})$ by Corollary 3.5, but $A\theta^{(-1)} = \theta^{(-3)}$, so $\|A\| \leq 2$, and $c_1(T_A) \leq 7$ by Proposition 4.14. Since $7 < 8 = c(B_6) + d(1, \theta^{(-1)})$, we deduce that 1 is also degenerate, and the proof is complete. \square

Computation of c_9 The bricks $B_6, B_7, B_8, B_9,$ and B_{10} are respectively $M2_2^1, M3_4^1, M4_1^2, N = M6_1^3,$ and N again (with appropriate markings; as above we use the notation of [5] for cusped hyperbolic manifolds). Each of these manifolds can be obtained as an appropriate Dehn filling of N . So for $i = 6, \dots, 10$ we can describe B_i as $N_{\alpha^{(i)}}$ where $\alpha^{(i)}$ is a triple of slopes and/or θ -graphs. Due to the symmetries of N the triples $\alpha^{(i)}$ are not unique, but we choose the following definite ones:

$$\begin{aligned}\alpha^{(6)} &= (1, -4, \theta^{(-1)}), & \alpha^{(7)} &= (1, -5, \theta^{(-1)}), & \alpha^{(8)} &= (1, \theta^{(-2)}, \theta^{(-2)}), \\ \alpha^{(9)} &= (\theta^{(-2)}, \theta^{(-2)}, \theta^{(-2)}), & \alpha^{(10)} &= (\theta^{(-2)}, \theta^{(-2)}, \theta^{(-3)}).\end{aligned}$$

The proof that indeed $B_i = N_{\alpha^{(i)}}$ for $i = 6, \dots, 10$ uses the explicit description of the B_i 's given in [8].

As opposed to what we did for c_8 , we start for c_9 with the non-hyperbolic fillings of N , because we have not proved yet well-behavedness on tori of $n = 9$. This property is readily implied by the next result, using Remark 4.10 and the information already shown on B_4 in Proposition 4.15. The next result will also be used in Propositions 6.7 and 6.8 to show that c_9 equals c_8 on Seifert manifolds and torus bundles.

Proposition 5.5. *If $B \in \{B_7, \dots, B_{10}\}$ and α is a set of slopes on ∂B such that B_α is not hyperbolic then α is degenerate.*

Proof. Recall that the triples α such that N_α is not hyperbolic were described in Theorem 1.13. Since $c(B_i) > 2$ for $i = 7, \dots, 10$ we can now apply Proposition 4.8-(2). According to this result, to prove our proposition it is sufficient to show degeneracy with respect to B_i of the α 's as follows:

- (a) α is a triple of slopes and θ -graphs obtained from $\alpha^{(i)}$ by removing some θ -graphs and inserting slopes instead of them;
- (b) α satisfies one of the conditions of Theorem 1.13;
- (c) it is impossible to attain one of the conditions of Theorem 1.13 with a smaller number of θ -graph-to-slope replacements on $\alpha^{(i)}$.

To prove that all such α 's are degenerate, we first establish upper bounds on $c_9(N_\alpha)$ for all α 's obtained as in (a)-(c) from $\alpha^{(9)}$. Our inequalities use many facts already established, together with the easy relation

$$\left\| \begin{pmatrix} n & -1 \\ 1 & 0 \end{pmatrix} \right\| \leq d \left(\theta^{(-1)}, \begin{pmatrix} n & -1 \\ 1 & 0 \end{pmatrix} \theta^{(-1)} \right) = d(\theta^{(-1)}, \theta^{(n)}) = |n + 1| \quad (19)$$

(already used with $n = -3$ in the proof of Proposition 5.4). To save space while helping the reader follow our arguments, we will write under each equality or inequality sign the equation or statement it is implied by, with "[10]" standing for [10, Theorem 1.3].

$$\begin{aligned}
c_9(N_{\infty, \theta^{(-2)}, \theta^{(-2)}}) &\stackrel{(12)}{=} c_9(T \times I, \theta^{(-2)} \times \{0\}, \theta(-1, -1/2, 0) \times \{1\}) \\
&\stackrel{\text{Prop. 4.1}}{\leq} d(\theta^{(-2)}, \theta(-1, -1/2, 0)) = 2
\end{aligned} \tag{20}$$

(here $\theta(-1, -1/2, 0)$ denotes the θ -graph containing the slopes -1 , $-1/2$, and 0).

$$\begin{aligned}
c_9(N_{-3, \theta^{(-2)}, \theta^{(-2)}}) &\stackrel{(13)}{=} c_9\left((D_2 \times S^1)_{2, \theta^{(0)}} \cup_{\begin{pmatrix} 1 & 1 \\ 0 & -1 \end{pmatrix}} (D_2 \times S^1)_{2, \theta^{(0)}}\right) \\
&\stackrel{\text{Lem. 5.3(2)}}{\leq} 6 + 0 + 0 + 0 + 0 + 0 = 6.
\end{aligned} \tag{21}$$

$$\begin{aligned}
c_9(N_{-2, \theta^{(-2)}, \theta^{(-2)}}) &\stackrel{(14)}{=} c_9((D_2 \times S^1)_{3/2, \theta^{(-1)}, \theta^{(-1)}}) \stackrel{\text{Lem. 5.3(1)}}{\leq} 3 + 1 + 1 = 5.
\end{aligned} \tag{22}$$

$$\begin{aligned}
c_9(N_{-1, \theta^{(-2)}, \theta^{(-2)}}) &\stackrel{(15)}{=} c_9((D_2 \times S^1)_{2, \theta^{(-2)}, \theta^{(-2)}}) \\
&\stackrel{\text{Prop. 4.1}}{\leq} c_9((D_2 \times S^1)_{2, \theta^{(-2)}, \theta^{(-1)}}) + d(\theta^{(-2)}, \theta^{(-1)}) \\
&\stackrel{\text{Lem. 5.3(1)}}{\leq} 3 + 0 + 2 + 1 = 6.
\end{aligned}$$

$$\begin{aligned}
c_9(N_{0, \theta^{(-2)}, \theta^{(-2)}}) &\stackrel{(16)}{=} c_9\left((D_2 \times S^1)_{\theta^{(0)}, \theta^{(0)}} \cup_{\begin{pmatrix} 0 & -1 \\ 1 & 1 \end{pmatrix}} (D_2 \times S^1)_{2, 3}\right) \\
&\stackrel{\text{Lem. 5.3(2)}}{\leq} 6 + 0 + 0 + 0 + 1 + 0 = 7.
\end{aligned} \tag{23}$$

$$\begin{aligned}
c_9(N_{1, 1, \theta^{(-2)}}) &\stackrel{(17)}{=} c_9\left((D_2 \times S^1)_{\theta^{(-1)}} / \begin{pmatrix} 1 & -1 \\ -1 & 0 \end{pmatrix}\right) \stackrel{\text{Lem. 5.3(3)}}{\leq} 9 + 0 = 9.
\end{aligned} \tag{24}$$

$$\begin{aligned}
c_9(N_{-4, -1/2, \theta^{(-2)}}) &\stackrel{(2)_{-1}}{=} c_9(N_{-3/2, 0, \theta^{(-2)}}) \\
&\stackrel{\text{Prop. 4.1}}{\leq} c_9(N_{0, \theta^{(-2)}, \theta^{(-2)}}) + d(-3/2, \theta^{(-2)}) \stackrel{(23)}{\leq} 7 + 0 = 7.
\end{aligned}$$

$$\begin{aligned}
c_9(N_{-5/2, -3/2, \theta^{(-2)}}) &\stackrel{(4)}{=} c_9(N_{-5/2, -3, \theta^{(-2)}}) \\
&\stackrel{\text{Prop. 4.1}}{\leq} c_9(N_{\theta^{(-2)}, -3, \theta^{(-2)}}) + d(-5/2, \theta^{(-2)}) \leq 6 + 1 = 7. \tag{21}
\end{aligned}$$

$$c_9(N_{-5, -5, -1/2}) \stackrel{(5)}{=} c_9(N_{1,1, -1/2}) \stackrel{\text{Prop. 4.1}}{\leq} c_9(N_{1,1, \theta^{(-2)}}) + d(-1/2, \theta^{(-2)}) \leq 9 + 1 = 10. \tag{24}$$

$$\begin{aligned}
c_9(N_{-4, -4, -2/3}) &\stackrel{(2)}{=} c_9(N_{-3/2, 1, 1}) \\
&\stackrel{\text{Prop. 4.1}}{\leq} c_9(N_{1,1, \theta^{(-2)}}) + d(-3/2, \theta^{(-2)}) \leq 9 + 0 = 9. \tag{25}
\end{aligned}$$

$$c_9(N_{-3/2, -7/3, -7/3}) \stackrel{(3)}{=} c_9(N_{-3/2, 1, 1}) \leq 9. \tag{25}$$

$$c_9(N_{-4, -3/2, -3/2}) \stackrel{[10]}{=} c_9\left(T_{\begin{pmatrix} -3 & -1 \\ 1 & 0 \end{pmatrix}}\right) \stackrel{\text{Prop. 4.14}}{\leq} 5 + \left\| \begin{pmatrix} -3 & -1 \\ 1 & 0 \end{pmatrix} \right\| \leq 5 + 2 = 7. \tag{19}$$

$$c_9(N_{-8/3, -3/2, -3/2}) \stackrel{(2)}{=} c_9(N_{-4, -1/3, 1}) \stackrel{(7)}{=} c_9(N_{1, -4, -3}) \leq 7. \tag{18}$$

$$c_9(N_{-5/2, -5/2, -4/3}) \stackrel{(4)}{=} c_9(N_{-5/2, 1, 1}) \stackrel{\text{Prop. 4.1}}{\leq} c_9(N_{1,1, \theta^{(-2)}}) + d(-5/2, \theta^{(-2)}) \leq 9 + 1 = 10. \tag{24}$$

$$\begin{aligned}
c_9(N_{-5/2, -5/3, -5/3}) &\stackrel{[10]}{=} c_9\left((D_2 \times S^1)_{2,2} \cup_{\begin{pmatrix} 1 & -1 \\ 0 & 1 \end{pmatrix}} (D_2 \times S^1)_{2,3}\right) \\
&\stackrel{\text{Lem. 5.3(2)}}{\leq} 6 + 0 + 0 + 0 + 1 + 1 = 8.
\end{aligned}$$

$$c_9(N_{1,2,2}) \stackrel{[10]}{=} c_9(S^2, (2, 1), (3, 1), (7, 1), -1) = 7$$

(the last equality holds because $(S^2, (2, 1), (3, 1), (7, 1), -1)$ is the closed brick E_2 of \mathcal{M}^* , and its complexity is 7).

$$c_9(N_{1,2,3}) \stackrel{[10]}{=} c_9(S^2, (2, 1), (4, 1), (5, 1), -1) \stackrel{\text{Prop. 4.15-(4)}}{\leq} 1 + 3 + 4 + (-1) + 1 = 8.$$

$$c_9(N_{1,2,4}) \underset{[10]}{=} c_9(S^2, (3, 1), (3, 1), (4, 1), -1) \underset{\text{Prop. 4.15-(4)}}{\leq} 2 + 2 + 3 + (-1) + 1 = 7.$$

$$c_9(N_{1,2,5}) \underset{[10]}{=} c_9\left((D_2 \times S^1)_{2,2} \cup_{\begin{pmatrix} 0 & 1 \\ 1 & 0 \end{pmatrix}} (D_2 \times S^1)_{2,3}\right) \underset{\text{Lem. 5.3(2)}}{\leq} 6 + 0 + 0 + 0 + 1 + 0 = 7.$$

$$c_9(N_{1,3,3}) \underset{[10]}{=} c_9\left((D_2 \times S^1)_{2,3} \cup_{\begin{pmatrix} 1 & 2 \\ 0 & -1 \end{pmatrix}} (D_2 \times S^1)_{2,2}\right) \underset{\text{Lem. 5.3(2)}}{\leq} 6 + 0 + 1 + 0 + 0 + 1 = 8.$$

$$c_9(N_{2,2,2}) \underset{[10]}{=} c_9\left((D_2 \times S^1)_{2,3} \cup_{\begin{pmatrix} 2 & 3 \\ -1 & -2 \end{pmatrix}} (D_2 \times S^1)_{2,2}\right) \underset{\text{Lem. 5.3(2)}}{\leq} 6 + 0 + 1 + 0 + 0 + 2 = 9. \quad (26)$$

Using these inequalities, we prove now that the triples α obtained as explained in (a)-(c) from $\alpha^{(i)}$ are degenerate with respect to B_i for $i = 7, \dots, 10$. We start with $i = 7$. Since $\alpha^{(7)} = (1, -5, \theta^{(-1)})$ the only triples we have to consider are $(1, -5, n)$ for $n = -3, -2, -1, 0, 1, \infty$. Now $-1, 0, \infty$ are degenerate because they are contained in $\theta^{(-1)}$. And the slopes $-3, -2$, and 1 are degenerate because

$$c_9(N_{1,-5,-3}) \underset{\text{Prop. 4.1}}{\leq} c_9(N_{\theta^{(-2)}, \theta^{(-2)}, -3}) + d(\theta^{(-2)}, 1) + d(\theta^{(-2)}, -5) \underset{(21)}{\leq} 6 + 1 + 2 = 9 < 10 = 9 + 1 = c(B_7) + d(-3, \theta^{(-1)})$$

$$c_9(N_{1,-5,-2}) \underset{\text{Prop. 4.1}}{\leq} c_9(N_{\theta^{(-2)}, \theta^{(-2)}, -2}) + d(\theta^{(-2)}, 1) + d(\theta^{(-2)}, -5) \underset{(22)}{\leq} 5 + 1 + 2 = 8 < 9 = 9 + 0 = c(B_7) + d(-2, \theta^{(-1)})$$

$$c_9(N_{1,1,-5}) \underset{[10]}{=} c_9\left(T_{\begin{pmatrix} 4 & 1 \\ -1 & 0 \end{pmatrix}}\right) \underset{\text{Prop. 4.14}}{\leq} 5 + \left\| \begin{pmatrix} 4 & 1 \\ -1 & 0 \end{pmatrix} \right\| \underset{(19)}{\leq} 5 + 3 = 8 < 9 = 9 + 0 = c(B_7) + d(1, \theta^{(-1)}).$$

To conclude for $i = 8, 9, 10$ we now claim that for all the triples α obtained as explained in (a)-(c) from $\alpha^{(9)}$ the following inequality holds:

$$c_9(N_\alpha) < 8 + d(\alpha, \alpha^{(9)}). \quad (27)$$

Before proving (27), we show that it is sufficient to conclude not only for $i = 9$, which is obvious since $c(B_9) = 9$, but also for $i = 8$ and $i = 10$. We start with $i = 10$ and assume that α is obtained as in (a)-(c) from $\alpha^{(10)}$ by some θ -graph-to-slope replacement. Let $\tilde{\alpha}$ be obtained by performing the same replacements on $\alpha^{(9)}$. Then (27) applies to $\tilde{\alpha}$. Using the fact that $d(\alpha^{(9)}, \alpha^{(10)}) = d(\theta^{(-2)}, \theta^{(-3)}) = 1$, it is also easy to see that either $d(\alpha, \tilde{\alpha}) = 0$ and $d(\tilde{\alpha}, \alpha^{(9)}) \leq d(\alpha, \alpha^{(10)}) + 1$, or $d(\tilde{\alpha}, \alpha) = 1$ and $d(\tilde{\alpha}, \alpha^{(9)}) = d(\alpha, \alpha^{(10)})$. In particular, the following holds anyway:

$$d(\tilde{\alpha}, \alpha^{(9)}) + d(\tilde{\alpha}, \alpha) \leq d(\alpha, \alpha^{(10)}) + 1. \quad (28)$$

Hence

$$\begin{aligned} c_9(N_\alpha) &\stackrel{\text{Prop. 4.1}}{\leq} c_9(N_{\tilde{\alpha}}) + d(\tilde{\alpha}, \alpha) \stackrel{(27)}{\leq} 8 + d(\tilde{\alpha}, \alpha^{(9)}) + d(\tilde{\alpha}, \alpha) \\ &\stackrel{(28)}{\leq} 9 + d(\alpha, \alpha^{(10)}) = c(B_{10}) + d(\alpha, \alpha^{(10)}). \end{aligned}$$

For $i = 8$ a very similar argument applies, except that to define $\tilde{\alpha}$ it is necessary in some cases to replace $\theta^{(-2)}$ by 1, to ensure that one of the properties (A), (B), or (C) is fulfilled. The key point is in any case that $d(\alpha^{(8)}, \alpha^{(9)}) = d(1, \theta^{(-2)}) = 1$.

Having shown that (27) allows to conclude the proof, we then establish it. Recall that the α 's to consider are precisely those appearing in the left-hand side of the inequalities (20) to (26), and there is nothing to prove whenever $d(\alpha, \alpha^{(9)}) \geq 0$ and the right-hand side is 7 or less. In the other cases we get the result by computing $d(\alpha, \alpha^{(9)})$ and showing that it is greater than -8 plus the number on the right-hand side:

$$\begin{aligned} d((\infty, \theta^{(-2)}, \theta^{(-2)}), \alpha^{(9)}) &= -1 > 2 - 8 \\ d((-2, \theta^{(-2)}, \theta^{(-2)}), \alpha^{(9)}) &= -1 > 5 - 8 \\ d((-1, \theta^{(-2)}, \theta^{(-2)}), \alpha^{(9)}) &= -1 > 6 - 8 \\ d((1, 1, \theta^{(-2)}), \alpha^{(9)}) &= 2 > 9 - 8 \\ d((-5, -5, -1/2), \alpha^{(9)}) &= 5 > 10 - 8 \\ d((-4, -4, -2/3), \alpha^{(9)}) &= 4 > 9 - 8 \\ d((-7/3, -7/3 - 3/2,), \alpha^{(9)}) &= 4 > 9 - 8 \\ d((-5/2, -5/2, -4/3), \alpha^{(9)}) &= 3 > 10 - 8 \\ d((-5/2, -5/3, -5/3), \alpha^{(9)}) &= 3 > 8 - 8 \end{aligned}$$

$$\begin{aligned}
d((1, 2, 2), \alpha^{(9)}) &= 5 > 9 - 8 \\
d((1, 2, 3), \alpha^{(9)}) &= 6 > 8 - 8 \\
d((1, 3, 3), \alpha^{(9)}) &= 7 > 8 - 8 \\
d((2, 2, 2), \alpha^{(9)}) &= 6 > 9 - 8.
\end{aligned}$$

Our argument is now complete □

Having proved eventually that 9 is well-behaved on tori, we are now ready to apply Proposition 4.7 to compute c_9 on the negatively curved fillings of N . To do this we need to slightly extend the “distance” function d introduced in Section 3. Recall that $d(\alpha, \alpha')$ was originally defined when α is either a θ -graph or a slope on a given torus, and α' is a θ -graph. Now we also allow the case where both α and α' are slopes, defining $d(\alpha, \alpha')$ to be 0 if they coincide and $+\infty$ if they do not. The following result is an easy consequence of Proposition 4.7

Lemma 5.6. *Let M be hyperbolic. Then $c_9(M)$ equals the minimum of $c(B_i) + d(\alpha, \alpha^{(i)})$ over all realizations of M as N_α and all $6 \leq i \leq 10$.*

Recall that at the end of Section 1 we have defined a certain function h on triples of rational numbers. The next result implies the second part of Theorem 1.15.

Proposition 5.7. *Assume M is irreducible, closed, atoroidal, and not a Seifert manifold. Then $c_9(M)$ equals the minimum of $h(p/q, r/s, t/u)$ over all realizations of M as $N_{p/q, r/s, t/u}$.*

Proof. By Lemma 5.6, it is sufficient to fix $p/q, r/s, t/u$ and prove that $h(p/q, r/s, t/u)$ is $\min\{k_6, \dots, k_{10}\}$ where $k_i = c(B_i) + d((p/q, r/s, t/u), \alpha^{(i)})$.

We first note that $d(p/q, \theta^{(-2)}) = |p + 2q, q| - 1$, whence $k_9 = 6 + |p + 2q, q| + |r + 2s, s| + |t + 2u, u|$. We will compute our minimum by systematically analyzing for $i \neq 9$ the triples on which k_i is smaller than k_9 . We start with k_{10} and note that it is smaller than k_9 precisely when $p/q < -2$ up to permutation, and $k_{10} = -1 + k_9$ in this case.

Concerning k_8 , we note that it is finite precisely when $p/q = 1$ up to permutation. Moreover $d(1, \theta^{(-2)}) = 1$, so k_8 is smaller than k_9 for $p/q = 1$, and again the difference is 1.

Now k_7 is finite precisely when $p/q = 1$ and $r/s = -5$ up to permutation. Moreover $d(1, \theta^{(-2)}) = 1$ and $d(-5, \theta^{(-2)}) = 2$, so there is a -3 gain on the first two coordinates. And $d(\theta^{(-1)}, \theta^{(-2)}) = 1$, so there is a global gain whatever the last coordinate. More precisely, there is a further -1 gain with respect to k_9 when $t/u > -1$, and a $+1$ loss if $t/u < -1$. Summing up we have $k_7 = -4 + k_9$ if $p/q = 1, r/s = -5, t/u > -1$ up to permutation, and $k_7 = -2 + k_9$ if $p/q = 1, r/s = -5, t/u < -1$ up to permutation.

We are left to analyze k_6 , which is finite when $p/q = 1$ and $r/s = -4$ up to permutation. Since $d(1, \theta^{(-2)}) = d(-4, \theta^{(-2)}) = 1$ we have a -2 gain on the first two coordinates, together with a -1 gain coming from the fact that $c(B_6) = 8$. As above there is a further -1 gain if $t/u > -1$, and a $+1$ loss $t/u < -1$. Therefore $k_7 = -4 + k_9$ if $p/q = 1, r/s = -4, t/u > -1$ up to permutation, and $k_7 = -2 + k_9$ if $p/q = 1, r/s = -4, t/u < -1$ up to permutation.

This analysis easily implies that indeed $\min\{k_6, \dots, k_{10}\}$ is $h(p/q, r/s, t/u)$. \square

6 Complexity of Seifert manifolds and torus bundles

The key tool used for the computation of c_n in the atoroidal case, namely Proposition 4.6, is typically not valid for Seifert manifolds and torus bundles, so a different technique has to be employed.

Seifert manifolds with compatible markings The bricks involved in the calculation of c_3 have markings containing fibres of their product fibration. This motivates the following:

Definition 6.1. The total space of a Seifert fibration has *compatible* marked boundary if every θ -graph of the marking contains a fibre (up to isotopy).

It turns out that the set of *oriented* manifolds with markings compatible with a given Seifert fibration is parameterized by \mathbb{Z} . To show this, denote by $\theta_{(i)}$ the θ -graph which contains the slopes $0, 1/i$, and $1/(i+1)$, and note that any oriented Seifert manifold with compatible marking can be expressed as

$$M = (F \overset{(\infty)}{\times} S^1)_{\frac{p_1}{q_1}, \dots, \frac{p_h}{q_h}, \theta_{(i_1)}, \dots, \theta_{(i_k)}}$$

with $p_j > q_j > 0$ for all j . Here F is a surface with $h+k$ boundary components, $F \overset{(\infty)}{\times} S^1$ denotes the unique oriented circle bundle over F , and $k \geq 1$ otherwise M is closed. Moreover, slopes are expressed using homology bases as described at the beginning of Section 1, *i.e.* positive bases with first vector contained in a section of $F \overset{(\infty)}{\times} S^1$, and a fibre as second vector. These requirements do not determine the bases uniquely if $k > 1$, but the general theory of Seifert bundles [6] easily implies that the \mathbb{Z} -valued invariant

$$t(M) = i_1 + \dots + i_k$$

is well-defined and parameterizes compatible markings on M .

Proposition 6.2. *Reversing orientation we get $t(-M) = -t(M) - h - k$.*

Proof. Under orientation reversal, coordinates of slopes get multiplied by -1 , hence $\theta_{(i)}$ becomes $\theta_{(-i-1)}$. Therefore

$$\begin{aligned} -M &= (F \overset{\circlearrowleft}{\times} S^1)_{-\frac{p_1}{q_1}, \dots, -\frac{p_h}{q_h}, \theta_{(-i_1-1)}, \dots, \theta_{(-i_k-1)}} \\ &= (F \overset{\circlearrowleft}{\times} S^1)_{\frac{p_1}{p_1-q_1}, \dots, \frac{p_h}{p_h-q_h}, \theta_{(-i_1-1-h)}, \dots, \theta_{(-i_k-1)}} \end{aligned}$$

whence the conclusion. \square

Small bricks have compatible marking The first bricks B_0, \dots, B_4 have markings compatible with the product fibration (but B_5 has not). We list their twisting numbers t below. For all bricks except B_0 there are two choices of t , depending on orientation.

$$\begin{aligned} t(B_0) &= -1, & t(B_1) &\in \{-1, 0\}, & t(B_2) &\in \{-2, 1\}, \\ t(B_3) &\in \{-2, 0\}, & t(B_4) &\in \{-2, -1\}. \end{aligned} \tag{29}$$

Let S be the Möbius strip. We will also need below the marked manifold $Z = S \overset{\circlearrowleft}{\times} S^1$ with $t(Z) \in \{-1, 0\}$.

Given two *oriented* Seifert manifolds with compatible markings, we define now an assembling of them to be *compatible* if it is orientation-reversing and fibre-preserving. The result of this assembling is another oriented Seifert manifold with compatible marking. The same definition applies to a self-assembling. In the following lemma, N may be closed, and in this case $t(N)$ is the twisting number defined in Section 1.

Lemma 6.3. *If N is obtained as a compatible assembling of M and M' , then $t(N) = t(M) + t(M') + 1$. If N is obtained as a compatible self-assembling of M , then $t(N) = t(M) + 1$.*

Proof. We prove the first assertion only, because a similar argument shows the second one. Let us note that

$$t \left((F \overset{\circlearrowleft}{\times} S^1)_{\frac{p_1}{q_1}, \dots, \frac{p_h}{q_h}, \frac{1}{b}, \theta_{(i_1)}, \dots, \theta_{(i_k)}} \right) = b + i_1 + \dots + i_k$$

whenever $p_j > q_j > 0$, and this formula gives the correct value of the twisting number even for $k = 0$, *i.e.* when the manifold is closed. Hence we can write

$$M = (F \overset{\circlearrowleft}{\times} S^1)_{\frac{p_1}{q_1}, \dots, \frac{p_h}{q_h}, \frac{1}{t(M)}, \theta_{(0)}, \dots, \theta_{(0)}}, \quad M' = (F' \overset{\circlearrowleft}{\times} S^1)_{\frac{p'_1}{q'_1}, \dots, \frac{p'_h}{q'_h}, \frac{1}{t(M')+1}, \theta_{(-1)}, \theta_{(0)}, \dots, \theta_{(0)}}$$

and assume that one boundary torus of M is glued to the boundary torus of M' marked by $\theta_{(-1)}$. The gluing matrix A has determinant -1 and maps 0 to 0 (because

the assembling is compatible), so it maps $\{1, \infty\}$ to $\{-1, \infty\}$ (because it maps $\theta_{(0)}$ to $\theta_{(-1)}$). This implies that $A = \pm \begin{pmatrix} 1 & 0 \\ 0 & -1 \end{pmatrix}$, *i.e.* A matches the both the fibres and the sections of the fibrations, whence

$$N = ((F \cup F') \times S^1) \left(\frac{p_1}{q_1}, \dots, \frac{p_h}{q_h}, \frac{p'_1}{q'_1}, \dots, \frac{p'_h}{q'_h}, \frac{1}{t(M)}, \frac{1}{t(M')+1}, \theta_{(0)}, \dots, \theta_{(0)} \right)$$

and the conclusion follows. \square

We recall now that the Seifert parameters for a manifold with non-empty boundary are almost always unique. In the setting of Seifert manifolds with compatible markings, the next lemma describes two non-uniqueness instances needed below. Recall that D is the disc and D_i is the disc with i holes.

Lemma 6.4. *The brick B_2 equals $(D_1 \times S^1)_{2, \theta_{(-1)}}$, and Z equals $(D_2 \times S^1)_{2, 2, \theta_{(-1)}}$.*

Proof. By (29) we have $B_2 = (D \times S^1)_{\theta_{(-2)}}$, but $(D_1 \times S^1)_2$ is homeomorphic to $D \times S^1$. Using the explicit homeomorphism one easily gets the first assertion.

For the second assertion, recall that the fibrations $(D_2 \times S^1)_{2, 2}$ and $S \times S^1$ are homeomorphic, and the fibres have geometric intersection 1 when the fibrations are identified. A θ -graph is compatible with both fibrations when it contains both the fibres, so there are two such θ -graphs θ and θ' . Set

$$\begin{aligned} t_D &= t((D_2 \times S^1)_{2, 2, \theta}), & t'_D &= t((D_2 \times S^1)_{2, 2, \theta'}), \\ t_S &= t((S \times S^1)_\theta), & t'_S &= t((S \times S^1)_{\theta'}). \end{aligned}$$

Reversing orientation t_S gets replaced by $-t_S - 1$, but the property that a θ -graph contains both fibres is insensitive to orientation, so $-t_S - 1 \in \{t_S, t'_S\}$ whence $t'_S = -t_S - 1$. Moreover θ and θ' share two curves, so t_S and t'_S must be consecutive, which implies that $\{t_S, t'_S\} = \{-1, 0\}$. A similar argument proves that $\{t_D, t'_D\} = \{-2, -1\}$. Therefore $Z = (S \times S^1)_{\theta_{(t_S)}}$ for $t_S \in \{-1, 0\}$ is also $(D_2 \times S^1)_{2, 2, \theta_{(t_D)}}$ for $t_D \in \{-2, -1\}$. \square

The previous result implies the fact (also used in the proof) that Z has a marking compatible with both its original $S \times S^1$ and its alternative $(D_2 \times S^1)_{2, 2}$ fibrations. Lemmas 6.3 and 6.4 readily imply the following:

Corollary 6.5. *There is an assembling of one B_4 and two B_2 's realizing Z .*

We can now compute c_3 on Seifert manifolds.

Theorem 6.6. *Let $M = (F, (p_1, q_1), \dots, (p_k, q_k), t)$ be a closed genuine Seifert manifold with parameters normalized so that $k - \chi(F) > 0$, $p_i > q_i > 0$, $t \geq -k/2$. If M is not $(S^2, (2, 1), (2, 1), (j, 1), -1)$ for $j \in \{2, 3\}$ then:*

$$c_3(M) = \max\{0, t - 1 + \chi(F)\} + 6(1 - \chi(F)) + \sum_{i=1}^k (|p_i, q_i| + 2).$$

Proof. Our proof is organized as a sequence of claims and constructions, and it uses the Seifert Z introduced above, fibred as $S \tilde{\times} S^1$. The assumption that M is not $(S^2, (2, 1), (2, 1), (j, 1), -1)$ for $j \in \{2, 3\}$ ensures that M is not a closed brick of complexity up to 3, so every realization of $c_3(M)$ will consist of blocks B_0, B_1, B_2, B_3, B_4 .

Claim 1. *There exists an assembling of bricks realizing $c_3(M)$ and such that:*

- *it involves only copies of B_2 , B_3 , and B_4 ;*
- *each copy of B_3 is saturated (i.e. it is a union of fibres);*
- *each copy of B_4 is either saturated or assembled to two copies of B_2 giving a saturated Z as a result;*
- *each copy of B_2 not contained in the Z 's just described is a regular neighbourhood of an exceptional fibre of M , and conversely each exceptional fibre is contained in one such B_2 .*

To prove the claim we fix an assembling realizing $c_3(M)$ with a minimal number of copies of B_4 . The only case where B_0 's cannot be dismissed is when M is a torus bundle, and this is not our case. Lemma 4.5 easily implies that our assembling cannot involve B_1 's, so there are only B_2 's, B_3 's, and B_4 's. Moreover, there is at least one B_4 , otherwise M is a lens space.

Let us concentrate on one B_4 and note that, by irreducibility of the blocks involved, each component of ∂B_4 is either incompressible in M or the boundary of a solid torus \mathbf{T} . Since $n = 3$ is well-behaved on tori, minimality of the number of B_4 's shows that such a \mathbf{T} must be an assembling of some B_3 's and one B_2 . In particular, \mathbf{T} lies outside B_4 , and hence defines a Dehn filling of B_4 . Moreover, if the filled slope is r/s with respect to the basis fixed on $H_1(\partial B_4)$, we have $r \geq 2$ (up to switching signs) by Proposition 4.15-(2). Let $i \in \{0, 1, 2, 3\}$ be the number of incompressible components of ∂B_4 . Recall that incompressible tori are always fibred (because M is genuine, see [6]). The next discussion shows that we can modify the assembling so that all B_4 's are as in the claim:

- *If $i = 3$ then B_4 is saturated and compatible (because its fibration is unique);*

- If $i = 2$, the one solid torus incident to B_4 gives a r/s -Dehn filling N of B_4 with $r \geq 2$, so $N = (D_1, (r, s))$ has a unique Seifert fibration, which restricts to the fibration of B_4 . It follows that B_4 is saturated;
- If $i = 1$ the two T 's incident to B_4 give some saturated Dehn filling of B_4 , again denoted by N . Let r_1/s_1 and r_2/s_2 be the filled slopes, with $r_1, r_2 \geq 2$. If $r_1 > 2$ or $r_2 > 2$ then $N = (D, (r_1, s_1), (r_2, s_2))$ has a unique fibration, so B_4 is saturated. Assume $r_1 = r_2 = 2$ and choose homology bases on $\partial(D_2 \times S^1)$ so that B_4 is given by $\partial(D_2 \times S^1)_{\theta_{(0)}, \theta_{(0)}, \theta_{(t)}}$ for some $t \in \{-2, -1\}$, and the filled components are those marked by $\theta_{(0)}$. Note that this change of bases affects s_1 and s_2 : the new value of s_i is now intrinsically determined by the fact that $|2, s_i| - 1$ copies of B_3 (and one copy of B_2) realize the filling $2/s_i$. Moreover

$$N = (D \times S^1)_{\frac{2}{s_1}, \frac{2}{s_2}, \theta_{(t)}} = (D \times S^1)_{2, 2, \theta_{(t+(s_1-1)/2+(s_2-1)/2)}}.$$

Since $|2, 2h + 1| = |h| + 1$, setting $s_i = 2h_i + 1$, we see that the original assembling giving N consists of one B_4 , two B_2 's, and $|h_1| + |h_2|$ copies of B_3 . But N can also be realized as one $Z = (D \times S^1)_{2, 2, \theta_{(t)}}$ with $|s_1/2 + s_2/2 - 1| = |h_1 + h_2| \leq |h_1| + |h_2|$ copies of B_3 (whence $h_1 h_2 \geq 0$). Since $(D \times S^1)_{2, 2}$ admits two fibrations only, either the original B_4 or the new Z are saturated;

- If $i = 0$ then M is atoroidal and B_4 is the centre of the assembling, by Proposition 4.6.

Turning to the B_2 's not contained in the Z 's and to the B_3 's, we note that they are saturated, because their boundary is. The correspondence between exceptional fibres and B_2 's not contained in the Z 's is a byproduct of the above construction.

A modified realization and its graph. A self-assembling which identifies two tori T and T' matches $\theta \subset T$ either with $\theta' \subset T'$ or with another θ -graph on T' having distance 1 from θ' . In the second case we can insert one copy of B_3 and get a self-assembling which matches the θ -graphs. Doing this to an assembling giving $c_3(M)$ as in Claim 1, we get a realization of M as an assembling of blocks of type B_2, B_3, B_4, Z such that θ -graphs are always matched. We call *fake* the B_3 's we have inserted, and we define a graph \mathcal{G} with the blocks of our assembling as vertices and the gluings as edges. So the B_4 's are trivalent, the B_3 's are bivalent, the B_2 's and Z 's are univalent.

Claim 2. Let V_0, \dots, V_{n+1} be the vertices of a simple (possibly closed) path in \mathcal{G} . Suppose V_0, V_{n+1} are (possibly equal and) of type B_4 or Z and the V_1, \dots, V_n are of type B_3 . Then V_1, \dots, V_n are compatible. Let T_i be the torus along which V_{i-1} is glued to V_i and let θ_i be the θ -graph on T_i . Since the T_i 's are parallel in M , we can identify them to a single fibred torus T . Now $\theta_1, \dots, \theta_{n+1}$ can be viewed as

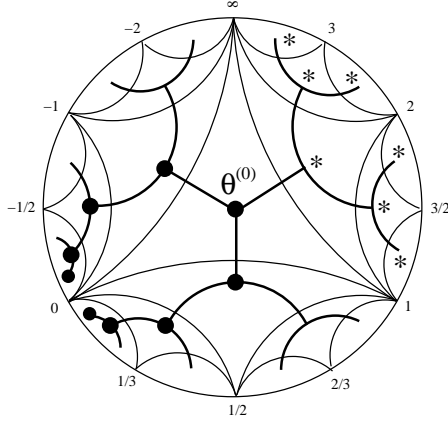

Figure 8: The θ -graph θ_1 is one of the stars, and θ_{n+1} is one of the solid dots.

the vertices of a path in $\Theta(T)$, because $d(\theta_i, \theta_{i+1}) = 1$. Minimality shows that this path must be simple, so it is determined by θ_1 and θ_{n+1} . Knowing that θ_1 and θ_{n+1} contain a fibre (because the blocks B_4 and Z are compatible), it is now easy to show that the other θ_i 's do, and the claim is proved.

Claim 3. Let V_0, \dots, V_{n+1} be the vertices of a simple path in \mathcal{G} . Suppose V_0 is a B_2 block containing an exceptional fibre of type (p, q) . Suppose V_{n+1} is of type B_4 or Z and V_1, \dots, V_n are of type B_3 . Then V_i is compatible for $i = |p, q|, \dots, n$ and it is not for $i = 1, \dots, |p, q| - 1$. With notation as for the previous claim, we note that there is a preferred positive basis (a, b) for $H_1(T)$, such that b is a fibre and $p \cdot a + q \cdot b$ is a meridian of V_0 . We use (a, b) to identify $\mathcal{S}(T)$ to $\partial_{\mathbb{Q}}(\mathbb{H}^2)$ and note that θ_{n+1} contains the slope 0, so it is one of the vertices marked by solid dots in Fig. 8. In addition θ_1 contains p/q and $1 < p/q < \infty$, so it is one of the vertices marked by stars. Using Proposition 3.3 and recalling that $\theta^{(0)}$ is the centre of the disc, we deduce that

$$n = d(\theta_1, \theta_{n+1}) = d(\theta_1, \theta^{(0)}) + d(\theta^{(0)}, \theta_{n+1}) = |p, q| + d(\theta^{(0)}, \theta_{n+1}).$$

The figure also shows that precisely the last $1 + d(\theta^{(0)}, \theta_{n+1})$ θ -graphs among $\theta_1, \dots, \theta_{n+1}$ contain 0, whence the conclusion at once.

Claim 4. If b_3^c is the number of non-fake compatible B_3 's in our assembling then

$$c_3(M) = b_3^c + 6(1 - \chi(F)) + \sum_{i=1}^k (|p_i, q_i| + 2).$$

Let us denote by b_3, b_4, z, s the number of non-fake B_3 's, of B_4 's, of Z 's, and of self-assemblings. By assumption we have $c_3(M) = b_3 + 3b_4 + 3z + 6s$, and Claims 2

and 3 show that

$$b_3 = b_3^c + \sum_{i=1}^k (|p_i, q_i| - 1) = b_3^c - 3k + \sum_{i=1}^k (|p_i, q_i| + 2).$$

We now claim that $b_4 = k - \chi(F)$ and $z = 2 - 2s - \chi(F)$. These relations easily imply the desired conclusion. Relation $\chi(F) = -b_4 + k$ readily follows from Lemma 6.3 and the identities (29). To show the other relation consider the fibred space arising from the assembling of the blocks of type B_2, B_3, B_4 only, without self-assemblings. The base surface is then a sphere with some holes. Filling z of these holes and identifying the boundary circles of s pairs of them we get the closed surface F . So there are $z + 2s$ holes in all, and $\chi(F) = 2 - (z + 2s)$, whence the desired relation.

Claim 5. Conclusion: $b_3^c = \max\{0, t - 1 + \chi(F)\}$. We first note that Claim 3 (and its proof) imply that by dismissing from our assembling the B_2 's and the non-compatible B_3 's we get an M' with $t(M') = t(M)$. We also note that $z + b_4 > 0$, otherwise M would be a lens space. Then we slightly change our perspective and ask ourselves to what extent do the numbers b_3^c, b_4, z, k actually determine M' . Namely we discuss what N 's can be realized as follows:

- N is connected and has k boundary components;
- N is obtained via fibre-preserving gluings from b_4 copies of B_4 , z copies of Z , b_3^c copies of B_3 , and some number $f \geq 0$ of additional copies of B_3 , with $z + b_4 > 0$;
- the graph of this gluing remains connected after removing the f additional copies of B_3 .

These conditions easily imply that there are $n = (z + 2(b_3^c + f) + 3b_4 - k)/2$ gluings, precisely $s = (3b_4 - z - k)/2 - (b_4 - 1)$ of which are self-assemblings. (Of course our notation for s is consistent with above.) Moreover N has base surface with Euler characteristic $-b_4$ and no exceptional fibres. For the other Seifert parameters we have some flexibility, because the gluing maps are not uniquely determined. The flexibility reduces if we fix orientations on all the blocks, because then the twisting number of each block is determined, so $t(N)$ is computed via Lemma 6.3. If $s = 0$ then the base surface is orientable, otherwise we can realize both an orientable and a non-orientable one without changing the other parameters.

Let us now discuss exactly what possible $t(N)$'s can be realized once b_3^c, b_4, z, k are given. Recall that, depending on orientation, $t(B_4)$ is -2 or -1 . Similarly $t(Z)$ is -1 or 0 and $t(B_3)$ is -2 or 0 . So:

$$-2b_4 - z - 2(b_3^c + f) + n \leq t(N) \leq -b_4 + n$$

and all possibilities can be realized by appropriate choices of orientations (because $z + b_4 > 0$). Noting that f can take any value between 0 and s and plugging in the values of n and s these inequalities easily imply that

$$-b_4 - b_3^c - 1 \leq t(N) \leq b_4 + b_3^c - k + 1 \quad (30)$$

and all these values can be realized.

We are eventually ready to prove the desired equality, so we assume that the parameters b_3^c, b_4, z, k and f arise as above from an assembling realizing $c_3(M)$. Since $b_4 - k = -\chi(F)$, the right-hand side of equation (30) readily implies that $b_3^c \geq \max\{0, t - 1 + \chi(F)\}$. We prove equality by contradiction, so we assume that $b_3^c > 0$ and $e < b_4 + b_3^c - k + 1$. Since $t \geq -k/2$ by assumption, we also have $t > -b_4 - b_3^c - 1$. Now equation (30) and the discussion leading to it prove that (M', X) could be realized with $b_3^c - 1$ copies of B_3 and all other parameters unchanged: a contradiction to minimality. \square

Proposition 6.7. *Let M be a closed Seifert manifold. Then:*

- *the bricks B_6, \dots, B_{10} give no contribution to $c_8(M)$ and $c_9(M)$;*
- *if M is toroidal, the brick B_5 gives no contribution to $c_8(M)$.*

Proof. The first point is easy. Assume there is a hyperbolic brick $B \in \{B_6, \dots, B_{10}\}$ in an assembling that realizes $c_8(M)$ or $c_9(M)$. Each boundary component of B either bounds a solid torus outside B or is incompressible in M . Let M' be the filling of B given by the union of B and the solid tori incident to it. Then, by Propositions 5.4 and 5.5, either the filling is degenerate or M' is hyperbolic, so it is one of the blocks of the JSJ decomposition of M , which is absurd.

Turning to the second point, we have

$$B_4 = (D_2 \times S^1)_{\theta^{(0)}, \theta^{(0)}, \theta^{(-1)}} \quad \text{and} \quad B_5 = (D_2 \times S^1)_{2,3,\theta} \quad \text{with } \theta \supset \{-5/4, -6/5, -1\}.$$

Let us then assume by contradiction that there is a copy of B_5 in an assembling realizing $c_8(M)$. Since M is toroidal, the single boundary component of B_5 is incompressible. Therefore B_5 is a union of fibres, and its induced Seifert structure, being unique, is precisely that of $(D_2 \times S^1)_{2,3,\theta}$. Moreover, glued to ∂B_5 , we have some B_3 's (possibly none of them) and then a brick B equal to either B_4 or B_5 .

Consider first the case where $B = B_4$. Precisely as in the proof of Theorem 6.6 we can see that either this B_4 is compatible or its two free boundary components are glued to two B_2 's so to give a compatible Z . In both cases we see that the original θ on ∂B_5 is modified along a simple path in \mathcal{T} until a compatible θ -graph θ' is reached, and the $d(\theta, \theta')$ edges in this path correspond to the copies of B_3 . The

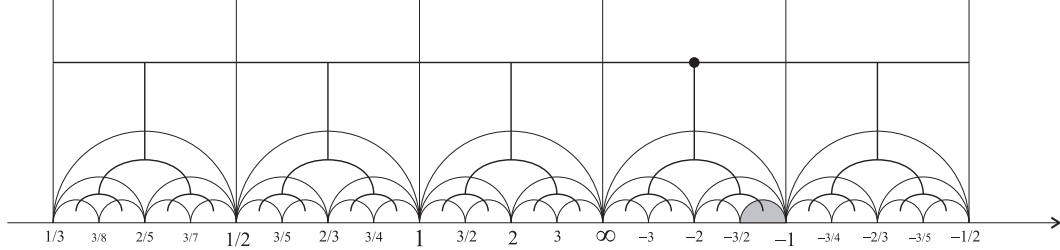

Figure 9: An alternative picture of the Farey tessellation.

sub-assembling consisting of B_5 and the neighbouring B_3 's gives $(D_2 \times S^1)_{2,3,\theta'}$ and contributes to $c_8(M)$ as

$$c(B_5) + d(\theta, \theta') = 8 + d(\theta, \theta^{(-1)}) + d(\theta^{(-1)}, \theta') = 8 + 5 + d(\theta^{(-1)}, \theta') = 13 + d(\theta^{(-1)}, \theta')$$

(identity $d(\theta, \theta') = d(\theta, \theta^{(-1)}) + d(\theta^{(-1)}, \theta')$ is deduced from Fig. 7, because θ' contains 0). Now the same $(D_2 \times S^1)_{2,3,\theta'}$ can also be realized using B_4 with complexity

$$c(B_4) + d(\theta^{(0)}, 2) + d(\theta^{(0)}, 3) + d(\theta^{(-1)}, \theta') = 3 + 0 + 1 + d(\theta^{(-1)}, \theta') = 4 + d(\theta^{(-1)}, \theta').$$

This proves that B_5 can be dismissed with a gain of 9 on complexity, so the original assembling was not a realization of $c_8(M)$, a contradiction.

The case where $B = B_5$ is similar. Here M is given by

$$(D_2 \times S^1)_{2,3} \bigcup_A (D_2 \times S^1)_{2,3}.$$

But M is Seifert, so $A = \begin{pmatrix} \pm 1 & 0 \\ n & 1 \end{pmatrix}$. Since the two manifolds glued along A both have θ on the boundary, the number of B_3 's required to assemble them is $d(\theta, A\theta)$, so $c_8(M) = 2 \cdot c(B_5) + d(\theta, A\theta) = 16 + d(\theta, A\theta)$. As above we can use B_4 instead of B_5 on both sides, deducing that

$$c_3(M) \leq 2 \cdot (3 + 0 + 1) + d(\theta^{(-1)}, A\theta^{(-1)}) = 8 + d(\theta^{(-1)}, A\theta^{(-1)}).$$

The conclusion now follows as soon as we show that $d(\theta^{(-1)}, A\theta^{(-1)}) < 8 + d(\theta, A\theta)$ for $A = \begin{pmatrix} \varepsilon & 0 \\ n & 1 \end{pmatrix}$, $\varepsilon = \pm 1$, $n \in \mathbb{Z}$. We begin with $\varepsilon = +1$ and note that $A = B^n$, where $B = \begin{pmatrix} 1 & 0 \\ 1 & 1 \end{pmatrix}$. We consider the alternative picture in the half-space model of \mathbb{H}^2 of the Farey tessellation and its dual graph, as shown in Fig. 9. (As above, the picture is only combinatorially, not geometrically, correct. Note also that we have

used a smaller and smaller character for p/q as $|p, q|$ grows.) Here B acts on the tessellation of Fig. 9 as the horizontal translation that moves each vertical half-line to the previous one. Since $\theta^{(-1)}$ is the dot marked in the picture whereas θ lies somewhere in the small shadowed region, we deduce that

$$d(\theta^{(-1)}, A\theta^{(-1)}) = |n|, \quad d(\theta, A\theta) = 2d(\theta, \theta^{(-1)}) + |n| = 10 + |n|$$

whence the desired inequality. When $A = \begin{pmatrix} -1 & 0 \\ n & 1 \end{pmatrix}$ the action of A on the tessellation is a horizontal translation followed by the reflection in the vertical half-line through 0 and ∞ . It is then easy to see that $d(\theta^{(-1)}, A\theta^{(-1)}) = |n-1|$ and $d(\theta, A\theta) = 10 + |n-1|$, whence the conclusion. \square

The two previous results conclude the proof of Theorem 1.11 for genuine Seifert manifolds, because $c_n(M)$ was already computed in Propositions 4.13, 4.15, and 4.17 for $n \leq 8$ when M is atoroidal and Seifert but not a member of \mathcal{M}^* . For torus bundles, having already computed c_1 in Proposition 4.14, we are left to show the following:

Proposition 6.8. $c_n(T_A) = c_1(T_A)$ for $n = 2, \dots, 9$.

Proof. We begin by noting the following topological fact: if H is an incompressible torus embedded in T_A then, cutting T_A along H , we get either $T \times I$ or two copies of $S \tilde{\times} S^1$ (the twisted S^1 -bundle over the Möbius strip). And, in the latter case, we have $A = \begin{pmatrix} -1 & 0 \\ t & -1 \end{pmatrix}$ up to conjugation, and $T_A = (K, +t) = (K, -t)$, where K denotes the Klein bottle.

Let us then consider an assembling realizing $c_n(T_A)$, and let $\mathcal{H} \subset T_A$ be the family of tori along which the gluings of the assembling are performed. If all tori in \mathcal{H} are compressible, well-behavedness of $n \leq 9$ easily implies that the assembling has a certain centre B_i with $i \geq 4$. However Propositions 4.15, 4.17, 5.4, and 5.5 imply that a filling of B_i giving T_A is always degenerate, except for $i = 4$ and $A = \begin{pmatrix} 0 & 1 \\ -1 & -1 \end{pmatrix}$, but in this case we have $c_1(T_A) = c_3(T_A) = c(T_A) = 6$, so $c_n(T_A) = 6$ for $1 \leq n \leq 9$.

Assume one $H \in \mathcal{H}$ cuts T_A into $T \times I$. Then a self-assembling is performed along H of a suitably marked $T \times I$. Well-behavedness of $n \leq 9$ implies that we can realize this pair as either B_0 or an assembling of B_3 's, so we have $c_n(T_A) = c_1(T_A)$.

Assume now one $H \in \mathcal{H}$ cuts T_A into two copies of $S \tilde{\times} S^1 = (D, (2, 1), (2, 1))$. Therefore $T_A = (K, \pm t)$ is Seifert, and every incompressible torus in \mathcal{H} is saturated. Although T_A is not genuine, this condition is enough in the proof of Theorem 6.6 to conclude that $c_3(M) = 6 + \max\{0, |t| - 1\} = \max\{6, \|A\| + 5\} = c_1(M)$, as required. \square

We conclude the section noting that a proof of Theorem 2.5-(3) is already contained in our results. In fact, Proposition 4.15-(4) proves that $c_3(C_{i,j}) = 1 + i + j$ if

$c^*(C_{i,j}) > 9$, whereas $c^*(C_{i,j}) = i + j$, Proposition 4.17-(3) proves that $c_8(E_k) = k + 6$ if $c^*(E_k) > 9$, whereas $c^*(E_k) = k + 5$, and Proposition 6.7 proves that $c_9(C_{i,j}) = c_3(C_{i,j})$ and $c_9(E_k) = c_8(E_k)$ under the same constraints.

7 Tables of small manifolds

We provide in this section a description, for $n = 0, \dots, 9$, of the set of closed orientable irreducible manifolds M with $c(M) = 9$. A summary of our results was already given in Table 3. For $n \leq 6$ we give here complete lists, including geometric information, while for $n = 7, 8, 9$ we only concentrate on the most interesting geometric features, addressing the reader to [18] for the lists. The lists for $n \leq 6$ coincide with those of Matveev [12].

Before turning to the data, we quickly sketch how we have found them. Note first that for M as above one has $c(M) \leq 9$ if and only if $c_9(M) \leq 9$, and $c(M) = c_9(M)$ in this case. Different enumeration methods were used to list manifolds of hyperbolic, geometric but non-hyperbolic, and graph type. The hyperbolic case was already discussed in Section 1. When M is geometric but non-hyperbolic, *i.e.* a Seifert manifold or a torus bundle, Theorems 1.11 and 2.5 allow to determine $c_9(M)$ directly. We have then written a computer program, available from [18], which lists all such M 's with $c_9(M) \leq 9$, using also Proposition 1.1 to avoid repetitions. To determine which graph manifolds M satisfy $c_9(M) \leq 9$ we have used some estimates in the spirit of Lemma 5.3, and the same computer program [18], which does a careful analysis of the different ways M can be presented as a graph manifold. Since this paper is devoted to geometric manifolds, we do not insist on these technicalities here.

In the rest of this section by ‘manifold’ we mean a closed, connected, orientable, irreducible 3-manifold. We recall now that we describe Seifert manifolds using the filling parameters, not the orbital parameters (see the beginning of Section 1), and we proceed to a more accurate explanation of our results. Below we will also use the notation employed in Section 5 to describe graph manifolds (and an obvious extension of this notation).

Complexity up to 5 It is well-known that the only manifolds of complexity 0 are S^3 , $L_{3,1}$, and $\mathbb{R}P^3$. In complexity 1 we have only the lens spaces $L_{4,1}$ and $L_{5,2}$. In complexity 2 the lens spaces $L_{5,1}$, $L_{7,2}$, and $L_{8,3}$, and the Seifert space $(S^2, (2, 1), (2, 1), (2, 1), -1)$, which carries elliptic geometry and belongs to \mathcal{M}^* . A similar phenomenon occurs in complexity 3, with the lens spaces

$$L_{6,1} \quad L_{9,2} \quad L_{10,3} \quad L_{11,3} \quad L_{12,5} \quad L_{13,5}$$

and the elliptic Seifert $(S^2, (2, 1), (2, 1), (3, 1), -1)$ which belongs to \mathcal{M}^* . In complexity 4 there are the lens spaces

$$L_{7,1} \ L_{11,2} \ L_{13,3} \ L_{14,3} \ L_{15,4} \ L_{16,7} \ L_{17,5} \ L_{18,5} \ L_{19,7} \ L_{21,8}$$

and the elliptic Seifert spaces

$$\begin{aligned} & (S^2, (2, 1), (2, 1), (2, 1)), \quad (S^2, (2, 1), (2, 1), (3, 2), -1), \\ & (S^2, (2, 1), (3, 1), (3, 1), -1), \quad (S^2, (2, 1), (2, 1), (4, 1), -1), \end{aligned}$$

the last two of which belong to \mathcal{M}^* .

In complexity 5 we have the lens spaces

$$\begin{aligned} & L_{8,1} \ L_{13,2} \ L_{16,3} \ L_{17,3} \ L_{17,4} \ L_{19,4} \ L_{20,9} \ L_{22,5} \ L_{23,5} \ L_{23,7} \\ & L_{24,7} \ L_{25,7} \ L_{25,9} \ L_{26,7} \ L_{27,8} \ L_{29,8} \ L_{29,12} \ L_{30,11} \ L_{31,12} \ L_{34,13} \end{aligned}$$

and the following elliptic Seifert spaces

$$\begin{aligned} & (S^2, (2, 1), (2, 1), (2, 1), 1), \quad (S^2, (2, 1), (2, 1), (3, 1)), \\ & (S^2, (2, 1), (2, 1), (3, 2)), \quad (S^2, (2, 1), (2, 1), (4, 3), -1), \\ & (S^2, (2, 1), (2, 1), (5, 2), -1), \quad (S^2, (2, 1), (2, 1), (5, 3), -1), \\ & (S^2, (2, 1), (3, 1), (3, 2), -1), \quad (S^2, (2, 1), (3, 2), (3, 2), -1), \\ & (S^2, (2, 1), (3, 1), (4, 1), -1), \quad (S^2, (2, 1), (2, 1), (5, 1), -1), \\ & (S^2, (2, 1), (3, 1), (5, 1), -1), \end{aligned}$$

the last three of which belong to \mathcal{M}^* (the last one is Poincaré's homology sphere). Note that all the manifolds found so far are Seifert bundles over S^2 with at most three exceptional fibres.

Complexity 6 The list of lens spaces in complexity 6 consists of

$$\begin{aligned} & L_{9,1} \ L_{15,2} \ L_{19,3} \ L_{20,3} \ L_{21,4} \ L_{23,4} \ L_{24,5} \ L_{24,11} \ L_{27,5} \ L_{28,5} \ L_{29,9} \ L_{30,7} \ L_{31,7} \\ & L_{31,11} \ L_{32,7} \ L_{33,7} \ L_{33,10} \ L_{34,9} \ L_{35,8} \ L_{36,11} \ L_{37,8} \ L_{37,10} \ L_{39,14} \ L_{39,16} \ L_{40,11} \\ & L_{41,11} \ L_{41,12} \ L_{41,16} \ L_{43,12} \ L_{44,13} \ L_{45,19} \ L_{46,17} \ L_{47,13} \ L_{49,18} \ L_{50,19} \ L_{55,21}. \end{aligned}$$

We then have many Seifert spaces fibred over S^2 , with invariants and geometry as described in table 4. We have grouped together the three members of \mathcal{M}^* equals 7 and the two Seifert spaces with 4 exceptional fibres.

Besides those based on S^2 , a few more Seifert manifolds have complexity 6, as described in Table 5, where T denotes the torus and K the Klein bottle. One should actually note that there is another such manifold, namely $(K, 0)$, which was already listed in Table 4 as $(S^2, (2, 1), (2, 1), (2, 1), (2, 1), -2)$. Note also that a torus bundle T_A has $c_9(T_A) \leq 6$ if and only if $\|A\| \leq 1$, and in this case T_A is one of the (flat or Nil) Seifert manifolds already described.

invariants	geometry	invariants	geometry
$(2, 1), (2, 1), (2, 1), 2$	elliptic	$(2, 1), (2, 1), (3, 1), 1$	elliptic
$(2, 1), (2, 1), (3, 2), 1$	elliptic	$(2, 1), (2, 1), (4, 1)$	elliptic
$(2, 1), (2, 1), (4, 3)$	elliptic	$(2, 1), (2, 1), (5, 2)$	elliptic
$(2, 1), (2, 1), (5, 3)$	elliptic	$(2, 1), (2, 1), (5, 4), -1$	elliptic
$(2, 1), (2, 1), (7, 2), -1$	elliptic	$(2, 1), (2, 1), (7, 3), -1$	elliptic
$(2, 1), (2, 1), (7, 4), -1$	elliptic	$(2, 1), (2, 1), (7, 5), -1$	elliptic
$(2, 1), (2, 1), (8, 3), -1$	elliptic	$(2, 1), (2, 1), (8, 5), -1$	elliptic
$(2, 1), (3, 1), (3, 1)$	elliptic	$(2, 1), (3, 1), (3, 2)$	elliptic
$(2, 1), (3, 1), (4, 3), -1$	elliptic	$(2, 1), (3, 1), (5, 2), -1$	elliptic
$(2, 1), (3, 1), (5, 3), -1$	elliptic	$(2, 1), (3, 2), (3, 2)$	elliptic
$(2, 1), (3, 2), (4, 1), -1$	elliptic	$(2, 1), (3, 2), (4, 3), -1$	elliptic
$(2, 1), (3, 2), (5, 2), -1$	elliptic	$(2, 1), (3, 2), (5, 3), -1$	elliptic
$(3, 1), (3, 1), (3, 1), -1$	flat	$(3, 1), (3, 1), (3, 2), -1$	Nil
$(3, 1), (3, 2), (3, 2), -1$	Nil	$(3, 2), (3, 2), (3, 2), -1$	Nil
$(2, 1), (4, 1), (4, 1), -1$	flat	$(2, 1), (2, 1), (6, 1), -1$	elliptic
$(2, 1), (3, 1), (6, 1), -1$	flat		
$(2, 1), (2, 1), (2, 1), (2, 1), -2$	flat	$(2, 1), (2, 1), (2, 1), (2, 1), -1$	Nil

Table 4: Seifert manifolds of complexity 6 based on S^2

manifold	geometry
$(\mathbb{P}^2, (2, 1), (2, 1), -1)$	flat
$(\mathbb{P}^2, (2, 1)(2, 1))$	Nil
$(K, 1)$	Nil
$(T, 0)$	flat
$(T, 1)$	Nil

Table 5: Seifert manifolds of complexity 6 not based on S^2

manifold	geometry
$(S^2, (2, 1), (2, 1), (2, 1), (2, 1))$	Nil
$(S^2, (2, 1), (2, 1), (2, 1), (3, 1), -2)$	SL_2
$(S^2, (2, 1), (2, 1), (2, 1), (3, 1), -1)$	SL_2
$(S^2, (2, 1), (2, 1), (2, 1)(3, 2), -1)$	SL_2
$(\mathbb{P}^2, (2, 1), (2, 1), 1)$	Nil
$(\mathbb{P}^2, (2, 1), (3, 1), -1)$	SL_2
$(\mathbb{P}^2, (2, 1), (3, 1))$	SL_2
$(\mathbb{P}^2, (2, 1)(3, 2))$	SL_2
$(K, 2)$	Nil
$(T, 2)$	Nil

Table 6: Seifert manifolds of complexity 7 except those over S^2 with 2 or 3 exceptional fibres

Complexity 7 As mentioned above, we do not provide complete data for complexity higher than 6, addressing the reader to [18]. The numbers of manifolds per geometry are already in Table 3, we only describe here the most interesting ones. In complexity 7, besides the lens spaces, there are 84 Seifert manifolds fibred over S^2 with 3 exceptional fibres, with geometry either elliptic, or SL_2 , or Nil. Three of these manifolds belong to \mathcal{M}^* . The other Seifert manifolds are as listed in Table 6. In addition, we have the two Sol manifolds T_A for $A = \begin{pmatrix} 3 & -1 \\ 1 & 0 \end{pmatrix}, \begin{pmatrix} -3 & 1 \\ -1 & 0 \end{pmatrix}$, and

$$(D, (2, 1), (2, 1)) \bigcup_A (D, (2, 1), (2, 1))$$

for $A = \begin{pmatrix} 1 & 2 \\ -1 & -1 \end{pmatrix}, \begin{pmatrix} 1 & -1 \\ -1 & 0 \end{pmatrix}, \begin{pmatrix} 0 & 1 \\ -1 & 0 \end{pmatrix}$. These manifolds are fibred over the 1-orbifold given by the interval with silvered endpoints, with fibre a Klein bottle at the endpoints and a torus at the other points. To conclude, we have the 4 non-geometric manifolds

$$(D, (2, 1), (2, 1)) \bigcup_A (D, (2, 1), (p, q))$$

with $(p, q) \in \{(2, 1), (3, 2)\}$ and $A \in \left\{ \begin{pmatrix} 0 & 1 \\ -1 & -1 \end{pmatrix}, \begin{pmatrix} 0 & 1 \\ 1 & 0 \end{pmatrix} \right\}$.

Complexity 8 After the 136 lens spaces, there are 226 Seifert bundles over S^2 with three exceptional fibres and geometry either elliptic, or SL_2 , or Nil. Of these 226 manifolds, 4 belong to \mathcal{M}^* and one is only discovered to have complexity 8 using the brick B_5 . Next, there are 14 Seifert bundles over S^2 with 4 exceptional fibres and geometry either Nil or $\mathbb{H}^2 \times S^1$, each in one case, or SL_2 , in the other 12 cases. Then we have 14 Seifert bundles over \mathbb{P}^2 with 2 exceptional fibres and exactly the same distribution of geometries. The list of Seifert manifolds in complexity 8 is completed by $(K, 3)$ and $(T, 3)$, both carrying Nil geometry.

Next, we have the Sol manifolds T_A with $A = \begin{pmatrix} 4 & -1 \\ 1 & 0 \end{pmatrix}, \begin{pmatrix} -4 & 1 \\ -1 & 0 \end{pmatrix}$ and

$$(D, (2, 1), (2, 1)) \bigcup_A (D, (2, 1), (2, 1))$$

for $A = \begin{pmatrix} 1 & 3 \\ 0 & -1 \end{pmatrix}, \begin{pmatrix} 2 & 3 \\ -1 & -1 \end{pmatrix}, \begin{pmatrix} 2 & -1 \\ -1 & 0 \end{pmatrix}, \begin{pmatrix} 1 & 2 \\ 1 & 1 \end{pmatrix}, \begin{pmatrix} 1 & 2 \\ 0 & 1 \end{pmatrix}, \begin{pmatrix} 1 & -1 \\ 1 & 0 \end{pmatrix}, \begin{pmatrix} 1 & -1 \\ 0 & -1 \end{pmatrix}$.

The list of manifolds of complexity 8 is completed by 35 non-geometric ones, all of the form

$$(D, (2, 1), (p, q)) \bigcup_A (D, (r, s), (t, u)).$$

Complexity 9 We have here, besides the 272 lens spaces, Seifert bundles of many sorts. First, we have 586 over S^2 with 3 fibres, and geometry SL_2 , elliptic and (sporadically) Nil. Four of these 586 belong to \mathcal{M}^* and 3 require B_6 in the assembling realizing the complexity. Next, we have 41 Seifert bundles over S^2 with 4 fibres, always with SL_2 geometry except for one Nil case, and two SL_2 bundles over S^2 with 5 fibres. Turning to Seifert bundles over \mathbb{P}^2 , we have 34 with 2 fibres (all SL_2 except one Nil), and 2 with 3 fibres and geometry SL_2 . The list of Seifert bundles of complexity 9 is completed by the Nil manifolds $(K, 4)$ and $(T, 4)$ and the SL_2 manifolds

$$(K, (2, 1), 0), (K, (2, 1), 1), (T, (2, 1), 0), (T, (2, 1), 1).$$

There are then 6 Sol manifolds fibred over the circle and 17 fibred over the interval. The 4 hyperbolic manifolds have been described in Section 1.

We have then non-geometric manifolds, 168 of them with JSJ decomposition given by two blocks of the form $(D, (p, q), (r, s))$, where (p, q) is always $(2, 1)$ for one of the blocks. Next we have

$$(D, (2, 1), (2, 1), (2, 1)) \bigcup_A (D, (2, 1), (2, 1))$$

with $A = \begin{pmatrix} 1 & 1 \\ -1 & 0 \end{pmatrix}, \begin{pmatrix} 0 & 1 \\ 1 & 0 \end{pmatrix}, \begin{pmatrix} 1 & 1 \\ 1 & 0 \end{pmatrix}$. Denoting by S the Möbius strip and by D_1 the annulus we also have

$$(S, (2, 1)) \bigcup_A (D, (2, 1), (2, 1))$$

with $A = \begin{pmatrix} 2 & 1 \\ -1 & 0 \end{pmatrix}, \begin{pmatrix} 1 & 1 \\ 1 & 0 \end{pmatrix}, \begin{pmatrix} 1 & 1 \\ -1 & 0 \end{pmatrix}$,

$$(D, (2, 1), (2, 1)) \bigcup_A (D_1, (2, 1)) \bigcup_B (D, (2, 1), (2, 1))$$

with $(A, B) = \left(\begin{pmatrix} 0 & 1 \\ -1 & -1 \end{pmatrix}, \begin{pmatrix} 1 & 1 \\ -1 & 0 \end{pmatrix} \right), \left(\begin{pmatrix} 0 & 1 \\ 1 & 0 \end{pmatrix}, \begin{pmatrix} 0 & 1 \\ 1 & 0 \end{pmatrix} \right), \left(\begin{pmatrix} 0 & 1 \\ 1 & 0 \end{pmatrix}, \begin{pmatrix} 1 & 1 \\ -1 & 0 \end{pmatrix} \right)$, and

$$(D_1, (2, 1))_A$$

with $A = \begin{pmatrix} 0 & 1 \\ 1 & 0 \end{pmatrix}, \begin{pmatrix} 0 & -1 \\ -1 & 0 \end{pmatrix}, \begin{pmatrix} 1 & 1 \\ 0 & -1 \end{pmatrix}, \begin{pmatrix} -1 & -1 \\ 0 & 1 \end{pmatrix}, \begin{pmatrix} -1 & -1 \\ 1 & 2 \end{pmatrix}, \begin{pmatrix} 1 & 1 \\ -1 & -2 \end{pmatrix}, \begin{pmatrix} 1 & 2 \\ 0 & -1 \end{pmatrix}, \begin{pmatrix} -1 & -1 \\ 0 & 1 \end{pmatrix}$.

References

- [1] I. AGOL, *Volume and topology of hyperbolic 3-manifolds*, PhD thesis, University of California at San Diego, 1998.
- [2] S. ANISOV, *Towards lower bounds for complexity of 3-manifolds: a program*, math.GT/0103169.
- [3] J. S. BIRMAN – C. SERIES, *Algebraic linearity for an automorphism of a surface group*, J. Pure Appl. Algebra **52** (1988), 227-275.
- [4] S. A. BLEILER – C. D. HODGSON – J. R. WEEKS, *Cosmetic surgery on knots*, in “Proceedings of the Kirbyfest” (Berkeley, CA, 1998), pp. 23-34 (electronic), Geometry and Topology Monographs, Vol. 2, Coventry, 1999.
- [5] P. J. CALLAHAN – M. V. HILDEBRAND – J. R. WEEKS, *A census of cusped hyperbolic 3-manifolds*, Mathematics of Computation **68** (1999), 321-332.
- [6] A. FOMENKO – S. V. MATVEEV, “Algorithmic and computer methods for three-manifolds,” Mathematics and its Applications, Vol. 425, Kluwer Academic Publishers, Dordrecht, 1997.
- [7] C. D. HODGSON – J. R. WEEKS, *Symmetries, isometries and length spectra of closed hyperbolic three-manifolds*, Experiment. Math. **3** (1994), 261-274.
- [8] B. MARTELLI – C. PETRONIO, *Three-manifolds having complexity at most 9*, Experiment. Math. **10** (2001), 207-237.
- [9] B. MARTELLI – C. PETRONIO, *A new decomposition theorem for 3-manifolds*, Illinois J. Math. **46** (2002), 755-780.
- [10] B. MARTELLI – C. PETRONIO, *Dehn filling of the “magic” 3-manifold*, math.GT/0204228, revised version (March 2003).

- [11] S. V. MATVEEV, *Complexity theory of three-dimensional manifolds*, Acta Appl. Math. **19** (1990), 101-130.
- [12] S. V. MATVEEV, “Algorithmic topology and classification of 3-manifolds,” to appear.
- [13] D. ROLFSEN, “Knots and links,” Mathematics Lecture Series, Vol. 7, Publish or Perish, Berkeley, CA, 1976.
- [14] P. SCOTT, *The geometries of 3-manifolds*, Bull. London Math. Soc. **15** (1983), 401-487.
- [15] C. SERIES, *Symbolic dynamics and Diophantine equations*, in “Number theory and dynamical systems” (York, 1987), pp. 49-67, London Math. Soc. Lecture Note Series, Vol. 134, Cambridge Univ. Press, Cambridge, 1989.
- [16] W. P. THURSTON, “The geometry and topology of three-manifolds”, Princeton University Mathematics Department, 1979.
- [17] J. R. WEEKS, *SnapPea: a computer program for creating and studying hyperbolic 3-manifolds*, available from www.northnet.org/weeks.
- [18] www.dm.unipi.it/pages/petronio/public_html/

Dipartimento di Matematica Applicata
Via Bonanno Pisano, 25B
56126 Pisa, Italy
martelli@mail.dm.unipi.it
petronio@dm.unipi.it