

Indecomposables of the derived categories of certain associative algebras

Igor Burban * Yuriy Drozd †

Abstract

In this article we describe indecomposable objects of the derived categories of a branch class of associative algebras. To this class belong such known classes of algebras as gentle algebras, skew-gentle algebras and certain degenerations of tubular algebras.

1 Introduction

In this article we elaborate a method of description of indecomposable objects of derived categories of representations of associative algebras proposed in [6]. We consider the derived categories of gentle and skew-gentle algebras treated also in [16], [18], [10], by using the Happel's functor from the derived category of finite-dimensional modules over a finite-dimensional \mathbf{k} -algebra A of finite homological dimension to the stable category over the repetitive algebra \hat{A} . This class of algebras was also treated in [4] and [5] by using other methods. An advantage of our approach is that it also works for algebras of infinite homological dimension and gives a description of the derived category $D^-(A - \text{mod})$ of *bounded from the right* complexes.

It is well-known that canonical tubular algebras of type $(2, 2, 2, 2, \lambda)$

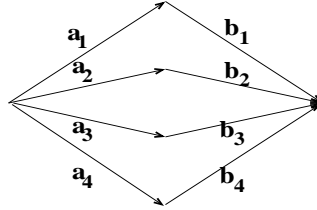

*Kaiserslautern University, Kyiv University and Institute of Mathematics

†Kyiv Taras Shevchenko University and Kaiserslautern University

The both authors were partially supported CRDG Grant UM2-2094. The first author was also partially supported by DFG Schwerpunkt "Globale Methoden in der komplexen Geometrie".

where relations are

$$\begin{aligned} b_1 a_1 + b_2 a_2 + b_3 a_3 &= 0, \\ b_2 a_2 + b_3 a_3 + \lambda b_4 a_4 &= 0 \end{aligned}$$

and $\lambda \neq 0, 1$ are derived-tame of polynomial growth. They arises naturally in connection with weighted projective lines of tubular type [15]. A natural question is: what happens if a family of tubular algebras specializes to a forbidden value of parameter $\lambda = 0$? It turns out that the derived category of the degenerated tubular algebra is still tame but now it has exponential growth.

2 Category of triples

Let \mathcal{A} and \mathcal{B} be two abelian categories, $\mathbf{F} : \mathcal{A} \rightarrow \mathcal{B}$ a right exact functor. It induces a functor between corresponding derived categories $\mathbf{D}^- \mathbf{F} : D^-(\mathcal{A}) \rightarrow D^-(\mathcal{B})$. The description of the fibers of this functor is often equivalent to certain matrix problem.

In the following we are going to work in the following situation. Let A be a semi-perfect associative \mathbf{k} -algebra (not necessarily finite dimensional), $A \subset \tilde{A}$ be an embedding such that $r = \text{rad}(A) = \text{rad}(\tilde{A})$. Let $I \subset A$ be a two-sided \tilde{A} -ideal containing r . It means that $r \subseteq I = I\tilde{A} = \tilde{A}I$, thus A/I and \tilde{A}/I are semi-simple algebras.

Example 2.1 Consider the following embedding of algebras:

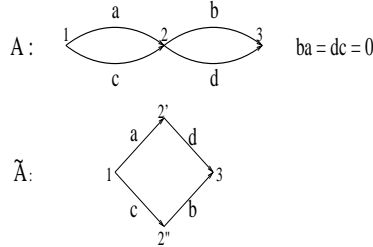

Then the two-sided ideal I in A and \tilde{A} , which is generated by e_1 and e_3 satisfies the properties above.

Definition 2.2 Consider the following category of triples of complexes TC_A

1. Objects are triples $(\tilde{\mathcal{P}}_\bullet, \mathcal{M}_\bullet, i)$, where
 - $\tilde{\mathcal{P}}_\bullet \in D^-(\tilde{A} - \text{mod})$,
 - $\mathcal{M}_\bullet \in D^-(A/I - \text{mod})$,
 - $i : \mathcal{M}_\bullet \rightarrow \tilde{A}/I \otimes_{\tilde{A}} \tilde{\mathcal{P}}_\bullet$ a morphism in $D^-(A/I - \text{mod})$, such that
 - $\tilde{i} : \tilde{A}/I \otimes_{A/I} \mathcal{M}_\bullet \rightarrow \tilde{A}/I \otimes_{\tilde{A}} \tilde{\mathcal{P}}_\bullet$ is an isomorphism in $D^-(\tilde{A}/I - \text{mod})$.

2. Morphisms $(\tilde{\mathcal{P}}_{\bullet 1}, \mathcal{M}_{\bullet 1}, i_1) \longrightarrow (\tilde{\mathcal{P}}_{\bullet 2}, \mathcal{M}_{\bullet 2}, i_2)$ are pairs (Φ, φ) ,

$$\tilde{\mathcal{P}}_{\bullet 1} \xrightarrow{\Phi} \tilde{\mathcal{P}}_{\bullet 2}, \quad \mathcal{M}_{\bullet 1} \xrightarrow{\varphi} \mathcal{M}_{\bullet 2},$$

such that

$$\begin{array}{ccc} \tilde{A}/I \otimes_{\tilde{A}} \tilde{\mathcal{P}}_{\bullet 1} & \xleftarrow{i_1} & \mathcal{M}_{\bullet 1} \\ \downarrow \Phi \otimes \text{id} & & \downarrow \varphi \\ \tilde{A}/I \otimes_{\tilde{A}} \tilde{\mathcal{P}}_{\bullet 2} & \xleftarrow{i_2} & \mathcal{M}_{\bullet 2} \end{array}$$

is commutative.

Remark 2.3 If an algebra A has infinite homological dimension, then we are forced to deal with the derived category of right bounded complexes (in order to define the left derived functor of the tensor product). In case A has finite homological dimension we can suppose that all complexes above are bounded from both sides.

Theorem 2.4 ([6]) *The functor*

$$D^-(A - \text{mod}) \xrightarrow{\mathbf{F}} \text{TC}_A$$

$\mathcal{P}_{\bullet} \longrightarrow (\tilde{A} \otimes_A \mathcal{P}_{\bullet}, A/I \otimes_A \mathcal{P}_{\bullet}, i : A/I \otimes_A \mathcal{P}_{\bullet} \longrightarrow \tilde{A}/I \otimes_A \mathcal{P}_{\bullet})$ has the following properties:

1. \mathbf{F} is dense (i.e., every triple $(\tilde{\mathcal{P}}_{\bullet}, \mathcal{M}_{\bullet}, i)$ is isomorphic to some $\mathbf{F}(\mathcal{P}_{\bullet})$).
2. $\mathbf{F}(\mathcal{P}_{\bullet}) \cong \mathbf{F}(\mathcal{Q}_{\bullet}) \iff \mathcal{P}_{\bullet} \cong \mathcal{Q}_{\bullet}$.
3. $\mathbf{F}(\mathcal{P}_{\bullet})$ is indecomposable if and only if so is \mathcal{P}_{\bullet} (note that this property is an easy formal consequence of the previous two properties).
4. \mathbf{F} is full.

The main point to be clarified is: having a triple $\mathcal{T} = (\tilde{\mathcal{P}}_{\bullet}, \mathcal{M}_{\bullet}, i)$ how can we reconstruct \mathcal{P}_{\bullet} ? The exact sequence

$$0 \longrightarrow I\tilde{\mathcal{P}}_{\bullet} \longrightarrow \tilde{\mathcal{P}}_{\bullet} \longrightarrow \tilde{A}/I \otimes_{\tilde{A}} \tilde{\mathcal{P}}_{\bullet} \longrightarrow 0$$

of complexes in $A - \text{mod}$ gives a distinguished triangle

$$I\tilde{\mathcal{P}}_{\bullet} \longrightarrow \tilde{\mathcal{P}}_{\bullet} \longrightarrow \tilde{A}/I \otimes_{\tilde{A}} \tilde{\mathcal{P}}_{\bullet} \longrightarrow I\tilde{\mathcal{P}}_{\bullet}[-1]$$

in $D^-(A - \text{mod})$. The properties of triangulated categories imply that there is a morphism of triangles

$$\begin{array}{ccccccc} I\tilde{\mathcal{P}}_{\bullet} & \longrightarrow & \tilde{\mathcal{P}}_{\bullet} & \longrightarrow & \tilde{A}/I \otimes_{\tilde{A}} \tilde{\mathcal{P}}_{\bullet} & \longrightarrow & I\tilde{\mathcal{P}}_{\bullet}[-1] \\ \uparrow \text{id} & & \uparrow \Phi & & \uparrow i & & \uparrow \text{id} \\ I\tilde{\mathcal{P}}_{\bullet} & \longrightarrow & \mathcal{P}_{\bullet} & \longrightarrow & \mathcal{M}_{\bullet} & \longrightarrow & I\tilde{\mathcal{P}}_{\bullet}[-1], \end{array}$$

where $\mathcal{P}_\bullet = \text{cone}(\mathcal{M}_\bullet \rightarrow I\tilde{\mathcal{P}}_\bullet[-1])[1]$. Set $\mathbf{G}(\mathcal{T}) = \mathcal{P}_\bullet$. Taking a cone is not a functorial operation. It gives an intuitive explanation why the functor \mathbf{F} is not an equivalence. The properties of triangulated categories immediately imply that the constructed map (not a functor!)

$$\mathbf{G} : \text{Ob}(\text{TC}_A) \longrightarrow \text{Ob}(D^-(A - \text{mod}))$$

sends isomorphic objects into isomorphic ones and $\mathbf{GF}(\mathcal{P}_\bullet) \cong \mathcal{P}_\bullet$. For more details see [6].

3 Derived categories of gentle algebras

It was observed that the representation theory of gentle (or, more general, string) algebras is closely related to the representation of quivers of type \tilde{A}_n . We shall sketch a proof of the result of Z. Pogorzaly, A. Skowronski [16] that any gentle algebra is derived-tame and propose a new way of reduction to a matrix problem.

Let A be the path algebra of the quiver

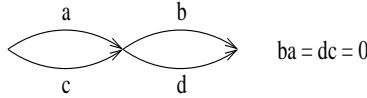

Then we can embed it into the path algebra \tilde{A} of the quiver

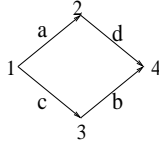

In this case set $I = (a, b, c, d, e_1, e_4)$. So $A/I = \mathbf{k}$ and $\tilde{A}/I = \mathbf{k} \times \mathbf{k}$, $A/I \rightarrow \tilde{A}/I$ is a diagonal embedding.

As we have seen in the previous section, a complex \mathcal{P}_\bullet of the derived category $D^-(A - \text{mod})$ is defined by some triple $(\tilde{\mathcal{P}}_\bullet, \mathcal{M}_\bullet, i)$. Since $A/I - \text{mod}$ can be identified with the category of \mathbf{k} -vector spaces, the map $i : \mathcal{M}_\bullet \rightarrow \tilde{\mathcal{P}}_\bullet/I\tilde{\mathcal{P}}_\bullet$ is given by a collection of linear maps $H_k(i) : H_k(\mathcal{M}_\bullet) \rightarrow H_k(\tilde{\mathcal{P}}_\bullet/I\tilde{\mathcal{P}}_\bullet)$. The map $H_k(i)$ is a \mathbf{k} -linear map of a \mathbf{k} -module into a $\mathbf{k} \times \mathbf{k}$ -module. Hence it is given by two matrices $H_k(i)(1)$ and $H_k(i)(2)$. From the non degenerated condition of the category of triples it follows that both of these matrices are square and non degenerated.

The algebra \tilde{A} has a homological dimension 1. By the theorem of Dold (see [9]), an indecomposable complex from $D^-(\tilde{A} - \text{mod})$ has a form

$$\dots \rightarrow 0 \rightarrow \underbrace{M}_i \rightarrow 0 \rightarrow \dots,$$

where M is an indecomposable \tilde{A} -module.

The next question is: which transformations can we perform with the matrices $H_k(i)(1)$ and $H_k(i)(2)$?

We can do, simultaneously, any elementary transformation of columns of matrices $H_k(i)(1)$ and $H_k(i)(2)$. From the definition of the category of triples it follows that row transformations are induced by the morphisms in $D^-(\tilde{A}\text{-mod})$.

If \tilde{P}_i denotes the indecomposable projective \tilde{A} -module corresponding to the vertex i , then

$$\begin{aligned} \tilde{A}/I \otimes_{\tilde{A}} \tilde{P}_1 &= \tilde{A}/I \otimes_{\tilde{A}} \tilde{P}_4 = 0, \\ \tilde{A}/I \otimes_{\tilde{A}} \tilde{P}_2 &= \mathbf{k}(2), \quad \tilde{A}/I \otimes_{\tilde{A}} \tilde{P}_3 = \mathbf{k}(3). \end{aligned}$$

Consider the continuous series of representations of the quiver $\tilde{A} = \tilde{A}_4$:

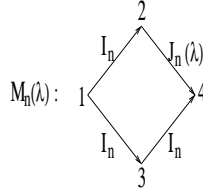

$M_n(\lambda)$ has a projective resolution:

$$0 \longrightarrow \tilde{P}_4^n \longrightarrow \tilde{P}_1^n \longrightarrow M_n(\lambda) \longrightarrow 0.$$

Hence, in the derived category $D^-(\tilde{A}/I)$ holds: $\tilde{A}/I \otimes_{\tilde{A}} M_n(\lambda) = 0$. So, $\tilde{A}/I \otimes_{\tilde{A}}$ kills the continuous series of representations of \tilde{A} . We only have to consider the discrete series of representations.

Recall some basic facts of the theory of representations of tame hereditary algebras (see [17] for more details). The Auslander-Reiten quiver has the following structure:

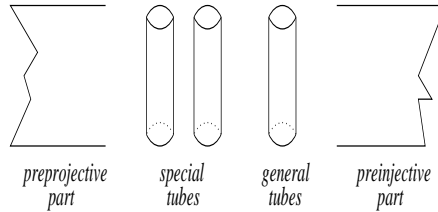

In this concrete case

1. The preprojective series is:

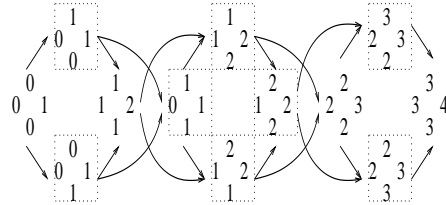

(We mark with dotted boxes the objects that remain nonzero after tensoring by \tilde{A}/I .)

2. The preinjective series is

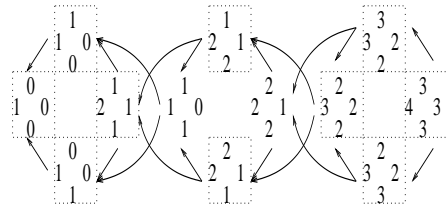

3. Two special tubes are

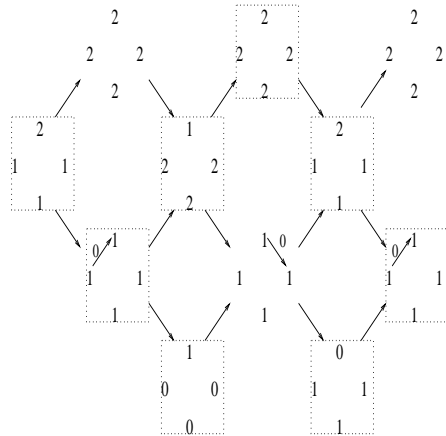

and the symmetric one.

We see that as preprojective series, as well as preinjective series and two special tubes are 2-periodic. Let M be a preprojective module with the dimension vector (d_1, d_2, d_3, d_4) . Then $\tau^{-1} \circ \tau^{-1}(M)$ has the dimension vector $(d_1 + 2, d_2 + 2, d_3 + 2, d_4 + 2)$. The same holds for a preinjective module N and $\tau \circ \tau(N)$. The same holds also for special tubes, if one goes two floors upstairs.

Consider the module M from the preprojective series

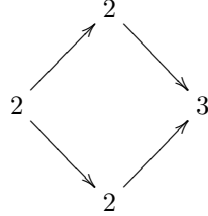

It has a projective resolution

$$0 \longrightarrow P_4 \longrightarrow P_1^2 \longrightarrow M \longrightarrow 0.$$

From it follows that $\tilde{A}/I \otimes_{\tilde{A}} M = 0$. With other words, the module M plays no role in our matrix problem.

The list of modules, which are relevant for our problem is the following:

1. Preprojective modules:

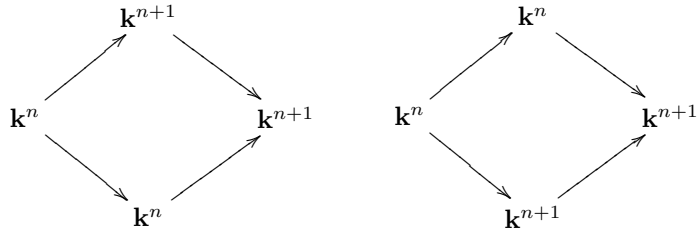

and

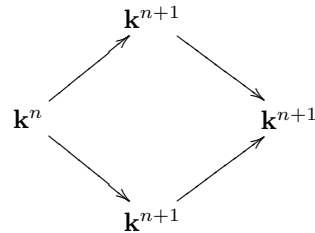

2. Preinjective modules

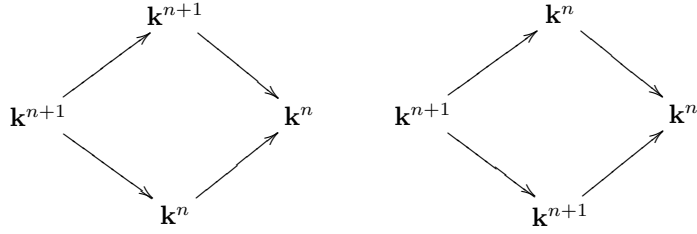

and

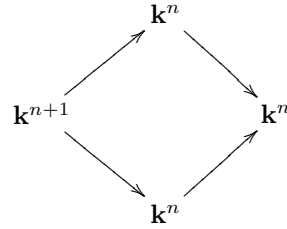

3. Modules from special tubes:

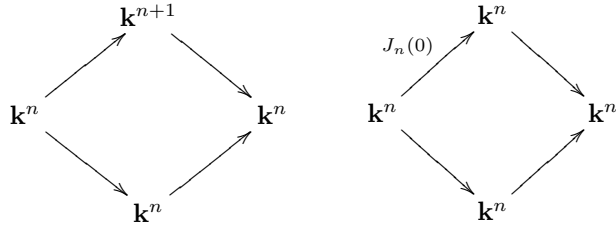

and

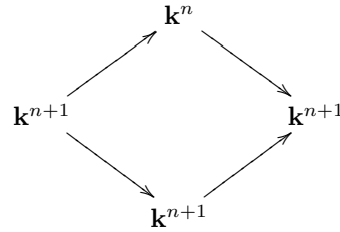

and symmetric ones.

We have to compute the images of these objects after applying the left derived functor $\tilde{A}/I \otimes_{\tilde{A}}$. In order to do it we have to consider the minimal projective resolutions of all these modules and then apply the functor $\tilde{A}/I \otimes_{\tilde{A}}$.

1. Preprojective series. From the module

$$0 \longrightarrow P_4^n \longrightarrow P_1^n \oplus P_2 \longrightarrow 0$$

we get

$$0 \longrightarrow 0 \longrightarrow \mathbf{k}(2) \longrightarrow 0;$$

from the module

$$0 \longrightarrow P_4^n \longrightarrow P_1^n \oplus P_3 \longrightarrow 0$$

will be

$$0 \longrightarrow 0 \longrightarrow \mathbf{k}(3) \longrightarrow 0;$$

from the module

$$0 \longrightarrow P_4^{n+1} \longrightarrow P_1^n \oplus P_2 \oplus P_3 \longrightarrow 0$$

we get

$$0 \longrightarrow 0 \longrightarrow \mathbf{k}(2) \oplus \mathbf{k}(3) \longrightarrow 0.$$

2. Preinjective series. From the module

$$0 \longrightarrow P_2 \oplus P_3 \oplus P_4^n \longrightarrow P_1^{n+1} \longrightarrow 0$$

we get

$$0 \longrightarrow \mathbf{k}(2) \oplus \mathbf{k}(3) \longrightarrow 0 \longrightarrow 0;$$

from the module

$$0 \longrightarrow P_2 \oplus P_4^n \longrightarrow P_1^{n+1} \longrightarrow 0$$

will be

$$0 \longrightarrow \mathbf{k}(2) \longrightarrow 0 \longrightarrow 0;$$

from the module

$$0 \longrightarrow P_3 \oplus P_4^n \longrightarrow P_1^{n+1} \longrightarrow 0$$

will be

$$0 \longrightarrow \mathbf{k}(3) \longrightarrow 0 \longrightarrow 0;$$

3. Let us finally consider modules from special tubes. From the module

$$0 \longrightarrow P_4^{n+1} \longrightarrow P_1^n \oplus P_2 \longrightarrow 0$$

we get

$$0 \longrightarrow 0 \longrightarrow \mathbf{k}(2) \longrightarrow 0;$$

from the module

$$0 \longrightarrow P_4^n \oplus P_2 \longrightarrow P_1^n \oplus P_2 \longrightarrow 0$$

will be

$$0 \longrightarrow \mathbf{k}(2) \xrightarrow{0} \mathbf{k}(2) \longrightarrow 0;$$

from the module

$$0 \longrightarrow P_4^n \oplus P_2 \longrightarrow P_1^{n+1} \longrightarrow 0$$

we get

$$0 \longrightarrow \mathbf{k}(2) \longrightarrow 0 \longrightarrow 0.$$

The case of the second special tube is completely symmetric.

What are induced morphisms between all these modules after applying the functor $\tilde{A}/I \otimes_{\tilde{A}}$? The image of the preprojective series is:

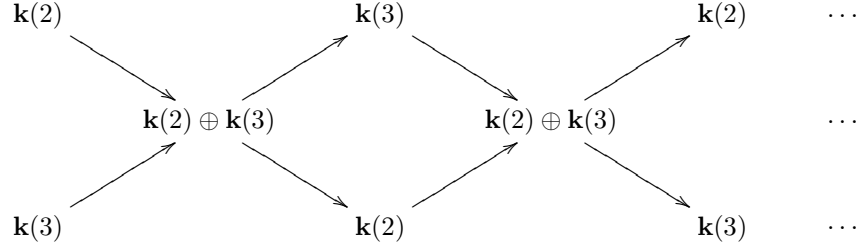

We want to prove that all induced morphisms in this diagram are non-zero. It is well-known (see, for instance [17]) that all morphisms between preprojective modules are determined by the Auslander-Reiten quiver. So, every morphism is a linear combination of finite paths of irreducible morphisms. Consider the morphism

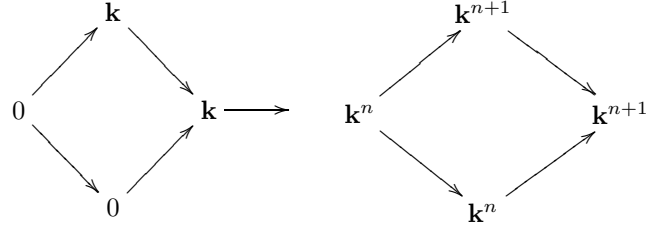

It is clear that this map remains non-zero after applying $\tilde{A}/I \otimes_{\tilde{A}}$. But from this fact follows that all morphisms we are interested in are non-zero after applying $\tilde{A}/I \otimes_{\tilde{A}}$. The same argument can be applied to preinjective modules.

Consider finally the case of special tubes. The module

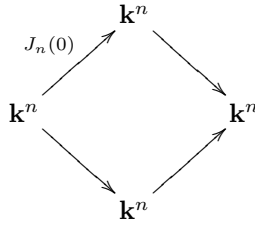

has a resolution

$$0 \longrightarrow P_4^n \oplus P_2 \longrightarrow P_1^n \oplus P_2 \longrightarrow 0.$$

It is indecomposable and its endomorphism algebra is local. Any endomorphism of this module is therefore either invertible or nilpotent. An isomorphism induces a map of the form:

$$\begin{array}{ccc} \mathbf{k}(2) & \xrightarrow{0} & \mathbf{k}(2) \\ \downarrow \lambda & & \downarrow \lambda \\ \mathbf{k}(2) & \xrightarrow{0} & \mathbf{k}(2) \end{array}$$

Let f be a nilpotent endomorphism. Consider an induced map of its projective resolution f_\bullet :

$$\begin{array}{ccccccc}
 0 & \longrightarrow & P_4^n \oplus P_2 & \longrightarrow & P_1^n \oplus P_2 & \longrightarrow & 0 \\
 & & \downarrow f_1 & & \downarrow f_0 & & \\
 0 & \longrightarrow & P_4^n \oplus P_2 & \longrightarrow & P_1^n \oplus P_2 & \longrightarrow & 0.
 \end{array}$$

The map f_\bullet^n is homotopic to the zero map. Consider the component $f_1^n|_{P_2} : P_2 \rightarrow P_2$ of the map f_1^n . It is zero modulo the radical and hence is equal to zero itself. But then $f_1|_{P_2} : P_2 \rightarrow P_2$ is also zero. The same holds of course for $f_0|_{P_2} : P_2 \rightarrow P_2$. We have shown that nilpotent morphisms induce the zero map modulo $\tilde{A}/I \otimes_{\tilde{A}}$.

Finally observe that the chain of morphisms

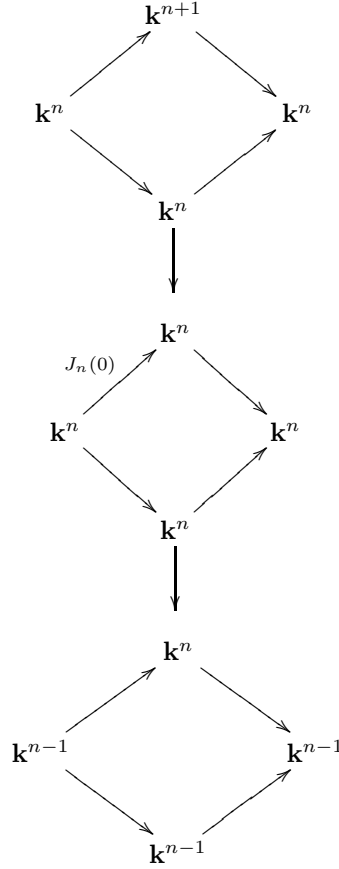

induces modulo $\tilde{A}/I \otimes_{\tilde{A}}$ the following maps:

$$\begin{array}{ccc}
0 & \longrightarrow & \mathbf{k}(2) \\
\downarrow & & \downarrow 1 \\
\mathbf{k}(2) & \xrightarrow{0} & \mathbf{k}(2) \\
\downarrow & & \downarrow 1 \\
0 & \longrightarrow & \mathbf{k}(2).
\end{array}$$

In the same way the chain of morphisms

$$\begin{array}{ccc}
& \mathbf{k}^{n-1} & \\
\swarrow & & \searrow \\
\mathbf{k}^n & & \mathbf{k}^n \\
\searrow & & \swarrow \\
& \mathbf{k}^n & \\
\downarrow & & \\
& \mathbf{k}^n & \\
\swarrow & & \searrow \\
\mathbf{k}^n & & \mathbf{k}^n \\
\searrow & & \swarrow \\
& \mathbf{k}^n & \\
\downarrow & & \\
& \mathbf{k}^n & \\
\swarrow & & \searrow \\
\mathbf{k}^{n+1} & & \mathbf{k}^{n+1} \\
\searrow & & \swarrow \\
& \mathbf{k}^{n+1} &
\end{array}$$

induce the maps

$$\begin{array}{ccc}
\mathbf{k}(2) & \longrightarrow & 0 \\
\downarrow 1 & & \downarrow \\
\mathbf{k}(2) & \xrightarrow{0} & \mathbf{k}(2) \\
\downarrow 1 & & \downarrow \\
\mathbf{k}(2) & \longrightarrow & 0
\end{array}$$

We have the same picture for the second symmetric tube. Now we observe that the matrix problem describing the derived category $D^-(A - \text{mod})$ is given by the following bunch of chains (see [1], [7]), where small circles correspond to the horizontal stripes, small rectangles below to the vertical stripes, dotted lines show the related stripes and arrows describe the ordering in the chains or, the same, possible transformations between different horizontal stripes:

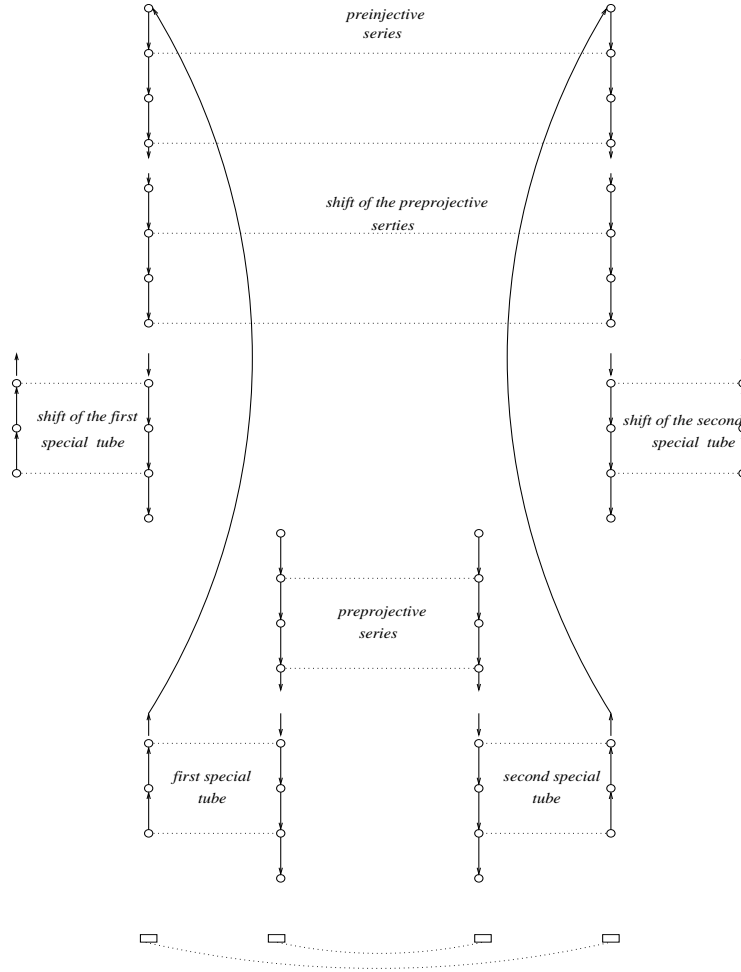

1. We can do any simultaneous elementary transformations of columns of the matrices $H_k(i)(0)$ and $H_k(i)(\infty)$.
2. We can do any simultaneous transformations of rows inside related blocks.
3. We can add a scalar multiple of any row from a block with lower weight to any row of a block of a higher weight (inside the big matrix, of course).

These transformations can be done independently inside $H_k(i)(0)$ and $H_k(i)(\infty)$.

This type of matrix problems is well-known in the representation theory. First they appeared in the work of Nazarova-Roiter ([19]) about the classification of $\mathbf{k}[[x, y]]/(xy)$ -modules. They are called, sometimes, Gelfand problems in honor of I. M. Gelfand, since they originated in a problem that first appeared in Gelfand’s investigation of Harish-Chandra modules over $SL_2(\mathbb{R})$ [12] (see also [1], [7] and [6]).

4 Derived categories of skew-gentle algebras

In the same way as the representation theory of gentle algebras is based on the representation theory of hereditary algebras \tilde{A}_n , that of skew-gentle algebras is built on representations of \tilde{D}_n .

Consider the following example:

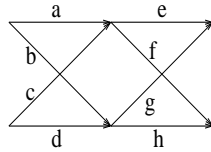

where all squares are commutative. Observe that we can embed this algebra into

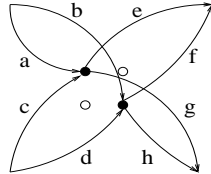

where $M_2(\mathbf{k})$ stands in the middle. The last algebra is Morita-equivalent to the

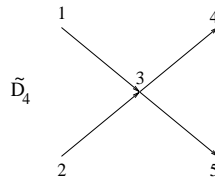

In this case the embedding $A/I \rightarrow \tilde{A}/I$ is $\mathbf{k} \times \mathbf{k} \rightarrow M_2(\mathbf{k})$. It means that the matrix problem we obtain is the so called “representation of the bunch of semi-chains” (see [1], [7] and [6] for more details). We have $\tilde{A} \otimes_{\tilde{A}/I} P_i = 0$, $i = 1, 2, 4, 5$.

The continuous series of representations of \tilde{D}_4 has a projective resolution

$$0 \longrightarrow P_4^n \oplus P_5^n \longrightarrow P_1^n \oplus P_2^n \longrightarrow M_n(\lambda) \longrightarrow 0,$$

hence $\tilde{A}/I \otimes_{\tilde{A}} M_n(\lambda) = 0$. We again have to take care only of discrete series of \tilde{D}_4 . It consists of preprojective series, preinjective series, and three special tubes.

1. The preprojective series is:

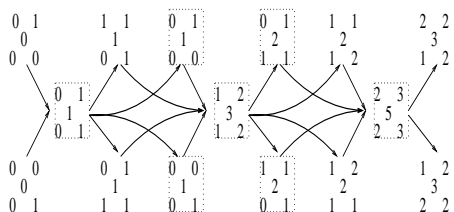

2. The preinjective series is:

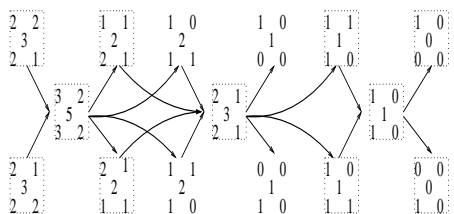

3. The only special tube that gives an input into the matrix problem is:

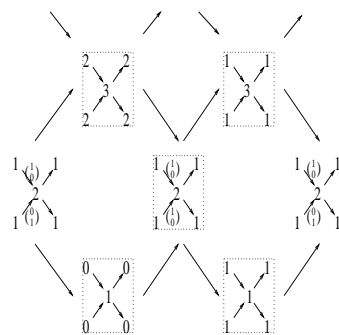

The representations from two other special tubes vanish under tensoring by \tilde{A}/I .

In the same way as for gentle algebras, we see that our matrix problem is given by the following partially ordered set:

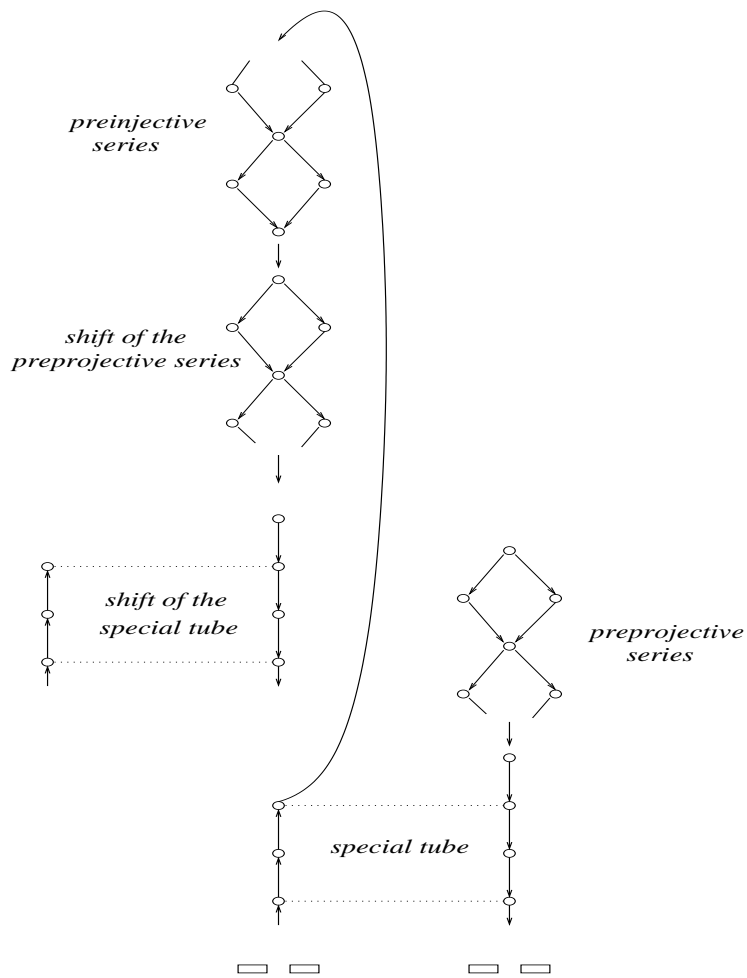

The generalization of this approach to other skew-gentle algebras of finite homological dimension gives a new proof of the result of Ch. Geiß and J. A. de la Pena [10] that the bounded derived categories of these algebras are tame.

5 Skew-gentle algebras of infinite homological dimension

Consider now our next example:

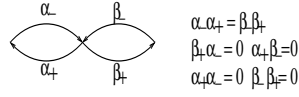

This algebra is skew-gentle of infinite homological dimension. We can embed it in

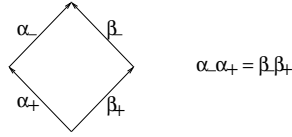

It is well known (see, for example, [14]) that this algebra is derived-equivalent to the algebra \tilde{D}_4 . In such a way we can obtain our matrix problem. But we can embed it further into

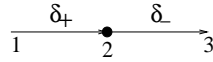

where the fat point in the middle means $M_2(\mathbf{k})$. This algebra is Morita-equivalent to the algebra A_2 . Note that there are only the following indecomposable complexes in $D^-(A_2 - \text{mod})$ (up to shifts):

$$\begin{array}{l}
 \dots 0 \longrightarrow P_1 \longrightarrow 0 \longrightarrow \dots, \\
 \dots 0 \longrightarrow P_2 \longrightarrow 0 \longrightarrow \dots, \\
 \dots 0 \longrightarrow P_3 \longrightarrow 0 \longrightarrow \dots; \\
 \dots 0 \longrightarrow P_3 \longrightarrow P_1 \longrightarrow 0 \longrightarrow \dots, \\
 \dots 0 \longrightarrow P_3 \longrightarrow P_2 \longrightarrow 0 \longrightarrow \dots, \\
 \dots 0 \longrightarrow P_2 \longrightarrow P_1 \longrightarrow 0 \longrightarrow \dots
 \end{array}$$

It is easy to establish a matrix problem now:

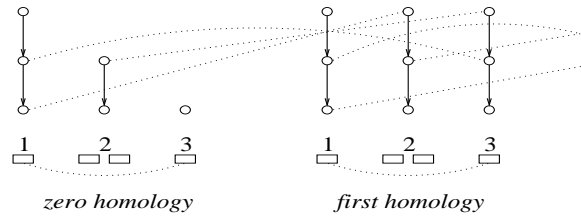

Derived categories of skew-gentle algebras of infinite homological dimension were independently considered in [5].

6 Derived category of degenerated tubular algebra $(2, 2, 2, 2; 0)$

In all previous examples we embedded our path algebra A into a hereditary algebra \tilde{A} . As we shall see in the following example, it is also possible to consider an embedding into a concealed algebra.

If we consider a canonical algebra of tubular type $(2, 2, 2, 2; \lambda)$ and set the forbidden value of parameter $\lambda = 0$, then we get the following quiver

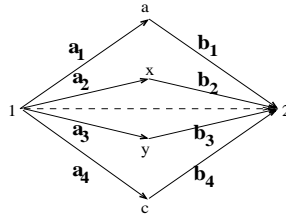

with relations

$$b_2a_2 = b_3a_3$$

and

$$b_1a_1 + b_2a_2 + b_4a_4 = 0.$$

We can do our trick with gluing of idempotents x and y and embed this algebra into

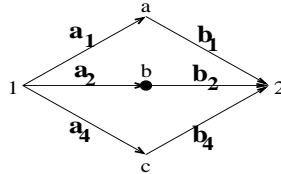

where the fat point as usually means $M_2(\mathbf{k})$. The corresponding basic algebra is a tame-concealed algebra of type $(2, 2, 2)$. It is well-known [17] that it is derived-equivalent to the algebra \tilde{D}_4 . Take the ideal I equal to the ideal generated by all idempotents e_1, e_2, e_a, e_c . Then we have: $A/I = \mathbf{k} \times \mathbf{k}$, $\tilde{A}/I = \text{Mat}_2(\mathbf{k})$ and the map $A/I \rightarrow \tilde{A}/I$ is the diagonal embedding.

It is no longer true that any complex of $D^b(\tilde{A} - \text{mod})$ is isomorphic to its homology. The structure of the Auslander-Reiten quiver is the same as for derived categories of tame hereditary algebras.

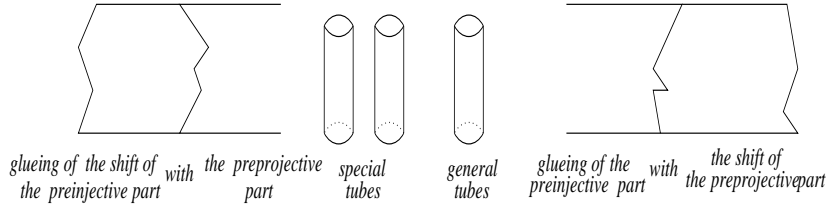

In particular, continuous series of complexes are just shifts of modules of tubular type. But they have the following form:

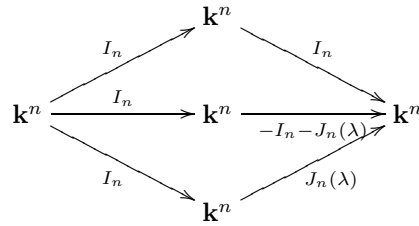

It is easy to see that they they minimal projective resolutions have the form $P_2^n \rightarrow P_2^n$ and hence $\tilde{A}/I \otimes_{\tilde{A}} (P_2^n \rightarrow P_2^n) = 0$, they do not affect the resulting matrix problem.

Let us first consider the structure of preprojective and preinjective components of the Auslander-Reiten quiver of $\tilde{A} - \text{mod}$.

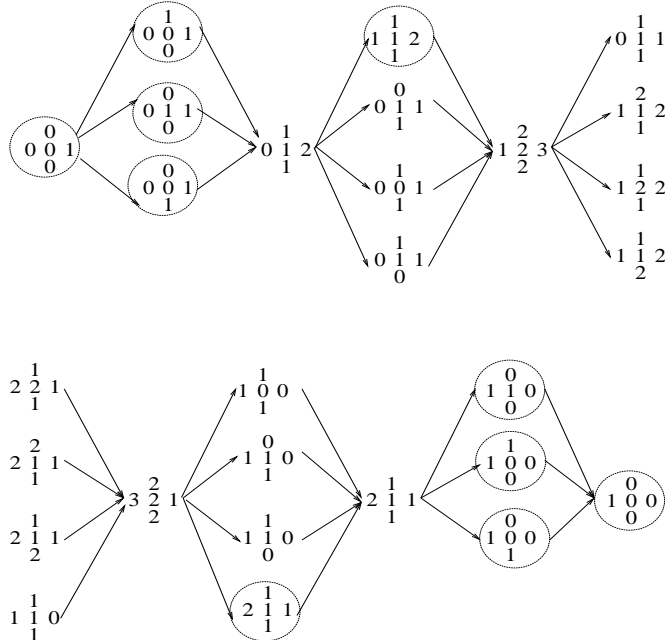

We can use the following lemma (see [14])

Lemma 6.1 *Let A be an associative \mathbf{k} -algebra,*

$$0 \longrightarrow M \xrightarrow{u} N \xrightarrow{v} K \longrightarrow 0$$

an Auslander-Reiten sequence in $A\text{-mod}$, $w \in \text{Ext}^1(K, M) = \text{Hom}_{D^b(A)}(K, T(M))$ the corresponding element. Then the following is equivalent:

1. $M \xrightarrow{u} N \xrightarrow{v} K \xrightarrow{w} T(M)$ is an Auslander-Reiten triangle in $D^b(A\text{-mod})$.
2. $\text{inj.dim}(M) \leq 1, \text{proj.dim}(K) \leq 1$.
3. $\text{Hom}_A(I, M) = 0$ for any injective A -module I and $\text{Hom}_A(K, P) = 0$ for any projective A -module P .

This lemma means that the structure of the Auslander-Reiten quiver of the category $D^b(A\text{-mod})$ is basically the same as for $A\text{-mod}$. For instance, all morphisms from tubes are still almost split in the derived category.

There is exactly one indecomposable complex in $D^b(A\text{-mod})$, which is not isomorphic to a shift of some module: it is

$$P_a \oplus P_b \oplus P_c \longrightarrow P_1.$$

It is easy to see that this complex has two non-trivial homologies and is indecomposable. Now from lemma above and the fact that there is only one non-trivial indecomposable complex we can derived the exact form of the “gluing” of the pre-projective component with the shift of the pre-injective component in the Auslander-Reiten quiver:

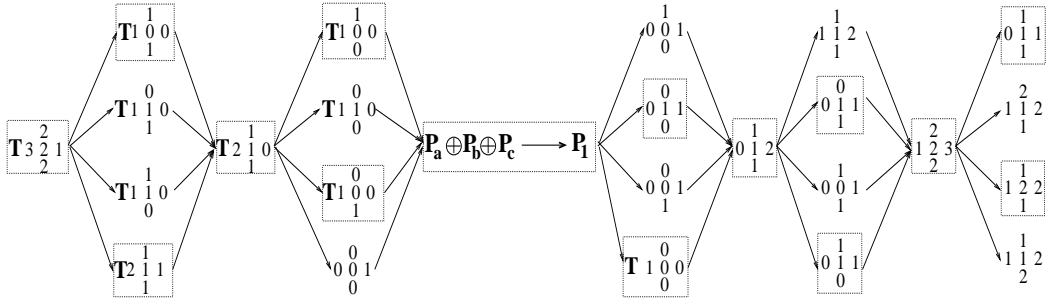

The first author would like to thank C.-M.Ringel for explaining him this.

There are finally 3 special tubes of the length 2. They are completely symmetric with respect to permutation of vertices a, b and c and only one of them is relevant for the matrix problem.

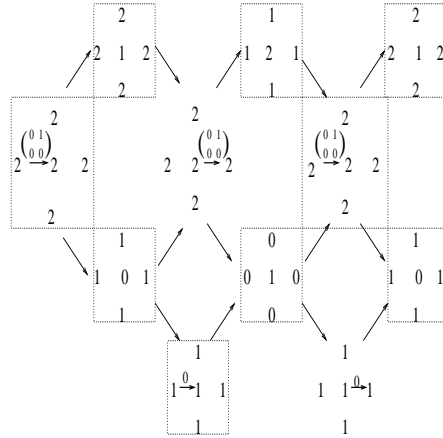

The resulting matrix problem is given by the following partially ordered set (which is very similar to the case of skew-gentle algebra, considered above)

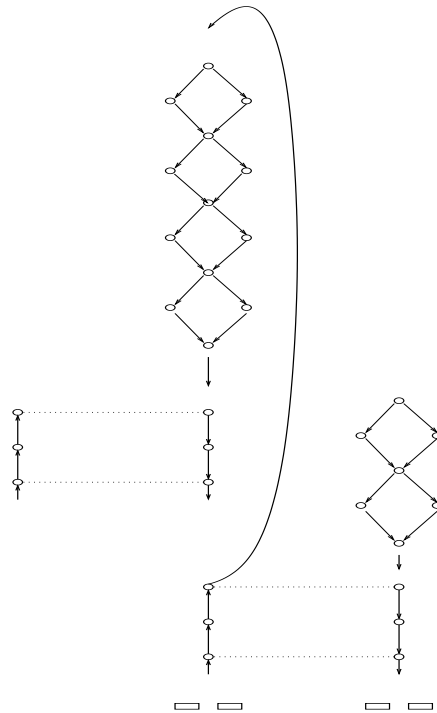

Therefore the degenerated tubular algebra $(2, 2, 2, 2; 0)$ is derived-tame of exponential growth.

It seems to be very plausible that this algebra is closely related to “weighted projective lines with a singularity of virtual genus one” and the map $A \rightarrow \tilde{A}$ plays the role of non-commutative normalization (and note that \tilde{A} correspond to a weighted projective line of virtual genus zero). We are planing to come back to this problem in the future.

One can also consider a mixes situation where we consider a radical embedding of a \mathbf{k} -algebra A into a product of finite or tame hereditary algebras and finite or tame concealed algebras.

References

- [1] V. M. Bondarenko, *Representations of bundles of semi-chains and their applications*, St. Petersburg Math. J., **3** (1992), 973-996
- [2] V. M. Bondarenko, *Bundles of semi-chains and their representations*, preprint of the Kiev Institute of mathematics, 1988.
- [3] V. M. Bondarenko, L. A. Nazarova, A. V. Roiter, V. V. Sergijchuck *Applications of the modules over a dyad to the classification of finite p -groups, having an abelian subgroup of index p* , Zapiski Nauchn. Seminara LOMI, **28** (1972) 69-92.
- [4] V. Bekkert, H. Merklen, *Indecomposables in derived categories of gentle algebras*, Preprint RT-MAT 2000-23, University of Sao Paolo 2000.
- [5] V. Bekkert, E. Marcos, H. Merklen, *Indecomposables in derived categories of skew-gentle algebras*, Preprint RT-MAT 2001-07, University of Sao Paolo 2001.
- [6] I. Burban, Yu. Drozd, *Indecomposable objects of the derived categories of nodal algebras*, to appear in Journal of Algebra.
- [7] W. Crawley-Boevey, *Functorial filtrations II. Clans and the Gelfand problem*, J. London Math. Soc. (2) **40**, no. 1, (1989), 9-30.
- [8] Yu. A. Drozd, *Matrix problems and categories of matrices*, Zapiski Nauchn. Seminara LOMI, **28** (1972) 144-153.
- [9] A. Dold *Zur Homotopietheorie der Kettenkomplexe*, Math. Ann. **140**, 278-298 (1960).
- [10] Ch. Geiß, J. A. de la Pena, *Auslander-Reiten components for clans*, Boll. Soc. Mat. Mexicana (3), **5**, (1999), pp. 307-326.
- [11] Ch. Geiß, H. Krause *On the Notion of Derived Tameness*, J. of Algebra and its Applications **1**, (2002), 133-157.

- [12] I. M. Gelfand, *Cohomology of the infinite dimensional Lie algebras; some questions of the integral geometry*, International congress of mathematics, Nice, 1970.
- [13] I. M. Gelfand, V. A. Ponomarev, *Indecomposable representations of the Lorenz group*, Uspehi Mat. Nauk, 1968, **140**, 3-60.
- [14] D. Happel, *Triangulated Categories in the Representation Theory of Finite Dimensional Algebras*, London Mathematical Society Lecture Notes Series, 119.
- [15] W. Geigle, H. Lenzing, *A class of weighted projective curves arising in representation theory of finite dimensional algebras*, Singularities, representation of algebras, and vector bundles, Proc. Symp., Lambrecht/Pfalz/FRG 1985, Lect. Notes Math. **1273**, pp.265-297 (1987).
- [16] Z. Pogorzaly, A. Skowronski, *Self-injective biserial standard algebras*, Journal of Algebra **138**, no. 2, (1991), 491-504.
- [17] C.-M. Ringel, *Tame Algebras and Integral Quadratic Forms*, Springer, 1984.
- [18] C.-M. Ringel, *The Repetitive Algebra of a Gentle Algebra*, Bol. Soc. Mat. Mexicana **3** (3), 1997, 235-253.
- [19] L. A. Nazarova, A. V. Roiter, *Finitely generated modules over diad of two discrete valuation rings*, Izv. Akad. Nauk USSR, ser. mat. **33**, (1969), 65-89.
- [20] L. A. Nazarova, A. V. Roiter, *About one problem of I. M. Gelfand*, Functional analysis and its applications, vol. **7**, **4**, 1973, 54-69.