

# An infinite family of hyperbolic graph complements in $S^3$

Roberto FRIGERIO

November 13, 2018

## Abstract

For any  $g \geq 2$  we construct a graph  $\Gamma_g \subset S^3$  whose exterior  $M_g = S^3 \setminus N(\Gamma_g)$  supports a complete finite-volume hyperbolic structure with one toric cusp and a connected geodesic boundary of genus  $g$ . We compute the canonical decomposition and the isometry group of  $M_g$ , showing in particular that any self-homeomorphism of  $M_g$  extends to a self-homeomorphism of the pair  $(S^3, \Gamma_g)$ , and that  $\Gamma_g$  is chiral. Building on a result of Lackenby [5] we also show that any non-meridinal Dehn filling of  $M_g$  is hyperbolic, thus getting an infinite family of graphs in  $S^2 \times S^1$  whose exteriors support a hyperbolic structure with geodesic boundary.

MSC (2000): 57M50 (primary), 57M15 (secondary).

## 1 Preliminaries and statements

In this paper we introduce an infinite class  $\{\Gamma_g, g \geq 2\}$  of graphs in  $S^3$  whose exteriors support a complete finite-volume hyperbolic structure with geodesic boundary. Any  $\Gamma_g$  has two connected components, one of which is a knot. We describe some geometric and topological properties of the  $\Gamma_g$ 's, and we show that for any  $g \geq 2$  any non-meridinal Dehn-filling of the torus boundary of the exterior of  $\Gamma_g$  gives a compact hyperbolic manifold with geodesic boundary.

**Definition of  $\Gamma_g$  and hyperbolicity** We say that a compact orientable 3-manifold is *hyperbolic* if, after removing the boundary tori, we get a complete finite-volume hyperbolic 3-manifold with geodesic boundary. Let  $\Gamma$  be a graph in a closed 3-manifold  $M$  and let  $N(\Gamma) \subset M$  be an open regular neighbourhood of  $\Gamma$  in  $M$ . We say that  $\Gamma$  is *hyperbolic* if  $M \setminus N(\Gamma)$  is hyperbolic. If so, Mostow-Prasad's Rigidity Theorem (see [3, 2] for a proof in the case with non-empty geodesic boundary) ensures that the complete finite-volume hyperbolic structure with geodesic boundary on  $M \setminus N(\Gamma)$  is unique up to isometry.

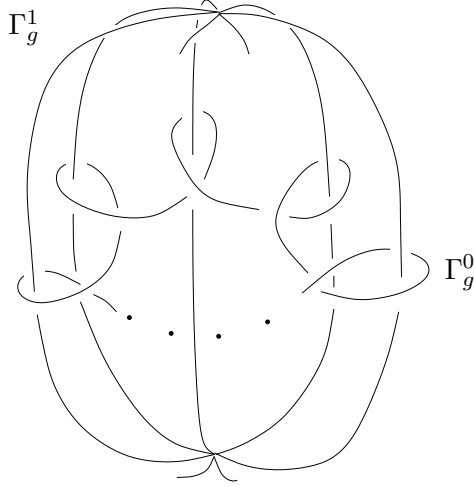

Figure 1:  $\Gamma_g$  has two components:  $\Gamma_g^0$  is a knot, while  $\Gamma_g^1$  is a graph with  $g + 1$  edges and two vertices.

For any integer  $g \geq 2$  let  $\Gamma_g \subset S^3$  be the graph shown in Fig. 1 (the graphs  $\Gamma_2$  and  $\Gamma_3$  are shown in Fig. 2). Let us denote by  $\Gamma_g^0$  and  $\Gamma_g^1$  the connected components of  $\Gamma$ , where  $\Gamma_g^0 \cong S^1$  and  $\Gamma_g^1$  has two vertices and  $g+1$  edges. We also put  $M_g = S^3 \setminus N(\Gamma_g)$ ,  $\partial_0 M_g = \partial N(\Gamma_g^0)$  and  $\partial_1 M_g = \partial N(\Gamma_g^1)$ . Recall that if  $M$  is a compact 3-manifold with  $\partial M = \partial_0 M \sqcup \partial_1 M$ , the *Heegaard genus* of  $(M, \partial_0 M, \partial_1 M)$  is the minimal genus of a surface that splits  $M$  as  $C_0 \sqcup C_1$ , where  $C_i$  is obtained by attaching 1-handles either to the “internal” side of a collar of  $\partial_i M$ , if  $\partial_i M \neq \emptyset$ , or to a 0-handle if  $\partial_i M = \emptyset$  (so  $C_i$  is a handlebody in the latter case). In Section 2 we prove the following:

**Theorem 1.1.** *The graphs  $\Gamma_g$ ,  $g \geq 2$  are hyperbolic and the Heegaard genus of  $(M_g, \partial_0 M_g, \partial_1 M_g)$  is  $g + 1$ . Moreover, the hyperbolic volume of  $M_g$  grows linearly with  $g$  as follows:*

$$\lim_{g \rightarrow \infty} \frac{\text{vol}(M_g)}{g} = 5.419960359 \dots$$

**Remark 1.2.** Since  $\Gamma_g^1$  is unknotted in  $S^3$ , the manifold  $M_g$  is the exterior of a knot in the handlebody of genus  $g$ . The knot giving  $M_2$ , which is shown in Fig. 3, was first introduced in [1], where it was proved to be hyperbolic by means of Thurston’s Hyperbolization Theorem for Haken manifolds.

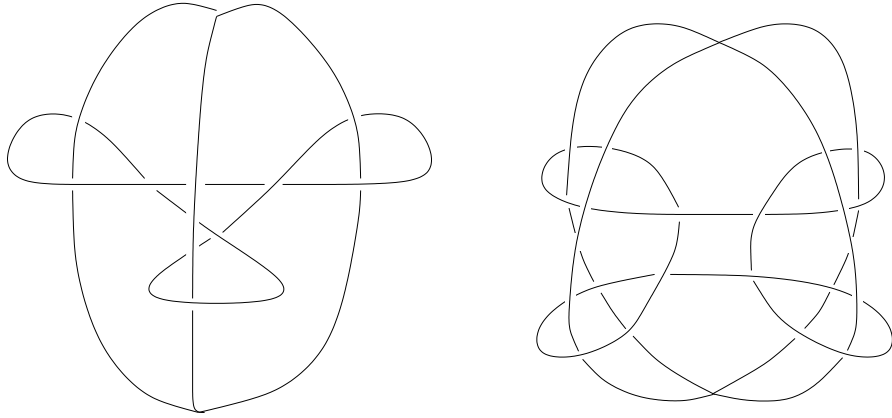

Figure 2: The graphs  $\Gamma_2$  (on the left) and  $\Gamma_3$  (on the right).

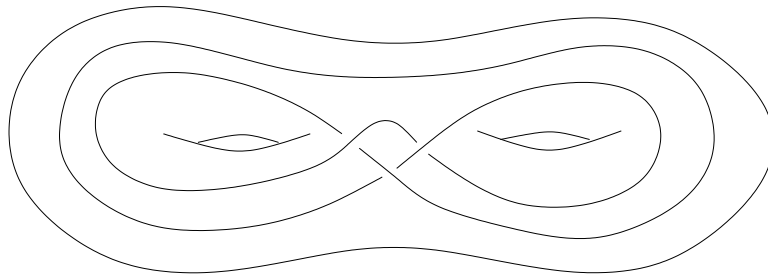

Figure 3:  $M_2$  as a knot exterior in the handlebody of genus 2.

**Canonical decomposition and isometries** In order to give  $M_g$  a hyperbolic structure we geometrize a topological triangulation of  $M_g$  by choosing suitable shapes for the tetrahedra involved. More precisely, let  $\Delta$  denote the standard tetrahedron, and let  $\dot{\Delta}$  be  $\Delta$  with its vertices removed. An *ideal triangulation* of a compact 3-manifold  $M$  with non-empty boundary is a realization of the interior of  $M$  as a gluing of a finite number of copies of  $\dot{\Delta}$ , induced by a simplicial face-pairing of the corresponding  $\Delta$ 's. In Section 2 we construct for any  $g \geq 2$  an ideal triangulation  $\mathcal{T}_g$  of  $M_g$  by  $2g + 2$  tetrahedra and we realize the simplices of  $\mathcal{T}_g$  as geodesic polyhedra in  $\mathbb{H}^3$ , in such a way that the hyperbolic structure defined on them extends to the whole of  $M_g$ .

Kojima proved in [4] that every complete finite-volume hyperbolic manifold with non-empty geodesic boundary admits a *canonical decomposition* into geometric polyhedra. The following result is proved in Section 3:

**Proposition 1.3.** *The canonical decomposition of  $M_g$  is given by  $\mathcal{T}_g$ .*

Let  $\text{Iso}(M_g)$  be the group of isometries of  $M_g$ , let  $\text{Aut}(\mathcal{T}_g)$  be the group of combinatorial automorphisms of  $\mathcal{T}_g$  and let  $\mathcal{M}(M_g)$  be the group of homotopy classes of self-homeomorphisms of  $M_g$ . An easy application of Mostow-Prasad's Rigidity Theorem gives  $\text{Iso}(M_g) \cong \text{Aut}(\mathcal{T}_g) \cong \mathcal{M}(M_g)$ .

An oriented manifold  $M$  is *chiral* if it does not admit an orientation-reversing self-homeomorphism. Let  $\Gamma \subset S^3$  be a graph and let  $\Gamma'$  be the mirror image of  $\Gamma$ . We say that  $\Gamma$  is *chiral* if there does not exist an orientation-preserving homeomorphism between  $(S^3, \Gamma)$  and  $(S^3, \Gamma')$ . The definitions just given imply that  $\Gamma$  is chiral if  $S^3 \setminus \Gamma$  is chiral. Using Proposition 1.3 we will prove the following:

**Theorem 1.4.** *Let  $D_n$  be the dihedral group of order  $2n$ , i.e.  $D_n = \langle r, s \mid r^n = s^2 = 1, rs = sr^{-1} \rangle$ , and let  $g \geq 2$ . Then:*

1. *Any element of  $\text{Iso}(M_g)$  extends to a self-homeomorphism of  $(S^3, \Gamma_g)$ ;*
2. *The group  $\text{Iso}(M_g)$  is isomorphic to  $D_{g+1}$ ;*
3. *All the elements of  $\text{Iso}(M_g)$  are orientation-preserving;*
4. *The manifold  $M_g$  and the graph  $\Gamma_g$  are chiral.*

**Dehn fillings** Recall that a *slope* on a torus is an isotopy class of simple closed curves. For any  $g \geq 2$ , we denote by  $s_g^m$  the *meridional slope* on the torus boundary of  $M_g$ , i.e. the unique slope on  $\partial N(\Gamma_g^0)$  which bounds a disc in  $\overline{N(\Gamma_g^0)}$ . For any slope  $s$  in  $\partial N(\Gamma_g^0)$  we denote by  $M_g(s)$  the manifold obtained by Dehn-filling the torus boundary of  $M_g$  along  $s$ . The next result is proved in Section 4:

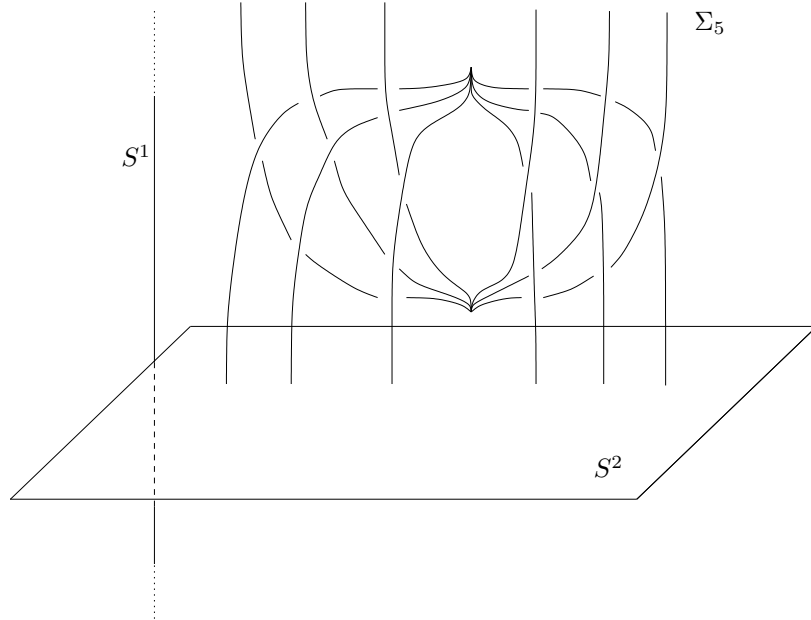

Figure 4:  $\Sigma_g$  has  $g + 1$  edges and two vertices. The picture shows the mirror image of  $\Sigma_5$  as a graph in  $\mathbb{R}^2 \times \mathbb{R} \subset S^2 \times S^1$ .

**Theorem 1.5.** *Let  $g \geq 2$  and let  $s \neq s_g^m$  be a slope on the torus boundary of  $M_g$ . Then  $M_g(s)$  is hyperbolic and has Heegaard genus equal to  $g + 1$ .*

Since  $\Gamma_g^0$  is unknotted in  $S^3$ , performing  $(0, 1)$ -Dehn surgery on the boundary torus of  $M_g$  we get the exterior of a graph in  $S^2 \times S^1$ . So Theorem 1.5 easily implies the following:

**Corollary 1.6.** *Let  $\Sigma_g$  be the graph in  $S^2 \times S^1$  shown in Fig. 4. Then  $\Sigma_g$  is a tunnel number one hyperbolic graph for any  $g \geq 2$ .*

**Remark 1.7.** Theorem 1.5 also implies the following result, which generalizes Corollary 1.6: For any  $g \geq 2$ , the  $(p, q)$ -Dehn surgery on  $\Gamma_g^0$  yields a hyperbolic tunnel number one graph in the lens space  $L_{p,q}$ .

## 2 Triangulations and hyperbolicity

In this section we prove Theorem 1.1. To this aim we construct an ideal triangulation of  $M_g$  and we prove that the tetrahedra of such triangulation can be given hyperbolic structures which match under the gluings.

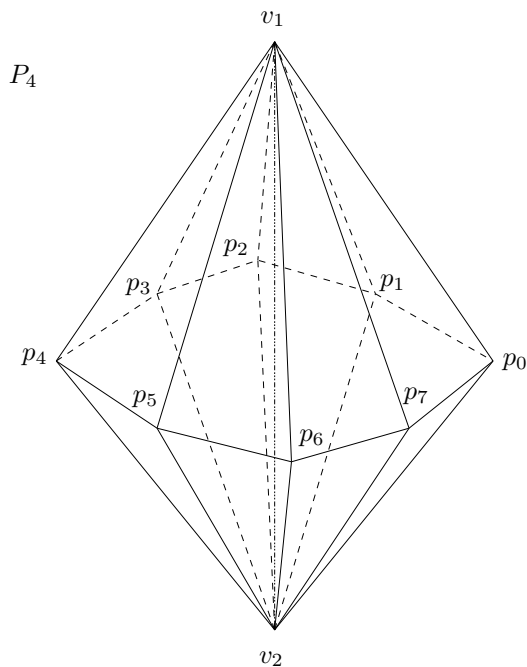

Figure 5: Gluing in pairs the faces of this ideal double cone we get (the internal part of)  $M_3$ .

**Defining the ideal triangulation** For any  $n \geq 3$ , let  $P_n$  be the solid double cone based on the regular  $2n$ -gon, and let  $\dot{P}_n$  be  $P_n$  with its vertices removed. We fix notation as suggested in Fig. 5, viewing mod  $2n$  the index  $i$  of the  $p_i$ 's. Let  $X_n$  be the topological space obtained by gluing the faces of  $\dot{P}_n$  according to the following rules:

- For any  $i = 0, 2, \dots, 2n - 4, 2n - 2$ , the face  $v_1 p_i p_{i+1}$  is identified with the face  $p_{i+1} p_{i+2} v_2$  (with  $v_1$  identified to  $p_{i+1}$ ,  $p_i$  to  $p_{i+2}$  and  $p_{i+1}$  to  $v_2$ );
- For any  $i = 1, 3, \dots, 2n - 3, 2n - 1$ , the face  $v_1 p_i p_{i+1}$  is identified with the face  $p_{i+2} v_2 p_{i+1}$  (with  $v_1$  identified to  $p_{i+2}$ ,  $p_i$  to  $v_2$  and  $p_{i+1}$  to  $p_{i+1}$ ).

The proof of the following proposition will be sketched in the next paragraph.

**Proposition 2.1.** *For any  $n \geq 3$ ,  $X_n$  is homeomorphic to the interior of  $M_{n-1}$ .*

Before discussing the proof of Proposition 2.1, let us observe that we can subdivide  $P_{g+1}$  into  $2g+2$  tetrahedra by adding the “vertical” edge  $v_1 v_2$ . Such tetrahedra

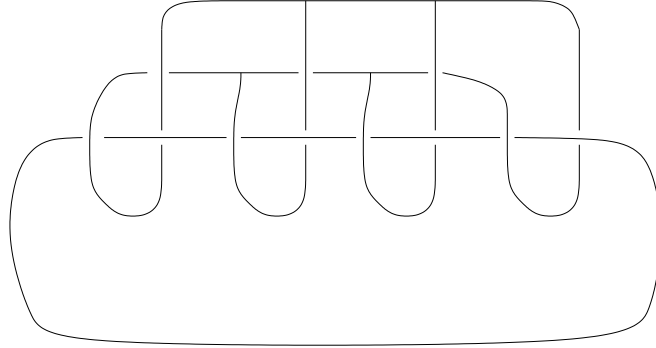

Figure 6: A projection of the graph  $\Gamma'_3$ .

give an ideal triangulation of  $M_g$ , which we denote from now on by  $\mathcal{T}_g$ . The *incidence number* of an edge in a triangulation is the number of tetrahedra incident to it (with multiplicity). The definition of  $\mathcal{T}_g$  readily implies the following:

**Lemma 2.2.** *For any  $g \geq 2$ , the triangulation  $\mathcal{T}_g$  has  $g + 3$  edges  $e_0, \dots, e_{g+2}$  such that:*

- for any  $k = 0, \dots, g$ , the edge  $e_k$  is the projection in  $M_g$  of the edges

$$v_1 p_{2k}, p_{2k} p_{2k+1}, p_{2k+1} p_{2k+2}, p_{2k+2} v_2 \subset \dot{P}_{g+1},$$

and has incidence number 6;

- $e_{g+1}$  is the projection in  $M_g$  of the edges  $\{v_i p_j \subset \dot{P}_{g+1}, i = 1, 2, j \text{ odd}\}$ , and has incidence number  $4g + 4$ ;
- $e_{g+2}$  is the projection in  $M_g$  of  $v_1 v_2 \subset \dot{P}_{g+1}$ , and has incidence number  $2g + 2$ .

□

**Constructing the ideal triangulation** In this paragraph we sketch the proof of Proposition 2.1. To this aim we apply (a slight generalization of) the algorithm producing ideal triangulations for link complements in  $S^3$  described in [6]. Such an algorithm can be easily modified in order to work with graphs rather than with links. Let us start with the following:

**Remark 2.3.** Let  $\Gamma'_g$  be the graph shown in Fig. 6. Then the complement of  $\Gamma'_g$  is homeomorphic to the complement of  $\Gamma_g$ , i.e.  $S^3 \setminus N(\Gamma'_g) \cong M_g$ .

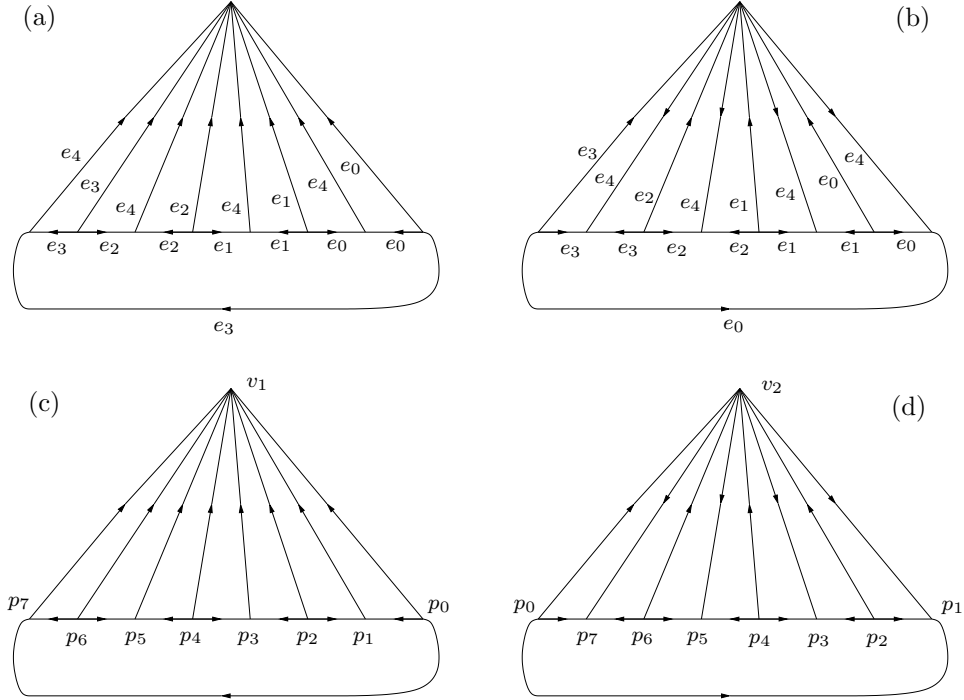

Figure 7: Applying Petronio’s algorithm to the projection in Fig. 6 we obtain the description of a cellularization of  $S^3 \setminus \Gamma'_3$  which contains two 3-cells: in (a) and (c) it is described the boundary of the upper 3-cell, while in (b) and (d) we show the boundary of the lower one. Labels for edges and vertices agree with notation in Fig. 5 and in Lemma 2.2.

Applying Petronio’s algorithm to the projection of  $\Gamma'_g$  shown in Fig. 6 we obtain the gluing diagrams shown in Fig. 7. Such diagrams encode the combinatorial rule which defines the face-pairing of  $P_{g+1}$  described in the previous paragraph (see [6] for the details). This implies Proposition 2.1.

**Geometric tetrahedra** In order to construct a hyperbolic structure on  $M_g$  we will realize the tetrahedra of  $\mathcal{T}_g$  as geometric blocks in  $\mathbb{H}^3$ . To describe the blocks to be used we need some definitions.

A *partially truncated tetrahedron* is a pair  $(\Delta, \mathcal{I})$ , where  $\Delta$  is a tetrahedron and  $\mathcal{I}$  is a set of vertices of  $\Delta$ , which are called *ideal vertices*. In the sequel we will always refer to  $\Delta$  itself as a partially truncated tetrahedron, tacitly implying that  $\mathcal{I}$  is also fixed. The *topological realization*  $\Delta^*$  of  $\Delta$  is obtained by removing from  $\Delta$  the ideal vertices and small open stars of the non-ideal ones. We call *lateral*



*hexagon* and *truncation triangle* the intersection of  $\Delta^*$  respectively with a face of  $\Delta$  and with the link in  $\Delta$  of a non-ideal vertex. The edges of the truncation triangles, which also belong to the lateral hexagons, are called *boundary edges*, and the other edges of  $\Delta^*$  are called *internal edges*. Note that, if  $\Delta$  has ideal vertices, a lateral hexagon of  $\Delta^*$  may not quite be a hexagon, because some of its (closed) edges may be missing. A *geometric realization* of  $\Delta$  is an embedding of  $\Delta^*$  in  $\mathbb{H}^3$  such that the truncation triangles are geodesic triangles, the lateral hexagons are geodesic polygons with ideal vertices corresponding to missing edges, and the truncation triangles and lateral hexagons lie at right angles to each other.

**Consistency** For any  $g \geq 2$  let us set

$$\alpha_g = \pi/(2g + 2), \quad \beta_g = 2\alpha_g, \quad \gamma_g = \arccos((2 \cos \alpha_g)^{-1}), \quad \delta_g = \pi - 2\gamma_g.$$

For any  $i = 0, \dots, 2g+1$  let  $\Delta_i$  be the tetrahedron in  $P_{g+1}$  with vertices  $v_1, v_2, p_i, p_{i+1}$ . We realize the simplices of  $\mathcal{T}_g$  as partially truncated tetrahedra as follows (see Fig. 8):

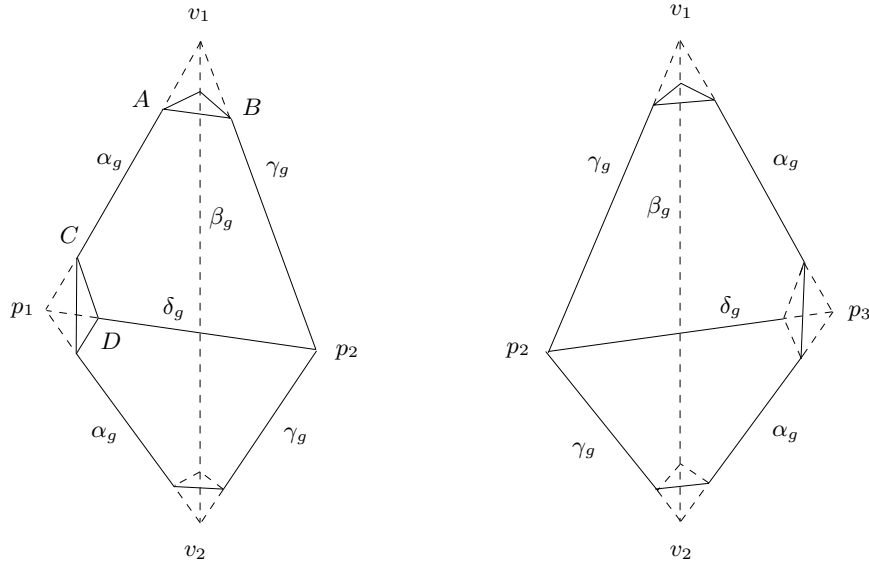

Figure 8: The dihedral angles along the edges of the tetrahedra in  $\mathcal{T}_g$ : to ensure that the matching faces can be glued by isometries we impose that  $AB$  and  $CD$  have the same length.

- For any  $i = 0, 2, \dots, 2g - 2, 2g$ , we declare  $p_i$  to be the only ideal vertex of  $\Delta_i$  and we set  $\Delta_i^*$  to be the geometric realization of  $\Delta_i$  with dihedral angles  $\delta_g$  along  $p_i p_{i+1}$ ,  $\beta_g$  along  $v_1 v_2$ ,  $\gamma_g$  along  $p_i v_1$  and  $p_i v_2$ , and  $\alpha_g$  along  $p_{i+1} v_1$  and  $p_{i+1} v_2$ ;

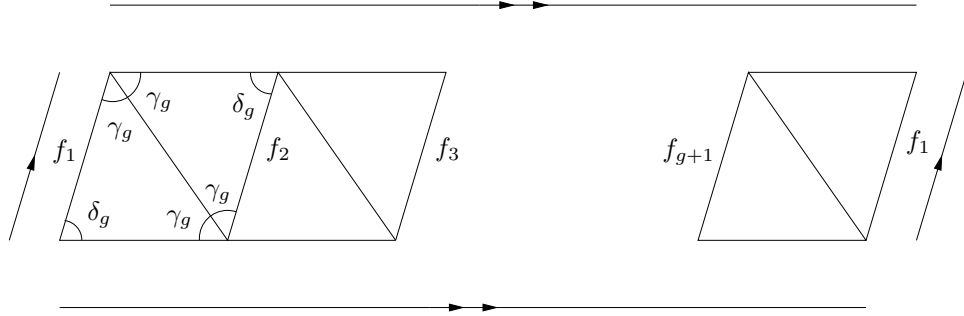

Figure 9:  $\mathcal{T}_g$  induces a tiling of the boundary torus of  $M_g$  by  $2g + 2$  isometric Euclidean isosceles triangles.

- For any  $i = 1, 3, \dots, 2g - 1, 2g + 1$ , we declare  $p_{i+1}$  to be the only ideal vertex of  $\Delta_i$  and we set  $\Delta_i^*$  to be the geometric realization of  $\Delta_i$  with dihedral angles  $\delta_g$  along  $p_i p_{i+1}$ ,  $\beta_g$  along  $v_1 v_2$ ,  $\alpha_g$  along  $p_i v_1$  and  $p_i v_2$ , and  $\gamma_g$  along  $p_{i+1} v_1$  and  $p_{i+1} v_2$ .

Existence and uniqueness of such geometric realizations are proved in [3], where it is also shown that the hyperbolic structure given on the tetrahedra of  $\mathcal{T}_g$  extends to the whole of  $M_g$  if and only if the matching boundary edges have the same length and the total dihedral angle around each internal edge is  $2\pi$ . Our choice of angles is such that all the conditions on dihedral angles and several conditions on boundary lengths are trivially satisfied. The only non-trivial condition to be imposed in order to ensure geometricity of  $\mathcal{T}_g$  is that the edges  $AB$  and  $CD$  in Fig. 8 should have the same length. This requirement translates into the following equation:

$$\frac{\cos \gamma_g \cos \alpha_g + \cos \beta_g}{\sin \gamma_g \sin \alpha_g} = \frac{\cos \delta_g \cos \alpha_g + \cos \alpha_g}{\sin \delta_g \sin \alpha_g}, \quad (1)$$

which is solved by the chosen values for  $\alpha_g, \beta_g, \gamma_g$  and  $\delta_g$ . We have thus proved that the geometric realization of  $\mathcal{T}_g$  just described defines a (possibly incomplete) hyperbolic structure on the whole of  $M_g$ .

**Completeness** To check completeness of the hyperbolic structure defined in the last paragraph we have to determine the similarity structure it induces on the boundary torus of  $M_g$ . By construction, the torus in  $\partial M_g$  is tiled by  $2g + 2$  Euclidean triangles as in Fig. 9. This shows that the structure on the boundary torus is indeed Euclidean, so the hyperbolic structure constructed in the previous paragraph is complete.

**Volume and Heegaard genus** The notion of partially truncated tetrahedron introduced before admits a generalization [3] to the case in which some internal edge degenerates into an ideal point, becoming a so-called *length-0 edge*. If the dihedral angle along a length-0 edge is declared to be equal to 0, then the volume is a continuous function of the dihedral angles of *generalized* partially truncated tetrahedra (see [10]).

Let now  $w_1, \dots, w_4$  be the vertices of a tetrahedron  $\Delta$ , and suppose that  $w_1$  is the unique ideal vertex of  $\Delta$ . Let  $\Delta_g^*$  be the geometric realization of  $\Delta$  parametrized by the following dihedral angles:

$$\angle w_1 w_2 = \angle w_1 w_3 = \gamma_g, \angle w_1 w_4 = \delta_g, \angle w_2 w_4 = \angle w_3 w_4 = \alpha_g, \angle w_2 w_3 = \beta_g, \quad (2)$$

and set  $V_g = \text{Vol}(\Delta_g^*)$ . Let also  $\Delta_\infty^*$  be the geometric (generalized) realization of  $\Delta$  with dihedral angles equal to  $\pi/3$  along the edges emanating from  $w_1$  and equal to 0 along the other three edges, and set  $V_\infty = \text{Vol}(\Delta_\infty^*)$ . Continuity of volume of generalized partially truncated tetrahedra as a function of their dihedral angles implies that

$$\lim_{g \rightarrow \infty} \frac{\text{Vol}(M_g)}{g} = \lim_{g \rightarrow \infty} \frac{(2g+2)V_g}{g} = 2 \lim_{g \rightarrow \infty} V_g = 2V_\infty = 5.419960359 \dots$$

Finally, the genus of  $(M_g, \partial_0 M_g, \partial_1 M_g)$  is of course at least  $g$ , and it is actually at most  $g+1$  because the boundary of a regular neighbourhood of  $\partial_1 M_g \cup e_{g+1}$  is easily seen to be a Heegaard surface. If the Heegaard genus of  $M_g$  were  $g$ , then  $\partial_1 M_g$  should be compressible in  $M_g$ , against the hyperbolicity of  $M_g$ .

### 3 Canonical decomposition

Kojima proved in [4] that a complete finite-volume hyperbolic manifold  $M$  with non-empty geodesic boundary admits a *canonical decomposition* into partially truncated polyhedra (an obvious generalization of a partially truncated tetrahedron). This decomposition is obtained by projecting first to  $\mathbb{H}^3$  and then to  $M$  the faces of the convex hull of a certain family  $\mathcal{P}$  of points in Minkowsky 4-space. This family  $\mathcal{P}$  splits as  $\mathcal{P}' \sqcup \mathcal{P}''$ , with  $\mathcal{P}'$  consisting of the points on the hyperboloid  $\|x\|^2 = +1$  which are dual to the hyperplanes giving  $\partial \widetilde{M}$ , where  $\widetilde{M} \subset \mathbb{H}^3$  is a universal cover of  $M$ . The points in  $\mathcal{P}''$  lie in the light-cone, and they are the duals of horoballs projecting in  $M$  to Margulis neighbourhoods of the cusps. The choice of these Margulis neighbourhoods is somewhat tricky, and carefully explained in [3]. It will be sufficient for our present purposes to know that any choice of sufficiently small Margulis neighbourhoods leads to a set  $\mathcal{P}''$  which works. In the sequel we will denote by  $\mathcal{O}$  the union of sufficiently small Margulis neighbourhoods of the cusps.

**Tilts** Suppose a decomposition  $\mathcal{T}$  of  $M$  by partially truncated tetrahedra is given. The matter of deciding if  $\mathcal{T}$  is the canonical Kojima decomposition of  $M$  is faced using the *tilt formula* [12, 11, 3], that we now briefly describe.

Let  $\sigma$  be a  $d$ -simplex in  $\mathcal{T}$  and  $\tilde{\sigma}$  be a lifting of  $\sigma$  to  $\tilde{M} \subset \mathbb{H}^3$ . To each end of  $\tilde{\sigma}$  there corresponds (depending on the nature of the end) one horoball in the lifting of  $\mathcal{O}$  or one component of the geodesic boundary of  $\tilde{M}$ , so  $\tilde{\sigma}$  determines  $d+1$  points of  $\mathcal{P}$ . Now let two tetrahedra  $\Delta_1^*$  and  $\Delta_2^*$  share a 2-face  $F^*$ , and let  $\tilde{\Delta}_1^*$ ,  $\tilde{\Delta}_2^*$  and  $\tilde{F}^*$  be liftings of  $\Delta_1^*$ ,  $\Delta_2^*$  and  $F^*$  to  $\tilde{M} \subset \mathbb{H}^3$  such that  $\tilde{\Delta}_1^* \cap \tilde{\Delta}_2^* = \tilde{F}^*$ . Let  $\tilde{F}$  be the 2-subspace in Minkowsky 4-space that contains the three points of  $\mathcal{P}$  determined by  $\tilde{F}^*$ . For  $i = 1, 2$  let  $\overline{\Delta}_i^{(F)}$  be the half-3-subspace bounded by  $\tilde{F}$  and containing the fourth point of  $\mathcal{P}$  determined by  $\tilde{\Delta}_i^*$ . Then one can show that  $\mathcal{T}$  is canonical if and only if, whatever  $F^*, \Delta_1^*, \Delta_2^*$ , the following holds:

- The half-3-subspaces  $\overline{\Delta}_1^{(F)}$  and  $\overline{\Delta}_2^{(F)}$  lie on distinct 3-subspaces and their convex hull does not contain the origin of Minkowsky 4-space.

The tilt formula computes a real number  $t(\Delta^*, F^*)$  describing the “slope” of  $\overline{\Delta}^{(F)}$  in terms of the intrinsic geometry of  $\Delta^*$  and  $\mathcal{O}$ . More precisely, one can translate the condition just stated into the inequality  $t(\Delta_1^*, F^*) + t(\Delta_2^*, F^*) < 0$ .

**The canonical decomposition of  $M_g$**  Coming to the manifolds we are interested in, let  $g \geq 2$ , let  $\mathcal{T}_g$  be the geometric triangulation of  $M_g$  we have described in the previous section and let  $\mathcal{O}$  be a suitable neighbourhood of the cusp of  $M_g$ . It was shown in [3] that  $\mathcal{O}$  determines a real number  $r_\Delta(v) > 0$  for the ideal vertex  $v$  of any tetrahedron  $\Delta$  in  $\mathcal{T}_g$ . This number  $r_\Delta(v)$  represents the “height” of the trace in  $\Delta$  near  $v$  of  $\partial\mathcal{O}$  (except that  $r_\Delta(v) \ll 1$  means that  $\partial\mathcal{O}$  is “very” high). Looking at the intersection of  $\mathcal{O}$  with the tetrahedra of  $\mathcal{T}_g$  it is easily seen that  $r_\Delta(v)$  has a certain fixed value  $r$  whenever  $v$  is the ideal vertex of any  $\Delta$  in  $\mathcal{T}_g$ .

Let now  $w_1, \dots, w_4$  be the vertices of a geometric partially truncated tetrahedron  $\Delta_g^*$  in  $\mathcal{T}_g$  and suppose that  $w_1$  is the unique ideal vertex of  $\Delta_g^*$ . Let the dihedral angles of  $\Delta_g^*$  be as prescribed in equation (2) and let  $r = r(w_1)$  be the parameter associated with the intersection of  $\mathcal{O}$  with  $\Delta_g^*$ . For any  $i = 1, \dots, 4$  let also  $F_i^*$  be the face of  $\Delta_g^*$  opposite to  $w_i$ . Using the formulae given in [3] we can compute the tilts of the geometric blocks of  $\mathcal{T}_g$ . Let us set

$$\begin{aligned} d_1 &= 2r \cdot (\sin^2 \gamma_g \sin \delta_g) / (2 \sin \gamma_g \cos \alpha_g + \sin \delta_g \cos \beta_g) > 0, \\ d_2 = d_3 &= \cos^2 \alpha_g + \cos^2 \beta_g + \cos^2 \gamma_g + 2 \cos \alpha_g \cos \beta_g \cos \gamma_g - 1 > 0, \\ d_4 &= 2 \cos^2 \alpha_g + \cos^2 \delta_g + 2 \cos^2 \alpha_g \cos \delta_g - 1 > 0. \end{aligned}$$

Then there exists a constant  $k_g > 0$ , depending only on  $g$ , such that

$$\begin{aligned} t(\Delta_g^*, F_1^*) &= d_1 - k_g \cdot \left( 2\sqrt{d_2} \cos \alpha_g + \sqrt{d_4} \cos \beta_g \right), \\ t(\Delta_g^*, F_2^*) = t(\Delta_g^*, F_3^*) &= -d_1 \cos \alpha_g + k_g \cdot \left( \sqrt{d_2}(1 - \cos \delta_g) - \sqrt{d_4} \cos \gamma_g \right), \\ t(\Delta_g^*, F_2^*) &= -d_1 \cos \beta_g + k_g \cdot \left( -2\sqrt{d_2} \cos \gamma_g + \sqrt{d_4} \right). \end{aligned}$$

Now an easy computation shows that

$$\sqrt{d_2}(1 - \cos \delta_g) - \sqrt{d_4} \cos \gamma_g = -2\sqrt{d_2} \cos \gamma_g + \sqrt{d_4} = 0.$$

This implies that if  $r$  is small enough, then all the tilts are negative, so  $\mathcal{T}_g$  is the Kojima decomposition of  $M_g$  for any  $g \geq 2$ , and Proposition 1.3 is proved.

**Isometry group** By Proposition 1.3, the isometry group of  $M_g$  is canonically isomorphic to the group  $\text{Aut}(\mathcal{T}_g)$  of combinatorial automorphisms of  $\mathcal{T}_g$ . For any  $g \geq 2$ , let  $r_g$  and  $s_g$  be the unique combinatorial automorphisms of the double cone  $P_{g+1}$  such that:

$$\begin{aligned} r_g(p_i) &= p_{i+2} \quad \forall i \in \{0, \dots, 2g+1\}, \quad r_g(v_1) = v_1, \quad r_g(v_2) = v_2, \\ s_g(p_i) &= p_{-i} \quad \forall i \in \{0, \dots, 2g+1\}, \quad s_g(v_1) = v_2, \quad s_g(v_2) = v_1. \end{aligned}$$

If we realize  $P_{g+1}$  as a Euclidean regular  $(2g+2)$ -gonal double cone, then  $r_g$  is a rotation of order  $g+1$  around the line containing  $v_1$  and  $v_2$ , while  $s_g$  is a rotation of order 2 having as axis the line through  $p_0$  and  $p_{g+1}$ . This easily implies that the following relations hold:

$$r_g^{g+1} = s_g^2 = 1, \quad r_g \circ s_g = s_g \circ r_g^{-1}.$$

Theorem 1.4 is now readily deduced from the following:

**Proposition 3.1.** *Both  $r_g$  and  $s_g$  induce combinatorial automorphisms of  $\mathcal{T}_g$ . Moreover, the group  $\text{Aut}(\mathcal{T}_g)$  is generated by  $r_g$  and  $s_g$  for any  $g \geq 2$ .*

*Proof:* The first statement readily follows by a direct computation. In order to prove the second statement, for any  $g \geq 2$  let  $H_g$  be the subgroup of  $\text{Aut}(\mathcal{T}_g)$  generated by  $r_g$  and  $s_g$ . Noting that  $H_g$  acts transitively on the set of tetrahedra of  $\mathcal{T}_g$ , to conclude that  $\text{Aut}(\mathcal{T}_g) = H_g$  it is enough to show that the stabilizer in  $\text{Aut}(\mathcal{T}_g)$  of one tetrahedron of  $\mathcal{T}_g$  is trivial. So let  $\Delta_0 \subset P_{g+1}$  be the tetrahedron in  $\mathcal{T}_g$  with vertices  $p_0, p_1, v_1, v_2$ . We observe that  $p_0$  and  $p_1$  can be characterized as the only vertices of  $\Delta_0$  satisfying the following properties:

- $p_0$  is asymptotic in  $M_g$  to the boundary torus (*i.e.* it is ideal in the geometric realization);
- there exist edges  $e, e'$  of  $\Delta_0$  such that  $p_1 = e \cap e'$  and  $e, e'$  are projected in  $M_g$  to the only edge of  $\mathcal{T}_g$  having order  $4g + 4$ .

Let now  $\varphi$  be an element in  $\text{Aut}(\mathcal{T}_g)$  such that  $\varphi(\Delta_0) = \Delta_0$ . The intrinsic description of  $p_0$  and  $p_1$  given above implies that  $\varphi(p_i) = p_i$  for  $i = 0, 1$ . Now it is easily seen that the simplicial automorphism of  $\Delta_0$  which fixes  $p_0, p_1$  and interchanges  $v_1$  with  $v_2$  does not extend to an automorphism of  $\mathcal{T}_g$ , so  $\varphi|_{\Delta_0}$  must be the identity. This implies that  $\varphi = 1$  in  $\text{Aut}(\mathcal{T}_g)$ , so the stabilizer of  $\Delta_0$  in  $\text{Aut}(\mathcal{T}_g)$  is trivial, and we are done.  $\square$

## 4 Dehn filling

This section is devoted to the proof of Theorem 1.5. A detailed analysis of the geometry of the tetrahedra of  $\mathcal{T}_g$  will lead us to an estimate on the size of the cusp of  $M_g$ . We will then apply a theorem of Lackenby [5] to prove the desired result.

**Maximal cusps, slopes and hyperbolicity** Let  $M$  be an orientable hyperbolic 3-manifold and let  $\dot{M}$  be  $M$  with its boundary tori removed, so that  $\dot{M}$  admits by definition a complete finite-volume hyperbolic structure with geodesic boundary and cusps. We say that  $\mathcal{O} \subset \dot{M}$  is a *horocusp section* for  $M$  if  $\dot{M} \setminus \mathcal{O}$  is compact and the preimage of  $\mathcal{O}$  in the universal covering of  $\dot{M}$  is the disjoint union of open horoballs. If  $\mathcal{O}$  is a horocusp section, then  $\partial\mathcal{O}$  is a union of (possibly touching or self-touching) tori and the hyperbolic structure of  $\dot{M}$  induces on  $\partial\mathcal{O}$  a well-defined Euclidean metric. A horocusp section for  $M$  is *maximal* if it is maximal among the horocusp sections for  $M$  with respect to inclusion. We observe that a maximal horocusp section always exists, and is unique if  $M$  has only one boundary torus.

Let now  $T_1, \dots, T_k$  be the boundary tori of  $M$ , let  $h \leq k$  and let  $s_i$  be a slope on  $T_i$  for any  $i = 1, \dots, h$ . We denote by  $M(s_1, \dots, s_h)$  the manifold obtained by Dehn-filling  $M$  along  $s_1, \dots, s_h$ . If  $\mathcal{O}$  is a fixed horocusp section for  $M$ , then any  $s_i$  determines a well-defined isotopy class of Euclidean geodesics on the corresponding component of  $\partial\mathcal{O}$ . We denote by  $L_{\mathcal{O}}(s_i)$  the Euclidean length of such geodesics. The following theorem is proved in [5]:

**Theorem 4.1.** *Let  $M$  be hyperbolic with boundary  $\partial M = T_1 \sqcup \dots \sqcup T_k$  given by  $k$  tori. Let  $h \leq k$  and  $s_i$  be a slope on  $T_i$  for any  $i = 1, \dots, h$ . Fix a horocusp section  $\mathcal{O}$  for  $M$  and suppose that  $L_{\mathcal{O}}(s_i) > 6$  for any  $i = 1, \dots, h$ . Then  $M(s_1, \dots, s_h)$  is irreducible, atoroidal and has infinite word-hyperbolic fundamental group.*

**Hyperbolic Dehn fillings** Building on Theorem 4.1 we prove here the following:

**Proposition 4.2.** *Let  $M$  be hyperbolic with boundary  $\partial M = \Sigma_1 \sqcup \dots \sqcup \Sigma_r \sqcup T_1 \sqcup \dots \sqcup T_k$  given by  $r > 0$  surfaces of negative Euler characteristic and  $k$  tori. Let  $h \leq k$  and  $s_i$  be a slope on  $T_i$  for any  $i = 1, \dots, h$ . Fix a horocusp section  $\mathcal{O}$  for  $M$  and suppose that  $L_{\mathcal{O}}(s_i) > 6$  for any  $i = 1, \dots, h$ . Then  $M(s_1, \dots, s_h)$  is hyperbolic.*

*Proof:* Let  $DM$  be the double of  $M$  along  $\Sigma = \Sigma_1 \sqcup \dots \sqcup \Sigma_r$ , i.e. the manifold obtained by mirroring  $M$  along  $\Sigma$ . Then  $M$  is canonically embedded in  $DM$ , and  $DM$  admits an involution  $\sigma$  which fixes  $\Sigma \subset M \subset DM$  and interchanges  $M$  with its mirror copy. Of course we have  $\partial DM = T_1 \sqcup \dots \sqcup T_k \sqcup \bar{T}_1 \sqcup \dots \sqcup \bar{T}_k$ , where  $\bar{T}_i = \sigma(T_i)$  for any  $i = 1, \dots, k$ . Note also that for any  $i = 1, \dots, h$  the slope  $s_i$  on  $T_i$  determines a mirror slope  $\bar{s}_i = \sigma(s_i)$  on  $\bar{T}_i$ . The manifold  $DM$  can be given a hyperbolic structure simply by doubling the hyperbolic structure with geodesic boundary of  $M$ . Then  $\mathcal{O}$  determines a horocusp section  $D\mathcal{O}$  for  $DM$  such that  $L_{D\mathcal{O}}(\bar{s}_i) = L_{D\mathcal{O}}(s_i) = L_{\mathcal{O}}(s_i) > 6$  for any  $i = 1, \dots, h$ . So Theorem 4.1 implies that  $DM(s, \bar{s}) := DM(s_1, \dots, s_h, \bar{s}_1, \dots, \bar{s}_h)$  is irreducible and atoroidal and has infinite, word-hyperbolic fundamental group.

Let now  $W$  be a compression disc for  $\Sigma$  in  $DM(s, \bar{s})$ , so  $\partial W = \Sigma \cap W$  does not bound a disc on  $\Sigma$ . By possibly replacing  $W$  with  $\sigma(W)$  we can suppose that  $W$  is properly embedded in  $M(s_1, \dots, s_h)$ . If  $W$  were non-separating in  $M(s_1, \dots, s_h)$  then its double  $DW$  would be a non-separating sphere in  $DM(s, \bar{s})$ , a contradiction since  $DM(s, \bar{s})$  is irreducible. So let  $N_1$  and  $N_2$  be the manifolds obtained by cutting  $M(s_1, \dots, s_h)$  along  $W$  and for  $r = 1, 2$  let  $DN_r$  be the double of  $N_r$  along  $\Sigma \cap N_r \subset \partial N_r$ . By construction the sphere  $DW$  decomposes  $DM(s, \bar{s})$  as the connected sum of  $DN_1$  and  $DN_2$ , so  $DN_{\bar{r}}$  is a 3-ball for  $\bar{r} = 1$  or  $2$ . This easily implies that  $N_{\bar{r}}$  is 3-ball and  $\Sigma \cap N_{\bar{r}}$  is a disc on  $\Sigma$  with boundary  $\partial W$ , a contradiction since  $W$  is a compression disc for  $\Sigma$ . We have thus shown that  $\Sigma$  is incompressible in  $DM(s, \bar{s})$ , so Thurston's Hyperbolization Theorem for Haken manifolds [8] implies that  $DM(s, \bar{s})$  is hyperbolic.

Of course  $\sigma$  extends to an involution  $\hat{\sigma}$  of  $DM(s, \bar{s})$ , which is in turn homotopic to an involutive isometry  $\bar{\sigma}$  by Mostow-Prasad's Rigidity Theorem. A result of Tollefson [9] now ensures that  $\bar{\sigma}$  fixes a surface  $\Sigma'_1 \sqcup \dots \sqcup \Sigma'_r$  isotopic to  $\Sigma_1 \sqcup \dots \sqcup \Sigma_r$ . Cutting  $DM(s, \bar{s})$  along  $\Sigma'_1 \sqcup \dots \sqcup \Sigma'_r$  we obtain isometric complete finite-volume hyperbolic manifolds with geodesic boundary  $Y$  and  $\bar{Y}$ . Since  $M(s_1, \dots, s_h)$  is homeomorphic to  $Y$ , the conclusion follows.  $\square$

**The maximal cusp of  $M_g$**  Coming back to the case we are interested in, we now want to determine the size of the maximal horocusp section  $\mathcal{O}_g$  for  $M_g$ ,  $g \geq 2$ . So let us fix  $g \geq 2$  and let  $\Delta_g^*$  be a geometric partially truncated tetrahedron in  $\mathcal{T}_g$  with

vertices  $w_1, w_2, w_3$  and  $w_4$  and with dihedral angles as prescribed in equation (2). We can realize  $\Delta_g^*$  in the upper half-space model of  $\mathbb{H}^3$  in such a way that  $w_1$  is identified with  $\infty$ , so the truncation triangles corresponding to  $w_2, w_3$  and  $w_4$  lie on the hyperbolic planes bounded by  $S_2, S_3$  and  $S_4$  respectively, where  $S_i$  is a Euclidean circle in  $\mathbb{C} \times \{0\} \subset \partial\mathbb{H}^3$  for  $i = 2, 3, 4$  (see Fig. 10). We also denote by  $F_1, F_2, F_3, F_4$

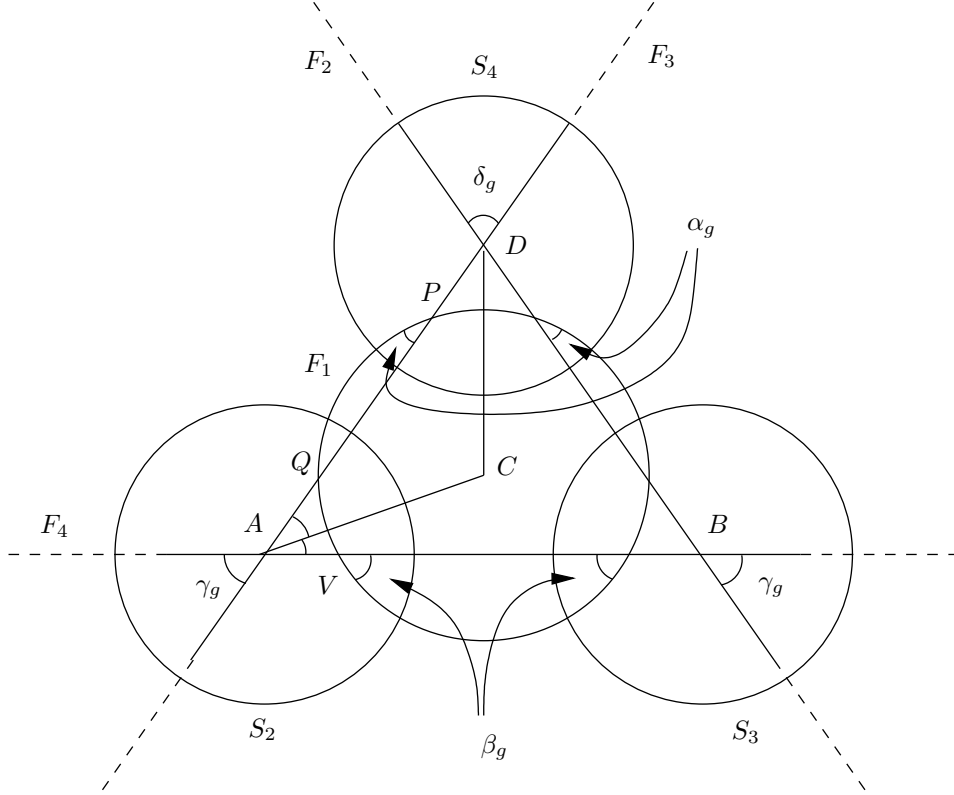

Figure 10: Notation for the proof of Lemma 4.3.

the traces at infinity of the hyperbolic planes containing the faces of  $\Delta_g^*$  with vertices  $w_2w_3w_4, w_1w_3w_4, w_1w_2w_4, w_1w_2w_3$  respectively. By construction  $F_1$  is a Euclidean circle perpendicular to  $S_i$  for  $i = 2, 3, 4$ , while  $F_j$  is a Euclidean line perpendicular to  $S_l$  for  $j, l \in \{2, 3, 4\}, l \neq j$ . We denote by  $C$  and  $R$  the center and the radius of  $F_1$ , and we also set

$$A = F_3 \cap F_4, B = F_2 \cap F_4, D = F_2 \cap F_3, \{P, Q\} = F_1 \cap F_3, V \in F_1 \cap F_4.$$



Let us observe that equation (1) in Section 2 implies that the Euclidean radii of  $S_2, S_3$  and  $S_4$  are equal to the same value  $R'$ .

**Lemma 4.3.** *The following equalities hold:*

$$R'^2 = R^2 \cdot \frac{\cos^2 \alpha_g + \cos^2 \beta_g + \cos^2 \gamma_g + 2 \cos \alpha_g \cos \beta_g \cos \gamma_g - 1}{\sin^2 \gamma_g}, \quad (3)$$

$$\overline{AB} = 2R' \cdot \frac{\cos \alpha_g + \cos \beta_g \cos \gamma_g}{\sqrt{\cos^2 \alpha_g + \cos^2 \beta_g + \cos^2 \gamma_g + 2 \cos \alpha_g \cos \beta_g \cos \gamma_g - 1}}. \quad (4)$$

*Proof:* Let  $\gamma'_g = \angle CAV$ ,  $\gamma''_g = \angle CAQ$ . Applying the Euclidean Sine Rule to the triangles  $ACV$  and  $ACQ$  we get  $\overline{AC}/\sin(\pi/2 + \beta_g) = R/\sin \gamma'_g$  and  $\overline{AC}/\sin(\pi/2 + \alpha_g) = R/\sin \gamma''_g$ . So we have  $\sin \gamma''_g \cos \beta_g = \sin \gamma'_g \cos \alpha_g$ . Substituting the equality  $\gamma''_g = \gamma_g - \gamma'_g$  in this equation and dividing by  $\sin \gamma'_g$  we obtain:

$$\cot \gamma'_g = \frac{\cos \alpha_g + \cos \beta_g \cos \gamma_g}{\cos \beta_g \sin \gamma_g}. \quad (5)$$

Combining this relation with the equalities

$$\sin \gamma'_g = (1 + \cot^2 \gamma'_g)^{-1/2}, \quad \overline{AC} = R \cdot \cos \beta_g / \sin \gamma'_g, \quad R'^2 = \overline{AC}^2 - R^2$$

we finally get equation (3).

Since  $\overline{AB} = 2\overline{AC} \cdot \cos \gamma'_g$  and  $\overline{AC} = R \cdot \cos \beta_g / \sin \gamma'_g$  we have  $\overline{AB} = 2R \cdot \cos \beta_g \cot \gamma'_g$ . Substituting equations (5) and (3) in this equality we now get equation (4).  $\square$

**Lemma 4.4.** *We have  $R' > R$ .*

*Proof:* By equation (3), we have to prove that

$$\cos^2 \alpha_g + \cos^2 \beta_g + 2 \cos^2 \gamma_g + 2 \cos \alpha_g \cos \beta_g \cos \gamma_g > 2.$$

Using that  $\cos \gamma_g = (2 \cos \alpha_g)^{-1}$  and  $2 \cos^2 \alpha_g = 1 + \cos \beta_g$ , this inequality reduces to  $2 \cdot \cos^3 \beta_g + 5 \cdot \cos^2 \beta_g - 1 > 0$ , which is verified since  $\beta_g = \pi/(g+1) \geq \pi/3$ .  $\square$

Let now  $O_{\Delta_g^*}$  be the intersection of  $\Delta_g^*$  with the horoball centered in  $\infty$  and bounded by the Euclidean plane  $\mathbb{C} \times \{R'\} \subset \mathbb{C} \times (0, \infty) \cong \mathbb{H}^3$ . By Lemma 4.4,  $O_{\Delta_g^*} \subset \mathbb{C} \times (0, \infty)$  is an Euclidean triangular prism and touches the three boundary triangles of  $\Delta_g^*$ . Recall now that the geometric tetrahedra  $\Delta_g^{1,*}, \dots, \Delta_g^{2g+2,*}$  in  $\mathcal{T}_g$  are all isometric to  $\Delta_g^*$ . For any  $i = 1, \dots, 2g+2$  we define  $O_i \subset \Delta_g^{i,*}$  as the only subset of  $\Delta_g^{i,*}$  such that the pair  $(\Delta_g^{i,*}, O_i)$  is isometric to the pair  $(\Delta_g^*, O_{\Delta_g^*})$ . It is easily seen that the  $O_i$ 's glue to each other in  $M_g$  to a horocusp section for  $M_g$ . Such section is the desired maximal section  $\mathcal{O}_g$ , since it touches the geodesic boundary of  $M_g$ .

**Length of the slopes** The boundary  $\partial\mathcal{O}_g$  of the maximal horocusp section of  $M_g$  is a Euclidean torus tiled by  $2g + 2$  triangles. Let  $f_1, \dots, f_{g+1}$  be the edges of this tiling shown in Fig. 9 and let  $\bar{s}_g$  be the slope on the boundary torus of  $M_g$  determined by  $f_1, \dots, f_{g+1}$ . We set  $\ell_g = L_{\mathcal{O}_g}(\bar{s}_g)$ . Let us note that  $\ell_g$  is the Euclidean length of each of the  $f_i$ 's.

**Lemma 4.5.** *The following equality holds:*

$$\ell_g = 2 \cos \alpha_g \cdot \sqrt{\frac{4 \cos^2 \alpha_g - 1}{4 \cos^4 \alpha_g - 1}}.$$

*Proof:* Keeping notations from the previous paragraph, we have  $\ell_g = \overline{AD}/R'$ . Now  $\overline{AD} = \overline{AB}/(2 \cos \gamma_g)$ , so by equation (4) we get

$$\ell_g = \frac{\cos \alpha_g + \cos \beta_g \cos \gamma_g}{\cos \gamma_g \cdot \sqrt{\cos^2 \alpha_g + \cos^2 \beta_g + \cos^2 \gamma_g + 2 \cos \alpha_g \cos \beta_g \cos \gamma_g - 1}}.$$

Substituting in this equation the relations  $\beta_g = 2\alpha_g$ ,  $\cos \gamma_g = (2 \cos \alpha_g)^{-1}$  we get the desired result.  $\square$

If  $s, s'$  are slopes on a torus, we denote by  $\Delta(s, s')$  their *distance*, *i.e.* their geometric intersection.

**Proposition 4.6.** *Let  $g \geq 2$  and let  $s$  be a slope on the boundary torus of  $M_g$  with  $s \neq \bar{s}_g$ . Then  $L_{\mathcal{O}_g}(s) > 6$ .*

*Proof:* The torus  $\partial\mathcal{O}_g$  is tiled by  $2g + 2$  Euclidean triangles each of which has area equal to  $\ell_g^2 \cdot \sin \delta_g / 2$ . Using Lemma 4.5 and the relations  $\delta_g = \pi - 2\gamma_g$ ,  $\cos \gamma_g = (2 \cos \alpha_g)^{-1}$  we can easily compute the area  $A_g$  of  $\partial\mathcal{O}_g$ , getting  $A_g = (2g + 2)(4 \cos^2 \alpha_g - 1)^{3/2} / (4 \cos^4 \alpha_g - 1)$ .

Let now  $\theta(s, \bar{s}_g)$  be the Euclidean angle determined by geodesic representatives for  $s$  and  $\bar{s}_g$  on  $\partial\mathcal{O}_g$ . We have  $L_{\mathcal{O}_g}(s) \cdot L_{\mathcal{O}_g}(\bar{s}_g) \cdot \sin \theta(s, \bar{s}_g) = \Delta(s, \bar{s}_g) \cdot A_g$ , which implies that

$$L_{\mathcal{O}_g}(s) \geq \frac{\Delta(s, \bar{s}_g) \cdot A_g}{\ell_g} = \frac{(g + 1) \cdot \Delta(s, \bar{s}_g) \cdot (4 \cos^2 \alpha_g - 1)}{\cos \alpha_g \cdot \sqrt{4 \cos^4 \alpha_g - 1}}.$$

Suppose first that  $(g + 1) \cdot \Delta(s, \bar{s}_g) \geq 6$ . Then, since  $4 \cos^2 \alpha_g = 2 + 2 \cos \beta_g \geq 2 + 2 \cos \pi/3 = 3$ , we obtain

$$L_{\mathcal{O}_g}(s) \geq \frac{(g + 1) \cdot \Delta(s, \bar{s}_g) \cdot 2}{\sqrt{3}} > (g + 1) \cdot \Delta(s, \bar{s}_g) \geq 6,$$

and we are done.

We have now to examine the cases when  $\Delta(s, \bar{s}_g) = 1$  and  $g = 2, 3, 4$  or  $5$ . Suppose for example  $g = 2$ ,  $\Delta(s, \bar{s}_2) = 1$ , and let  $s'_2$  be the slope corresponding to the longest edges of the fundamental domain for  $\partial\mathcal{O}_2$  shown in Fig. 9. Then we have  $\Delta(s'_2, \bar{s}_2) = 1$ ,  $L_{\mathcal{O}_2}(s'_2) = 3\ell_2$  and  $\theta(s'_2, \bar{s}_2) = \delta_2 = \arccos 1/3$ . Let  $\bar{r}_2, r'_2$  and  $r$  be representatives in  $H_1(\partial\mathcal{O}_2)$  for  $\bar{s}_2, s'_2$  and  $s$  respectively (such representatives are uniquely defined up to sign). Since  $\Delta(s, \bar{s}_2) = 1$ , there exists  $a \in \mathbb{Z}$  such that  $r = a \cdot \bar{r}_2 \pm r'_2$ . Then

$$L_{\mathcal{O}_2}^2(s) = a^2\ell_2^2 + 9\ell_2^2 \pm 6a\ell_2^2 \cdot \cos\theta(\bar{s}_2, s'_2) = (a^2 + 9 \pm 2a) \cdot \ell_2^2 \geq 8\ell_2^2.$$

Since  $\alpha_2 = \pi/6$ , Lemma 4.5 implies that  $\ell_2^2 = 24/5$ , so  $L_{\mathcal{O}_2}^2(s) \geq 8 \cdot 24/5 = 38.4 > 6^2$ , and we are done.

A very similar computation works also in the remaining cases.  $\square$

We can now prove Theorem 1.5. By Propositions 4.6 and 4.2 we deduce that for any  $g \geq 2$  all but one Dehn-filling of  $M_g$  are hyperbolic. If  $s_g^m$  is the meridinal slope on the torus boundary of  $M_g$ , then  $M_g(s_g^m)$  is the handlebody, so it is boundary-reducible, whence non-hyperbolic. This implies that  $M_g(s)$  is hyperbolic if and only if  $s \neq s_g^m$ .

Moreover, if  $s \neq s_g^m$  then the Heegaard genus of  $M_g(s)$  is at least  $g + 1$ , since  $\text{genus}(\partial M_g(s)) = g$  and  $M_g(s)$  is not a handlebody. Since a Heegaard surface for  $(M_g, \partial_0 M_g, \partial_1 M_g)$  embeds in  $M_g(s)$  as a Heegaard surface for  $M_g(s)$  itself, the genus of  $M_g(s)$  is actually equal to  $g + 1$ .

## Acknowledgements

The author gratefully acknowledges financial support from the University of Melbourne and thanks Craig Hodgson and Damian Heard for many helpful conversations.

## References

- [1] C. ADAMS, *Quasifuchsian Surfaces in Hyperbolic Knots Complements*, J. Austr. Math. Soc. **55** (1993), 116-131.
- [2] R. FRIGERIO, *Hyperbolic manifolds with geodesic boundary which are determined by their fundamental group*, [math.GT/0306398](#).
- [3] R. FRIGERIO, C. PETRONIO, *Construction and recognition of hyperbolic 3-manifolds with geodesic boundary*, [math.GT/0109012](#), to appear in Trans. Amer. Math. Soc.

- [4] S. KOJIMA, *Polyhedral decomposition of hyperbolic manifolds with boundary*, Proc. Work. Pure Math. **10** (1990), 37-57.
- [5] M. LACKENBY, *Word hyperbolic Dehn surgery*, Invent. Math. **140** (2000), 243-282.
- [6] C. PETRONIO, *An algorithm producing hyperbolicity equations for a link complement in  $S^3$* , Geom. Dedicata **44** (1992), 67-104.
- [7] W.P. THURSTON, "The geometry and topology of 3-manifolds", mimeographed notes, Princeton, 1979.
- [8] W.P. THURSTON, *Three-dimensional manifolds, Kleinian groups and hyperbolic geometry*, Bull. Amer. Math. Soc. (N.S.) **6** (1982), 357-381.
- [9] J. L. TOLLEFSON, *Involutions of sufficiently large 3-manifolds*, Topology **20** (1981), 323-352.
- [10] A. USHIJIMA, *A volume formula for generalized hyperbolic tetrahedra*, math.GT/0309216.
- [11] A. USHIJIMA, *The tilt formula for generalized simplices in hyperbolic space*, Discrete Comput. Geom. **28** (2002), 19-27.
- [12] J. R. WEEKS, *Convex hulls and isometries of cusped hyperbolic 3-manifolds*, Topology Appl. **52** (1993), 127-149.

Scuola Normale Superiore  
 Piazza dei Cavalieri 7  
 56127 Pisa, Italy  
 frigerio@sns.it