

Real Polynomial Diffeomorphisms with Maximal Entropy: II. Small Jacobian

Eric Bedford and John Smillie

§0. Introduction

The problem of understanding the dynamical behavior of diffeomorphisms has played a central role in the field of dynamical systems. One way of approaching this question is to ask about generic behavior in the space of diffeomorphisms. Another way to approach it is to ask about behavior in some specific parametrized family. The family of diffeomorphisms of \mathbf{R}^2 introduced by Hénon has often played the role of such a test case. This is a two parameter family given by the formula

$$f_{a,b}(x, y) = (a - x^2 - by, x)$$

for $b \neq 0$. There are regions of parameter space which are well understood. If we fix b then for $a \ll 0$ the nonwandering set of $f_{a,b}$ is empty. For $a \gg 0$, it is shown in [DN] that the restriction of $f_{a,b}$ to its nonwandering set is hyperbolic and topologically conjugate to the full two-shift. Such diffeomorphisms are called “horseshoes”. How the dynamics changes between these two extremes has been the subject of much investigation. The case $b = 0$ is an interesting special case. In this case the map $f_{a,b}$ is not a diffeomorphism; in fact the dynamical behavior is essentially one dimensional. The dynamical complexity of $f_{a,0}$ increases monotonically with a (see [MT]). For other values of b no such results are known. In fact [KKY] show that in some respects the behavior should not be expected to be monotone. One way of measuring the topological complexity is through the topological entropy, $h_{top}(f_{a,b})$. This is a continuous real valued function of the parameters which takes on values in the interval $[0, \log 2]$. The case $a \ll 0$ corresponds to $h_{top} = 0$. The case $a \gg 0$ corresponds to $h_{top} = \log 2$. In this paper we study the set of parameters (a, b) for which $h_{top}(f_{a,b})$ takes on its maximal value. We say that $f_{a,b}$ has maximal entropy if $h_{top}(f_{a,b}) = \log 2$. We analyze the “maximal entropy locus” when the Jacobian parameter b is small. We show:

Theorem 1. *For each b with $|b| < .08$ there is a unique $a = a_b$ so that $h_{top}(f_{ab}) < \log 2$ for $a < a_b$ and $h_{top}(f_{ab}) = \log 2$ for $a \geq a_b$. Further, we have:*

- (1) *If $a > a_b$, f_{ab} is a hyperbolic horseshoe.*
- (2) *If $a = a_b$, f_{ab} has a quadratic tangency between stable and unstable manifolds of fixed points. This tangency is homoclinic when $b > 0$ and heteroclinic when $b < 0$.*

The next result discusses properties of the function $b \mapsto a_b$ defined in Theorem 1.

Theorem 2. *The function $b \mapsto a_b$ is continuous on the interval $(-.08, .08)$. It is analytic on the subintervals $(-.08, 0)$ and $(0, .08)$ but not differentiable at $b = 0$. Furthermore, there is a generic unfolding of the homoclinic tangency at the parameter (a_b, b) , i.e., at the point of tangency, the stable and unstable manifolds move past one another with positive speed with respect to a .*

The terminology “generic unfolding” will be explained in greater detail in §5.

Part of Theorem 1 follows from a more general analysis of polynomial diffeomorphisms of maximal entropy in degree $d \geq 2$, which was carried out in [BS8] and [BS1]. In particular we proved in this more general context that a maximal entropy polynomial diffeomorphism is either hyperbolic or has a quadratic tangency between stable and unstable manifolds of periodic points. The contribution of this paper is to describe the set of parameter values corresponding to these two types of behavior.

Though these results are stated for the diffeomorphisms $f_{a,b} : \mathbf{R}^2 \rightarrow \mathbf{R}^2$ our methods give us very complete information about the corresponding complex extensions $f_{a,b} : \mathbf{C}^2 \rightarrow \mathbf{C}^2$ for maximal entropy parameter values. In fact it is the analysis of these complex extensions which allows us to obtain information about the real Hénon diffeomorphisms. In particular we take advantage of theory of intersections of complex manifolds to analyze the complex extensions of the of the real stable and unstable manifolds.

In addition to proving Theorems 1 and 2, a goal of this paper is to develop the technique of crossed mappings as a method of more general applicability in the analysis of families of polynomial diffeomorphisms of \mathbf{C}^2 . These techniques are explored further in [BS3].

We note that this is not the first time that complex methods have been used to address similar questions. J.H. Hubbard and R. Oberste-Vorth [O] used complex methods to improve the result of Devaney-Nitecki. And Fornæss and Gavosto [FG1,2] have used complex methods to show that there is a generic unfolding of a complex tangency for $f_{a,b}$ for certain parameters (a, b) .

§1. The Quadratic Horseshoe Locus: First Approximation

We consider mappings of the form

$$f_{a,b}(x, y) = (a - x^2 - by, x) \tag{1.1}$$

with $b \neq 0$. Note that f may also be written in the form $\chi^{-1} \circ f \circ \chi = (y, y^2 - a - bx)$, where we set $\chi(x, y) = (-y, -x)$. We say that $f_{a,b}$ is a *(complex) horseshoe* if $f_{a,b}$ is hyperbolic on $J = J(f_{a,b})$ and if $f|_J$ is topologically conjugate to the full 2-shift. If, in addition, $J \subset \mathbf{R}^2$, we say that $f_{a,b}$ is a *real horseshoe*. J.H. Hubbard and R. Oberste-Vorth have obtained estimates on the (complex) horseshoe locus; see [O] and [MNTU, Proposition 7.4.6]. These are summarized in the following:

Theorem 1.1. *If $b \neq 0$, and if $|a| > 2(1 + |b|)^2$, then $f_{a,b}$ is a (complex) horseshoe. If, in addition, $b \in \mathbf{R}$, and $a > 0$, then $f_{a,b}$ is a real horseshoe.*

Since horseshoes have entropy equal to $\log 2$, the following result gives a large region of parameter space where there are no horseshoes. This is the region to the left in Figure 1.

Theorem 1.2. *Define $\sigma^-(b) = 2 - \frac{13}{8}b - \frac{7}{64}b^2$ and $\sigma^+(b) = 2 + \frac{7}{4}b + \frac{5}{16}b^2$. If $(a, b) \in \mathbf{R}^2$ satisfy $b \neq 0$, $|b| \leq 1$ and $a \leq \max(\sigma^-(b), \sigma^+(b))$, then the entropy of $f|_{\mathbf{R}^2}$ is less than $\log 2$.*

Proof. First we note that a fixed point of $f_{a,b}$ has the form (x, y) , where

$$x = y = -\frac{1}{2} \left[b + 1 \pm \sqrt{(b+1)^2 + 4a} \right]. \tag{1.2}$$

Now we recall some results from [BS1]. If $f_{a,b}$ is a quadratic diffeomorphism of \mathbf{R}^2 , and if $f|_{\mathbf{R}^2}$ has entropy $\log 2$, then $f_{a,b}$ has two fixed points, which must be saddles. Further, one of these points must be unstably one-sided, and the unstable eigenvalue of Df at this fixed point is (strictly) greater than 4. The other fixed point has a negative eigenvalue in the unstable direction, and this eigenvalue must be less than -2 .

The differential is given in (x, y) -coordinates as

$$Df_{a,b} = \begin{pmatrix} -2x & -b \\ 1 & 0 \end{pmatrix}.$$

The product of the eigenvalues is b , so we may write them as λ and b/λ . Thus the trace of the differential is

$$-2x = \lambda + b/\lambda.$$

If $|b| \leq 1$, then $\lambda \mapsto \lambda + b/\lambda$ is strictly increasing in λ for $|\lambda| > 1$. Thus the condition that there is an eigenvalue greater than 4 gives us the inequality

$$-2x > 4 + \frac{b}{4}, \tag{1.3}$$

and the condition that there is an eigenvalue less than -2 gives the inequality

$$-2x < -(2 + \frac{b}{2}). \tag{1.4}$$

(Note that the inequalities (1.3) and (1.4) refer to different fixed points and thus involve different values of x .)

Now we substitute expression (1.2) into (1.3) and obtain

$$\begin{aligned} b + 1 \pm \sqrt{(b+1)^2 + 4a} &> 4 + \frac{b}{4} \\ \sqrt{(b+1)^2 + 4a} &> 3 - \frac{3}{4}b \\ b^2 + 2b + 1 + 4a &> 9 - \frac{9}{2}b + \frac{9}{16}b^2 \end{aligned}$$

which gives $a > \sigma^-(b)$.

Similarly, we substitute (1.2) into (1.4) and find

$$\begin{aligned} b + 1 \pm \sqrt{(b+1)^2 + 4a} &< -2 - \frac{b}{2} \\ \pm \sqrt{(b+1)^2 + 4a} &< -3 - \frac{3}{2}b \\ b^2 + 2b + 1 + 4a &> 9 + 9b + \frac{9}{4}b^2, \end{aligned}$$

where the last inequality is reversed because the quantities being squared are negative. Thus $a > \sigma^+(b)$. The case that one of these inequalities fails happens exactly when we have $a \leq \max(\sigma^+(b), \sigma^-(b))$, and in this case the entropy is not equal to $\log 2$. \square

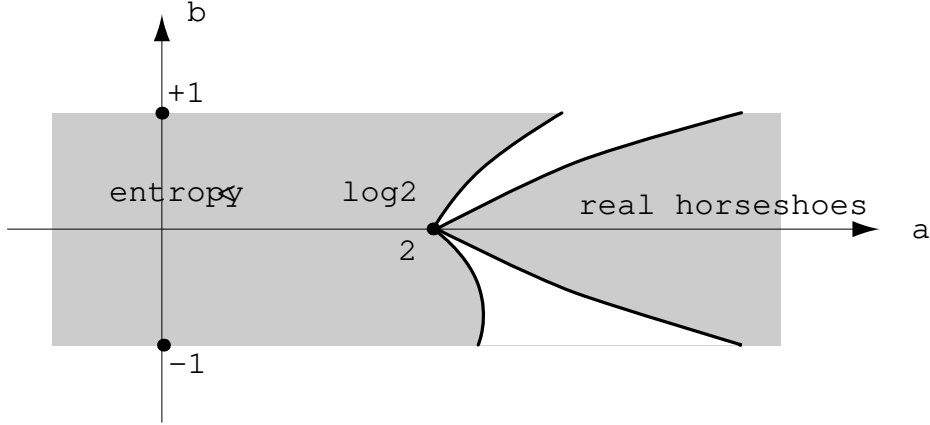

Figure 1

Figure 1 shows the information on parameter space that is given by Theorems 1.1 and 1.2. This figure considers only parameters $|b| \leq 1$. In fact, we restrict our attention without loss of generality to the case $|b| \leq 1$ throughout this paper. Each of the items discussed in the theorem: maximal entropy, the horseshoe property, and generic unfolding, will hold for f if and only if it holds for f^{-1} . Thus the fact that $f_{a,b}^{-1}$ is conjugate to $f_{\frac{a}{b^2}, \frac{1}{b}}$ means that the regions that define these dynamical behaviors are invariant under the involution $(a, b) \mapsto (ab^{-2}, b^{-1})$. In particular, this gives versions of these Theorems corresponding to the case $|b| > (.08)^{-1}$.

§2. Complex Boxes and Crossed Mappings

In order to study the system $f|K : K \rightarrow K$, we will introduce an open cover by “boxes” B_i and study a family of “crossed mappings” $f_{i,j} : B_i \rightarrow B_j$. We start by working with $p(z) = 2 - z^2$ and a covering of its Julia set $[-2, 2]$. The Green function for $[-2, 2]$ is

$$G(z) = \log \left| \frac{z + \sqrt{z^2 - 4}}{2} \right|.$$

For $\lambda > 0$, p induces a 2-fold branched covering $p : \{G < \lambda\} \rightarrow \{G < 2\lambda\}$. The level sets $\{G = \lambda\}$ are ellipses with foci at ± 2 , and the gradient lines (the orthogonal trajectories) are given by the family of hyperbolae with foci at ± 2 .

Let us fix $c = \frac{1}{2}(\sqrt{17} - 1)/2 \sim 1.5615$ and $d = \frac{1}{2}(1 + \sqrt{7 + 2\sqrt{17}}) \sim 2.4523$. Let $E \subset \mathbf{C}$ be the domain bounded by the ellipse with foci at ± 2 and passing through $\pm d$. It follows that $p(E)$ is the ellipse with foci at ± 2 and passing through $\pm(d^2 - 2)$. We set $D_0 := \{\zeta \in \mathbf{C}^2 : \Re(\zeta) < 0\} \cap E$ and $D_2 := \{\zeta \in \mathbf{C}^2 : \Re(\zeta) > 0\} \cap E$ as in Figure 2. It follows that $p(D_0) = p(D_2) = p(E) - [2, d^2 - 2]$. Let D_1 denote the region in E lying between the hyperbolae with foci at ± 2 and which pass through $\pm c$ as in Figure 3. Thus $p(D_1)$ is the region of the ellipse $p(E)$ to the right of the hyperbola with foci at ± 2 and passing through $2 - c^2$. We have the following inclusions:

$$D_0 \cup D_1 \subset p(D_0) = p(D_2), \quad D_2 \subset p(D_1).$$

We may also compute certain distances related to these inclusions:

$$\begin{aligned}
\text{dist}(\partial p(D_0), D_0) &= d^2 - 2 - d \\
\text{dist}(\partial p(D_0), D_1) &= 2 - c \\
\text{dist}(\partial p(D_1), D_2) &= c^2 - 2;
\end{aligned}
\tag{2.1}$$

While calculating the distances between ellipses can be difficult in general, these calculations are straightforward because the relevant ellipses are in a confocal family. Thus the minimal distances between these ellipses are realized by points on the real axis. By the choices of c and d , we have

$$\Delta := d^2 - d - 2 = 2 - c = c^2 - 2 \sim .4384.
\tag{2.2}$$

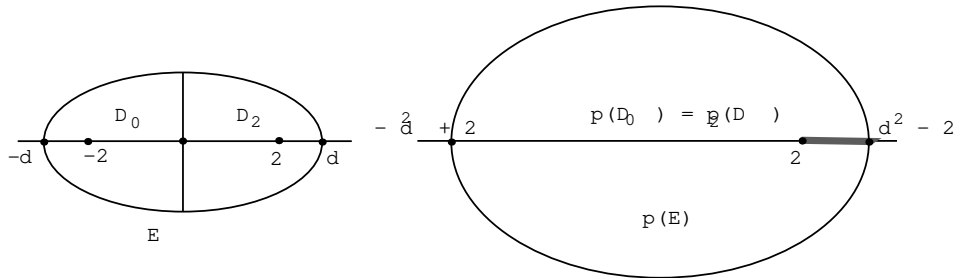

Figure 2

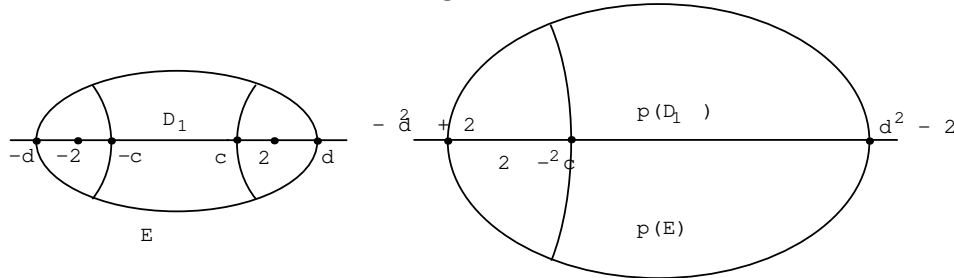

Figure 3

Now choose $e > d$ and set $B_j = \{(x, y) \in \mathbf{C}^2 : x \in D_j, |y| < e\} = D_j \times \{|y| < e\}$ for $j = 0, 1, 2$. Thus $B_0 \cup B_1 \cup B_2 = E \times \{|y| < e\}$. We introduce the set

$$\mathcal{A} := \{a, b \in \mathbf{C}, b \neq 0, |a - 2| + e|b| < \Delta\} \approx \{|a - 2| + 2.4|b| < .43\}.
\tag{\ddagger}$$

Proposition 2.1. *If $(a, b) \in \mathcal{A}$, then $K \subset B_0 \cup B_1 \cup B_2$.*

Proof. By [MNTU, p. 238], we know that K is contained in the bidisk $\{|x|, |y| < R\}$, where R is the larger root of the equation $t^2 - (1 + |b|)t - |a| = 0$. By the condition $|a - 2| + e|b| < \Delta$, we conclude that we may take e sufficiently close to d , then we have

$$R \leq \frac{1 + \Delta/e + \sqrt{(1 + \Delta/e)^2 + 4(2 + \Delta)}}{2} \sim 2.25845$$

Recall that pE is an ellipse with foci at ± 2 and major axis of length $d^2 - 2 \sim 4.01378$. We then compute that its minor axis has length $\sqrt{(d^2 - 2)^2 - 4} \sim 3.48$.

To prove the Proposition, we need to show that if $(x, y) \in \{|x|, |y| < R\}$, and if $x \notin E$, then $(x, y) \notin K$. For such (x, y) , the x -coordinate of $f(x, y)$ satisfies:

$$|\pi_v(f(x, y)) - p(x)| < |a - 2| + |by| < |a - 2| + R|b| < \Delta + (R - e)|b| < 1.03465\Delta$$

since $|b| < \Delta/e$. Now let $D := \{\zeta \in pE : \text{dist}(\zeta, \partial(pE)) > 1.03465\Delta\}$. Since $x \notin E$, it follows that $px \notin pE$, and so the x -coordinate of $f(x, y)$ does not belong to D . On the other hand, the minor axis of pE is 3.48, so that D contains the disk of radius $3.48 - 1.03465\Delta \sim 3.0264 > R$. Thus $f(x, y) \notin K$. \square

The vertical and horizontal components of the boundaries are defined to be

$$\partial_v B_j = (\partial D_j) \times \{|y| \leq e\}, \quad \partial_h B_j = \overline{D}_j \times \{|y| = e\}.$$

We set $\mathcal{G} = \{(0, 0), (0, 1), (1, 2), (2, 1), (2, 0)\}$, and we interpret \mathcal{G} as a graph on the vertices $\{B_0, B_1, B_2\}$ as in Figure 4.

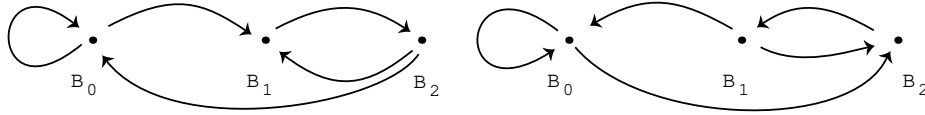

Figure 4: Graphs \mathcal{G} for f (on left) and \mathcal{G}^{-1} for f^{-1} (on right)

Proposition 2.2. *If (\ddagger) holds, then $f_{a,b}(\partial_v B_i) \cap \overline{B}_j = \emptyset$ and $f_{a,b}(\overline{B}_i) \cap \partial_h B_j = \emptyset$ for all $(i, j) \in \mathcal{G}$.*

Proof. By estimates (2.1) and (2.2) and the fact that $p(\partial D_0) = p(\partial D_2)$, we have

$$\text{dist}(p(\zeta), \partial D_j) \geq \Delta$$

for $\zeta \in \partial D_i$ and $(i, j) \in \Gamma$. Thus if $x \in \partial D_i$ and $|y| < e$, the first coordinate of $f_{a,b}(x, y)$ satisfies

$$|a - x^2 - by - p(x)| \leq |a - 2| + |by| < \Delta.$$

This gives $a - x^2 - by \notin \overline{D}_j$, so $f(\partial_v B_i) \cap \overline{B}_j = \emptyset$.

Note that $\partial_h B_j \subset \{|y| = e\}$. The second coordinate of f is x , so the second condition follows from the fact that $\overline{D}_j \cap \{|y| = e\} = \emptyset$, independently of a and b . \square

Let $\pi_v(x, y) = x$ and $\pi_h(x, y) = y$ denote the projections in the vertical and horizontal directions. We let $f_{i,j}$ denote the mapping $f : B_i \cap f^{-1}B_j \rightarrow B_j$. Following [HO], we say that $f_{i,j}$ is a *crossed mapping* if for each $y \in \{|y| < e\}$,

$$\pi_v \circ f : (D_i \times \{y\}) \cap f^{-1}B_j \rightarrow D_j \tag{2.4}$$

is proper. Given $(i, j) \in \mathcal{G}$, then it follows from Proposition 2.2 that $f_{i,j}$ is a crossed mapping. We say that the degree of $f_{i,j}$ as a crossed mapping is the mapping degree of the map in (2.4) (which is independent of y). Similarly, we say that $f^{-1} : B_j \cap fB_i \rightarrow B_i$, which we denote by f_{ji}^{-1} , is a crossed mapping if for each $x \in D_j$,

$$\pi_h \circ f^{-1} : (\{x\} \times \{|y| < e\}) \cap fB_i \rightarrow \{|y| < e\} \tag{2.5}$$

is proper. As was observed in [HO], $f_{i,j}$ is a crossed mapping if and only if f_{ji}^{-1} is. And the degree of f_{ji}^{-1} as a crossed mapping is defined as the mapping degree of the map in (2.5) (which is independent of x). This, in turn, is the same as the degree of $f_{i,j}$. We will say that $(\mathcal{B}, \mathcal{G})$ is a system of crossed mappings, if $f_{i,j}$ induces a crossed mapping from B_i to B_j for each $(i, j) \in \mathcal{G}$. The following Corollary is a consequence of Proposition 2.2.

Corollary 2.3. *If (\ddagger) holds, then $(\mathcal{B}, \mathcal{G})$ is a system of crossed mappings.*

We define an *orbit* in a system of crossed mappings as a bi-infinite sequence $(p_j, i_j)_{j \in \mathbf{Z}}$ such that for all $j \in \mathbf{Z}$, $p_j \in B_{i_j}$, $(i_j, i_{j+1}) \in \mathcal{G}$, and $f(p_j) = p_{j+1}$. Next we give conditions that guarantee that every f -orbit $(p_j)_{j \in \mathbf{Z}}$ in K can be lifted to an orbit of the system of crossed mappings.

Proposition 2.4. *Suppose that $K \cap (B_0 \cup B_1) \subset f(B_0 \cup B_2)$ and $K \cap B_2 \subset f(B_1)$. Then for $q \in K$ there is an admissible sequence $I = (i_n)_{n \in \mathbf{Z}}$ such that $f^n q \in B_{i_n}$ for all $n \in \mathbf{Z}$.*

Proof. Let us start by making a sequence $J_M = \{j_n : -M \leq n \leq M\}$ of finite length. If we have determined j_n already, then $f^n(q) \in B_{j_n} \cap K$. If $j_n = 0$ or 1 , then by hypothesis $f^{n-1}q \in (B_0 \cup B_2) \cap K$. Thus we may choose $j_{n-1} \in \{0, 2\}$ such that $f^{n-1}q \in B_{j_{n-1}}$, and in either case we have $(j_{n-1}, j_n) \in \mathcal{G}$. Similarly, if $j_n = 2$, then $f^n q \in B_2 \cap K$, and by hypothesis we have $f^{n-1}q \in B_1$. Thus we set $j_{n-1} = 1$ and $(j_{n-1}, j_n) = (1, 2) \in \mathcal{G}$. Starting at $n = M$, we continue backwards and generate an admissible sequence J_M .

Now we have admissible sequences J_1, J_2, \dots of increasing length. For each M , there is a sequence I_M that is a subsequence of infinitely many sequences J_{k_m} . We may make M increasingly large and thus obtain an infinite sequence I . \square

Proposition 2.5. *If $a, b \in \mathbf{R}$ and if (\ddagger) holds, then*

$$(\overline{B}_{0,r} \cup \overline{B}_{1,r}) \cap f(B_0 \cup B_1 \cup B_2) \subset f(B_0 \cup B_2)$$

$$\overline{B}_{2,r} \cap f(B_0 \cup B_1 \cup B_2) \subset f(B_1).$$

Proof. We note that $(B_0 \cup B_1 \cup B_2 - B_0 \cup B_2) \cap \mathbf{R}^2 = \{0\} \times (-e, e)$. Thus to prove the first inclusion, it suffices to show that $(\overline{B}_{0,r} \cup \overline{B}_{1,r}) \cap f(\{0\} \times (-e, e)) = \emptyset$. But $\overline{B}_{0,r} \cup \overline{B}_{1,r} = [-d, c] \times [-e, e]$, and the x -projection of the f -image of this set is

$$\pi_v \circ f(\{0\} \times (-e, e)) = \{a - x^2 - by : x = 0, |y| < e\} \subset (2 - \Delta, 2 + \Delta).$$

On the other hand, $\overline{B}_{0,r} \cup \overline{B}_{1,r} = [-d, c] \times [-e, e]$. Thus $(\overline{B}_{0,r} \cup \overline{B}_{1,r}) \cap f(\{0\} \times (-e, e)) = \emptyset$ since $c + \Delta = 2$, which proves the first inclusion.

For the second inclusion, we note that

$$(B_0 \cup B_1 \cup B_2 - B_1) \cap \mathbf{R}^2 = ((-d, -c) \cup (c, d)) \times (-e, e).$$

The x -projection of the f -image of this set is

$$\{a - x^2 - by : c < |x| < d, |y| < e\} \subset (2 - d^2 - \Delta, 2 - c^2 + \Delta).$$

On the other hand, the x -projection of $\overline{B}_{2,r}$ is $[c, d]$, which is disjoint from $(-\infty, 2 - c^2 + \Delta)$ since $2 - c^2 + \Delta = c$. \square

Let $V \subset B_i$ be a complex subvariety. We say that V is a *horizontal multi-disk* (resp. *vertical multi-disk*) if each component of V is conformally equivalent to a complex disk, and if $\partial_h B_i \cap \overline{V} = \emptyset$ (resp. $\partial_v B_i \cap \overline{V} = \emptyset$). With this terminology the union of horizontal (resp. vertical) multi-disks is again a horizontal (resp. vertical) multi-disk. We denote the set of horizontal (resp. vertical) multi-disks by $\mathcal{D}_h(B_i)$ (resp. $\mathcal{D}_v(B_i)$). If $V \in \mathcal{D}_h(B_0)$ (resp. $V \in \mathcal{D}_v(B_i)$), then $\pi_v : V \rightarrow D_i$ (resp. $\pi_h : V \rightarrow \{|y| < e\}$) is proper, and we let $\delta(V)$ denote the degree of the corresponding projection. By $\mathcal{D}_h^m(B_i)$ (resp. $\mathcal{D}_v^m(B_i)$) we denote the set of horizontal (resp. vertical) multi-disks V such that for each component W of V , the degree $\delta(W)$ is no greater than m . We note the following:

$$\text{If } V' \in \mathcal{D}_v(B_i) \text{ and } V'' \in \mathcal{D}_h(B_i), \text{ then } \#(V' \cap V'') = \delta(V')\delta(V''). \quad (2.6)$$

If f_{ij} is a crossed map, and if $V \subset B_i$ is a subvariety for which $\partial_h B_i \cap \overline{V} = \emptyset$, then $\tilde{f}_{ij}(V) := f(V) \cap B_j$ is closed in B_j and satisfies $\partial_h B_j \cap \overline{\tilde{f}_{ij}(V)} = \emptyset$, and is thus a horizontal subvariety. If $\deg(f_{ij})$ denotes the degree as a crossed map, then we have

$$\deg(f_{ij})\delta(V) = \delta(\tilde{f}_{ij}(V)). \quad (2.7)$$

Proposition 2.6. *If (\dagger) holds, it follows that*

$$\tilde{f}_{12} : \mathcal{D}_h^m(B_i) \rightarrow \mathcal{D}_h^{2m}(B_j) \text{ and } \tilde{f}_{21}^{-1} : \mathcal{D}_v^m(B_j) \rightarrow \mathcal{D}_v^{2m}(B_i),$$

and if $(i, j) \in \mathcal{G}$, $(i, j) \neq (1, 2)$, then

$$\tilde{f}_{ij} : \mathcal{D}_h^m(B_i) \rightarrow \mathcal{D}_h^m(B_j) \text{ and } \tilde{f}_{ji}^{-1} : \mathcal{D}_v^m(B_j) \rightarrow \mathcal{D}_v^m(B_i).$$

Proof. We will show that $\tilde{f}_{ij}(V)$ is conformally equivalent to a disk; the degree is given by (2.7). Suppose V is a horizontal disk in B_i . Then, taking boundary inside \mathbf{C}^2 , we have $\partial V \subset \partial_v(B_i)$. By Proposition 2.2, $f(\partial V) \cap \partial B_j = \emptyset$. Thus each component of $f(V) \cap B_j$ is closed in B_j . The second part of Proposition 2.2 implies that $\pi_v : f(V) \cap B_j \rightarrow D_j$ is proper. Finally, we need to show that each component W of $f(V) \cap B_j$ is conformally equivalent to the disk. Since V is a disk, there is a conformal equivalence $\varphi : \Delta \rightarrow V \subset \mathbf{C}^2$. Now the components of $fV \cap B_j$ correspond to the components of $\{\zeta \in \Delta : f \circ \varphi(\zeta) \in B_j\} = \{\zeta \in \Delta : \pi_v \circ f \circ \varphi(\zeta) \in D_j\}$. Since $\overline{D_j}$ is simply connected, there is a subharmonic function s on \mathbf{C} such that $\overline{D_j} = \{s \leq 0\}$. It follows from the maximum principle that each component of $(\pi_v \circ f \circ \varphi)^{-1}(\overline{D_j}) = \{s \circ f \circ \varphi \leq 0\}$ is simply connected. Finally, since $\pi_v \circ f \circ \varphi$ is an open mapping, each component of $(\pi_v \circ f \circ \varphi)^{-1}D_j$ is simply connected. \square

Since f_{00} is a crossed mapping from B_0 to itself, there is a saddle fixed point $p_0 \in B_0$. Let us define $W_0^{s/u}$ to be the connected component of $W^{s/u}(p_0) \cap B_0$ which contains p_0 . It follows that $W_0^{s/u} \in \mathcal{D}_{v/h}^1(B_0)$. Note that

$$W_0^u = \bigcap_{n \geq 0} f^n B_0, \quad W_0^s = \bigcap_{n \geq 0} f^{-n} B_0. \quad (2.8)$$

There is also a saddle point $p_1 \in B_1 \cap B_2$. We let W_1^u denote the component of $W^u(p_1) \cap B_1$ that contains p_1 . We show in Proposition 4.3 that if (\ddagger) holds, then it is a horizontal disk of degree 1.

Let us say that a sequence $I = i_0 i_1 \cdots i_n$ is *admissible* if $(i_k, i_{k+1}) \in \mathcal{G}$ for all k . We will sometimes also say that a sequence $J = j_0 j_1 \cdots j_m$ is admissible if $(j_k, j_{k+1}) \in \mathcal{G}^{-1}$ for all k . It will be clear from context whether we mean \mathcal{G} or \mathcal{G}^{-1} . For admissible sequences I (for \mathcal{G}) and J (for \mathcal{G}^{-1}), we use the notation

$$W_I^u = W_{i_0 i_1 \cdots i_n}^u = \tilde{f}_{i_{n-1} i_n} \tilde{f}_{i_{n-2} i_{n-1}} \cdots \tilde{f}_{i_0 i_1} (W_{i_0}^u) \quad (2.9)$$

$$W_J^s = W_{j_0 j_1 \cdots j_m}^s = \tilde{f}_{j_{n-1} j_n}^{-1} \tilde{f}_{j_{n-2} j_{n-1}}^{-1} \cdots \tilde{f}_{j_0 j_1}^{-1} (W_{j_0}^s). \quad (2.10)$$

It follows that $W_0^{s/u}$ are vertical/horizontal disks of degree 1 in B_0 , and W_{02}^s is a vertical disk of degree 1 in B_2 . By Proposition 2.6, W_{01}^u are vertical/horizontal disks of degree 1; and W_{012}^u is a horizontal disk of degree 2. This last statement includes two possibilities: W_{012}^u might consist of two disjoint disks of degree 1 or one disk on which π_v has degree 2. In either case, W_{012}^u intersects W_{02}^s in B_2 with multiplicity two, which means that either $W_{012}^u \cap W_{02}^s$ consists of two distinct points, or the intersection is tangential.

§3. Mappings of Real Boxes

Here we work under the additional condition that $f_{a,b}$ is a real mapping. In this section, we will restrict our attention to the real parameter region

$$\mathcal{A}_r := \mathcal{A} \cap \mathbf{R}^2.$$

Let τ be the involution of \mathbf{C}^2 defined by $\tau(x, y) = (\bar{x}, \bar{y})$. The fixed point set of τ is \mathbf{R}^2 . The condition that $a, b \in \mathbf{R}$ is equivalent to the condition that $f_{a,b}$ commutes with τ . We say that a set $S \subset \mathbf{C}^2$ is *real* if $\tau S = S$. For instance $\tau B_i = B_i$, so in this terminology B_i is real. Let $\mathcal{D}_{h/v,r}(B_i)$ denote the set of horizontal/vertical disks in $\mathcal{D}_{h/v}(B_i)$ which are real. If $(a, b) \in \mathcal{A}_r$, then Proposition 2.6 applies to real disks to yield

$$\tilde{f}_{12} : \mathcal{D}_{h,r}^m(B_i) \rightarrow \mathcal{D}_{h,r}^{2m}(B_j) \text{ and } \tilde{f}_{21}^{-1} : \mathcal{D}_{v,r}^m(B_j) \rightarrow \mathcal{D}_{v,r}^{2m}(B_i),$$

and

$$\tilde{f}_{ij} : \mathcal{D}_{h,r}^m(B_i) \rightarrow \mathcal{D}_{h,r}^m(B_j) \text{ and } \tilde{f}_{ji}^{-1} : \mathcal{D}_{v,r}^m(B_j) \rightarrow \mathcal{D}_{v,r}^m(B_i)$$

for $(i, j) \in \mathcal{G}$, $(i, j) \neq (1, 2)$.

We set $B_i^r := B_i \cap \mathbf{R}^2$, which is a rectangle in \mathbf{R}^2 with sides parallel to the axes.

Proposition 3.1. *If $V \in \mathcal{D}_{h,r}(B_i)$, then $V \cap B_{i,r}$ consists of a nonempty, connected, one-dimensional curve. In fact, there is a conformal uniformization $h : \Delta \rightarrow V$ such that $h(\bar{\zeta}) = \tau \circ h(\zeta)$.*

Proof. Let $\varphi : \Delta \rightarrow V$ be a conformal uniformization of V . It follows that $\kappa : \Delta \ni \zeta \mapsto \varphi^{-1} \circ \tau \circ \varphi(\zeta) \in \Delta$ is an anti-conformal involution of Δ . It follows that κ is an orientation-reversing isometry for the Poincaré metric, so the fixed point set $\gamma := \{\zeta \in \Delta : \kappa(\zeta) = \zeta\}$ is a Poincaré geodesic. Let ψ be a conformal automorphism of Δ which maps the real axis $(-1, 1) \subset \Delta$ to γ . It follows that $\psi^{-1} \circ \kappa \circ \psi$ is an isometric involution of Δ which fixes $(-1, 1)$, so it is simply the map $\zeta \mapsto \bar{\zeta}$. Thus $h = \varphi \circ \psi$ is the desired uniformization. \square

If f is a real map, then for $(i, j) \in \mathcal{G}$, f_{ij} is a crossed mapping of the pair (B_i^r, B_j^r) .

Proposition 3.2. *If $a, b \in \mathcal{A}_r$, then $B_{0,r} \cap fB_0$ lies below $B_{0,r} \cap fB_2$ inside $B_{0,r}$, and $B_{1,r} \cap fB_0$ lies below $B_{1,r} \cap fB_2$ inside $B_{1,r}$. In particular, let $I = 0i_1 \cdots i_n 00$ and $J = 0j_1 \cdots j_m 20$ be admissible sequences. Then W_I^u lies below W_J^u inside $B_{0,r}$. Similarly, if $K = 0k_1 \cdots k_n 01$ and $L = 0l_1 \cdots l_m 21$ are admissible sequences, then W_K^u lies below W_L^u inside $B_{1,r}$.*

Proof. The y -coordinate of f is $\pi_h \circ f = x$. Since B_0 lies to the left of B_2 , it follows that the y -coordinate of $fB_{0,r}$ is less than that of $fB_{2,r}$. Thus it lies below.

For the assertions about the pieces of unstable manifolds, we note that if I is a sequence that ends in ij , then $W_I^u \subset fB_i \cap B_j$. Thus for a sequence I which ends in 00 and a sequence J which ends in 20 , we will have $W_I^u \subset B_{0,r} \cap fB_0$ which lies below $W_J^u \subset B_{0,r} \cap fB_2$. \square

If $(i, j) \in \mathcal{G}$, $(i, j) \neq (1, 2)$, then the crossed mapping f_{ij} has degree 1. This means that real, horizontal curves in $B_{i,r}$ which run from left to right are taken to real, horizontal curves in $B_{j,r}$ which run either from left to right or from right to left. If the left-to-right direction is preserved, we assign the symbol $\epsilon_u = +$ to f . Otherwise, we set $\epsilon_u = -$. Similarly, real, vertical curves in $B_{j,r}$ which run from bottom to top are mapped under f^{-1} to real, vertical curves which either run from bottom to top or from top to bottom. If the run from bottom to top, then we assign the symbol $\epsilon_s = +$ to f . Otherwise, $\epsilon_s = -$.

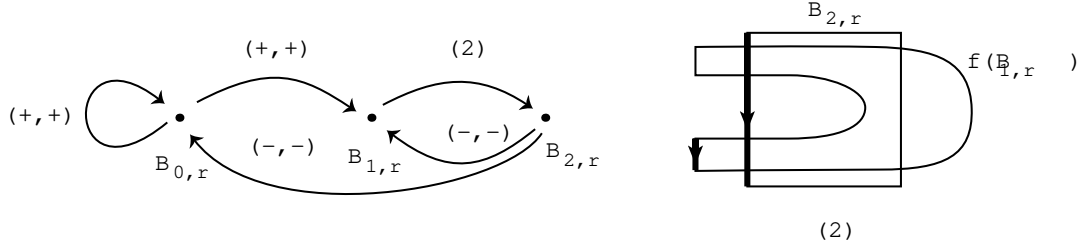

Figure 5: Graph induced by f (orientation-preserving)

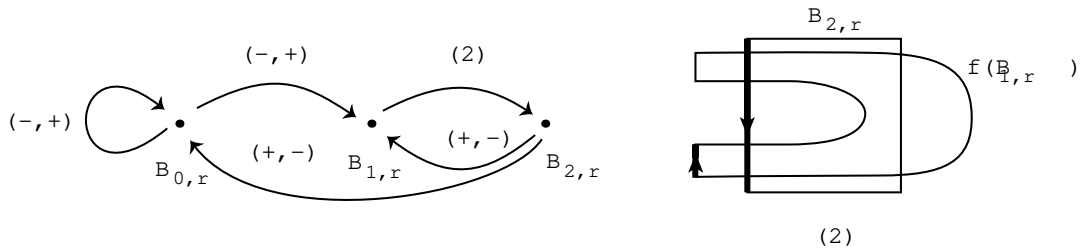

Figure 6: Graph induced by f (orientation-reversing)

Proposition 3.3. *If $a, b \in \mathcal{A}_r$, then the signs (ϵ_s, ϵ_u) are given as in Figures 5 and 6.*

Proof. First we consider the degenerate case $b = 0$. The map $a - x^2 = \pi_v \circ f_{a,0}(x, y)$ is increasing on $D_0 \cap \mathbf{R} = (-d, 0)$ and decreasing on $D_2 \cap \mathbf{R} = (0, d)$. Thus we have $\epsilon_u = +$ on $D_0 \cap \mathbf{R}$ and $\epsilon_u = -$ on $D_2 \cap \mathbf{R}$. This condition continues to hold for $b \neq 0$. Thus we have $\epsilon_u = +$ on D_0 and $\epsilon_u = -$ on D_2 . This continues to hold for $b \neq 0$, so the arrows of \mathcal{G} emanating from B_0 should be labeled $(\cdot, +)$, and the arrows emanating from B_2 should be labeled $(\cdot, -)$. In the orientation-preserving case, the only possible labels are $(+, +)$ and

$(-, -)$. In the orientation-reversing case, the only possible labels are $(+, -)$ and $(-, +)$. Thus we have the labeling shown in the graphs in Figures 5 and 6. \square

The crossed map f_{12} has degree 2 and is less easy to work with. The illustrations on the right hand sides of Figures 5 and 6 indicate its combinatorial behavior in the following sense. The left side of the vertical boundary of $B_{1,r}$ is $\{-c\} \times [-e, e]$, and the right side is $\{c\} \times [-e, e]$. In the degenerate case $b = 0$, $f_{a,0}$ maps the left boundary to the point $(a - c^2, -c)$ which is to the left of $B_{2,r}$; and the right boundary goes to $(a - c^2, c)$ which is directly above $(a - c^2, -c)$. If $b \neq 0$, then the image of the left boundary will continue to be to the left of $B_{2,r}$ and below the image of the right boundary. The use we make of this combinatorial/topological information is given in Proposition 3.4, whose proof is a straightforward consequence of the preceding discussion.

Proposition 3.4. *Suppose $a, b \in \mathcal{A}_r$. Suppose, too, that A_1 and A_2 are curves that cross $B_{1,r}$ from left to right and that A_1 lies below A_2 inside $B_{1,r}$. If f preserves orientation, then the curves $C_1 = \tilde{f}_{12}A_1$ and $C_2 = \tilde{f}_{12}A_2$ open to the left, and C_2 lies inside C_1 as illustrated in Figure 7. If f reverses orientation, then the relative positions of C_1 and C_2 are exchanged.*

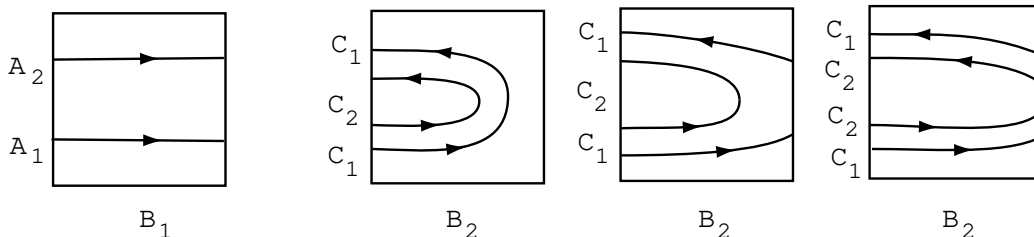

Figure 7: Curve C_2 lies inside C_1 : three possibilities.

In the sequel, we will work with parameter values in \mathcal{A}_r . However, for many of the arguments the essential point is that $(\mathcal{B}, \mathcal{G})$ is a system of crossed mappings with the “combinatorial” behavior given in Figures 5 and 6. Thus we are led to the following condition:

$(\mathcal{B}, \mathcal{G})$ is a family of real, crossed mappings, with the (†)
topological configurations shown in Figures 5, 6, and 7.

We may summarize the discussion above by the statement: *If $a, b \in \mathbf{R}$ and (†) holds, then (†) holds.* We also introduce the two conditions

$$\#(W_{02}^s \cap W_{012}^u \cap B_{2,r}) = 2 \text{ if } b > 0, \text{ and } \#(W_{02}^s \cap W_{12}^u \cap B_{2,r}) = 2 \text{ if } b < 0. \quad (*)$$

$$\#(W_{02}^s \cap W_{01212}^u \cap B_{2,r}) = 4 \text{ if } b > 0, \text{ and } \#(W_{02}^s \cap W_{12012}^u \cap B_{2,r}) = 4 \text{ if } b < 0. \quad (**)$$

Remark on notation. We have now defined a parameter domain \mathcal{A}_r as well as three conditions that may or may hold for a given parameter value (a, b) . The condition (†) requires the boxes \mathcal{B} to have specified behavior under f and f^{-1} . The conditions (*) and (**) define dynamical characteristics of $f_{a,b}$. It will be shown below that (†) holds for all parameters in \mathcal{A}_r and that (**) implies (*).

Proposition 3.5. *If (\dagger) holds, then $(**) \Rightarrow (*)$.*

Proof. We will treat only the case $b < 0$ since the case $b > 0$ is similar. Let us suppose that $(*)$ fails. We map W_1^u forward under \tilde{f}_{12} to W_{12}^u . By Proposition 3.1, $W_{12}^u \cap B_{2,r}$ is a nonempty, connected curve, and by Proposition 3.4 it forms a curve which opens to the left, which by hypothesis does not intersect W_{02}^s . This is pictured in the pair of boxes on the left hand side of Figure 8. Next we map W_{12}^u forward under \tilde{f}_{20} . Again by Proposition 3.1, $W_{120}^u \cap B_{0,r}$ is a nonempty, connected curve. Since the sign of f_{20} is $(\cdot, -)$, the x -direction of the curve is reversed, so $W_{120}^u \cap B_{0,r}$ opens to the right. By Proposition 3.2, W_{120}^u lies above $W_0^u = W_{00}^u$, which is drawn in gray as a visual aid to the reader, although it is not necessary for the proof. (The gray dot is p_0 , and W_1^u is above W_{01}^u in $B_{0,r}$ by Proposition 3.2.) Since the sign of f_{21} is $(+, \cdot)$, the vertical orientation is preserved, so W_{121}^u contains W_1^u as well as a curve below it. Since the sign of f_{20} is $(+, \cdot)$, the vertical orientation is preserved, so the upper part of W_{120}^u with a single hash mark is identified with W_1^u on the set $B_{0,r} \cap B_{1,r}$. Since $W_{02}^s \cap W_{12}^u = \emptyset$, W_{120}^u is disjoint from W_0^s , so we obtain the picture as in the right hand pair of boxes in Figure 8.

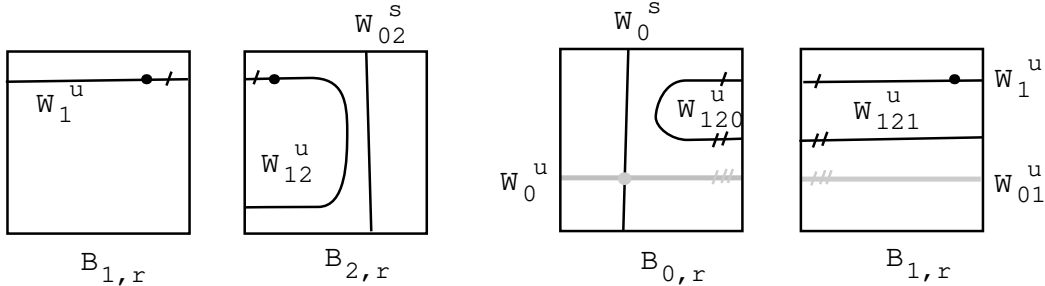

Figure 8

Next we map W_{120}^u forward under \tilde{f}_{01} . This is shown in the left hand picture of Figure 9. Since f_{01} has signature $(-, \cdot)$, the vertical orientation is reversed, so W_{1201}^u lies below W_{121}^u and W_{01}^u in $B_{1,r}$. Finally, we map forward under \tilde{f}_{12} and obtain the picture in the right hand box of Figure 9. The two arches of W_{12012}^u lie inside W_{12}^u by Proposition 3.4. Thus W_{12012}^u cannot intersect W_{02}^s , so condition $(**)$ does not hold. \square

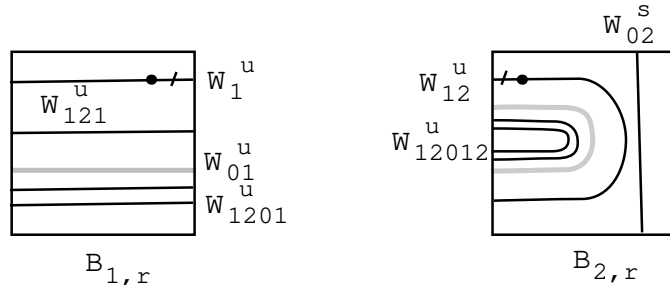

Figure 9

Figure 10 illustrates conditions $(*)$ and $(**)$ in the case $b > 0$. To understand Figure 10, start in the left hand box with W_0^u and W_0^s passing through the saddle point p_0 . We move W_0^u to box $B_{1,r}$ via the map \tilde{f}_{01} , and to box $B_{2,r}$ via \tilde{f}_{02} . The map f_{02} has degree

2, and $\tilde{f}_{02}W_{01}^u = W_{012}^u$ is a curve of degree 2 which opens to the left by Proposition 3.4. By condition (*), W_{012}^u crosses W_{02}^s . The crossed map f_{20} has degree 1 and sign $(\cdot, -)$, so the left-opening, degree two curve W_{012}^u produces a degree two curve $W_{0120}^u = \tilde{f}_{20}W_{012}^u$ in $B_{0,r}$ which opens to the right. Condition (*) maps forward under f_{20} , so W_{0120}^u intersects W_0^u .

The crossed map f_{21} has degree 1, so $\tilde{f}_{21}W_{012}^u = W_{0121}^u$ has degree 2 and by Proposition 3.2, it lies above W_{01}^u . Now $(\tilde{f}_{02} \cup \tilde{f}_{21})(W_{012}^u)$ is a curve in $B_0 \cup B_1$ of degree 2, and since $W_{0120}^u \cap B_{0,r}$ is connected, it follows that $W_{0121}^u \cap B_{1,r}$ consists of two curves of degree 1. By Proposition 3.1, then, it follows that the complex variety W_{0121}^u consists of two irreducible components. Now we map $W_{0121}^u \cap B_{1,r}$ under \tilde{f}_{12} , which has degree 2. By Proposition 3.4, $W_{01212}^u = \tilde{f}_{12}W_{0121}^u$ lies inside W_{012}^u . By (**), W_{01212}^u intersects W_{02}^s . Note that the arrangement of W_{01212}^u corresponds to one of the possibilities in Figure 7. Another possibility is given in the right hand of Figure 11. This picture is mapped forward under f_{20} , to show one possibility for W_{012120}^u inside $B_{0,r}$.

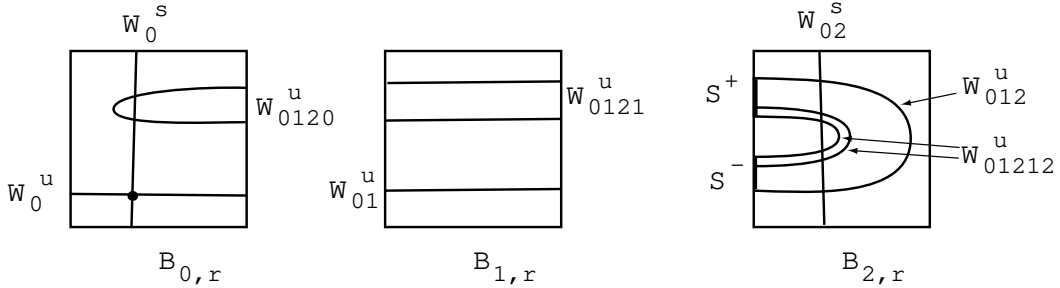

Figure 10: Moving W_0^u forward along the sequence 01212 (case $b > 0$)

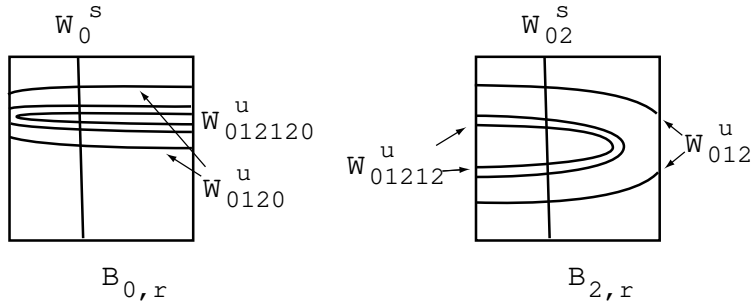

Figure 11: Alternative to Figure 10

Figure 12 deals with the orientation-reversing case and shows various unstable pieces W_I^u starting with W_1^u through p_1 and moving forward along the sequences $I = 1200, 1201,$ and 12012 . The construction of this picture was explained in large part in the proof of Proposition 3.5, so we do not repeat it here.

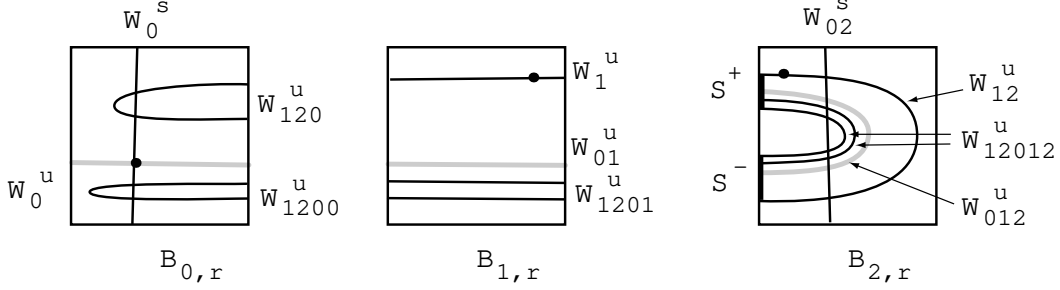

Figure 12: Moving W_1^u forward along the sequences 1200, 1201, and 12012 (case $b < 0$)

When $(**)$ holds, we use Figures 10 and 12 to define S^\pm as the closed subintervals of the left hand component of $\partial_v B_{2,r}$ which meet each component of $\overline{W}_{012}^u \cup \overline{W}_{01212}^u$ if $b > 0$ (resp. each component of $\overline{W}_{12}^u \cup \overline{W}_{12012}^u$ if $b < 0$).

Proposition 3.6. *Suppose that $b > 0$ and that (\dagger) and $(**)$ hold. Let I be an admissible sequence starting with 0 and ending with k , and let Γ be a connected component of W_I^u . Then we have the following:*

If $k = 0$, then: Γ is disjoint from the component of $B_{0,r} - W_0^u$ lying below W_0^u . If $\delta(\Gamma) \neq 1$, then $\delta(\Gamma) = 2$, and Γ intersects $W_0^s \cap B_{0,r}$, and $\overline{\Gamma}$ intersects the right hand component of $\partial_v B_{0,r}$ in two points.

If $k = 1$, then: $\delta(\Gamma) = 1$, and Γ is disjoint from the topmost and bottommost components of $B_{1,r} - (W_{01}^u \cup W_{0121}^u)$.

If $k = 2$, then: Γ is disjoint from the innermost and outermost components of $B_{2,r} - (W_{012}^u \cup W_{01212}^u)$. If $\delta(\Gamma) \neq 1$, then $\delta(\Gamma) = 2$, and $\overline{\Gamma}$ intersects both S^+ and S^- .

Proof. The proof proceeds by induction on the length of the sequence I . First, the case $I = 0$ is clear. Now we suppose that the Proposition holds for $I = I'i$. We will show that if $(i, j) \in \mathcal{G}$, then the Proposition holds for $I = I'ij$ by considering five cases.

Case $ij = 00$. Since f_{00} has sign $(+, \cdot)$, f_{00} maps the component of $B_{0,r} - W_0^u$ above W_0^u to itself. So $\tilde{f}_{00}\Gamma$ is disjoint from the component of $B_{0,r} - W_0^u$ below W_0^u . Now suppose $\delta(\Gamma) = 2$. f_{00} maps W_0^s into itself, and the sign of f_{00} is $(\cdot, +)$, so $\tilde{f}_{00}\Gamma$ intersects $W_0^s \cap B_{0,r}$, and $\overline{\Gamma}$ intersects the right hand component of $\partial_v B_{0,r}$ in two points.

Case $ij = 01$. By Proposition 3.2, $f_{01}(B_{0,r})$ lies below W_{0121}^u . On the other hand Γ is above W_0^u and f_{01} has sign $(+, \cdot)$, so $\tilde{f}_{01}\Gamma$ is above W_{01}^u in $B_{1,r}$. It remains to show that $\tilde{f}_{01}\Gamma$ consists of two components of degree 1. For this, we may assume that $\delta(\Gamma) = 2$, and $\Gamma \cap W_0^s \cap B_{0,r} \neq \emptyset$. Consider how $\gamma' = (\tilde{f}_{00} \cup \tilde{f}_{01})(B_{0,r} \cap \Gamma)$ maps across $B_{0,r} \cup B_{1,r}$: the left hand side of γ' intersects $W_0^s \cap B_{0,r}$ and the right hand side goes across the right hand boundary of $\partial_v B_{1,r}$. Thus $\gamma' \cap B_{1,r}$ consists of two curves. By Proposition 3.1, $\tilde{g}_{01}\Gamma \cap B_{0,1} = \gamma' \cap B_1$ consists of two disks of degree one.

Case $ij = 12$. This is a direct consequence of Proposition 3.4.

Cases $ij = 21$ and $ij = 20$. Let Γ be as in case $k = 2$. We may assume that $\delta(\Gamma) = 2$. Since f_{20} and f_{21} have sign $(\cdot, -)$, it follows that $\gamma' := (\tilde{f}_{20} \cup \tilde{f}_{21})\Gamma \cap (B_{0,r} \cup B_{1,r})$ is a 2-fold curve opening to the right. Since $\overline{\Gamma}$ intersects both S^+ and S^- , we have $\Gamma \cap W_{02}^s \cap B_{2,r} \neq \emptyset$, and it follows that $\gamma' \cap W_0^s \cap B_{0,r} \neq \emptyset$. By Proposition 3.2, γ' lies above W_0^u . This finishes the case $ij = 20$.

For the case $ij = 21$, we observe that γ' is a degree two real curve which crosses $W_0^s \cap B_{0,r}$ and opens to the right. Since $\bar{\Gamma}$ intersects both S^+ and S^- , and f_{21} has sign $(\cdot, -)$, it follows that $\bar{\gamma}'$ intersects the right hand boundary of $\partial_v B_{1,r}$ in two points. Thus $\gamma' \cap B_{1,r}$ consists of two real curves crossing $B_{1,r}$ horizontally. It follows from Proposition 3.1 that $\tilde{f}_{21}\Gamma$ consists of two components of degree one. \square

In the following, we let $B_{0,r}^+$ denote the right-hand component of $B_{0,r} - W_0^s$.

Proposition 3.7. *Suppose that $b < 0$, and that (\dagger) and $(**)$ hold. Let I be an admissible sequence starting with 1 and ending with k , and let Γ be a connected component of W_I^u . Then we have the following:*

If $k = 0$: Γ is disjoint from the topmost and bottommost components of $B_{0,r}^+ - (W_{120}^u \cup W_{1200}^u)$. If $\delta(\Gamma) \neq 1$, then $\delta(\Gamma) = 2$, and Γ intersects $W_0^s \cap B_{0,r}$, and $\bar{\Gamma}$ intersects the right hand component of $\partial_v B_{0,r}$ in two points.

If $k = 1$: $\delta(\Gamma) = 1$, and Γ is disjoint from the topmost and bottommost components of $B_{1,r} - (W_1^u \cup W_{1201}^u)$.

If $k = 2$: Γ is disjoint from the innermost and outermost components of $B_{2,r} - (W_{12}^u \cup W_{12012}^u)$. If $\delta(\gamma) \neq 1$, then $\delta(\Gamma) = 2$, and $\bar{\Gamma}$ intersects both S^+ and S^- .

Proof. This proof is analogous to the proof of Proposition 3.6; we omit the details. \square

Proposition 3.8. *Suppose that (\dagger) and $(**)$ hold. Let I be an admissible sequence of the form $I = 0i_1 \cdots i_n 2$ if $b > 0$ or $I = 1i_1 \cdots i_n 2$ if $b < 0$. Then for each component Γ of W_I^u , $\#(W_{02}^s \cap \Gamma \cap B_{0,r}) = \delta(\Gamma)$. In particular, if the intersection in the definition of $(**)$, is not tangential, then there is no tangency between W_0^s and W_I^u .*

Proof. This follows from the case $k = 2$ in Propositions 3.6 and 3.7. The only case to consider is $\delta(\Gamma) = 2$. Now if Γ is not one of the curves W_I^u in condition $(**)$, $\Gamma \cap B_{2,r}$ is trapped between an inner and an outer curve. Since its closure intersects both S^+ and S^- , it must cross W_{02}^s at least twice. These two intersections account for the total intersection number, and so these intersections must be simple (nontangential), and there can be no further intersections. \square

Proposition 3.9. *Suppose that (\dagger) and $(**)$ hold. Let I be an admissible sequence of the form $I = 0i_1 \cdots i_n 0$ if $b > 0$ or $I = 1i_1 \cdots i_n 0$ if $b < 0$. Then for each component Γ of W_I^u , $\#(W_0^s \cap \Gamma \cap B_{0,r}) = \delta(\Gamma)$. In particular, if the intersection in the definition of $(**)$, is not tangential, then there is no tangency between W_0^s and W_I^u .*

Proof. This follows by applying the map \tilde{f}_{20} , which has degree one, to the result of Proposition 3.8. \square

This allows us to characterize the mappings of maximal entropy.

Theorem 3.9. *Suppose that (\dagger) holds. If the real map $f_{a,b}$ has entropy equal to $\log 2$, then $(**)$ holds. Conversely, if $S \subset \{(a,b) \in \mathbf{R}^2 : b \neq 0\}$ is a connected set such that $(**)$ holds for all $(a,b) \in S$, and if f_{a_0,b_0} has entropy $\log 2$ for some $(a_0,b_0) \in S$, then $f_{a,b}$ has entropy $\log 2$ for all $(a,b) \in S$.*

Proof. The proof will be based on the following criterion from [BLS]: $f_{a,b}$ has (maximal) entropy $\log 2$ if and only if for all saddle points p and q , all (complex) intersection points of $W^s(p) \cap W^u(q)$ belong to \mathbf{R}^2 .

We suppose first that the entropy of $f_{a,b}$ is $\log 2$. If $b > 0$ we take $p = q = p_0$. By (2.7), $\delta(W_{02}^s) = 1$ and $\delta(W_{01212}^u) = 4$. If $b < 0$, we take $p = p_0$ and $q = p_1$. Again by (2.7), we have $\delta(W_{12012}^u) = 4$. By (2.6) we have $\#(W_{02}^s \cap \Gamma) = \delta(W_{02}^s)\delta(\Gamma) = 4$ with $\Gamma = W_{01212}^u$ if $b > 0$ and $\Gamma = W_{12012}^u$ if $b < 0$. By the criterion above, all (complex) intersections between W_{02}^s and Γ must belong to \mathbf{R}^2 , so it follows that (**) holds.

Now let us suppose that (**) holds for all $(a, b) \in S$. Consider the subset S_0 of points $(a, b) \in S$ such that the entropy of $f_{a,b}$ is equal to $\log 2$. Since $(a, b) \mapsto \text{entropy}(f_{a,b})$ is continuous, it follows S_0 is a closed subset of S . Since S is connected, it suffices to show that S_0 is an open subset of S . Let us fix a point $(a_0, b_0) \in S_0$. By Proposition 2.5 there is an open set $U_0 \subset \mathbf{C}^2$ such that $\overline{B}_{0,r} \cup \overline{B}_{1,r} \cup \overline{B}_{2,r} \subset U_0$, and

$$U_0 \cap f_{a,b}(B_0 \cup B_1 \cup B_2) \subset f_{a,b}(B_0 \cup B_2)$$

$$U_0 \cap f_{a,b}(B_0 \cup B_1 \cup B_2) \subset f_{a,b}(B_1)$$

holds for $(a, b) = (a_0, b_0)$. Thus it holds for (a, b) in a small neighborhood of (a_0, b_0) . Thus we also have that $K_{a_0, b_0} \subset \mathbf{R}^2$ since f_{a_0, b_0} has maximal entropy. By Proposition 2.1, then, $K_{a_0, b_0} \subset B_{0,r} \cup B_{1,r} \cup B_{2,r} \subset U_0$. Since $(a, b) \mapsto K_{a,b}$ is upper semicontinuous, it follows that for (a, b) sufficiently close to (a_0, b_0) we have $K_{a,b} \subset U_0$, and thus $f_{a,b}$ satisfies the hypotheses of Proposition 2.4.

Now we consider the case $b > 0$; the argument for the case $b < 0$ is similar and is omitted. Let $q \in W^s(p_0) \cap W^u(p_0)$ be any point of intersection. Replacing q by $f^{-m}q$ if necessary, we may assume that $q \in B_0$. Let I denote the admissible sequence given by Proposition 2.4. For n sufficiently large, we have $f^n q \in W_0^s$, which is a neighborhood of p_0 inside $W^s(p_0)$. Thus, writing $I(n) := i_0 i_1 \cdots i_n$, we have $f^n q \in W_{I(n)}^u$. By Proposition 3.8, it follows that $W_0^s \cap W_{I(n)}^u \subset \mathbf{R}^2$. Since $f^n q \in W_0^s \cap W_{I(n)}^u$, it follows that $q \in \mathbf{R}^2$. Thus $W^s(p_0) \cap W^u(p_0) \subset \mathbf{R}^2$, so that $f_{a,b}$ has entropy equal to $\log 2$. \square

Remark. There is an alternative approach to the ‘‘Conversely’’ part of this Theorem. Namely, we could use the arguments of this section to show that W_{02}^s and W_I^u have certain trellis properties, and then we can apply the work of P. Collins [Co] to conclude that the real map f has entropy $\log 2$.

§4. The Quadratic Horseshoe Locus

In this section we analyze the real, maximal entropy bifurcations in a neighborhood of (2,0).

Lemma 4.1. *Suppose that $(a, b) \in \mathcal{A}$, and suppose that $\Delta/3 \leq \delta \leq e^2 - 4 - 2\Delta$. If we define B'_0 and B'_2 by*

$$B'_0 := \{|x + 2| < \delta, |y| < e\}, \quad B'_2 := \{|x - 2| < \delta, |y| < e\}$$

then f induces crossed mappings from B'_0 to itself and from B'_0 to B'_2 . In particular, the sets W_0^s and W_{02}^s (as in (2.10)) are given by

$$W_0^s = \bigcap_{n \geq 0} f^{-n} B'_0, \quad \text{and} \quad W_{02}^s = \bigcap_{n \geq 1} B'_2 \cap f^{-n} B'_0.$$

Proof. Let us fix δ such that $\Delta/3 \leq \delta \leq e^2 - 4 - 2\Delta$ and set $B'_0 := \{|x+2| < \delta, |y| < e\}$. By the upper bound on δ , we have $\{|4-x^2| < \Delta + \delta\} \subset \{|x| < e\}$. We compute

$$\begin{aligned}
f^{-1}B'_0 \cap \{|y| < e\} &= \{|2 + \pi_v f(x, y)| < \delta, |\pi_h f(x, y)| < e, |y| < e\} \\
&\subset \{|2 + a - x^2 - by| < \delta, |x| < e, |y| < e\} \\
&\subset \{|4 - x^2| < |a - 2| + |by| + \delta, |x| < e\} \subset \{|4 - x^2| < \Delta + \delta, |x| < e\} \\
&\subset \{|2 - x| < \sqrt{4 + \Delta + \delta} - 2\} \cup \{|2 + x| < \sqrt{4 + \Delta + \delta} - 2\} \\
&\subset \{|2 - x| < \frac{\Delta + \delta}{4}\} \cup \{|2 + x| < \frac{\Delta + \delta}{4}\}.
\end{aligned}$$

In the next to last line we have removed the condition $|x| < e$ by the upper bound condition on δ . The last line uses the concavity of the square root. By the lower bound on δ , we have $(\Delta + \delta)/4 < \delta$, so it follows that $f^{-1}\overline{B'_0} \cap \partial_v B'_0 = \emptyset$.

Next we consider a point $(x', y') \in f^{-1}(\partial_h B'_0)$. By (?5),

$$\begin{aligned}
|y'| &= \left| \frac{1}{b}(a - y'^2 - x') \right| > \frac{e}{\Delta} (|y'|^2 - 4 - |a - 2| - |x' + 2|) \\
&> \frac{e}{\Delta} (e^2 - 4 - \Delta - \delta).
\end{aligned}$$

This last quantity is greater than e by the upper bound on δ , so $(x', y') \notin \overline{B'_0}$. Thus f induces a crossed mapping from B'_0 to itself. The proof that f induces a crossed mapping from B'_0 to B'_2 is the same \square

Corollary 4.2. *If $(a, b) \in \mathcal{A}$, then (*) holds.*

Proposition 4.3. *If $(a, b) \in \mathcal{A}$, then the horizontal disk W_1^u has degree one.*

Proof. Let $\Gamma \in \mathcal{D}_{h,r}^1(B_1)$ be any real, horizontal disk. Then by Proposition 3.4, $\tilde{f}_{12}\Gamma \in \mathcal{D}_{h,r}^2(B_2)$ is a real disk of degree two which opens to the left. Applying $(\tilde{f}_{20} \cup \tilde{f}_{21})$ to $\tilde{f}_{12}\Gamma$, we obtain a disk Γ' of degree two, which is horizontal in $B_0 \cup B_1$. There can be at most one critical point for the projection $\pi_v : \Gamma' \rightarrow B_0 \cup B_1$, and if there is a critical point, it must be real, since its conjugate is also a critical point.

Since the sign of $f_{20} \cup f_{21}$ is $(\cdot, -)$, Γ' opens to the right. By Proposition 3.1, $\tilde{f}_{20}\tilde{f}_{12}\Gamma = \Gamma' \cap B_0$ defines a nonempty real curve in $B_{0,r}$. Thus, if there is a critical point, then vertical projection $\pi_v : \Gamma \cap (B_{0,r} \cup B_{1,r}) \rightarrow (-d, c)$ has a critical point. Since (*) holds, this critical point must belong to $B_{0,r}$, and by (\ddagger), this point cannot belong to $B_{1,r}$. In particular, it follows that π_v has no critical point in $\tilde{f}_{12}\tilde{f}_{12}\Gamma = \Gamma' \cap B_1$. Thus $\Gamma' \cap B_1$ consists of two components. Since $p_1 \in B_1 \cap B_2$ is a fixed point, one of these components contains p_1 , and we denote this component by $(\tilde{f}_{21}\tilde{f}_{12})^\# \Gamma$, which is a disk of degree one.

Now if we choose Γ to pass through p_1 such that its tangent at p_1 is transverse to $W^s(p_1)$, then \cdot . It follows that $(\tilde{f}_{12}\tilde{f}_{21})^\# \Gamma$ is a sequence of horizontal disks of degree one, passing through p_1 , which converge to W_1^u as $n \rightarrow \infty$. \square

Now let us examine the case $b = 0$. The image of $f_{a,0}$ is the parabola

$$\Gamma := f_{a,0}(\mathbf{C}^2) = \{x = a - y^2\} = \{(p(t), t) : t \in \mathbf{C}\},$$

where $p(z) = a - z^2$. Throughout our discussion, we assume that $|a - 2| < \Delta$. Thus $a \notin D_0 \cup D_1$, and so there are two holomorphic branches of $p^{-1}(z) = \pm\sqrt{a - z}$ over $D_0 \cup D_1$. For $j = 0, 1$, $\Gamma \cap B_j$ consists of two components Γ'_j and Γ''_j , each of which is a smooth graph of a branch of p^{-1} . We note that $f_{a,0}$ is injective on each component Γ'_j and Γ''_j , $j = 0, 1$. On the other hand, $\Gamma \cap B_2$ is connected, and $f_{a,0}$ is two-to-one on $\Gamma \cap B_2$.

Let $p_0 = (t_0, t_0)$ denote the fixed point which belongs to B_0 . (The following discussion can be adapted to work with the other fixed point $p_1 \in B_1 \cap B_2$, as well.) Let $\varphi_a : \mathbf{C} \rightarrow \mathbf{C}$ denote the linearizing coordinate such that $\varphi_a(0) = t_0$, $\varphi'_a(0) = 1$, and $p(\varphi_a(\zeta)) = \varphi_a(\lambda\zeta)$, where $\lambda := p'(t_0)$. If we write $\varphi = \varphi_a$, it follows that

$$\psi_{a,0}(\zeta) := (\varphi(\zeta), \varphi(\lambda^{-1}\zeta))$$

defines a mapping $\psi_{a,0} : \mathbf{C} \rightarrow \Gamma$ which satisfies $f_{a,0} \circ \psi(\zeta) = \psi(\lambda\zeta)$.

We wish to define the sets W_I^u in the case $b = 0$. We let W_0^u be the connected component of $\Gamma \cap B_0$ containing p_0 ; W_{01}^u is the connected component of $\Gamma \cap B_1$ which intersects W_0^u ; and $W_{012}^u = \Gamma \cap B_2$. As we try to consider longer I , we run into the difficulty that the mappings \tilde{f}_{ij} are not invertible. To deal with this, we identify W_I^u in terms of the parametrization $\psi_{a,0}$ of Γ . To do this, let $\Omega_0 \subset \mathbf{C}$ be the connected component of $\psi_{a,0}^{-1}(W_0^u) = \varphi^{-1}(D_0)$ which contains the origin. In general, we set

$$\Omega_I := \lambda^n \Omega_0 \cap \varphi^{-n} D_{i_1} \cap \cdots \cap \varphi^{-n} (D_{i_n}) = \lambda^n \Omega_0 \cap \psi_{a,0}^{-n} B_{i_1} \cap \cdots \cap \psi_{a,0}^{-n} (B_{i_n}), \quad (4.1)$$

where $I = 0i_1 \cdots i_n$ is an admissible sequence. We then identify W_I^u in terms of the map $\psi_{a,0} : \Omega_I \rightarrow W_I^u$.

The usefulness of the case $b = 0$ is that it is the limit of the case $b \neq 0$. When $b \neq 0$, we let $\psi_{a,b} : \mathbf{C} \rightarrow W_{p_0}^u$ be the uniformization of $W^u(p_0)$, normalized by the condition $(\pi_v \circ \psi_{a,b})'(0) = 1$. In this case, $(a, b, \zeta) \mapsto \psi_{a,b}(\zeta)$ is holomorphic, and we have

$$\lim_{b \rightarrow 0} \psi_{a,b} = \psi_{a,0}, \quad (4.2)$$

with uniform convergence on compact subsets. Restricting this to the image of Ω_I , we have:

$$\lim_{b \rightarrow 0} W_I^u(f_{a,b}) = W_I^u(f_{a,0}), \quad (4.3)$$

where the convergence is in the sense of the Hausdorff topology. Taking multiplicities of $W_I^{s/u}(f_{a,0})$ into account, the convergence also holds in the sense of currents.

Lemma 4.4. *If $|a - 2| < \Delta$, then for $I = 01212$ and $I = 12012$, Ω_I consists of two connected components with disjoint closures. If $b \neq 0$ is sufficiently small, then W_I^u consists of two components.*

Proof. Since $p : D_0 \rightarrow p(D_0)$ is a conformal equivalence, and $p^{-1}D_0 \subset D_0$, we may define a holomorphic map $\lim_{n \rightarrow \infty} \lambda^n p^{-n} : p(D_0) \rightarrow \mathbf{C}$. This is the inverse of φ , and so $\varphi : \lambda\Omega_0 \rightarrow p(D_0)$ is univalent. Thus $\Omega_{01} = \Omega_0 \cap \varphi^{-1}(D_1)$ is connected and relatively compact in Ω_0 . Let c_{01} be the unique point of $\lambda\Omega_0$ such that $\varphi(c_{01}) = 0$. It follows that $\varphi'(\lambda c_{01}) = (p \circ \varphi(c_{01}))' = p'(0)\varphi'(c_0) = 0$. Conversely, if $\zeta \in \lambda^2\Omega_0$, and if $0 =$

$\varphi'(\zeta) = p'(\varphi(\lambda^{-1}\zeta))\varphi'(\lambda^{-1}\zeta)\lambda^{-1}$, then we must have $p'(\varphi(\lambda^{-1}\zeta)) = 0$ since $\varphi' \neq 0$ on $\lambda\Omega_0$. It follows that $\zeta = \lambda c_{01}$, so λc_{01} is the unique critical point in $\lambda^2\Omega_0$. It follows that $\psi_{a,0}(\zeta) = (\varphi(\zeta), \varphi(\lambda^{-1}\zeta))$ has no critical point on $\lambda^2\Omega_0$. Since $\psi_{a,0}(\Omega_{012}) = \Gamma \cap B_2$ is simply connected, it follows that $\psi_{a,0} : \Omega_{012} \rightarrow \Gamma \cap B_2$ is univalent. By the argument above, $\lambda^2 c_{01}$ is the unique critical point for $\psi_{a,0}$ in $\lambda^3\Omega_0$. Now $\psi_{a,0}(\lambda^2 c_{01}) = f_{a,0}(a, 0) = (a - a^2, a)$, which does not belong to B_1 , since $\Re(a - a^2) < -c$. It follows that $\psi_{a,0}$ is unbranched on the closure of $\lambda^3\Omega_0 \cap \psi_{a,0}^{-1}(B_1)$. Recall that $f_{a,0} : W_{012}^u = \Gamma \cap B_2 \rightarrow f_{a,0}(W_{012}^u)$ is a mapping of degree two. Thus W_{0121}^u is the component of $\Gamma \cap B_1$ which is disjoint from W_{01}^u , and W_{0121}^u has multiplicity two. It follows that $\psi_{a,0} : \Omega_{0121} \rightarrow W_{0121}^u$ is a covering of degree two. Since $\psi_{a,0}$ is unbranched on the closure of $\Omega_{0121} \subset \lambda^3 \cap \psi_{a,0}^{-1}(B_1)$, it follows that Ω_{0121} consists of two components with disjoint closures.

Let us move forward one more step: since $f_{a,0}$ is injective on W_{0121}^u , it follows that $\psi_{a,0}$ gives a conformal equivalence between each component of $\lambda\Omega_{0121}$ and $f_{a,0}W_{0121}^u$. Intersecting $\lambda\Omega_{0121}$ with $\psi_{a,0}^{-1}(B_2 \cap f_{a,0}(W_{0121}^u)) = \psi_{a,0}^{-1}(B_2 \cap \Gamma) = \varphi^{-1}(D_2)$, then Ω_I consists of two components Ω'_I and Ω''_I which have disjoint closures. If $b \neq 0$ is sufficiently small, then $\psi_{a,b}^{-1}(W_I^u)$ will be close to Ω_I . Thus it (as well as W_I^u) has two components. \square

Now we pass from unstable manifolds to stable manifolds. The vertical complex line through the fixed point p_0 is mapped to p_0 under $f_{a,0}$. If we write $p_0 = (t_0, t_0)$, then

$$W_0^s = \{(x, y) : x = t_0, |y| < e\}, \text{ and } W_{02}^s = \{(x, y) : x = t'_0, |y| < e\},$$

where $t'_0 \in \mathbf{C}$ is the solution to $p(t'_0) = t_0$ such that $t'_0 \neq t_0$. If (\ddagger) holds, then

$$W_{02}^s \cap \Gamma = \{(\zeta, \pm\sqrt{a - \zeta}) : \zeta = t'_0\}. \quad (4.4)$$

This intersection consists of two distinct points unless $t'_0 = a$, which happens exactly when $a = 2$. We can work our way backwards, taking successive preimages, to define $W_J^s(f_{a,0})$ for an admissible sequence J . As in the case of unstable manifolds, we have

$$\lim_{b \rightarrow 0} W_J^s(f_{a,b}) = W_J^s(f_{a,0}). \quad (4.5)$$

Proposition 4.5. *Suppose that $(a, b) \in \mathcal{A}$ and $|a - 2| \geq (e + \Delta)|b|$. Then for $I = 01212$ and $I = 12012$, W_{02}^s intersects W_I^u in four distinct points, and thus the intersection is not tangential.*

Proof. We begin by noting

$$W_I^u \subset B_2 \cap fB_0 \subset \{|b^{-1}(a - x - y^2)| < \delta, |y| < e\}.$$

If we set $\delta = \Delta/3$, then by Lemma 3.5 we have

$$W_{02}^s \subset B'_2 \subset \{|x - 2| < \frac{\Delta + \delta}{4}, |y| < e\}.$$

Thus

$$\begin{aligned}
W_{02}^s \cap W_I^u &\subset \{|x-2| < \frac{\Delta+\delta}{4}, |a-x-y^2| < \delta|b|\} \\
&\subset \{|x-2| < \frac{\Delta+\delta}{4}, |a-2-y^2| < |b|\delta + |x-2|\} \\
&\subset \{|a-2-y^2| < |b|\delta + \frac{\Delta+\delta}{4}\} \\
&=: U_{a,b}.
\end{aligned}$$

The set $U_{a,b}$ is symmetric with respect to $y \mapsto -y$ and is seen to be disconnected if (and only if) it does not contain $y = 0$. This occurs exactly when $|a-2| \geq |b|\delta + \frac{\Delta+\delta}{4}$. Now we recall that $\delta = \Delta/3$ and substitute the condition (\ddagger) , which gives $|a-2| \geq |b|\Delta/3 + \Delta/3 \geq |b|\Delta/3 + (|a-2| + e|b|)/3$, and this is equivalent to $|a-2| \geq (\Delta+e)|b|$.

Now consider the case $b = 0$. By Lemma 4.4, Ω_I consists of components Ω'_I and Ω''_I . Since $a \neq 2$, the intersection (4.4) contains two points, which lie in different components of $U_{a,b}$. Thus $\psi_{a,0}(\Omega'_I)$ and $\psi_{a,0}(\Omega''_I)$ each intersect W_{02}^s in two points, which lie in different components of $U_{a,0}$. If $b \neq 0$, $|a-2| \geq (e+\Delta)|b|$, then W_I^u consists of two components $(W_I^u)' = \psi_{a,b}(\Omega'_I(a,b))$ and $(W_I^u)'' = \psi_{a,b}(\Omega''_I(a,b))$. Further, the set $U_{a,b}$ continues to be disconnected, and by (4.3) the each component of $U_{a,b}$ will continue to contain a point of $W_{02}^s \cap W_I^{u'}$. Since $\delta(W_I^u)' = 2$ and $W_{02}^s \cap (W_I^u)'$ contains two distinct points, the intersection is not tangential. A similar argument for $(W_I^u)'' \cap W_{02}^s$ shows that $W_{02}^s \cap W_I^u$ has no tangency. \square

Let us define

$$\begin{aligned}
\mathcal{D} &:= \{(a,b) \in \mathbf{C}^2 : |a-2| < .237186, |b| < .08205\} \\
T_I &:= \{(a,b) \in \mathcal{D} : W_{02}^s \text{ intersects } W_I^u \text{ tangentially}\}.
\end{aligned}$$

In the definition of T_I , we interpret the case $b = 0$ as follows. By §1, we know that $T_I \cap \{b \neq 0\}$ is a complex subvariety of $\mathcal{D} - \{b \neq 0\}$. By (4.5) and (4.2), we have that $(T_I \cap \{b \neq 0\}) \cup (2,0)$ is the closure of $T_I \cap \{b \neq 0\}$ in \mathcal{D} . With this interpretation, T_I is a complex subvariety of \mathcal{D} .

Proposition 4.6. *For $I = 01212$ and 12012 , T_I is a complex subvariety of \mathcal{D} with the following properties:*

- (i) *The projection $\pi_h : T_I \rightarrow \{|b| < .08205\}$ is a proper mapping of degree two.*
- (ii) *T_I is locally reducible at $(2,0)$.*
- (iii) *There are real analytic functions $\kappa_I^\pm : [-.08205, .08205] \rightarrow \mathbf{R}$ with $\kappa_I^-(t) < \kappa_I^+(t)$ for $t > 0$ such that $T_I \cap \mathbf{R}^2$ is the union of the graphs of κ_I^+ and κ_I^- .*

Proof. Note that with our values of e and Δ , (\ddagger) holds for $(a,b) \in \mathcal{D}$ whenever $b \neq 0$. Further, the condition $|a-2| \geq (e+\Delta)|b|$ holds for $(a,b) \in \partial_v \mathcal{D}$. By Proposition 4.5, then, $\overline{T_I} \cap \partial_v \mathcal{D} = \emptyset$. Thus π_h is a proper mapping. To determine the multiplicity of π_h , it suffices to determine the multiplicity at $b = 0$. If $b = 0$, then the only tangency occurs at $a = 2$. Now $W_I^u = \Gamma \cap B_2$, with multiplicity two, so in case $a = 0$, W_{02}^s makes a tangential intersection with each component of W_I^u . It follows that $T_I \cap \{b = 0\} = \{(2,0)\}$, with multiplicity two. Thus π_h has multiplicity two.

For (ii), let $b = 0$. By Lemma 4.4, Ω_I consists of components Ω'_I and Ω''_I which have disjoint closures. Thus, for $b \neq 0$ small, there are domains $\Omega'_I(a, b)$ and $\Omega''_I(a, b)$ which are mapped under $\psi_{a,b}$ to the two components of W_I^u . Thus for $|b| < r_0$ small, we may split T_I into $T'_I = \{(a, b) \in \mathcal{D} : |b| < r_0, W_{02}^s \text{ intersects } W_I^u(a, b)' \text{ tangentially}\}$, and a similar set T''_I for $W_I^u(a, b)''$.

Now we consider the projection $\pi_h : T_I \cap \mathbf{R}^2 \rightarrow (-.08205, .08205)$. This is a proper mapping of degree two. Consider a point $(a, b) \in T_I \cap \mathbf{R}^2$ with $b < 0$ and suppose that $I = 12012$. We may repeat the argument of Proposition 3.5 to conclude that W_{12012}^u consists of two curves in $B_{2,r}$ which open to the left. By γ' and γ'' we denote the components of W_{12012}^u such that $\gamma' \cap B_{2,r}$ forms the inner curve, and $\gamma'' \cap B_{2,r}$ forms the outer curve.

Let us note at the outset that $\delta(\gamma') = \delta(\gamma'') = 2$, and so $\#(W_{02}^s \cap \gamma') = \#(W_{02}^s \cap \gamma'') = 2$. If there is a tangency between γ' and W_{02}^s , then the tangency must be real. For otherwise, if there were a point of tangency $q \in B_2 - B_{2,r}$, the complex conjugate \bar{q} would also be a point of tangency, so the total intersection of γ' and W_{02}^s in B_2 would be at least four.

Now suppose that the outer curve γ'' is tangential to W_{02}^s . Then this point of tangency must have order two, and can be the only intersection with W_{02}^s since the total intersection satisfies $\#(W_{02}^s \cap W_{12012}^u) = 2$. Since $\gamma'' \cap B_{2,r}$ opens to the left, it follows that $\gamma'' \cap B_{2,r}$ must lie to the left of W_{02}^s . Thus γ' cannot intersect $W_{02}^s \cap B_{2,r}$. Thus there can be no tangency between the complex disks W_{02}^s and γ' .

Thus in the case $b \neq 0$, with a and b both real, there cannot be tangencies (necessarily real) between both components of W_I^u and W_{02}^s . In other words, if $(a, b) \in T'_I \cap \mathbf{R}^2$, $b \neq 0$, then $(a, b) \notin T''_I \cap \mathbf{R}^2$. This gives a splitting of T_I into two components in a neighborhood of $\pi_h^{-1}(-.08205, .08205)$. Since π_h has degree one on $T'_I \cap \mathbf{R}^2$ and $T''_I \cap \mathbf{R}^2$ these sets are given as the graphs of real analytic functions. \square

Let us set

$$\kappa(t) := \max(\kappa_{01212}^+(t), \kappa_{12012}^-(t)).$$

Corollary 4.7. $\{(a, b) \in \mathcal{D} \cap \mathbf{R}^2 : b \neq 0, (**) \text{ holds}\} = \{(a, b) \in \mathcal{D} \cap \mathbf{R}^2 : b \neq 0, a \geq \kappa(b)\}$.

Proof. We consider only the case $b > 0$; the other case is similar. For $I = 01212$, set $T_I^\pm := \{a = \kappa_{01212}^\pm(b)\}$. Thus $T_I \cap \mathbf{R}^2 = T_I^+ \cup T_I^-$. As was noted in the proof of Proposition 7.7, T_I^- is the set of parameters for which one component of W_I^u is tangent to W_{02}^s , and the other component is disjoint from W_{02}^s . T_I^+ is the set of parameters for which one component of W_I^u is tangential to W_{02}^s , and the other component intersects W_{02}^s in two points. \square

Let us write

$$\mathcal{E} := \{(a, b) \in \mathbf{R}^2 : f_{a,b} \text{ has entropy} < \log 2\}$$

$$\mathcal{H} := \{(a, b) \in \mathbf{R}^2 : f_{a,b} \text{ is a real horseshoe}\}$$

Theorem 4.8.

$$\mathcal{H} \cap \mathcal{D} = \{(a, b) \in \mathcal{D} \cap \mathbf{R}^2 : a > \kappa(b), b \neq 0\},$$

$$\mathcal{E} \cap \mathcal{D} = \{(a, b) \in \mathcal{D} \cap \mathbf{R}^2 : a < \kappa(b), b \neq 0\}.$$

Proof. By Theorem 3.9 and Corollary 4.7, the set of parameters $(a, b) \in \mathcal{D} \cap \mathbf{R}^2$ for which the entropy is $\log 2$ is exactly the set $\{a \geq \kappa(b)\}$. On the other hand, if $a > \kappa(b)$, then by Proposition 3.8 there is no tangency. Since f has maximal entropy, it follows from [BS1] that f is hyperbolic. Now $\mathcal{D} \cap \mathbf{R}^2 \cap \{a > \kappa(b)\}$ is a connected set of parameters for which $f_{a,b}$ is hyperbolic. By Theorem 1.1, this set contains parameters for which $f_{a,b}$ is a real horseshoe. It follows, then, from the structural stability of hyperbolic maps that all of these maps are horseshoes. \square

§5. Generic Unfolding

In Theorem 5.2 we establish the “generic unfolding” statement in Theorem 2. Let us fix $I = 01212$ or $I = 12012$. In §4 we saw that for $(a, b) \in \mathcal{D}$, $b \neq 0$, the set W_I^u is disconnected and may be split into

$$W_I^u(a, b) = W_I^u(a, b)' \cup W_I^u(a, b)'' \quad (5.1)$$

Further we saw that if $(a_0, b_0) \in \mathcal{D} \cap \mathbf{R}^2 \cap \partial\mathcal{H}$, then one of these components, say $W_I^u(a_0, b_0)'$, has a quadratic tangency with $W_{02}^s(a_0, b_0)$. This splitting may be done for all $(a, b) \in \mathcal{D} \cap \mathbf{R}^2$ in such a way that we obtain a continuous family

$$\mathcal{D} \cap \mathbf{R}^2 \ni (a, b) \mapsto W_I^u(a, b)'.$$

The horizontal projection $\pi_h(x, y) = y$, establishes a conformal equivalence

$$\pi_h : W_{02}^s(a, b) \rightarrow \{|y| < e\}.$$

For $(a, b) \in \mathcal{D}$, $b \neq 0$, we define the function

$$h(a, b) = \prod_{i \neq j} (\pi_h(p_i) - \pi_h(p_j))$$

where the p_i and p_j in the product range over the four points of intersection $W_{02}^s(a, b) \cap W_I^u(a, b)$. Since $\pi_h|_{W_{02}^s(a, b)}$ is invertible, we see that $h(a, b) \neq 0$ if and only if there are four distinct points of intersection. Thus $h(a, b) \neq 0$ means that the multiplicities of all four intersections are 1, and thus all four intersections are transverse. As in §4 we may extend the definition of h to the case $b = 0$, and we see that h is analytic in \mathcal{D} .

Theorem 5.1. *For $(a, b) \in \mathcal{D} \cap \mathbf{R}^2 \cap T_I$ with $b \neq 0$, we have $\frac{\partial h}{\partial a} \neq 0$.*

Proof. If $b = 0$, then by the discussion in §4, we see that $a \mapsto h(a, 0)$ has a zero of order 2 at $a = 2$, and $h(a, 0) \neq 0$ for $\{0 < |a - 2| < .237186\}$.

By Theorem 4.5, none of the tangencies T_I occur on the vertical boundary of \mathcal{D} . Thus $h \neq 0$ there. It follows that for each fixed value $|b_0| \leq .08$, the function

$$\{|a - 2| < .237186\} \ni a \mapsto h(a, b_0)$$

is analytic and has exactly two zeros (counted with multiplicity). One zero corresponds to a point $(a', b_0) \in T_I'$ and one corresponds to $(a'', b_0) \in T_I''$. We have seen that $T_I' \cap \mathcal{D} \cap \mathbf{R}^2 \cap \{b \neq 0\}$ is disjoint from $T_I'' \cap \mathcal{D} \cap \mathbf{R}^2 \cap \{b \neq 0\}$. Since the total multiplicity is 2, each of these zeros must be a simple zero. In particular, we conclude that $\frac{\partial h}{\partial z}(a, b) \neq 0$ for $(a, b) \in T_I \cap \mathcal{D} \cap \mathbf{R}^2 \cap \{b \neq 0\}$. \square

Let us discuss this situation further. We will consider a sequence of holomorphic coordinate changes $(x', y') = (x'(x, y), y'(x, y))$ which in addition depend holomorphically on the parameter (a, b) . First, we may change coordinates so that $W_{02}^s(a, b) = \{x = 0\}$ since $W_{02}^s(a, b)$ has degree one in B_2 . Now let us split $W_I^u(a, b)$ as in (5.1). We will show that we may introduce coordinates such that we have

$$W_{02}^s = \{x = 0\} \quad \text{and} \quad W_I^u(a, b) = \{x = c_0(a, b) + y^2\}. \quad (5.2)$$

The *generic unfolding* condition is that $\partial c_0(a, b)/\partial a \neq 0$ for $a = a_b$ (see [PT, page 35]).

Now let us fix $b_0 \in (-.08, .08)$, $b_0 \neq 0$, and set $a_0 = a_{b_0}$. Thus we have

$$W_I^u(a_0, b_0)' = \{x = \sum_{j=2}^{\infty} c_j(y - y_0)^j\},$$

where $(0, y_0)$ is the point of tangential intersection, and so $c_0 = c_1 = 0$. The coefficient c_2 is nonzero because the intersection is quadratic (see [BS1]). Without loss of generality we may assume that $y_0 = 0$. Now for (a, b) near (a_0, b_0) , we have

$$W_I^u(a, b)' = \{x = c_0(a, b) + c_1(a, b)y + c_2(a, b)y^2 + \dots\}.$$

Now since $c_2(a, b) \neq 0$ and $c_0(a_0, b_0) = c_1(a_0, b_0) = 0$, we may solve $\tilde{y} = \tilde{y}(a, b) \sim -c_1/(2c_2)$ such that

$$\frac{\partial x}{\partial y} = c_1(a, b) + 2c_2(a, b)\tilde{y} + \dots = 0.$$

Replacing y by $y - \tilde{y}$, we have

$$W_I^u(a, b)' = \{x = \tilde{c}_0(a, b) + \tilde{c}_2(a, b)y^2 + \dots\}.$$

Finally, since $\tilde{c}_2 \neq 0$, we may change coordinates $y' = \sigma(a, b)y$ to obtain (5.2).

Now we consider the function $h(a, b)$ in the coordinates (x, y) . We have $W_{02}^s(a, b) \cap W_I^u(a, b)' = \{(0, \pm\sqrt{-\tilde{c}_0(a, b)})\}$. Since $W_I^u(a, b)' \cap W_I^u(a, b)'' = \emptyset$, and $W_I^u(a, b)''$ has no tangency for (a, b) near (a_0, b_0) , we have

$$h(a, b) = -(\sqrt{-\tilde{c}_0(a, b)} + \sqrt{-\tilde{c}_0(a, b)})^2 \alpha(a, b) = 2\tilde{c}_0(a, b)\alpha(a, b)$$

where α is a nonvanishing analytic function. Since $\tilde{c}_0(a_0, b_0) = 0$, we have

$$\frac{\partial h}{\partial a}(a, b_0) = \frac{\partial \tilde{c}_0}{\partial a}(a, b_0) \cdot \alpha(a, b_0)$$

for $a = a_0$. By Theorem 5.1, then, $\partial \tilde{c}_0(a_0, b_0)/\partial a \neq 0$. Thus we have:

Theorem 5.2. $(a, b) \mapsto (W_{02}^s(a, b), W_I^u(a, b))$ is a generic unfolding of a tangency at the parameter value (a_0, b_0) .

References

- [BLS] E. Bedford, M. Lyubich, and J. Smillie, Polynomial diffeomorphisms of \mathbf{C}^2 . IV: The measure of maximal entropy and laminar currents, *Invent. Math.* 112, 77–125 (1993).
- [BS8] E. Bedford and J. Smillie, Polynomial diffeomorphisms of \mathbf{C}^2 . VIII: Quasi-expansion. *American J. of Math.*, 124, 221–271, (2002).
- [BS1] E. Bedford and J. Smillie, Real polynomial diffeomorphisms with maximal entropy: Tangencies. *Annals of Math.*, to appear.
- [BS3] E. Bedford and J. Smillie, A new approach to the analysis of analytic diffeomorphisms, in preparation.
- [Co] P. Collins, Dynamics forced by surface trellises. *Geometry and topology in dynamics (Winston-Salem, NC, 1998/San Antonio, TX, 1999)*, 65–86, *Contemp. Math.*, 246, Amer. Math. Soc., Providence, RI, 1999.
- [DN] R. Devaney and Z. Nitecki, Shift automorphisms in the Hénon family, *Comm. Math. Phys.* 67, 137–48, 1979.
- [FG1] J-E Fornæss and E. Gavosto, Existence of generic homoclinic tangencies for Hénon mappings, *J. Geom. Anal.*, 2:5 (1992), 429–444.
- [FG2] J-E Fornæss and E. Gavosto, Tangencies for real and complex Hénon maps: An analytic method, *Experimental Math.*, Vol. 8 (1999), No. 3, 253–260.
- [HO] J.H. Hubbard and R. Oberste-Vorth, Hénon mappings in the complex domain II: Projective and inductive limits of polynomials, in: *Real and Complex Dynamical Systems*, B. Branner and P. Hjorth, eds. 89–132 (1995).
- [KKY] Kan, Ittai; Kocak, Huseyin; Yorke, James A. Antimonotonicity: concurrent creation and annihilation of periodic orbits. *Ann. of Math.* (2) 136 (1992), no. 2, 219–252.
- [MNTU] S. Morosawa, Y. Nishimura, M. Taniguchi, and T. Ueda, *Holomorphic Dynamics*, Cambridge U. Press, 2000.
- [O] R. Oberste-Vorth, Complex horseshoes and the dynamics of mappings of two complex variables, Ph.D dissertation, Cornell Univ., Ithaca, NY, 1987.
- [MT] J. Milnor and W. Thurston, On iterated maps of the interval. *Dynamical systems (College Park, MD, 1986–87)*, 465–563, *Lecture Notes in Math.*, 1342, Springer, Berlin, 1988.
- [PT] J. Palis and F. Takens, *Hyperbolicity and sensitive chaotic dynamics at homoclinic bifurcations. Fractal dimensions and infinitely many attractors.* Cambridge Studies in Advanced Mathematics, 35. Cambridge University Press, Cambridge, 1993.

Eric Bedford
Indiana University
Bloomington, IN 47405

John Smillie
Cornell University
Ithaca, NY 14853