

# Haruspicy 2: The anisotropic generating function of self-avoiding polygons is not D-finite

Andrew Rechnitzer

Department of Mathematics and Statistics,  
The University of Melbourne, Parkville Victoria 3010, Australia.  
email: A.Rechnitzer@ms.unimelb.edu.au

October 16, 2018

## Abstract

We prove that the anisotropic generating function of self-avoiding polygons is not a D-finite function — proving a conjecture of Guttmann and Enting [7, 8]. This result is also generalised to self-avoiding polygons on hypercubic lattices. Using the haruspicy techniques developed in an earlier paper [17], we are also able to prove the form of the coefficients of the anisotropic generating function, which was first conjectured in [8].

## 1 Introduction

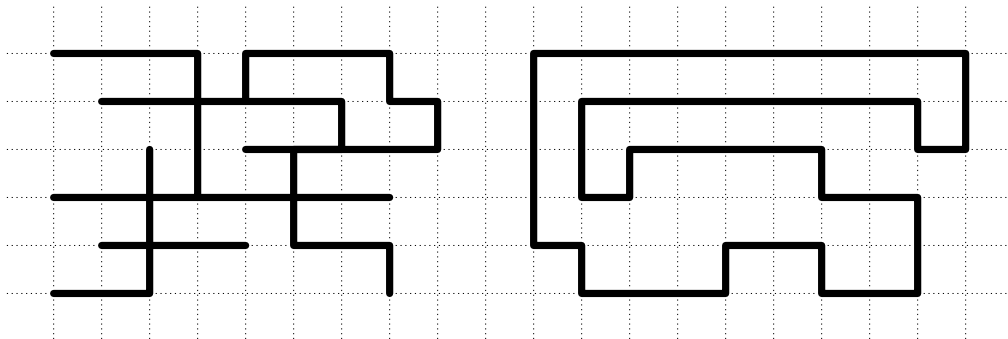

Figure 1: A square lattice bond animal (left) and a self-avoiding polygon (right).

Lattice models of magnets and polymers in statistical physics lead naturally to questions about the combinatorial objects that form their basis — *lattice animals*. Despite intensive study these

objects, and the lattice models from which they arise, have tenaciously resisted rigorous analysis and much of what we know is the result of numerical studies and “not entirely rigorous” results from conformal field theory.

Recently, Guttmann and Enting [7, 8] suggested a numerical procedure for testing the “solvability” of lattice models based on the study of the singularities of their *anisotropic generating functions*. The application of this test provides compelling evidence that the solutions of many of these models do not lie inside the class of functions that includes the most common functions of mathematical physics, namely *differentiably-finite* or *D-finite* functions (defined below). The main result of this paper is to sharpen this numerical evidence into proof for a particular model — *self-avoiding polygons*.

Let us now define some of the terms we have used above. A *bond animal* is a connected union of edges, or *bonds*, on the square lattice. The set,  $\mathcal{P}$ , of square lattice *self-avoiding polygons*, or SAPs, is the set of all bond animals in which every vertex has degree 2. Equivalently it is the set of all bond animals that are the embeddings of a simple closed loop into the square lattice (see Figure 1). Self-avoiding polygons were introduced in 1956 by Temperley [19] in work on lattice models of the phase transitions of magnets and polymers. Not only is this problem of considerable interest in statistical mechanics, but is an interesting combinatorial problem in its own right. See [9, 15] for reviews of this topic.

While the model was introduced nearly 60 years ago, little progress has been made towards either an explicit, or useful implicit, solution. To date, only subclasses of polygons have been solved and all of these have quite strong convexity conditions which render the problem tractable (see [2, 19] for example).

We wish to enumerate SAPs according to the number of bonds they contain; since this number is always even it is customary to count their *half-perimeter* which is half the number of bonds. The generating function of these objects is then

$$P(x) = \sum_{P \in \mathcal{P}} x^{|P|}, \quad (1)$$

where  $|P|$  denotes the half-perimeter of the polygon  $P$ .

To form the the *anisotropic* generating function we distinguish between vertical and horizontal bonds, and so count according to the vertical and horizontal half-perimeters. This generating function is then

$$P(x, y) = \sum_{P \in \mathcal{P}} x^{|P|_{\Leftrightarrow}} y^{|P|_{\Uparrow}}, \quad (2)$$

where  $|P|_{\Leftrightarrow}$  and  $|P|_{\Uparrow}$  respectively denote the horizontal and vertical half-perimeters of  $P$ . By partitioning  $\mathcal{P}$  according to the vertical half-perimeter we may rewrite the above generating function as

$$P(x, y) = \sum_{n \geq 1} y^n \sum_{P \in \mathcal{P}_n} x^{|P|_{\Leftrightarrow}} = \sum_{n \geq 1} H_n(x) y^n, \quad (3)$$

where  $\mathcal{P}_n$  is the set of SAPs with  $2n$  vertical bonds, and  $H_n(x)$  is its horizontal half-perimeter generating function.

The anisotropic generating function is arguably a more manageable object than the isotropic. By splitting the set of polygons into separate simpler subsets,  $\mathcal{P}_n$ , we obtain smaller pieces which

is easier to study than the whole. If one seeks to compute or even just understand the *isotropic* generating function then one must somehow examine *all* possible configurations that can occur in  $\mathcal{P}$ ; this is perhaps the reason that only families of bond animals with severe topological restrictions have been solved (such as column-convex polygons). On the other hand, if we examine the generating function of  $\mathcal{P}_n$ , then the number of different configurations that can occur is always finite. For example, if  $n = 1$  all configurations are rectangles, for  $n = 2$  all configurations are vertically *and* horizontally convex and for  $n = 3$  all configurations are vertically *or* horizontally convex. The anisotropy allows one to study the effect that these configurations have on the generating function in a more controlled manner.

In a similar way, the anisotropic generating function is broken up into separate simpler pieces,  $H_n(x)$ , that can be calculated exactly for small  $n$ . By studying the properties of these coefficients, rather than the whole (possibly unknown) isotropic generating function, we can obtain some idea of the properties of the generating function as a whole.

In many cases generating functions (and other formal power series) satisfy simple linear differential equations; an important subclass of such series are *differentiably finite* power series; a formal power series in  $n$  variables,  $F(x_1, \dots, x_n)$  with complex coefficients is said to be *differentiably finite* if for each variable  $x_i$  there exists a non-trivial differential equation:

$$P_d(\mathbf{x}) \frac{\partial^d}{\partial x_i^d} F(\mathbf{x}) + \dots P_1(\mathbf{x}) \frac{\partial}{\partial x_i} F(\mathbf{x}) + \dots + P_0(\mathbf{x}) F(\mathbf{x}) = 0, \quad (4)$$

with  $P_j$  a polynomial in  $(x_1, \dots, x_n)$  with complex coefficients [14].

While no solution is known for  $P(x, y)$ , and certainly no equation of the form of equation (4), the first few coefficients of  $y$  may be expanded numerically [10] and the following properties were observed (up to the coefficient of  $y^{14}$ ):

- $H_n(x)$  is a rational function of  $x$ ,
- the degree of the numerator of  $H_n(x)$  is equal to the degree of its denominator.
- the first few denominators of  $H_n(x)$  (we denote them  $D_n(x)$ ) are:

$$\begin{aligned} D_1(x) &= (1-x) \\ D_2(x) &= (1-x)^3 \\ D_3(x) &= (1-x)^5 \\ D_4(x) &= (1-x)^7 \\ D_5(x) &= (1-x)^9(1+x)^2 \\ D_6(x) &= (1-x)^{11}(1+x)^4 \\ D_7(x) &= (1-x)^{13}(1+x)^6(1+x+x^2) \\ D_8(x) &= (1-x)^{15}(1+x)^8(1+x+x^2)^3 \\ D_9(x) &= (1-x)^{17}(1+x)^{10}(1+x+x^2)^5 \\ D_{10}(x) &= (1-x)^{19}(1+x)^{12}(1+x+x^2)^7(1+x^2). \end{aligned}$$

Similar observations have been made for a large number of solved and unsolved lattice models [7] and it was noted that for *solved* models the denominators appear to only contain a small and fixed number of different factors, while for *unsolved* models the number of different factors appears to increase with  $n$ . Guttmann and Enting suggested that this pattern of increasing number of denominator factors was the hallmark of an unsolvable problem, and that it could be used as a test of *solvability*.

In [17] we developed techniques to prove these observations for many families of bond animals. In particular, for families of animals that are *dense* (a term we will define in the next Section), we have the following Theorem (slightly restated for SAPs):

**Theorem 1 (from [17]).** *If  $G(x,y) = \sum_{n \geq 0} H_n(x)y^n$  is the anisotropic generating function of some dense family of polygons,  $\mathcal{P}$ , then*

- $H_n(x)$  is a rational function,
- the degree of the numerator of  $H_n(x)$  cannot be greater than the degree of its denominator, and
- the denominator of  $H_n(x)$  is a product of cyclotomic polynomials.

**Remark.** We remind the reader that the *cyclotomic polynomials*,  $\Psi_k(x)$ , are the factors of the polynomials  $(1 - x^n)$ . More precisely  $(1 - x^n) = \prod_{k|n} \Psi_k(x)$ .

In Section 2, we quickly review the *haruspicy* techniques developed in [17] and use them to find a multiplicative upper bound  $B_n(x)$  on the denominator  $D_n(x)$ . *ie* we find a sequence of polynomials  $B_n(x)$  such that they are always divisible by  $D_n(x)$ .

In Section 3, we further refine this result to prove that that  $D_{3k-2}(x)$  contains exactly one factor of  $\Psi_k(x)$  (for  $k \neq 2$ ). This implies that the singularities of the functions  $H_n(x)$  form a dense set in the complex plane. Consequently, the generating function  $P(x,y)$  is *not* differentiably finite — as predicted by the Guttmann and Enting solvability test. This result is then extended to self-avoiding polygons on hypercubic lattices.

## 2 Denominator Bounds

### 2.1 Haruspicy

The techniques developed in [17] allow us to determine properties of the coefficients,  $H_n(x)$ , whether or not they are known in some nice form. The basic idea is to reduce or squash the set of animals down onto some sort of minimal set, and then various properties of the coefficients may be inferred by examining the bond configurations of those minimal animals. We refer to this approach as *haruspicy*; the word refers to techniques of divination based on the examination of the forms and shapes of the organs of animals.

We start by describing how to cut up polygons so that they may be reduced or squashed in a consistent way.

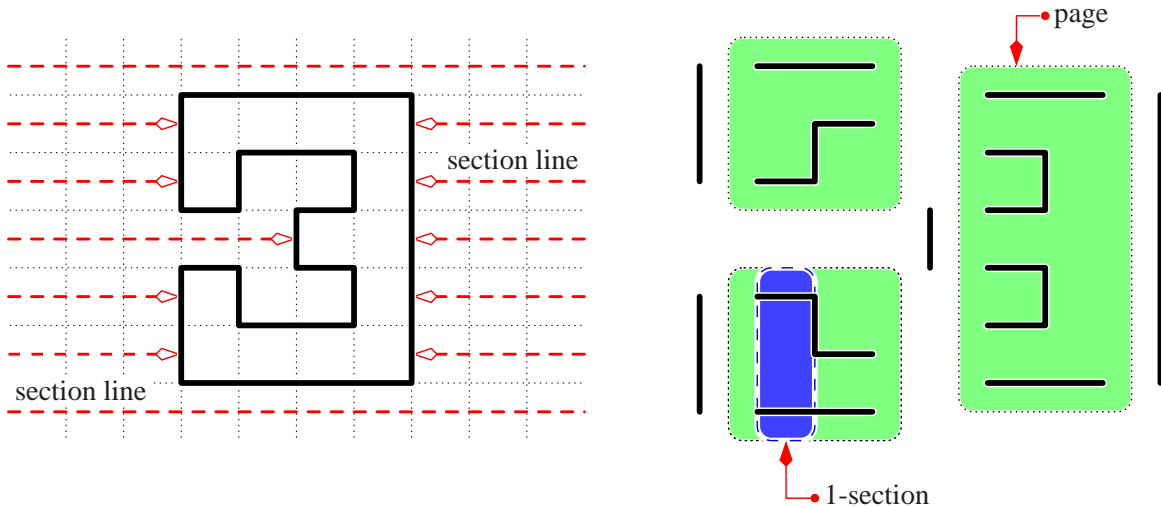

Figure 2: *Section lines* (the heavy dashed lines in the left-hand figure) split the polygon into *pages* (as shown on the right-hand figure). Each column in a page is a *section*. This polygon is split into 3 pages, each containing 2 sections; a 1-section is highlighted. 10 vertical bonds lie between pages and 4 vertical bonds lie within the pages.

**Definition 2.** Draw horizontal lines from the extreme left and the extreme right of the lattice towards the animal so that the lines run through the middle of each lattice cell. These lines are called *section lines*. The lines are terminated when they first touch (*ie* are obstructed by) a vertical bond (see Figure 2).

Cut the lattice along each section line from infinity until it terminates at a vertical bond. Then from this vertical bond cut vertically in both directions until another section line is reached. In this way the polygon (and the lattice) is split into *pages* (see Figure 2); we consider the vertical bonds along these vertical cuts to lie *between* pages, while the other vertical bonds lie *within* the pages.

We call a *section* the set of horizontal bonds within a single column of a given page. Equivalently, it is the set of horizontal bonds of a column of an animal between two neighbouring section lines. A section with  $2k$  horizontal bonds is a  $k$ -section. The number of  $k$ -sections in a polygon,  $P$ , is denoted by  $\sigma_k(P)$ .

The polygon has now been divided up into smaller units, which we have called sections. In some sense many of these sections are superfluous and are not needed to encode its “*shape*” (in some loose sense of the word). More specifically, if there are two neighbouring sections that are the same, then we can reduce the polygon by removing one of them, while leaving the polygon with essentially the same shape.

**Definition 3.** We say that a section is a *duplicate section* if the section immediately on its left (without loss of generality) is identical (see Figure 3).

One can reduce polygons by *deletion* of duplicate sections by slicing the polygon on either side of the duplicate section, removing it and then recombining the polygon, as illustrated in Figure 3. By reversing the section-deletion process we define *duplication* of a section.

We say that a set of polygons,  $\mathcal{P}$ , is *dense* if the set is closed under section deletion and duplication. *Ie* no polygon outside the set can be produced by section deletion and / or duplication from a polygon inside the set.

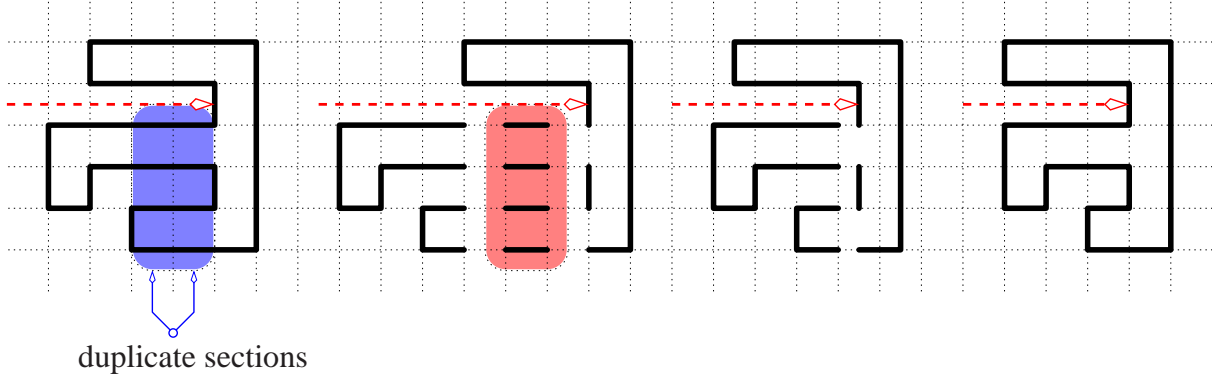

Figure 3: The process of section deletion. The two indicated sections are identical. Slice either side of the duplicate and separate the polygon into three pieces. The middle piece, being the duplicate, is removed and the remainder of the polygon is recombined. Reversing the steps leads to section duplication. Also indicated is a section line which separates the duplicate sections from the rest of the columns in which they lie.

The process of section-deletion and duplication leads to a partial order on the set of polygons.

**Definition 4.** For any two polygons  $P, Q \in \mathcal{P}_n$ , we write  $P \preceq_s Q$  if  $P = Q$  or  $P$  can be obtained from  $Q$  by a sequence of section-deletions. A *section-minimal* polygon,  $P$ , is a polygon such that for all polygons  $Q$  with  $Q \preceq_s P$  we have  $P = Q$ .

The lemma below follows from the above definition (see [17] for details):

**Lemma 5.** *The binary relation  $\preceq_s$  is a partial order on the set of polygons. Further every polygon reduces to a unique section-minimal polygon, and there are only a finite number of minimal polygons in  $\mathcal{P}_n$ .*

By considering the generating function of all polygons that are equivalent (by some sequence of section-deletions) to a given section-minimal polygon, we find that  $H_n(x)$  may be written as the sum of simple rational functions. Theorem 1 follows directly from this. Further examination of the denominators of these functions gives the following result:

**Theorem 6 (from [17]).** *If  $H_n(x)$  has a denominator factor  $\Psi_k(x)$ , then  $\mathcal{P}_n$  must contain a section-minimal polygon containing a  $K$ -section for some  $K \in \mathbb{Z}^+$  divisible by  $k$ . Further if  $H_n(x)$  has a denominator factor  $\Psi_k(x)^\alpha$ , then  $\mathcal{P}_n$  must contain a section-minimal polygon that contains  $\alpha$  sections that are  $K$ -sections for some (possibly different)  $K \in \mathbb{Z}^+$  divisible by  $k$ .*

This theorem demonstrates the link between the factors of  $D_n(x)$  and the sections in section-minimal polygons with  $2n$  vertical bonds.

## 2.2 The number of $k$ -sections

In this subsection, we shall demonstrate the following multiplicative upper bound on the denominator,  $D_n(x)$  of  $H_n(x)$ :

$$D_n(x) \text{ is a factor of } \prod_{k=1}^{\lceil n/3 \rceil} \Psi_k(x)^{2n-6k+5}. \quad (5)$$

We do this by finding an upper bound on the number of  $k$ -sections that a SAP with  $2n$  vertical bonds may contain. A proof of the corresponding result for general bond animals is given in [17]; here we follow a similar line of proof, but specialise (where possible) to the case of SAPs.

The proof consists of several steps:

1. Find the maximum number of sections in a polygon with  $2V$  vertical bonds.
2. Determine a lower bound on the number of vertical bonds and sections that must lie to the left (without loss of generality) of a  $k$ -section. This gives a lower bound on the number of sections that must lie to the left of the leftmost  $k$ -section and to the right of the rightmost  $k$ -section — none of these can be  $k$ -sections and so we obtain a lower bound on number of sections that cannot be  $k$ -sections.
3. From the above two facts we obtain an upper bound on the number of sections in a polygon that may be  $k$ -sections; assume that they are all  $k$ -sections.
4. Theorem 6 then gives the upper bound on the exponent of  $\Psi_k(x)$ .

Please note that for the remainder of this part of the paper we shall use “*sm-polygons*” to denote “*section-minimal polygons*” unless otherwise stated.

**Lemma 7.** *An sm-polygon that contains  $p$  pages and  $v$  vertical bonds inside those pages may contain at most  $p + v$  sections.*

*Proof.* Consider the  $v_i$  vertical bonds inside the  $i^{\text{th}}$  page. Between any two sections in this page there must be at least 1 vertical bond (otherwise the horizontal bonds in both sections would be the same and they would be duplicate sections). Hence the  $i^{\text{th}}$  page contains at most  $v_i + 1$  sections. Since every section must lie in exactly 1 page the result follows.  $\square$

**Lemma 8.** *The maximum number of pages in an sm-polygon is  $2R - 1$  where  $R$  denotes the number of rows in the sm-polygon.*

*Proof.* See Lemma 13 in [17]. We note that this differs from the result for bond animal since all sections must contain an even number of horizontal bonds, and must also lie between vertical bonds. Consequently we are only interested in those pages that lie *inside* the sm-polygon.  $\square$

**Lemma 9.** *The maximum number of sections in an sm-polygon with  $2V$  vertical bonds is  $2V - 1$ .*

*Proof.* Consider an sm-polygon of height  $R$  with  $2V = 2R + 2v$  vertical bonds. Of these vertical bonds  $2R$  block section lines and the remaining  $2v$  may lie *inside* pages. By Lemma 8, this sm-polygon has at most  $2R - 1$  pages. At most  $2v$  vertical bonds lie inside these pages and so by Lemma 7 the result follows.  $\square$

The above lemma tells us the maximum number of sections in a sm-polygon. We now determine how many of these sections lie to the left (without loss of generality) of a  $k$ -section. We start by determining how many vertical bonds lie to the left of a  $k$ -section.

**Lemma 10.** *To the left (without loss of generality) of a  $k$ -section there are at least  $3k - 2$  vertical bonds, of which at least  $2k - 1$  obstruct section lines.*

*Hence no polygon with fewer than  $6k - 4$  vertical bonds may contain a  $k$ -section. Further, it is always possible to construct a polygon with  $6k - 4$  vertical bonds and a single  $k$ -section.*

*Proof.* Consider a vertical line drawn through a  $k$ -section (as depicted in left-hand side of Figure 4). The line starts outside the polygon and then as it crosses horizontal bonds it alternates between the inside and outside of the polygon. More precisely, there are  $k + 1$  segments of the line that lie outside the polygon and  $k$  segments that lie inside the polygon. Let us call the segments that lie within the polygon “*inside gaps*” and those that lie outside “*outside gaps*”.

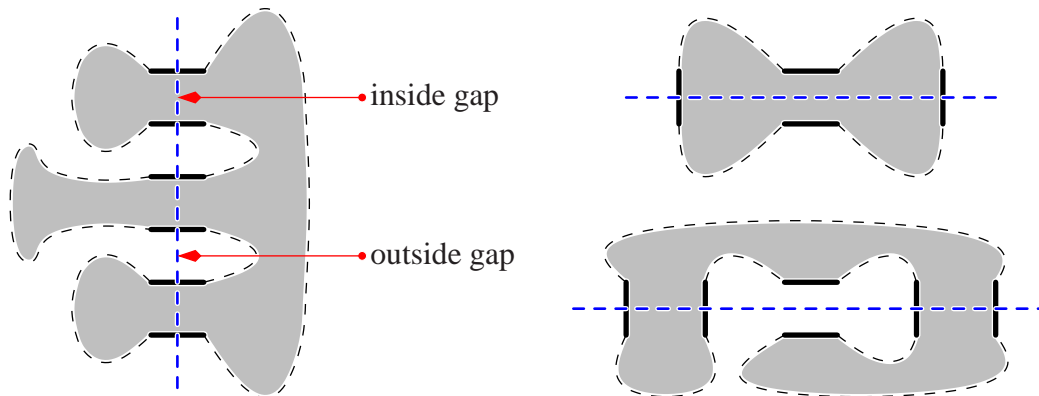

Figure 4: Vertical and horizontal lines drawn through a  $k$ -section show the minimum number of vertical bonds required in their construction.

Draw a horizontal line through an inside gap (as depicted in the top-right of Figure 4). If we traverse the horizontal line from left to right, we must cross at least 1 vertical bond to the left of the gap (since it is inside the polygon) and then another to the right of the gap. Hence to the left of any inside gap there must be at least 1 vertical bond. Similarly we must cross at least 1 vertical bond to the right of any inside gap.

Draw a horizontal line through the topmost of the  $k + 1$  outside gaps. Since the line need not intersect the polygon it need not cross any vertical bonds at all. Similarly for the bottommost outside gap.



Now draw a horizontal line through one of the other outside gaps (as depicted in the bottom-right of Figure 4). Traverse this line from the left towards the outside gap. If no vertical bonds are crossed then a section line may be drawn from the left into the outside gap. This splits the  $k$ -section into two smaller sections and so contradicts our assumptions. Hence we must cross at least 1 vertical bond to block section lines. If we cross only a single vertical bond before reaching the gap then the gap would lie inside the polygon. Hence we must cross at least 2 (or any even number) vertical bonds before reaching the gap. Similar reasoning shows that we must also cross an even number of vertical bonds when we continue traversing to the right.

Since any  $k$ -section contains  $k$  inside gaps, a topmost outside gap, a bottommost outside gap and  $k - 1$  other outside gaps, there must be at least  $k \times 1 + 2 \times 0 + 2 \times (k - 1) = 3k - 2$  vertical bonds to its left and  $3k - 2$  vertical bonds to its right.

Consider the polygons depicted in Figure 5 that are constructed by adding “hooks”. In this way we are always able to construct an sm-polygon with  $(6k - 4)$  vertical bonds and exactly one  $k$ -section. □

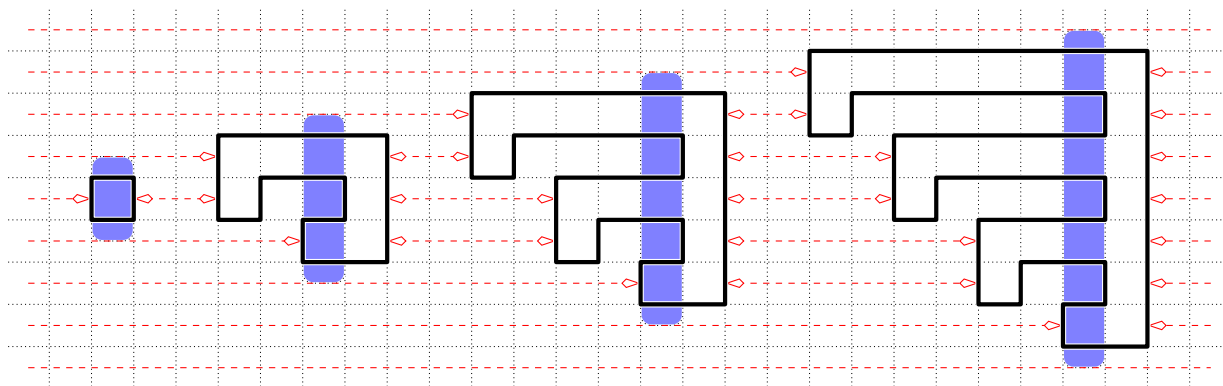

Figure 5: Section-minimal polygons with  $6k - 4$  vertical bonds and a single  $k$ -section may be constructed by concatenating such “hook” configurations.

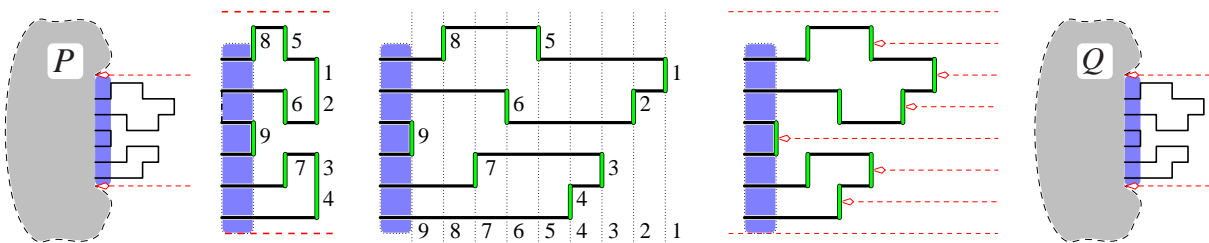

Figure 6: Given an sm-polygon  $P$  we can create a new sm-polygon  $Q$  that is identical to  $P$  except for the region lying to the right of its rightmost  $k$ -section; that region is altered to maximise the number of sections lying to the right of the  $k$ -section. We do this by stretching that portion  $P$  that lies to the right of the  $k$ -section so that no two vertical bonds lie in the same vertical line. The polygon is then made section-minimal again by deleting duplicate sections.

The next lemma shows that given an sm-polygon,  $P$ , that contains a  $k$ -section, we are always able to find a new sm-polygon,  $Q$ , with the same number of vertical bonds that has *at least*  $3(k-1)$  sections to the left of its leftmost  $k$ -section. This result allows us to compute how many sections in an sm-polygon cannot be  $k$ -sections since they lie to the left of the leftmost or to the right of the rightmost  $k$ -section.

**Lemma 11.** *Let  $P$  be an sm-polygon that contains a  $k$ -section and  $2V$  vertical bonds. If there are fewer than  $3(k-1)$  sections to the right of the rightmost  $k$ -section in  $P$ , then there exists another sm-polygon,  $Q$ , that is identical to  $P$  except that to the right of the rightmost  $k$ -section there are at least  $3(k-1)$  sections. See Figure 6.*

*Similarly given a polygon,  $P'$  with fewer than  $3(k-1)$  sections to the left of the leftmost  $k$ -section, there exists another polygon  $Q'$  identical to  $P'$  except that there are at least  $3(k-1)$  sections to the left of the leftmost  $k$ -section.*

*Proof.* We prove the above result by “stretching” the portion of the sm-polygon,  $P$ , to the right of the rightmost  $k$ -section so as to obtain a new sm-polygon,  $Q$ , in which the number of sections to the right of the  $k$ -section is maximised.

Consider the example given in Figure 6. Consider the portion of the sm-polygon that lies to the right of rightmost  $k$ -section (which is highlighted). Label the vertical bonds from top-rightmost (1) to bottom-leftmost (9). We now “stretch” the horizontal bonds of the sm-polygon so that bonds with higher labels lie to the left of those with lower labels and so that no two bonds lie in the same vertical line (Figure 6, centre). To recover a section-minimal polygon we now delete duplicate sections (Figure 6, right). We now need to determine how many sections remain.

Consider the stretched portion of polygon before duplicate sections are removed. If there were originally  $r$  vertical bonds blocking section lines, then there are still  $r$  vertical bonds blocking section lines after stretching. See Figure 7. Since no two vertical bonds lie in the same vertical line, each page corresponds to a single vertical bond that blocks a section line (which will lie on the right-hand edge of the page). Hence the stretched portion polygon contains  $r$  pages (one of which contains the  $k$ -section). The other vertical bonds must lie within these pages. See also the proof of Lemma 13 in [17].

Thus, if there were  $v = r + m$  vertical bonds to the right of the  $k$ -section, with  $r$  blocking section lines, then after deleting duplicate sections there will be  $r$  pages (no pages will be removed) and  $m$  vertical bonds within those pages (with no two vertical bonds in the same page lying in the same vertical line). Consequently there will be  $r + m - 1$  sections *excluding* the  $k$ -section.

By Lemma 10 there must be at least  $3k - 2$  vertical bonds to the right of a  $k$ -section, and so the “stretching” procedure will produce an sm-polygon with at least  $3k - 3$  sections to the right of the  $k$ -section.

Note that this procedure does not change the number of vertical bonds in each row, nor the number of vertical bonds on either side of the  $k$ -section. □

Since we now know the total number of sections in a section minimal polygon and how many of these cannot be  $k$ -sections we can prove an upper bound on the number of  $k$ -sections:

**Theorem 12.** *A section-minimal polygon  $P$  that contains  $2V = (6k - 4 + 2M)$  vertical bonds may not contain more than  $2M + 1$  sections that contain  $2k$  or more horizontal bonds.*

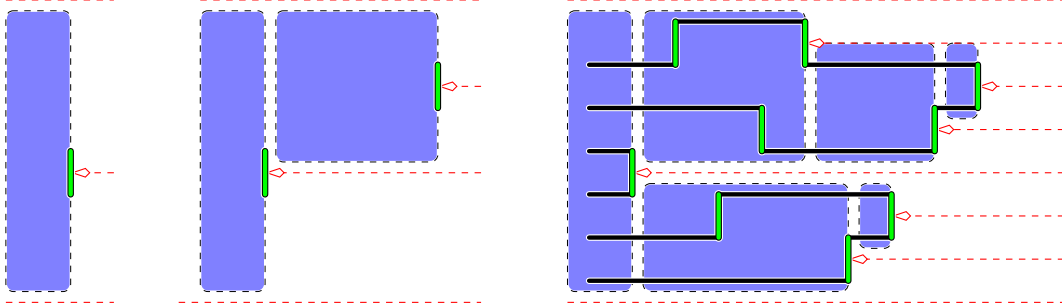

Figure 7: The pages in the stretched polygon before removing duplicate sections. By “scanning” from left to right we see that each page corresponds one vertical bond that blocks a section line.

*Proof.* By Lemma 9,  $P$  may contain no more that  $(2V - 1)$  sections. We complete the proof by assuming that the theorem is false and then reaching a contradiction.

Consider an sm-polygon,  $P$ , that does not have a section with  $> 2k$  horizontal bonds, but does contain more than  $(2M + 1)k$  sections. By Lemma 11 we may always “stretch” the portion of the polygon lying to the right of the rightmost  $k$ -section to obtain a new section-minimal polygon so that at least  $3(k - 1)$  sections lie to the right of the rightmost  $k$ -section. Similarly we may “stretch” the portion of the polygon lying to the left of the leftmost  $k$ -section to obtain a new section-minimal polygon  $Q$  that has at least  $6(k - 1)$  sections lying either to the left of the leftmost or to the right of the rightmost  $k$ -sections. Consequently this new polygon contains more than  $(2M + 1) + (6k - 6) = 6k + 2M - 5$  sections. This contradicts Lemma 9.

Now consider an sm-polygon that contains sections with at least  $2k$  horizontal bonds. Assume that it does contain more than  $2M + 1$  such sections. Without loss of generality consider the leftmost section with at least  $2k$  horizontal bonds. By applying Lemma 11 we see that one may always construct a new section-minimal polygon so that at least  $3(k - 1)$  sections lie to the left of the leftmost such section. Repeating the argument in the paragraph above shows that one will reach a contradiction and the proof is complete.  $\square$

**Remark.** It is possible to construct a section-minimal polygon with exactly  $(6k - 4 + 2M)$  vertical bonds and  $2M + 1$   $k$ -sections — see Figure 8.

**Corollary 13.** *The factor of  $\Psi_k(x)$  in the denominator,  $D_n(x)$  of  $H_n(x)$  may not appear with a power greater than  $2n - 6k + 5$ . Hence we have the following multiplicative upper bound for  $D_n(x)$ :*

$$D_n(x) \left| \prod_{k=1}^{\lceil n/3 \rceil} \Psi_k(x)^{2n-6k+5} \right.$$

*Proof.* This follows by combining the results of Theorems 1, 6 and 12.

**Remark.** We note that a comparison of the above bound on the denominator of  $H_n(x)$  appears to be quite tight when compared with series expansion data [10]. It appears to be wrong only by a single factor of  $\Psi_2(x)$ ; the exponents of other factors appear to be equal to that of the bound.

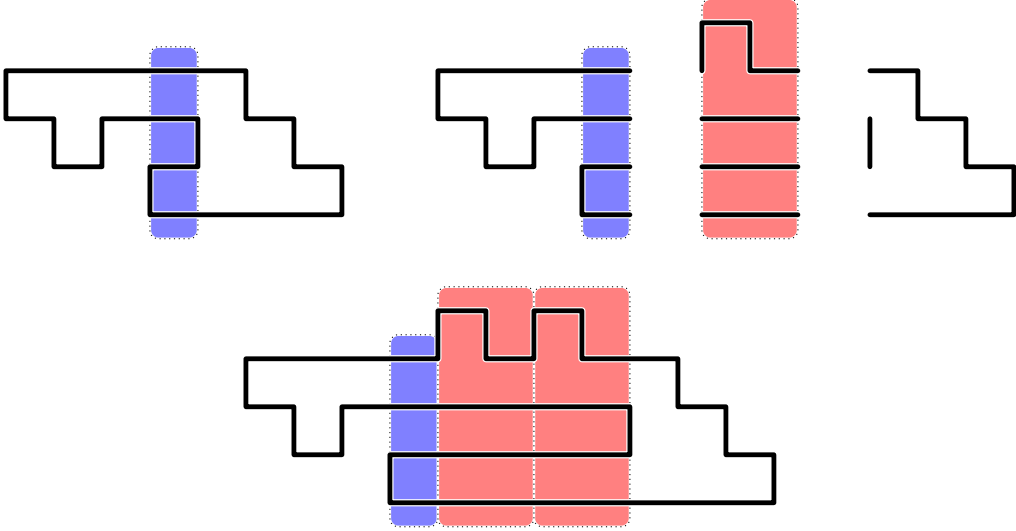

Figure 8: To construct a polygon with  $2M + 1$   $k$ -sections and  $6k - 4 + 2M$  vertical bonds, start with a polygon with a single  $k$ -section and  $6k - 4$  vertical bonds as shown (top left). Cut it on the right of the  $k$ -section. Insert  $M$  copies of the pair of  $k$ -sections and recombine the polygon. This gives a polygon with  $2M + 1$   $k$ -sections and  $6k - 4 + 2M$  vertical bonds.

We also note that the above result significantly reduces the difficulty of computing the coefficients,  $H_n(x)$  of the anisotropic generating function. In particular, we know that  $H_n(x)$  is a rational function whose numerator degree is no greater than that of its denominator. Corollary 13 gives this denominator (up to multiplicative cyclotomic factors) and as a consequence also bounds the degree of the numerator and hence the number of unknowns we must compute in order to know  $H_n(x)$ .

Since the degree of  $\Psi_k(x)$  is no greater than  $k$ , the degree of  $D_n(x)$  is no greater than  $\sum_{k=1}^{\lceil n/3 \rceil} k(2n - 6k + 5) \sim \frac{1}{27}n^3$ . Note that using similar (non-rigorous) arguments to those in Section 4.2 of [17] one can show that the degree grows like  $\frac{2}{9\pi^2}n^3$ . Hence the degree of the numerator (and the number of unknowns to be computed) grows as  $n^3$ . Bounds from transfer matrix techniques (such as [6]) grow exponentially.

### 3 The nature of the generating function

#### 3.1 Differentiably finite functions

Perhaps the most common functions in mathematical physics (and combinatorics) are those that satisfy simple linear differential equations. A subset of these are the differentiably finite functions that satisfy linear differential equations with polynomial coefficients.

**Definition 14.** Let  $F(x)$  be a formal power series in  $x$  with coefficients in  $\mathbb{C}$ . It is said to be

*differentiably finite* or *D-finite* if there exists a non-trivial differential equation:

$$P_d(x) \frac{\partial^d}{\partial x^d} F(x) + \cdots + P_1(x) \frac{\partial}{\partial x} F(x) + P_0(x) F(x) = 0, \quad (6)$$

with  $P_j$  a polynomial in  $x$  with complex coefficients [14].

In this paper we consider series,  $G(x, y)$  that are formal power series in  $y$  with coefficients that are rational functions of  $x$ . Such a series is said to be *D-finite* if there exists a non-trivial differential equation:

$$Q_d(x, y) \frac{\partial^d}{\partial y^d} G(x, y) + \cdots + Q_1(x, y) \frac{\partial}{\partial y} G(x, y) + Q_0(x, y) G(x, y) = 0, \quad (7)$$

with  $Q_j$  a polynomial in  $x$  and  $y$  with complex coefficients

One of the main aims of this paper is to demonstrate that the anisotropic generating function of SAPs is not *D-finite*, and we do so by examining the singularities of that function.

The classical theory of linear differential equations implies that a *D-finite* power series of a single variable has only a finite number of singularities. This forms a very simple “*D-finiteness test*” — a function such as  $f(x) = 1/\cos(x)$  cannot be *D-finite* since it has an infinite number of singularities. Unfortunately we know very little about the singularities of the *isotropic* SAP generating function and cannot apply this test.

When we turn our attention to the anisotropic generating function (a power series with rational coefficients) there is a similar test that examines the singularities of the *coefficients*. Consider the following example:

$$f(x, y) = \sum_{n \geq 1} \frac{x^n}{1 - nx} y^n. \quad (8)$$

The coefficient of  $y^n$  is singular at  $x = 1/n$  and so the set of singularities of its coefficients,  $\{n^{-1} \mid n \in \mathbb{Z}^+\}$ , is infinite and has an accumulation point at 0. In spite of this it is a *D-finite* power series in  $y$ , since it satisfies the following partial differential equation:

$$xy^2(1 - xy) \frac{\partial^2 f}{\partial y^2} - y(1 - xy + x^2y) \left( \frac{\partial f}{\partial y} \right) + f = 0. \quad (9)$$

So the set of the singularities of the coefficients of a *D-finite* series may be infinite and have accumulation points. It may not, however, have an infinite number of accumulation points.

**Theorem 15 (from [4]).** *Let  $f(x, y) = \sum_{n \geq 0} y^n H_n(x)$  be a *D-finite* series in  $y$  with coefficients  $H_n(x)$  that are rational functions of  $x$ . For  $n \geq 0$  let  $S_n$  be the set of poles of  $H_n(x)$ , and let  $S = \bigcup_n S_n$ . Then  $S$  has only a finite number of accumulation points.*

In order to apply this theorem to the self-avoiding polygon generating function we need to prove that the denominators of the coefficients  $H_n(x)$  suggested by Corollary 13 do not cancel with the numerators — so that the singularities suggested by those denominators really do exist. Unfortunately, we are unable to prove such a strong result. However, we do not need to understand the full singularity structure of the coefficients; the following result is sufficient:

**Theorem 16.** For  $k \neq 2$  the generating function  $H_{3k-2}(x)$  has simple poles at the zeros of  $\Psi_k(x)$ . Equivalently the denominator of  $H_{3k-2}(x)$  contains a single factor of  $\Psi_k(x)$  which does not cancel with the numerator.

An immediate corollary of this result is that singularities of the coefficients  $H_n(x)$  are dense on the unit circle,  $|x| = 1$  and so the anisotropic generating function is not a D-finite power series in  $y$ .

### 3.2 2-4-2 polygons

In order to prove Theorem 16 we split the set of polygons with  $(6k - 4)$  vertical bonds into two sets — polygons that contain a  $k$ -section and those that do not. Let us denote those polygons with  $(6k - 4)$  vertical bonds and at least one  $k$ -section by  $\mathcal{K}_{3k-2}$ . Hence we may write the generating function  $H_{3k-2}(x)$  as

$$H_{3k-2}(x) = \sum_{P \in \mathcal{K}_{3k-2}} x^{|P|_{\Leftrightarrow}} + \sum_{P \in \mathcal{P}_{3k-2} \setminus \mathcal{K}_{3k-2}} x^{|P|_{\Leftrightarrow}}.$$

**Lemma 17.** The factor  $\Psi_k(x)$  appears in the denominator of the generating function  $\sum_{P \in \mathcal{K}_{3k-2}} x^{|P|_{\Leftrightarrow}}$  with exponent exactly equal to one if and only if it appears in the denominator of  $H_{3k-2}(x)$  with exponent exactly equal to one.

*Proof.* The sets  $\mathcal{K}_{3k-2}$  and  $\mathcal{P}_{3k-2} \setminus \mathcal{K}_{3k-2}$  are trivially dense, and so by Theorem 1 we know that the horizontal half-perimeter generating functions of these sets are rational and that their denominators are products of cyclotomic factors. Further, since  $\mathcal{P}_{3k-2} \setminus \mathcal{K}_{3k-2}$  does not contain a polygon with  $k$ -section (or indeed, by Lemma 10, any section with more than  $2k$  horizontal bonds), it follows by Theorem 6 that the denominator of the horizontal half-perimeter generating function of this set is a product of cyclotomic polynomials  $\Psi_j(x)$  for  $j$  strictly less than  $k$ . Consequently this generating function is not singular at the zeros of  $\Psi_k(x)$ . By Theorem 12, every section-minimal polygon in  $\mathcal{K}_{3k-2}$  contains exactly one  $k$ -section, and so the exponent of  $\Psi_k(x)$  in the denominator of the horizontal half-perimeter generating function of  $\mathcal{K}_{3k-2}$  is either one or zero (due to cancellations with the numerator). The result follows since this denominator factor may not be cancelled by adding the other generating function.  $\square$

$\triangleleft \triangleleft \diamond \triangleright \triangleright$

The above Lemma shows that to prove Theorem 16 it is sufficient to prove a similar result for the set of polygons,  $\mathcal{K}_{3k-2}$ . Let us examine this set further. In the proof of Lemma 10 it was shown that a  $k$ -section could be decomposed an alternating sequence of “inside gaps” and “outside gaps”; a row containing an inside gap contained at least 2 vertical bonds and a row containing an outside gap contained at least 4 vertical bonds (see the examples in Figure 5). We now concentrate on polygons containing 2 vertical bonds in very second row and 4 vertical bonds in every other row.

**Definition 18.** Number the rows of a polygon  $P$  starting from the topmost row (row 1) to the bottommost (row  $r$ ). Let  $v_i(P)$  be the number of vertical bonds in the  $i^{\text{th}}$  row of  $P$ . If  $(v_1(P), \dots, v_r(P)) = (2, 4, 2, \dots, 4, 2)$  then we call  $P$  a 2-4-2 polygon. We denote the set of such 2-4-2 polygons with  $2n$  vertical bonds by  $\mathcal{P}_n^{242}$ . Note that this set is empty unless  $2n = 6k - 4$  (for some  $k = 1, 2, \dots$ ).

**Lemma 19.** *A section-minimal polygon with  $(6k - 4)$  vertical bonds that contains one  $k$ -section must be a 2-4-2 polygon. On the other hand, a section-minimal 2-4-2 polygon need not contain a  $k$ -section.*

*Proof.* The first statement follows by arguments given in the proof of Lemma 10. The rightmost polygon in Figure 9 show that a 2-4-2 polygon need not contain a  $k$ -section.  $\square$

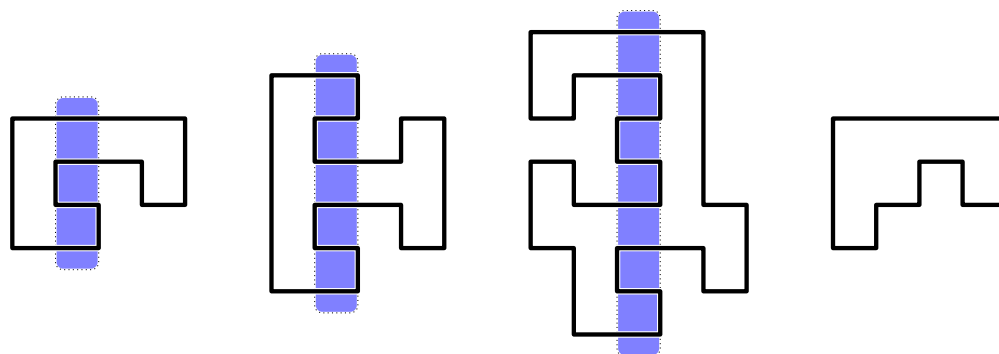

Figure 9: Four section-minimal 2-4-2 polygons. The first three polygons contain a 2-section, a 3-section, and a 4-section respectively. The rightmost polygon contains only 1-sections.

Despite the fact that 2-4-2 polygons are a superset of those polygons containing at least one  $k$ -section, it turns out both that they are easier to analyse (in the work that follows) and that a result analogous to Lemma 17 still holds.

**Lemma 20.** *The factor  $\Psi_k(x)$  appears in the denominator of the generating function  $\sum_{P \in \mathcal{P}_{3k-2}^{242}} x^{|P|} \Leftrightarrow$  with exponent exactly equal to 1 if and only if it appears in the denominator of  $H_{3k-2}(x)$  with exponent exactly equal to one.*

*Proof.* Similar to the the proof of Lemma 17.  $\square$

In the next section we derive a (non-trivial) functional equation satisfied by the generating function of 2-4-2 polygons.

### 3.3 Counting with Hadamard products

By far the most well understood classes of square lattice polygons are families of *row convex* polygons. Each row of a row convex polygon contains only two vertical bonds; this allows one to find a construction by which polygons are built up *row-by-row*. This technique is sometimes called the *Temperley method* [2, 19].

Since every second row of a 2-4-2 polygon contains 2 vertical bonds, we shall find a similar construction that instead of building up the polygons row-by-row, we build them two rows at a time (an idea also used in [5]). Like the constructions given in [2], this construction leads quite naturally to a functional equation satisfied by the generating function. One could also derive this functional equation using the techniques described in [2], however it proves more convenient in

this case to use techniques based on the application of Hadamard products (this idea is also used in [3]).

We shall start by showing how 2-4-2 polygons may be decomposed into smaller units we shall call *seeds* and *building blocks*. Consider the 2-4-2 polygon in Figure 10. Start by highlighting each row with 2 vertical bonds. We then “duplicate” each of these rows, excepting the bottommost; this situation is depicted in the middle polygon in Figure 10. By cutting the polygon horizontally between each pair of duplicate rows we decompose the polygon *uniquely* into a rectangle of unit height and a sequence of 2-4-2 polygons of height 3, such that the bottom row of each polygon is the same length of the top row of the next in the sequence. We refer to this initial rectangle as the *seed block* and the subsequent 2-4-2 polygons of height 3 as *building blocks*.

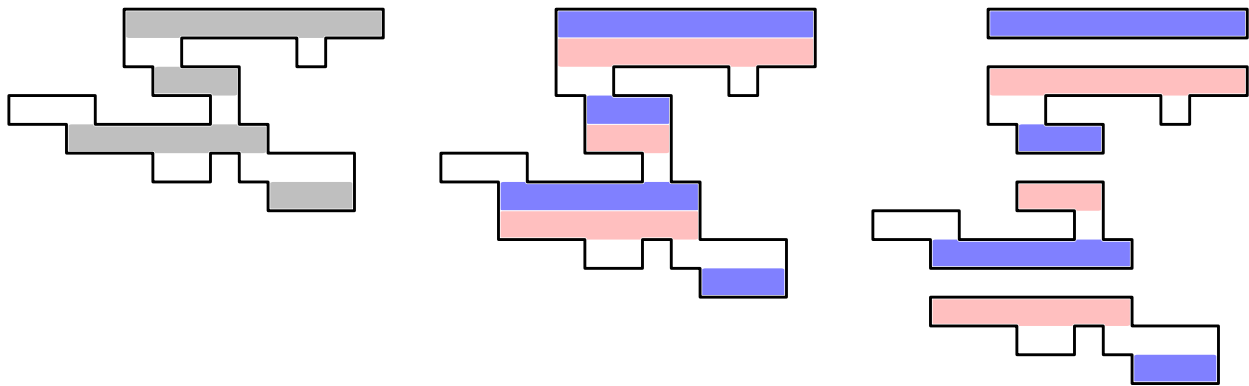

Figure 10: Decomposing 2-4-2 polygons into building blocks. Highlight each row with 2 vertical bonds. Then “duplicate” each of these rows excepting the bottommost. By cutting along each of these duplicated rows each 2-4-2 polygon is decomposed into a rectangle (of unit height) and a sequence of building blocks.

This decomposition implies that each 2-4-2 polygon is either a rectangle of unit height, or may be constructed by “combining” a (shorter) 2-4-2 polygon and a 2-4-2 building block, so that the bottom row of the polygon has the same length as the top row of the building block. This construction is depicted in Figure 11.

We will translate this construction into a recurrence satisfied by the 2-4-2 polygon generating function by using Hadamard products. We note that a similar construction (but for different lattice objects) appears in [11, 12] but is phrased in terms of constant term integrals.

Let us start with the generating function of the building blocks:

**Lemma 21.** *Let  $T(t, s; x, y)$  be the generating function of 2-4-2 polygon building blocks, where  $t$  and  $s$  are conjugate to the length of top and bottom rows (respectively). Then  $T$  may be expressed as*

$$T(t, s; x, y) = 2 \left( \hat{T}(t, s; x, y) + \hat{T}(s, t; x, y) \right), \quad (10)$$



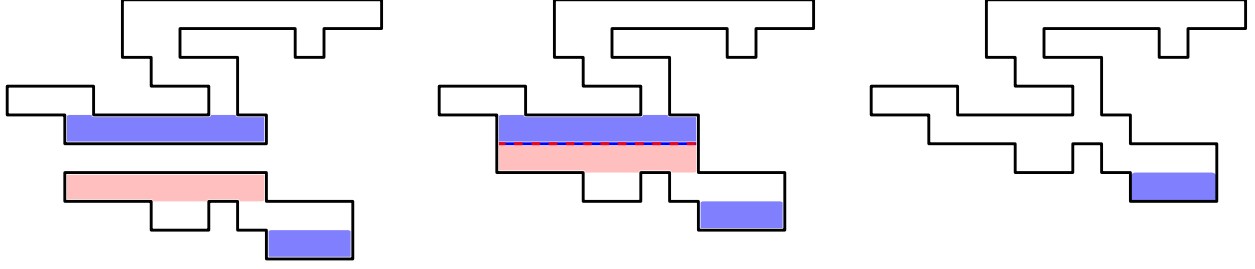

Figure 11: Constructing a 2-4-2 polygon from a (shorter) 2-4-2 polygon and a 2-4-2 building block. Note that when the building block and the polygon are squashed together, the total vertical perimeter is reduced by 2, and the total horizontal perimeter is reduced by twice the width of the joining row.

where the generating function  $\hat{T}(t, s; x, y)$  is given by

$$\begin{aligned}
\hat{T}(t, s; x, y) = & y^4 \left( A(s, t; x) \cdot \llbracket stx \rrbracket \llbracket tx \rrbracket^2 \cdot B(s, t; x) \right. \\
& + A(s, t; x) \cdot \llbracket stx \rrbracket \llbracket stx^2 \rrbracket \llbracket tx \rrbracket^2 \cdot B(s, t; x) \\
& + A(s, t; x) \cdot \llbracket stx \rrbracket \llbracket tx \rrbracket^3 \cdot B(s, t; x) \\
& + C(s, t; x) \cdot \llbracket sx \rrbracket \llbracket tx \rrbracket^3 \cdot B(s, t; x) \\
& \left. + C(s, t; x) \cdot \llbracket sx \rrbracket \llbracket x \rrbracket \llbracket tx \rrbracket^3 \cdot B(s, t; x) \right). \tag{11}
\end{aligned}$$

We have used  $\llbracket f \rrbracket$  as shorthand for  $\frac{f}{1-f}$ , and the generating functions  $A$ ,  $B$  and  $C$  are:

$$\begin{aligned}
A(s, t; x) = & 1 + \llbracket x \rrbracket + 2\llbracket sx \rrbracket + 2\llbracket tx \rrbracket + \llbracket sx \rrbracket \llbracket tx \rrbracket + \\
& \llbracket sx \rrbracket^2 + \llbracket sx \rrbracket \llbracket x \rrbracket + \llbracket tx \rrbracket^2 + \llbracket tx \rrbracket \llbracket x \rrbracket \tag{12}
\end{aligned}$$

$$B(s, t; x) = 1 + \llbracket tx \rrbracket + \llbracket x \rrbracket \tag{13}$$

$$C(s, t; x) = 1 + \llbracket sx \rrbracket + \llbracket x \rrbracket. \tag{14}$$

*Proof.* Figure 12 shows the four possible orientations of a building block. Figures 14 and 15 show how to construct the generating function  $\hat{T}$  of building blocks in one orientation. To obtain all building blocks we must reflect the blocks counted by  $\hat{T}$  about both horizontal and vertical lines (as shown in Figure 12). Reflecting about a vertical line multiplies  $\hat{T}$  by 2. Reflecting about a horizontal line interchanges the roles of  $s$  and  $t$ . This proves the first equation.

We now find  $\hat{T}$  by finding the *section-minimal* building blocks in one orientation (that of the top-left polygon in Figure 12). All such polygons contain 8 vertical bonds, let  $a, \dots, h \in \mathbb{Z}$  denote the  $x$ -ordinate of these bonds. Figure 13 shows the Hasse diagram that these numbers must satisfy:

$$\begin{aligned}
a, b < d & & a, b, c < e \\
d, e < f & & f < g, h.
\end{aligned}$$

Without loss of generality we set  $a = 0$  (to enforce translational invariance).

Consider a section-minimal building block and determine the values of  $b, \dots, h$ . We can decompose the building block depending on these values:

- Find which of  $g$  and  $h$  is minimal and cut the polygon along a vertical line running through that vertical bond. This separates the polygon into 2 parts; the part to the right is a *B-frill* (see Figure 15) — there are 3 possible *B-frills* depending on whether  $g = h$ ,  $g < h$  or  $g > h$ .
- If  $c < d$  then the building block must be of the form of polygon 1, 2 or 3 in Figure 14. Determine which is the greatest of  $a, b$  and  $c$  and cut the polygon along the vertical line running through that vertical bond. This separates the polygon into 2-parts; the part to the right is an *A-frill* (see Figure 15) — there are 11 possible *A-frills* depending on the relative magnitudes of  $a, b$ , and  $c$ .
- If  $c \geq d$  then the building block must be of the form of polygon 4 or 5 in Figure 14. Find which of  $a$  and  $b$  is greater and cut along the vertical line running through that vertical bond. This separates the polygon into 2 parts; the part to the right is a *C-frill* (see Figure 15) — there are 3 possible *C-frills* depending on the whether  $a = b$ ,  $a < b$  or  $a > b$ .

Using this decomposition we see that every section minimal polygon is given by one of the 5 polygons given in Figure 14 together with 2 of the *frills* from Figure 15. The above equation for  $\hat{T}(t, s; x, y)$  follows.  $\square$

We note that one could find  $\hat{T}$  using the theory of *P*-partitions [18], and we used it to check the result.

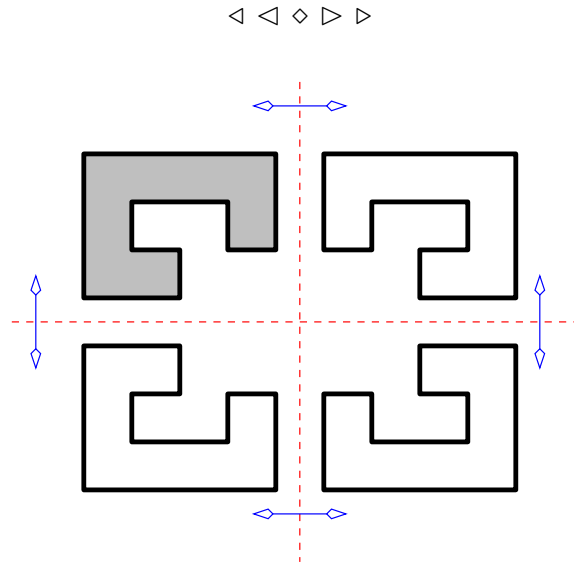

Figure 12: The set of building blocks has a 4-fold symmetry as shown. It suffices to find all the building blocks in one orientation and then obtain the others by reflections.

We now define the (restricted) Hadamard product and show how it relates to the construction of 2-4-2 polygons.

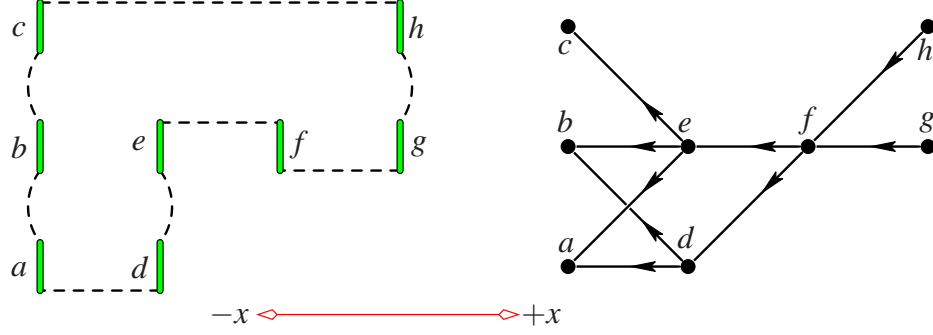

Figure 13: The vertical bonds of a 2-4-2 polygon building block. The  $x$ -ordinate of these bonds are denoted  $a, b, \dots, h$  as shown. The Hasse diagram showing the constraints on the values  $a, b, \dots, h$  is given on the right; an arrow from  $v_i$  to  $v_j$  implies that  $v_i > v_j$ .

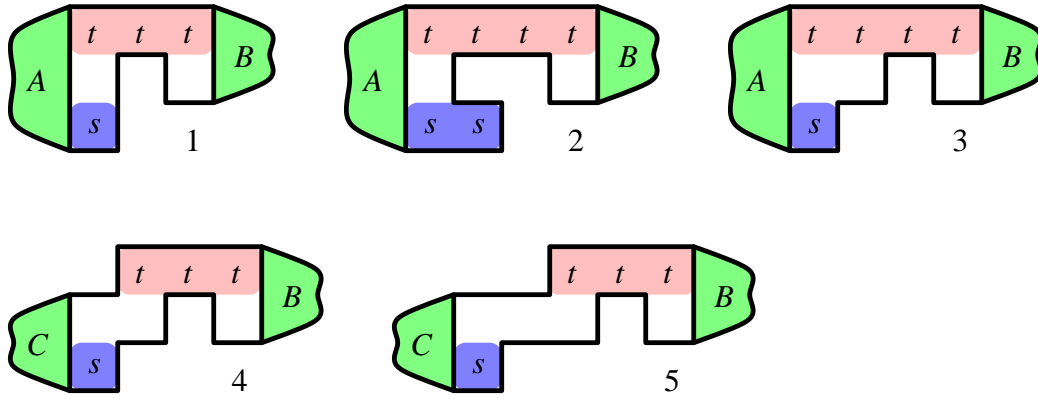

Figure 14: The section-minimal building blocks of 2-4-2 polygons. The “frills”, denoted  $A, B$  and  $C$  are given in Figure 15.

**Definition 22.** Let  $f(t) = \sum_{i \geq 0} f_n t^n$  and  $g(t) = \sum_{i \geq 0} g_n t^n$  be two power series in  $t$ . We define the (restricted) Hadamard product  $f(t) \odot_t g(t)$  to be

$$f(t) \odot_t g(t) = \sum_{n \geq 0} f_n g_n t^n.$$

We note that if  $f(t)$  and  $g(t)$  are two power series with real coefficients such that

$$\lim_{n \rightarrow \infty} |f_n g_n|^{1/n} < 1,$$

then the Hadamard product  $f(t) \odot_t g(t)$  will exist. For example  $(1 - 2t)^{-1} \odot_t (1 - 3t)^{-1}$  does not exist, while  $(1 - 2t)^{-1} \odot_t (1 - t/3)^{-1}$  does exist and is equal to 3.

Below we consider Hadamard products of power series in  $t$  whose coefficients are themselves power series in two variables,  $x$  and  $s$ . These products are of the form

$$f(t; x) \odot_t T(t, s, x) = \sum_{n \geq 0} f_n(x) T_n(s, x). \quad (15)$$

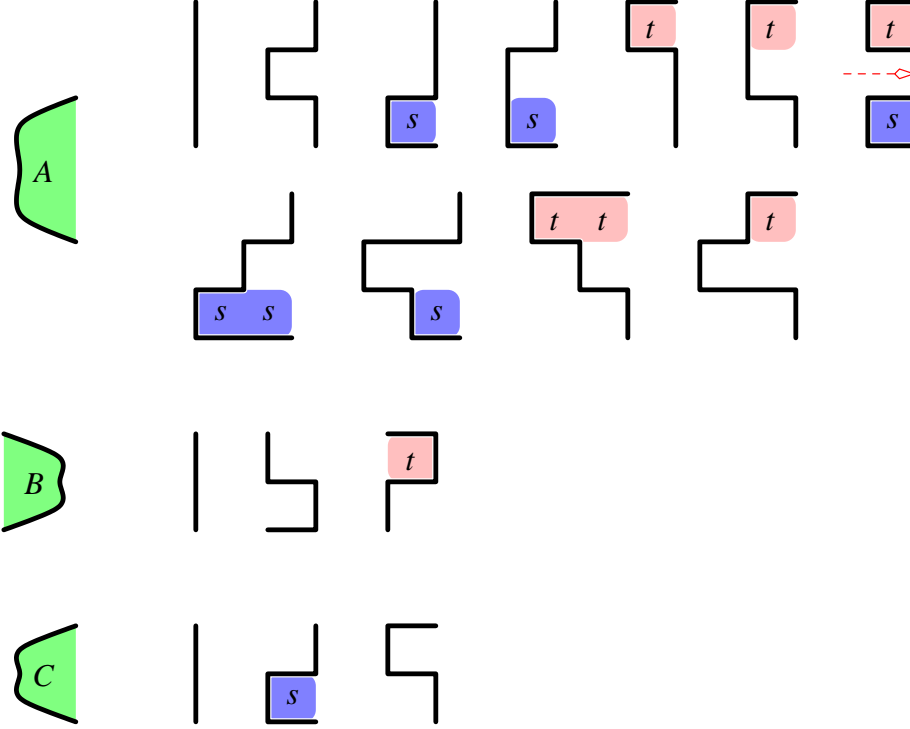

Figure 15: The “frills” of the building blocks in Figure 14.

Since the summands are the generating functions of certain polygons (see below) it follows that  $f_n(x)T_n(x) = O(sx^n)$  and so the sum converges.

**Lemma 23.** *Let  $f(s;x,y)$  be the generating function of 2-4-2 polygons, where  $s$  is conjugate to the length of bottom row of the polygon. This generating function satisfies the following equation*

$$f(s;x,y) = \frac{ysx}{1-sx} + f(t;x,y) \odot_t \left( \frac{1}{y} T(t/x,s;x,y) \right),$$

where  $T(t,s;x,y)$  is the generating function of the 2-4-2 building blocks.

*Proof.* Let us write  $f(s;x,y) = \sum_{n \geq 1} f_n(x,y)s^n$  and  $T(t,s;x,y) = \sum_{n \geq 1} T_n(s;x,y)$ , where  $f_n(x,y)$  is the generating function of 2-4-2 polygons whose *bottom* row has length  $n$ , and  $T_n(s;x,y)$  is the generating function of 2-4-2 building blocks, whose *top* row has length  $n$ . The above recurrence becomes:

$$f(s;x,y) = \frac{ysx}{1-sx} + \sum_{n \geq 1} f_n(x,y)T_n(s;x,y)/(yx^n).$$

This follows because 2-4-2 polygon is either a rectangle of unit height (counted by  $\frac{ysx}{1-sx}$ ) or may be constructed by combining a 2-4-2 polygon, whose last row is of length  $n$  (counted by  $f_n(x,y)$ ) with a 2-4-2 polygon whose top row is of length  $n$  (counted by  $T_n(s;x,y)$ ). To explain the factor of  $1/(yx^n)$  see Figure 11; when the building block is joined to the polygon (centre) and the duplicated row is “squashed” (right), the total vertical half-perimeter is reduced by 1 (two vertical bonds are

removed) and the total horizontal half-perimeter is reduced by the length of the join (two horizontal bonds are removed for each cell in the join). Hence if the join is of length  $n$ , the perimeter weight needs to be reduced by a factor of  $(yx^n)$ .  $\square$

$\triangleleft \triangleleft \diamond \triangleright \triangleright$

While in general Hadamard products are difficult to evaluate, if one of the functions is rational then the result is quite simple. This fact allows us to translate the above Hadamard-recurrence into a functional equation.

**Lemma 24.** *Let  $f(t) = \sum_{t \geq 0} f_n t^n$  be a power series. The following (restricted) Hadamard products are easily evaluated:*

$$f(t) \odot_t \left( \frac{1}{1 - \alpha t} \right) = f(\alpha) \quad (16)$$

$$f(t) \odot_t \left( \frac{k! t^k}{(1 - \alpha t)^{k+1}} \right) = \left( \frac{\partial^k f}{\partial t^k} \right) \Big|_{t=\alpha}. \quad (17)$$

We also note that the Hadamard product is linear:

$$f(t) \odot_t (g(t) + h(t)) = f(t) \odot_t g(t) + f(t) \odot_t h(t). \quad (18)$$

*Proof.* The second equation follows from the first by differentiating with respect to  $\alpha$ . The first equation follows because

$$f(t) \odot_t \frac{1}{1 - \alpha t} = \left( \sum_{n \geq 0} f_n t^n \right) \odot_t \left( \sum_{n \geq 0} \alpha^n t^n \right) = \sum_{n \geq 0} f_n \alpha^n = f(\alpha).$$

The linearity follows directly from the definition.  $\square$

$\triangleleft \triangleleft \diamond \triangleright \triangleright$

In order to apply the above lemma, we need to rewrite  $T(t/x, s; x, y)/y$  in (a non-standard) partial fraction form:

$$T(t/x, s; x, y)/y = y^3 \left[ c_0 \cdot t^0 + \sum_{k=0}^5 c_{k+1} \frac{k! t^k}{(1-t)^{k+1}} + c_7 \frac{1}{1-st} + c_8 \frac{1}{1-stx} \right], \quad (19)$$

where the  $c_i$  are rational functions of  $s$  and  $x$ . We note that when  $s = 1$  some singularities of  $T$  coalesce and we rewrite  $T$  as:

$$T(t/x, 1; x, y)/y = y^3 \left[ \hat{c}_0 \cdot t^0 + \sum_{k=0}^6 \hat{c}_{k+1} \frac{k! t^k}{(1-t)^{k+1}} + \hat{c}_8 \frac{1}{1-tx} \right], \quad (20)$$

where the  $\hat{c}_i$  are rational functions of  $x$ . The Hadamard product  $f(t; x, y) \odot_t T(t/x, s; x, y)/y$  is then:

$$f(t; x, y) \odot_t T(t/x, s; x, y)/y = y^3 \left[ \sum_{k=0}^5 c_{k+1} \frac{\partial^k f}{\partial t^k}(1; x, y) + c_7 f(s; x, y) + c_8 f(sx; x, y) \right], \quad (21)$$

where we have made use of the fact that  $[t^0]f(t; x, y) = 0$  (there are no rows of zero length).

We do not state in full the coefficients,  $c_i$ , since they are very large and, with the exception of  $c_8$ , not particularly relevant to the following analysis. We will just state the denominators of all the coefficients, as well as the coefficient  $c_8$  in full. If we write the denominator of  $c_i$  as  $d_i$ :

$$\begin{aligned} d_0 &= (1-x)^3(1-sx)^6(1-s)^6 & d_1 &= (1-x)^3(1-sx)^5(1-s)^5 \\ d_2 &= (1-x)^3(1-sx)^3(1-s)^4 & d_3 &= (1-x)^3(1-sx)^3(1-s)^3 \\ d_4 &= (1-x)^2(1-sx)(1-s)^2 & d_5 &= (1-x)(1-sx)(1-s) \\ & & d_6 &= (1-s) & d_7 &= (1-sx)^6(1-s)^6 \\ c_8 &= -\frac{2sx^2(s^2x^2 + sx - s + 1)}{(1-sx)^4(1-x)^2}. \end{aligned} \quad (22)$$

When  $s = 1$  the coalescing poles change equation (21) to:

$$f(t; x, y) \odot_t T(t/x, 1; x, y)/y = y^3 \left[ \sum_{k=0}^6 \hat{c}_{k+1} \frac{\partial^k f}{\partial t^k}(1; x, y) + \hat{c}_8 f(x; x, y) \right] \quad (23)$$

The coefficients,  $\hat{c}_i$ , become somewhat simpler and can be stated here in full:

$$\begin{aligned} \hat{c}_0 &= -2 \frac{x^3(1+x)(2x^2+1)}{(1-x)^6} & \hat{c}_1 &= 4 \frac{(1+x)(x^2+1)x^3}{(1-x)^6} \\ \hat{c}_2 &= 2 \frac{x^2(1+x)(2x^2+x+1)}{(1-x)^5} & \hat{c}_3 &= \frac{x^2(1+x)(2x+1)}{(1-x)^4} \\ \hat{c}_4 &= \frac{1}{3} \frac{(1+x)(x^2+x+1)}{(1-x)^3} & \hat{c}_5 &= \frac{1}{12} \frac{(x^2+2x+3)}{(1-x)^2} \\ & & \hat{c}_6 &= \frac{1}{60} \frac{(x+3)}{(1-x)} & \hat{c}_7 &= \frac{1}{360} \\ \hat{c}_8 &= -2 \frac{x^3(1+x)}{(1-x)^6} = c_8|_{s=1}. \end{aligned} \quad (24)$$

**Lemma 25.** *Let  $f(s; x, y)$  be the generating function for 2-4-2 polygons enumerated by bottom row-width, half-horizontal perimeter and half-vertical perimeter ( $s, x$  and  $y$  respectively).  $f(s; x, y)$  satisfies the following functional equations:*

$$f(s; x, y) = \frac{sxy}{1-sx} + y^3 \left[ \sum_{k=0}^5 c_{k+1} \frac{\partial^k f}{\partial s^k}(1; x, y) + c_7 f(s; x, y) + c_8 f(sx; x, y) \right] \quad (25)$$

$$f(1; x, y) = \frac{xy}{1-x} + y^3 \left[ \sum_{k=0}^6 \hat{c}_{k+1} \frac{\partial^k f}{\partial s^k}(1; x, y) + \hat{c}_8 f(x; x, y) \right], \quad (26)$$

with  $c_i$  and  $\hat{c}_i$  given above.

We rewrite the generating function as  $f(s; x, y) = \sum_{n \geq 1} f_n(s; x) y^{3n-2}$ , where the coefficient  $f_n(s; x)$  is the generating function for  $\mathcal{P}_{3n-2}^{242}$ . This allows the above functional equations to be transformed into recurrences:

$$f_1(s; x) = \frac{sx}{1-sx} \quad (27)$$

$$f_{n+1}(s; x) = \sum_{k=0}^5 c_{k+1} \frac{\partial^k f_n}{\partial s^k}(1; x) + c_7 f_n(s; x) + c_8 f_n(sx; x) \quad s \neq 1 \quad (28)$$

$$f_{n+1}(1; x) = \sum_{k=0}^6 \hat{c}_{k+1} \frac{\partial^k f_n}{\partial s^k}(1; x) + \hat{c}_8 f_n(x; x). \quad (29)$$

*Proof.* Apply Lemma 24 to the partial fraction form of the transition function for general  $s$ , and when  $s = 1$ .  $\square$

### 3.4 Analysing the functional equation

By Lemma 20, we are able to prove Theorem 16 by showing that  $f_n(1; x)$  is singular at the zeros of  $\Psi_n(x)$ . We do this by induction using the recurrences in Lemma 25.

Before we can do this we need to prove the following lemma about the zeros (and hence factors) of one of the coefficients in the recurrence:

**Lemma 26.** *Consider the coefficient  $c_8(s; x)$  defined above. When  $s = x^k$ ,  $c_8(x^k, x)$  has a single zero on the unit circle at  $x = -1$  when  $k$  is even. When  $k$  is odd  $c_8(x^k, x)$  has no zeros on the unit circle.*

*Proof.* When  $s = x^k$ ,  $c_8(x^k, x)$  is

$$c_8(x^k, x) = \frac{2x^{k+2}(k^{2k+2} + x^{k+1} - x^k + 1)}{(1-x^{k+1})^4(1-x)^2}.$$

Let  $\xi$  be a zero of  $c_8(x^k, x)$  that lies on the unit circle;  $\xi$  must be a solution of the polynomial  $p_k(x) = x^{2k+2} + x^{k+1} - x^k + 1 = 0$ . Hence:

$$\begin{aligned} \xi^k - \xi^{k+1} &= \xi^{2k+2} + 1 && \text{divide by } \xi^{k+1} \\ 1/\xi - 1 &= \xi^{k+1} + \xi^{-k-1}. \end{aligned}$$

Since  $\xi$  lies on the unit circle we may write  $\xi = e^{i\theta}$ :

$$\begin{aligned} e^{-i\theta} - 1 &= e^{i(k+1)\theta} + e^{-i(k+1)\theta} \\ &= 2 \cos((k+1)\theta). \end{aligned}$$

Since the right hand-side of the above expression is real the left-hand side must also be real. Therefore  $\theta = 0, \pi$  and  $\xi = \pm 1$ . If  $\xi = 1$  then  $p_k(\xi) = 2$ . On the other hand, if  $\xi = -1$  then  $p_k(\xi) = 4$  if  $k$  is odd and is zero if  $k$  is even.

Since the denominator of  $c_8(x^k, x)$  is not zero when  $k$  is even and  $x = -1$  the result follows. One can verify that there are not multiple zeros at  $x = -1$  by examining the derivative of the numerator.  $\square$

$\triangleleft \triangleleft \diamond \triangleright \triangleright$

**Proof of Theorem 16:**

This proof for SAPs was first given in [16]. A similar (but cleaner) argument for a different class of polygons appears in [5]. We follow the latter.

Consider the recurrence given in Lemma 25. This recurrence shows that  $f_n(s; x)$  may be written as a rational function of  $s$  and  $x$ . Since  $f_n(1; x)$  is a well defined (and rational) function, the denominator of  $f_n(s; x)$  does not contain any factors of  $(1 - s)$ .

Let  $\mathbb{C}_n(s; x)$  be the set of polynomials of the form

$$\prod_{k=1}^n \Psi_k(x)^{a_k} (1 - sx^k)^{b_k}, \quad (30)$$

where  $a_k$  and  $b_k$  are non-negative integers. We define  $\mathbb{C}_n(x) = \mathbb{C}_n(0; x)$  (polynomials which are products of cyclotomic polynomials). We first prove (by induction on  $n$ ) that  $f_n$  may be written as

$$f_n(s; x) = \frac{N_n(s; x)}{(1 - sx^n)D_n(s; x)}, \quad (31)$$

where  $N_n(s; x)$  and  $D_n(s; x)$  are polynomials in  $s$  and  $x$  with the restriction that  $D_n(s; x) \in \mathbb{C}_{n-1}(s; x)$ . Then we consider what happens at  $s = 1$  and  $x$  is set to a zero of  $\Psi_k$ .

For  $n = 1$ , equation (31) is true, since  $f_1(s; x) = \frac{sx}{1-sx}$ . Now assume equation (31) is true up to  $n$  and apply the recurrence. The only term that may introduce a new zero into the denominator is  $c_8(s; x)f_n(sx; x)$ . By assumption  $f_n(s; x) = \frac{N_n(s; x)}{(1-sx^n)D_n(s; x)}$ , and  $D_n(sx; x) \in \mathbb{C}_n(s; x)$ . Hence equation (31) is true for  $n + 1$ , and so is also true for all  $n \geq 1$ .

$\triangleleft \triangleleft \diamond \triangleright \triangleright$

Let  $\xi$  be a zero of  $\Psi_k(x)$ . We wish to prove that  $f_n(1; x)$  is singular at  $x = \xi$  and we do so by proving that for  $k = 1, \dots, n$ , the generating function  $f_k(x^{n-k}; x)$  is singular at  $x = \xi$ , and then setting  $k = n$ . We proceed by induction on  $k$  for fixed  $n$ .

If we set  $k = 1$ , then we see that  $f_1(x^{n-1}; x) = \frac{x^n}{1-x^n}$ , and so the result is true. Now let  $k \geq 2$  and assume that the result is true for  $k - 1$ , ie  $f_{k-1}(x^{n-k+1}; x)$  is singular at  $x = \xi$ . The recurrence relation and equation (31) together imply

$$f_k(s; x) = \frac{N(s; x)}{D(s; x)} + c_8(s; x)f_{k-1}(sx; x), \quad (32)$$

where  $N$  and  $D$  are polynomials in  $s$  and  $x$  and  $D(s; x) \in \mathbb{C}_{k-1}(s; x)$ . Setting  $s = x^{n-k}$  yields

$$f_k(x^{n-k}; x) = \frac{N(x^{n-k}; x)}{D(x^{n-k}; x)} + c_8(x^{n-k}; x)f_{k-1}(x^{n-k+1}; x), \quad (33)$$



and we note that  $D(x^{n-k}; x) \in \mathbb{C}_{n-1}(x)$ . In the case  $k = n$  the above equation is still true, since  $\hat{c}_8 = c_8|_{s=1}$ .

Equation (33) shows that  $f_k(x^{n-k})$  is singular at  $x = \xi$  only if  $c_8(x^{n-k}; x)f_{k-1}(x^{n-k+1}; x)$  is singular at  $x = \xi$ . This is true (by assumption) unless  $c_8(x^{n-k}; x) = 0$  at  $x = \xi$ . By Lemma 26,  $c_8(x^{n-k}; x)$  is non-zero at  $x = \xi$ , except when  $n = k = 2$ .

In the case  $n = k = 2$  this proof breaks down, and indeed we see that  $H_4(x)$  is not singular at  $x = -1$ . Excluding this case,  $f_k(x^{n-k}; x)$  is singular at  $x = \xi$  and so  $f_n(1; x)$  is also singular at  $x = \xi$ . By Lemma 20,  $H_{3k-2}(x)$  is singular at  $x = \xi$ .  $\square$

$\triangleleft \triangleleft \diamond \triangleright \triangleright$

We can now prove that the self-avoiding polygon anisotropic generating function is not a D-finite function:

**Corollary 27.** *Let  $S_n$  be the set of singularities of the coefficient  $H_n(x)$ . The set  $S = \bigcup_{n \geq 1} S_n$  is dense on the unit circle  $|x| = 1$ . Consequently the self-avoiding polygon anisotropic half-perimeter generating function is not a D-finite function of  $y$ .*

*Proof.* For any  $q \in \mathbb{Q}$ , there exists  $k$ , such that  $\Psi_k(e^{2\pi i q}) = 0$ . By Theorem 16,  $H_{3k-2}(x)$  is singular at  $x = e^{2\pi i q}$ , excepting  $x = -1$ . Hence the set  $S$  is dense on the unit circle,  $|x| = 1$ . Consequently  $S$  has an infinite number of accumulation points and so  $G(x, y) = \sum H_n(x)y^n$  is not a D-finite power series in  $y$ .  $\square$

We can easily extend this result to self-avoiding polygons on hypercubic lattices.

**Corollary 28.** *Let  $\mathcal{G}_d$  be the set of self-avoiding polygons on the  $d$ -dimensional hypercubic lattice and let  $G_d$  be the anisotropic generating function*

$$G_d(x_1, \dots, x_{d-1}, y) = \sum_{P \in \mathcal{G}_d} y^{|P|_d} \prod_{i=1}^{d-1} x_i^{|P|_i},$$

where  $|P|_i$  is half the number of bonds in parallel to the unit vector  $\vec{e}_i$ . Ie when  $d = 2$  we recover the square lattice anisotropic generating function. If  $d = 1$  then the generating function is equal to zero and otherwise is a non-D-finite power series in  $y$ .

*Proof.* When  $d = 1$  then there are no self-avoiding polygons and so the generating function is trivially zero. Now consider  $d \geq 2$ . It is a standard result in the theory of D-finite power series that any well defined specialisation of a D-finite power series is itself D-finite [14]. Setting  $x_2 = \dots = x_{d-1} = 0$  in the generating function  $G_d(\mathbf{x}, y)$  recovers the square lattice generating function  $P(x, y)$ . Hence if  $G_d(\mathbf{x}, y)$  were a D-finite power series in  $y$  then it follows that  $P(x, y)$  would also be D-finite. This contradicts Corollary 27, and so the result follows.  $\square$

## 4 Discussion

We have shown that the anisotropic generating function of self-avoiding polygons on the square lattice,  $P(x, y)$ , is not a D-finite function of  $y$ . This result was then extended to prove that the anisotropic generating function of self-avoiding polygons on any hypercubic lattice is either trivial (in one dimension) or a non-D-finite function (in dimensions 2 and higher).

There exists a number of non-D-finiteness results for generating functions of other models, such as bargraphs enumerated by their site-perimeter [5], a number of lattice animal models related to heaps of dimers [4] and certain types of matchings [13]; these results rely upon a knowledge of the generating function — either in closed form or via some sort of recurrence. The result for self-avoiding polygons is, as far as we are aware, the first result on the D-finiteness of a completely unsolved model!

Unfortunately we are not able to use this result to obtain information about the nature of the isotropic generating function  $P(x, x)$ ; it is all too easy to construct a two-variable function that is not D-finite, that reduces to a single variable D-finite function. For example

$$F(x, y) = \sum_{n \geq 1} \frac{y^n}{(1-x^n)(1-x^{n+1})}. \quad (34)$$

is not a D-finite function of  $y$  by Theorem 15. Setting  $y = x$  gives a rational, and hence D-finite, function of  $x$ :

$$\begin{aligned} F(x, x) &= \sum_{n \geq 1} \frac{x^n}{(1-x^n)(1-x^{n+1})} \\ &= \frac{1}{1-x} \sum_{n \geq 1} \left( \frac{x^n}{1-x^n} - \frac{x^{n+1}}{1-x^{n+1}} \right) \\ &= \frac{x}{(1-x)^2}. \end{aligned}$$

On the other hand, the anisotropisation of *solvable* lattice models does not alter the nature of the generating function — rather it simply moves singularities around in the complex plane. Unfortunately we are unable to rigorously determine how far this phenomenon extends since we know very little about the nature of the generating functions of unsolved models.

That the self-avoiding polygon anisotropic half-perimeter generating function is not D-finite (Corollary 27) demonstrates the stark difference between the bond-animal models we have been able to solve and those we wish to solve. Solved bond-animal models (with the exception of spiral walks [1]) all have D-finite anisotropic generating functions. More general (and unsolved) models, such as bond animals and self-avoiding walks, are believed to exhibit the same dense pole structure [7, 8] as self-avoiding polygons and therefore are thought to be non-D-finite.

Two papers are in preparation to extend these results to directed bond animals, bond trees and general bond animals. We are also investigating the possibility of applying these techniques to site-animals and other combinatorial objects.

## Acknowledgements

I would like to thank a number of people for their assistance during this work.

- A. L. Owczarek, A. J. Guttmann and M. Bousquet-Mélou for supervision and advice during my PhD and beyond.
- I. Jensen for his anisotropic series data.
- R. Brak, M. Zabrocki, E. J. Janse van Rensburg and N. Madras for discussions and help with the manuscript.
- The people at LaBRI for their hospitality during my stay at the Université Bordeaux 1.

This work was partially funded by the Australian Research Council.

## References

- [1] H. W. J. Blöte and H. J. Hilhorst. Spiralling self-avoiding walks: an exact solution. *J. Phys. A: Math. Gen.*, 17:L111–L115, 1984.
- [2] M. Bousquet-Mélou. A method for the enumeration of various classes of column-convex polygons. *Discrete Math.*, 154:1–25, 1996.
- [3] M. Bousquet-Mélou, A. J. Guttmann, W. P. Orrick, and A. Rechnitzer. Inversion relations, reciprocity and polyominoes. *Annal Comb.*, 3:223–249, 1999.
- [4] M. Bousquet-Mélou and A. Rechnitzer. Lattice animals and heaps of dimers. *Discrete Math.*, 258:235–274, 2002.
- [5] M. Bousquet-Mélou and A. Rechnitzer. The site-perimeter of bargraphs. *Adv. in Appl. Math.*, 31:86–112, 2003.
- [6] I. G. Enting. Generating functions for enumerating self-avoiding rings on the square lattice. *J. Phys. A: Math. Gen.*, 13:3713–3722, 1980.
- [7] A. J. Guttmann. Indicators of solvability for lattice models. *Discrete Math.*, 217:167–189, 2000.
- [8] A. J. Guttmann and I. G. Enting. Solvability of some statistical mechanical systems. *Phys. Rev. Lett.*, 76:344–347, 1996.
- [9] B. D. Hughes. *Random walks and random environments: Vol 1 Random walks*. Clarendon Press, Oxford, 1995.
- [10] I. Jensen and A. J. Guttmann. Anisotropic series for self-avoiding polygons. Personal communication with author.

- [11] D. A. Klarner. Cell growth problems. *Canad. J. Math.*, 19:851–863, 1967.
- [12] D. A. Klarner. A combinatorial formula involving the Fredholm integral equation. *J. Combin. Theory*, 5:59–74, 1968.
- [13] M. Klazar. On non P-recursiveness of numbers of matchings (linear chord diagrams) with many crossings. *Adv. in Appl. Math.*, 30:126–136, 2003.
- [14] L. Lipshitz. D-finite power series. *J. Algebra*, 122:353–373, 1989.
- [15] N. Madras and G. Slade. *The Self-Avoiding Walk*. Birkhäuser, Boston, 1993.
- [16] A. Rechnitzer. *Some problems in the counting of lattice animals, polyominoes, polygons and walks*. PhD thesis, The University of Melbourne, 2001.
- [17] A. Rechnitzer. Haruspicy and anisotropic generating functions. *Adv. in Appl. Math.*, 30:228–257, 2003.
- [18] R.P. Stanley. *Enumerative Combinatorics*, volume I. Wadsworth and Brooks/Cole, Monterey, California, 1986.
- [19] H. N. V. Temperley. Combinatorial problems suggested by the statistical mechanics of domains and of rubber-like molecules. *Phys. Rev.*, 103:1–16, 1956.