

Lamé operators with projective octahedral and icosahedral monodromies

Keiri Nakanishi

November 18, 2004

Abstract

We show that there exists a Lamé operator L_n with projective octahedral monodromy for each $n \in \frac{1}{2}(\mathbb{N} + \frac{1}{2}) \cup \frac{1}{3}(\mathbb{N} + \frac{1}{2})$, and with projective icosahedral monodromy for each $n \in \frac{1}{3}(\mathbb{N} + \frac{1}{2}) \cup \frac{1}{5}(\mathbb{N} + \frac{1}{2})$. To this end, we construct Grothendieck's dessins d'enfants corresponding to the Belyi morphisms which pull-back hypergeometric operators into Lamé operators L_n with the desired monodromies.

1 Introduction

In this paper, we consider Lamé differential operators

$$L_n = \left(\frac{d}{dx} \right)^2 + \frac{1}{2} \left(\frac{1}{x} + \frac{1}{x-1} + \frac{1}{x-\lambda} \right) \cdot \frac{d}{dx} - \frac{n(n+1)x + B}{4x(x-1)(x-\lambda)}$$

whose solutions are algebraic over $\mathbb{C}(x)$. Here, λ is a complex number with $\lambda \neq 0, 1$, n (so-called degree parameter) is a rational number, and $B \in \mathbb{C}$ is the accessory parameter. The possible finite projective monodromies of L_n were studied by Baldassarri, Chiarellotto, and Dwork, and recently by Beukers, Dahmen, Lițcanu, van der Waall, and Zapponi. One of the most remarkable results is that there are at most finitely many equivalence classes of L_n for fixed $n \in \mathbb{Q}$ and fixed finite monodromy group. This was first done by Chiarellotto [C], and later shown by Lițcanu by using the notion of Grothendieck's dessins d'enfants [L1]. For details of the theory of Grothendieck's dessins d'enfants, see [S] and [SV]. Moreover, Chiarellotto and Lițcanu got the explicit formula for the number of equivalence classes with projective dihedral monodromy of order $2N$ for the case $n = 1$, which has been generalized more recently by Dahmen [D] for arbitrary n . They

translated the counting problem for the number of equivalence classes of Lamé operators into that for the number of the dessins compatible with the ramification data of Belyi morphisms which pull-back hypergeometric operators into the Lamé operators. This strategy is based on the Klein's theorem, which claims that a second order Fuchsian differential operator with finite projective monodromy is a rational pull-back of hypergeometric operator in the “*basic Schwarz list*”.

To carry out this program, the method of Grothendieck's dessins d'enfants by Litcanu and Dahmen provides a powerful tool. Baldassarri determined the possible finite projective monodromy groups of L_n [B2], but recently, Lițcanu got the same results and the necessary conditions for n to have fixed possible finite projective monodromy group by using the notion of Grothendieck's dessins d'enfants [L2]. By [B2] and [L2], the possible finite projective monodromy groups are dihedral group \mathcal{D}_{2N} , octahedral group \mathcal{S}_4 , or icosahedral group \mathcal{A}_5 . More recently, Lițcanu [L2] proves the following theorem:

- Theorem 1.1** ([B2], [L2] **Theorem 3.4**) (1) *If the projective monodromy group of Lamé operator L_n is dihedral, then $n \in \mathbb{Z}$*
(2) *If the projective monodromy group of Lamé operator L_n is octahedral, then $n \in \frac{1}{2}(\mathbb{Z} + \frac{1}{2}) \cup \frac{1}{3}(\mathbb{Z} + \frac{1}{2})$.*
(3) *If the projective monodromy group of Lamé operator L_n is icosahedral, then $n \in \frac{1}{3}(\mathbb{Z} + \frac{1}{2}) \cup \frac{1}{5}(\mathbb{Z} + \frac{1}{2})$.*
(4) *There is no Lamé operator with projective cyclic monodromy.*
(5) *There is no Lamé operator with projective tetrahedral monodromy.*

The proof of this theorem is based on the analysis of the Belyi morphism which pull-backs the hypergeometric operator into the Lamé operator, as well as the combinatorial data of the corresponding dessin. Conversely, the following problem arises:

Problem

- (1) *For each $n \in \mathbb{Z}$, does there exist Lamé operator L_n with projective dihedral monodromy?*
(2) *For each $n \in \frac{1}{2}(\mathbb{Z} + \frac{1}{2}) \cup \frac{1}{3}(\mathbb{Z} + \frac{1}{2})$, does there exist Lamé operator L_n with projective octahedral monodromy?*
(3) *For each $n \in \frac{1}{3}(\mathbb{Z} + \frac{1}{2}) \cup \frac{1}{5}(\mathbb{Z} + \frac{1}{2})$, does there exist Lamé operator L_n with projective icosahedral monodromy?*

If we replace n by $-n-1$, it is easy to see that $L_n = L_{-n-1}$. Hence we can assume $n > -\frac{1}{2}$. As we saw, (1) is solved by Beukers and van der Waall [BW, Theorem 5.1] and Dahmen [D]. Beukers and van der Waall [BW, Theorem 6.1] and Baldassarri [B2, (3.e)] gave some examples of Lamé operators which have projective octahedral monodromy and icosahedral monodromy.

The aim of this article is to solve (2) and (3) of the problem above. Assuming $n > -\frac{1}{2}$, we have a few possible negative n in each case. Such “exceptional” cases will be dealt with case by case in Remarks 3.3 and 3.4, where we will see that these cases can be easily dismissed. Thus we may assume $n \geq 0$. In this situation, the following theorem gives the existence of Lamé operators L_n with projective octahedral monodromy and projective icosahedral monodromy for each n as in Theorem 1.1 (2) and (3):

Main Theorem

- (1) For each $n \in \frac{1}{2}(\mathbb{N} + \frac{1}{2}) \cup \frac{1}{3}(\mathbb{N} + \frac{1}{2})$, there exists a Lamé operator L_n with projective octahedral monodromy.
- (2) For each $n \in \frac{1}{3}(\mathbb{N} + \frac{1}{2}) \cup \frac{1}{5}(\mathbb{N} + \frac{1}{2})$, there exists a Lamé operator L_n with projective icosahedral monodromy.

We will prove this theorem by constructing explicitly the dessins compatible with the ramification data of the Belyi morphisms which pull-back hypergeometric operators with the same projective monodromy group into the Lamé operators L_n for each n . From this theorem, we can see that there exist infinitely Lamé operators with projective octahedral monodromy and infinitely many ones with projective icosahedral monodromy, which seems unknown. Note that this theorem does not answer the counting problem of the numbers of the equivalence classes of Lamé operators with projective octahedral and icosahedral monodromies.

2 Preliminaries.

Our first aim in this section is to reduce the existences of the Lamé operators with projective octahedral (resp. icosahedral) monodromy to the existences of the Belyi morphisms which pull-back the hypergeometric operators with projective octahedral (resp. icosahedral) monodromies into the Lamé operators. The second aim is to reduce them to the existences of the corresponding dessins.

2.1 Hypergeometric operators and Lamé operators.

In this subsection, we review some results on hypergeometric operators, their rational pull-backs, and Lamé operators.

Let us first consider the linear differential operator on \mathbb{P}^1 :

$$L = D^n + a_1(z) \cdot D^{n-1} + \cdots + a_{n-1}(z) \cdot D + a_n(z), \quad (1)$$

with $D^i = (\frac{d}{dz})^i$ and $a_j(z)$ rational functions in $\mathbb{C}(z)$ for $1 \leq i, j \leq n$. The linear operator (1) is said to be *Fuchsian* if any point on \mathbb{P}^1 is regular or regular singular.

Throughout this paper, we treat projective monodromies of the Fuchsian operators rather than (full) monodromies of them. Let us consider the natural projection P :

$$P : GL(n, \mathbb{C}) \longrightarrow PGL(n, \mathbb{C}).$$

The monodromy group G of the operator (1) is defined in $GL(n, \mathbb{C})$. Then its natural image of G by P is said to be the *projective monodromy* of operator (1), and we denote it by PG , i.e., $PG = G \cdot Z/Z$ where $Z = \{\lambda \cdot I_n | \lambda \in \mathbb{C}^*\}$. Here, PG is a subgroup of $PGL(n, \mathbb{C})$ and determined up to conjugate.

Let us consider a second order Fuchsian operator with finite projective monodromy. If it has precisely three regular singular points, it is the so-called hypergeometric operator and it has the following normalized form

$$H_{\lambda, \mu, \nu} = \left(\frac{d}{dx} \right)^2 + \left\{ \frac{1 - \lambda^2}{4x^2} + \frac{1 - \mu^2}{4(x-1)^2} + \frac{\lambda^2 + \mu^2 + \nu^2 - 1}{4x(x-1)} \right\},$$

where $\lambda + \mu + \nu > 1$. The regular singular points of $H_{\lambda, \mu, \nu}$ are $0, 1, \infty$, and their exponent differences are λ, μ, ν , respectively. The finite projective monodromy groups of $H_{\lambda, \mu, \nu}$ are classified as in the following “*basic Schwarz list*”.

(λ, μ, ν)	projective monodromy of $H_{\lambda, \mu, \nu}$
$(1/n, 1, 1/n)$	\mathcal{C}_n : cyclic of order n
$(1/2, 1/n, 1/2)$	\mathcal{D}_{2n} : dihedral of order $2n$
$(1/2, 1/3, 1/3)$	\mathcal{A}_4 : tetrahedral
$(1/2, 1/3, 1/4)$	\mathcal{S}_4 : octahedral
$(1/2, 1/3, 1/5)$	\mathcal{A}_5 : icosahedral

In general, second order Fuchsian operators with finite projective monodromy are characterized by the following theorem by Klein.

Theorem 2.1 (Klein) *Let L be a second order Fuchsian operator with finite projective monodromy PG in normalized form on \mathbb{P}^1 , i.e. $L = (\frac{d}{dx})^2 + Q(x)$, $Q(x) \in \mathbb{C}(x)$. Then there exists a morphism $f : \mathbb{P}^1 \rightarrow \mathbb{P}^1$ which ramifies at most over the set $\{0, 1, \infty\}$, and a unique hypergeometric operator H in the Schwarz list, having the same projective monodromy PG , such that $f^*H = L$. Moreover, the morphism f as above is unique up to Möbius transformations except in the case $(\lambda, \mu, \nu) = (1/2, 1/2, 1/2)$.*

Proof. See [K] or [B1, Theorem 1.8]. \square

Let C be an algebraic curve defined over \mathbb{C} . A morphism $f : C \rightarrow \mathbb{P}^1$ is said to be *Belyi morphism* if f has at most three critical values.

A *Lamé operator* is a second order Fuchsian operator having four regular singular points on \mathbb{P}^1 with exponent differences $\frac{1}{2}, \frac{1}{2}, \frac{1}{2}$, and $|n + \frac{1}{2}|$ where n is a rational number. If its four regular singular points are $0, 1, \lambda$, and ∞ , and their exponent differences are $\frac{1}{2}, \frac{1}{2}, \frac{1}{2}$, and $|n + \frac{1}{2}|$ respectively, then, after suitable transformation, we can assume it has the following Riemann scheme :

$$\left\{ \begin{array}{cccc} x = 0 & x = 1 & x = \lambda & x = \infty \\ 0 & 0 & 0 & -\frac{n}{2} \\ \frac{1}{2} & \frac{1}{2} & \frac{1}{2} & \frac{n+1}{2} \end{array} \right\},$$

and the Lamé operator L_n has the following form:

$$L_n = \left(\frac{d}{dx} \right)^2 + \frac{1}{2} \left(\frac{1}{x} + \frac{1}{x-1} + \frac{1}{x-\lambda} \right) \cdot \frac{d}{dx} - \frac{n(n+1)x + B}{4x(x-1)(x-\lambda)},$$

where $B \in \mathbb{C}$ is the accessory parameter. Therefore, if there exists a Belyi morphism $f : \mathbb{P}^1 \rightarrow \mathbb{P}^1$ satisfying the following condition (★) bellow, then $f^*H_{\lambda, \mu, \nu}$ is a Lamé operator.

Condition (★) : $f^*H_{\lambda, \mu, \nu}$ has four regular singular points $0, 1, \lambda$, and ∞ and their exponent differences are $\frac{1}{2}, \frac{1}{2}, \frac{1}{2}$, and $|n + \frac{1}{2}|$ respectively.

We summarize some facts about pull-backs of Fuchsian operators. We refer to [vdW, Ch.2] for details.

Proposition 2.2 *Let L be a Fuchsian operator on \mathbb{P}^1 , and $f : \mathbb{P}^1 \rightarrow \mathbb{P}^1$ be a morphism. Then f^*L is again Fuchsian.*

Proof. See [vdW, Proposition 2.6.3]. \square

Proposition 2.3 *Let L be a Fuchsian operator on \mathbb{P}^1 with projective monodromy PG_L , and f^*L is a pull-back by a morphism $f : \mathbb{P}^1 \rightarrow \mathbb{P}^1$, with projective monodromy PG_{f^*L} . Then PG_{f^*L} is conjugate in $PGL(2, \mathbb{C})$ to a subgroup of PG .*

Proof. See [vdW, Corollary 2.6.10]. \square

Corollary 2.4 *Let $f : \mathbb{P}^1 \rightarrow \mathbb{P}^1$ be a Belyi morphism satisfying the condition (\star) , $H_{1/2,1/3,1/4}$ (resp. $H_{1/2,1/3,1/5}$) the hypergeometric operator with projective octahedral (resp. icosahedral) monodromy. Let $n \in \frac{1}{2}(\mathbb{Z} + \frac{1}{2}) \cup \frac{1}{3}(\mathbb{Z} + \frac{1}{2}) \cup \frac{1}{5}(\mathbb{Z} + \frac{1}{2})$. Then the second order Fuchsian operator $f^*H_{1/2,1/3,1/4}$ (resp. $f^*H_{1/2,1/3,1/5}$) have projective octahedral (resp. icosahedral) monodromy.*

Proof. By Theorem 1.1, the projective monodromy of $f^*H_{1/2,1/3,1/4}$ is octahedral or icosahedral, and by Proposition 2.3, it must be conjugate to a subgroup of projective octahedral group. But projective icosahedral group cannot be conjugate to a subgroup of projective octahedral group, then the projective monodromy of $f^*H_{1/2,1/3,1/4}$ is octahedral. The icosahedral case is proved similarly. \square

By this Corollary, the construction of Lamé operator with projective octahedral monodromy amounts to the construction of the Belyi morphism satisfying the condition (\star) .

2.2 Belyi morphisms and Grothendieck's dessins d'enfants.

This subsection gives some reviews about *Grothendieck's dessins d'enfants*. For more details, we refer to [S] and [SV]. Let us first recall Belyi's Theorem.

Theorem 2.5 (Belyi's Theorem) *Let X be an algebraic curve over \mathbb{C} . Then X is defined over $\bar{\mathbb{Q}}$ if and only if there exist a morphism $\beta : X \rightarrow \mathbb{P}^1(\mathbb{C})$ which ramifies at most over $\{0, 1, \infty\}$.*

Proof. Well-known; see [Be] or [S, Theorem I.2]. \square

Let $\beta : X \rightarrow \mathbb{P}^1$ be a Belyi morphism. For a point $P \in X$, we denote by e_P the ramification index at P of β . The Belyi morphism β is said to be *clean* if $e_P = 2$ for any $P \in \beta^{-1}(1)$, and *preclean* if $e_P \leq 2$ for any $P \in \beta^{-1}(1)$. Consider a pair (X, β) consisting of a complex algebraic curve defined over $\bar{\mathbb{Q}}$ and a morphism $\beta : X \rightarrow \mathbb{P}^1$. The pair (X, β) is said to be a *Belyi pair* if the morphism β ramifies at most over $\{0, 1, \infty\}$. Two pairs

(X, β) and (Y, α) are said to be *isomorphic* if there exists an isomorphism $\phi : X \rightarrow Y$ such that $\beta = \alpha \circ \phi$.

Definition 2.6 (Dessins d'enfants) Let X be a compact Riemann surface, X_1 a connected 1-complex, X_0 the set of vertices of X_1 , $[\iota]$ an isotopical class of inclusions $\iota : X_1 \hookrightarrow X$. The triple $D = (X_0 \subset X_1, [\iota])$ is said to be *Grothendieck's dessin d'enfant* on X if D satisfies the following conditions:

- (1) The complement of X_0 in X_1 is a finite disjoint union of segments and each segment is homeomorphic to the interval $(0, 1)$.
- (2) The complement of $\iota(X_1)$ in X is a finite disjoint union of open cells (simply connected regions).
- (3) Each element of X_0 is equipped with the mark “•” or “*” and if two different elements of X_0 are connected by a segment, one is equipped with “•” and another “*”.

Definition 2.7 Two Grothendieck's dessins $D = (X_0 \subset X_1, [\iota])$ on X and $D' = (X'_0 \subset X'_1, [\iota'])$ on X' are said to be *equivalent* if there exists a homeomorphism $\phi : X \rightarrow X'$ such that $\phi|_{\iota(X_1)} : \iota(X_1) \rightarrow \iota'(X'_1)$ and $\phi|_{\iota(X_0)} : \iota(X_0) \rightarrow \iota'(X'_0)$ are homeomorphisms.

Definition 2.8 A Grothendieck's dessin $D = (X_0 \subset X_1, [\iota])$ is said to be *preclean* if all vertices with the mark “*” have valencies ≤ 2 . If all vertices with the mark “*” have valencies 2, D is said to be *clean*.

Let (X, β) be a Belyi pair. Then from the Belyi pair (X, β) , we can construct a dessin $D = (\beta^{-1}(\{0, 1\}) \subset \beta^{-1}([0, 1]))$ by putting the mark “•” on the vertices of $\beta^{-1}(0)$, and “*” on the vertices of $\beta^{-1}(1)$.

Theorem 2.9 (Grothendieck Correspondence) *This correspondence gives a bijection between the set of isomorphic classes of preclean Belyi pairs and the set of equivalence classes of preclean dessins.*

Proof. See [S, Theorem I.5]. \square

The procedure for getting Belyi pairs from dessins is given in [S, Chapter I, §3]. By this correspondence, the most important thing is that the ramification multiplicities of points in $\beta^{-1}(0)$ (resp. $\beta^{-1}(1)$) are translated to the valencies of “•” (resp. “*”).

By Grothendieck Correspondence, we can construct Lamé operator L_n with projective octahedral and icosahedral monodromy, if there exists a

dessin d'enfant corresponding to a Belyi morphism which satisfies the condition (★). In the next section, we are going to construct the dessins that the corresponding Belyi morphisms satisfies the condition (★) for each n .

Definition 2.10 A Belyi morphism $f : \mathbb{P}^1 \rightarrow \mathbb{P}^1$ is said to be **-morphism* if $\{0, 1, \infty\} \subseteq f^{-1}(\{0, 1, \infty\})$.

Remark 2.11 Under the action of $PGL(2, \mathbb{C})$, any Belyi morphism $f : \mathbb{P}^1 \rightarrow \mathbb{P}^1$ is transformed to a *-morphism.

3 Constructions of the Dessins.

3.1 The case of projective octahedral monodromy.

We start this subsection by preparing some notations. We denote a second order Fuchsian differential operator on \mathbb{P}^1 by L and its exponent difference at $P \in \mathbb{P}^1$ by $\Delta_{P,L}$. Set $\Delta_L = \sum_{P \in \mathbb{P}^1} (\Delta_{P,L} - 1)$.

We need the following useful lemma.

Lemma 3.1 ([BD] Lemma 1.5) *Let $f : \mathbb{P}^1 \rightarrow \mathbb{P}^1$ be a morphism, and L a Fuchsian second order differential operator. Then*

$$\deg(f) = \frac{\Delta_{f^*L} + 2}{\Delta_L + 2}.$$

Proof. This is the genus 0 case of [BD, Lemma 1.5]. Let $Q \in \mathbb{P}^1$, $P \in \mathbb{P}^1$ be points with $f(Q) = P$. If α_1, α_2 are local exponents of L at P , then the local exponents of f^*L at Q are $\alpha_1 \cdot e_{Q,f}$ and $\alpha_2 \cdot e_{Q,f}$ where $e_{Q,f}$ is the ramification index of f at Q . Thus we get

$$\Delta_{Q,f^*L} = \Delta_{P,L} \cdot e_{Q,f},$$

whence having

$$\sum_{Q \rightarrow P} \Delta_{Q,f^*L} = \deg(f) \cdot \Delta_{P,L}.$$

Now let S be finite subset of \mathbb{P}^1 and put

$$\Delta(L, S) = \sum_{P \in S} (\Delta_{P,L} - 1).$$

Here we have

$$\Delta(f^*L, f^{-1}(S)) + \#f^{-1}(S) = \deg(f) \cdot \{\Delta(L, S) + \#S\}, \quad (2)$$

and by Riemann-Hurwitz formula,

$$-2 + 2 \cdot \deg(f) = \deg(f) \cdot (\#S) - \#f^{-1}(S). \quad (3)$$

When we take $\#S$ sufficiently large, (2) and (3) imply

$$\deg(f) \cdot (\Delta_L + 2) = \Delta_{f^*L} + 2,$$

and the lemma follows. \square

Let L_n denote a Lamé operator with projective octahedral monodromy. By Theorem 1.1, we have $n \in \frac{1}{2}(\mathbb{N} + \frac{1}{2}) \cup \frac{1}{3}(\mathbb{N} + \frac{1}{2})$. As we saw in §2.1, there is a $*$ -morphism such that $L_n = f^*H_{1/2,1/3,1/4}$. We want to construct such a $*$ -morphism $f : \mathbb{P}^1 \rightarrow \mathbb{P}^1$.

In the octahedral case, by Lemma 3.1,

$$\deg(f) = 12n,$$

and Riemann-Hurwitz formula implies

$$\#f^{-1}(\{0, 1, \infty\}) = 12n + 2.$$

Then we can assume $f^{-1}(\{0, 1, \infty\}) = \{0, 1, \lambda, \infty, a_1, \dots, a_{12n-2}\}$ where, a_1, \dots, a_{12n-2} denote distinct points different from $0, 1, \lambda, \infty$, and thus, possible ramification data of such an f is given as follows:

	0	1	λ	∞	a_1, \dots, a_{12n-2}	deg
0	0, 1	0, 1	0, 1	0, $2n + 1$	0, 2	$12n$
1	0	0	0	0, $3n + \frac{3}{2}$	0, 3	$12n$
∞	0, 2	0, 2	0, 2	0, $4n + 2$	0, 4	$12n$

Here, we explain how to read this table. For $P \in \{0, 1, \infty\}$ (an entry of the first column) and $Q \in \{0, 1, \infty, a_1, \dots, a_{12n-2}\}$ (an entry of the first row), the possible ramification index of f at P is written in the corresponding entry (i.e., (Q, P) -th entry); the number 0 occurs when $f(Q) \neq P$. These values $e_{Q,P}$ are calculated by the formula

$$\Delta_{Q,L_n} = e_{Q,f} \cdot \Delta_{P,H}$$

where $H = H_{1/2, 1/3, 1/4}$. Moreover, these values must satisfy the following compatibility conditions:

- (1) The summation of every row is equal to $\deg(f)$.
- (2) Every column contains only one non-zero number.

Let us ask, conversely, if we can construct the $*$ -morphism f , or what amounts to the same, the corresponding dessin, starting from a table as above which satisfies the above compatibility conditions for each $n \in \frac{1}{2}(\mathbb{N} + \frac{1}{2}) \cup \frac{1}{3}(\mathbb{N} + \frac{1}{2})$.

(1) The case for $n \in \frac{1}{2}(\mathbb{N} + \frac{1}{2})$

	0	1	λ	∞	a_1, \dots, a_{12n-2}	deg
0	1	1	1	0	$(6n - \frac{3}{2})$ pts with $mult. = 2$	$12n$
1	0	0	0	0	$4n$ pts with $mult. = 3$	$12n$
∞	0	0	0	$4n + 2$	$(2n - \frac{1}{2})$ pts with $mult. = 4$	$12n$

If the dessin has N loops with valency 4,

$$N = 2n - \frac{1}{2} \Leftrightarrow n = \frac{1}{2}(N + \frac{1}{2}) \in \frac{1}{2}(\mathbb{N} + \frac{1}{2})$$

and then the table becomes the following.

	0	1	λ	∞	a_1, \dots, a_{12n-2}	deg
0	1	1	1	0	$3N$ pts with $mult. = 2$	$6N + 3$
1	0	0	0	0	$(2N + 1)$ pts with $mult. = 3$	$6N + 3$
∞	0	0	0	$2N + 3$	N pts with $mult. = 4$	$6N + 3$

So it suffices to construct the dessins compatible with the table for all $N \in \mathbb{N}$. Now, we construct dessins.

For $N = 0$,

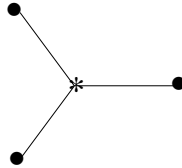

For $N = 1$,

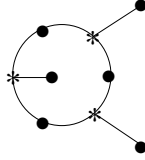

For $N = 2$,

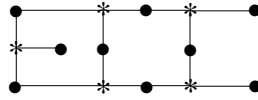

For $N = k \geq 2$,

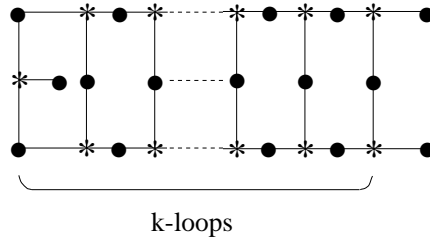

It is easy to check that these are the dessins we want, and thus we could draw dessins inductively for all $N \in \mathbb{N}$.

Remark 3.2 For each $N \geq 1$, our dessin drawn above is one of those which are compatible with the table. There may exist other dessins compatible with the table.

(2) The case for $n \in \frac{1}{3}(\mathbb{N} + \frac{1}{2})$

	0	1	λ	∞	a_1, \dots, a_{12n-2}	deg
0	1	1	0	0	$(6n - 1)$ pts with $mult. = 2$	$12n$
1	0	0	0	$3n + \frac{3}{2}$	$(3n - \frac{1}{2})$ pts with $mult. = 3$	$12n$
∞	0	0	2	0	$(3n - \frac{1}{2})$ pts with $mult. = 4$	$12n$

If the dessin has N loops with valency 4,

$$N = 3n - \frac{1}{2} \Leftrightarrow n = \frac{1}{3}(N + \frac{1}{2}) \in \frac{1}{3}(\mathbb{N} + \frac{1}{2})$$

and then the table becomes the following.

	0	1	λ	∞	a_1, \dots, a_{12n-2}	deg
0	1	1	0	0	$2N$ pts with <i>mult.</i> = 2	$4N + 2$
1	0	0	0	$N + 2$	N pts with <i>mult.</i> = 3	$4N + 2$
∞	0	0	2	0	N pts with <i>mult.</i> = 4	$4N + 2$

As in the previous case, it suffices to construct the dessins compatible with the table for all $N \in \mathbb{N}$.

Now, we construct dessins. (For each $N \geq 1$, our dessin is one of those which are compatible with the table.)

For $N = 0$,

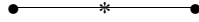

For $N = 1$,

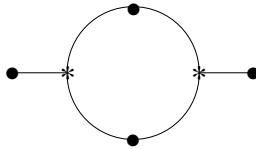

For $N = 2$,

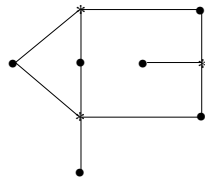

For $N = 3$,

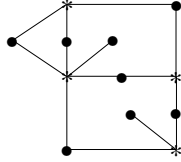

For $N = 4$,

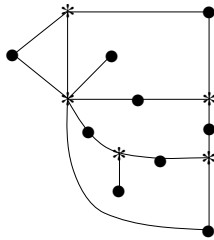

For $N = 5$,

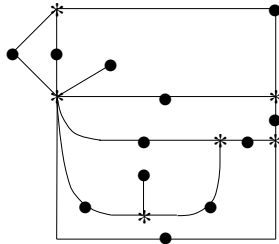

For $N = 6$,

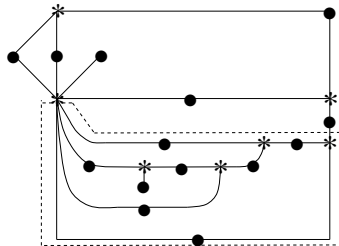

For $N \geq 6$, we can construct dessins inductively according to the following operations. We operate the lower-half part of the dessin. (We draw only the part which is enclosed by the dotted line in the dessin of $N = 6$.)

If the dessin with N loops is

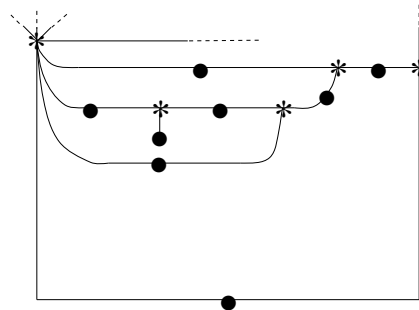

then the dessin with $N + 1$ loops is obtained by

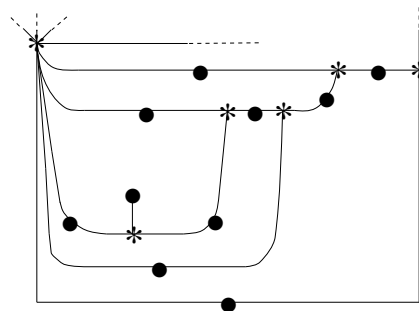

and the dessin with $N + 2$ loops is obtained by

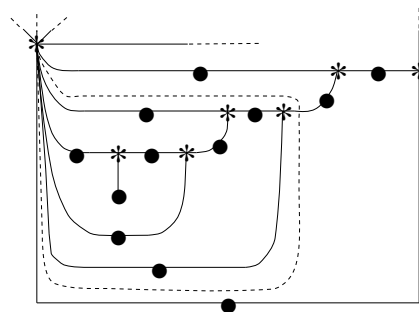

We can see that the part which is enclosed by the dotted line in the above dessin repeatedly appears when N is even. Also we can easily see that dessins inductively constructed by this operation are compatible with the table above. In fact, in each step of this operation, the number of “•” with valency 2 increase by two, that of “*” with valency 3 increase by one, that of edges increase by four, and that of loops having a_i in the fiber over ∞ with valency 4 inside increase by one.

Remark 3.3 As we saw in the introduction, we can assume degree parameter $n > -1/2$. If there exists Lamé operator with projective octahedral monodromy for $n = -1/4$ (resp. $n = -1/6$), there would exist Belyi morphism which pull-backs $H_{1/2,1/3,1/4}$ into $L_{-1/4}$ (resp. $L_{-1/6}$). But this morphism has to have negative degree, and hence the corresponding dessin does not exist. Therefore, the Lamé operator with projective octahedral monodromy for $n = -1/4$ and $n = -1/6$ do not exist.

3.2 The case of projective icosahedral monodromy.

As in the previous subsection, We want $*$ -morphism $f : \mathbb{P}^1 \rightarrow \mathbb{P}^1$ such that $L_n = f^*H_{1/2,1/3,1/5}$ for $n \in \frac{1}{3}(\mathbb{N} + \frac{1}{2}) \cup \frac{1}{5}(\mathbb{N} + \frac{1}{2})$.

Lemma 3.1 and Riemann-Hurwitz formula implies

$$\#f^{-1}(\{0, 1, \infty\}) = 30n + 2.$$

So we can assume $f^{-1}(\{0, 1, \infty\}) = \{0, 1, \lambda, \infty, a_1, \dots, a_{30n-2}\}$, and possible ramification data of f is according to the following table.

	0	1	λ	∞	a_1, \dots, a_{12n-2}	deg
0	1	1	1	$0, 2n + 1$	$0, 2$	$30n$
1	0	0	0	$0, 3n + \frac{3}{2}$	$0, 3$	$30n$
∞	0	0	0	$0, 5n + \frac{5}{2}$	$0, 5$	$30n$

In this subsection, we construct dessins compatible with the ramification data above for each $n \in \frac{1}{3}(\mathbb{N} + \frac{1}{2}) \cup \frac{1}{5}(\mathbb{N} + \frac{1}{2})$.

(3) The case for $n \in \frac{1}{3}(\mathbb{N} + \frac{1}{2})$

	0	1	λ	∞	a_1, \dots, a_{12n-2}	deg
0	1	1	1	0	$(15n - \frac{3}{2})$ pts with $mult. = 2$	$30n$
1	0	0	0	$3n + \frac{3}{2}$	$(9n - \frac{1}{2})$ pts with $mult. = 3$	$30n$
∞	0	0	0	0	$6n$ pts with $mult. = 5$	$30n$

When we have $n \in \frac{1}{3}(\mathbb{N} + \frac{1}{2})$, $6n$ is odd and we can put $6n = 2M + 1$ where $M \in \mathbb{N}$. Then the table becomes the following.

	0	1	λ	∞	a_1, \dots, a_{12n-2}	deg
0	1	1	1	0	$(5M + 1)$ pts with $mult. = 2$	$10M + 5$
1	0	0	0	$M + 2$	$(3M + 1)$ pts with $mult. = 3$	$10M + 5$
∞	0	0	0	0	$(2M + 1)$ pts with $mult. = 5$	$10M + 5$

So it suffices to construct the dessins compatible with the table for all $M \in \mathbb{N}$.
 Now, we construct dessins. (For each $M \geq 1$, our dessin is one of those which are compatible with the table.)

For $M = 0$,

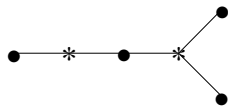

For $M = 1$,

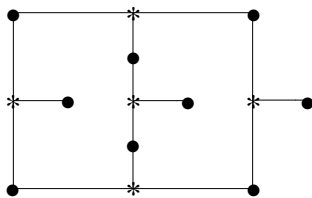

For $M = 2$,

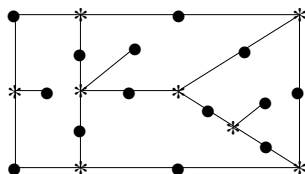

For $M = 3$,

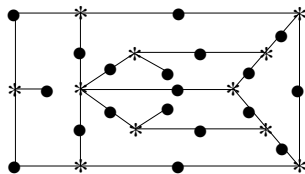

For $M = 4$,

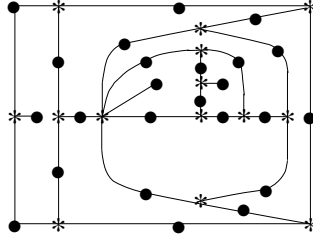

For $M = 5$,

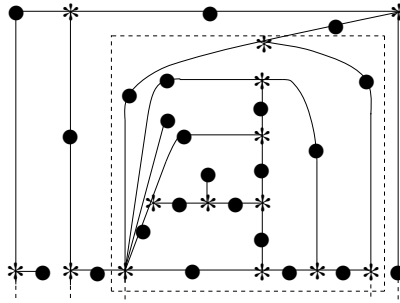

(We draw only the upper-half part, the lower part looks like the same as $M = 4$.)

For $M = 6$,

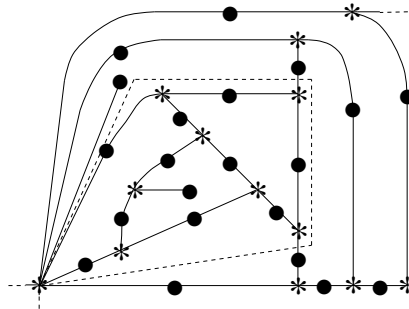

(We draw only the main part which is enclosed by the dotted line in the dessin of $M = 5$, the other parts are same as $M = 5$.)

For $M \geq 6$, we can construct dessins inductively according to the following operations. We operate the upper half part of the dessin. (We draw only the main part that is enclosed by the dotted line in the dessin of $M = 6$.)

If the dessin with $M = 2m$ loops is

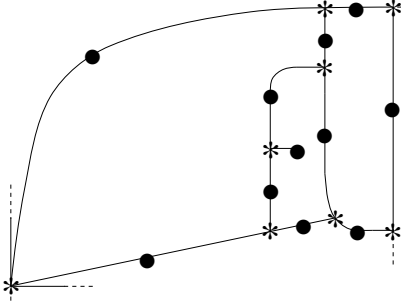

then the dessin with $2m + 1$ loops is obtained by

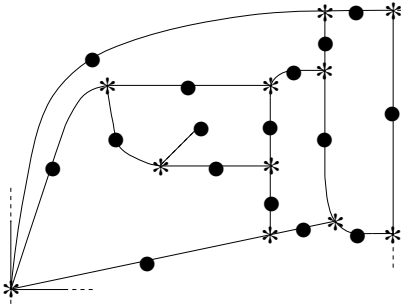

and the dessin with $2m + 2$ loops is obtained by

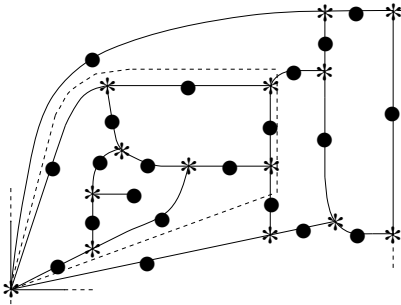

We can easily see that the part which is enclosed by the dotted line in the above dessin repeatedly appears when M is even and that dessins inductively constructed by this operation are compatible with the table.

(4) The case for $n \in \frac{1}{5}(\mathbb{N} + \frac{1}{2})$

	0	1	λ	∞	a_1, \dots, a_{12n-2}	deg
0	1	1	1	0	$(15n - \frac{3}{2})$ pts with <i>mult.</i> = 2	$30n$
1	0	0	0	0	$10n$ pts with <i>mult.</i> = 3	$30n$
∞	0	0	0	$5n + \frac{5}{2}$	$(5n - \frac{1}{2})$ pts with <i>mult.</i> = 5	$30n$

If the dessin has N loops with valency 5,

$$N = 5n - \frac{1}{2} \Leftrightarrow n = \frac{1}{5}(N + \frac{1}{2}) \in \frac{1}{5}(\mathbb{N} + \frac{1}{2})$$

and then the table becomes the following.

	0	1	λ	∞	a_1, \dots, a_{12n-2}	deg
0	1	1	1	0	$3N$ pts with <i>mult.</i> = 2	$6N + 3$
1	0	0	0	0	$(2N + 1)$ pts with <i>mult.</i> = 3	$6N + 3$
∞	0	0	0	$N + 3$	N pts with <i>mult.</i> = 5	$6N + 3$

So it suffices to construct the dessins compatible with the table for all $N \in \mathbb{N}$. Now, we construct dessins. (For each $N \geq 1$, our dessin is one of those which are compatible with the table.)

For $N = 0$,

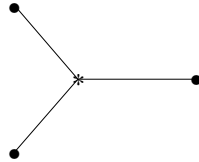

For $N = 1$,

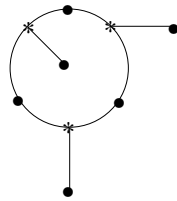

For $N = 2$,

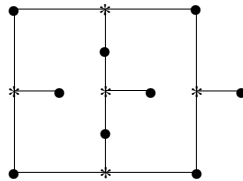

For $N = 3$,

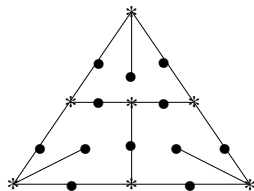

For $N = 4$,

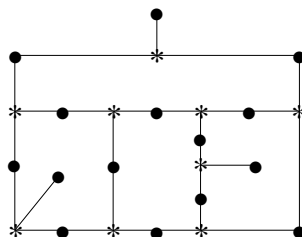

For $N = 5$,

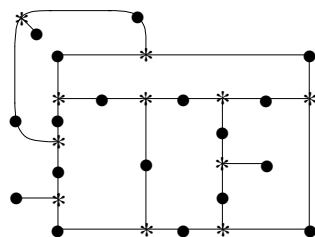

For $N = 6$,

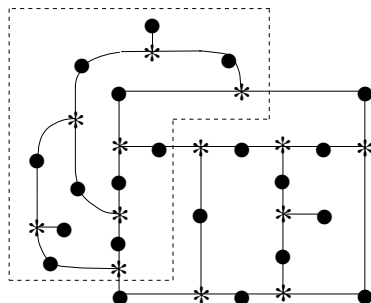

For $N \geq 6$, we can construct dessins inductively according to the following operations. We operate the left side of the dessin. (We draw only the main part which is enclosed by the dotted line in the dessin of $N = 6$.)

If the dessin with $N = 2k, (k \geq 3)$ loops is

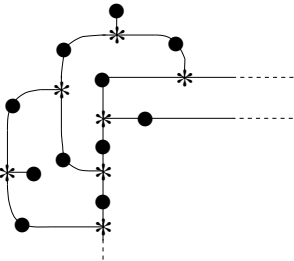

then the dessin with $N + 1 = 2k + 1$ loops is obtained by

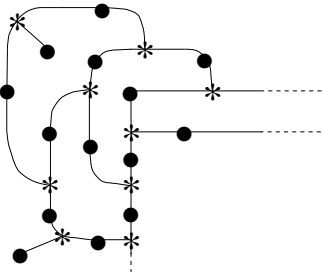

and the dessin with $N + 2 = 2k + 2$ loops is obtained by

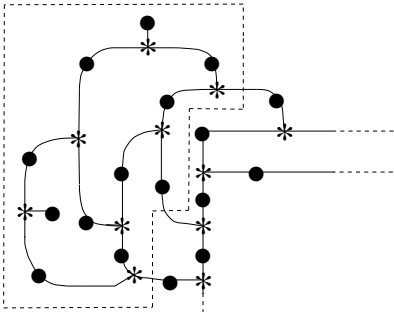

We can easily see that the part which is enclosed by the dotted line in the above dessin repeatedly appears when N is even and that dessins inductively constructed by this operation are compatible with the table.

Remark 3.4 The “exceptional” values of n in icosahedral case are $n = -1/6$ and $n = -1/10$. Similarly to the case of octahedral monodromy, we can show that these cases do not occur.

Acknowledgements. I would like to thank Răzvan Lițcanu for showing me the new version of [L2]. I am deeply grateful to my adviser, Professor Fumiharu Kato for his advice and support. Thanks are also due to Masao Aoki and Koki Itoh for their useful comments.

References

- [Be] G. V. Belyi, Galois extensions of a maximal cyclotomic field, *Math. USSR Izv.* **14** (1980) no.2. 247-256.
- [BD] F. Baldassarri and B. Dwork, On second order differential equations with algebraic solutions, *Amer.J.Math.* **101** (1979) 42-76.
- [B1] F. Baldassarri, On second order linear differential equations on algebraic curves. *Amer.J.Math.* **102** (1980) 517-535.
- [B2] F. Baldassarri, On algebraic solutions of Lamé’s differential equations. *J.Differential Equations.* **41** (1981) 44-58.
- [BW] F. Beukers and A van der Waall, Lamé equations with algebraic solutions. *J.Differential Equations.* **197** (2004) no.1. 1-25.
- [C] B. Chiarellotto, On Lamé operators which are pull backs of hypergeometric ones. *Trans.Amer.Math.Soc.* **347** (1995) no.8. 2753-2780.
- [D] S. Dahmen, Counting Integral Lamé Equations by Means of Dessins d’Enfants. arXiv:math.CA/0311510.
- [K] F. Klein, Vorlesungen über das Ikosaeder. B. G. Teubner, Leipzig, 1884.
- [L1] R. Lițcanu, Counting Lamé differential operators. *Rend. Sem. Mat. Univ. Padova.* **107** (2002) 191-208.
- [L2] R. Lițcanu, Lamé operators with finite monodromy - a combinatorial approach. *J.Differential Equations.* doi:10.1016/j.jde.2004.08.012.

- [M] R. S. Maier, Algebraic solutions of the Lamé equation, revisited. *J. Differential Equations* **198** (2004) no.1 16-34.
- [S] L. Schneps, Dessins d'enfants on the Riemann sphere, in L. Schneps (Ed.), "The Grothendieck theory of dessins d'enfants", London Math. Soc. Lecture Note Series 200, Cambridge Univ. Press, 1994.
- [SV] G. B. Shabat and V. A. Voevodsky, Drawing Curves over number fields, in P. Cartier et al (Eds.), "Grothendieck Festschrift III", Progress in Math. 88, Birkhäuser, Basel. 1990, 199-227.
- [vdW] A. van der Waall, Lamé Equations with Finite Monodromy. *Universiteit Utrecht*, Thesis, 2002.
- [Z] L.Zapponi, Some arithmetic properties of Lamé operators with dihedral monodromy. arXiv:math.AG/0403287.

Department of Mathematics, Faculty of Science, Kyoto University, Kyoto 606-8502, JAPAN.

E-mail: nakanisi@math.kyoto-u.ac.jp