

Quantum affine Cartan matrices, Poincaré series of binary polyhedral groups, and reflection representations

Ruedi Suter

*Institut für Theoretische Physik,
Eidgenössische Technische Hochschule Zürich,
ETH Hönggerberg, 8093 Zürich, Switzerland*

e-mail: `suter@math.ethz.ch`

March 24, 2005

1 Introduction

One of the first results in Lie representation theory is that the symmetric powers $S^n(\mathbb{C}^2)$ (for $n \in \mathbb{Z}_{\geq 0}$) of the standard representation \mathbb{C}^2 of $SU(2)$ are representatives for the list of equivalence classes of the irreducible complex representations of $SU(2)$. Take a finite subgroup $\Gamma \subseteq SU(2)$ and let i be an irreducible complex representation of Γ . It is a basic question to ask what is the multiplicity of i in the restriction of $S^n(\mathbb{C}^2)$ to Γ . This question has been addressed and answered by Kostant [Ko1] in a beautiful way. A crucial ingredient in his approach is a Coxeter transformation c_{aff} of the affine Weyl group associated to Γ via the McKay correspondence [McK1, McK2, St]. Kostant writes c_{aff} as a product of two involutions r_1 and r_2 where r_1 and r_2 themselves are products of commuting simple reflections. This is only possible if the affine Coxeter-Dynkin diagram has no odd cycle. Hence type A_{2n} must be omitted in this approach. In a somewhat different context Springer [Sp1] reproved Kostant's results in his paper in the *Mathematische Annalen* volume dedicated to Hirzebruch on his sixtieth birthday. See also [Sp2]. Earlier papers by Gonzalez-Sprinberg and Verdier [G-SVe] as well as by Knörrer [Kn] also deal with the question stated above (but their main goal was something else, namely, the McKay correspondence and singularity theory). They used that Γ is an index 2 subgroup of a complex reflection group.

As is often the case in well developed and elementary subjects, one can hardly avoid rediscovering previously known results. In the first few sections I shall show how one can derive some invariant theoretic results very easily and quickly by using quantum affine Cartan matrices. In this largely expository part I tried to avoid too much overlap with

other expositions, and I hope that even the informed reader will find here some new aspects. Sect. 8 displays for each pair (Γ, i) where Γ is a (binary) tetrahedral, octahedral, or icosahedral group and i is an irreducible representation of Γ a homomorphism into a finite complex reflection group G such that the reflection representation of G restricts to the representation i of Γ .

There were two main stimuli for writing the present note. The first was McKay's short paper on semi-affine Coxeter-Dynkin diagrams in the issue of the Canadian Journal of Mathematics dedicated to Coxeter on his ninetieth birthday [McK3], and the second was a recent preprint of Kostant's [Ko2] which came to me as an inspiration to dig out and complete my notes from 2000/2001.

Acknowledgements. I am pleased to thank Jürg Fröhlich for inviting me to visit ETH Hönggerberg and ITP at ETH Zürich for its hospitality and financial support.

2 McKay's correspondence

The starting point is the same as in Kostant's paper: we accept the McKay correspondence. It establishes a one-to-one correspondence between the set of conjugacy classes of finite subgroups of $SU(2)$ and the set of simply-laced (types A, D, E) affine Coxeter-Dynkin diagrams, and it gives the character table of such a finite subgroup Γ in terms of eigenvectors of the corresponding affine Cartan matrix. What we actually need from the McKay correspondence other than the one-to-one correspondence alluded to above is the following corollary.

Corollary 2.1 (Corollary to the McKay correspondence) *Let Γ be a finite subgroup of $SU(2)$. Its unitary dual $\widehat{\Gamma}$ can then be identified with the set of vertices in the affine Coxeter-Dynkin diagram associated to Γ via the McKay correspondence. (The affine vertex thereby corresponds to the trivial 1-dimensional representation.) Let $\mathbf{st} = \mathbb{C}^2|_{\Gamma}$ (which we will sometimes simply write as \mathbb{C}^2 for easier readability) denote the standard representation of Γ , which comes from the inclusion $\Gamma \subseteq SU(2)$. For $i \in \widehat{\Gamma}$ the tensor product $\mathbf{st} \otimes i$ decomposes as*

$$\mathbf{st} \otimes i \cong \bigoplus_{j \in N(i)} j \tag{2.1}$$

where $N(i)$ is the (multi-)set of neighbours of i , i. e., consists of those vertices in $\widehat{\Gamma}$ that are connected to i by an edge. For instance, if we write $\mathbf{1}$ for the trivial 1-dimensional representation, then $\mathbf{st} \cong \bigoplus_{j \in N(\mathbf{1})} j$. Actually, \mathbf{st} is irreducible unless Γ is a cyclic group.

(And if Γ has order 1 or 2, then the neighbours count with multiplicity 2.)

Definition 2.2 For $i \in \widehat{\Gamma}$ we define the generating function (Poincaré series)

$$P_i(t) := \sum_{n=0}^{\infty} \dim \operatorname{Hom}_{\Gamma}(i, S^n(\mathbb{C}^2)) \cdot t^n$$

whose t^n coefficient is the multiplicity of i in $S^n(\mathbb{C}^2)$.

Consider the classical $SU(2)$ (or its restriction to Γ) Clebsch-Gordan decomposition

$$\mathbb{C}^2 \otimes S^n(\mathbb{C}^2) \cong S^{n+1}(\mathbb{C}^2) \oplus S^{n-1}(\mathbb{C}^2) \quad (2.2)$$

for $n \in \mathbb{Z}_{\geq 0}$. In an explicit realization as a space of polynomials, we can think of \mathbb{C}^2 as a space of linear polynomials in two variables and of $S^n(\mathbb{C}^2)$ as a space of homogeneous binary polynomials of degree n . So on the left side we see a space of bihomogeneous polynomials in $2 + 2$ variables of bidegree $(1, n)$ (and in particular of total degree $n + 1$). So also the space on the right side can be realized by the same space of bihomogeneous polynomials. Taking into account the degrees and using the McKay correspondence, we arrive at the equation

$$(1 + t^2)P_i(t) - \delta_i = t \sum_{j \in N(i)} P_j(t) \quad (2.3)$$

with $\delta_1 = 1$ and $\delta_i = 0$ for $1 \neq i \in \widehat{\Gamma}$. If you prefer to see a step-by-step derivation of formula (2.3), here is one:

$$\begin{aligned} & (1 + t^2)P_i(t) - \delta_i \\ &= \sum_{n=0}^{\infty} \dim \operatorname{Hom}_{\Gamma}(i, S^n(\mathbb{C}^2)) \cdot t^n - \delta_i + \sum_{n=0}^{\infty} \dim \operatorname{Hom}_{\Gamma}(i, S^n(\mathbb{C}^2)) \cdot t^{n+2} \\ &= t \left(\sum_{n=0}^{\infty} \dim \operatorname{Hom}_{\Gamma}(i, S^{n+1}(\mathbb{C}^2)) \cdot t^n + \sum_{n=0}^{\infty} \dim \operatorname{Hom}_{\Gamma}(i, S^{n-1}(\mathbb{C}^2)) \cdot t^n \right) \\ &= t \sum_{n=0}^{\infty} \dim \operatorname{Hom}_{\Gamma}(i, S^{n+1}(\mathbb{C}^2) \oplus S^{n-1}(\mathbb{C}^2)) \cdot t^n \\ &= t \sum_{n=0}^{\infty} \dim \operatorname{Hom}_{\Gamma}(i, \mathbb{C}^2 \otimes S^n(\mathbb{C}^2)) \cdot t^n \end{aligned}$$

and since \mathbf{st} is isomorphic to its dual representation we can continue

$$\begin{aligned} &= t \sum_{n=0}^{\infty} \dim \operatorname{Hom}_{\Gamma}(\mathbf{st} \otimes i, S^n(\mathbb{C}^2)) \cdot t^n = t \sum_{n=0}^{\infty} \dim \operatorname{Hom}_{\Gamma}\left(\bigoplus_{j \in N(i)} j, S^n(\mathbb{C}^2)\right) \cdot t^n \\ &= t \sum_{n=0}^{\infty} \sum_{j \in N(i)} \dim \operatorname{Hom}_{\Gamma}(j, S^n(\mathbb{C}^2)) \cdot t^n = t \sum_{j \in N(i)} P_j(t). \end{aligned} \quad (2.3)$$

The equation (2.3) when written as a matrix equation looks like

$$C_{\text{aff}}(t)P(t) = \delta. \quad (2.4)$$

Here $C_{\text{aff}}(t)$ is the *quantum affine Cartan matrix* for Γ . Its row and column indices run over the vertices of the affine Coxeter-Dynkin diagram as for the usual affine Cartan matrix C_{aff} . Now $C_{\text{aff}}(t)$ is gotten from C_{aff} by replacing the diagonal elements 2 by $1 + t^2$ and by multiplying the off-diagonal entries by t . [For type A_0 we have $C_{\text{aff}}(t) = ((1-t)^2)$.] The vectors $P(t)$ and δ have $P_i(t)$ and δ_i as entries, respectively. Note that $C_{\text{aff}}(t) \equiv \mathbf{1} \pmod{t}$, so that the matrix $C_{\text{aff}}(t)$ is invertible in the power series ring, and the entries of $C_{\text{aff}}(t)^{-1}$ can obviously be written as rational functions in t . So we obtain the various Poincaré series $P_i(t)$ simply by solving (2.4) for $P(t)$, that is, $P(t) = C_{\text{aff}}(t)^{-1}\delta$.

The following theorem summarizes what we have gotten so far.

Theorem 2.3 *Let Γ be a finite subgroup of $SU(2)$. We identify its unitary dual $\widehat{\Gamma}$ with the vertices of an affine Coxeter-Dynkin diagram with affine Cartan matrix C_{aff} . Then the vector of Poincaré series $P(t) = (P_i(t))_{i \in \widehat{\Gamma}}$ in Definition 2.2 is*

$$P(t) = C_{\text{aff}}(t)^{-1} \delta$$

where $C_{\text{aff}}(t) = (1-t)^2 \mathbf{1} + t C_{\text{aff}}$ is the quantum affine Cartan matrix and $\delta = (\delta_i)_{i \in \widehat{\Gamma}}$ is the vector such that $\delta_i = 1$ if i is the trivial representation and $\delta_i = 0$ otherwise.

Cramer's rule yields the following corollary.

Corollary 2.4 *The Poincaré series for the invariant ring $S^*(\mathbb{C}^2)^\Gamma$ is*

$$P_1(t) = \frac{\det C_{\text{fin}}(t)}{\det C_{\text{aff}}(t)}. \quad (2.5)$$

Here $C_{\text{fin}}(t)$ is the submatrix of $C_{\text{aff}}(t)$ with row and column indices different from 1.

The most natural way to derive the crucial equation (2.3) that led us to introduce the quantum affine Cartan matrix actually comes from the following general formula that takes place in the formal power series ring with coefficients in the complex representation ring $R(\Gamma)$ of our finite group Γ . (By some slight abuse of notation we denote representations or their equivalence classes in the representation ring by the same letters.)

$$\frac{1}{\lambda_{-t}(i)} = \sigma_t(i) \in R(\Gamma)[[t]] \quad (2.6)$$

Here $\lambda_{-t}(i)$ and $\sigma_t(i)$ are defined as usual, namely, if $i \in R(\Gamma)$ is the class of any (honest) finite-dimensional complex representation of Γ , then we look at its exterior powers $\bigwedge^k i$ and symmetric powers $S^n(i)$ and put

$$\lambda_{-t}(i) = \sum_{k=0}^{\dim i} \bigwedge^k i \cdot t^k \quad \text{and} \quad \sigma_t(i) = \sum_{n=0}^{\infty} S^n(i) \cdot t^n.$$

For $i = \mathbf{st}$ we have $\lambda_{-t}(\mathbf{st}) = 1 - \mathbf{st}t + 1t^2$ and since $\sigma_t(\mathbf{st}) = \sum_{i \in \widehat{\Gamma}} i \cdot P_i(t)$ the identity (2.6) says that

$$(1 - \mathbf{st}t + 1t^2) \left(\sum_{i \in \widehat{\Gamma}} i \cdot P_i(t) \right) = 1.$$

Inserting McKay's formula (2.1) we get

$$(1 + t^2) \left(\sum_{i \in \widehat{\Gamma}} i \cdot P_i(t) \right) - 1 = t \sum_{j \in \widehat{\Gamma}} \sum_{i \in N(j)} i \cdot P_j(t).$$

Its i th component is just equation (2.3) because $i \in N(j)$ is equivalent to $j \in N(i)$. An obvious advantage of formula (2.6) in comparison with the previous *ad hoc* approach to derive formula (2.3) is that we can use formula (2.6) for any representation and not just for the standard 2-dimensional representation. We will use it in Sect. 7.

3 An example— E_8

In this short section we shall apply the formula in Corollary 2.4 to compute the Poincaré series of the invariant ring of the binary icosahedral group in its standard 2-dimensional representation. (Another way of computing the Poincaré series would be to use the classical Molien formula.) The binary icosahedral group corresponds to E_8 via the McKay correspondence, and its quantum affine Cartan matrix reads

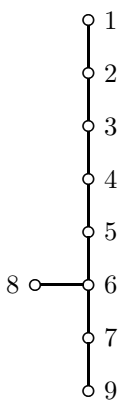
$$\begin{pmatrix} 1+t^2 & -t & 0 & 0 & 0 & 0 & 0 & 0 & 0 \\ -t & 1+t^2 & -t & 0 & 0 & 0 & 0 & 0 & 0 \\ 0 & -t & 1+t^2 & -t & 0 & 0 & 0 & 0 & 0 \\ 0 & 0 & -t & 1+t^2 & -t & 0 & 0 & 0 & 0 \\ 0 & 0 & 0 & -t & 1+t^2 & -t & 0 & 0 & 0 \\ 0 & 0 & 0 & 0 & -t & 1+t^2 & -t & -t & 0 \\ 0 & 0 & 0 & 0 & 0 & -t & 1+t^2 & 0 & -t \\ 0 & 0 & 0 & 0 & 0 & -t & 0 & 1+t^2 & 0 \\ 0 & 0 & 0 & 0 & 0 & 0 & -t & 0 & 1+t^2 \end{pmatrix}$$

where the rows and columns are ordered according to the numbering of the vertices in the affine E_8 diagram displayed above.

One computes

$$\begin{aligned} \det C_{\text{fin}}(t) &= 1 + t^2 - t^6 - t^8 - t^{10} + t^{14} + t^{16}, \\ \det C_{\text{aff}}(t) &= 1 + t^2 - t^6 - t^8 - t^{10} - t^{12} + t^{16} + t^{18}. \end{aligned}$$

The quotient can be put into the form

$$P_1(t) = \frac{\det C_{\text{fin}}(t)}{\det C_{\text{aff}}(t)} = \frac{1 + t^{30}}{(1 - t^{12})(1 - t^{20})}.$$

This is a classical result known from the theory of Kleinian singularities.

Fact 3.1 *Let Γ be a finite subgroup of $SU(2)$. The Poincaré series for the invariant ring $S^*(\mathbb{C}^2)^\Gamma$ is*

$$P_1(t) = \frac{1 + t^h}{(1 - t^a)(1 - t^b)} \tag{3.1}$$

where $h = \sum_{i \in \widehat{\Gamma}} \dim i$ is the Coxeter number, $a = 2 \max\{\dim i \mid i \in \widehat{\Gamma}\}$, and $b = h + 2 - a$, and it turns out that $ab = 2|\Gamma|$.

In general, Kostant [Ko1] proved that one can write the rational functions $P_i(t)$, which we expressed as matrix entries of the inverse quantum affine Cartan matrix in Theorem 2.3, as

$$P_i(t) = \frac{z_i(t)}{(1 - t^a)(1 - t^b)}$$

for certain polynomials $z_i(t)$ with nonnegative integer coefficients and that these polynomials can be described in a beautiful way by considering the action of a finite Coxeter

transformation c_{fin} on the root system and by intersecting the orbits with the set of positive roots that are not perpendicular to the highest root. The details are in [Ko1, Ko2].

To finish the E_8 example, let us display the polynomials $z_i(t)$.

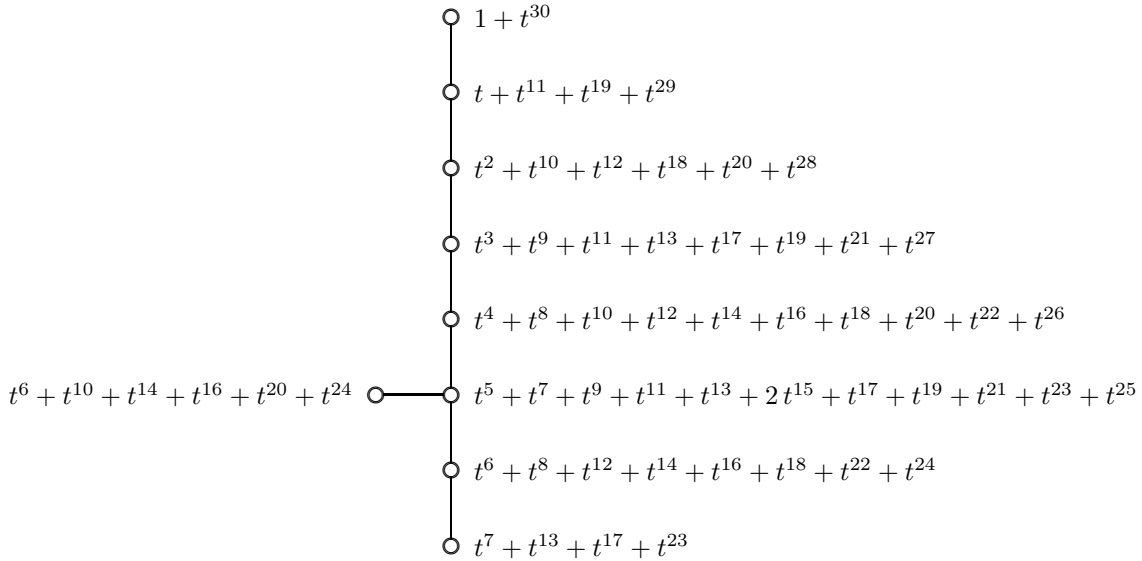

4 A numerological table

Up to now we have looked at the parameters a, b, h for ADE types. Some of the corresponding affine Coxeter-Dynkin diagrams can be folded into affine Coxeter-Dynkin diagrams of CBFG types. In this way C_l unfolds to A_{2l-1} , B_l unfolds to D_{l+1} , F_4 unfolds to E_6 , and G_2 unfolds to D_4 . We define the parameters a, b, h for the folded types to be equal to those parameters for the corresponding unfolded types. The formula

$$\frac{\det C_{\text{fin}}(t)}{\det C_{\text{aff}}(t)} = \frac{1 + t^h}{(1 - t^a)(1 - t^b)} \quad (4.1)$$

which for the ADE types follows from (2.5) and (3.1) is actually valid for all types. In fact, from a computational point of view this may be obvious by taking into account symmetries. The parameters p, q, r (ordered appropriately) in the table are determined by Proposition 4.1.

type	a	b	h	p	q	r
$A_l \ (l \geq 0)$	2	$l + 1$	$l + 1$	$\frac{1}{2}(l + 1)$	$\frac{1}{2}(l + 1)$	1
$D_l \ (l \geq 4)$	4	$2l - 4$	$2l - 2$	$l - 2$	2	2
E_6	6	8	12	3	3	2
E_7	8	12	18	4	3	2
E_8	12	20	30	5	3	2
$C_l \ (l \geq 2)$	2	$2l$	$2l$	l	1	1
$B_l \ (l \geq 3)$	4	$2l - 2$	$2l$	$l - 1$	2	1
F_4	6	8	12	3	2	1
G_2	4	4	6	2	1	1

Proposition 4.1 *The determinant of a quantum affine Cartan matrix $C_{\text{aff}}(t)$ is*

$$\det C_{\text{aff}}(t) = \frac{(1 - t^{2p})(1 - t^{2q})(1 - t^{2r})}{1 - t^2} \quad (4.2)$$

where p, q, r are given in the table.

Proof. The proof is an elementary computation. (See also [LT].) \square

Looking at the degree, we obtain the following corollary.

Corollary 4.2 $p + q + r = l + 2$.

The numbers p, q , and r have the usual interpretation for the ADE types. For instance, $p - 1, q - 1$, and $r - 1$ are the arm lengths in the Y-shaped *finite* Coxeter-Dynkin diagram (to be interpreted with a grain of salt in case of type A_{2n}).

The next corollary gives a formula for the determinant of the finite Cartan matrix $C_{\text{fin}} = C_{\text{fin}}(1)$. It generalizes Saito's relation [Sa] to all types.

Corollary 4.3 $\det C_{\text{fin}} = \frac{8pqr}{ab}$.

Proof. Solve (4.1) and (4.2) for $C_{\text{fin}}(t)$, cancel the factors $(1 - t)^3$ in the numerator and denominator, and evaluate at $t = 1$. \square

Remark 4.4 Using the fact that $ab = 2|\Gamma|$ and the formula for $|\Gamma|$ in terms of p, q, r (see the last entry of Facts 5.1 below), one writes $\det C_{\text{fin}}$ in terms of p, q, r for the ADE types. It turns out that the same expression in p, q, r is a well-known quantity for the CBF types, too.

$$pq + qr + pr - pqr = \begin{cases} \det C_{\text{fin}} & \text{for the ADE types,} \\ l + 1 & \text{for the CBF types.} \end{cases}$$

Before stating the next corollary let me recall how the spectrum of the Cartan matrix C_{fin} or C_{aff} is related to the spectrum of a corresponding Coxeter transformation c_{fin} or c_{aff} (see [BLM, Co]). Namely, there are complex numbers χ_1, \dots, χ_n satisfying $\chi_j + \chi_{n+1-j} = 2\pi i$ (for $j = 1, \dots, n$) such that $e^{\chi_1}, \dots, e^{\chi_n}$ are the eigenvalues of a Coxeter transformation. The eigenvalues of the corresponding Cartan matrix are then $2 - e^{\chi_1/2} - e^{-\chi_1/2}, \dots, 2 - e^{\chi_n/2} - e^{-\chi_n/2}$. This is true if the underlying Coxeter-Dynkin diagram is a tree (or forest), which covers all finite cases and all irreducible affine cases except affine A type. In the latter case the Coxeter-Dynkin diagram is a cycle with $l + 1$ vertices, and the $(l + 1)!$ possible Coxeter transformations occur in $\lfloor (l + 1)/2 \rfloor$ spectral classes (for $l \geq 1$). If s_1, \dots, s_{l+1} are the simple reflections (still for affine A_l type), then one can compute (see [Co]) that

$$\prod_{\sigma \in \text{Sym}_{l+1}} \det(T \cdot \text{id} - s_{\sigma(1)} \cdots s_{\sigma(l+1)}) = \prod_{k=1}^l (1 - T^k)^{2(l+1)A(l,k)}$$

where Sym_{l+1} is the symmetric group of degree $l + 1$ and $A(l, k) = \sum_{j=0}^k (-1)^j \binom{l+1}{j} (k - j)^l$ are Eulerian numbers.

Coming back to the tree case we evaluate the characteristic polynomial (in t^2) of a Coxeter transformation as

$$\begin{aligned} \prod_{j=1}^n (t^2 - e^{\chi_j}) &= \prod_{j=1}^n ((t - e^{\chi_j/2})(t + e^{\chi_j/2})) = \prod_{j=1}^n (t - e^{\chi_j/2}) \prod_{j=1}^n (t + e^{\chi_{n+1-j}/2}) \\ &= \prod_{j=1}^n ((t - e^{\chi_j/2})(t - e^{-\chi_j/2})) \quad (\text{using the symmetry } \chi_j + \chi_{n+1-j} = 2\pi i) \\ &= \prod_{j=1}^n (t^2 - te^{\chi_j/2} - te^{-\chi_j/2} + 1) = \prod_{j=1}^n ((1-t)^2 + t(2 - e^{\chi_j/2} - e^{-\chi_j/2})) \end{aligned}$$

so that we get $\det C_{\text{fin}}(t) = \det(t^2 \cdot \text{id} - c_{\text{fin}})$ and $\det C_{\text{aff}}(t) = \det(t^2 \cdot \text{id} - c_{\text{aff}})$ except for affine A type.

The next corollary gives a characterization of the exponents m_j of a finite Weyl group. (Recall that $1 \leq m_j < h$ and $\exp(2\pi i m_j/h)$ (for $j = 1, \dots, l$) are the eigenvalues of a finite Coxeter transformation c_{fin} .)

Corollary 4.5 *Setting $q = e^{2\pi i/h}$, we have*

$$\prod_{j=1}^l (t^2 - q^{m_j}) = \frac{(1-t^{2h})(1-t^{2p})(1-t^{2q})(1-t^{2r})}{(1-t^2)(1-t^a)(1-t^b)(1-t^h)}.$$

Proof. The left hand side is $C_{\text{fin}}(t)$ by the discussion above, and by (4.1) and (4.2) $C_{\text{fin}}(t)$ can be expressed by the right hand side. \square

5 Some facts about binary polyhedral groups

Facts 5.1 *Let $\Gamma = \langle \alpha, \beta, \gamma \mid \alpha^p = \beta^q = \gamma^r = \alpha\beta\gamma \rangle$ be a (finite) binary polyhedral group with $p \geq q \geq r \geq 1$ and $p = q$ if $r = 1$.*

- *The collection of parameters (p, q, r) as above is*

- $(p, p, 1)$ cyclic group of order $2p$,*
- $(p, 2, 2)$ binary dihedral (= generalized quaternion = dicyclic) group of order $4p$,*
- $(3, 3, 2)$ binary tetrahedral group \mathcal{T} (of order 24),*
- $(4, 3, 2)$ binary octahedral group \mathcal{O} (of order 48),*
- $(5, 3, 2)$ binary icosahedral group \mathcal{I} (of order 120).*

- *If Γ is not cyclic, then the centre $Z(\Gamma)$ has order 2 and is generated by $\alpha\beta\gamma$.*
- *The conjugacy classes other than $\{1\}$ and $\{\alpha\beta\gamma\}$ are the following:*
 - $[\alpha^j]$ of size $|[\alpha^j]| = |\Gamma|/2p$ for $1 \leq j \leq p-1$,
 - $[\beta^j]$ of size $|[\beta^j]| = |\Gamma|/2q$ for $1 \leq j \leq q-1$,
 - $[\gamma^j]$ of size $|[\gamma^j]| = |\Gamma|/2r$ for $1 \leq j \leq r-1$.

Therefore the order of Γ is the following well-known expression.

$$|\Gamma| = \frac{4}{\frac{1}{p} + \frac{1}{q} + \frac{1}{r} - 1}$$

6 Explicit computations: the primitive cases E_6, E_7, E_8

Some vertices in the following Coxeter-Dynkin diagrams are decorated. The cross is for the trivial representation. The spinorial representations, i. e., those representations where the nontrivial central element $\bar{1} = \alpha\beta\gamma$ acts by -1 , are marked by a dot.

Tetrahedral case $\mathcal{T} = \langle \alpha, \beta, \gamma \mid \alpha^3 = \beta^3 = \gamma^2 = \alpha\beta\gamma \rangle \cong \mathrm{SL}_2(\mathbb{F}_3)$

Remark 6.1 $\alpha \mapsto \begin{pmatrix} -1 & -1 \\ 0 & -1 \end{pmatrix}, \beta \mapsto \begin{pmatrix} -1 & 1 \\ -1 & 0 \end{pmatrix}, \gamma \mapsto \begin{pmatrix} 0 & -1 \\ 1 & 0 \end{pmatrix}$ gives an isomorphism $\mathcal{T} \cong \mathrm{SL}_2(\mathbb{F}_3)$.

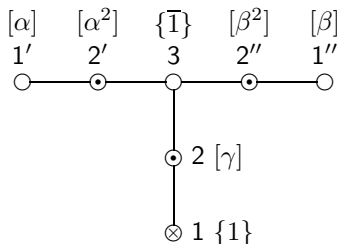

character table	{1}	[\gamma]	{\bar{1}}	[\alpha^2]	[\beta^2]	[\alpha]	[\beta]
1	1	1	1	1	1	1	1
2	2	0	-2	-1	-1	1	1
3	3	-1	3	0	0	0	0
2'	2	0	-2	$-\rho$	$-\rho^2$	ρ^2	ρ
2''	2	0	-2	$-\rho^2$	$-\rho$	ρ	ρ^2
1'	1	1	1	ρ	ρ^2	ρ^2	ρ
1''	1	1	1	ρ^2	ρ	ρ	ρ^2

$\rho = \frac{-1+\sqrt{-3}}{2} = \exp(2\pi i/3)$

Octahedral case $\mathcal{O} = \langle \alpha, \beta, \gamma \mid \alpha^4 = \beta^3 = \gamma^2 = \alpha\beta\gamma \rangle$

Remark 6.2 Note that $\mathcal{O} \not\cong \mathrm{SL}_2(\mathbb{F}_4)$ (in fact, $\mathrm{SL}_2(\mathbb{F}_4) \cong \mathrm{Alt}_5$ is the simple group of order 60), and also that $\mathcal{O} \not\cong \mathrm{SL}_2(\mathbb{Z}/4\mathbb{Z})$ (in fact, the group $\mathrm{SL}_2(\mathbb{Z}/4\mathbb{Z})$ (of order 48) has more than one element of order 2). But one can embed \mathcal{O} into $\mathrm{SL}_2(\mathbb{F}_7)$, e. g., by $\alpha \mapsto \begin{pmatrix} 1 & 1 \\ 2 & 3 \end{pmatrix}, \beta \mapsto \begin{pmatrix} -1 & -3 \\ 1 & 2 \end{pmatrix}, \gamma \mapsto \begin{pmatrix} 0 & -1 \\ 1 & 0 \end{pmatrix}$. Note that $\mathrm{tr} \begin{pmatrix} 1 & 1 \\ 2 & 3 \end{pmatrix} = 4$ is a square root of 2 in \mathbb{F}_7 .

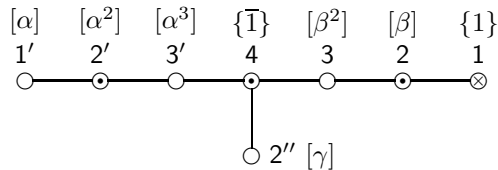

character table	{1}	[\beta]	[\beta^2]	{\bar{1}}	[\alpha^3]	[\gamma]	[\alpha^2]	[\alpha]
1	1	1	1	1	1	1	1	1
2	2	1	-1	-2	$-\sigma$	0	0	σ
3	3	0	0	3	1	-1	-1	1
4	4	-1	1	-4	0	0	0	0
3'	3	0	0	3	-1	1	-1	-1
2''	2	-1	-1	2	0	0	2	0
2'	2	1	-1	-2	σ	0	0	$-\sigma$
1'	1	1	1	1	-1	-1	1	-1

$\sigma = \sqrt{2}$

Icosahedral case $\mathcal{I} = \langle \alpha, \beta, \gamma \mid \alpha^5 = \beta^3 = \gamma^2 = \alpha\beta\gamma \rangle \cong \mathrm{SL}_2(\mathbb{F}_5)$

Remark 6.3 $\alpha \mapsto \begin{pmatrix} -1 & -1 \\ 0 & -1 \end{pmatrix}$, $\beta \mapsto \begin{pmatrix} -1 & 1 \\ -1 & 0 \end{pmatrix}$, $\gamma \mapsto \begin{pmatrix} 0 & -1 \\ 1 & 0 \end{pmatrix}$ gives an isomorphism $\mathcal{I} \cong \mathrm{SL}_2(\mathbb{F}_5)$.

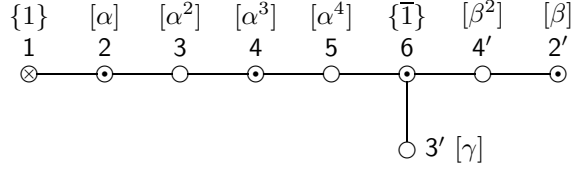

character table	{1}	[α]	[α^2]	[α^3]	[α^4]	{ $\bar{1}$ }	[β^2]	[γ]	[β]
1	1	1	1	1	1	1	1	1	1
2	2	τ	$-\tau'$	τ'	$-\tau$	-2	-1	0	1
3	3	τ	τ'	τ'	τ	3	0	-1	0
4	4	1	-1	1	-1	-4	1	0	-1
5	5	0	0	0	0	5	-1	1	-1
6	6	-1	1	-1	1	-6	0	0	0
4'	4	-1	-1	-1	-1	4	1	0	1
3'	3	τ'	τ	τ	τ'	3	0	-1	0
2'	2	τ'	$-\tau$	τ	$-\tau'$	-2	-1	0	1

$$\tau = \frac{1+\sqrt{5}}{2}$$

$$\tau' = \frac{1-\sqrt{5}}{2}$$

7 More on the three primitive cases

Let us denote the irreducible representations of $\mathrm{SU}(2)$ (or rather their classes in the representation ring) by bold letters. So \mathbf{i} stands for the i -dimensional representation $\mathbf{i} = \mathbf{S}^{i-1}(\mathbf{2})$ of $\mathrm{SU}(2)$. As before we use sanserif fonts for representations of Γ . Addition in the representation ring will be denoted by $+$ and multiplication usually by \otimes . We also write, e. g., $2 \cdot 5$ for $5 + 5$. Multiplication in $\mathrm{R}(\Gamma)[[t]]$ will be indicated by juxtaposition while we keep the tensor product sign if no t is in sight.

If we denote the character of $\mathbf{2}$ by $\xi + \xi^{-1}$, then $\mathbf{i} = \mathbf{S}^{i-1}(\mathbf{2})$ has character $\sum_{k=0}^{i-1} \xi^{i-1-2k}$ and $\lambda_{-t}\mathbf{i}$ becomes $\prod_{k=0}^{i-1} (1 - \xi^{i-1-2k}t)$. Explicitly, the first few $\lambda_{-t}\mathbf{i}$ read as follows.

$$\lambda_{-t}\mathbf{1} = \mathbf{1} - \mathbf{1}t$$

$$\lambda_{-t}\mathbf{2} = \mathbf{1} - \mathbf{2}t + \mathbf{1}t^2$$

$$\lambda_{-t}\mathbf{3} = \mathbf{1} - \mathbf{3}t + \mathbf{3}t^2 - \mathbf{1}t^3$$

$$\lambda_{-t}\mathbf{4} = \mathbf{1} - \mathbf{4}t + (\mathbf{1} + \mathbf{5})t^2 - \mathbf{4}t^3 + \mathbf{1}t^4$$

$$\lambda_{-t}\mathbf{5} = \mathbf{1} - \mathbf{5}t + (\mathbf{3} + \mathbf{7})t^2 - (\mathbf{3} + \mathbf{7})t^3 + \mathbf{5}t^4 - \mathbf{1}t^5$$

$$\lambda_{-t}\mathbf{6} = \mathbf{1} - \mathbf{6}t + (\mathbf{1} + \mathbf{5} + \mathbf{9})t^2 - (\mathbf{4} + \mathbf{6} + \mathbf{10})t^3 + (\mathbf{1} + \mathbf{5} + \mathbf{9})t^4 - \mathbf{6}t^5 + \mathbf{1}t^6$$

$$\lambda_{-t}\mathbf{7} = \mathbf{1} - \mathbf{7}t + (\mathbf{3} + \mathbf{7} + \mathbf{11})t^2 - (\mathbf{1} + \mathbf{5} + \mathbf{7} + \mathbf{9} + \mathbf{13})t^3$$

$$+ (\mathbf{1} + \mathbf{5} + \mathbf{7} + \mathbf{9} + \mathbf{13})t^4 - (\mathbf{3} + \mathbf{7} + \mathbf{11})t^5 + \mathbf{7}t^6 - \mathbf{1}t^7$$

Next we shall compute the λ -polynomials $\lambda_{-t}(\mathbf{i})$ for each irreducible representation in the binary tetrahedral, octahedral, and icosahedral cases.

\mathcal{T}

SU(2)	1	2	3	4	5
\mathcal{T}	1	2	3	$2' + 2''$	$3 + 1' + 1''$

Restricting from SU(2) to \mathcal{T} gives the λ -polynomials for the representations 1, 2, 3 of \mathcal{T} . From the character table we get $2' \otimes 2' = 3 + 1''$, and its 1-dimensional summand $\bigwedge^2 2'$ is therefore $\bigwedge^2 2' = 1''$. Similarly we get $\bigwedge^2 2'' = 1'$.

Here is the list of λ -polynomials for the irreducible representations of \mathcal{T} .

$$\begin{aligned}
\lambda_{-t}1 &= 1 - 1t \\
\lambda_{-t}2 &= 1 - 2t + 1t^2 \\
\lambda_{-t}3 &= 1 - 3t + 3t^2 - 1t^3 \\
\lambda_{-t}2' &= 1 - 2't + 1''t^2 \\
\lambda_{-t}2'' &= 1 - 2''t + 1't^2 \\
\lambda_{-t}1' &= 1 - 1't \\
\lambda_{-t}1'' &= 1 - 1''t
\end{aligned}$$

\mathcal{O}

SU(2)	1	2	3	4	5	6	7
\mathcal{O}	1	2	3	4	$3' + 2''$	$4 + 2'$	$3 + 3' + 1'$

Restricting from SU(2) to \mathcal{O} gives the λ -polynomials for the representations 1, ..., 4 of \mathcal{O} . From the character table we get $2' \otimes 2' = 3 + 1$, so that $\bigwedge^2 2' = 1$. From $2'' \otimes 2'' = 1 + 2'' + 1'$, however, one cannot read off $\bigwedge^2 2''$. But from

$$\begin{aligned}
\lambda_{-t}(\mathbf{7}|_{\mathcal{O}}) &= \lambda_{-t}(3 + 3' + 1') = \lambda_{-t}3 \lambda_{-t}3' \lambda_{-t}1' \quad \text{and} \\
\lambda_{-t}(\mathbf{5}|_{\mathcal{O}}) &= \lambda_{-t}(3' + 2'') = \lambda_{-t}3' \lambda_{-t}2''
\end{aligned}$$

we first get $\bigwedge^3 3' = 1'$ and $\bigwedge^2 2'' = 1'$. Looking at the t^2 coefficient of the second equation above we see that

$$\mathbf{3}|_{\mathcal{O}} + \mathbf{7}|_{\mathcal{O}} = 3 + 3 + 3' + 1' = 1' + 3' \otimes 2'' + \bigwedge^2 3'$$

and since $3' \otimes 2'' = 3 + 3'$ we get $\bigwedge^2 3' = 3$.

Here is the list of λ -polynomials for the irreducible representations of \mathcal{O} .

$$\begin{aligned}
\lambda_{-t}1 &= 1 - 1t \\
\lambda_{-t}2 &= 1 - 2t + 1t^2 \\
\lambda_{-t}3 &= 1 - 3t + 3t^2 - 1t^3 \\
\lambda_{-t}4 &= 1 - 4t + (1 + 3' + 2'')t^2 - 4t^3 + 1t^4 \\
\lambda_{-t}3' &= 1 - 3't + 3t^2 - 1't^3 \\
\lambda_{-t}2'' &= 1 - 2''t + 1't^2 \\
\lambda_{-t}2' &= 1 - 2't + 1t^2 \\
\lambda_{-t}1' &= 1 - 1't
\end{aligned}$$

\mathcal{I}

SU(2)	1	2	3	4	5	6	7	8	9	10
\mathcal{I}	1	2	3	4	5	6	$4' + 3'$	$6 + 2'$	$5 + 4'$	$4 + 6$

Restricting from SU(2) to \mathcal{I} gives the λ -polynomials for the representations $1, \dots, 6$ of \mathcal{I} . The λ -polynomials for $3'$ and $2'$ are obvious, too. Only the t^2 coefficient in $\lambda_{-t}4'$ is not totally obvious. For this, we can use the universal formula

$$\bigwedge^2(x \otimes y) = \bigwedge^2 x \otimes y^{\otimes 2} + x^{\otimes 2} \otimes \bigwedge^2 y - 2 \cdot \bigwedge^2 x \otimes \bigwedge^2 y$$

and apply it for $4' = 2 \otimes 2'$.

Here is the list of λ -polynomials for the irreducible representations of \mathcal{I} .

$$\lambda_{-t}1 = 1 - 1t$$

$$\lambda_{-t}2 = 1 - 2t + 1t^2$$

$$\lambda_{-t}3 = 1 - 3t + 3t^2 - 1t^3$$

$$\lambda_{-t}4 = 1 - 4t + (1 + 5)t^2 - 4t^3 + 1t^4$$

$$\lambda_{-t}5 = 1 - 5t + (3 + 4' + 3')t^2 - (3 + 4' + 3')t^3 + 5t^4 - 1t^5$$

$$\lambda_{-t}6 = 1 - 6t + (1 + 2 \cdot 5 + 4')t^2 - (2 \cdot 4 + 2 \cdot 6)t^3 + (1 + 2 \cdot 5 + 4')t^4 - 6t^5 + 1t^6$$

$$\lambda_{-t}4' = 1 - 4't + (3 + 3')t^2 - 4't^3 + 1t^4$$

$$\lambda_{-t}3' = 1 - 3't + 3't^2 - 1t^3$$

$$\lambda_{-t}2' = 1 - 2't + 1t^2$$

We are now ready to compute the Poincaré series (Γ is fixed and suppressed in the notation)

$$P_{i,j}(t) := \sum_{n=0}^{\infty} \dim \operatorname{Hom}_{\Gamma}(i, S^n(j)) \cdot t^n$$

generalizing $P_i(t) = P_{i,2}(t)$ from Definition 2.2. To do so one has to invert the polynomial $\lambda_{-t}(j)$ in the power series ring $R(\Gamma)[[t]]$ (see (2.6)). This is best done by regarding $\lambda_{-t}(j)$ as a multiplication operator in $\operatorname{Aut}_{\mathbb{Z}[[t]]}(R(\Gamma)[[t]])$ and by inverting its matrix (with respect to the basis $\widehat{\Gamma}$). The column corresponding to the trivial representation $\mathbf{1}$ of the inverted matrix is then the vector $(P_{i,j}(t))_{i \in \widehat{\Gamma}}$ we are looking for.

Note how the Poincaré series $P_{i,3}(t)$ is determined by $P_i(t) = P_{i,2}(t)$.

$$P_{i,3}(t) = \begin{cases} \frac{P_i(t^{1/2})}{1 - t^2} & \text{if } i \text{ is not spinorial,} \\ 0 & \text{if } i \text{ is spinorial.} \end{cases}$$

Here is one way of proving this. Let ψ^2 be the Adams square which doubles the SU(2) weights. If $\pm\varpi$ are the weights of $\mathbf{2}$, then those of $\mathbf{3}$ are $2\varpi, 0, -2\varpi$, so that $\mathbf{3} = \psi^2(\mathbf{2}) + \mathbf{1}$. More generally, note that $\psi^2 S^{n-2i}(\mathbf{2}) = S^{2n-4i}(\mathbf{2}) - \psi^2 S^{n-2i-1}(\mathbf{2})$. We get

$$\begin{aligned} S^n(\mathbf{3}) &= S^n(\psi^2(\mathbf{2}) + \mathbf{1}) = \sum_{k=0}^n S^{n-k}(\psi^2(\mathbf{2})) \otimes S^k(\mathbf{1}) = \sum_{k=0}^n \psi^2 S^{n-k}(\mathbf{2}) \\ &= \sum_{i=0}^{\lfloor n/2 \rfloor} (S^{2n-4i}(\mathbf{2}) - \psi^2 S^{n-2i-1}(\mathbf{2})) + \sum_{i=0}^{\lfloor n/2 \rfloor} \psi^2 S^{n-2i-1}(\mathbf{2}) = \sum_{i=0}^{\lfloor n/2 \rfloor} S^{2n-4i}(\mathbf{2}). \end{aligned}$$

Now we can restrict from $SU(2)$ to Γ and compute

$$\begin{aligned}
 P_{i,3}(t) &= \sum_{n=0}^{\infty} \dim \operatorname{Hom}_{\Gamma}(i, S^n(3)) \cdot t^n = \sum_{n=0}^{\infty} \sum_{k=0}^{\lfloor n/2 \rfloor} \dim \operatorname{Hom}_{\Gamma}(i, S^{2n-4k}(\mathbf{2})) \cdot t^n \\
 &= \sum_{k=0}^{\infty} \sum_{n=2k}^{\infty} \dim \operatorname{Hom}_{\Gamma}(i, S^{2n-4k}(\mathbf{2})) \cdot t^{n-2k} \cdot t^{2k} \\
 &= \sum_{k=0}^{\infty} t^{2k} \sum_{n=0}^{\infty} \dim \operatorname{Hom}_{\Gamma}(i, S^n(\mathbf{2})) \cdot t^{n/2} = \frac{1}{1-t^2} P_i(t^{1/2})
 \end{aligned}$$

assuming that i is not spinorial, so that $\operatorname{Hom}_{\Gamma}(i, S^{\text{odd}}(\mathbf{2})) = 0$.

It would be easy to list all the Poincaré series $P_{i,j}(t)$. Let it suffice to show the Poincaré series $P_{1,j}(t)$ for the invariant rings $S^*(j)^{\Gamma}$.

$$\Gamma = \mathcal{T}$$

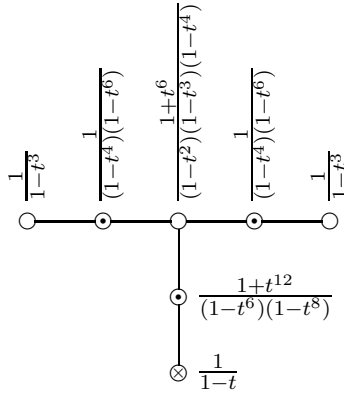

$$\Gamma = \mathcal{O}$$

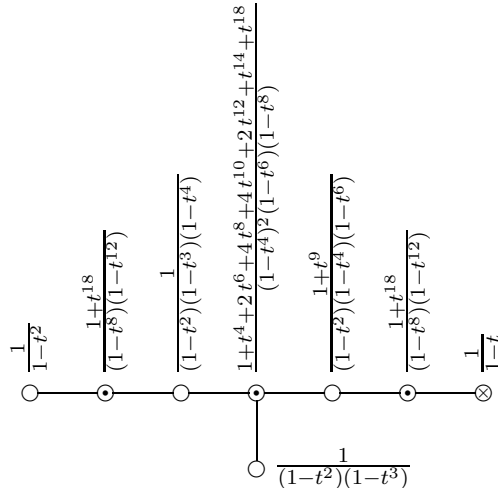

$$\Gamma = \mathcal{I}$$

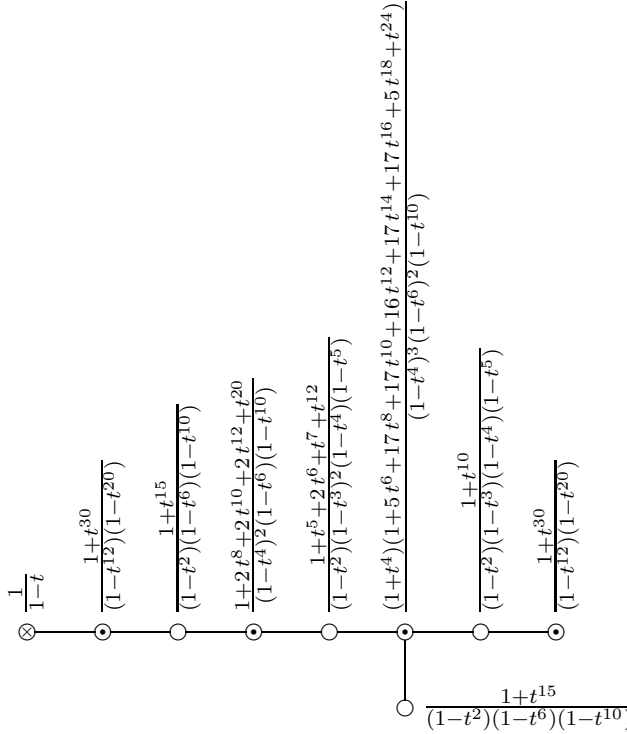

Remark 7.1 Note that in this last case $\Gamma = \mathcal{I}$ one has $\dim \mathfrak{j} = -\deg P_{1,\mathfrak{j}}(t)$ for all $\mathfrak{j} \in \widehat{\Gamma}$ where the degree of a rational function is defined to be the degree of the numerator polynomial minus the degree of the denominator polynomial (and this difference is of course well-defined). This example suggests evident classification questions.

8 Homomorphisms into finite complex reflection groups

The well-known Chevalley-Shephard-Todd Theorem characterizes the finite complex reflection groups as those finite groups that have a polynomial algebra as invariant ring of some faithful complex representation. More precisely, one has the following theorem.

Theorem 8.1 *Let V be a finite-dimensional K -vector space and $G \hookrightarrow \mathrm{GL}(V)$ a faithful representation of a finite group G . Assume that $\mathrm{char} K \nmid |G|$. Then the following are equivalent.*

- (i) G is generated by (pseudo-)reflections.
- (ii) $K[V]^G$ is a polynomial algebra.

The original verification of this theorem for $K = \mathbb{C}$ by Shephard and Todd [ST] depended on their classification of finite irreducible complex reflection groups. A case free (but computational) proof was furnished by Chevalley [Ch]. A noncomputational proof of this result can be found in [Sm].

The aim of this section is to exhibit explicitly, for each of the three primitive binary polyhedral groups Γ and each of their irreducible representations i , a homomorphism from Γ to a finite complex reflection group G such that the reflection representation of G restricts to the representation i . A hint for guessing suitable target groups G for such homomorphisms $\Gamma \rightarrow G$ comes from looking at the exponents in the denominator of the Poincaré series of the invariant rings $S^*(i)^\Gamma$ and comparing them with the degrees for the finite complex reflection groups as tabulated for instance in [BMR] where one also finds presentations “à la Coxeter” for all these groups.

Our results are compiled below. For each primitive binary polyhedral group Γ and each of its irreducible representations i we give $\Gamma \twoheadrightarrow \bar{\Gamma} \hookrightarrow G$ for a complex reflection group G in the Shephard-Todd list. We make this very explicit by writing down a presentation for G and by giving the matrices for the reflection representation (unless G is a symmetric group; if G is a symmetric group then the usual representation by permutation matrices is the direct sum of the reflection representation and a 1-dimensional trivial representation). Finally, the homomorphisms $\Gamma \rightarrow G$ are defined by giving the images of the generators α and β of Γ . One can then easily check that this gives the correct character values. The computer algebra system GAP [GAP] was used for some computations.

Tetrahedral case $\mathcal{T} = \langle \alpha, \beta, \gamma \mid \alpha^3 = \beta^3 = \gamma^2 = \alpha\beta\gamma \rangle$

\mathcal{T} has four normal subgroups. The quotient groups look as follows.

- $\langle \alpha, \beta, \gamma \mid \alpha^3 = \beta^3 = \gamma^2 = \alpha\beta\gamma \rangle = \mathcal{T}$
- $\langle \alpha, \beta, \gamma \mid \alpha^3 = \beta^3 = \gamma^2 = \alpha\beta\gamma = 1 \rangle \cong \text{Alt}_4$
- $\langle \alpha, \beta, \gamma \mid \alpha^3 = \beta^3 = \gamma = \alpha\beta = 1 \rangle \cong \text{Alt}_3$
- $\langle \alpha, \beta, \gamma \mid \alpha = \beta = \gamma = 1 \rangle = 1$

$$\boxed{1} \quad \mathcal{T} \twoheadrightarrow 1 \hookrightarrow \text{Sym}_2 \cong W(\mathbf{A}_1) = \langle r \mid r^2 = 1 \rangle$$

$$\alpha \mapsto 1 \quad \beta \mapsto 1$$

$$\boxed{2} \quad \mathcal{T} \hookrightarrow G_{12} = \langle r, s, t \mid r^2 = s^2 = t^2 = 1, rstr = str s = trst \rangle$$

$$r \mapsto \begin{pmatrix} 0 & \varepsilon \\ -\varepsilon^3 & 0 \end{pmatrix} \quad s \mapsto \frac{1}{\sqrt{2}} \begin{pmatrix} 1 & i \\ -i & -1 \end{pmatrix} \quad t \mapsto \frac{1}{\sqrt{2}} \begin{pmatrix} 1 & 1 \\ 1 & -1 \end{pmatrix} \quad (\varepsilon = \exp(\pi i/4))$$

$$\alpha \mapsto rs \quad \beta \mapsto ts$$

$$\boxed{3} \quad \mathcal{T} \twoheadrightarrow \text{Alt}_4 \hookrightarrow \text{Sym}_4 \cong W(\mathbf{A}_3) = \langle r, s, t \mid r^2 = s^2 = t^2 = (rs)^3 = (st)^3 = (rt)^2 = 1 \rangle$$

$$\alpha \mapsto rs \quad \beta \mapsto st$$

$$\boxed{2'} \quad \mathcal{T} \xrightarrow{\cong} G_4 = \langle r, s \mid r^3 = s^3 = 1, rsr = srs \rangle$$

$$r \mapsto \begin{pmatrix} 1 & 0 \\ 0 & \rho \end{pmatrix} \quad s \mapsto \frac{i}{\sqrt{3}} \begin{pmatrix} 1 & -\sqrt{2}\rho^2 \\ -\sqrt{2}\rho^2 & -\rho \end{pmatrix} \quad (\rho = \exp(2\pi i/3))$$

$$\alpha \mapsto r^2 s^2 \quad \beta \mapsto rs$$

$$\boxed{2''} \quad \mathcal{T} \xrightarrow{\cong} G_4 = \langle r, s \mid r^3 = s^3 = 1, rsr = srs \rangle$$

$$\alpha \mapsto rs \quad \beta \mapsto r^2s^2$$

$$\boxed{1'} \quad \mathcal{T} \twoheadrightarrow \text{Alt}_3 \cong G_3(3) = \langle r \mid r^3 = 1 \rangle, r \mapsto \rho = \exp(2\pi i/3)$$

$$\alpha \mapsto r^2 \quad \beta \mapsto r$$

$$\boxed{1''} \quad \mathcal{T} \twoheadrightarrow \text{Alt}_3 \cong G_3(3) = \langle r \mid r^3 = 1 \rangle$$

$$\alpha \mapsto r \quad \beta \mapsto r^2$$

Octahedral case $\mathcal{O} = \langle \alpha, \beta, \gamma \mid \alpha^4 = \beta^3 = \gamma^2 = \alpha\beta\gamma \rangle$

\mathcal{O} has five normal subgroups. The quotient groups look as follows.

- $\langle \alpha, \beta, \gamma \mid \alpha^4 = \beta^3 = \gamma^2 = \alpha\beta\gamma \rangle = \mathcal{O}$
- $\langle \alpha, \beta, \gamma \mid \alpha^4 = \beta^3 = \gamma^2 = \alpha\beta\gamma = 1 \rangle \cong \text{Sym}_4$
- $\langle \alpha, \beta, \gamma \mid \alpha^2 = \beta^3 = \gamma^2 = \alpha\beta\gamma = 1 \rangle \cong \text{Sym}_3$
- $\langle \alpha, \beta, \gamma \mid \alpha^2 = \beta = \gamma^2 = \alpha\gamma = 1 \rangle \cong \text{Sym}_2$
- $\langle \alpha, \beta, \gamma \mid \alpha = \beta = \gamma = 1 \rangle = 1$

$$\boxed{1} \quad \mathcal{O} \twoheadrightarrow 1 \hookrightarrow \text{Sym}_2 \cong W(\mathbf{A}_1) = \langle r \mid r^2 = 1 \rangle$$

$$\alpha \mapsto 1 \quad \beta \mapsto 1$$

$$\boxed{2} \quad \mathcal{O} \hookrightarrow G_{13} = \langle r, s, t \mid r^2 = s^2 = t^2 = 1, rstrs = trstr, strs = trst \rangle$$

$$r \mapsto \begin{pmatrix} -1 & 0 \\ 0 & 1 \end{pmatrix} \quad s \mapsto \frac{1}{\sqrt{2}} \begin{pmatrix} -1 & -i \\ i & 1 \end{pmatrix} \quad t \mapsto \frac{1}{\sqrt{2}} \begin{pmatrix} -1 & 1 \\ 1 & 1 \end{pmatrix}$$

$$\alpha \mapsto rs \quad \beta \mapsto ts$$

$$\boxed{3} \quad \mathcal{O} \twoheadrightarrow \text{Sym}_4 \hookrightarrow W(\mathbf{B}_3) = \langle r, s, t \mid r^2 = s^2 = t^2 = (rs)^4 = (st)^3 = (rt)^2 = 1 \rangle$$

$$r \mapsto \begin{pmatrix} -1 & 0 & 0 \\ 0 & 1 & 0 \\ 0 & 0 & 1 \end{pmatrix} \quad s \mapsto \begin{pmatrix} 0 & 1 & 0 \\ 1 & 0 & 0 \\ 0 & 0 & 1 \end{pmatrix} \quad t \mapsto \begin{pmatrix} 1 & 0 & 0 \\ 0 & 0 & 1 \\ 0 & 1 & 0 \end{pmatrix}$$

$$\alpha \mapsto rs \quad \beta \mapsto st$$

$$\boxed{4} \quad \mathcal{O} \hookrightarrow G(4, 2, 4) = \left\langle r, s, t, u, v \mid \begin{array}{l} r^2 = s^2 = t^2 = u^2 = v^2 = 1, rst = str = trs \\ (ru)^2 = (rv)^2 = 1 \\ (su)^3 = (tu)^3 = (uv)^3 = (sv)^2 = (tv)^2 = 1 \end{array} \right\rangle$$

$$r \mapsto \begin{pmatrix} -1 & 0 & 0 & 0 \\ 0 & 1 & 0 & 0 \\ 0 & 0 & 1 & 0 \\ 0 & 0 & 0 & 1 \end{pmatrix} \quad s \mapsto \begin{pmatrix} 0 & -i & 0 & 0 \\ i & 0 & 0 & 0 \\ 0 & 0 & 1 & 0 \\ 0 & 0 & 0 & 1 \end{pmatrix} \quad t \mapsto \begin{pmatrix} 0 & 1 & 0 & 0 \\ 1 & 0 & 0 & 0 \\ 0 & 0 & 1 & 0 \\ 0 & 0 & 0 & 1 \end{pmatrix} \quad u \mapsto \begin{pmatrix} 1 & 0 & 0 & 0 \\ 0 & 0 & 1 & 0 \\ 0 & 1 & 0 & 0 \\ 0 & 0 & 0 & 1 \end{pmatrix} \quad v \mapsto \begin{pmatrix} 1 & 0 & 0 & 0 \\ 0 & 1 & 0 & 0 \\ 0 & 0 & 0 & 1 \\ 0 & 0 & 1 & 0 \end{pmatrix}$$

$$\alpha \mapsto tusrsv \quad \beta \mapsto (rstuv)^2$$

$$\boxed{3'} \quad \mathcal{O} \twoheadrightarrow \text{Sym}_4 \cong W(\mathbf{A}_3) = \langle r, s, t \mid r^2 = s^2 = t^2 = (rs)^3 = (st)^3 = (rt)^2 = 1 \rangle$$

$$\alpha \mapsto rst \quad \beta \mapsto ts$$

$$\boxed{2''} \quad \mathcal{O} \twoheadrightarrow \text{Sym}_3 \cong W(\mathbf{A}_2) = \langle r, s \mid r^2 = s^2 = (rs)^3 = 1 \rangle$$

$$\alpha \mapsto r \quad \beta \mapsto rs$$

$$\boxed{2'} \quad \mathcal{O} \hookrightarrow G_{13} = \langle r, s, t \mid r^2 = s^2 = t^2 = 1, rstrs = trstr, strs = trst \rangle$$

$$\alpha \mapsto (rs)^3 \quad \beta \mapsto st$$

$$\boxed{1'} \quad \mathcal{O} \twoheadrightarrow \text{Sym}_2 \cong W(\mathbf{A}_1) = \langle r \mid r^2 = 1 \rangle$$

$$\alpha \mapsto r \quad \beta \mapsto 1$$

Icosahedral case $\mathcal{I} = \langle \alpha, \beta, \gamma \mid \alpha^5 = \beta^3 = \gamma^2 = \alpha\beta\gamma \rangle$

\mathcal{I} has three normal subgroups. The quotient groups look as follows.

- $\langle \alpha, \beta, \gamma \mid \alpha^5 = \beta^3 = \gamma^2 = \alpha\beta\gamma \rangle = \mathcal{I}$
- $\langle \alpha, \beta, \gamma \mid \alpha^5 = \beta^3 = \gamma^2 = \alpha\beta\gamma = 1 \rangle \cong \text{Alt}_5$
- $\langle \alpha, \beta, \gamma \mid \alpha = \beta = \gamma = 1 \rangle = 1$

$$\boxed{1} \quad \mathcal{I} \twoheadrightarrow 1 \hookrightarrow \text{Sym}_2 \cong W(\mathbf{A}_1) = \langle r \mid r^2 = 1 \rangle$$

$$\alpha \mapsto 1 \quad \beta \mapsto 1$$

$$\boxed{2} \quad \mathcal{I} \hookrightarrow G_{22} = \langle r, s, t \mid r^2 = s^2 = t^2 = 1, rstrsr = (trs)^2, strs = trst \rangle$$

$$r \mapsto \begin{pmatrix} 0 & -i \\ i & 0 \end{pmatrix} \quad s \mapsto \begin{pmatrix} 0 & i\eta^3 \\ -i\eta^2 & 0 \end{pmatrix} \quad t \mapsto \frac{i}{\sqrt{5}} \begin{pmatrix} \eta^2 - \eta^3 & -1 + \eta^2 \\ 1 - \eta^3 & -\eta^2 + \eta^3 \end{pmatrix} \quad (\eta = \exp(2\pi i/5))$$

$$\alpha \mapsto rs \quad \beta \mapsto ts$$

$$\boxed{3} \quad \mathcal{I} \twoheadrightarrow \text{Alt}_5 \hookrightarrow G_{23} = W(\mathbf{H}_3) = \langle r, s, t \mid r^2 = s^2 = t^2 = (rs)^5 = (st)^3 = (rt)^2 = 1 \rangle$$

$$r \mapsto \frac{1}{2} \begin{pmatrix} \tau' & \tau & 1 \\ \tau & 1 & \tau' \\ 1 & \tau' & \tau \end{pmatrix} \quad s \mapsto \begin{pmatrix} -1 & 0 & 0 \\ 0 & 1 & 0 \\ 0 & 0 & 1 \end{pmatrix} \quad t \mapsto \frac{1}{2} \begin{pmatrix} 1 & \tau' & -\tau \\ \tau' & \tau & -1 \\ -\tau & -1 & \tau' \end{pmatrix} \quad (\tau = \frac{1+\sqrt{5}}{2}, \tau' = 1 - \tau)$$

$$\alpha \mapsto rs \quad \beta \mapsto st$$

$$\boxed{4} \quad \mathcal{I} \hookrightarrow G_{29} = \left\langle r, s, t, u \mid \begin{array}{l} r^2 = s^2 = t^2 = u^2 = (rs)^3 = (rt)^2 = (ru)^2 = 1 \\ (st)^4 = (su)^3 = (tu)^3 = 1, (ust)^2 = (stu)^2 \end{array} \right\rangle$$

$$r \mapsto \begin{pmatrix} -1 & 0 & 0 & 0 \\ 0 & 1 & 0 & 0 \\ 0 & 0 & 1 & 0 \\ 0 & 0 & 0 & 1 \end{pmatrix} \quad s \mapsto \frac{1}{2} \begin{pmatrix} 1 & -1 & i & i \\ -1 & 1 & i & i \\ -i & -i & 1 & -1 \\ -i & -i & -1 & 1 \end{pmatrix} \quad t \mapsto \begin{pmatrix} 1 & 0 & 0 & 0 \\ 0 & 1 & 0 & 0 \\ 0 & 0 & 0 & -1 \\ 0 & 0 & -1 & 0 \end{pmatrix} \quad u \mapsto \begin{pmatrix} 1 & 0 & 0 & 0 \\ 0 & 0 & 1 & 0 \\ 0 & 1 & 0 & 0 \\ 0 & 0 & 0 & 1 \end{pmatrix}$$

$$\alpha \mapsto (rstu)^2 \quad \beta \mapsto rstsrustst$$

$$\begin{aligned}
\boxed{5} \quad \mathcal{I} &\rightarrow \text{Alt}_5 \hookrightarrow \text{Sym}_6 \cong W(\mathbf{A}_5) \\
&= \left\langle r, s, t, u, v \mid \begin{array}{l} r^2 = s^2 = t^2 = u^2 = v^2 = 1 \\ (rs)^3 = (st)^3 = (tu)^3 = (uv)^3 = 1 \\ (rt)^2 = (ru)^2 = (rv)^2 = (su)^2 = (sv)^2 = (tv)^2 = 1 \end{array} \right\rangle \\
&\quad \alpha \mapsto rstu \quad \beta \mapsto sruv
\end{aligned}$$

This may be used to recover the classical fact that the outer automorphism group of the symmetric group of degree 6 is nontrivial.

$$\begin{aligned}
\boxed{6} \quad \mathcal{I} &\hookrightarrow G(4, 4, 6) \\
&= \left\langle r, s, t, u, v, w \mid \begin{array}{l} r^2 = s^2 = t^2 = u^2 = v^2 = w^2 = 1 \\ (rs)^4 = (rt)^3 = (ru)^2 = (rv)^2 = (rw)^2 = 1 \\ (st)^3 = 1, (trs)^2 = (rst)^2 \\ (su)^2 = (sv)^2 = (sw)^2 = (tv)^2 = (tw)^2 = (uw)^2 = 1 \\ (tu)^3 = (uv)^3 = (vw)^3 = 1 \end{array} \right\rangle \\
r \mapsto &\begin{pmatrix} 0 & i & 0 & 0 & 0 & 0 \\ -i & 0 & 0 & 0 & 0 & 0 \\ 0 & 0 & 1 & 0 & 0 & 0 \\ 0 & 0 & 0 & 1 & 0 & 0 \\ 0 & 0 & 0 & 0 & 1 & 0 \\ 0 & 0 & 0 & 0 & 0 & 1 \end{pmatrix} \quad s \mapsto \begin{pmatrix} 0 & 1 & 0 & 0 & 0 & 0 \\ 1 & 0 & 0 & 0 & 0 & 0 \\ 0 & 0 & 1 & 0 & 0 & 0 \\ 0 & 0 & 0 & 1 & 0 & 0 \\ 0 & 0 & 0 & 0 & 1 & 0 \\ 0 & 0 & 0 & 0 & 0 & 1 \end{pmatrix} \quad t \mapsto \begin{pmatrix} 1 & 0 & 0 & 0 & 0 & 0 \\ 0 & 0 & 1 & 0 & 0 & 0 \\ 0 & 1 & 0 & 0 & 0 & 0 \\ 0 & 0 & 0 & 1 & 0 & 0 \\ 0 & 0 & 0 & 0 & 1 & 0 \\ 0 & 0 & 0 & 0 & 0 & 1 \end{pmatrix} \quad \cdots \quad w \mapsto \begin{pmatrix} 1 & 0 & 0 & 0 & 0 & 0 \\ 0 & 1 & 0 & 0 & 0 & 0 \\ 0 & 0 & 1 & 0 & 0 & 0 \\ 0 & 0 & 0 & 1 & 0 & 0 \\ 0 & 0 & 0 & 0 & 1 & 0 \\ 0 & 0 & 0 & 0 & 0 & 1 \end{pmatrix}
\end{aligned}$$

[u, v are mapped to the permutation matrices for the transpositions (34), (45)]

$$\alpha \mapsto (rstuvw)^2 \quad \beta \mapsto srtsrutsrtuwutrvwu$$

$$\begin{aligned}
\boxed{4'} \quad \mathcal{I} &\rightarrow \text{Alt}_5 \hookrightarrow \text{Sym}_5 \cong W(\mathbf{A}_4) \\
&= \left\langle r, s, t, u \mid \begin{array}{l} r^2 = s^2 = t^2 = u^2 = (rs)^3 = (st)^3 = (tu)^3 = 1 \\ (rt)^2 = (ru)^2 = (su)^2 = 1 \end{array} \right\rangle \\
&\quad \alpha \mapsto rstu \quad \beta \mapsto stsr
\end{aligned}$$

$$\begin{aligned}
\boxed{3'} \quad \mathcal{I} &\rightarrow \text{Alt}_5 \hookrightarrow G_{23} = W(\mathbf{H}_3) = \langle r, s, t \mid r^2 = s^2 = t^2 = (rs)^5 = (st)^3 = (rt)^2 = 1 \rangle \\
&\quad \alpha \mapsto (rs)^3 \quad \beta \mapsto rtsrsrts
\end{aligned}$$

$$\begin{aligned}
\boxed{2'} \quad \mathcal{I} &\hookrightarrow G_{22} = \langle r, s, t \mid r^2 = s^2 = t^2 = 1, rstrsr = (trs)^2, strst = trst \rangle \\
&\quad \alpha \mapsto (rs)^3 \quad \beta \mapsto (sr)^2(tr)^2
\end{aligned}$$

References

- [BLM] S. Berman, Y. S. Lee, R. V. Moody: The spectrum of a Coxeter transformation, affine Coxeter transformations, and the defect map. *J. Algebra* **121** (1989), 339–357.
- [BMR] M. Broué, G. Malle, R. Rouquier: Complex reflection groups, braid groups, Hecke algebras. *J. Reine angew. Math.* **500** (1998), 127–190.
- [Bo] N. Bourbaki: Groupes et algèbres de Lie. Chapitres 4, 5 et 6. Hermann, Paris 1968. Masson, Paris 1981.
- [Ch] C. Chevalley: Invariants of finite groups generated by reflections. *Amer. J. Math.* **77** (1955), 778–782.

- [Co] A. J. Coleman: Killing and the Coxeter transformation of Kac-Moody algebras. *Invent. Math.* **95** (1989), 447–477.
- [GAP] The GAP Group, GAP—Groups, Algorithms, and Programming, Version 4.2; Aachen, St Andrews, 2000. (<http://www-gap.dcs.st-and.ac.uk/~gap>). The GAP Group, GAP—Groups, Algorithms, and Programming, Version 4.4; 2004. (<http://www.gap-system.org>)
- [G-SVe] G. Gonzalez-Sprinberg, J.-L. Verdier: Construction géométrique de la correspondance de McKay. *Ann. Sci. École Norm. Sup. (4)* **16** (1983), 409–449.
- [Kn] H. Knörrer: Group representations and the resolution of rational double points. In: *Finite groups—coming of age (Montreal, Que., 1982)*. *Contemp. Math.* **45** (1985), 175–222.
- [Ko1] B. Kostant: The McKay correspondence, the Coxeter element and representation theory. In: *Élie Cartan et les mathématiques d’aujourd’hui (Lyon, 1984)*. *Astérisque, Numéro Hors Série* (1985), 209–255.
- [Ko2] B. Kostant: The Coxeter element and the branching law for the finite subgroups of $SU(2)$. [arXiv:math.RT/0411142](https://arxiv.org/abs/math/0411142)
- [LT] G. Lusztig, J. Tits: The inverse of a Cartan matrix. *An. Univ. Timișoara Ser. Științ. Mat.* **30** (1992), 17–23.
- [McK1] J. McKay: Graphs, singularities, and finite groups. In: *The Santa Cruz Conference on Finite Groups (Univ. California, Santa Cruz, Calif., 1979)*. *Proc. Symp. Pure Math.* **37** (1980), 183–186.
- [McK2] J. McKay: Cartan matrices, finite groups of quaternions, and Kleinian singularities. *Proc. Amer. Math. Soc.* **81** (1981), 153–154.
- [McK3] J. McKay: Semi-affine Coxeter-Dynkin graphs and $G \subseteq SU_2(\mathbb{C})$. *Canad. J. Math.* **51** (1999), 1226–1229.
- [Sa] K. Saito: A new relation among Cartan matrix and Coxeter matrix. *J. Algebra* **105** (1987), 149–158.
- [Sm] L. Smith: On the invariant theory of finite pseudo reflection groups. *Arch. Math.* **44** (1985), 225–228.
- [Sp1] T. A. Springer: Poincaré series of binary polyhedral groups and McKay’s correspondence. *Math. Ann.* **278** (1987), 99–116.
- [Sp2] T. A. Springer: Some remarks on characters of binary polyhedral groups. *J. Algebra* **131** (1990), 641–647.
- [St] R. Steinberg: Finite subgroups of SU_2 , Dynkin diagrams and affine Coxeter elements. *Pacific J. Math.* **118** (1985), 587–598.
- [ST] G. C. Shephard, J. A. Todd: Finite unitary reflection groups. *Can. J. Math.* **6** (1954), 274–304.