

MATRADS, BIASSOCIAHEDRA, AND  $A_\infty$ -BIALGEBRASSAMSON SANEBLIDZE<sup>1</sup> AND RONALD UMBLE<sup>2</sup>

ABSTRACT. We introduce the notion of a matrad  $M = \{M_{n,m}\}$  whose submodules  $M_{*,1}$  and  $M_{1,*}$  are non- $\Sigma$  operads. We define the free matrad  $\mathcal{H}_\infty$  generated by a singleton  $\theta_m^n$  in each bidegree  $(m, n)$  and realize  $\mathcal{H}_\infty$  as the cellular chains on a new family of polytopes  $\{KK_{n,m} = KK_{m,n}\}$ , called *biassociahedra*, of which  $KK_{n,1} = KK_{1,n}$  is the associahedron  $K_n$ . We construct the universal enveloping functor from matrads to PROPs and define an  $A_\infty$ -bialgebra as an algebra over  $\mathcal{H}_\infty$ .

## CONTENTS

1. Introduction	2
2. Low Dimensional Biassociahedra	3
2.1. The Fraction Product	3
2.2. Low Dimensional Matrad Products	4
3. Submodules of $TTM$	8
4. Prematrads	11
4.1. $\Upsilon$ -products on $\overline{\mathbf{M}}$	11
4.2. Prematrads Defined	12
4.3. Free Prematrads	16
4.4. The Bialgebra Prematrad	20
4.5. Local Prematrads	21
5. Diagonal Approximations	21
5.1. The S-U Diagonals $\Delta_P$ and $\Delta_K$	21
5.2. $k$ -Subdivisions and $k$ -Approximations	22
6. Matrads	25
6.1. Matrads Defined	26
6.2. Free Matrads	29
6.3. The Biderivative	31
7. The Posets $\mathcal{PP}$ and $\mathcal{KK}$	32
8. The Combinatorial Join of Permutahedra	36
9. Constructions of $PP$ and $KK$	37
9.1. Matrices with constant rows or columns	37
9.2. Step 1: The $(m, n)$ -subdivision of $\underline{m}   (\underline{n} + m)$	40
9.3. Step 2: Subdividing cells of $P_{m+n} \setminus \underline{m}   (\underline{n} + m)$	41
9.4. $PP$ -factorization of proper cells	43
9.5. The projection $\vartheta\vartheta : PP \rightarrow KK$	45
References	53

---

*Date:* November 30, 2010.

1991 *Mathematics Subject Classification.* Primary 55P35, 55P99; Secondary 52B05.

*Key words and phrases.*  $A_\infty$ -bialgebra, operad, matrad, permutahedron, biassociahedron.

<sup>1</sup> This research described in this publication was made possible in part by Award No. GM1-2083 of the U.S. Civilian Research and Development Foundation for the Independent States of the Former Soviet Union (CRDF) and by Award No. 99-00817 of INTAS.

<sup>2</sup> This research funded in part by a Millersville University faculty research grant.

## 1. INTRODUCTION

Let  $H$  be a DG module over a commutative ring  $R$  with identity. In [13], we defined an  $A_\infty$ -bialgebra structure on  $H$  in terms of a square-zero  $\odot$ -product on the universal PROP  $U_H = \text{End}(TH)$ . In this paper we take an alternative point-of-view motivated by three classical constructions: First, chain maps  $\text{Ass} \rightarrow U_H$  and  $\mathcal{A}_\infty \rightarrow U_H$  in the category of non- $\Sigma$  operads define strictly (co)associative and  $A_\infty$ -(co)algebra structures on  $H$ ; second, there is a minimal resolution of operads  $\mathcal{A}_\infty \rightarrow \text{Ass}$ ; and third,  $\mathcal{A}_\infty$  is realized by the cellular chains on the Stasheff associahedra  $K = \sqcup K_n$  [10], [9]. It is natural, therefore, to envision a category in which analogs of  $\text{Ass}$  and  $\mathcal{A}_\infty$  define strictly biassociative and  $A_\infty$ -bialgebra structures on  $H$ .

In this paper we introduce the notion of a *matrad* whose distinguished objects  $\mathcal{H}$  and  $\mathcal{H}_\infty$  play the role of  $\text{Ass}$  and  $\mathcal{A}_\infty$ . But unlike the operadic case, freeness considerations are subtle since biassociative bialgebras cannot be simultaneously free and cofree. Although  $\mathcal{H}$  and  $\mathcal{H}_\infty$  are generated by singletons in each bidegree, those in  $\mathcal{H}$  are module generators while those in  $\mathcal{H}_\infty$  are matrad generators. Indeed, as a non-free matrad,  $\mathcal{H}$  has two matrad generators and  $\mathcal{H}_\infty$  is its minimal resolution. Thus  $\mathcal{H}$  and  $\mathcal{H}_\infty$  are the smallest possible constructions that control biassociative bialgebras structures and their homotopy versions (c.f. [8], [15], [11]).

Given a finite sequence  $\mathbf{x}$  in  $\mathbb{N}$ , let  $|\mathbf{x}| = \sum x_i$ . A matrad  $(M, \gamma)$  is a bigraded module  $M = \{M_{n,m}\}_{m,n \geq 1}$  together with a family of structure maps

$$\gamma = \{\gamma_{\mathbf{x}}^{\mathbf{y}} : \Gamma_{\mathbf{p}}^{\mathbf{y}}(M) \otimes \Gamma_{\mathbf{x}}^{\mathbf{q}}(M) \rightarrow M_{|\mathbf{y}|, |\mathbf{x}|}\}_{\mathbf{x}, \mathbf{y} \in \mathbb{N}^{1 \times p} \times \mathbb{N}^{q \times 1}}$$

defined on certain submodules  $\Gamma_{\mathbf{p}}^{\mathbf{y}}(M) \otimes \Gamma_{\mathbf{x}}^{\mathbf{q}}(M) \subseteq \bigotimes_{j=1}^q M_{y_j, p} \otimes \bigotimes_{i=1}^p M_{q, x_i}$  and generated by certain components of the S-U diagonal  $\Delta_P$  on permutahedra [12]; its substructures  $(\Gamma_1^{\mathbf{y}}(M), \gamma)$  and  $(\Gamma_{\mathbf{x}}^1(M), \gamma)$  are non- $\Sigma$  operads. We think of monomials in  $\Gamma_{\mathbf{x}}^{\mathbf{q}}(M)$  as  $p$ -fold tensor products of multilinear operations, each with  $q$  outputs, and monomials in  $\Gamma_{\mathbf{p}}^{\mathbf{y}}(M)$  as  $q$ -fold tensor products of multilinear operations, each with  $p$  inputs.

A general PROP, and  $U_H$  in particular, admits a canonical matrad structure and chain maps  $\mathcal{H} \rightarrow U_H$  and  $\mathcal{H}_\infty \rightarrow U_H$  in the category of matrads define biassociative bialgebra and  $A_\infty$ -bialgebra structures on  $H$ . Furthermore,  $\mathcal{H}_\infty$  is realized by the cellular chains on a new family of polytopes  $KK = \bigsqcup_{m,n \geq 1} KK_{m,n}$ , called *biassociahedra*, of which  $KK_{m,n} = KK_{n,m}$ , and  $KK_{1,n}$  is the Stasheff associahedron  $K_n$ . We identify the top dimensional cell of  $KK_{m,n}$  with the indecomposable matrad generator  $\theta_m^n$  represented graphically by a ‘‘double corolla’’ with data flowing upward through  $m$  input and  $n$  output channels (see Figure 1). The action of the matrad product  $\gamma$  on the submodule  $\Theta = \langle \theta_m^n \rangle_{m,n \geq 1}$  generates  $\mathcal{H}_\infty$ ; we define a differential  $\partial$  of degree  $-1$  on  $\theta_m^n$  and extend it as a derivation of  $\gamma$  (as in Example 6.11).

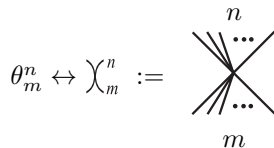

Figure 1.

Among the various attempts to construct homotopy versions of bialgebras, recent independent results of Markl and Shoikhet are related to ours through the theory of

PROPs: In characteristic 0, the low-order relations in Markl's version of a homotopy bialgebra [8] agree with our  $A_\infty$ -bialgebra relations and Shoikhet's composition product on the universal preCROC [15] agrees with our prematrad operation on  $U_H$ . Thus we construct a functor from matrads to PROPs called the *universal enveloping functor*.

The paper is organized as follows: In Section 2 we construct the biassociahedra  $KK_{n,m}$  in the range  $m + n \leq 6$ . These polytopes have a simple description in terms of the S-U diagonal  $\Delta_K$  on associahedra [12] and demonstrate the general construction while avoiding the complicating subtleties. In Section 3 we discuss various submodules of  $TTM$  (the tensor module of  $TM$ ) that model the geometry of our construction. We introduce the notion of a prematrad in Section 4, the notion of a  $k$ -approximation in Section 5, and a matrad in Section 6. We construct the posets  $\mathcal{PP}$  and  $\mathcal{KK}$  in Section 7, introduce the notion of the combinatorial join of permutahedra in Section 8, and construct  $PP$  and  $KK$  as geometric realizations of  $\mathcal{PP}$  and  $\mathcal{KK}$  in Section 9. We identify the cellular chains of  $KK$  with the  $A_\infty$ -bialgebra matrad  $\mathcal{H}_\infty$  and prove that the restriction of the free resolution of prematrads  $\rho^{\text{pre}} : F^{\text{pre}}(\Theta) \rightarrow \mathcal{H}$  to  $\mathcal{H}_\infty$  is a free resolution in the category of matrads.

## 2. LOW DIMENSIONAL BIASSOCIAHEDRA

Our construction of the biassociahedra  $\{KK_{n,m}\}$  in the range  $1 \leq m, n \leq 4$  and  $m + n \leq 6$  is controlled by the S-U diagonal on associahedra  $K$ ; the polytope  $KK_{n,m}$  is identical to  $B_m^n$  constructed by M. Markl in [8]. In the course of his construction, Markl makes arbitrary choices, which correspond to choices we made when constructing the S-U diagonal  $\Delta_K$ . So for us, all choices in our construction were made a priori once and for all.

**2.1. The Fraction Product.** Let  $\Theta = \langle \theta_m^n \neq 0 \mid \theta_1^1 = \mathbf{1} \rangle_{m,n \geq 1}$  and let  $M = \{M_{n,m}\}_{m,n \geq 1}$  be the free PROP generated by  $\Theta$ . For simplicity, we assume that  $M$  is a free bigraded  $\mathbb{Z}_2$ -module; sign considerations that arise over a general ground ring will be addressed in subsequent sections. For  $p, q \geq 1$ , let  $\mathbf{x} \times \mathbf{y} = (x_1, \dots, x_p) \times (y_1, \dots, y_q) \in \mathbb{N}^p \times \mathbb{N}^q$ . In [8], M. Markl defined the submodule  $S$  of *special elements* in  $M$  whose additive generators are monomials  $\alpha_{\mathbf{x}}^{\mathbf{y}}$  expressed as "elementary fractions" of the form

$$(2.1) \quad \alpha_{\mathbf{x}}^{\mathbf{y}} = (\alpha_p^{y_1} \cdots \alpha_p^{y_q}) / (\alpha_{x_1}^q \cdots \alpha_{x_p}^q),$$

where  $\alpha_{x_i}^q$  and  $\alpha_p^{y_j}$  are additive generators of  $S$  and the  $j^{\text{th}}$  output of  $\alpha_{x_i}^q$  is linked to the  $i^{\text{th}}$  input of  $\alpha_p^{y_j}$  (juxtaposition in the numerator and denominator denotes tensor product). Thus  $\dim \alpha_{\mathbf{x}}^{\mathbf{y}} = \sum_{i,j} \dim \alpha_{x_i}^q + \dim \alpha_p^{y_j}$ , and  $\alpha_{\mathbf{x}}^{\mathbf{y}}$  is represented graphically by a connected non-planar graph under the identification  $\theta_m^n \leftrightarrow \chi_m^n$  (see Example 1). We refer to  $\mathbf{x}$  and  $\mathbf{y}$  as the *leaf sequences* of  $\alpha_{\mathbf{x}}^{\mathbf{y}}$ .

Let  $TM$  denote the tensor module of  $M$ . All elementary fractions define a non-associative *fraction product*  $/ : TM \otimes TM \rightarrow S$ . For example, in the iterated fraction

$$A/B/C = \lambda / (\lambda \mathbf{1}) / (\lambda \mathbf{1} \mathbf{1})$$

with  $\lambda \leftrightarrow \theta_2^1$ , we have  $(A/B)/C \neq 0$  and  $A/(B/C) = 0$ . Notationally, let  $\mathbf{M}_{\mathbf{x}}^q = M_{q,x_1} \otimes \cdots \otimes M_{q,x_p}$  and  $\mathbf{M}_p^{\mathbf{y}} = M_{y_1,p} \otimes \cdots \otimes M_{y_q,p}$ ; then the fraction product (2.1)

can be expressed in terms of our *prematrad product*  $\gamma_{\mathbf{x}}^{\mathbf{y}} : \mathbf{M}_p^{\mathbf{y}} \otimes \mathbf{M}_{\mathbf{x}}^q \rightarrow M_{|\mathbf{y}|, |\mathbf{x}|}$  as

$$(\alpha_p^{y_1} \cdots \alpha_p^{y_q}) / (\alpha_{x_1}^q \cdots \alpha_{x_p}^q) = \gamma_{\mathbf{x}}^{\mathbf{y}} (\alpha_p^{y_1} \cdots \alpha_p^{y_q}; \alpha_{x_1}^q \cdots \alpha_{x_p}^q).$$

Note that the free action of  $\gamma$  on up-rooted  $m$ -leaf corollas  $\lambda_m$  (or on down-rooted  $n$ -leaf corollas  $\Upsilon^n$ ) generates all planar rooted trees with levels (PLTs), and the projection to planar rooted trees (PRTs) by forgetting levels induces the standard operadic product.

The matrad  $\mathcal{H}_{\infty}$  is a proper submodule of  $S$  and the matrad product  $\gamma$  is the fraction product restricted to  $\mathcal{H}_{\infty}$ . Thus we may regard the  $A_{\infty}$ -operad  $\mathcal{A}_{\infty}$  as either

$$(2.2) \quad \mathcal{H}_{1,*} = (\langle \theta_m^1 \mid m \geq 1 \rangle / \sim, \partial), \text{ where } \partial(\theta_m^1) = \sum_{\substack{\alpha_m^1 \in \mathcal{H}_{1,*} \cdot \mathcal{H}_{1,*} \\ \dim \alpha_m^1 = m-3}} \alpha_m^1 \text{ or}$$

$$\mathcal{H}_{*,1} = (\langle \theta_1^n \mid n \geq 1 \rangle / \sim, \partial), \text{ where } \partial(\theta_1^n) = \sum_{\substack{\alpha_1^n \in \mathcal{H}_{*,1} \cdot \mathcal{H}_{*,1} \\ \dim \alpha_1^n = n-3}} \alpha_1^n.$$

**2.2. Low Dimensional Matrad Products.** Let us construct  $\{\mathcal{H}_{n,m}\}_{m+n \leq 6}$  inductively as stage  $\mathcal{F}_6$  of the increasing filtration  $\mathcal{F}_k = \bigoplus_{m+n \leq k} \mathcal{H}_{n,m}$ . Our construction is controlled by the S-U diagonal  $\Delta_K$  on cellular chains of the associahedra  $K$  (see Subsection 5.1 and [12]), which in the range of dimensions considered here is given by

$$\begin{aligned} \Delta_K(\lambda_2) &= \lambda_2 \otimes \lambda_1, \\ \Delta_K(\lambda_3) &= \lambda_3 \otimes \lambda_2 + \lambda_2 \otimes \lambda_3, \text{ and} \\ \Delta_K(\lambda_4) &= \lambda_4 \otimes \lambda_3 + \lambda_3 \otimes \lambda_4 + \lambda_2 \otimes \lambda_2 \otimes \lambda_2 \\ &\quad + \lambda_2 \otimes \lambda_2 \otimes \lambda_2 + \lambda_2 \otimes \lambda_2 \otimes \lambda_2. \end{aligned}$$

Note that  $\Delta_K$  agrees with the Alexander-Whitney diagonal on  $K_2 = *$  and  $K_3 = I$ . Define  $\Delta_K^{(0)} = \mathbf{1}$ ; for each  $k \geq 1$ , define the (left)  $k$ -fold iterate of  $\Delta_K$  by

$$\Delta_K^{(k)} = (\Delta_K \otimes \mathbf{1}^{\otimes k-1}) \Delta_K^{(k-1)}$$

and view  $\Delta_K^{(k)}(\lambda_p)$  as a  $(p-2)$ -dimensional subcomplex of  $K_p^{\times k+1}$ , and dually for  $\Delta_K^{(k)}(\Upsilon^p)$ .

Referring to (2.2) above, define  $\mathcal{F}_3 = \mathcal{H}_{1,1} \oplus \mathcal{H}_{1,2} \oplus \mathcal{H}_{2,1}$ . To construct  $\mathcal{F}_4$ , use the generators of  $\mathcal{F}_3$  to construct all possible elementary fractions with two inputs and two outputs. There are exactly two such elementary fractions, namely,

$$\alpha_2^2 \leftrightarrow \Upsilon / \lambda \quad \text{and} \quad \alpha_{11}^{11} \leftrightarrow (\lambda \lambda) / (\Upsilon \Upsilon),$$

each of dimension zero. Let  $\mathcal{H}_{2,2} = \langle \theta_2^2, \alpha_2^2, \alpha_{11}^{11} \rangle$  and define  $\partial(\theta_2^2) = \alpha_2^2 + \alpha_{11}^{11}$ . Then  $\mathcal{H}_{2,2}$  is a proper submodule of  $M_{2,2}$  and  $KK_{2,2}$  is an interval  $I$  whose edge is identified with  $\theta_2^2$  and whose vertices are identified with  $\alpha_2^2$  and  $\alpha_{11}^{11}$ . Define  $\mathcal{F}_4 = \mathcal{F}_3 \oplus \mathcal{H}_{1,3} \oplus \mathcal{H}_{2,2} \oplus \mathcal{H}_{3,1}$ .

Although all fraction products are used to construct  $\mathcal{F}_4$ , more fractions than we need appear at the next stage of the construction and beyond. Note that each numerator or denominator of  $\alpha_2^2$  and  $\alpha_{11}^{11}$  is an iterated S-U diagonal  $\Delta_K^{(k)}(\Upsilon)$  or

$\Delta_K^{(k)}(\lambda)$  for some  $k = 0, 1$ . Indeed, the components of  $\Delta_K^{(k)}(\lambda_m)$  and  $\Delta_K^{(k)}(\gamma^n)$  will determine which fraction products to admit and which to discard.

Continuing with the construction of  $\mathcal{F}_5$ , use the generators of  $\mathcal{F}_4$  to construct all possible fractions with three inputs and two outputs. There are 18 of these: one in dimension 2, nine in dimension 1 and eight in dimension 0. Since  $KK_{2,3}$  is to have a single top dimensional (indecomposable) 2-cell, we must discard the 2-dimensional (decomposable) generator

$$e = \frac{\begin{array}{c} \diagup \quad \diagdown \\ \diagdown \quad \diagup \\ \diagup \quad \diagdown \end{array}}{\begin{array}{c} \diagdown \quad \diagup \\ \diagdown \quad \diagup \\ \diagdown \quad \diagup \end{array}}$$

as well as the appropriate components of its boundary. Note that  $e$  represents a square given by the Cartesian product of the three points in the denominator with the two intervals in the numerator. Thus the boundary of  $e$  consists of the four edges

$$(2.3) \quad \frac{\begin{array}{c} \diagup \quad \diagdown \\ \diagdown \quad \diagup \end{array}}{\begin{array}{c} \diagdown \quad \diagup \\ \diagdown \quad \diagup \end{array}}, \quad \frac{\begin{array}{c} \diagdown \quad \diagup \\ \diagdown \quad \diagup \end{array}}{\begin{array}{c} \diagdown \quad \diagup \\ \diagdown \quad \diagup \end{array}}, \quad \frac{\begin{array}{c} \diagdown \quad \diagup \\ \diagdown \quad \diagup \end{array}}{\begin{array}{c} \diagdown \quad \diagup \\ \diagdown \quad \diagup \end{array}}, \quad \frac{\begin{array}{c} \diagdown \quad \diagup \\ \diagdown \quad \diagup \end{array}}{\begin{array}{c} \diagdown \quad \diagup \\ \diagdown \quad \diagup \end{array}},$$

the first two of which contain components of  $\Delta_K^{(1)}(\lambda_3)$  and  $\Delta_K^{(2)}(\gamma)$  in their numerators and denominators. Our selection rule admits the first two edges and their vertices.

Express each of the factors  $\alpha_{x_i}^q$  and  $\alpha_p^{y_j}$  in  $\alpha_{\mathbf{x}}^{\mathbf{y}} = \gamma_{\mathbf{x}}^{\mathbf{y}} \left( \alpha_p^{y_1} \cdots \alpha_p^{y_q}; \alpha_{x_1}^q \cdots \alpha_{x_p}^q \right)$  in terms of their respective *leaf sequences*  $\mathbf{x}_i$ ,  $\mathbf{q}_i$ ,  $\mathbf{y}_j$  and  $\mathbf{p}_j$  so that

$$\alpha_{\mathbf{x}}^{\mathbf{y}} = \frac{\alpha_{\mathbf{p}_1}^{\mathbf{y}_1} \cdots \alpha_{\mathbf{p}_q}^{\mathbf{y}_q}}{\alpha_{\mathbf{x}_1}^{\mathbf{q}_1} \cdots \alpha_{\mathbf{x}_p}^{\mathbf{q}_p}}.$$

Then  $(\mathbf{p}_1, \dots, \mathbf{p}_q)$  and  $(\mathbf{q}_1, \dots, \mathbf{q}_p)$  define the *upper and lower contact sequences* of  $\alpha_{\mathbf{x}}^{\mathbf{y}}$ , respectively.

**Example 1.** *The upper and lower contact sequences of*

$$(2.4) \quad \alpha_{111}^{12} = \frac{\theta_3^1 \alpha_{12}^{11}}{\theta_1^2 \theta_1^2 \theta_1^2} \leftrightarrow \frac{\begin{array}{c} \diagup \quad \diagdown \\ \diagdown \quad \diagup \\ \diagdown \quad \diagup \end{array}}{\begin{array}{c} \diagdown \quad \diagup \\ \diagdown \quad \diagup \\ \diagdown \quad \diagup \end{array}} = \begin{array}{c} \diagup \quad \diagdown \\ \diagdown \quad \diagup \\ \diagdown \quad \diagup \end{array}$$

are  $((3), (1, 2))$  and  $((2), (2), (2))$ , respectively.

A non-vanishing *matrad monomial of codimension 1*

$$\alpha_{\mathbf{x}}^{\mathbf{y}} = \frac{\alpha_{\mathbf{p}_1}^{\mathbf{y}_1} \cdots \alpha_{\mathbf{p}_q}^{\mathbf{y}_q}}{\alpha_{\mathbf{x}_1}^{\mathbf{q}_1} \cdots \alpha_{\mathbf{x}_p}^{\mathbf{q}_p}} \in M_{|\mathbf{y}|, |\mathbf{x}|} \text{ with } |\mathbf{x}| + |\mathbf{y}| \leq 6$$

satisfies the following two conditions:

- (i) The upper contact sequence  $(\mathbf{p}_1, \dots, \mathbf{p}_q)$  is the list of leaf sequences in some component of  $\Delta_K^{(q-1)}(\lambda_p)$ .
- (ii) The lower contact sequence  $(\mathbf{q}_1, \dots, \mathbf{q}_p)$  is the list of leaf sequences in some component of  $\Delta_K^{(p-1)}(\gamma^q)$ .

**Example 2.** The elementary fraction  $\alpha_{111}^{12} = (\theta_3^1 \alpha_{12}^{11}) / (\theta_1^2 \theta_1^2 \theta_1^2)$  in Example 1 is a non-vanishing 2-dimensional matrad generator since its upper contact sequence  $((3), (1, 2))$  is the list of leaf sequences in the component

$$\begin{array}{c} \diagup \diagdown \otimes \diagup \diagdown \text{ of } \Delta_K^{(1)} \left( \begin{array}{c} \diagup \diagdown \end{array} \right) \end{array}$$

and its lower contact sequence  $((2), (2), (2))$  is the list of leaf sequences in

$$\Delta_K^{(2)}(\Upsilon) = \Upsilon \otimes \Upsilon \otimes \Upsilon.$$

Having discarded the last two fractions in (2.3), our selection rule admits seven 1-dimensional generators labeling the edges of  $KK_{2,3}$ . Now linearly extend the boundary map  $\partial$  to these matrad generators and compute the seven admissible 0-dimensional generators labeling the vertices of  $KK_{2,3}$  (see Figure 12). Then in addition to the 2-dimensional generator  $e$  and the last two 1-dimensional generators in (2.3), our selection rule discards the common vertex

$$\frac{\begin{array}{c} \diagup \diagdown \quad \diagup \diagdown \\ \Upsilon \quad \Upsilon \quad \Upsilon \end{array}}{\cdot}$$

Different elementary fractions may represent the same element. For example,

$$(2.5) \quad \frac{\begin{array}{c} \diagup \diagdown \quad \diagup \diagdown \\ \Upsilon \quad \Upsilon \quad \Upsilon \end{array}}{\cdot} = \frac{\begin{array}{c} \diagup \diagdown \quad \diagup \diagdown \\ \diagup \diagdown \quad \diagup \diagdown \quad \Upsilon \end{array}}{\cdot}.$$

The associativity and unit axioms in the definition of a prematrad (see Definition 2 below) identify various representations such as these.

Finally,  $\mathcal{H}_{2,3}$  is the proper submodule of  $M_{2,3}$  generated by  $\theta_3^2$  and the 14 admissible fractions  $\alpha_3^2$  given by the selection rule above. Define

$$\partial \left( \begin{array}{c} \diagdown \diagup \\ \diagup \diagdown \end{array} \right) = \frac{\begin{array}{c} \Upsilon \\ \diagup \diagdown \end{array}}{\cdot} + \frac{\begin{array}{c} \diagdown \diagup \\ \diagup \diagdown \quad | \end{array}}{\cdot} + \frac{\begin{array}{c} \diagdown \diagup \\ | \quad \diagup \diagdown \end{array}}{\cdot} + \frac{\begin{array}{c} \diagup \diagdown \quad \diagup \diagdown \\ \diagdown \diagup \quad \Upsilon \end{array}}{\cdot} + \frac{\begin{array}{c} \diagup \diagdown \quad \diagup \diagdown \\ \Upsilon \quad \diagdown \diagup \end{array}}{\cdot} + \frac{\begin{array}{c} \diagup \diagdown \quad \diagup \diagdown \\ \Upsilon \quad \Upsilon \quad \Upsilon \end{array}}{\cdot} + \frac{\begin{array}{c} \diagup \diagdown \quad \diagup \diagdown \\ \Upsilon \quad \Upsilon \quad \Upsilon \end{array}}{\cdot};$$

then  $KK_{2,3}$  is the heptagon pictured in Figure 2. Since  $KK_{3,2}$  is homeomorphic to  $KK_{2,3}$  (see Figure 19), we simultaneously obtain  $\mathcal{H}_{3,2}$ . Define  $\mathcal{F}_5 = \mathcal{F}_4 \oplus \mathcal{H}_{1,4} \oplus \mathcal{H}_{2,3} \oplus \mathcal{H}_{3,2} \oplus \mathcal{H}_{4,1}$ .

We continue with the construction of  $\mathcal{F}_6$ . Use the generators of  $\mathcal{F}_5$  to construct all possible fractions with two inputs and four outputs. Using the selection rule defined above, admit all elementary fractions in dimension 2 whose upper and lower contact sequences agree with lists of leaf sequences of components in  $\Delta_K^{(k)}(\lambda_p)$  or  $\Delta_K^{(k)}(\gamma^q)$ ; these represent the 2-faces of  $KK_{4,2}$ . Linearly extend the boundary map  $\partial$  and compute the admissible generators in dimensions 0 and 1. Let  $\mathcal{H}_{4,2}$  be the proper

submodule of  $M_{4,2}$  generated by  $\theta_2^4$  and all admissible fractions  $\alpha_2^4$ , and define

$$\begin{aligned} \partial(\times) &= \frac{\Psi}{\wedge} + \frac{|Y}{\times} + \frac{Y|}{\times} + \frac{||Y}{\times} + \frac{|Y|}{\times} + \frac{Y||}{\times} \\ &+ \frac{\wedge \times}{Y Y} + \frac{\times \times}{Y Y} + \frac{\times \wedge}{Y Y} + \frac{\wedge \wedge \times}{Y Y} + \frac{\wedge \wedge \times}{Y Y} + \frac{\wedge \times \wedge}{Y Y} \\ &+ \frac{\wedge \times \wedge}{Y Y} + \frac{\times \wedge \wedge}{Y Y} + \frac{\times \wedge \wedge}{Y Y} + \frac{\wedge \wedge \wedge \wedge}{Y Y} + \frac{\wedge \wedge \wedge \wedge}{Y Y} \\ &+ \frac{\wedge \wedge \wedge \wedge}{Y Y} + \frac{\wedge \wedge \wedge \wedge}{Y Y} + \frac{\wedge \wedge \wedge \wedge}{Y Y} + \frac{\wedge \wedge \wedge \wedge}{Y Y}; \end{aligned}$$

then  $KK_{4,2}$  is the 3-dimensional polytope pictured in Figures 3 and 21.

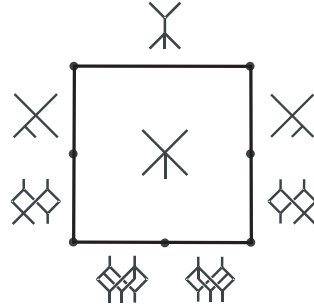

Figure 2. The biassociahedron  $KK_{2,3}$ .

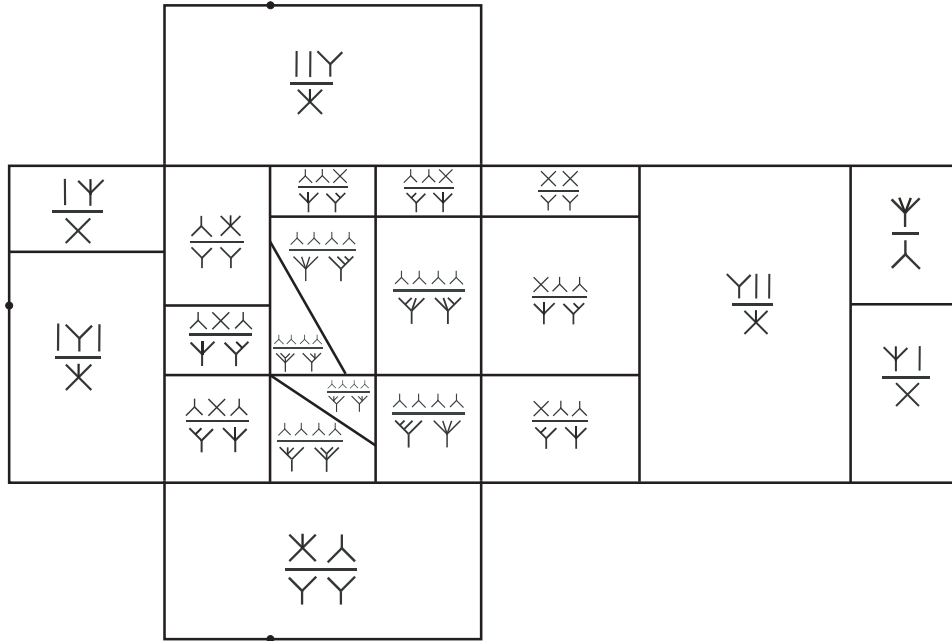

Figure 3. The 2-skeleton of  $KK_{4,2}$ .

Again,  $KK_{2,4}$  is homeomorphic to  $KK_{4,2}$  (see Figure 22) and we simultaneously obtain  $\mathcal{H}_{2,4}$ . While similar, the calculations for  $KK_{3,3}$  (see Figure 20) also involve elements such as (2.4); we leave this case to the reader. Define  $\mathcal{F}_6 = \mathcal{F}_5 \oplus \mathcal{H}_{1,5} \oplus \mathcal{H}_{2,4} \oplus \mathcal{H}_{3,3} \oplus \mathcal{H}_{4,2} \oplus \mathcal{H}_{5,1}$ .

Note that all fractions in  $\mathcal{F}_6$  are “operadic” in the sense that each contact sequence is identified with some component of  $\Delta_K^{(p)}(\lambda_q)$  or  $\Delta_K^{(p)}(\gamma^q)$ . When  $n > 6$ , however,  $\mathcal{F}_n$  contains “matradic” fractions whose contact sequences are identified with components of  $\Delta_P^{(p)}(\lambda_q)$  or  $\Delta_P^{(p)}(\gamma^q)$ , the iterated diagonal on the permutahedron  $P_{q-1}$ . In  $\mathcal{F}_7$ , for example, there is the fraction

$$\frac{\begin{array}{c} \wedge \quad \wedge \\ \hline \times \quad \times \end{array} \quad \begin{array}{c} | \\ \wedge \quad \wedge \\ \hline \wedge \quad \wedge \end{array}}{\begin{array}{c} \vee \quad \vee \quad \vee \quad \vee \end{array}} .$$

Nevertheless, the low dimensional examples discussed here demonstrate the general principle, and with this in mind we proceed with the general construction.

### 3. SUBMODULES OF $TTM$

Let  $M = \{M_{n,m}\}_{m,n \geq 1}$  be a bigraded module over a commutative ring  $R$  with identity  $1_R$ . Various submodules of  $TTM$  will be important in our work, the most basic of which is the  $q \times p$  matrix submodule  $(M^{\otimes p})^{\otimes q}$ . The name “matrix submodule” is motivated by the fact that each pair of  $q \times p$  matrices  $X = (x_{ij})$ ,  $Y = (y_{ij}) \in \mathbb{N}^{q \times p}$  with  $p, q \geq 1$  uniquely determines the submodule

$$M_{Y,X} = (M_{y_{1,1},x_{1,1}} \otimes \cdots \otimes M_{y_{1,p},x_{1,p}}) \otimes \cdots \otimes (M_{y_{q,1},x_{q,1}} \otimes \cdots \otimes M_{y_{q,p},x_{q,p}}) \subset TTM.$$

Fix a set of bihomogeneous module generators  $G \subset M$ . A *monomial in  $TM$*  is an element of  $G^{\otimes p}$  and a *monomial in  $TTM$*  is an element of  $(G^{\otimes p})^{\otimes q}$ . Thus  $A \in (G^{\otimes p})^{\otimes q}$  is naturally represented by the  $q \times p$  matrix

$$[A] = \begin{bmatrix} g_{x_{1,1}}^{y_{1,1}} & \cdots & g_{x_{1,p}}^{y_{1,p}} \\ \vdots & & \vdots \\ g_{x_{q,1}}^{y_{q,1}} & \cdots & g_{x_{q,p}}^{y_{q,p}} \end{bmatrix}$$

with entries in  $G$  and rows identified with elements of  $G^{\otimes p}$ . Thus  $A$  is the  $q$ -fold tensor product of the rows of  $[A]$ , and we refer to  $A$  as a  $q \times p$  *monomial* (we use the symbols  $A$  and  $[A]$  interchangeably) Consequently,

$$(M^{\otimes p})^{\otimes q} = \bigoplus_{X,Y \in \mathbb{N}^{q \times p}} M_{Y,X}$$

and we refer to

$$\overline{\mathbf{M}} = \bigoplus_{\substack{X,Y \in \mathbb{N}^{q \times p} \\ p,q \geq 1}} M_{Y,X} \quad \text{and} \quad \overline{\mathbf{V}} = \bigoplus_{\substack{X,Y \in \mathbb{N}^{1 \times p} \cup \mathbb{N}^{q \times 1} \\ p,q \geq 1}} M_{Y,X}$$

as the *matrix submodule* and the *vector submodule*, respectively. The matrix transpose  $A \mapsto A^T$  induces the permutation of tensor factors  $\sigma_{p,q} : (M^{\otimes p})^{\otimes q} \xrightarrow{\cong} (M^{\otimes q})^{\otimes p}$  given by

$$(3.1) \quad \left( \alpha_{x_{1,1}}^{y_{1,1}} \otimes \cdots \otimes \alpha_{x_{1,p}}^{y_{1,p}} \right) \otimes \cdots \otimes \left( \alpha_{x_{q,1}}^{y_{q,1}} \otimes \cdots \otimes \alpha_{x_{q,p}}^{y_{q,p}} \right) \mapsto$$



$$\left( \alpha_{x_{1,1}}^{y_{1,1}} \otimes \cdots \otimes \alpha_{x_{q,1}}^{y_{q,1}} \right) \otimes \cdots \otimes \left( \alpha_{x_{1,p}}^{y_{1,p}} \otimes \cdots \otimes \alpha_{x_{q,p}}^{y_{q,p}} \right).$$

Throughout this paper,  $\mathbf{x}$  and  $\mathbf{y}$  denote matrices in  $\mathbb{N}^{q \times p}$  with constant columns and constant rows, respectively;  $\mathbf{x}$  and  $\mathbf{y}$  will often be row and column matrices. Define

$$\overline{\mathbf{M}}_{\text{row}} = \bigoplus_{\mathbf{x}, Y \in \mathbb{N}^{q \times p}; p, q \geq 1} M_{Y, \mathbf{x}} \quad \text{and} \quad \overline{\mathbf{M}}^{\text{col}} = \bigoplus_{X, \mathbf{y} \in \mathbb{N}^{q \times p}; p, q \geq 1} M_{\mathbf{y}, X}.$$

Consider  $q \times p$  monomials

$$A = \begin{bmatrix} \alpha_{x_1}^{y_{1,1}} & \cdots & \alpha_{x_p}^{y_{1,p}} \\ \vdots & & \vdots \\ \alpha_{x_1}^{y_{q,1}} & \cdots & \alpha_{x_p}^{y_{q,p}} \end{bmatrix} \in M_{Y, \mathbf{x}} \quad \text{and} \quad B = \begin{bmatrix} \beta_{x_{1,1}}^{y_1} & \cdots & \beta_{x_{1,p}}^{y_1} \\ \vdots & & \vdots \\ \beta_{x_{q,1}}^{y_q} & \cdots & \beta_{x_{q,p}}^{y_q} \end{bmatrix} \in M_{\mathbf{y}, X}.$$

The *row (or coderivation) leaf sequence* of  $A$  is the  $p$ -tuple of lower (input) indices  $\text{rls}(A) = (x_1, \dots, x_p)$  along each row of  $A$ . Dually, the *column (or derivation) leaf sequence* of  $B$  is the  $q$ -tuple of upper (output) indices  $\text{cls}(B) = (y_1, \dots, y_q)^T$  along each column of  $B$ . Pictorially, each graph in the  $j^{\text{th}}$  column of  $A$  has  $x_j$  inputs and each graph in the  $i^{\text{th}}$  row of  $B$  has  $y_i$  outputs (see Figure 4).

The *bisequence submodule* of  $T\mathbf{M}$  is the intersection

$$\mathbf{M} = \overline{\mathbf{M}}_{\text{row}} \cap \overline{\mathbf{M}}^{\text{col}} = \bigoplus_{\mathbf{x}, \mathbf{y} \in \mathbb{N}^{q \times p}; p, q \geq 1} M_{\mathbf{y}, \mathbf{x}}.$$

A  $q \times p$  monomial  $A \in \mathbf{M}$  is represented as a *bisequence matrix*

$$(3.2) \quad A = \begin{bmatrix} \alpha_{x_1}^{y_1} & \cdots & \alpha_{x_p}^{y_1} \\ \vdots & & \vdots \\ \alpha_{x_1}^{y_q} & \cdots & \alpha_{x_p}^{y_q} \end{bmatrix};$$

in this case  $\text{rls}(A) = (x_1, \dots, x_p)$  and  $\text{cls}(A) = (y_1, \dots, y_q)^T$ . Let

$$\mathbf{M}_{\mathbf{x}}^{\mathbf{y}} = \langle A \in \mathbf{M} \mid \mathbf{x} = \text{rls}(A) \text{ and } \mathbf{y} = \text{cls}(A) \rangle;$$

then

$$\mathbf{M} = \bigoplus_{\substack{\mathbf{x} \times \mathbf{y} \in \mathbb{N}^{1 \times p} \times \mathbb{N}^{q \times 1} \\ p, q \geq 1}} \mathbf{M}_{\mathbf{x}}^{\mathbf{y}}.$$

Given a finite sequence of positive integers  $\mathbf{u} = (u_1, \dots, u_k)$ , let  $|\mathbf{u}| = \sum u_i$ . By identifying  $(H^{\otimes q})^{\otimes p} \approx (H^{\otimes p})^{\otimes q}$  with  $(q, p) \in \mathbb{N}^2$ , we can think of a  $q \times p$  monomial  $A \in \mathbf{M}_{\mathbf{x}}^{\mathbf{y}}$  as an operator on the positive integer lattice  $\mathbb{N}^2$ , pictured as an arrow  $(|\mathbf{x}|, q) \mapsto (p, |\mathbf{y}|)$  (see Figure 4 and Example 8). While this representation is helpful conceptually, it is unfortunately not faithful.

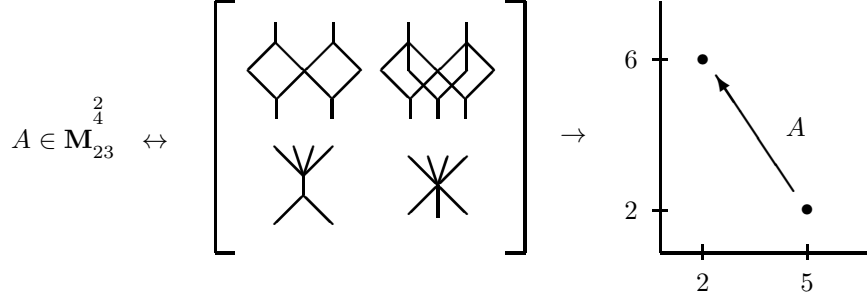
Figure 4. A  $2 \times 2$  monomial in  $\mathbf{M}$  and its arrow representation.

Unless explicitly indicated otherwise, we henceforth assume that  $\mathbf{x} \times \mathbf{y} = (x_1, \dots, x_p) \times (y_1, \dots, y_q)^T \in \mathbb{N}^{1 \times p} \times \mathbb{N}^{q \times 1}$  with  $p, q \geq 1$ . When the context is clear, we will often write  $\mathbf{y}$  as a row vector. The *bisquence vector submodule* is the intersection

$$\mathbf{V} = \overline{\mathbf{V}} \cap \mathbf{M} = \bigoplus_{s, t \in \mathbb{N}} \mathbf{M}_s^{\mathbf{y}} \oplus \mathbf{M}_{\mathbf{x}}^t.$$

**Example 3.** Let  $M = M_{1,1} \oplus M_{2,2} = \langle \theta_1^1 \rangle \oplus \langle \theta_2^2 \rangle$ . Then the bisquence vector submodule of TTM is

$$\begin{aligned} \mathbf{V} &= \mathbf{M}_1^1 \oplus \mathbf{M}_{11}^1 \oplus \mathbf{M}_{111}^1 \oplus \dots \oplus \mathbf{M}_1^{11} \oplus \mathbf{M}_1^{111} \oplus \dots \oplus \\ &\quad \mathbf{M}_2^2 \oplus \mathbf{M}_{22}^2 \oplus \mathbf{M}_{222}^2 \oplus \dots \oplus \mathbf{M}_2^{22} \oplus \mathbf{M}_2^{222} \oplus \dots \\ &\approx T^+(M_{1,1}) \oplus T^+(M_{1,1}) \oplus T^+(M_{2,2}) \oplus T^+(M_{2,2}). \end{aligned}$$

A submodule

$$\mathbf{W} = M \oplus \bigoplus_{\mathbf{x}, \mathbf{y} \notin \mathbb{N}; s, t \in \mathbb{N}} \mathbf{W}_s^{\mathbf{y}} \oplus \mathbf{W}_{\mathbf{x}}^t \subseteq \mathbf{V}$$

is *telescoping* if for all  $\mathbf{x}, \mathbf{y}, s, t$

- (i)  $\mathbf{W}_s^{\mathbf{y}} \subseteq \mathbf{M}_s^{\mathbf{y}}$  and  $\mathbf{W}_{\mathbf{x}}^t \subseteq \mathbf{M}_{\mathbf{x}}^t$ ;
- (ii)  $\alpha_s^{y_1} \otimes \dots \otimes \alpha_s^{y_q} \in \mathbf{W}_s^{\mathbf{y}}$  implies  $\alpha_s^{y_1} \otimes \dots \otimes \alpha_s^{y_j} \in \mathbf{W}_s^{y_1 \dots y_j}$  for all  $j < q$ ;
- (iii)  $\beta_{x_1}^t \otimes \dots \otimes \beta_{x_p}^t \in \mathbf{W}_{\mathbf{x}}^t$  implies  $\beta_{x_1}^t \otimes \dots \otimes \beta_{x_i}^t \in \mathbf{W}_{x_1 \dots x_i}^t$  for all  $i < p$ .

Thus the truncation maps  $\tau : \mathbf{W}_s^{y_1 \dots y_j} \rightarrow \mathbf{W}_s^{y_1 \dots y_{j-1}}$  and  $\tau : \mathbf{W}_{x_1 \dots x_i}^t \rightarrow \mathbf{W}_{x_1 \dots x_{i-1}}^t$  determine the following “telescoping” sequences of submodules:

$$\begin{aligned} \tau(\mathbf{W}_s^{\mathbf{y}}) &\subseteq \tau^2(\mathbf{W}_s^{\mathbf{y}}) \subseteq \dots \subseteq \tau^{q-1}(\mathbf{W}_s^{\mathbf{y}}) = \mathbf{W}_s^{y_1} \\ \tau(\mathbf{W}_{\mathbf{x}}^t) &\subseteq \tau^2(\mathbf{W}_{\mathbf{x}}^t) \subseteq \dots \subseteq \tau^{p-1}(\mathbf{W}_{\mathbf{x}}^t) = \mathbf{W}_{x_1}^t. \end{aligned}$$

In general,  $\mathbf{W}_{\mathbf{x}}^t$  is an *additive* submodule of  $\mathbf{M}_{x_1}^t \otimes \dots \otimes \mathbf{M}_{x_p}^t$  and does *not* necessarily decompose as  $B_1 \otimes \dots \otimes B_p$  with  $B_i \subseteq \mathbf{M}_{x_i}^t$ .

The *telescopic extension* of a telescoping submodule  $\mathbf{W} \subseteq \mathbf{V}$  is the submodule of matrices  $\mathcal{W} \subseteq \overline{\mathbf{M}}$  with the following properties: If  $A = [\alpha_{x_i, j}^{y_i, j}]$  is a  $q \times p$  monomial in  $\mathcal{W}$  and

- (i)  $[\alpha_{x_i, j}^{y_i, j} \dots \alpha_{x_i, j+m}^{y_i, j+m}]$  is a string in the  $i^{\text{th}}$  row of  $A$  such that  $y_{i, j} = \dots = y_{i, j+m} = t$ , then  $\alpha_{x_i, j}^t \otimes \dots \otimes \alpha_{x_i, j+m}^t \in \mathbf{W}_{x_i, j, \dots, x_i, j+m}^t$ .
- (ii)  $[\alpha_{x_i, j}^{y_i, j} \dots \alpha_{x_{i+r}, j}^{y_{i+r}, j}]^T$  is a string in the  $j^{\text{th}}$  column of  $A$  such that  $x_{i, j} = \dots = x_{i+r, j} = s$ , then  $\alpha_s^{y_{i, j}} \otimes \dots \otimes \alpha_s^{y_{i+r, j}} \in \mathbf{W}_s^{y_{i, j}, \dots, y_{i+r, j}}$ .

Thus if  $A \in \mathbf{M}_{\mathbf{x}}^{\mathbf{y}} \cap \mathcal{W}$ , the  $i^{\text{th}}$  row of  $A$  lies in  $\mathbf{W}_{\mathbf{x}}^{y_i}$  and  $j^{\text{th}}$  column of  $A$  lies in  $\mathbf{W}_{x_j}^{\mathbf{y}}$ .

## 4. PREMATRADS

4.1.  **$\Upsilon$ -products on  $\overline{\mathbf{M}}$ .** Given a family of maps  $\bar{\gamma} = \{M^{\otimes q} \otimes M^{\otimes p} \rightarrow M\}_{p,q \geq 1}$ , there is a canonical extension of the component  $\gamma = \{\gamma_{\mathbf{x}}^{\mathbf{y}} : \mathbf{M}_{\mathbf{p}}^{\mathbf{y}} \otimes \mathbf{M}_{\mathbf{x}}^{\mathbf{q}} \rightarrow \mathbf{M}_{|\mathbf{x}|}^{|\mathbf{y}|}\}$  to a global product  $\Upsilon : \overline{\mathbf{M}} \otimes \overline{\mathbf{M}} \rightarrow \overline{\mathbf{M}}$ . Pairs of bisequence matrices in  $\mathbf{M}_{\mathbf{p}}^{\mathbf{y}} \otimes \mathbf{M}_{\mathbf{x}}^{\mathbf{q}}$  are called ‘‘transverse pairs.’’

**Definition 1.** A pair  $A \otimes B = [\alpha_{v_{kl}}^{y_{kl}}] \otimes [\beta_{x_{ij}}^{u_{ij}}]$  of  $(q \times s, t \times p)$  monomials in  $\overline{\mathbf{M}} \otimes \overline{\mathbf{M}}$  is a

- (i) **Transverse Pair (TP)** if  $s = t = 1$ ,  $u_{1,j} = q$ , and  $v_{k,1} = p$  for all  $j$  and  $k$ , i.e., setting  $x_j = x_{1,j}$  and  $y_k = y_{k,1}$  gives

$$A \otimes B = \begin{bmatrix} \alpha_p^{y_1} \\ \vdots \\ \alpha_p^{y_q} \end{bmatrix} \otimes [\beta_{x_1}^q \quad \cdots \quad \beta_{x_p}^q] \in \mathbf{M}_{\mathbf{p}}^{\mathbf{y}} \otimes \mathbf{M}_{\mathbf{x}}^{\mathbf{q}}.$$

- (ii) **Block Transverse Pair (BTP)** if there exist  $t \times s$  block decompositions

$$A = [A'_{k',l}] \text{ and } B = [B'_{i,j'}] \text{ such that } A'_{il} \otimes B'_{il} \text{ is a TP for all } i \text{ and } l.$$

The block sizes in a BTP decomposition are uniquely determined. Unlike the blocks in a standard block matrix, the blocks  $A'_{il}$  (or  $B'_{il}$ ) of a BTP  $A \otimes B \in \overline{\mathbf{M}} \otimes \overline{\mathbf{M}}$  may vary in length within a given row (or column). However, if  $A \otimes B \in \mathbf{M}_{\mathbf{p}_1 \dots \mathbf{p}_s}^{\mathbf{y}_1 \dots \mathbf{y}_t} \otimes \mathbf{M}_{\mathbf{x}_1 \dots \mathbf{x}_s}^{\mathbf{q}_1 \dots \mathbf{q}_t}$  is a BTP, each TP  $A'_{il} \otimes B'_{il} \in \mathbf{M}_{\mathbf{p}_i}^{\mathbf{y}_i} \otimes \mathbf{M}_{\mathbf{x}_i}^{\mathbf{q}_i}$  so that for fixed  $i$  (or  $l$ ) the blocks  $A'_{il}$  (or  $B'_{il}$ ) have constant length  $q_i$  (or  $p_i$ ). Furthermore,  $A \otimes B \in \mathbf{M}_{\mathbf{p}}^{\mathbf{y}} \otimes \mathbf{M}_{\mathbf{x}}^{\mathbf{q}}$  is a BTP if and only if  $\mathbf{x} \times \mathbf{y} \in \mathbb{N}^{1 \times |\mathbf{v}|} \times \mathbb{N}^{|\mathbf{u}| \times 1}$  if and only if the initial point of arrow  $A$  coincides with the terminal point of arrow  $B$  in  $\mathbb{N}^2$ .

**Example 4.** A  $(4 \times 2, 2 \times 3)$  monomial pair  $A \otimes B \in \mathbf{M}_{21}^{1543} \otimes \mathbf{M}_{123}^{31}$  is a  $2 \times 2$  BTP per the block decompositions

$$A = \begin{bmatrix} \alpha_2^1 & \alpha_1^1 \\ \alpha_2^5 & \alpha_1^5 \\ \alpha_2^4 & \alpha_1^4 \\ \alpha_2^3 & \alpha_1^3 \end{bmatrix} \quad B = \begin{bmatrix} \beta_1^3 & \beta_2^3 & \beta_3^3 \\ \beta_1^1 & \beta_2^1 & \beta_3^1 \end{bmatrix}.$$

Given a family of maps  $\bar{\gamma} = \{M^{\otimes q} \otimes M^{\otimes p} \rightarrow M\}_{p,q \geq 1}$ , extend the component  $\gamma = \{\gamma_{\mathbf{x}}^{\mathbf{y}} : \mathbf{M}_{\mathbf{p}}^{\mathbf{y}} \otimes \mathbf{M}_{\mathbf{x}}^{\mathbf{q}} \rightarrow \mathbf{M}_{|\mathbf{x}|}^{|\mathbf{y}|}\}$  to a global product  $\Upsilon : \overline{\mathbf{M}} \otimes \overline{\mathbf{M}} \rightarrow \overline{\mathbf{M}}$  by defining

$$(4.1) \quad \Upsilon(A \otimes B) = \begin{cases} [\gamma(A'_{ij} \otimes B'_{ij})], & A \otimes B \text{ is a BTP} \\ 0, & \text{otherwise,} \end{cases}$$

where  $A'_{ij} \otimes B'_{ij}$  is the  $(i, j)^{\text{th}}$  TP in the BTP decomposition of  $A \otimes B$ .

We denote the  $\Upsilon$ -product by ‘‘ $\cdot$ ’’ or juxtaposition. When  $A \otimes B = [\alpha_p^{y_j}]^T \otimes [\beta_{x_i}^q]$  is a TP, we write

$$AB = \gamma(\alpha_p^{y_1}, \dots, \alpha_p^{y_q}; \beta_{x_1}^q, \dots, \beta_{x_p}^q).$$

As an arrow,  $AB$  “transgresses” from the  $x$ -axis to the  $y$ -axis  $\mathbb{N}^2$ . When  $A^{q \times s} \otimes B^{t \times p} \in \mathbf{M}_{\mathbf{y}}^y \otimes \mathbf{M}_{\mathbf{x}}^x$  is a BTP and  $A'_{ij} \otimes B'_{ij} \in \mathbf{M}_{p_j}^{y_i} \otimes \mathbf{M}_{x_j}^{q_i}$  is its BTP decomposition,  $AB$  is a  $t \times s$  matrix in  $\mathbf{M}_{|\mathbf{x}_1| \cdots |\mathbf{x}_s|}^{|\mathbf{y}_1| \cdots |\mathbf{y}_t|}$ . As an arrow,  $AB$  runs from the initial point of  $B$  to the terminal point of  $A$ .

Note that  $\Upsilon$ -products always restrict to the submodules  $\overline{\mathbf{M}}_{\text{row}}$  and  $\overline{\mathbf{M}}^{\text{col}}$ , and consequently to  $\mathbf{M}$ . To see this, consider a BTP  $A \otimes B \in \overline{\mathbf{M}}^{\text{col}} \otimes \overline{\mathbf{M}}^{\text{col}}$  with block decomposition  $[A'_{ij}] \otimes [B'_{ij}]$ . Since each entry along the  $i^{\text{th}}$  row of  $B$  has  $q$  outputs, each block  $A'_{ij}$  is a column of length  $q$ . Since all entries along a row of  $A$  have the same number of outputs, the total number of outputs from each block  $A'_{ij}$  is the same for all  $j$ . Thus  $AB \in \overline{\mathbf{M}}^{\text{col}}$  and  $\Upsilon$  is closed in  $\overline{\mathbf{M}}^{\text{col}}$ . Dually,  $\Upsilon$  is closed in  $\overline{\mathbf{M}}_{\text{row}}$ , and consequently,  $\Upsilon$  is closed in  $\mathbf{M}$ .

**Example 5.** Continuing Example 4, the action of  $\Upsilon$  on the  $(4 \times 2, 2 \times 3)$  monomial pair  $A \otimes B \in \mathbf{M}_{21}^{1543} \otimes \mathbf{M}_{123}^{31}$  produces a  $2 \times 2$  monomial in  $\mathbf{M}_{33}^{10,3}$ :

$$\left[ \begin{array}{|c|c|} \hline \alpha_2^1 & \alpha_1^1 \\ \hline \alpha_2^5 & \alpha_1^5 \\ \hline \alpha_2^4 & \alpha_1^4 \\ \hline \alpha_2^3 & \alpha_1^3 \\ \hline \end{array} \right] \left[ \begin{array}{|c|c|c|} \hline \beta_1^3 & \beta_2^3 & \beta_3^3 \\ \hline \beta_1^1 & \beta_2^1 & \beta_3^1 \\ \hline \end{array} \right] = \left[ \begin{array}{|c|c|c|} \hline \alpha_2^1 & \alpha_1^1 & \\ \hline \alpha_2^5 & \beta_1^3 & \beta_2^3 & \alpha_1^5 & \beta_3^3 \\ \hline \alpha_2^4 & & & \alpha_1^4 & \\ \hline \alpha_2^3 & \beta_1^1 & \beta_2^1 & \alpha_1^3 & \beta_3^1 \\ \hline \end{array} \right]$$

In the target,  $(|\mathbf{x}_1|, |\mathbf{x}_2|) = (1 + 2, 3)$  since  $(p_1, p_2) = (2, 1)$ ; and  $(|\mathbf{y}_1|, |\mathbf{y}_2|) = (1 + 5 + 4, 3)$  since  $(q_1, q_2) = (3, 1)$ . As an arrow in  $\mathbb{N}^2$ ,  $AB$  initializes at  $(6, 2)$  and terminates at  $(2, 13)$ .

**4.2. Prematrads Defined.** Let  $1^{1 \times p} = (1, \dots, 1) \in \mathbb{N}^{1 \times p}$  and  $1^{q \times 1} = (1, \dots, 1)^T \in \mathbb{N}^{q \times 1}$ ; we often suppress the exponents when the context is clear.

**Definition 2.** A *prematrad*  $(M, \gamma, \eta)$  is a bigraded  $R$ -module  $M = \{M_{n,m}\}_{m,n \geq 1}$  together with a family of structure maps  $\gamma = \{\gamma_{\mathbf{x}}^{\mathbf{y}} : \mathbf{M}_{\mathbf{p}}^{\mathbf{y}} \otimes \mathbf{M}_{\mathbf{x}}^q \rightarrow \mathbf{M}_{|\mathbf{x}|}^{|\mathbf{y}|}\}$  and a unit  $\eta : R \rightarrow \mathbf{M}_1^1$  such that

- (i)  $\Upsilon(\Upsilon(A; B); C) = \Upsilon(A; \Upsilon(B; C))$  whenever  $A \otimes B$  and  $B \otimes C$  are BTPs in  $\overline{\mathbf{M}} \otimes \overline{\mathbf{M}}$ ;
- (ii) the following compositions are the canonical isomorphisms:

$$\begin{aligned} R^{\otimes b} \otimes \mathbf{M}_a^b &\xrightarrow{\eta^{\otimes b} \otimes 1} \mathbf{M}_1^{1^{b \times 1}} \otimes \mathbf{M}_a^b \xrightarrow{\gamma_a^{1^{b \times 1}}} \mathbf{M}_a^b; \\ \mathbf{M}_a^b \otimes R^{\otimes a} &\xrightarrow{1 \otimes \eta^{\otimes a}} \mathbf{M}_a^b \otimes \mathbf{M}_{1^{1 \times a}}^1 \xrightarrow{\gamma_{1^{1 \times a}}^b} \mathbf{M}_a^b. \end{aligned}$$

We denote the element  $\eta(1_R)$  by  $\mathbf{1}_{\mathbf{M}}$ .

A *morphism of prematrads*  $(M, \gamma)$  and  $(M', \gamma')$  is a map  $f : M \rightarrow M'$  such that  $f\gamma_{\mathbf{x}}^{\mathbf{y}} = \gamma'_{\mathbf{x}}^{\mathbf{y}}(f^{\otimes q} \otimes f^{\otimes p})$  for all  $\mathbf{x} \times \mathbf{y}$ .

Although  $\Upsilon$  fails to act associatively on  $\overline{\mathbf{M}}$ , Axiom (i) implies that  $(AB)C = A(BC)$  whenever  $A, B, C \in \overline{\mathbf{M}}$ ,  $AB \neq 0$ , and  $BC \neq 0$ . On the other hand,  $\Upsilon$  acts

associatively on  $\mathbf{M}$ , which is the content of Proposition 1 below. Given a bisequence matrix  $A^{q \times p} \in \mathbf{M}_{\mathbf{x}}$ , let  $\mathbf{1}^{q \times |\mathbf{x}|}$  and  $\mathbf{1}^{|\mathbf{y}| \times p}$  denote the (bisequence) matrices whose entries are constantly  $\mathbf{1}_{\mathbf{M}}$ . Then Axiom (ii) implies  $\Upsilon(\mathbf{1}^{|\mathbf{y}| \times p}; A) = A = \Upsilon(A; \mathbf{1}^{q \times |\mathbf{x}|})$ .

In the discussion that follows, we think of a string of matrices as a composition of operators and index the matrices in the order applied (from right-to-left).

**Definition 3.** Let  $(M, \gamma, \eta)$  be a prematrad, and let  $m, n \geq 1$ . A string of matrices  $A_s \cdots A_1$  is a **basic string of bidegree**  $(m, n)$  if

- (i)  $A_1 \in \mathbf{M}_{\mathbf{x}}^b$ ,  $|\mathbf{x}| = m$ ,
- (ii)  $A_i \in \overline{\mathbf{M}} \setminus \{\mathbf{1}^{q \times p} \mid p, q \in \mathbb{N}\}$  for all  $i$ ,
- (iii)  $A_s \in \mathbf{M}_{\mathbf{a}}^y$ ,  $|\mathbf{y}| = n$ , and
- (iv) some association of  $A_s \cdots A_1$  defines a sequence of BTPs.

In particular, if  $A_s \cdots A_1$  is a basic string of bidegree  $(m, n)$  and each BTP in Axiom (iv) defines a non-zero  $\Upsilon$ -product, then  $A_s \cdots A_1$  defines a non-zero element of  $\mathbf{M}_m^n = M_{n,m}$ . Indeed, this is exactly the situation when a prematrad  $(M, \gamma, \eta)$  is “free” (see Definition 4 below).

**Lemma 1.** Let  $(M, \gamma, \eta)$  be a prematrad. Then  $\Upsilon$  acts associatively on a basic string  $A_s \cdots A_1$  if and only if  $A_i \in \mathbf{M}$  for all  $i$ .

*Proof.* Suppose  $\Upsilon$  acts associatively on a basic string  $A_s \cdots A_1$ . If  $s = 1, 2$  there is nothing to prove, so assume that  $s > 2$  and  $1 < i < s$ . Since  $\Upsilon$  acts associatively, every association of  $A_s \cdots A_1$  defines a sequence of BTPs. Hence

$$BA_iC = (A_s \cdots A_{i+1})A_i(A_{i-1} \cdots A_1)$$

is a basic string and  $B \otimes A_i$  and  $A_i \otimes C$  are BTPs. So write  $B = [b_p^{y_1} \cdots b_p^{y_q}]^T$  and  $C = [c_{x_1}^r \cdots c_{x_i}^r]$ ; then the  $i^{\text{th}}$  row of  $A_i$  has the form  $[a_{u_1}^{w_i} \cdots a_{u_p}^{w_i}]$  and the  $j^{\text{th}}$  column of  $A_i$  has the form  $[a_{z_j}^{v_1} \cdots a_{z_j}^{v_r}]^T$ . Thus  $A_i \in \overline{\mathbf{M}}_{\text{row}} \cap \overline{\mathbf{M}}^{\text{col}} = \mathbf{M}$ .

Conversely, we proceed by induction on string length  $s$ . Consider a basic string  $ABC$  with  $B \in \mathbf{M}$ , and suppose that  $A \otimes B$  and  $AB \otimes C$  are BTPs. Write

$$A \otimes B = \begin{bmatrix} a_p^{y_1} \\ \vdots \\ a_p^{y_r} \end{bmatrix} \otimes \begin{bmatrix} b_{u_1}^{v_1} & \cdots & b_{u_p}^{v_1} \\ \vdots & & \vdots \\ b_{u_1}^{v_q} & \cdots & b_{u_p}^{v_q} \end{bmatrix};$$

let  $B^i$  and  $B_j$  denote the  $i^{\text{th}}$  row and  $j^{\text{th}}$  column of  $B$ . Set  $v_0 = 0$  and express  $A$  as the block matrix  $[A^1 \cdots A^q]^T$  where  $A^i = [a_p^{y_{v_1+\cdots+v_{i-1}+1}} \cdots a_p^{y_{v_1+\cdots+v_i}}]^T$ . Then

$$AB = \begin{bmatrix} A^1 B^1 \\ \vdots \\ A^q B^q \end{bmatrix}, \quad \text{where } A^i B^i = \begin{bmatrix} a_p^{y_{v_1+\cdots+v_{i-1}+1}} \\ \vdots \\ a_p^{y_{v_1+\cdots+v_i}} \end{bmatrix} [b_{u_1}^{v_i} \cdots b_{u_p}^{v_i}].$$

Since  $AB \otimes C$  is a BTP,  $C$  has the form  $[c_{x_1}^q \cdots c_{x_s}^q]$ , where  $s = u_1 + \cdots + u_p$ . Set  $u_0 = 0$  and express  $C$  as the block matrix  $[C_1 \cdots C_p]$ , where

$$C_j = [c_{x_{u_1+\cdots+u_{j-1}+1}}^q \cdots c_{x_{u_1+\cdots+u_j}}^q].$$

Then

$$B_j \otimes C_j = \begin{bmatrix} b_{u_j}^{v_1} \\ \vdots \\ b_{u_j}^{v_q} \end{bmatrix} \otimes \begin{bmatrix} c_{x_{u_1+\dots+u_{j-1}+1}}^q & \dots & c_{x_{u_1+\dots+u_j}}^q \end{bmatrix}$$

is a TP and  $B \otimes C$  is a BTP. Therefore  $(AB)C = A(BC)$  by Definition 2, Axiom (i). Similarly, if  $B \otimes C$  and  $A \otimes BC$  are BTPs, then  $A \otimes B$  is a BTP.

Next consider a basic string  $ABCD$  with  $B, C \in \mathbf{M}$ . If  $B \otimes C$ ,  $A \otimes BC$ , and  $A(BC) \otimes D$  are BTPs,  $A(BC)$  is a column matrix whose entries are basic strings of the form  $A_i([B_{i1} \dots B_{ip}][C_{i1} \dots C_{ip}])$ . Hence  $A(BC) = (AB)C$  by the calculations above; and dually,  $(BC)D = B(CD)$ . Furthermore, the equalities  $(A(BC))D = ((AB)C)D$  and  $A((BC)D) = A(B(CD))$  imply  $((AB)C)D = (AB)(CD) = A(B(CD))$ .

Inductively, let  $k \geq 4$ , and assume that  $\Upsilon$  acts associatively on basic strings  $A_s \dots A_1$  of length  $s \leq k$  with  $A_i \in \mathbf{M}$  for all  $i$ , and consider a basic string  $A_{k+1} \dots A_1$  with  $A_j \in \mathbf{M}$  for all  $j$ . Since some association of  $A_{k+1} \dots A_1$  defines a sequence of BTPs, there is an innermost BTP  $A_{j+1} \otimes A_j$ . Let  $B = A_{j+1}A_j$ ; then  $B$  is a bisequence matrix since  $\Upsilon$  is closed in  $\mathbf{M}$ , and  $\Upsilon$  acts associatively on  $A_{k+1} \dots A_{j+2}BA_{j-1} \dots A_1$ . If  $1 < j < k$ , let  $C = A_{k+1} \dots A_{j+2}$  and  $D = A_{j-1} \dots A_1$ ; then  $\Upsilon$  acts associatively on  $CA_{j+1}A_jD$ , completing the proof.  $\square$

**Proposition 1.** *Let  $(M, \gamma, \eta)$  be a prematrad; then  $\Upsilon$  acts associatively on  $\mathbf{M}$ .*

*Proof.* If  $A, B, C \in \mathbf{M}$  such that  $A \otimes B$  and  $AB \otimes C$  are BTPs, the entries of  $(AB)C$  are basic strings on which  $\Upsilon$  acts associatively by Lemma 1. Hence  $B \otimes C$  is a BTP and  $(AB)C = A(BC)$ . If  $A \otimes B$  is a BTP and  $B \otimes C$  is not, neither is  $AB \otimes C$ . Dually, if  $B \otimes C$  is a BTP and  $A \otimes B$  is not, neither is  $A \otimes BC$ . In either case,  $(AB)C = A(BC) = 0$ .  $\square$

Some examples of prematrads now follow.

**Remark 1.** *If  $(M, \gamma, \eta)$  is a prematrad, the restrictions  $(M_{1,*}, \gamma_*^1, \eta)$  and  $(M_{*,1}, \gamma_1^*, \eta)$  are non- $\Sigma$  operads in the sense of May (see [9]).*

**Example 6.** *A non- $\Sigma$  operad  $(K, \gamma_*)$  with  $\gamma_{\mathbf{x}} : K(p) \otimes K(x_1) \otimes \dots \otimes K(x_p) \rightarrow K(|\mathbf{x}|)$  is a prematrad via*

$$M_{n,m} = \begin{cases} K(m), & \text{if } n = 1 \\ 0, & \text{otherwise} \end{cases} \quad \text{and} \quad \gamma_{\mathbf{x}}^{\mathbf{y}} = \begin{cases} \gamma_{\mathbf{x}}, & \text{if } \mathbf{y} = 1 \\ 0, & \text{otherwise} \end{cases}$$

(c.f. Remark 1). For a discussion of the differential in the special case  $K = \mathcal{A}_\infty$ , see Example 18.

**Example 7.** *Let  $(K = \bigoplus_{n \geq 1} K(n), \gamma_*)$  and  $(L = \bigoplus_{m \geq 1} L(m), \gamma^*)$  be non- $\Sigma$  operads with  $K(1) = L(1)$  and the same unit  $\eta$ . Set*

$$M_{n,m} = \begin{cases} K(n), & \text{if } m = 1 \\ L(m), & \text{if } n = 1 \\ 0, & \text{otherwise} \end{cases} \quad \text{and} \quad \gamma_{\mathbf{x}}^{\mathbf{y}} = \begin{cases} \gamma_{\mathbf{x}}, & \text{if } \mathbf{y} = 1 \\ \gamma^{\mathbf{y}}, & \text{if } \mathbf{x} = 1 \\ 0, & \text{otherwise,} \end{cases}$$

then  $(M, \gamma)$  is a prematrad.

**Example 8.** *The Prematrad PROP  $M$ . The free PROP  $M$ , with its horizontal and vertical products  $\times : M_{n,m} \otimes M_{n',m'} \rightarrow M_{n+n',m+m'}$  and  $\circ : M_{r,q} \otimes M_{q,p} \rightarrow M_{r,p}$  (c.f. [1], [9]), is endowed with a canonical prematrad structure  $(M^{\text{pre}}, \gamma, \eta)$ , with*

$\eta$  determined by  $\eta(1_R) = \{\text{unit of the PROP } M\}$ . To define the structure map  $\gamma$ , define  $\times^0 = \mathbf{1}$  and iterate  $\times$  to obtain

$$\times^{q-1} \otimes \times^{p-1} : \mathbf{M}_p^{\mathbf{y}} \otimes \mathbf{M}_{\mathbf{x}}^q \longrightarrow \mathbf{M}_{pq}^{|\mathbf{y}|} \otimes \mathbf{M}_{|\mathbf{x}|}^{qp}.$$

View  $\alpha_{|\mathbf{x}|}^{qp} \in \mathbf{M}_{|\mathbf{x}|}^{qp}$  as a graph with  $p$  groups of  $q$  outputs  $(y_{1,1} \cdots y_{1,q}) \cdots (y_{p,1} \cdots y_{p,q})$  labeled from left-to-right. The leaf permutation

$$\sigma_{q,p} : (y_{1,1} \cdots y_{1,q}) \cdots (y_{p,1} \cdots y_{p,q}) \mapsto (y_{1,1} \cdots y_{p,1}) \cdots (y_{1,q} \cdots y_{p,q})$$

induces a map  $\sigma_{q,p}^* : \mathbf{M}_{|\mathbf{x}|}^{qp} \rightarrow \mathbf{M}_{|\mathbf{x}|}^{pq}$ . Then  $\gamma$  is the sum of the compositions

$$(4.2) \quad \gamma_{\mathbf{x}}^{\mathbf{y}} : \mathbf{M}_p^{\mathbf{y}} \otimes \mathbf{M}_{\mathbf{x}}^q \xrightarrow{\times^{q-1} \otimes \times^{p-1}} \mathbf{M}_{pq}^{|\mathbf{y}|} \otimes \mathbf{M}_{|\mathbf{x}|}^{qp} \xrightarrow{\mathbf{1} \otimes \sigma_{q,p}^*} \mathbf{M}_{pq}^{|\mathbf{y}|} \otimes \mathbf{M}_{|\mathbf{x}|}^{pq} \xrightarrow{\circ} \mathbf{M}_{|\mathbf{x}|}^{|\mathbf{y}|}.$$

The induced associative product  $\Upsilon$  on  $\mathbf{M}$  takes values in matrices of (typically) non-planar graphs as in Figure 4. In particular, let  $H$  be a free DG  $R$ -module of finite type and view the universal PROP  $U_H = \text{End}(TH)$  as the bigraded  $R$ -module  $M = \{\text{Hom}(H^{\otimes m}, H^{\otimes n})\}_{n,m \geq 1}$ . Then a  $q \times p$  monomial  $A \in \mathbf{M}_{\mathbf{x}}^{\mathbf{y}}$  admits a representation as an operator on  $\mathbb{N}^2$  via the identification  $(H^{\otimes p})^{\otimes q} \leftrightarrow (p, q)$  with the action of  $A$  given by the composition

$$\begin{aligned} \left( H^{\otimes |\mathbf{x}|} \right)^{\otimes q} &\approx (H^{\otimes x_1} \otimes \cdots \otimes H^{\otimes x_p})^{\otimes q} \rightarrow (H^{\otimes y_1})^{\otimes p} \otimes \cdots \otimes (H^{\otimes y_q})^{\otimes p} \\ &\xrightarrow{\sigma_{y_1,p} \otimes \cdots \otimes \sigma_{y_q,p}} (H^{\otimes p})^{\otimes y_1} \otimes \cdots \otimes (H^{\otimes p})^{\otimes y_q} \approx (H^{\otimes p})^{\otimes |\mathbf{y}|}. \end{aligned}$$

This motivates the representation of a general  $A$  as an arrow  $(|\mathbf{x}|, q) \mapsto (p, |\mathbf{y}|)$  in  $\mathbb{N}^2$  (see Figure 4). The map  $\times^{q-1} \otimes \times^{p-1}$  in 4.2 is the canonical isomorphism and  $\gamma$  agrees with the composition product on the universal preCROC [15].

**Example 9.** *The Universal Enveloping PROP  $U$ .* Recall that the structure map  $\gamma_{FP}$  in the free PROP  $FP(M)$  is the sum of all possible (iterated) ‘‘horizontal’’ and ‘‘vertical’’ products  $\times : M_{b,a} \otimes M_{b',a'} \rightarrow M_{b+b', a+a'}$  and  $\circ : M_{c,b} \otimes M_{b,a} \rightarrow M_{c,a}$ . Furthermore, the tensor product induces left  $S_n$ - and right  $S_m$ -actions

$$M_{b,b} \otimes M_{b,a} \xrightarrow{\sigma \otimes \mathbf{1}} M_{b,b} \otimes M_{b,a} \xrightarrow{\gamma_{FP}} M_{b,a} \quad \text{and}$$

$$M_{b,a} \otimes M_{a,a} \xrightarrow{\mathbf{1} \otimes \sigma} M_{b,a} \otimes M_{a,a} \xrightarrow{\gamma_{FP}} M_{b,a}.$$

Note that  $FP$  is functorial: Given bigraded modules  $M$  and  $N$ , a map  $f = \{f_{b,a} : M_{b,a} \rightarrow N_{b,a}\}$  extends to a map  $FP(f) : FP(M) \rightarrow FP(N)$  preserving horizontal and vertical products, i.e.,  $FP(f)(M_{b,a} \times M_{b',a'}) = f(M_{b,a}) \times f(M_{b',a'})$  and  $FP(f)(M_{c,b} \circ M_{b,a}) := f(M_{c,b}) \circ f(M_{b,a})$ . Now if  $(M, \gamma_M)$  is a prematrad,  $\gamma_M$  is a component of  $\gamma_{FP}$  on  $\mathbf{M}_p^{\mathbf{y}} \otimes \mathbf{M}_{\mathbf{x}}^q$ . Let  $J$  be the two-sided ideal generated by  $\bigoplus_{\mathbf{x} \times \mathbf{y}} (\gamma_{FP} - \gamma_M)(\mathbf{M}_p^{\mathbf{y}} \otimes \mathbf{M}_{\mathbf{x}}^q)$ . The **universal enveloping PROP of  $M$**  is the quotient

$$U(M) = FP(M) / J.$$

Note that the restriction of  $U$  to operads is the standard functor from operads to PROPs [1].

**4.3. Free Prematrads.** “Free prematrads” are fundamentally important. Our definition of a free prematrad (below) involves an inductive definition of the intermediate set  $G^{\text{pre}} = G_{*,*}^{\text{pre}}$  in which  $G_{n,m}^{\text{pre}}$  is defined in terms of the set

$$G_{[n,m]} = \bigcup_{\substack{i \leq m, j \leq n, \\ i+j < m+n}} G_{j,i}^{\text{pre}}.$$

We think of  $G_{[n,m]}$  as an  $n \times m$  array whose  $(j, i)^{\text{th}}$  cell contains  $G_{j,i}^{\text{pre}}$  when  $i + j < m + n$  and whose  $(n, m)^{\text{th}}$  cell is empty. For example, we picture  $G_{[3,4]}$  as:

	1	2	3	4
1				
2				
3				

Borrowing our notation for the matrix and bisequence submodules of  $TTM$ , we denote the set of matrices over  $G_{[n,m]}$  by  $\overline{\mathbf{G}}_{[n,m]}$ , the set of matrices over  $G^{\text{pre}}$  by  $\overline{\mathbf{G}}$ , and the subset of bisequence matrices in  $\overline{\mathbf{G}}$  by  $\mathbf{G}$ .

**Definition 4.** Let  $\Theta = \langle \theta_m^n \mid \theta_1^1 = \mathbf{1} \neq 0 \rangle_{m,n \geq 1}$  be a free bigraded  $R$ -module generated by singletons  $\theta_m^n$  and set  $G_{1,1}^{\text{pre}} = \mathbf{1}$ . Inductively, if  $m + n \geq 3$  and  $\overline{\mathbf{G}}_{[n,m]}$  has been constructed, define

$$G_{n,m}^{\text{pre}} = \theta_m^n \cup \{ \text{basic strings } A_s \cdots A_1 \text{ of bidegree } (m, n), A_i \in \overline{\mathbf{G}}_{[n,m]}, s \geq 2 \}.$$

Let  $\sim$  be the equivalence relation on  $G^{\text{pre}}$  generated by  $[A_{ij}B_{ij}] \sim [A_{ij}][B_{ij}]$  if and only if  $[A_{ij}] \times [B_{ij}] \in \overline{\mathbf{G}} \times \overline{\mathbf{G}}$  is a BTP, and let  $F^{\text{pre}}(\Theta) = \langle G^{\text{pre}} / \sim \rangle$ . The **free prematrad generated by  $\Theta$**  is the prematrad  $(F^{\text{pre}}(\Theta), \gamma, \eta)$ , where  $\gamma$  is juxtaposition and  $\eta : R \rightarrow F_{1,1}^{\text{pre}}(\Theta)$  is given by  $\eta(1_R) = \mathbf{1}$ .

**Example 10.** The  $A_\infty$  operad. Let  $\theta_m = \theta_m^1 \neq 0$  and  $\theta^n = \theta_1^n \neq 0$  for all  $m, n \geq 1$ . The non-sigma operads  $K = F^{\text{pre}}(\theta_*)$  and  $L = F^{\text{pre}}(\theta^*)$  are isomorphic to the  $A_\infty$  operad and encode the combinatorial structure of an  $A_\infty$ -algebra and an  $A_\infty$ -coalgebra, respectively. Let  $\theta_{m,i}^p$  denote the  $1 \times p$  matrix  $[\theta_1 \cdots \theta_m \cdots \theta_1]$  with  $\theta_m$  in the  $i^{\text{th}}$  position, and let  $\theta_q^{n,j}$  denote the  $q \times 1$  matrix  $[\theta^1 \cdots \theta^n \cdots \theta^1]^T$  with  $\theta^n$  in the  $j^{\text{th}}$  position. Then modulo prematrad axioms (i) and (ii), the bases for  $K$  and  $L$  given by Definition 4 are

$$\{ \theta_{p_k}^{\theta_{m_k, i_k}^{p_k}} \cdots \theta_{m_1, i_1}^{p_1} \in K(m_1 + p_1 - 1) \mid m_r = p_{r-1} - p_r + 1 \}$$

and

$$\{ \theta_{q_l}^{n_l, j_l} \cdots \theta_{q_1}^{n_1, j_1} \theta^{q_1} \in L(n_l + q_l - 1) \mid n_r = q_{r+1} - q_r + 1 \}.$$

Given  $A \in G_{n,m}^{\text{pre}} / \sim$ , choose a representative  $A_s \cdots A_1 \in G_{n,m}^{\text{pre}}$ . In view of Definition 3, Axiom (iv), some association of  $A_s \cdots A_1$  defines a sequence of BTPs; thus  $s - 1$  successive applications of  $\Upsilon$  produces a  $1 \times 1$  (bisequence) representative  $B$ .

**Definition 5.** Let  $A \in G_{n,m}^{\text{pre}} / \sim$ . A **factorization of  $A$**  is a representative  $A_s \cdots A_1 \in A$ . A factorization  $A_s \cdots A_1 \in A$  is a  $\Theta$ -**factorization** if the entries of  $A_i$  are elements of  $\Theta$  for all  $i$ . A factorization  $B_t \cdots B_1 \in A$  is a **bisequence**



**factorization** if  $B_i \in \mathbf{G}$  for all  $i$ . A bisequence factorization  $A_s \cdots A_1 \in A$  is **bisequence decomposable** if there is a bisequence factorization  $B_t \cdots B_1 \in A$  such that  $t > s$ .

Since bisequence factorizations are basic strings of matrices, bisequence factorizations are characterized by Lemma 1:  $A_s \cdots A_1 \in A$  is a bisequence factorization if and only if  $\Upsilon$  acts associatively on  $A_s \cdots A_1$ .

Given  $A \in G^{\text{pre}} / \sim$ , consider a factorization  $A_s \cdots A_1 \in A$ . Each association of  $A_s \cdots A_1$  determines a fraction, any two of which will look quite different. For example, the two associations of the bisequence  $\Theta$ -factorization

$$(4.3) \quad A_3 A_2 A_1 = \left[ \begin{array}{c} \theta_2^2 \\ \theta_2^2 \\ \theta_2^1 \end{array} \right] \left[ \begin{array}{cc} \theta_2^2 & \theta_1^2 \\ \theta_2^1 & \mathbf{1} \end{array} \right] \left[ \begin{array}{ccc} \theta_2^2 & \theta_2^2 & \theta_2^2 \end{array} \right] \in \mathbf{G}_6^6,$$

which are

$$(A_3 A_2) A_1 = \left[ \begin{array}{c} \left[ \begin{array}{c} \theta_2^2 \\ \theta_2^2 \end{array} \right] \left[ \begin{array}{cc} \theta_2^2 & \theta_1^2 \end{array} \right] \\ \left[ \begin{array}{c} \theta_2^2 \end{array} \right] \left[ \begin{array}{cc} \theta_2^1 & \mathbf{1} \end{array} \right] \end{array} \right] \left[ \begin{array}{ccc} \theta_2^2 & \theta_2^2 & \theta_2^2 \end{array} \right]$$

and

$$A_3 (A_2 A_1) = \left[ \begin{array}{c} \theta_2^2 \\ \theta_2^2 \\ \theta_2^2 \end{array} \right] \left[ \begin{array}{c} \left[ \begin{array}{cc} \theta_2^2 & \theta_2^2 \end{array} \right] \left[ \begin{array}{c} \theta_2^1 \\ \mathbf{1} \end{array} \right] \left[ \begin{array}{c} \theta_2^2 \end{array} \right] \end{array} \right],$$

respectively determine the fractions

$$\frac{\begin{array}{ccc} \times \times & \times & \\ \times \times & \times & \times \\ \times \times & \times & \times \end{array}}{\begin{array}{ccc} \times \times & \times & \\ \times \times & \times & \times \\ \times \times & \times & \times \end{array}} \quad \text{and} \quad \frac{\begin{array}{ccc} \times \times \times & & \\ \times \times \times & \times & \times \\ \times \times \times & \times & \times \end{array}}{\begin{array}{ccc} \times \times \times & \times & \times \\ \times \times \times & \times & \times \\ \times \times \times & \times & \times \end{array}}.$$

Define the *graph of  $A$*  to be the graph of the  $1 \times 1$  representative  $A' \in A$ . If a fraction  $f$  represents an association of  $A_s \cdots A_1 \in A$ , the graph of  $A$  can be obtained from  $f$  by removing fraction bars and making the prescribed connections.

The arrows representing the factors of  $A_s \cdots A_1 \in A$  form a polygonal path in  $\mathbb{N}^2$  from the  $x$ -axis to the  $y$ -axis, and evaluating subproducts in an association changes the path. For example, the 3-step path in Figure 5 represents the factorization  $A_3 A_2 A_1$  in (4.3) thought of as the composition

$$H^{\otimes 6} \xrightarrow{\text{XXX}} (H^{\otimes 2})^{\otimes 3} \xrightarrow{\sigma_{2,3}} (H^{\otimes 3})^{\otimes 2} \xrightarrow{\text{XY} \atop \lambda \mathbf{1}} (H^{\otimes 2})^{\otimes 3} \xrightarrow{\sigma_{2,2} \otimes \mathbf{1}} (H^{\otimes 2})^{\otimes 3} \xrightarrow{\begin{array}{c} \times \\ \times \\ \times \end{array}} H^{\otimes 6},$$

and the 2-step paths represent the associations  $(A_3 A_2) A_1$  and  $A_3 (A_2 A_1)$ , where the subproducts in parentheses have been evaluated and the remaining unevaluated products are thought of as the compositions

$$H^{\otimes 6} \xrightarrow{\text{XXX}} (H^{\otimes 2})^{\otimes 3} \xrightarrow{\sigma_{2,3}} (H^{\otimes 3})^{\otimes 2} \xrightarrow{\begin{array}{c} \times \times \\ \times \times \\ \times \\ \lambda \mathbf{1} \end{array}} H^{\otimes 6}$$

and

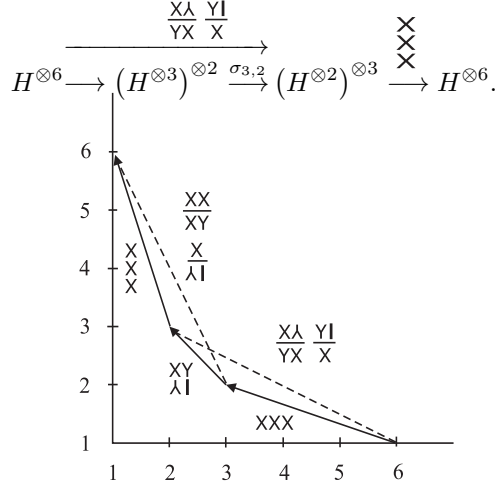

Figure 5: Polygonal paths of  $A_3A_3A_1$ .

In the special operadic situations of Example 10, every  $\Theta$ -factorization is a bisequence factorization, but this is not true, in general. For example, the  $\Theta$ -factorization

$$B_3B_2B_1 = \begin{bmatrix} \theta_2^1 \\ \theta_2^1 \end{bmatrix} \begin{bmatrix} \theta_2^1 & \mathbf{1} \\ \mathbf{1} & \theta_2^1 \end{bmatrix} [\theta_1^2 \quad \theta_1^2 \quad \theta_1^2] \in G_{2,3}^{\text{pre}}(\Theta)$$

is not a bisequence factorization since  $B_2$  is not a bisequence matrix. Furthermore,  $B_3B_2B_1$  only associates on the left since  $B_2 \otimes B_1$  is *not* a BTP. However,  $C_2 = B_3B_2$ ,  $C_1 = B_1$ , and  $C = C_2C_1$  are bisequence matrices; hence  $C_2C_1$  and  $C$  are bisequence factorizations of which

$$(4.4) \quad C_2C_1 = \begin{bmatrix} \theta_2^1 [\theta_2^1 \quad \mathbf{1}] \\ \theta_2^1 [\mathbf{1} \quad \theta_2^1] \end{bmatrix} [\theta_1^2 \quad \theta_1^2 \quad \theta_1^2]$$

is bisequence indecomposable (see Figure 6).

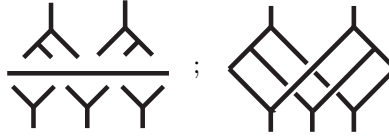

Figure 6. Graphical representations of  $C_2C_1$  and  $C$ .

Bisequence indecomposables are especially important, and we wish to identify a canonical bisequence indecomposable representative of a given class  $A \in G_{n,m}^{\text{pre}} / \sim$ . First consider a bisequence indecomposable  $A_k \cdots A_1 \in A$  with some  $A_i \in \{\theta_s^1, \theta_1^s\}$ . If  $A_i = \theta_s^1$  for some  $s$ , then  $A_i \cdots A_1$  is identified with an up-rooted planar rooted leveled trees (PLT) with  $i$  levels and  $m$  leaves; dually, if  $A_i = \theta_1^s$  for some  $t$ , then  $A_k \cdots A_i$  is identified with a down-rooted PLT with  $k - i + 1$  levels and  $n$  leaves. Note that both situations occur in factorizations of the form  $A_k \cdots \theta_1^t \theta_s^1 \cdots A_1$ . But in either case, the indicated PLT represents an isomorphism class of PLTs whose

elements determine distinct bisequence indecomposable factorizations of  $A$ . For example, the isomorphic PLTs

$$\begin{array}{c} \diagup \\ \diagdown \\ \text{---} \\ \diagup \\ \diagdown \end{array} : \bullet \bullet \bullet \bullet \rightarrow (\bullet \bullet) \bullet \bullet \rightarrow (\bullet \bullet)(\bullet \bullet)$$

and

$$\begin{array}{c} \diagup \\ \diagdown \\ \text{---} \\ \diagup \\ \diagdown \end{array} : \bullet \bullet \bullet \bullet \rightarrow \bullet \bullet (\bullet \bullet) \rightarrow (\bullet \bullet)(\bullet \bullet)$$

respectively determine the distinct equivalent bisequence indecomposables

$$A_4 A_3 A_2 A_1 = [\theta_1^2 \ \mathbf{1} \ \mathbf{1}]^T [\mathbf{1} \ \theta_1^2]^T [\theta_1^2] [\theta_3^1]$$

and

$$A'_4 A'_3 A'_2 A'_1 = [\mathbf{1} \ \mathbf{1} \ \theta_1^2]^T [\theta_1^2 \ \mathbf{1}]^T [\theta_1^2] [\theta_3^1]$$

in  $G_{4,3}^{\text{pre}}$ .

Now recall that a PLT with  $s$  levels and  $t$  leaves specifies the order in which  $s$  pairs of parentheses are inserted into a string of  $t$  indeterminants. When faced with the situations described above, *choose the factorization indexed by the PLT that successively inserts parentheses as far to the left as possible*. Such factorizations have *preferred operadic substrings*.

**Definition 6.** A **preferred factorization** is a factorization with preferred operadic substrings (if any) and factors whose entries have this property. A bisequence matrix  $B \in G^{\text{pre}}$  is **balanced** if each entry of  $B$  is a preferred bisequence indecomposable factorization. A **balanced factorization** of  $A \in G^{\text{pre}} / \sim$  is a preferred bisequence indecomposable factorization  $A_s \cdots A_1$  in which  $A_i$  is balanced for all  $i$ .

In the example above,  $A_4 A_3 A_2 A_1$  is the (obviously unique) balanced factorization of  $A \in G_{4,3}^{\text{pre}} / \sim$ . In view of Definition 2, Axiom (i), two associations of a basic string  $A_s \cdots A_1$  that define sequences of BTPs are equal. Hence each class  $A \in G_{n,m}^{\text{pre}} / \sim$  has a unique preferred factorization of maximal length. In fact:

**Proposition 2.** *Each class  $A \in G_{n,m}^{\text{pre}} / \sim$  has a unique balanced factorization.*

*Proof.* If  $m+n \leq 4$ , balanced factorizations of  $A$  are  $\Theta$ -factorizations, and obviously unique. Inductively, assume the statement holds for all  $B \in G_{l,k}^{\text{pre}} / \sim$  with  $k \leq m$ ,  $l \leq n$  and  $k+l < m+n$ , and consider a class  $A \in G_{n,m}^{\text{pre}} / \sim$ . If  $\theta_m^n \in A$ , then  $A$  is a balanced singleton class. Otherwise, consider the unique preferred class representative  $A_s \cdots A_1$  of maximal length. If  $A_s \cdots A_1$  is a bisequence factorization, it is balanced. If not, evaluate  $\Upsilon$ -products and obtain a bisequence factorization  $B_1 B_2$  of  $A$ . Either  $B_1 = A_s$  or  $B_1 = A_s B'_1$ . In either case, there is a bisequence factorization  $A_s B$  of  $A$ . If  $B$  is bisequence indecomposable,  $A_s B$  is the unique balanced factorization of  $A$ . If not, there is a bisequence factorization  $C_1 C_2$  of  $B$ . If  $C_1$  is bisequence indecomposable, consider  $C_2$ ; otherwise, decompose  $C_1$ . Continue in this manner until the process terminates.  $\square$

We now construct a set that conveniently indexes the module generators  $G^{\text{pre}} / \sim$  for  $F^{\text{pre}}(\Theta)$ . Define a map  $\phi$  that splits the projection  $G^{\text{pre}} \rightarrow G^{\text{pre}} / \sim$  as follows: For each pair  $(m, n)$  with  $m+n \leq 3$ , set  $\phi(\text{cls } \theta_m^n) = \theta_m^n$ . Inductively, for each pair  $(m, n)$  with  $m+n \geq 4$ , assume that  $\phi$  has been defined on  $G_{j,i}^{\text{pre}} / \sim$  for  $i+j < m+n$ . Then given a class  $g \in G_{n,m}^{\text{pre}} / \sim$ , define  $\phi_{n,m}(g)$  to be the balanced factorization of  $g$ . Let  $\mathcal{B}_{n,m}^{\text{pre}} = \text{Im } \phi_{n,m}$  and  $\mathcal{B}^{\text{pre}} = \bigcup \mathcal{B}_{n,m}^{\text{pre}}$ .

Although a balanced factorization  $\beta \in \mathcal{B}^{\text{pre}}$  is not a  $\Theta$ -factorization, there is a related PLT  $\Psi(\beta)$  whose leaves are  $\Theta$ -factorizations. Let  $\beta = B_s \cdots B_1 \in \mathcal{B}^{\text{pre}}$  and set  $\Psi_1(\beta) = \beta$ . If  $\beta$  is a  $\Theta$ -factorization, set  $\Psi(\beta) = \Psi_1(\beta)$ . Otherwise, let  $(\beta_k)$  denote the tuple of entries of  $B_k$  listed in row order and replace each entry  $\beta_k$  of  $(\beta_k)$  with its balanced factorization  $\beta'_k \in \mathcal{B}^{\text{pre}}$ . Form the 2-level tree  $\Psi_2(\beta)$  with root  $\beta$  and leaves labeled by the entries of  $(\beta'_k)$  (see Example 11). If each  $\beta'_k$  is a  $\Theta$ -factorization, set  $\Psi(\beta) = \Psi_2(\beta)$ . Otherwise, repeat this process for each  $\beta'_k$ , i.e., let  $\Psi_1(\beta'_k) = \beta'_k$ ; if  $\beta'_k$  that is not a  $\Theta$ -factorization, construct  $\Psi_2(\beta'_k)$ . Now construct 3-level tree  $\Psi_3(\beta)$  either by appending the tree  $\Psi_2(\beta'_k)$  to the leaf  $\beta'_k$  or by extending the branch of  $\beta'_k$  otherwise. If each level 3 entry of  $\Psi_3(\beta)$  is a  $\Theta$ -factorization, set  $\Psi(\beta) = \Psi_3(\beta)$ ; otherwise continue inductively. This process terminates after  $r$  steps and uniquely determines an  $r$ -level tree  $\Psi(\beta)$  whose leaves are balanced  $\Theta$ -factorizations.

**Example 11.** *The balanced factorization*

$$\beta = \left[ \begin{array}{c} \theta_2^1 [ \theta_2^1 \quad \theta_1^1 ] \\ \theta_2^1 [ \theta_1^1 \quad \theta_2^1 ] \end{array} \right] [ \theta_1^2 \quad \theta_1^2 \quad \theta_1^2 ]$$

is associated with the 2-level tree

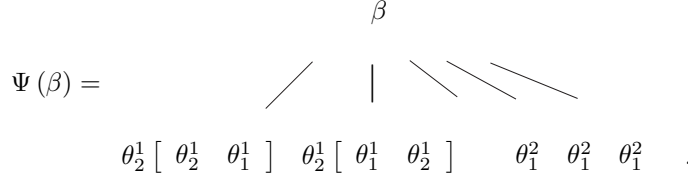

Finally, let  $\mathcal{C}_{n,m}^{\text{pre}} = \{ \Psi(\beta) \mid \beta \in \mathcal{B}_{n,m}^{\text{pre}} \}$ ; then  $\mathcal{C}^{\text{pre}} = \bigcup_{m,n} \mathcal{C}_{n,m}^{\text{pre}}$  indexes the set of module generators for  $F^{\text{pre}}(\Theta)$ . In Subsection 6.2 we identify a subset  $\mathcal{C} \subset \mathcal{C}^{\text{pre}}$  whose elements simultaneously index module generators of the “free matrad”  $F(\Theta)$  and cells of the biassociahedra  $KK$ . This identification relates the module structure of  $F(\Theta)$  to the combinatorics of permutahedra.

**4.4. The Bialgebra Prematrad.** As is the case for operads and PROPs, prematrads can be described by generators and relations.

**Definition 7.** *Let  $\mathcal{H}^{\text{pre}} = F^{\text{pre}}(\Theta) / \sim$ , where  $\Theta = \langle \theta_1^1 = \mathbf{1}, \theta_2^1, \theta_1^2 \rangle$ ,  $\theta_i^j \neq 0$ , and  $A \sim B$  if and only if  $\text{bideg}(A) = \text{bideg}(B)$ . Let  $\eta(\mathbf{1}) = \mathbf{1}$  and let  $\gamma$  be the structure map induced by projection. Then  $(\mathcal{H}^{\text{pre}}, \eta, \gamma)$  is the **bialgebra prematrad** if the following axioms hold:*

- (i) *Associativity:*  $\gamma(\theta_2^1; \theta_2^1, \mathbf{1}) = \gamma(\theta_2^1; \mathbf{1}, \theta_2^1)$ .
- (ii) *Coassociativity:*  $\gamma(\theta_1^2, \mathbf{1}; \theta_1^2) = \gamma(\mathbf{1}, \theta_1^2; \theta_1^2)$ .
- (iii) *Hopf compatibility:*  $\gamma(\theta_1^2; \theta_2^1) = \gamma(\theta_2^1, \theta_2^1; \theta_1^2, \theta_1^2)$ .

Each bigraded component  $\mathcal{H}_{n,m}^{\text{pre}}$  is generated by a singleton  $c_{n,m}$ ; for example,  $c_{1,2} = \theta_2^1$ ,  $c_{2,1} = \theta_1^2$ ,  $c_{1,3} = \gamma(\theta_2^1; \theta_2^1, \mathbf{1})$ ,  $c_{3,1} = \gamma(\theta_1^2, \mathbf{1}; \theta_1^2)$ ,  $c_{2,2} = \gamma(\theta_1^2; \theta_2^1)$ , and so on. Note that  $\mathcal{H}_{1,*}^{\text{pre}}$  and  $\mathcal{H}_{*,1}^{\text{pre}}$  are operads; the first is generated by  $\theta_2^1$  subject to (i) while the second is generated by  $\theta_1^2$  subject to (ii). Both are isomorphic to the associativity operad  $\underline{\text{Ass}}$  ([9]). And furthermore, for the bialgebra PROP  $\mathcal{B}$  we have  $\mathcal{B}^{\text{pre}} = \mathcal{H}^{\text{pre}}$  and  $U(\mathcal{H}^{\text{pre}}) = \mathcal{B}$ .

Given a graded  $R$ -module  $H$ , a map of prematrads  $\mathcal{H}^{\text{pre}} \rightarrow U_H$  defines a bialgebra structure on  $H$  and vice versa. Since each path of arrows from  $(m, 1)$  to  $(1, n)$  in  $\mathbb{N}^2$  represents some  $\Upsilon$ -factorization of  $c_{n,m}$  (see Figure 5), we think of all such paths as equal. Therefore  $\mathcal{H}^{\text{pre}}$  is the smallest module among existing general constructions that describe bialgebras (c.f. [8], [15]). Although the symmetric groups do not act on prematrads, the permutation  $\sigma_{n,m}$  built into the associativity axiom minimizes the modules involved.

**4.5. Local Prematrads.** Let  $M = \{M_{n,m}\}_{m,n \geq 1}$  be a bigraded  $R$ -module, let  $\mathbf{W}$  be a telescoping submodule of  $TTM$ , let  $\mathcal{W}$  be its telescopic extension, and let  $\gamma_{\mathbf{w}} = \left\{ \gamma_{\mathbf{x}}^{\mathbf{y}} : \mathbf{W}_p^{\mathbf{y}} \otimes \mathbf{W}_{\mathbf{x}}^q \rightarrow \mathbf{W}_{|\mathbf{x}|}^{|\mathbf{y}|} \right\}$  be a structure map. If  $A \otimes B$  is a BTP in  $\mathcal{W} \otimes \mathcal{W}$ , each TP  $A' \otimes B'$  in  $A \otimes B$  lies in  $\mathbf{W}_p^{\mathbf{y}} \otimes \mathbf{W}_{\mathbf{x}}^q$  for some  $\mathbf{x}, \mathbf{y}, p, q$ . Consequently,  $\gamma_{\mathbf{w}}$  extends to a global product  $\Upsilon : \mathcal{W} \otimes \mathcal{W} \rightarrow \mathcal{W}$  as in (4.1). In fact,  $\mathcal{W}$  is the smallest matrix submodule containing  $\mathbf{W}$  on which  $\Upsilon$  is well-defined.

**Definition 8.** Let  $\mathbf{W}$  be a telescoping submodule of  $TTM$ , let  $\gamma_{\mathbf{w}} = \left\{ \gamma_{\mathbf{x}}^{\mathbf{y}} : \mathbf{W}_p^{\mathbf{y}} \otimes \mathbf{W}_{\mathbf{x}}^q \rightarrow \mathbf{W}_{|\mathbf{x}|}^{|\mathbf{y}|} \right\}$  be a structure map, and let  $\eta : R \rightarrow \mathbf{M}$ . The triple  $(M, \gamma_{\mathbf{w}}, \eta)$  is a **local prematrad (with domain  $\mathbf{W}$ )** if the following axioms are satisfied:

- (i)  $\mathbf{W}_{\mathbf{x}}^1 = \mathbf{M}_{\mathbf{x}}^1$  and  $\mathbf{W}_1^{\mathbf{y}} = \mathbf{M}_1^{\mathbf{y}}$  for all  $\mathbf{x}, \mathbf{y}$ ;
- (ii)  $\Upsilon$  is associative on  $\mathcal{W} \cap \mathbf{M}$ ;
- (iii) the prematrad unit axiom holds for  $\gamma_{\mathbf{w}}$ .

**Example 12.** Let  $\mathbf{V}$  be the bisequence vector submodule of  $TTM$ . If  $(M, \gamma)$  is a prematrad, then  $\gamma = \gamma_{\mathbf{v}}$  and  $(M, \gamma)$  is a local prematrad with domain  $\mathbf{V}$ . Local sub-prematrads  $(M, \gamma_{\mathbf{w}}) \subset (M, \gamma)$  are obtained by restricting the domain to submodules such as  $\mathbf{M}_1^*$ ,  $\mathbf{M}_*^1$ , and  $\mathbf{M}_*^1 \cup \mathbf{M}_1^*$ . Note that  $(M, \gamma_{\mathbf{M}_1^*})$  and  $(M, \gamma_{\mathbf{M}_*^1})$  are operads.

## 5. DIAGONAL APPROXIMATIONS

A diagonal approximation  $\Delta_X$  on a cellular complex  $X$  determines a “ $k$ -subdivision”  $X^{(k)}$  of  $X$  and a cellular inclusion  $\Delta^{(k)} : X^{(k)} \hookrightarrow X^{\times k+1}$  whose image is the subcomplex of  $X^{\times k+1}$  we denote by  $\Delta^{(k)}(X)$ . In particular, the subcomplex  $\Delta^{(k)}(P_n) \subset P_n^{\times k+1}$  determined by the S-U diagonal  $\Delta_P$  defines the selection rule in Subsection 2.2 and, more generally, in the next section.

Recall that a map  $f : X \rightarrow Y$  of  $CW$ -complexes is homotopic to a cellular map  $g : X \rightarrow Y$ , which in turn induces a chain map  $g : C_*(X) \rightarrow C_*(Y)$ . Given a geometric diagonal  $\Delta : X \rightarrow X \times X$ , a cellular map  $\Delta_X : X \rightarrow X \times X$  homotopic to  $\Delta$  is called a *diagonal approximation*. A diagonal approximation  $\Delta_X$  induces a chain map  $\Delta_X : C_*(X) \rightarrow C_*(X) \otimes C_*(X)$ , called a *diagonal*. A brief review of the S-U diagonals  $\Delta_P$  and  $\Delta_K$  on cellular chains of permutahedra  $P = \sqcup_{n \geq 1} P_n$  and associahedra  $K = \sqcup_{n \geq 2} K_n$  (up to sign) now follows (see [12] for details).

**5.1. The S-U Diagonals  $\Delta_P$  and  $\Delta_K$ .** Let  $\underline{n} = \{1, 2, \dots, n\}$ ,  $n \geq 1$ . A matrix  $E$  with entries from  $\{0\} \cup \underline{n}$  is a *step matrix* if the following conditions hold:

- (i) Each element of  $\underline{n}$  appears as an entry of  $E$  exactly once.
- (ii) Elements of  $\underline{n}$  in each row and column of  $E$  form an increasing contiguous block.
- (iii) Each diagonal parallel to the main diagonal of  $E$  contains exactly one element of  $\underline{n}$ .

The non-zero entries in a step matrix form a continuous staircase connecting the lower-left and upper-right most entries. There is a bijective correspondence between step matrices with non-zero entries in  $\underline{n}$  and permutations of  $\underline{n}$ .

Given a  $q \times p$  integer matrix  $M = (m_{ij})$ , choose proper subsets  $S_i \subset \{\text{non-zero entries in row } (i)\}$  and  $T_j \subset \{\text{non-zero entries in col } (j)\}$ , and define *down-shift* and *right-shift* operations  $D_{S_i}$  and  $R_{T_j}$  on  $M$  as follows:

- (i) If  $S_i \neq \emptyset$ ,  $\max \text{row}(i+1) < \min S_i = m_{ij}$ , and  $m_{i+1,k} = 0$  for all  $k \geq j$ , then  $D_{S_i}M$  is the matrix obtained from  $M$  by interchanging each  $m_{ik} \in S_i$  with  $m_{i+1,k}$ ; otherwise  $D_{S_i}M = M$ .
- (ii) If  $T_j \neq \emptyset$ ,  $\max \text{col}(j+1) < \min T_j = m_{ij}$ , and  $m_{k,j+1} = 0$  for all  $k \geq i$ , then  $R_{T_j}M$  is the matrix obtained from  $M$  by interchanging each  $m_{k,j} \in T_j$  with  $m_{k,j+1}$ ; otherwise  $R_{T_j}M = M$ .

Given a  $q \times p$  step matrix  $E$  together with subsets  $S_1, \dots, S_q$  and  $T_1, \dots, T_p$  as above, there is the *derived matrix*

$$R_{T_p} \cdots R_{T_2} R_{T_1} D_{S_q} \cdots D_{S_2} D_{S_1} E.$$

In particular, step matrices are derived matrices under the trivial action with  $S_i = T_j = \emptyset$  for all  $i, j$ .

Let  $a = A_1|A_2|\cdots|A_p$  and  $b = B_q|B_{q-1}|\cdots|B_1$  be partitions of  $\underline{n}$ . Then  $a \times b$  is a  $(p, q)$ -complementary pair (CP) if there is a  $q \times p$  derived matrix  $M = (m_{ij})$  such that  $A_j = \{m_{ij} \neq 0 \mid 1 \leq i \leq q\}$  and  $B_i = \{m_{ij} \neq 0 \mid 1 \leq j \leq p\}$ . Thus  $(p, q)$ -CPs, which are in one-to-one correspondence with derived matrices, identify a particular set of product cells in  $P_n \times P_n$ .

**Definition 9.** Define  $\Delta_P : C_0(P_1) \rightarrow C_0(P_1) \otimes C_0(P_1)$  by  $\Delta_P(\underline{1}) = \underline{1} \otimes \underline{1}$ . Inductively, having defined  $\Delta_P : C_*(P_k) \rightarrow C_*(P_k) \otimes C_*(P_k)$  for all  $k \leq n$ , define  $\Delta_P$  on  $\underline{n+1} \in C_n(P_{n+1})$  by

$$\Delta_P(\underline{n+1}) = \sum_{\substack{(p,q)\text{-CPs } a \times b \\ p+q=n+2}} \pm a \otimes b$$

and extend  $\Delta_P$  multiplicatively, i.e.,  $\Delta_P(u_1|\cdots|u_r) = \Delta_P(u_1)|\cdots|\Delta_P(u_r)$ .

The diagonal  $\Delta_P$  induces a diagonal  $\Delta_K$  on  $C_*(K)$ . Recall that faces of  $P_n$  in codimension  $k$  are indexed by planar rooted trees with  $n+1$  leaves and  $k+1$  levels (PLTs), and forgetting levels defines the cellular projection  $\vartheta_0 : P_n \rightarrow K_{n+1}$  given by A. Tonks [18]. Thus faces of  $P_n$  indexed by PLTs with multiple nodes in the same level degenerate under  $\vartheta_0$ , and corresponding generators span the kernel of the induced map  $\vartheta_0 : C_*(P_n) \rightarrow C_*(K_{n+1})$ . The diagonal  $\Delta_K$  is given by

$$\Delta_K \vartheta_0 = (\vartheta_0 \otimes \vartheta_0) \Delta_P.$$

**5.2.  $k$ -Subdivisions and  $k$ -Approximations.** When  $X$  is a polytope one can choose a diagonal approximation  $\Delta_X : X \rightarrow X \times X$  such that

- (i)  $\Delta_X$  acts on each face  $e \subset X$  as a (topological) inclusion  $\Delta_X(e) \subset e \times e$ , and
- (ii) there is an induced (cellular) 1-subdivision  $X^{(1)}$  of  $X$  that converts  $\Delta_X$  into a cellular inclusion  $\Delta_X^{(1)} : X^{(1)} \rightarrow X \times X$ .

If  $e = \bigcup_{i=1}^m e_i$  and  $e_i \subseteq X^{(1)}$ , there are faces  $u_i, v_i \subseteq e_i$  such that  $\Delta_X^{(1)}(e_i) = u_i \times v_i$ . Thus  $\Delta_X(e) = \bigcup_{i=1}^m \Delta_X^{(1)}(e_i) = \bigcup_{i=1}^m u_i \times v_i$ , and in particular,  $\Delta_X^{(1)}$  agrees with the geometric diagonal  $\Delta$  only on vertices of  $X$ .

The 1-subdivision  $X^{(1)}$  arising from an explicit diagonal approximation  $\Delta_X$  can be thought of as the cell complex obtained by gluing the cells in  $\Delta_X(X)$  together along their common boundaries in the only way possible. For example, the A-W diagonal on the simplex  $\Delta^n$ , the Serre diagonal on the cube  $I^n$ , and the S-U diagonals on the permutahedron  $P_{n+1}$  and the associahedron  $K_{n+2}$  (see [12]) induce explicit 1-subdivisions  $(\Delta^n)^{(1)}$ ,  $(I^n)^{(1)}$ ,  $P_{n+1}^{(1)}$  and  $K_{n+2}^{(1)}$  (see Figures 7-10), and it is a good exercise to determine how the vertices of  $(I^n)^{(1)}$  resolve in  $P_{n+1}^{(1)}$  and  $K_{n+2}^{(1)}$ . Algebraically, the assignment

$$(5.1) \quad e \mapsto \{u_i \times v_i\}_{1 \leq i \leq m}$$

determines a DG diagonal  $\Delta_X : C_*(X) \rightarrow C_*(X) \otimes C_*(X)$  on cellular chains such that  $\Delta_X(C_*(X)) \subseteq C_*\left(\Delta_X^{(1)}(X^{(1)})\right)$ , where equality holds in the (unique) case  $X = *$ . Conversely, if a DG diagonal approximation  $\Delta_X$  on  $C_*(X)$  is determined by a cellular decomposition as in (5.1), there is a corresponding 1-subdivision  $X^{(1)}$  and a 1-approximation  $\Delta_X^{(1)} : X^{(1)} \rightarrow X \times X$ .

Furthermore, there is a 2-subdivision  $X^{(2)}$  of  $X$  (see Figure 11) and a corresponding 2-approximation  $\tilde{\Delta}_X^{(2)} : X^{(2)} \rightarrow X^{(1)} \times X$  that sends each cell of  $X^{(2)}$  onto a single cell of  $X^{(1)} \times X$ ; consequently, the composition  $\Delta_X^{(2)} = \left(\Delta_X^{(1)} \times \mathbf{1}\right) \tilde{\Delta}_X^{(2)}$  sends each cell of  $X^{(2)}$  onto a single cell of  $X^{\times 3}$ . Inductively, for each  $k$ , there is a  $k$ -subdivision  $X^{(k)}$  and a  $k$ -approximation  $\tilde{\Delta}_X^{(k)} : X^{(k)} \rightarrow X^{(k-1)} \times X$  such that  $\Delta_X^{(k)} = \left(\Delta_X^{(k-1)} \times \mathbf{1}\right) \tilde{\Delta}_X^{(k)}$  sends each cell of  $X^{(k)}$  onto a single cell of  $X^{\times k+1}$ . Thus, for each  $k \geq 0$ , a diagonal approximation  $\Delta_X$  fixes the subcomplex  $\Delta^{(k)}(X) := \Delta_X^{(k)}(X^{(k)}) \subset X^{\times k+1}$ , which says that  $\Delta_X$  acts on  $\Delta^{(k)}(X)$  as an inclusion.



Figure 7. The 1-subdivision of  $P_2 = K_3 = I$ .

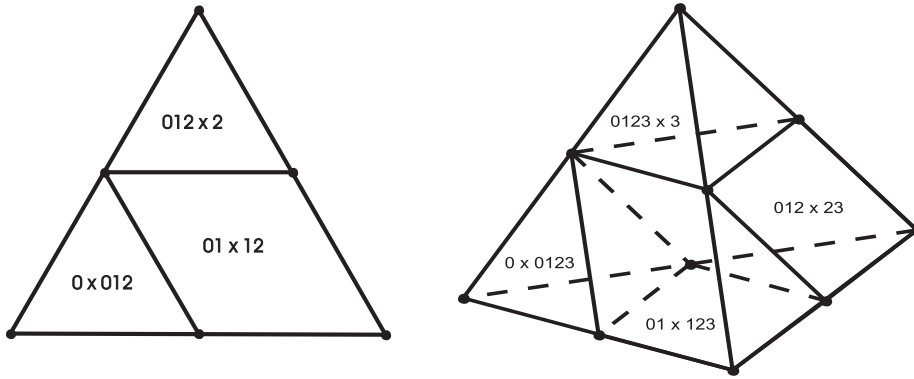

Figure 8. 1-subdivisions of  $\Delta^2$  and  $\Delta^3$  via the A-W diagonal.

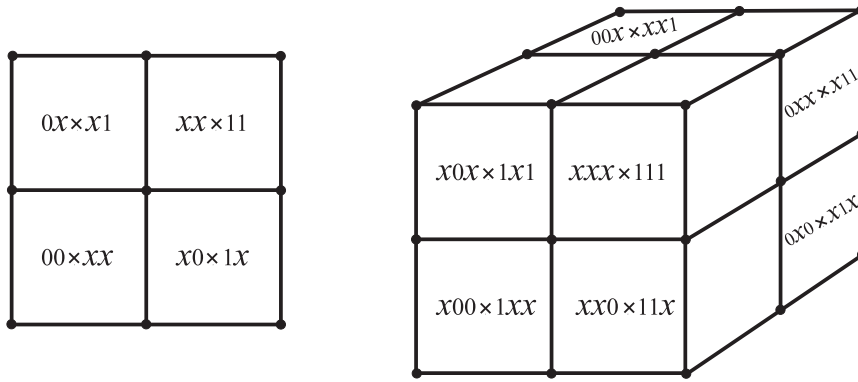

Figure 9. 1-subdivisions of  $I^2$  and  $I^3$  via the Serre diagonal.

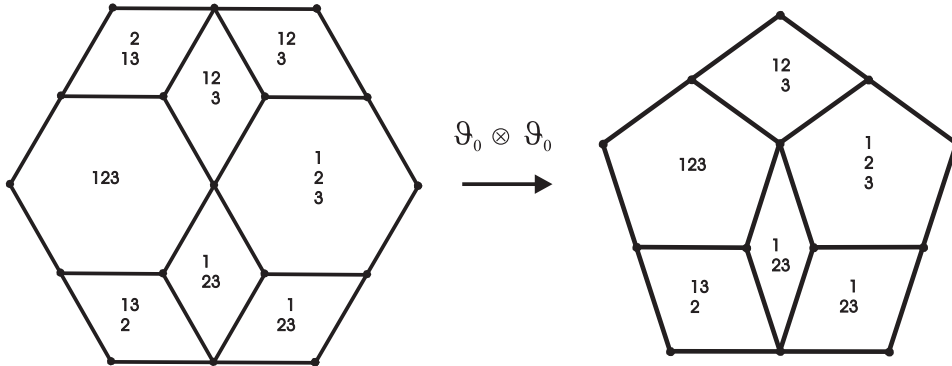
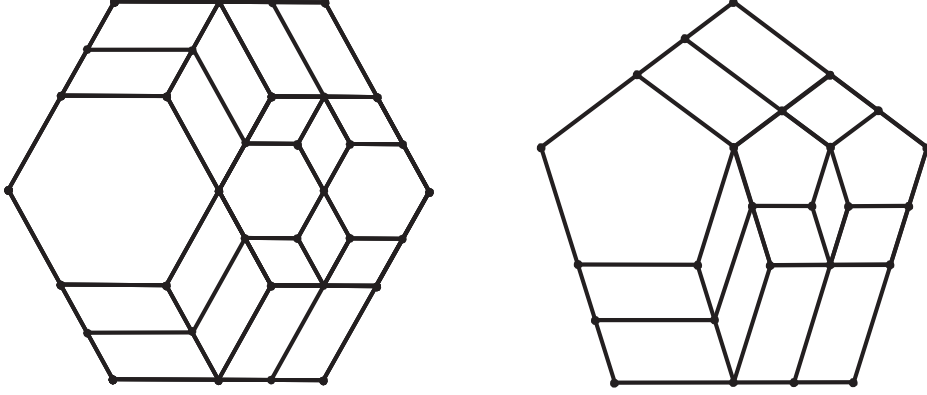

Figure 10. 1-subdivisions of  $P_3$  and  $K_4$  via S-U diagonals  $\Delta_P$  and  $\Delta_K$ .



Figure 11. 2-subdivisions of  $P_3$  and  $K_4$ .

The subcomplex  $\Delta^{(k)}(P_n) \subset P_n^{\times k+1}$  defines the “configuration module” of a local pretradr in the next section.

## 6. MATRADS

In this section we introduce the objects in the category of matrads; morphisms require a relative theory that will be constructed in the sequel. As motivation, let  $\Theta = \langle \theta_m^n \neq 0 \mid \theta_1^1 = \mathbf{1} \rangle_{m,n \geq 1}$ , and consider the canonical projection  $\rho^{\text{pre}} : F^{\text{pre}}(\Theta) \rightarrow \mathcal{H}^{\text{pre}}$ ; then

$$\rho^{\text{pre}}(\theta_m^n) = \begin{cases} \theta_m^n, & m+n \leq 3 \\ 0, & \text{otherwise.} \end{cases}$$

Now consider a differential  $\partial^{\text{pre}}$  on  $F^{\text{pre}}(\Theta)$  such that  $\rho^{\text{pre}}$  is a free resolution in the category of pretrads. Then the induced isomorphism  $\varrho^{\text{pre}} : H_*(F^{\text{pre}}(\Theta), \partial^{\text{pre}}) \approx \mathcal{H}^{\text{pre}}$  implies

$$\partial^{\text{pre}}(\theta_2^1) = \partial^{\text{pre}}(\theta_1^2) = 0$$

$$\partial^{\text{pre}}(\theta_3^1) = \gamma(\theta_2^1; \mathbf{1}, \theta_2^1) - \gamma(\theta_2^1; \theta_2^1, \mathbf{1})$$

$$\partial^{\text{pre}}(\theta_2^2) = \gamma(\theta_1^2; \theta_2^1) - \gamma(\theta_2^1 \theta_2^1; \theta_1^2)$$

$$\partial^{\text{pre}}(\theta_1^3) = \gamma(\mathbf{1}, \theta_1^2; \theta_1^2) - \gamma(\theta_1^2, \mathbf{1}; \theta_1^2).$$

However, defining  $\partial^{\text{pre}}$  on all of  $\Theta$  is quite subtle, and while it is possible to canonically extend  $\partial^{\text{pre}}$  to all of  $\Theta$ , acyclicity is difficult to verify. Instead, there is a canonical proper submodule  $\mathcal{H}_\infty \subset F^{\text{pre}}(\Theta)$  and a differential  $\partial$  on  $\mathcal{H}_\infty$  such that the canonical projection  $\varrho : \mathcal{H}_\infty \rightarrow \mathcal{H}^{\text{pre}}$  is a free resolution in the category of “matrads.” Furthermore, we conjecture that the minimal resolution of  $\mathcal{H}$  in the category of PROPs (and consequently, in the category of pretrads) is recovered by the universal enveloping functor  $U$  discussed in Example 17 below, i.e., the minimal resolution of the bialgebra PROP  $\mathcal{B}$  is  $U(\rho) : U(\mathcal{H}_\infty) \rightarrow U(\mathcal{H}^{\text{pre}}) = \mathcal{B}$ , in which case  $\mathcal{H}_\infty$  is the smallest extension of  $\mathcal{H}^{\text{pre}}$  in the category of modules.

The precise definition of  $\mathcal{H}_\infty$  requires more machinery.

**6.1. Matrads Defined.** Consider a family of pairs  $(\mathbf{W}_\alpha, \gamma_\alpha)$ , where  $\mathbf{W}_\alpha \subset TTM$  is a telescoping submodule, and the corresponding family of telescopic extensions  $(\mathcal{W}_\alpha, \Upsilon_\alpha)$ . To each pair  $(\mathcal{W}_\alpha, \Upsilon_\alpha)$  the  $\Upsilon$ -factorizations given by via Definition 10 below determine a unique “configuration module”  $\Gamma(\mathbf{W}_\alpha) \subseteq \mathcal{W}_\alpha$  with the following property: If  $\mathbf{W}_\alpha \subseteq \mathbf{W}_\beta$  and  $\gamma_{\mathbf{w}_\alpha} = \gamma_{\mathbf{w}_\beta} \Big|_{\mathbf{W}_\alpha}$ , then  $\Gamma(\mathbf{W}_\alpha) \subseteq \Gamma(\mathbf{W}_\beta)$ . The local prematrad  $(M, \gamma_{\mathbf{w}_\alpha})$  is a “matrad” if  $\mathbf{W}_\alpha$  is “ $\Gamma$ -stable,” i.e.,  $\mathbf{W}_\alpha$  is the smallest telescoping submodule such that  $\Gamma(\mathbf{W}_\alpha) = \Gamma(\mathbf{W}_\beta)$  whenever  $\mathbf{W}_\alpha \subset \mathbf{W}_\beta$  and  $\gamma_{\mathbf{w}_\alpha} = \gamma_{\mathbf{w}_\beta} \Big|_{\mathbf{W}_\alpha}$ .

Matrads are intimately related to the permutahedra. Recall that each codimension  $k - 1$  face of  $P_{m-1}$  is identified with two PLTs—an up-rooted PLT and its down-rooted mirror image—with  $m$  leaves and  $k \geq 2$  levels (see [5], [12]). Define the  $(m, 1)$ -row descent sequence of  $\lambda_m$  to be  $\mathbf{m} = (m)$ . Given an up-rooted PLT  $T = T^k$  with  $k$  levels, express  $T^i = T^{i-1} / \lambda_{m_{i,1}} \cdots \lambda_{m_{i,r_i}}$  for  $k \geq i > 1$  and  $T^1 = \lambda_{m_{1,1}}$ . Define the  $i^{\text{th}}$  leaf sequence of  $T$  to be the row matrix  $\mathbf{m}_i = (m_{i,1}, \dots, m_{i,r_i})$  and the  $(m, k)$ -row descent sequence of  $T$  to be the  $k$ -tuple of row matrices  $(\mathbf{m}_1, \dots, \mathbf{m}_k)$ . Note that the vertices of  $P_{m-1}$  are identified with  $(m, m - 1)$ -row descent sequences  $(\mathbf{m}_1, \dots, \mathbf{m}_{m-1})$ , where  $\mathbf{m}_i = (1, \dots, 2, \dots, 1)^T \in \mathbb{N}^{r_i}$  with exactly one 2 in position  $j$  for some  $1 \leq j \leq r_i$ , in which case  $\mathbf{m}_1 = (2)$ . Dually, define the  $(n, 1)$ -column descent sequence of  $\gamma^n$  to be  $\mathbf{n} = (n)$ . Given a down-rooted PLT  $T = T^l$  with  $l$  levels, express  $T^i = \gamma^{n_{i,1}} \cdots \gamma^{n_{i,s_i}} / T^{i-1}$  for  $l \geq i > 1$  and  $T^1 = \gamma^{n_{1,1}}$ . Define the  $i^{\text{th}}$  leaf sequence of  $T$  to be the column matrix  $\mathbf{n}_i = (n_{i,1}, \dots, n_{i,s_i})^T$  and the  $(n, l)$ -column descent sequence of  $T$  to be the  $l$ -tuple of column matrices  $(\mathbf{n}_l, \dots, \mathbf{n}_1)$ .

Given a telescoping submodule  $\mathbf{W}$  and its telescopic extension  $\mathcal{W}$ , let  $\mathcal{W}_{\text{row}} = \mathcal{W} \cap \overline{\mathbf{M}}_{\text{row}}$  and  $\mathcal{W}^{\text{col}} = \mathcal{W} \cap \overline{\mathbf{M}}^{\text{col}}$ .

**Definition 10.** Given a local prematrad  $(M, \gamma_{\mathbf{W}})$  with domain  $\mathbf{W}$ , let  $\zeta \in M_{*,m}$  and  $\xi \in M_{n,*}$  be elements with  $m, n \geq 2$ .

- (i) A **row factorization of  $\zeta$  with respect to  $\mathbf{W}$**  is a  $\Upsilon$ -factorization  $A_1 \cdots A_k = \zeta$  such that  $A_j \in \mathcal{W}_{\text{row}}$  and  $\text{rls}(A_j) \neq \mathbf{1}$  for all  $j$ . The sequence  $(\text{rls}(A_1), \dots, \text{rls}(A_k))$  is the related  $(m, k)$ -row descent sequence of  $\zeta$ .
- (ii) A **column factorization of  $\xi$  with respect to  $\mathbf{W}$**  is a  $\Upsilon$ -factorization  $B_l \cdots B_1 = \xi$  such that  $B_i \in \mathcal{W}^{\text{col}}$  and  $\text{cls}(B_i) \neq \mathbf{1}$  for all  $i$ . The sequence  $(\text{cls}(B_l), \dots, \text{cls}(B_1))$  is the related  $(n, l)$ -column descent sequence of  $\xi$ .

Column and row factorizations are not unique. Note that an element  $A \in M_{n,*}$  always has a trivial column factorization as the  $1 \times 1$  matrix  $[A]$ . When matrix entries in a row factorization are pictured as graphs, terms of the row descent sequence are “lower (input) leaf sequences” of the graphs along any row, and dually for column factorizations.

**Example 13.** An  $\Upsilon$ -product of bisequence matrices is simultaneously a row and column factorization. For example, consider the  $\Upsilon$ -product

$$C = C_1 C_2 C_3 = \begin{bmatrix} \theta_2^1 \\ \alpha_2^2 \\ \beta_2^2 \end{bmatrix} \begin{bmatrix} \theta_1^2 & \zeta_2^2 \\ \theta_1^1 & \theta_2^1 \end{bmatrix} [\theta_1^2 \ \xi_2^2 \ \theta_1^2] \in M_{5,4}.$$

As a row factorization, the  $(4, 3)$ -row descent sequence of  $C$  is

$$(\text{rls}(C_1), \text{rls}(C_2), \text{rls}(C_3)) = ((2), (12), (121)),$$

and as a column factorization, the  $(5, 3)$ -column descent sequence of  $C$  is

$$(\text{cls}(C_1), \text{cls}(C_2), \text{cls}(C_3)) = \left( \begin{pmatrix} 1 \\ 2 \\ 2 \end{pmatrix}, \begin{pmatrix} 2 \\ 1 \end{pmatrix}, (2) \right).$$

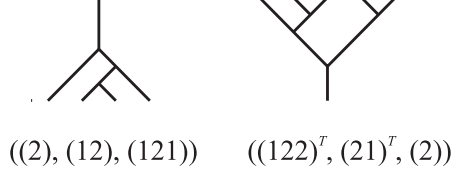

Given a local prematrad  $(M, \gamma_{\mathbf{W}})$  and elements  $A \in M_{*,s}$  and  $B \in M_{t,*}$  with  $s, t \geq 2$ , choose a row factorization  $A_1 \cdots A_k$  of  $A$  with respect to  $\mathbf{W}$  and  $(s, k)$ -row descent sequence  $\alpha$ , and a column factorization  $B_l \cdots B_1$  of  $B$  with respect to  $\mathbf{W}$  and  $(t, l)$ -column descent sequence  $\beta$ . Then  $\alpha$  identifies  $A$  with an up-rooted  $s$ -leaf,  $k$ -level PLT and a codimension  $k - 1$  face  $\hat{e}_A$  of  $P_{s-1}$ , and  $\beta$  identifies  $B$  with a down-rooted  $t$ -leaf,  $l$ -level PLT and a codimension  $l - 1$  face  $\check{e}_B$  of  $P_{t-1}$ . Extending to Cartesian products, identify the monomials  $A = A_1 \otimes \cdots \otimes A_q \in (M_{*,s})^{\otimes q}$  and  $B = B_1 \otimes \cdots \otimes B_p \in (M_{t,*})^{\otimes p}$  with the product cells

$$\hat{e}_A = \hat{e}_{A_1} \times \cdots \times \hat{e}_{A_q} \subset P_{s-1}^{\times q} \quad \text{and} \quad \check{e}_B = \check{e}_{B_1} \times \cdots \times \check{e}_{B_p} \subset P_{t-1}^{\times p}.$$

Now consider the S-U diagonal  $\Delta_P$  and recall from Section 5.2 that there is a  $k$ -subdivision  $P_r^{(k)}$  of  $P_r$  and a cellular inclusion  $P_r^{(k)} \hookrightarrow \Delta^{(k)}(P_r) \subset P_r^{\times k+1}$  for each  $k$  and  $r$ . Thus for each  $q \geq 2$ , the product cell  $\hat{e}_A$  either is or is not a subcomplex of  $\Delta^{(q-1)}(P_{s-1}) \subset P_{s-1}^{\times q}$ , and dually for  $\check{e}_B$ . This leads to the notion of ‘‘configuration module.’’

Let  $\mathbf{x}_{m,i}^p = (1, \dots, m, \dots, 1) \in \mathbb{N}^{1 \times p}$  with  $m$  in the  $i^{\text{th}}$  position and let  $\mathbf{y}_q^{n,j} = (1, \dots, n, \dots, 1)^T \in \mathbb{N}^{q \times 1}$  with  $n$  in the  $j^{\text{th}}$  position.

**Definition 11.** *The (left) configuration module of a local prematrad  $(M, \gamma_{\mathbf{W}})$  is the  $R$ -module*

$$\Gamma(M, \gamma_{\mathbf{W}}) = M \oplus \bigoplus_{\mathbf{x}, \mathbf{y} \notin \mathbb{N}; s, t \geq 1} \Gamma_{\mathbf{s}}^{\mathbf{y}}(M) \oplus \Gamma_{\mathbf{x}}^t(M), \quad \text{where}$$

$$\Gamma_{\mathbf{s}}^{\mathbf{y}}(M) = \begin{cases} \mathbf{M}_{\mathbf{1}}^{\mathbf{y}}, & s = 1; \mathbf{y} = \mathbf{y}_q^{n,j} \text{ for some } n, j, q \\ \langle A \in \mathbf{M}_{\mathbf{s}}^{\mathbf{y}} \mid \hat{e}_A \subset \Delta^{(q-1)}(P_{s-1}) \rangle, & s \geq 2 \\ 0, & \text{otherwise,} \end{cases}$$

$$\Gamma_{\mathbf{x}}^t(M) = \begin{cases} \mathbf{M}_{\mathbf{x}}^1, & t = 1; \mathbf{x} = \mathbf{x}_{m,i}^p \text{ for some } m, i, p \\ \langle B \in \mathbf{M}_{\mathbf{x}}^t \mid \check{e}_B \subset \Delta^{(p-1)}(P_{t-1}) \rangle, & t \geq 2 \\ 0, & \text{otherwise.} \end{cases}$$

Thus  $\Gamma_{\mathbf{x}}^t(M)$  is generated by those tensor monomials  $B = \beta_{x_1}^t \otimes \cdots \otimes \beta_{x_p}^t \in M_{t,x_1} \otimes \cdots \otimes M_{t,x_p}$  whose tensor factor  $\beta_{x_i}^t$  is identified with some factor of a product cell in  $\Delta^{(p-1)}(P_{t-1})$  corresponding to some column factorization  $\beta_{x_i}^t = B_{i,l} \cdots B_{i,1}$  with respect to  $\mathbf{W}$ , and dually for  $\Gamma_{\mathbf{s}}^{\mathbf{y}}(M)$ .

**Example 14.** Referring to Example 3, let  $M = M_{1,1} \oplus M_{2,2} = \langle \theta_1^1 \rangle \oplus \langle \theta_2^2 \rangle$ , and consider the local prematrad  $(M, \gamma_{\mathbf{V}})$ . Note that the action of  $\gamma_{\mathbf{V}}$  is trivial modulo unit (e.g.,  $\mathbf{M}_2^2 \cdot \mathbf{M}_{1,1}^1 = \mathbf{M}_2^2$  and  $\mathbf{M}_2^2 \cdot \mathbf{M}_{2,2}^2 \subseteq \mathbf{M}_4^4 = 0$ ). Then

$$\Gamma_*^1(M) \approx \Gamma_1^*(M) \approx T^+(M_{1,1}).$$

Since  $A = (\theta_2^2)^{\otimes q}$  can be thought of as an element of either  $\mathbf{M}_{2 \dots 2}^2$  or  $\mathbf{M}_2^{2 \dots 2}$ , we have either  $\hat{e}_A = \Delta^{(q-1)}(P_1) = P_1^{\times q}$  or  $\check{e}_A = \Delta^{(q-1)}(P_1) = P_1^{\times q}$  so that

$$\Gamma_*^2(M) \approx \Gamma_2^*(M) \approx T^+(M_{2,2}).$$

Thus

$$\Gamma(M, \gamma_{\mathbf{V}}) = \mathbf{V}.$$

Since  $r = 1$  is the only case in which the equality  $\Delta^{(k)}(P_r) = P_r^{\times k+1}$  holds for each  $k$ , it follows immediately that if  $A \in M_{n,m}$  is  $\gamma_{\mathbf{W}}$ -indecomposable (in which case its row and column factorizations with respect to  $\mathbf{W}$  are trivial) and  $\hat{e}_A \times \dots \times \hat{e}_A = e^{m-2} \times \dots \times e^{m-2}$  is a subcomplex of  $\Delta^{(n-1)}(P_{m-1})$ , then either  $m = 2$  and  $n$  is arbitrary or  $m > 2$  and  $n = 1$ ; dually, if  $\check{e}_A \times \dots \times \check{e}_A = e^{n-2} \times \dots \times e^{n-2}$  is a subcomplex of  $\Delta^{(m-1)}(P_{n-1})$ , then either  $m$  is arbitrary and  $n = 2$  or  $m = 1$  and  $n > 2$ . Consequently,

$$\bigoplus_{\mathbf{x}} \Gamma_{\mathbf{x}}^2(M) \approx T^+(M_{2,*}) \quad \text{and} \quad \bigoplus_{\mathbf{y}} \Gamma_{\mathbf{y}}^2(M) \approx T^+(M_{*,2}).$$

Furthermore, if  $m + n \geq 4$ ,  $(m, n) \neq (2, 2)$ , and  $A^{\otimes r} \in \Gamma(M, \gamma_{\mathbf{W}})$ , then  $r = 1$ , and the inclusion  $\Gamma_s^{\mathbf{y}}(M) \subseteq \mathbf{M}_s^{\mathbf{y}}$  is proper whenever  $s \geq 3$ ,  $\mathbf{y} \in \mathbb{N}^{q \times 1}$  with  $q \geq 2$ , and  $M_{y_j, s}$  contains a  $\gamma_{\mathbf{W}}$ -indecomposable element for each  $1 \leq j \leq q$ , and dually for  $\Gamma_{\mathbf{x}}^t(M) \subseteq \mathbf{M}_{\mathbf{x}}^t$ .

We are ready to define the notion of a matrad.

**Definition 12.** A local prematrad  $(M, \gamma_{\mathbf{W}}, \eta)$  is a *(left) matrad* if

$$\Gamma_p^{\mathbf{y}}(M, \gamma_{\mathbf{W}}) \otimes \Gamma_{\mathbf{x}}^q(M, \gamma_{\mathbf{W}}) = \mathbf{W}_p^{\mathbf{y}} \otimes \mathbf{W}_{\mathbf{x}}^q$$

for all  $p, q \geq 2$ . A **morphism of matrads** is a map of underlying local prematrads.

**Example 15.** The Bialgebra Matrad  $\mathcal{H}$ . The bialgebra prematrad  $\mathcal{H}^{\text{pre}}$  satisfies  $\Gamma_p^{\mathbf{y}}(M) \otimes \Gamma_{\mathbf{x}}^q(M) = \mathbf{M}_p^{\mathbf{y}} \otimes \mathbf{M}_{\mathbf{x}}^q$  for  $p, q \geq 2$ . Hence  $\mathcal{H}^{\text{pre}}$  is also a matrad, called the bialgebra matrad and henceforth denoted by  $\mathcal{H}$ .

**Example 16.** Continuing Example 12, the inclusions  $(M_{1,*}, \gamma_{\mathbf{M}_1^*}) \subset (M, \gamma_{\mathbf{M}_1^*})$  and  $(M_{*,1}, \gamma_{\mathbf{M}_1^*}) \subset (M, \gamma_{\mathbf{M}_1^*})$  are inclusions of matrads since  $\Gamma_p^{\mathbf{y}}(M, \gamma_{\mathbf{M}_1^*}) \otimes \Gamma_{\mathbf{x}}^q(M, \gamma_{\mathbf{M}_1^*}) = \mathbf{M}_p^{\mathbf{y}} \otimes \mathbf{M}_{\mathbf{x}}^q = 0$  for  $p, q \geq 2$ . In particular, when  $M = F^{\text{pre}}(\Theta)$  and  $\theta_m^n \neq 0$  for all  $m, n \geq 1$ , the free operad  $(\mathcal{A}_{\infty}, \gamma_{\mathbf{M}_1^*})$  embeds in  $(F^{\text{pre}}(\Theta), \gamma_{\mathbf{M}_1^*})$  as a submatrad (c.f. Example 10 and Definition 13 below).

**Example 17.** The Universal Enveloping Functor  $U$ . The universal enveloping PROP  $U$  discussed in Example 9 induces the **universal enveloping functor**  $U$  from the category of matrads to the category of PROPs. Given a matrad  $(M, \gamma_{\mathbf{W}})$ , let  $FP(M)$  be the free PROP generated by  $M$  and let  $J$  be the two-sided ideal generated by the elements  $\bigoplus_{\mathbf{x} \times \mathbf{y}} (\gamma_{\mathbf{W}} - \gamma_{FP}) (\Gamma_p^{\mathbf{y}}(M) \otimes \Gamma_{\mathbf{x}}^q(M))$ . Then  $U(M) = FP(M)/J$ .

**6.2. Free Matrads.** Recall that the domain of the free prematrad  $(M = F^{\text{pre}}(\Theta), \gamma, \eta)$  generated by  $\Theta = \langle \theta_m^n \rangle_{m,n \geq 1}$  is  $\mathbf{V} = M \oplus \bigoplus_{\mathbf{x}, \mathbf{y} \notin \mathbb{N}; s, t \in \mathbb{N}} \mathbf{M}_s^{\mathbf{y}} \oplus \mathbf{M}_{\mathbf{x}}^t$  whose submodules  $M$ ,  $\mathbf{M}_{\mathbf{x}}^1$ , and  $\mathbf{M}_1^{\mathbf{y}}$  are contained in the configuration module  $\Gamma(M)$ . As above, the symbol “ $\cdot$ ” denotes the  $\gamma$  product.

**Definition 13.** Let  $(M = F^{\text{pre}}(\Theta), \gamma, \eta)$  be the free prematrad generated by  $\Theta = \langle \theta_m^n \rangle_{m,n \geq 1}$ , let  $F(\Theta) = \Gamma(M) \cdot \Gamma(M)$ , and let  $\gamma_{F(\Theta)} = \gamma|_{\Gamma(M) \otimes \Gamma(M)}$ . The **free matrad generated by  $\Theta$**  is the triple  $(F(\Theta), \gamma_{F(\Theta)}, \eta)$ .

**Remark 2.** Let  $\omega = \sum \theta_m^n$  and consider the biderivative  $d_\omega$ . Then  $F(\Theta)$  is generated by the components of  $d_\omega \odot d_\omega$  in  $F^{\text{pre}}(\Theta)$  (the admissible fractions). Thus  $\Gamma(F(\Theta), \gamma_{F(\Theta)}) \setminus F(\Theta) = \Gamma(F^{\text{pre}}(\Theta), \gamma_{\mathbf{V}}) \setminus F^{\text{pre}}(\Theta)$  (c.f. Proposition 4).

Let  $\beta \in \mathcal{B}^{\text{pre}}$ . In Subsection 4.3 we constructed the  $r$ -level tree  $\Psi(\beta)$  whose leaves are balanced  $\Theta$ -factorizations; the set  $\mathcal{C}^{\text{pre}} = \{\Psi(\beta) \mid \beta \in \mathcal{B}^{\text{pre}}\}$  indexes the set  $G^{\text{pre}} / \sim$  of module generators of the free prematrad  $F^{\text{pre}}(\Theta)$ . Let  $\mathfrak{G} = F(\Theta) \cap G^{\text{pre}} / \sim$  and let  $\mathcal{B} = \phi(\mathfrak{G})$ . Then

$$\mathcal{C} = \{\Psi(\beta) \mid \beta \in \mathcal{B}\}$$

indexes the set  $\mathfrak{G}$  of module generators of  $F(\Theta)$ .

To establish the relationship between elements of  $\mathfrak{G}$  and cells of  $KK_{n,m}$ , let  $\beta = A_s \cdots A_1 \in \mathcal{B}_{n,m}^{\text{pre}}$  and observe that  $\beta \in \mathcal{B}_{n,m}$  if and only if the tensor monomials along each row and column of  $A_k$  lie in  $\Gamma(F^{\text{pre}}(\Theta))$  for all  $k$  (see (9.7) below). Let

$$\mathcal{C}''_{n,m} = \{\Psi(\beta) \mid \beta = A_s \cdots A_1 \in \mathcal{B}_{n,m} \text{ and either } A_1 \text{ or } A_s \text{ is a } 1 \times 1\};$$

then in particular,  $\mathcal{C}''_{1,m} = \mathcal{C}_{1,m}$  and  $\mathcal{C}''_{n,1} = \mathcal{C}_{n,1}$ . Let  $\mathcal{C}'_{n,m} = \mathcal{C}_{n,m} \setminus \mathcal{C}''_{n,m}$ ; then  $\mathcal{C}_{n,m} = \mathcal{C}'_{n,m} \sqcup \mathcal{C}''_{n,m}$  for each  $m, n \geq 1$ . Elements of  $\mathcal{C}'$  are defined in terms of  $\Delta_P$ ; elements of  $\mathcal{C}''$  are independent of  $\Delta_P$ .

Define the dimension of  $\theta_1^1 = \mathbf{1}$  to be zero and the dimension of  $\theta_m^n$  to be  $m + n - 3$ ; if  $A \in \mathfrak{G}$ , then the dimension of  $A$ , denoted by  $|A|$ , is the sum of the dimensions of the matrix entries in any representative monomial in  $G$ , and in particular, in its balanced factorization in  $\mathcal{B}$ . Clearly, given  $\mathbf{x} \times \mathbf{y} \in \mathbb{N}^{1 \times p} \times \mathbb{N}^{q \times 1}$ , the set  $\{|A| \mid A \in \mathbf{G}_{\mathbf{x}}^{\mathbf{y}}\}$  is bounded and, consequently, has a maximal element. For example, if  $A$  is a monomial in  $\Gamma_s^{\mathbf{y}}(F(\Theta))$  with  $s \geq 2$  and  $\hat{e}_A$  is the corresponding subcomplex of  $\Delta^{(q-1)}(P_{s-1})$ , then  $|A| = \left| \hat{e}_A \right| + |\mathbf{y}| - q$ ; and dually, if  $B$  is a monomial in  $\Gamma_{\mathbf{x}}^t(F(\Theta))$  with  $t \geq 2$  and  $\check{e}_B$  is the corresponding subcomplex of  $\Delta^{(p-1)}(P_{t-1})$ , then  $|B| = \left| \check{e}_B \right| + |\mathbf{x}| - p$ . Consequently,  $\max\{|A| \mid A \in \Gamma_s^{\mathbf{y}}(F(\Theta))\} = |\mathbf{y}| + s - q - 2$  and  $\max\{|B| \mid B \in \Gamma_{\mathbf{x}}^t(F(\Theta))\} = |\mathbf{x}| + t - p - 2$ . In particular, if  $A \in \mathfrak{G}_{n+1, m+1}$  has balanced factorization  $\beta = A_s \cdots A_1$ ,  $1 \leq s \leq m + n$ , then  $\text{codim } A \geq s - 1$  and  $\text{codim } A = s - 1$  if and only if the dimensions of each bisequence matrix  $A_k$  is maximal (see (9.12) below).

Given  $m + n \geq 3$  and  $\mathbf{x} \times \mathbf{y} \in \mathbb{N}^{1 \times p} \times \mathbb{N}^{q \times 1}$  such that  $|\mathbf{x}| = m$  and  $|\mathbf{y}| = n$ , define the codimension 1 face  $e_{(\mathbf{y}, \mathbf{x})} \subset P_{m+n-2}$  as follows: If  $|\mathbf{x}| = m > p \geq 2$ , let  $A_{\mathbf{x}}|B_{\mathbf{x}}$  be the codimension 1 face of  $P_{m-1}$  with leaf sequence  $\mathbf{x}$ ; dually, if  $|\mathbf{y}| = n > q \geq 2$ , let  $A_{\mathbf{y}}|B_{\mathbf{y}}$  be the codimension 1 face of  $P_{n-1}$  with leaf sequence  $\mathbf{y}$ . If  $A = \{a_1, \dots, a_r\} \subset \mathbb{Z}$  and  $z \in \mathbb{Z}$ , define  $-A = \{-a_1, \dots, -a_n\}$  and  $A + z =$

$\{a_1 + z, \dots, a_r + z\}$ ; then set

$$A_1 = \begin{cases} \underline{m-1}, & \text{if } \mathbf{x} = \mathbf{1}^m, m \geq 1 \\ \emptyset, & \text{if } \mathbf{x} = m \geq 2 \\ -A_{\mathbf{x}} + m, & \text{otherwise,} \end{cases} \quad A_2 = \begin{cases} \emptyset, & \text{if } \mathbf{y} = \mathbf{1}^n, n \geq 1 \\ \underline{n-1}, & \text{if } \mathbf{y} = n \geq 2 \\ A_{\mathbf{y}}, & \text{otherwise,} \end{cases}$$

$$B_1 = \begin{cases} \emptyset, & \text{if } \mathbf{x} = \mathbf{1}^m, m \geq 1 \\ \underline{m-1}, & \text{if } \mathbf{x} = m \geq 2 \\ -B_{\mathbf{x}} + m, & \text{otherwise,} \end{cases} \quad B_2 = \begin{cases} \underline{n-1}, & \text{if } \mathbf{y} = \mathbf{1}^n, n \geq 1 \\ \emptyset, & \text{if } \mathbf{y} = n \geq 2 \\ B_{\mathbf{y}}, & \text{otherwise,} \end{cases}$$

and define

$$(6.1) \quad e_{(\mathbf{y}, \mathbf{x})} = A_1 \cup (A_2 + m - 1) | B_1 \cup (B_2 + m - 1).$$

For example,  $e_{(\mathbf{1}^n, \mathbf{1}^m)} = \underline{m-1} | (\underline{n-1} + m - 1)$ ,  $e_{(n, m)} = (\underline{n-1} + m - 1) | \underline{m-1}$ , and  $e_{((21), (21))} = 13 | 24$ .

**Example 18.** *The  $A_\infty$ -bialgebra Matrad  $\mathcal{H}_\infty$ . Let  $\Theta = \langle \theta_m^n \neq 0 \mid \theta_1^1 = \mathbf{1} \rangle_{m, n \geq 1}$ . We say that  $\beta \in \mathcal{B}_{n, m}$  has **word length 2** if  $\beta = C_2 C_1$  for some  $C_2 \times C_1 \in \mathbf{G}_p^{\mathbf{y}} \times \mathbf{G}_x^q$ , where  $\mathbf{x} \times \mathbf{y} \in \mathbb{N}^{1 \times p} \times \mathbb{N}^{q \times 1}$ ,  $|\mathbf{x}| = m$ , and  $|\mathbf{y}| = n$ . Let*

$$\mathcal{A}_p^{\mathbf{y}} \times \mathcal{B}_x^q = \{ \Psi(\beta) \mid \beta \in \mathcal{B}_{n, m} \text{ has word length 2} \}.$$

Denote the corresponding bases of  $\Gamma_x^q(F(\Theta))$  and  $\Gamma_p^{\mathbf{y}}(F(\Theta))$  by  $\{(B_x^q)_\beta\}_{\beta \in \mathcal{B}_x^q}$  and  $\{(A_p^{\mathbf{y}})_\alpha\}_{\alpha \in \mathcal{A}_p^{\mathbf{y}}}$ , respectively. Then  $A_i^j = B_i^j = \theta_i^j$  with  $|\theta_i^j| = i + j - 3$ ;  $B_x^1 = \theta_m^{p, i}$  with  $\mathbf{x} = \mathbf{x}_m^{p, i}$  and  $|B_x^1| = m - 2$ , and  $A_1^{\mathbf{y}} = \theta_{q, j}^n$  with  $\mathbf{y} = \mathbf{y}_{q, j}^n$  and  $|A_1^{\mathbf{y}}| = n - 2$  (c.f. Example 10). In general, for  $p, q \geq 2$ ,  $|(B_x^q)_\beta| = |\mathbf{x}| + q - p - 2$  and  $|(A_p^{\mathbf{y}})_\alpha| = |\mathbf{y}| + p - q - 2$ . Then each  $\hat{e}_{A_\alpha}$  is a subcomplex of  $\Delta^{(q-1)}(P_{p-1})$  with the associated sign  $(-1)^{\epsilon_\alpha}$  and each  $\check{e}_{B_\beta}$  is a subcomplex of  $\Delta^{(p-1)}(P_{q-1})$  with the associated sign  $(-1)^{\epsilon_\beta}$ . Define a differential  $\partial : F(\Theta) \rightarrow F(\Theta)$  of degree  $-1$  as follows: Define  $\partial$  on generators by

$$(6.2) \quad \partial(\theta_m^n) = \sum_{(\alpha, \beta) \in \mathcal{AB}_{m, n}} (-1)^{\epsilon + \epsilon_\alpha + \epsilon_\beta} \gamma [(A_p^{\mathbf{y}})_\alpha; (B_x^q)_\beta],$$

where  $(-1)^\epsilon$  is the standard sign of  $e_{(\mathbf{y}, \mathbf{x})} \subset P_{m+n-2}$ . Extend  $\partial$  as a derivation of  $\gamma$ ; then  $\partial^2 = 0$  follows from the associativity of  $\gamma$ . The DG matrad  $(F(\Theta), \partial)$ , denoted by  $\mathcal{H}_\infty$  and called the  $A_\infty$ -bialgebra matrad, is realized by the biassociahedra  $\{KK_{n, m} \leftrightarrow \theta_m^n\}$  (see Theorem 1 below). One recovers  $\mathcal{A}_\infty$  by restricting  $\partial$  to  $(\mathcal{H}_\infty)_{1, *}$  or  $(\mathcal{H}_\infty)_{*, 1}$ . Note that  $\epsilon = i(m-1)$  in (6.2) gives the sign of the cell  $e_{(\mathbf{y}_p^m, i, \mathbf{1})} = e_{(\mathbf{1}, \mathbf{x}_m^{p, i})} \subset P_{m+p-2}$  (see [12]). This simplifies the standard sign in the differential on  $\mathcal{A}_\infty$  [9].

**Example 19.** For  $\mathbf{x} = (2, 1)$  and  $\mathbf{y} = (1, 1, 1)^T$ , we have  $\mathcal{A}_2^{111} = \{\alpha\}$  and  $\mathcal{B}_{21}^3 = \{\beta_1, \beta_2, \beta_3\}$ . The corresponding bases are

$$A_\alpha = \begin{bmatrix} \theta_2^1 \\ \theta_2^1 \\ \theta_2^1 \end{bmatrix} \quad \text{and} \quad B_{\beta_1} = \left[ \theta_2^3 \quad \begin{bmatrix} \theta_1^1 \\ \theta_1^2 \end{bmatrix} \theta_1^2 \right],$$

$$B_{\beta_2} = \left[ \begin{bmatrix} \theta_2^2 \\ \theta_2^1 \end{bmatrix} [\theta_1^2 \theta_1^2] \quad \theta_1^3 \right], \quad B_{\beta_3} = \left[ \begin{bmatrix} \theta_1^2 \\ \theta_1^1 \end{bmatrix} \theta_2^2 \quad \theta_1^3 \right].$$

Thus,  $\partial(\theta_3^3) = -\gamma(A_\alpha; B_{\beta_1} + B_{\beta_2} + B_{\beta_3}) + \dots$  (see Example 31).

**6.3. The Biderivative.** In [13] we used the canonical prematrad structure  $\gamma$  on the universal PROP  $U_A = \text{End}(TA)$  to define the biderivative operator. By replacing  $U_A$  with an arbitrary prematrad  $(M, \gamma)$  we obtain the general biderivative operator  $Bd_\gamma : \mathbf{M} \rightarrow \mathbf{M}$  having the property  $Bd_\gamma \circ Bd_\gamma = Bd_\gamma$ . An element  $A \in \mathbf{M}$  is a  $\gamma$ -biderivative if  $A = Bd_\gamma(A)$ . Note that  $Bd_\gamma(\mathbf{M}) \subseteq (\Gamma(M), \gamma)$ ; when  $M$  is generated by singletons in each bidegree, the image  $Bd_\gamma(\mathbf{M})$  is the module of fixed points of  $Bd_\gamma$  and gives rise to an algorithmic construction of an additive basis for the  $A_\infty$ -bialgebra matrad  $\mathcal{H}_\infty$ . More precisely:

**Proposition 3.** *Let  $(M, \gamma)$  be a prematrad generated by  $\Theta = \{\theta_m^n\}_{m,n \geq 1}$ , and let  $Bd_\gamma : \mathbf{M} \rightarrow \mathbf{M}$  denote the associated biderivative operator. Then*

- (i)  $Bd_\gamma(\mathbf{M}) \subseteq \Gamma(M, \gamma)$  and  $Bd_\gamma \circ Bd_\gamma = Bd_\gamma$ .
- (ii) Each element  $\theta \in \Theta$  has a unique  $\gamma$ -biderivative  $d_\theta^\gamma \in \mathbf{M}$ .
- (iii)  $\Gamma(M, \gamma) = \langle d_\theta^\gamma \rangle$ .

Thus the  $\gamma$ -biderivative can be viewed as a non-linear map  $d_\theta^\gamma : M \rightarrow \mathbf{M}$ . When  $M = \text{End}(TA)$  we omit the symbol  $\gamma$  and denote the biderivative of  $\theta$  by  $d_\theta$  as in [13].

In particular, the modules  $\langle Bd_\gamma(M_{*,2}) \rangle \subseteq T^+(M_{*,2})$  and  $\langle Bd_\gamma(M_{2,*}) \rangle \subseteq T^+(M_{2,*})$  are spanned by symmetric tensors (compare Example 14); furthermore,  $Bd_\gamma(M_{n,m}) = M_{n,m}$  for  $m, n > 2$ .

Finally, the algorithm that produces  $d_\theta^\gamma$  for  $(M, \gamma) = (F^{\text{pre}}(\Theta), \gamma)$  simultaneously produces an additive basis for  $\mathcal{H}_\infty$ .

**Proposition 4.** *Let  $\Theta = \langle \theta_m^n \neq 0 \rangle_{m,n \geq 1}$  as in Example 18. Elements of the bases  $\{(A_p^\gamma)_\alpha\}_{\alpha \in A_p^\gamma}$  and  $\{(B_x^q)_\beta\}_{\beta \in B_x^q}$  are exactly the components of  $d_\theta^\gamma$  in  $\Gamma_p^\gamma(F(\Theta), \gamma)$  and  $\Gamma_x^q(F(\Theta), \gamma)$  with degrees  $|\mathbf{y}| + p - q - 2$  and  $|\mathbf{x}| + q - p - 2$ , respectively. Thus*

$$\partial(\theta_m^n) = \sum_{\substack{|\mathbf{x}|=m; |\mathbf{y}|=n \\ A \times B \in (d_\theta^\gamma)_p^\gamma \times (d_\theta^\gamma)_x^q}} \gamma(A; B).$$

*Proof.* The proof follows from the definition of  $d_\theta^\gamma$  and is straightforward.  $\square$

**6.3.1. The  $\odot$ -Product.** Given a prematrad  $(M, \gamma)$ , define a (non-bilinear) operation

$$(6.3) \quad \odot : M \times M \xrightarrow{d_\bullet^\gamma \times d_\bullet^\gamma} \mathbf{M} \times \mathbf{M} \xrightarrow{\Upsilon} \mathbf{M} \xrightarrow{\text{proj}} M,$$

where  $\text{proj}$  is the canonical projection. The following facts are now obvious:

**Proposition 5.** *The  $\odot$  operation acts bilinearly on  $M_{*,1}$  and  $M_{1,*}$ . In fact, when  $M = \text{End}(TH)$ , the  $\odot$  operation coincides with Gerstenhaber's  $\circ$ -operation on  $M_{1,*}$  (see [3]) and dually on  $M_{*,1}$ .*

**Remark 3.** *The bilinear part of the  $\odot$  operation, i.e., its restriction to either  $M_{*,1}$  or  $M_{1,*}$ , is completely determined by the associahedra  $K = \sqcup K_n$  (rather than permutahedra) and induces the cellular projection  $\vartheta_0 : P_n \rightarrow K_{n+1}$  due to A. Tonks [18].*

7. THE POSETS  $\mathcal{PP}$  AND  $\mathcal{KK}$ 

In this section we construct a poset  $\mathcal{PP}$  and an appropriate quotient poset  $\mathcal{KK}$ . The elements of  $\mathcal{KK}$  correspond with the 0-dimensional module generators of the free matrad  $\mathcal{H}_\infty$ . The geometric realization of  $\mathcal{KK}$ , constructed in Section 8, is the disjoint union of biassociahedra  $KK = \{KK_{n,m}\}_{m,n \geq 1}$  whose cellular chains are identified with  $\mathcal{H}_\infty$ .

Let  $\mathcal{V}_n$  denote the set of vertices of  $P_n$  and identify  $\mathcal{V}_n$  with the set  $S_n$  of permutations of  $\underline{n} = \{1, 2, \dots, n\}$  via the standard bijection  $\mathcal{V}_n \leftrightarrow S_n$ . The Bruhat partial ordering on  $S_n$  generated by the relation  $a_1 | \dots | a_n < a_1 | \dots | a_i | a_{i+1} | \dots | a_n$  if and only if  $a_i < a_{i+1}$  imposes a poset structure on  $\mathcal{V}_n$ . For  $n \geq 1$ , set  $\mathcal{PP}_{n,0} = \mathcal{PP}_{0,n} = \mathcal{V}_n$  and define the *geometric realization*  $PP_{n,0} = |\mathcal{PP}_{n,0}| = |\mathcal{PP}_{0,n}| = PP_{0,n}$  to be the permutahedron  $P_n$ . Then  $KK_{n+1,1} = |\mathcal{KK}_{n+1,1}| = |\mathcal{KK}_{1,n+1}| = KK_{1,n+1}$  is the Stasheff associahedron  $K_{n+1}$  (see [16], [17], [12]). In the discussion that follows, we construct the posets  $\mathcal{PP}_{n,m}$  and  $\mathcal{KK}_{n+1,m+1}$  and their geometric realizations  $PP_{n,m}$  and  $KK_{n+1,m+1}$  for all  $m, n \geq 1$ .

Denote the sets of up-rooted and down-rooted binary trees with  $n+1$  leaves and  $n$  levels by  $\wedge_n$  and  $\vee_n$ , respectively; then each vertex of  $P_n$  is indexed by two trees, one the reflection of the other. These indexing sets have a poset structure induced by the standard bijections  $\hat{\ell} : \wedge_n \rightarrow \mathcal{V}_n$  and  $\check{\ell} : \vee_n \rightarrow \mathcal{V}_n$ , and the products  $\wedge_m^{\times n}$ ,  $\vee_n^{\times m}$ , and  $\wedge_m^{\times n} \times \vee_n^{\times m}$  are posets with respect to lexicographic ordering. Now consider the subcomplexes  $\Delta^{(n)}(P_m) \subseteq P_m^{\times n+1}$  and  $\Delta^{(m)}(P_n) \subseteq P_n^{\times m+1}$  with faces of  $P_m$  and  $P_n$  indexed by up-rooted and down-rooted PLTs, respectively. Then the 0-skeletons  $X_m^{n+1} \subseteq \Delta^{(n)}(P_m)$  and  $Y_n^{m+1} \subseteq \Delta^{(m)}(P_n)$  are subsets of  $\wedge_m^{\times n+1}$  and  $\vee_n^{\times m+1}$  and there is the inclusion of posets

$$X_m^{n+1} \times Y_n^{m+1} \hookrightarrow \wedge_m^{\times n+1} \times \vee_n^{\times m+1}.$$

Express  $x \in \wedge_m^{\times n}$  as an  $n \times 1$  column matrix of up-rooted binary trees and replace  $x$  with its (unique) BTP  $\Upsilon$ -factorization  $x_1 \cdots x_m \in \overline{\mathbf{M}}$ , where  $x_i$  is an  $n \times i$  matrix over  $\{\mathbf{1}, \lambda\}$  with  $\lambda$  appearing in each row exactly once. Dually, express  $y \in \vee_n^{\times m}$  as a  $1 \times m$  row matrix of down-rooted binary trees and replace  $y$  with its (unique) BTP factorization as a  $\Upsilon$ -product  $y_n \cdots y_1 \in \overline{\mathbf{M}}$ , where  $y_j$  is a  $j \times m$  matrix over  $\{\mathbf{1}, \Upsilon\}$  with  $\Upsilon$  appearing in each column exactly once.

**Example 20.** Whereas the product  $\Delta^{(1)}(P_1) = P_1^{\times 2}$  can be thought of as either  $\lambda \times \lambda$  or  $\Upsilon \times \Upsilon$ , we have

$$X_1^2 = \begin{bmatrix} \lambda \\ \lambda \end{bmatrix} \quad \text{and} \quad Y_1^2 = [\Upsilon \Upsilon] \quad \text{so that} \quad X_1^2 \times Y_1^2 = \begin{bmatrix} \lambda \\ \lambda \end{bmatrix} [\Upsilon \Upsilon].$$

The poset of vertices in  $\Delta^{(1)}(P_2) \subset P_2^{\times 2}$  expresses the following products of permutations and matrix sequences:

$$\begin{aligned} a|b \times c|d & : & 1|2 \times 1|2 & < & 1|2 \times 2|1 & < & 2|1 \times 2|1 \\ X_2^2 & : & \begin{bmatrix} \lambda \\ \lambda \end{bmatrix} \begin{bmatrix} \lambda & \mathbf{1} \\ \lambda & \mathbf{1} \end{bmatrix} & < & \begin{bmatrix} \lambda \\ \lambda \end{bmatrix} \begin{bmatrix} \lambda & \mathbf{1} \\ \mathbf{1} & \lambda \end{bmatrix} & < & \begin{bmatrix} \lambda \\ \lambda \end{bmatrix} \begin{bmatrix} \mathbf{1} & \lambda \\ \mathbf{1} & \lambda \end{bmatrix} \\ Y_2^2 & : & \begin{bmatrix} \Upsilon & \Upsilon \\ \mathbf{1} & \mathbf{1} \end{bmatrix} [\Upsilon \Upsilon] & < & \begin{bmatrix} \Upsilon & \mathbf{1} \\ \mathbf{1} & \Upsilon \end{bmatrix} [\Upsilon \Upsilon] & < & \begin{bmatrix} \mathbf{1} & \mathbf{1} \\ \Upsilon & \Upsilon \end{bmatrix} [\Upsilon \Upsilon] \end{aligned}$$



Furthermore, thinking of the product  $\Delta^{(2)}(P_1) = P_1^{\times 3}$  as  $\Upsilon \times \Upsilon \times \Upsilon$ , we have  $Y_1^3 = [\Upsilon \Upsilon \Upsilon]$ ; consequently  $X_2^2 \times Y_1^3 =$

$$\left\{ \left[ \begin{array}{c} \lambda \\ \lambda \end{array} \right] \left[ \begin{array}{cc} \lambda & \mathbf{1} \\ \lambda & \mathbf{1} \end{array} \right] [\Upsilon \Upsilon \Upsilon] < \left[ \begin{array}{c} \lambda \\ \lambda \end{array} \right] \left[ \begin{array}{cc} \lambda & \mathbf{1} \\ \mathbf{1} & \lambda \end{array} \right] [\Upsilon \Upsilon \Upsilon] < \left[ \begin{array}{c} \lambda \\ \lambda \end{array} \right] \left[ \begin{array}{cc} \mathbf{1} & \lambda \\ \mathbf{1} & \lambda \end{array} \right] [\Upsilon \Upsilon \Upsilon] \right\}.$$

**Definition 14.** Let  $A = [a_{ij}]$  be an  $(n+1) \times m$  matrix over  $\{\mathbf{1}, \lambda\}$ , each row of which contains the entry  $\lambda$  exactly once. Let  $B = [b_{ij}]$  be an  $n \times (m+1)$  matrix over  $\{\mathbf{1}, \Upsilon\}$ , each column of which contains the entry  $\Upsilon$  exactly once. Then  $(A, B)$  is an  $(i, j)$ -**edge pair** if

- (i)  $A \otimes B$  is a BTP,
- (ii)  $a_{ij} = a_{i+1, j} = \lambda$  and  $b_{ij} = b_{i, j+1} = \Upsilon$ .

For  $A_1 \cdots A_m B_n \cdots B_1 \in X_m^{n+1} \times Y_n^{m+1}$ , the only possible edge pair in is  $(A_m, B_n)$ . In  $X_2^3 \times Y_2^3$ , for example, the respective matrix sequences

$$\left[ \begin{array}{c} \lambda \\ \lambda \\ \lambda \end{array} \right] \left[ \begin{array}{cc} \lambda & \mathbf{1} \\ \lambda & \mathbf{1} \\ \lambda & \mathbf{1} \end{array} \right] \left[ \begin{array}{ccc} \Upsilon & \Upsilon & \mathbf{1} \\ \mathbf{1} & \mathbf{1} & \Upsilon \end{array} \right] [\Upsilon \Upsilon \Upsilon] \text{ and } \left[ \begin{array}{c} \lambda \\ \lambda \\ \lambda \end{array} \right] \left[ \begin{array}{cc} \lambda & \mathbf{1} \\ \lambda & \mathbf{1} \\ \lambda & \mathbf{1} \end{array} \right] \left[ \begin{array}{ccc} \Upsilon & \mathbf{1} & \mathbf{1} \\ \mathbf{1} & \Upsilon & \Upsilon \end{array} \right] [\Upsilon \Upsilon \Upsilon]$$

do and do not contain an edge pair.

**Definition 15.** Let  $Q$  be a poset and let  $x_1 \leq x_2 \in Q$ . The pair  $(x_1, x_2)$  is an **edge of  $Q$**  if  $x \in Q$  and  $x_1 \leq x \leq x_2$  implies  $x = x_1$  or  $x = x_2$ .

Edges of  $X_m^{n+1} \times Y_n^{m+1}$  correspond to 1-dimensional elements of  $\mathcal{H}_\infty$  generated by  $\{\mathbf{1}, \theta_2^1, \theta_1^2, \theta_3^1, \theta_1^3\}$ ; 1-dimensional elements of  $\mathcal{H}_\infty$  generated by  $\{\mathbf{1}, \theta_2^1, \theta_1^2, \theta_2^2\}$  correspond to edges of a poset  $Z_{n,m}$  related to but disjoint from  $X_m^{n+1} \times Y_n^{m+1}$ , which we now define.

Let  $A^{i*}$  and  $B^{*j}$  denote the matrices obtained by deleting the  $i^{\text{th}}$  row of  $A$  and the  $j^{\text{th}}$  column of  $B$ .

**Definition 16.** Let  $c = C_1 \cdots C_r$  be a sequence of matrices such that  $(C_k, C_{k+1})$  is an  $(i, j)$ -edge pair for some  $k \leq r-1$  and some association of  $C_1 \cdots (C_k C_{k+1}) \cdots C_r$  defines a sequence of BTPs. The  $(i, j)$ -**transposition of  $c$  in position  $k$**  is the sequence

$$\mathcal{T}_{ij}^k(c) = C_1 \cdots C_{k+1}^{*j} C_k^{i*} \cdots C_r.$$

The symbol  $\mathcal{T}_{ij}^k(c)$  implies that the action of  $\mathcal{T}_{ij}^k$  on  $c$  is defined.

Note that if  $\mathcal{T}_{ij}^k$  acts on  $u = A_1 \cdots A_m B_n \cdots B_1 \in X_m^{n+1} \times Y_n^{m+1}$ , then  $k = m$  and the potential edge pairs of consecutive matrices in

$$\mathcal{T}_{ij}^m(u) = A_1 \cdots A_{m-1} B_n^{*j} A_m^{i*} B_{n-1} \cdots B_1$$

are  $(A_{m-1}, B_n^{*j})$  and  $(A_m^{i*}, B_{n-1})$ . If  $(A_{m-1}, B_n^{*j})$  is an edge pair and  $\mathcal{T}_{kl}^{m-1}$  is defined on  $\mathcal{T}_{ij}^m(u)$ , then

$$\mathcal{T}_{kl}^{m-1} \mathcal{T}_{ij}^m(u) = A_1 \cdots A_{m-2} B_n^{*j*l} A_{m-1}^{k*} A_m^{i*} B_{n-1} \cdots B_1,$$

and so on. In this manner, iterate  $\mathcal{T}$  on each element  $u \in X_m^{n+1} \times Y_n^{m+1}$  in all possible ways and obtain

$$Z_{n,m} = \left\{ \mathcal{T}_{i_t j_t}^{k_t} \cdots \mathcal{T}_{i_1 j_1}^{k_1}(u) \mid u \in X_m^{n+1} \times Y_n^{m+1}, t \geq 1 \right\}.$$

Then

$$\mathcal{PP}_{n,m} = X_m^{n+1} \times Y_n^{m+1} \cup Z_{n,m}.$$

To extend the partial ordering to  $Z_{n,m}$ , first define  $c < \mathcal{T}_{ij}^k(c)$  for  $c \in \mathcal{PP}_{n,m}$ . To define a generating relation on  $Z_{n,m}$ , note that each composition  $\mathcal{T}_{i_t j_t}^{k_t} \cdots \mathcal{T}_{i_1 j_1}^{k_1}$  defined on  $u \in X_m^{n+1} \times Y_n^{m+1}$  uniquely determines an  $(m, n)$ -shuffle  $\sigma$ , in which case we denote

$$\mathcal{T}_\sigma(u) = \mathcal{T}_{i_t j_t}^{k_t} \cdots \mathcal{T}_{i_1 j_1}^{k_1}(u)$$

and define  $\mathcal{T}_{\text{Id}} = \text{Id}$ . When  $\mathcal{T}_\sigma(u)$  is defined, multiple compositions of  $(i, j)$ -transpositions on  $u$  may determine the same  $\sigma$ ; thus  $\mathcal{T}_\sigma(u)$  is a set, in general. For  $u_1 \leq u_2 \in X_m^{n+1} \times Y_n^{m+1}$ , define  $\mathcal{T}_\sigma(u_1) \leq \mathcal{T}_\sigma(u_2)$  if  $(u_1, u_2)$  is an edge of  $X_m^{n+1} \times Y_n^{m+1}$  or  $u_2$  is “ $\sigma$ -compatible” with  $u_1$  in the following sense: Let  $a = a_1 | \cdots | a_m \in S_m$  and  $b = b_1 | \cdots | b_n \in S_n$ . The action of  $\sigma$  on  $(a; b)$  decomposes  $a$  and  $b$  into subsequences  $\mathbf{m}_1, \dots, \mathbf{m}_k$  and  $\mathbf{n}_1, \dots, \mathbf{n}_l$  in one of the following four ways:

$$\sigma(a; b) = \begin{cases} \mathbf{m}_1, \mathbf{n}_1, \mathbf{m}_2, \mathbf{n}_2, \dots, \mathbf{n}_{k-1}, \mathbf{m}_k, & \sigma(a_1) = a_1, \sigma(b_n) \neq b_n \\ \mathbf{m}_1, \mathbf{n}_1, \mathbf{m}_2, \mathbf{n}_2, \dots, \mathbf{m}_k, \mathbf{n}_k, & \sigma(a_1) = a_1, \sigma(b_n) = b_n \\ \mathbf{n}_1, \mathbf{m}_1, \mathbf{n}_2, \mathbf{m}_2, \dots, \mathbf{n}_k, \mathbf{m}_k, & \sigma(a_1) \neq a_1, \sigma(b_n) \neq b_n \\ \mathbf{n}_1, \mathbf{m}_1, \mathbf{n}_2, \mathbf{m}_2, \dots, \mathbf{m}_k, \mathbf{n}_{k+1}, & \sigma(a_1) \neq a_1, \sigma(b_n) = b_n. \end{cases}$$

Define  $\mathbf{I}_\sigma = \{(\alpha_1, \dots, \alpha_{n+1}) \in S_m^{\times n+1} \mid \alpha_i \in S_{\#\mathbf{m}_1} \times \cdots \times S_{\#\mathbf{m}_k} \subset S_m\}$  for all  $i$  and  $\mathbf{J}_\sigma = \{(\beta_1, \dots, \beta_{m+1}) \in S_n^{\times m+1} \mid \beta_j \in S_{\#\mathbf{n}_1} \times \cdots \times S_{\#\mathbf{n}_l} \subset S_n\}$  for all  $j$ . Let  $\chi : \mathcal{V}_m \rightarrow \mathcal{V}_m$  be the involutory bijection defined by

$$\chi(a_1 | \cdots | a_m) = (m+1-a_m) | \cdots | (m+1-a_1)$$

and fix the inclusion of posets

$$(7.1) \quad X_m^{n+1} \times Y_n^{m+1} \xrightarrow{\kappa} \mathcal{V}_m^{\times n+1} \times \mathcal{V}_n^{\times m+1} \leftrightarrow S_m^{\times n+1} \times S_n^{\times m+1},$$

where  $\kappa = (\chi \circ \ell)^{\times n+1} \times (\ell)^{\times m+1}$ . Then  $u_2$  is  $\sigma$ -compatible with  $u_1$  if  $u_2 = (\alpha \times \beta)(u_1)$  for some  $\alpha \times \beta \in \mathbf{I}_\sigma \times \mathbf{J}_\sigma$ .

To view this geometrically, suppose  $u_2 = A'_1 \cdots A'_m B'_n \cdots B'_1$  is  $\sigma$ -compatible with  $u_1 = A_1 \cdots A_m B_n \cdots B_1$  in  $X_m^{n+1} \times Y_n^{m+1}$ . For each  $i$ , let  $a_i = i_1 | \cdots | i_m$  and  $a'_i = i'_1 | \cdots | i'_m$  be the permutations of  $\underline{m}$  corresponding with the up-rooted trees given by  $\gamma$ -products  $A_{i,1} \cdots A_{i,m}$  and  $A'_{i,1} \cdots A'_{i,m}$  of  $i^{\text{th}}$  rows, respectively; dually, for each  $j$ , let  $b_j = j_1 | \cdots | j_n$  and  $b'_j = j'_1 | \cdots | j'_n$  be the permutations of  $\underline{n}$  corresponding with the down-rooted trees given by the  $\gamma$ -products  $B_{n,j} \cdots B_{1,j}$  and  $B'_{n,j} \cdots B'_{1,j}$  of  $j^{\text{th}}$  columns, respectively. Then for each  $(i, j)$ , the  $\sigma$ -partition of  $(a_i; b_j)$  determines a product face  $\mathbf{m}_1 | \cdots | \mathbf{m}_k \times \mathbf{n}_1 | \cdots | \mathbf{n}_l \subset P_m \times P_n$  containing the vertices  $a_i \times b_j$  and  $a'_i \times b'_j$  and an oriented path of edges from  $a_i \times b_j$  to  $a'_i \times b'_j$ .

**Remark 4.**

- (i) The map  $\chi$  used to define the poset structure of  $\mathcal{PP}_{n,m}$  is evoked to induce the correct orientation of the quotient poset  $\mathcal{KK}_{n+1, m+1}$  (see below), and is necessary to establish the bijection in Theorem 1 (see also item (iii) below). For geometric realizations of  $\mathcal{KK}_{n+1, m+1}$  and  $\mathcal{KK}_{m+1, n+1}$  compare Figures 21 and 22.
- (ii) Note that if  $(u_1, u_2)$  is an edge of  $X_m^{n+1} \times Y_n^{m+1}$ , the partial ordering in  $\mathcal{PP}_{n,m}$  implies that  $(\mathcal{T}(u_1), \mathcal{T}(u_2))$  is an edge of  $\mathcal{PP}_{n,m}$ .
- (iii) The transpose map  $X_m^{n+1} \times Y_n^{m+1} \rightarrow X_n^{m+1} \times Y_m^{n+1}$  given by

$$A_1 \cdots A_m B_n \cdots B_1 \mapsto B_1^T \cdots B_n^T A_m^T \cdots A_1^T$$

induces a canonical order-preserving bijection  $\mathcal{PP}_{n,m} \leftrightarrow \mathcal{PP}_{m,n}$ .

**Example 21.** Using the notation of Example 20, let us determine those elements  $u_i \in X_2^2 \times Y_1^3$  that are  $\sigma$ -compatible with  $u_1$ . Since all matrices in  $u_1$  have constant columns or rows,  $a_i \times b_j = 1|2 \times 1 \subset P_2 \times P_1$  for all  $i, j$ . The  $(2, 1)$ -shuffles of  $(1, 2; 3)$  are  $\sigma_0 = 1|2|3$ ,  $\sigma_1 = 1|3|2$  and  $\sigma_2 = 3|1|2$ . The  $\sigma_1$ -partition of  $(1|2; 1)$  determines the face  $1|2 \times 1 \subset P_2 \times P_1$  whose only vertex is  $u_1$ . Hence the only element of  $X_2^2 \times Y_1^3$  that is  $\sigma_1$ -compatible with  $u_1$  is itself. If  $\sigma \in \{\sigma_0, \sigma_2\}$ , the  $\sigma$ -partition of  $(1|2; 1)$  determines the face  $12 \times 1 \subset P_2 \times P_1$  with vertices are  $1|2 \times 1$  and  $2|1 \times 1$ . Since all matrices in  $u_3$  have constant columns or rows,  $a'_i \times b'_j = 2|1 \times 1$  for all  $i, j$  implies that  $u_3$  is  $\sigma$ -compatible with  $u_1$ . Furthermore,  $a'_1 \times b'_j = 1|2 \times 1$  and  $a'_2 \times b'_j = 2|1 \times 1$  for all  $j$  implies that  $u_2$  is also  $\sigma$ -compatible with  $u_1$ . Since  $u_1 < u_3$  we have  $\mathcal{T}_{\sigma_2}(u_1) < \mathcal{T}_{\sigma_2}(u_3)$ .

**Example 22.** Since  $Z_{1,1} = [\gamma][\lambda]$  we have

$$\mathcal{PP}_{1,1} = \left\{ \begin{bmatrix} \lambda \\ \lambda \end{bmatrix} [\gamma\gamma] < [\gamma][\lambda] \right\}.$$

Using the notation of Example 21, the action of  $\mathcal{T}$  on

$$u_1 = \begin{bmatrix} \lambda \\ \lambda \end{bmatrix} \begin{bmatrix} \lambda & \mathbf{1} \\ \lambda & \mathbf{1} \end{bmatrix} [\gamma \ \gamma \ \gamma] \text{ and } u_3 = \begin{bmatrix} \lambda \\ \lambda \end{bmatrix} \begin{bmatrix} \mathbf{1} & \lambda \\ \mathbf{1} & \lambda \end{bmatrix} [\gamma \ \gamma \ \gamma]$$

produces the following four elements of  $Z_{1,2}$ :

$$\begin{aligned} u_1 &\xrightarrow{\mathcal{T}_{\sigma_1}} \begin{bmatrix} \lambda \\ \lambda \end{bmatrix} [\gamma\gamma][\lambda \ \mathbf{1}] \xrightarrow{\mathcal{T}_{\sigma_2}} [\gamma][\lambda][\lambda \ \mathbf{1}]; \\ u_3 &\xrightarrow{\mathcal{T}_{\sigma_1}} \begin{bmatrix} \lambda \\ \lambda \end{bmatrix} [\gamma\gamma][\mathbf{1} \ \lambda] \xrightarrow{\mathcal{T}_{\sigma_2}} [\gamma][\lambda][\mathbf{1} \ \lambda]. \end{aligned}$$

Thus  $\mathcal{PP}_{1,2} = \{u_1 < \mathcal{T}_{\sigma_1}(u_1) < \mathcal{T}_{\sigma_2}(u_1), u_2, u_3 < \mathcal{T}_{\sigma_1}(u_3) < \mathcal{T}_{\sigma_2}(u_3)\}$ . Recall that the action of  $\mathcal{T}$  on  $u_2$  is undefined, and as mentioned in Examples 20 and 21,  $u_1 < u_2 < u_3$  and  $\mathcal{T}_{\sigma_2}(u_1) < \mathcal{T}_{\sigma_2}(u_3)$  (see Figure 12).

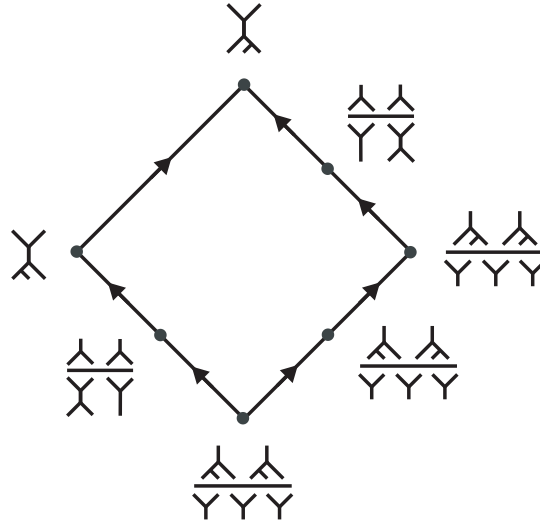

Figure 12. The digraph of  $\mathcal{PP}_{1,2}$ .

One can represent  $u = A_1 \cdots A_m B_n \cdots B_1 \in X_m^{n+1} \times Y_n^{m+1}$  and  $z = \mathcal{T}_\sigma(u) \in Z_{n,m}$  as piecewise linear paths of from  $(m+1, 1)$  to  $(1, n+1)$  in the integer lattice  $\mathbb{N}^2$  with  $m+n$  horizontal and vertical directed components. The arrow  $(i+1, n+1) \rightarrow (i, n+1)$  represents  $A_i$ , while the arrow  $(m+1, j) \rightarrow (m+1, j+1)$  represents  $B_j$ . Consequently,  $u$  is represented by the path  $(m+1, 1) \rightarrow \cdots \rightarrow (m+1, n+1) \rightarrow \cdots \rightarrow (1, n+1)$ , and  $z$  by some other path. In general, if the path  $(r+1, s-1) \rightarrow (r+1, s) \rightarrow (r, s)$  represents the edge pair  $(A'_k, B'_l)$  in  $z$ , the path  $(r+1, s-1) \rightarrow (r, s-1) \rightarrow (r, s)$  represents its transposition  $(B''_l, A''_k)$  in  $\mathcal{T}(z)$  (see Figure 13).

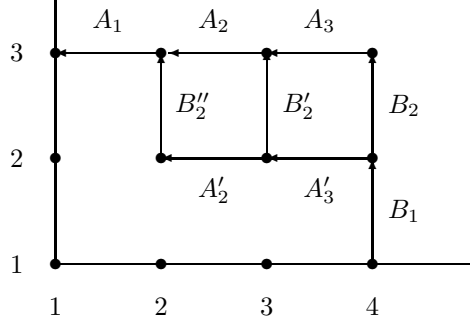

Figure 13.  $A_1 A_2 A_3 B_2 B_1 < A_1 A_2 B'_2 A'_3 B_1 < A_1 B''_2 A'_2 A'_3 B_1$ .

The poset  $\mathcal{KK}$  is a quotient of  $\mathcal{PP}$ , which we now describe. Recall Tonks' projection  $\vartheta_0 : P_m \rightarrow K_{m+1}$  [18]: If  $a$  and  $b$  are faces of  $P_m$ , then  $\vartheta_0(a) = \vartheta_0(b)$  if and only if corresponding PLTs are isomorphic as planar rooted trees (forgetting levels). Define  $a \sim b$  if  $\vartheta_0(a) = \vartheta_0(b)$ . Then  $\tilde{\mathcal{V}}_{m+1} = \vartheta_0(\mathcal{V}_m)$  is the set of vertices of  $K_{m+1}$ . For example,  $3|1|2 = 1|3|2 \in \tilde{\mathcal{V}}_4$ , since  $3|1|2$  and  $1|3|2$  are end points of the degenerate edge  $13|2 \subset P_3$ , and in terms matrix sequences we have  $[\lambda] [\lambda \mathbf{1}] [\mathbf{1} \mathbf{1} \lambda] = [\lambda] [\mathbf{1} \lambda] [\lambda \mathbf{1} \mathbf{1}]$  (and dually  $[\mathbf{1} \mathbf{1} \gamma]^T [\gamma \mathbf{1}]^T [\gamma] = [\gamma \mathbf{1} \mathbf{1}]^T [\mathbf{1} \gamma]^T [\gamma]$ ). Of course,  $\mathcal{V}_1 = \tilde{\mathcal{V}}_2 = [\lambda]$  and  $\mathcal{V}_2 = \tilde{\mathcal{V}}_3 = \{[\lambda] [\lambda \mathbf{1}], [\lambda] [\mathbf{1} \lambda]\}$ .

For matrix sequences in  $X_m^{n+1}$ , define  $x'_1 \cdots x'_m \sim_X x_1 \cdots x_m$  if the trees produced by  $\gamma$ -products of  $i^{\text{th}}$  rows are equivalent for each  $i$ . Dually, for matrix sequences in  $Y_n^{m+1}$ , define  $y'_n \cdots y'_1 \sim_Y y_n \cdots y_1$  if the trees produced by  $\gamma$ -products of  $j^{\text{th}}$  columns are equivalent for each  $j$ . Define  $a \times b \sim c \times d$  in  $X_m^{n+1} \times Y_n^{m+1}$  if  $a \sim_X c$  and  $b \sim_Y d$ . Finally, for  $u_1 \leq u_2 \in X_m^{n+1} \times Y_n^{m+1}$  and  $z_1 = \mathcal{T}_\sigma(u_1) \leq z_2 = \mathcal{T}_\sigma(u_2)$ , define  $z_1 \sim z_2$  if  $u_1 \sim u_2$ . Then

$$\mathcal{KK}_{n+1, m+1} = \mathcal{PP}_{n, m} / \sim ;$$

and  $\vartheta : \mathcal{PP}_{n, m} \rightarrow \mathcal{KK}_{n+1, m+1}$  denotes the projection.

## 8. THE COMBINATORIAL JOIN OF PERMUTAHEDRA

The combinatorial join of permutahedra, which resembles the standard join of spaces, plays an important role in our construction of the biassociahedra to follow. The *combinatorial join*  $P_m *_c P_n$  of permutahedra  $P_m$  and  $P_n$  is the permutahedron  $P_{m+n}$  constructed as follows: Given faces  $A_1 | \cdots | A_k \subseteq P_m$  and  $B_1 | \cdots | B_l \subseteq P_n$ , let  $s$  be an integer such that  $\max\{k, l\} \leq s \leq k+l$ , and let  $(\mathbf{i}; \mathbf{j}) = (i_1 < \cdots < i_k; j_1 < \cdots < j_l)$ , where  $\mathbf{i} \cup \mathbf{j} = \underline{s}$ . Obtain  $A'_1 | \cdots | A'_s$  and  $B'_1 | \cdots | B'_s$  by setting  $A'_{i_r} = A_r$ ,

$B'_{j_t} = B_t$ , and  $A'_i = B'_j = \emptyset$  otherwise. Note that  $(A'_r, B'_r) \neq (\emptyset, \emptyset)$  for all  $r$ . Given a set  $B = \{b_1, \dots, b_k\} \subset \mathbb{N}$  and  $m \in \mathbb{N}$ , define  $B + m = \{b_1 + m, \dots, b_k + m\}$  and consider the codimension  $s - 1$  face  $A_1 | \dots | A_k *_{(\mathbf{i}; \mathbf{j})} B_1 | \dots | B_l = A'_1 \cup (B'_1 + m) | \dots | A'_s \cup (B'_s + m) \subset P_{m+n}$ . When  $s = m + n$ , each pair of vertices  $A_1 | \dots | A_m \times B_1 | \dots | B_n \subset P_m \times P_n$  generates  $\binom{m+n}{m}$  vertices  $A_1 | \dots | A_m *_{(\mathbf{i}; \mathbf{j})} B_1 | \dots | B_n$  of  $P_{m+n}$  as  $(\mathbf{i}; \mathbf{j})$  ranges over all  $(m, n)$ -shuffles of  $(A_1, \dots, A_m; B_1 + m, \dots, B_n + m)$ . Define

$$P_m *_c P_n = \bigcup_{\substack{A_1 | \dots | A_k \times B_1 | \dots | B_l \subset P_m \times P_n \\ \mathbf{i} \cup \mathbf{j} = \underline{s}; \max\{k, l\} \leq s \leq k+l}} A_1 | \dots | A_k *_{(\mathbf{i}; \mathbf{j})} B_1 | \dots | B_l.$$

Thus, given  $m, n \geq 1$  and a cell  $e \subseteq P_{m+n}$ , there is a unique decomposition  $e = A_1 | \dots | A_k *_{(\mathbf{i}; \mathbf{j})} B_1 | \dots | B_l$  with  $A_1 | \dots | A_k \subset P_m$  and  $B_1 | \dots | B_l \subset P_n$ .

**Example 23.** Setting  $s = 2$  produces the 14 codimension 1 faces of  $P_2 *_c P_2 = P_4$  :

$(\mathbf{i}; \mathbf{j})$	$A$	$B$	$A *_{(\mathbf{i}; \mathbf{j})} B$
$(1, 2; 1, 2)$	1 2	1 2	13 24
	1 2	2 1	14 23
	2 1	1 2	23 14
	2 1	2 1	24 13
$(1; 1, 2)$	12	1 2	123 4
	12	2 1	124 3
$(1; 2)$	12	12	12 34

$(\mathbf{i}; \mathbf{j})$	$A$	$B$	$A *_{(\mathbf{i}; \mathbf{j})} B$
$(2; 1, 2)$	12	1 2	3 124
	12	2 1	4 123
$(1, 2; 1)$	1 2	12	134 2
	2 1	12	234 1
$(1, 2; 2)$	1 2	12	1 234
	2 1	12	2 134
$(2; 1)$	12	12	34 12

Fraction products  $a/b$  reappear as combinatorial joins  $a *_c b$  in Step 2 of the construction that follows in the next section.

## 9. CONSTRUCTIONS OF $PP$ AND $KK$

We conclude the paper with constructions of the geometric realizations  $PP = |\mathcal{PP}|$  and  $KK = |\mathcal{KK}|$ . While the edges of  $PP$  and  $KK$  realize the edges of  $\mathcal{PP}$  and  $\mathcal{KK}$ , it is difficult to imagine their higher dimensional faces. Fortunately,  $PP_{n,m}$  is a subdivision of the permutahedron  $P_{m+n}$ , which is a subdivision of  $I^{n+m-1}$ . Thus the higher dimensional combinatorics of  $PP_{n,m}$  are determined by the orientation on the faces of  $I^{m+n-1}$ .

Our construction of  $PP_{n,m}$  has two steps: (1) Perform an “ $(m, n)$ -subdivision” of the codimension 1 cell  $\underline{m} | (\underline{n} + m) \subset P_{m+n}$  and (2) use the  $(m, n)$ -subdivision to subdivide certain other cells of  $P_{m+n}$ . We emphasize that  $\Delta_P$  is used only in step (1) and only in terms of its geometrical definition. Thus the non-coassociativity and non-cocommutativity of  $\Delta_P$  are not in play here (see also Remark 5 below). We begin with some preliminaries.

**9.1. Matrices with constant rows or columns.** Given a set  $Q$  of matrix sequences, let

$$\text{con } Q = \{C_1 \cdots C_s \in Q \mid C_k \text{ has constant rows or constant columns}\}.$$

Note that if  $A_1 \cdots A_m \in \text{con } X_m^{n+1}$ , each  $A_i$  has constant columns; dually, if  $B_n \cdots B_1 \in \text{con } Y_n^{m+1}$ , each  $B_j$  has constant rows. Consequently, the inclusion of posets  $\kappa : X_m^{n+1} \times Y_n^{m+1} \hookrightarrow \mathcal{V}_m^{\times n+1} \times \mathcal{V}_n^{\times m+1}$  given in (7.1) restricts to an order-preserving bijection

$$\left( \chi \circ \hat{\ell} \right) \times \check{\ell} : \text{con} \left( X_m^{n+1} \times Y_n^{m+1} \right) \leftrightarrow \text{con} X_m^{n+1} \times \text{con} Y_n^{m+1}$$

$$(9.1) \quad \leftrightarrow \Delta(\mathcal{V}_m^{\times n+1}) \times \Delta(\mathcal{V}_n^{\times m+1}) \leftrightarrow \mathcal{V}_m \times \mathcal{V}_n,$$

where  $\Delta(\mathcal{V}_m^{\times n+1}) \leftrightarrow \mathcal{V}_m$  is given by the embedding  $\mathcal{V}_m \hookrightarrow \mathcal{V}_m^{\times n+1}$  along the diagonal subposet  $\Delta(\mathcal{V}_m^{\times n+1}) = \{(v, \dots, v) \mid v \in \mathcal{V}_m\}$ . Thus elements of  $\mathcal{V}_m \times \mathcal{V}_n$  may be represented as matrix sequences in  $\text{con}(X_m^{n+1} \times Y_n^{m+1})$ .

Note that  $(i, j)$ -transpositions preserve constant rows and columns, i.e.,  $u \in \text{con}\mathcal{PP}_{n,m}$  if and only if  $\mathcal{T}_{ij}^k(u) \in \text{con}\mathcal{PP}_{n,m}$ . And furthermore, if  $u = A_1 \cdots A_m B_n \cdots B_1 \in \text{con}(X_m^{n+1} \times Y_n^{m+1})$ , and  $\sigma$  is an  $(m, n)$ -shuffle,  $\mathcal{T}_\sigma(u)$  is defined since each  $A_i$  has a constant column of  $\lambda$ 's and each  $B_j$  has a constant row of  $\gamma$ 's. Thus

$$(9.2) \quad \text{con}\mathcal{PP}_{n,m} = \bigcup_{(m,n)\text{-shuffles } \sigma} \mathcal{T}_\sigma(\text{con}(X_m^{n+1} \times Y_n^{m+1})).$$

The order-preserving bijection

$$\text{con}\mathcal{PP}_{1,2} = \mathcal{PP}_{1,2} \setminus \{u_2\} \leftrightarrow \mathcal{V}_3$$

discussed in Example 22 illustrates the following remarkable fact:

**Proposition 6.** *The bijection  $(\chi \circ \hat{\ell}) \times \check{\ell} : \text{con}(X_m^{n+1} \times Y_n^{m+1}) \rightarrow \mathcal{V}_m \times \mathcal{V}_n$  extends to a canonical order-preserving bijection*

$$\kappa_{\#} : \text{con}\mathcal{PP}_{n,m} \rightarrow \mathcal{V}_{m+n}.$$

Thus  $|\kappa_{\#}| : |\text{con}\mathcal{PP}_{n,m}| \xrightarrow{\cong} P_{m+n}$ .

*Proof.* There is the order-preserving bijection  $(\chi \circ \hat{\ell}) \times \check{\ell} : \text{con}(X_m^{n+1} \times Y_n^{m+1}) \leftrightarrow S_m \times S_n$  via the identification  $\mathcal{V}_m \times \mathcal{V}_n \leftrightarrow S_m \times S_n$ . Thus

$$\text{con}\mathcal{PP}_{n,m} \leftrightarrow \{\sigma \circ (\sigma_m \times \sigma_n) \mid \sigma \text{ is an } (m, n)\text{-shuffle; } \sigma_m \times \sigma_n \in S_m \times S_n\}$$

by formula (9.2). But each permutation in  $S_{m+n}$  factors as  $\sigma \circ (\sigma_m \times \sigma_n)$  for some  $(m, n)$ -shuffle  $\sigma$  and some  $\sigma_m \times \sigma_n \in S_m \times S_n$ . Therefore  $(\chi \circ \hat{\ell}) \times \check{\ell}$  extends to  $\kappa_{\#} : \text{con}\mathcal{PP}_{n,m} \leftrightarrow S_{m+n} \leftrightarrow \mathcal{V}_{m+n}$ .  $\square$

**Corollary 1.** *For all  $m, n \geq 1$ , there is the commutative diagram*

$$\begin{array}{ccc} |\text{con}(X_m^{n+1} \times Y_n^{m+1})| & \hookrightarrow & |\text{con}\mathcal{PP}_{n,m}| \\ |\kappa| \downarrow \approx & & \approx \downarrow |\kappa_{\#}| \\ \underline{m} | (\underline{n} + m) & \hookrightarrow & P_{m+n}. \end{array}$$

Note that if  $\chi_{\#} : \mathcal{V}_{m+n} \rightarrow \mathcal{V}_{m+n}$  were induced by the composition  $\mathcal{V}_m \times \mathcal{V}_n \xrightarrow{\chi \times \check{\ell}} \mathcal{V}_m \times \mathcal{V}_n \hookrightarrow \mathcal{V}_{m+n}$  in the same manner as  $\kappa_{\#}$ , then  $\chi_{\#}$  and  $\chi$  would differ on  $\mathcal{V}_{m+n}$  even with  $n = 1$ .

**Example 24.** *Continuing Example 22, the identification  $\text{con}\mathcal{PP}_{1,1} \leftrightarrow \mathcal{V}_2$  is given by*

$$\begin{array}{ccc} \left[ \begin{array}{c} \lambda \\ \lambda \end{array} \right] [\gamma \gamma] & \xrightarrow{\mathcal{T}} & [\gamma] [\lambda] \\ \updownarrow & & \updownarrow \\ 1 | (1 + 1) & \xrightarrow{(1,1)\text{-shuffle}} & 2 | 1. \end{array}$$

The identification  $\text{con}\mathcal{PP}_{1,2} \leftrightarrow \mathcal{V}_3$  :

$$\begin{bmatrix} \lambda \\ \lambda \end{bmatrix} \begin{bmatrix} \lambda \mathbf{1} \\ \lambda \mathbf{1} \end{bmatrix} \leftrightarrow 1|2 \in S_2 \text{ and } [\gamma \gamma \gamma] \leftrightarrow 1 \in S_1$$

so that

$$u_1 = \begin{bmatrix} \lambda \\ \lambda \end{bmatrix} \begin{bmatrix} \lambda \mathbf{1} \\ \lambda \mathbf{1} \end{bmatrix} [\gamma \gamma \gamma] \leftrightarrow 1|2|(1+2) = 1|2|3 \in S_2 \times S_1.$$

Similarly,

$$u_3 = \begin{bmatrix} \lambda \\ \lambda \end{bmatrix} \begin{bmatrix} \mathbf{1} \lambda \\ \mathbf{1} \lambda \end{bmatrix} [\gamma \gamma \gamma] \leftrightarrow 2|1|(1+2) = 2|1|3 \in S_2 \times S_1$$

and we have

$$\begin{array}{ccc} \begin{bmatrix} \lambda \\ \lambda \end{bmatrix} \begin{bmatrix} \lambda \mathbf{1} \\ \lambda \mathbf{1} \end{bmatrix} [\gamma \gamma \gamma] & \xrightarrow{\mathcal{T}_{\sigma_1}} & \begin{bmatrix} \lambda \\ \lambda \end{bmatrix} [\gamma \gamma] [\lambda \mathbf{1}] \xrightarrow{\mathcal{T}_{\sigma_2}} [\gamma][\lambda][\lambda \mathbf{1}] \\ \downarrow & & \downarrow \qquad \qquad \downarrow \\ 1|2|3 & & \underbrace{1|3|2 \qquad \qquad 3|1|2}_{(2,1)\text{-shuffles of } 1|2|3} \end{array}$$

$$\begin{array}{ccc} \begin{bmatrix} \lambda \\ \lambda \end{bmatrix} \begin{bmatrix} \mathbf{1} \lambda \\ \mathbf{1} \lambda \end{bmatrix} [\gamma \gamma \gamma] & \xrightarrow{\mathcal{T}_{\sigma_1}} & \begin{bmatrix} \lambda \\ \lambda \end{bmatrix} [\gamma \gamma] [\mathbf{1} \lambda] \xrightarrow{\mathcal{T}_{\sigma_2}} [\gamma][\lambda][\mathbf{1} \lambda] \\ \downarrow & & \downarrow \qquad \qquad \downarrow \\ 2|1|3 & & \underbrace{2|3|1 \qquad \qquad 3|2|1}_{(2,1)\text{-shuffles of } 2|1|3.} \end{array}$$

The projection  $\vartheta : \text{con}\mathcal{PP}_{n,m} \rightarrow \text{con}\mathcal{PP}_{n,m}/\sim$  has the following simple geometrical interpretation: An element of  $\text{con}(X_m^{n+1} \times Y_n^{m+1})$  is represented as a fraction with multiple copies of the *same* leveled binary tree in the numerator and likewise in the denominator. Two such elements are equivalent if and only if the trees in their numerators or denominators (possibly both) are isomorphic as PRTs. So equivalence in  $\text{con}(X_m^{n+1} \times Y_n^{m+1})$  amounts to forgetting levels as in Tonks' projection. The poset structure then propagates this equivalence to general elements of  $\text{con}\mathcal{PP}_{n,m}$ .

**Remark 5.** *Our constructions are independent of the various choices involved here. If  $\tilde{\Delta}_P^{(k)}$  iterates  $\Delta_P$  on factors other than the those on the extreme left, let  $\tilde{X}_m^{n+1} \times \tilde{Y}_n^{m+1}$  be the poset defined in terms of  $\tilde{\Delta}_P^{(k)}$  and let  $\widetilde{\mathcal{PP}}_{n,m}$  be the poset produced by our construction. Then there is a canonical bijection  $\mathcal{PP}_{n,m} \leftrightarrow \widetilde{\mathcal{PP}}_{n,m}$  and the corresponding geometric realizations are canonically homeomorphic. When  $\Delta_P$  acts on the extreme right, for example, a (combinatorial) isomorphism  $|\mathcal{PP}_{n,m}| \cong |\widetilde{\mathcal{PP}}_{n,m}|$  is evident pictorially: The picture of  $|\mathcal{PP}_{n,m}|$  uses the standard orientation of the interval  $P_2$ , while the picture of  $|\widetilde{\mathcal{PP}}_{n,m}|$  uses the opposite orientation, but nevertheless, these pictures are identical.*

**9.2. Step 1: The  $(m, n)$ -subdivision of  $\underline{m} | (\underline{n} + m)$ .** The first step in our construction of  $PP_{n,m}$  performs an “ $(m, n)$ -subdivision” of the codimension 1 cell  $\underline{m} | (\underline{n} + m) \subset P_{n+m}$ . In Subsection 5.2 we applied the left-iterated diagonal  $\Delta_P^{(n)}$  to construct the  $n$ -subdivision  $P_m^{(n)}$  of  $P_m$ . Since the poset  $X_m^{n+1}$  is the 0-skeleton of  $\Delta^{(n)}(P_m)$ , the geometric realization  $|X_m^{n+1}| = P_m^{(n)}$ , and dually  $|Y_n^{m+1}| = P_n^{(m)}$ . The cellular subdivision  $|X_m^{n+1} \times Y_n^{m+1}| = P_m^{(n)} \times P_n^{(m)}$  of  $\underline{m} | (\underline{n} + m) = P_m \times P_n$  is called the  $(m, n)$ -subdivision of  $\underline{m} | (\underline{n} + m)$ ; thus each cell in this subdivision has a canonical Cartesian product decomposition. The *basic subdivision vertices* of  $PP_{n,m}$  are elements of

$$\mathcal{BS}_{n,m} = (X_m^{n+1} \times Y_n^{m+1}) \setminus \mathcal{V}_{m+n}.$$

Each subdivision cell of  $PP_{n,m}$  is a proper subset of some cell of  $P_{m+n}$  and is the geometric realization of its poset of vertices.

**Example 25.** The 1-subdivision  $P_2^{(1)}$  consists of two 1-cells obtained by subdividing the interval  $P_2$  at its midpoint (see Figure 7). Thus the  $(2, 1)$ -subdivision  $P_2^{(1)} \times P_1^{(2)}$  of the edge  $12|3 \subset P_3$  contains one basic subdivision vertex represented by the midpoint

$$u_2 = \begin{bmatrix} \lambda \\ \lambda \end{bmatrix} \begin{bmatrix} \lambda & \mathbf{1} \\ \mathbf{1} & \lambda \end{bmatrix} [\gamma \ \gamma \ \gamma] \in X_2^2 \times Y_1^3 \setminus \text{con}(X_2^2 \times Y_1^3),$$

and two 1-cells of  $PP_{1,2}$ . In fact,  $PP_{1,2}$  is exactly the heptagon obtained by subdividing  $P_3$  in this way. The 2-subdivision  $P_2^{(2)}$  consists of three 1-cells obtained by subdividing  $P_2$  at its midpoint and again at its three-quarter point. Thus the  $(2, 2)$ -subdivision  $P_2^{(2)} \times P_2^{(2)}$  of the square  $12|34 \subset P_4$  contains twelve basic subdivision vertices and nine 2-cells of  $PP_{2,2}$  as pictured in Figure 14.

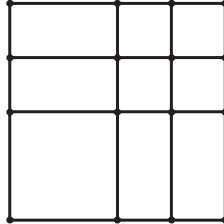

Figure 14. The  $(2, 2)$ -subdivision  $P_2^{(2)} \times P_2^{(2)}$ .

The  $(3, 1)$ -subdivision  $P_3^{(1)} \times P_1^{(3)}$  of the hexagon  $123|4 \subset P_4$  is identified with the 1-subdivision  $P_3^{(1)}$  and contains eleven basic subdivision vertices and eight 2-cells of  $PP_{3,1}$  as pictured in Figure 15.



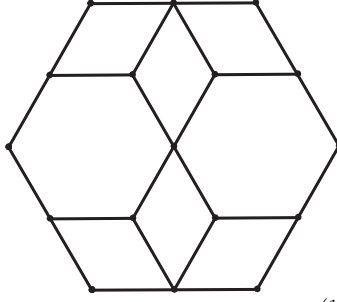

Figure 15. The  $(3, 1)$ -subdivision  $P_3^{(1)} \times P_1^{(3)}$ .

The  $(3, 2)$ -subdivision  $P_3^{(2)} \times P_2^{(3)}$  of the cylinder  $123|45 \subset P_5$ , obtained from  $P_3^{(2)} \times I$  by subdividing along the horizontal cross-sections  $P_3^{(2)} \times \frac{1}{2}$ ,  $P_3^{(2)} \times \frac{3}{4}$ , and  $P_3^{(2)} \times \frac{7}{8}$ , contains 140 basic subdivision vertices and eighty-four 3-cells of  $PP_{3,2}$  ( $P_3^{(2)}$  is pictured in Figure 11).

**9.3. Step 2: Subdividing cells of  $P_{m+n} \setminus \underline{m} | (\underline{n} + m)$ .** Recall that elements of  $Z_{n,m}$  arise from the non-trivial action of  $\mathcal{T}_\sigma$  on  $X_m^{n+1} \times Y_n^{m+1}$ . When  $\sigma$  ranges over all  $(m, n)$ -shuffles (including the identity), we obtain the poset

$$\mathcal{S}_{n,m} = \bigcup_{(m,n)\text{-shuffles } \sigma} \mathcal{T}_\sigma(\mathcal{BS}_{n,m})$$

of subdivision vertices of  $\mathcal{PP}_{n,m}$ . Thus as sets,  $\mathcal{PP}_{n,m} = \text{con } \mathcal{PP}_{n,m} \sqcup \mathcal{S}_{n,m}$ .

The second step of our construction detects those cells of  $P_{m+n} \setminus \underline{m} | (\underline{n} + m)$  that contain subdivision vertices. We refer to such cells as Type I cells; all other cells have Type II. We use the poset structure of subdivision vertices to subdivide Type I cells, and having done so, our construction of  $PP_{n,m}$  will be complete.

To begin, let us characterize those Type I cells of minimal dimension that contain non-basic subdivision vertices. If  $e$  is a cell of some polytope, denote the set of vertices of  $e$  by  $\mathcal{V}_e$ . Given an  $(m, n)$ -shuffle  $\sigma$  and a cell  $e \subset \underline{m} | (\underline{n} + m)$ , let  $\mathcal{T}(\sigma, e)$  denote the cell of  $P_{m+n}$  of minimal dimension such that  $\mathcal{T}_\sigma(\mathcal{V}_e) \subseteq \mathcal{V}_{\mathcal{T}(\sigma, e)}$ . This defines a map

$$\mathcal{T} : \{(m, n)\text{-shuffles}\} \times \{\text{partitions of } \underline{m} | (\underline{n} + m)\} \rightarrow \{\text{partitions of } \underline{m+n}\},$$

which extends the map  $(\sigma, \sigma_m \times \sigma_n) \mapsto \sigma \circ (\sigma_m \times \sigma_n)$  in the proof of Proposition 6. To define  $\mathcal{T}$  at a particular shuffle  $\sigma$  and partition  $e = A_1 | \cdots | A_k | B_1 | \cdots | B_l \subseteq \underline{m} | (\underline{n} + m)$ , remove all block delimiters of  $e$  and think of  $e$  as a permutation of  $\underline{m+n}$  in which  $A_i$  and  $B_j$  are contiguous subsequences. Consider the set  $\{D_1, \dots, D_r\}$  of all contiguous subsequences  $\sigma(A_i)$  and  $\sigma(B_j)$  of  $\sigma(e)$  that preserve the contiguity of the  $B_j$ 's and  $A_i$ 's, respectively, then reinsert block delimiters so that

$$\mathcal{T}(\sigma, e) = C_1 | D_{i_1} | \cdots | C_r | D_{i_r} | C_{r+1}.$$

Since each cell of  $P_{m+n}$  can be expressed uniquely as a component of the combinatorial join  $P_m *_c P_n$ , we have

$$(9.3) \quad \mathcal{T}(\sigma, e) = E *_{(i,j)} F = E'_1 \cup (F'_1 + m) | \cdots | E'_s \cup (F'_s + m),$$

where  $E_i$  and  $F_j$  are the unions of consecutive blocks  $A_{i'} | \cdots | A_{i'+i''}$  and  $B_{j'} | \cdots | B_{j'+j''}$  of  $e$ , respectively. Thus  $\sigma$  acts on the blocks of  $e$  as a  $(k, l)$ -shuffle if and only if  $C_i = \emptyset$  for all  $i$  if and only if  $\mathcal{T}(\sigma, e) = A_1 | \cdots | A_k *_{(i,j)} B_1 | \cdots | B_l$  for

some  $(k, l)$ -unshuffle  $(\mathbf{i}; \mathbf{j}) = (i_1 < \cdots < i_k; j_1 < \cdots < j_l)$  of  $\underline{k+l}$ . Clearly, a cell  $a \subset P_{n+m}$  contains a non-basic subdivision vertex  $\mathcal{T}_\sigma(u)$  if and only if  $a = \mathcal{T}(\sigma, e)$  for some cell  $e \subset \underline{m} | (\underline{n} + m)$  containing a basic subdivision vertex  $u$  on which  $\mathcal{T}_\sigma$  acts non-trivially. In fact,  $a$  contains at most one non-basic subdivision vertex when  $m + n \leq 4$ .

The following proposition incorporates the property of  $\mathcal{T}$  described in Remark 4 and will be applied in our subsequent examination of the poset structure of  $\mathcal{PP}_{n,m}$ .

**Proposition 7.** *If a cell  $e \subset \underline{m} | (\underline{n} + m)$  contains a subdivision cell  $a \subset |X_m^{n+1} \times Y_n^{m+1}|$  and  $\mathcal{T}_\sigma(\mathcal{V}_a) \subset (\mathcal{S}_{n,m} \cap \mathcal{T}(\sigma, e)) \cup \mathcal{V}_{\mathcal{T}(\sigma, e)}$ , then  $|\mathcal{T}_\sigma(\mathcal{V}_a)|$  is a subdivision cell of  $\mathcal{T}(\sigma, e)$  (combinatorially) isomorphic to  $a$ ; in particular, if  $a = a_1 \times a_2$ , then*

$$|\mathcal{T}_\sigma(\mathcal{V}_{a_1 \times a_2})| = |\mathcal{T}_\sigma(\mathcal{V}_{a_1})| \times |\mathcal{T}_\sigma(\mathcal{V}_{a_2})|.$$

*Proof.* Since  $\mathcal{T}_\sigma(u)$  is defined for all  $u \in \mathcal{V}_a$  and  $\mathcal{T}_\sigma$  preserves the poset structure of  $\mathcal{V}_a$ , the cells  $a = |\mathcal{V}_a|$  and  $|\mathcal{T}_\sigma(\mathcal{V}_a)|$  are combinatorially isomorphic.  $\square$

**Example 26.** *The action of  $\mathcal{T}$  on the four vertices of  $12|34$  partitions the 24 vertices of  $P_4$  into four mutually disjoint sets of six vertices each. The vertices  $v_1 = 1|2|3|4$  and  $v_2 = 1|2|4|3$  of edge  $e = 1|2|34$  correspond respectively to*

$$\begin{bmatrix} \lambda \\ \lambda \\ \lambda \end{bmatrix} \begin{bmatrix} \lambda & \mathbf{1} \\ \lambda & \mathbf{1} \\ \lambda & \mathbf{1} \end{bmatrix} \begin{bmatrix} \gamma & \gamma & \gamma \\ \mathbf{1} & \mathbf{1} & \mathbf{1} \end{bmatrix} [\gamma \gamma \gamma] \text{ and } \begin{bmatrix} \lambda \\ \lambda \\ \lambda \end{bmatrix} \begin{bmatrix} \lambda & \mathbf{1} \\ \lambda & \mathbf{1} \\ \lambda & \mathbf{1} \end{bmatrix} \begin{bmatrix} \mathbf{1} & \mathbf{1} & \mathbf{1} \\ \gamma & \gamma & \gamma \end{bmatrix} [\gamma \gamma \gamma].$$

*There are two basic subdivision vertices  $u_1$  and  $u_2$  along  $e$ , exactly one of which admits a non-trivial action of  $\mathcal{T}$ , namely,*

$$u_1 = \begin{bmatrix} \lambda \\ \lambda \\ \lambda \end{bmatrix} \begin{bmatrix} \lambda & \mathbf{1} \\ \lambda & \mathbf{1} \\ \lambda & \mathbf{1} \end{bmatrix} \begin{bmatrix} \gamma & \gamma & \mathbf{1} \\ \mathbf{1} & \mathbf{1} & \gamma \end{bmatrix} [\gamma \gamma \gamma]$$

$$\begin{array}{l} u_1 \quad \mathcal{T}_{\sigma_1} = \mathcal{T}_{11}^2 \quad \longrightarrow \quad z_1 = \begin{bmatrix} \lambda \\ \lambda \\ \lambda \end{bmatrix} \begin{bmatrix} \gamma & \mathbf{1} \\ \mathbf{1} & \gamma \end{bmatrix} \begin{bmatrix} \lambda & \mathbf{1} \\ \lambda & \mathbf{1} \end{bmatrix} [\gamma \gamma \gamma] \\ \quad \mathcal{T}_{\sigma_2} \searrow \quad \quad \quad \quad \quad \quad \quad \downarrow \mathcal{T}_{11}^3 \\ \quad \quad \quad \quad \quad \quad \quad \quad \quad \quad \quad \quad \quad \quad \quad \quad z_2 = \begin{bmatrix} \lambda \\ \lambda \\ \lambda \end{bmatrix} \begin{bmatrix} \gamma & \mathbf{1} \\ \mathbf{1} & \gamma \end{bmatrix} [\gamma \gamma] [\lambda \mathbf{1}]. \end{array}$$

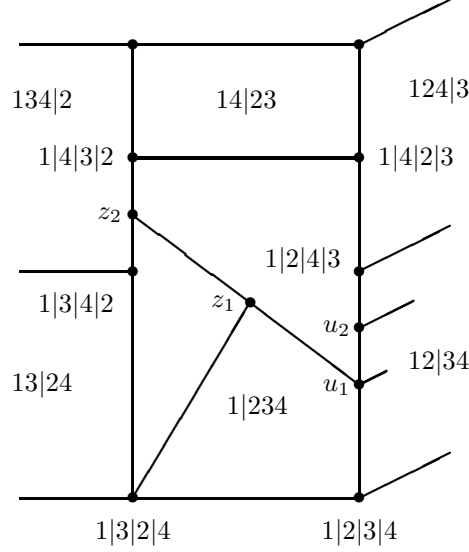

Figure 16. The subdivision of  $1|234$  in  $PP_{3,3}$ .

To physically position  $z_1$  and  $z_2$ , first note that  $\mathcal{T}_{\sigma_1}(\mathcal{V}_e) = \{\mathcal{T}_{\sigma_1}(v_1) = 1|3|2|4, \mathcal{T}_{\sigma_1}(v_2) = 1|4|2|3\}$  and  $\mathcal{T}_{\sigma_2}(\mathcal{V}_e) = \{\mathcal{T}_{\sigma_2}(v_1) = 1|3|4|2, \mathcal{T}_{\sigma_2}(v_2) = 1|4|3|2\}$ . Now  $e = A_1|A_2|B_1 = 1|2|34$  and  $\sigma_1(e) = 1324$ ; thus  $\sigma_1(B_1)$  is not contiguous in  $\sigma_1(e)$  and  $\sigma_1(A_2)$  breaks the contiguity of  $B_1$  in  $\sigma_1(e)$ . Thus  $D_1 = \sigma_1(A_1)$  and  $\mathcal{T}(\sigma_1, e) = 1|234$ . On the other hand,  $\sigma_2(e) = 1342$ ; in this case  $\mathcal{T}(\sigma_2, e) = 1|34|2$  since  $\sigma_2$  acts on the blocks of  $e$  as a  $(2, 1)$ -shuffle. Consequently, we represent the vertices  $z_1$  and  $z_2$  as interior points of the faces  $1|234$  and  $1|34|2$ , respectively. To complete the subdivision of  $1|234$ , use the poset structure to construct new edges from  $u_1$  to  $z_1$  and from  $z_1$  to  $z_2$ , and apply Proposition 7 to the subdivision cell  $a = (v_1, u_1) \subset e$  to construct the edge  $|\mathcal{T}_{\sigma_1}(\mathcal{V}_a)|$  from  $1|3|2|4$  to  $z_1$ . Then  $1|234 = d_1 \cup d_2 \cup d_3$  in which  $\mathcal{V}_{d_1} = \{u_1, u_2, v_2, \mathcal{T}_{\sigma_1}(v_2), \mathcal{T}_{\sigma_2}(v_2), z_2, z_1\}$ ,  $\mathcal{V}_{d_2} = \{u_1, v_1, \mathcal{T}_{\sigma_1}(v_1), z_1\}$ , and  $\mathcal{V}_{d_3} = \{\mathcal{T}_{\sigma_1}(v_1), \mathcal{T}_{\sigma_2}(v_1), z_2, z_1\}$  (see Figure 16 and Example 27). An algebraic interpretation of these cells appears in the discussion of  $KK_{3,3}$  following Theorem 1.

**9.4. PP-factorization of proper cells.** Recall that an element of  $\mathcal{PP}_{n,m}$  is assigned to a unique directed piece-wise linear path from  $(m+1, 1)$  to  $(1, n+1)$  in  $\mathbb{N}^2$  with  $m+n$  components of unit length (see Figure 13). Let  $\Pi_{n,m}$  denote the set of all such paths and consider the map  $\pi : \mathcal{PP}_{n,m} \rightarrow \Pi_{n,m}$ . If  $u \in \text{con}(X_m^{n+1} \times Y_n^{m+1})$ , i.e.,  $u$  is a vertex of  $\underline{m} | (\underline{n} + m)$ , then  $\pi$  restricts to a bijection  $\{\mathcal{T}_\sigma(u) \mid (m, n)\text{-shuffles } \sigma\} \leftrightarrow \Pi_{n,m}$ , and in view of Proposition 6,  $\pi$  assigns each vertex of  $P_{m+n}$  to a path in  $\Pi_{n,m}$  albeit non-injectively.

Now consider a proper cell  $c = C_1 | \dots | C_s \subset |\text{con}\mathcal{PP}_{n,m}| \leftrightarrow P_{m+n}$ . Each factor  $C_t$  is a permutahedron  $P_{m_t+n_t}$  whose vertices are assigned to connected subpaths of paths in  $\Pi_{n,m}$ . Assign  $c$  to a directed piece-wise linear path  $\varepsilon_c = \cup \varepsilon_t$  in the

following way: Write  $c = E_1 | \cdots | E_f *_{(i;j)} F_1 | \cdots | F_g$  and obtain sequences

$$(9.4) \quad \gamma = \{m+1 = \gamma_0 > \cdots > \gamma_f = 1\} \quad \text{and} \quad \delta = \{1 = \delta_0 < \cdots < \delta_g = n+1\},$$

where  $\gamma_{i+1} = \gamma_i - \#E_{f-i}$  and  $\delta_{j+1} = \delta_j + \#F_{g-j}$ , and assign  $C_t = E'_t \cup (F'_t + m)$  to the path

- (1)  $\varepsilon_t : (\gamma_{t'-1}, n+1-j) \rightarrow (\gamma_{t'}, n+1-j)$ , if  $C_t = E_{\gamma_{t'}}$  for some  $t'$  and maximal  $j$  such that  $F'_{s_1}, \dots, F'_{s_j} \neq \emptyset$  and  $s_1 < \cdots < s_j < t$ ;
- (2)  $\varepsilon_t : (i, \delta_{t'}) \rightarrow (i, \delta_{t'+1})$ , if  $C_t = F_{\delta_{t'}} + m$  for some  $t'$  and maximal  $i$  such that  $E'_{s_1}, \dots, E'_{s_i} \neq \emptyset$  and  $s_1 < \cdots < s_i < t$ ;
- (3)  $\varepsilon_t : (\gamma_i, \delta_j) \rightarrow (\gamma_{i+1}, \delta_{j+1})$ , if  $C_t = E_{\gamma_i} \cup (F_{\delta_j} + m)$  with  $E_{\gamma_i}, F_{\delta_j} \neq \emptyset$  for some  $i, j$ .

In particular, a cell  $a = A_1 \cdots A_k B_l \cdots B_1 \subset |\text{con}(X_m^{n+1} \times Y_n^{m+1})| \leftrightarrow \underline{m} | \underline{n} + m$  is assigned to the path

$$\varepsilon_a : (m+1, \beta_0) \xrightarrow{B_1} \cdots \xrightarrow{B_l} (m+1, \beta_l) \xrightarrow{A_k} (\alpha_1, n+1) \xrightarrow{A_{k-1}} \cdots \xrightarrow{A_1} (\alpha_k, n+1),$$

where  $\alpha = \{m+1 = \alpha_0 > \cdots > \alpha_k = 1\}$  and  $\beta = \{1 = \beta_0 < \cdots < \beta_l = n+1\}$  (case (3) does not occur). Thus if  $c = \mathcal{T}(\sigma, a)$ , the observation in (9.3) implies that  $\gamma \subseteq \alpha$  and  $\delta \subseteq \beta$ .

Given a subdivision cell  $d \subseteq \mathcal{T}(\sigma, a)$ , there is a subdivision subcomplex  $u \subset a$  such that  $d = |\mathcal{T}_\sigma(\mathcal{V}_u)|$ . Representing  $a$  as a partition  $U_1 | \cdots | U_s$  of  $\underline{m} | \underline{n} + m$ , there is a Cartesian product decomposition  $d = D_1 \times \cdots \times D_s$  in which  $D_t$  is a subdivision cell of  $\mathcal{T}(\sigma, U_t)$ . The representation  $U_1 | \cdots | U_s = E *_{(i;j)} F$  relates the paths associated with the vertices of  $\mathcal{T}(\sigma, U_t)$  to the vertices of  $D_t$ , and in view of case (3) above, the vertices of  $D_t$  are assigned to paths related to those  $z \in \mathcal{T}_\sigma(\mathcal{V}_u)$  given by the action of  $\mathcal{T}_\sigma$  on the matrix sequences  $x_{\gamma_{i+1}} \cdots x_{\gamma_{i-1}} y_{\delta_{j+1}-1} \cdots y_{\delta_j}$  associated with the vertices of  $u$  as a  $(\gamma_i - \gamma_{i+1}, \delta_{j+1} - \delta_j)$ -shuffle. But in every case, there is the Cartesian product decomposition

$$D_t = (e_{y_1^t, x_1^t} \times \cdots \times e_{y_1^t, x_{p_t}^t}) \times \cdots \times (e_{y_{q_t}^t, x_1^t} \times \cdots \times e_{y_{q_t}^t, x_{p_t}^t}),$$

where  $e_{y_j^t, x_i^t}$  is some cell of  $PP_{y_j^t, x_i^t}$  and  $(p_t, q_t) \in \{(\gamma_{t'}, n+1-j), (i, \delta_{t'}), (\gamma_{i+1}, \delta_j)\}$ ,  $p_1 + \cdots + p_t \in \{\gamma_{t'-1}, i, \gamma_i\}$ , and  $q_1 + \cdots + q_t \in \{n+1-j, \delta_{t'+1}, \delta_{j+1}\}$  (Cartesian product decomposition of  $D_t$  is trivial whenever  $m=1$  or  $n=1$ ). Therefore every proper cell  $e_{n,m} \subset PP_{n,m}$  has a *Cartesian matrix factorization*

$$(9.5) \quad e_{n,m} = [(e_{y_1^1, x_1^1} \times \cdots \times e_{y_1^1, x_{p_k}^1}) \times \cdots \times (e_{y_{q_k}^1, x_1^1} \times \cdots \times e_{y_{q_k}^1, x_{p_k}^1})] \times \cdots \\ \times [(e_{y_1^s, x_1^s} \times \cdots \times e_{y_1^s, x_{p_k}^s}) \times \cdots \times (e_{y_{q_k}^s, x_1^s} \times \cdots \times e_{y_{q_k}^s, x_{p_k}^s})],$$

where  $p_1 = q_s = 1$  and  $s \geq 2$ . The decomposition in (9.5) is a *PP-factorization* if each factor  $e_{y_j^k, x_i^k}$  lies in the family *PP*.

Indeed, each factor  $e_{y_j^k, x_i^k}$  of  $e_{n,m}$  has a Cartesian matrix factorization with  $x_i^k + y_j^k < m+n$ , and we may inductively apply the decomposition in (9.5) to obtain a decomposition of  $e_{n,m}$  as a Cartesian product of polytopes in the family *PP*. This decomposition involves Cartesian products in two settings: Those within bracketed quantities correspond to tensor products of entries in a bisequence monomial (controlled by  $\Delta_P^{(k)}$ ) and those between bracketed quantities correspond to  $\Upsilon$ -products of bisequence monomials. And indeed, this decomposition is encoded by a leveled tree  $\Psi(e_{n,m})$  constructed in the same way we constructed  $\Psi(\phi(\xi))$  for  $\xi \in \mathfrak{G}$ .

Whereas the levels and the leaves of  $\Psi(\phi(\xi))$  are bisequence and  $\Theta$ -factorizations, the levels and leaves of  $\Psi(e_{n,m})$  are Cartesian matrix and  $PP$ -factorizations.

**Example 27.** Refer to Example 26 and consider the codimension 1 cell  $c = C_1|C_2 = 1|234 \subset P_{2+2}$ . Write  $c = E_1|E_2 * F_1 = 1|2 * 12$  and obtain  $\gamma_0 = 3$ ,  $\gamma_1 = 2$ ,  $\gamma_2 = 1$ ; and  $\delta_0 = 1$ ,  $\delta_1 = 3$ . Then  $C_1 = E'_1 \cup F'_1 = E_1 \cup \emptyset$  and  $C_2 = E'_2 \cup (F'_2 + 2) = E_2 \cup (F_1 + 2)$ . The path  $C_1$  is assigned to the path component  $\varepsilon_1 : (2, 3) \rightarrow (1, 3)$  and  $C_2$  is assigned to  $\varepsilon_2 : (3, 1) \rightarrow (2, 3)$ ; in this case there is the action of a  $(\gamma_0 - \gamma_1, \delta_1 - \delta_0) = (1, 2)$ -shuffle on  $x_{\gamma_0-1}y_{\delta_1-1}y_{\delta_0} = x_2y_2y_1$ , which generates (classes of) vertices of  $C_2$ . Let  $u$  be the subdivision subcomplex of  $1|2|34$  consisting of the two edges  $(u_1, u_2)$  and  $(u_2, v_2)$  (see Figure 16). Then for  $i = 1, 2, 3$ , the subdivision cell  $d_i = D_1^i \times D_2^i$ , where  $D_1^i = C_1 = P_1$  is a vertex and  $D_2^i \subset C_2$  has the form  $D_2^i = e_{3,2}^i \times e_{3,1}^i$ , where  $(\dim e_{3,2}^1, \dim e_{3,1}^1) = (2, 0)$  and  $(\dim e_{3,2}^2, \dim e_{3,1}^2) = (1, 1)$  ( $e_{3,2}^1 = PP_{2,1}$  is a heptagon and  $e_{3,1}^1$  is a vertex of  $PP_{2,0}$ ;  $e_{3,2}^2$  is an edge of  $PP_{2,1}$  and  $e_{3,1}^2 = PP_{2,0}$  for  $i = 2, 3$ ). Thus up to homeomorphism we have

$$\begin{aligned} d_1 &= [PP_{0,1} \times PP_{0,1} \times PP_{0,1}] \times [PP_{2,1} \times (PP_{1,0} \times PP_{1,0})] \\ d_2 &= [PP_{0,1} \times PP_{0,1} \times PP_{0,1}] \times [(PP_{1,1} \times PP_{1,0}) \times PP_{2,0}] \\ d_3 &= [PP_{0,1} \times PP_{0,1} \times PP_{0,1}] \times [(PP_{1,0} \times PP_{1,1}) \times PP_{2,0}]. \end{aligned}$$

**9.5. The projection  $\vartheta\vartheta : PP \rightarrow KK$ .** The final piece of our construction establishes a geometric interpretation of the projection  $\vartheta\vartheta : PP_{m,n} \rightarrow KK_{n+1,m+1}$  induced by the quotient map  $\mathcal{PP}_{n,m} \rightarrow \mathcal{KK}_{n+1,m+1}$ . Let  $\mathcal{P}_{n,m} = \text{con}\mathcal{PP}_{n,m}$ ,  $P_{n,m} = |\mathcal{P}_{n,m}|$ , and  $K_{n+1,m+1} = |\mathcal{P}_{n,m}/\sim|$ ; we obtain  $KK_{n+1,m+1}$  as the subdivision of  $K_{n+1,m+1}$  that commutes the following diagram:

$$\begin{array}{ccc} PP_{n,m} & \xrightarrow{\cong} & P_{m+n} \\ \vartheta\vartheta \downarrow & & \downarrow \vartheta \\ KK_{n+1,m+1} & \xrightarrow[\cong]{} & K_{n+1,m+1} \end{array}$$

(the horizontal maps are non-cellular homeomorphisms induced by the subdivision process). We identify the cellular chains  $C_*(KK)$  with the free matrad  $\mathcal{H}_\infty$  and prove that the restriction of the free resolution of prematrads  $\rho^{\text{pre}} : F^{\text{pre}}(\Theta) \rightarrow \mathcal{H}$  to  $\mathcal{H}_\infty$  is a free resolution in the category of matrads.

To simplify notation, we suppress the subscripts of  $\vartheta_{n,m} : P_{n,m} \rightarrow K_{n+1,m+1}$  when  $m$  and  $n$  are clear from context. Since  $|\mathcal{P}_{n,m}| = P_{n,m} = P_{m+n}$ , a proper face  $e \subset P_{n,m}$  is a product of permutahedra

$$e = P_{n_1,m_1} \times \cdots \times P_{n_s,m_s}$$

and projects to a product

$$\tilde{e} = \vartheta(e) = \vartheta(P_{n_1,m_1}) \times \cdots \times \vartheta(P_{n_s,m_s}) = K_{n_1+1,m_1+1} \times \cdots \times K_{n_s+1,m_s+1}.$$

The fact that  $\vartheta_{n,m} = \text{Id}$  when  $1 \leq m, n \leq 2$  implies  $K_{n+1,m+1} = P_{m+n}$ ; also,  $K_{n,2} \cong K_{2,n}$  is the multiplihedron  $J_n$  for all  $n$  (see [17], [4], [12], [14]). The faces  $24|13$  and  $1|24|3$  of  $P_{3,1}$  are degenerate in  $K_{4,2}$  since  $\vartheta_{3,1}(24|13) = 24|1|3$  and  $\vartheta_{3,1}(1|24|3) = 1|2|4|3$ ; and dually, the faces  $24|13$  and  $2|13|4$  of  $P_{1,3}$  are degenerate in  $KK_{2,4}$  since  $\vartheta_{1,3}(24|13) = 2|4|1|3$  and  $\vartheta_{1,3}(2|13|4) = 2|1|3|4$ . Observe that the product cell  $K_{m+1} \times K_{n+1} = \vartheta(P_m \times P_n) \subset \vartheta(P_{m+n}) = \vartheta(P_{n,m}) =$

$K_{n+1,m+1}$  admits the  $(m,n)$ -subdivision  $K_{m+1}^{(n)} \times K_{n+1}^{(m)} = \vartheta\vartheta(P_m^{(n)} \times P_n^{(m)}) \subset \vartheta\vartheta(PP_{n,m}) = KK_{n+1,m+1}$ .

**Example 28.** The  $(2,2)$ -subdivision  $K_3^{(2)} \times K_3^{(2)}$  of the face  $\vartheta_{2,2}(12|34) = K_3 \times K_3 \subset K_{3,3}$  produces 9 cells of  $KK_{3,3}$  (see Figures 14 and 20); the  $(3,1)$ -subdivision  $K_2^{(3)} \times K_4^{(1)}$  of the face  $\vartheta_{1,3}(1|234) = K_2 \times K_4 \subset K_{4,2}$  produces 6 cells of  $KK_{4,2}$  (see Figures 3 and 21).

Define

$$\widetilde{\mathcal{BS}}_{n+1,m+1} = (\vartheta_* \times \vartheta_*)(\mathcal{BS}_{n,m}).$$

**Example 29.** The biassociahedron  $KK_{3,3} = PP_{2,2}$  and has 44 vertices, 16 of which lie in  $12|34$ . Of these 16 vertices, 4 lie in  $\mathcal{P}_{2,2}$  and generate the other 19 vertices of  $K_{3,3} = P_4$ ; another 4 lie  $\widetilde{\mathcal{BS}}_{3,3}$  and generate the 8 remaining vertices of  $KK_{3,3}$  (see Figure 20). By contrast,  $KK_{4,2}$  is a non-trivial quotient of  $PP_{3,1}$ . As in Tonks' projection  $\vartheta_0 : P_n \rightarrow K_{n+1}$ , we identify faces of  $PP_{3,1}$  indexed by isomorphic graphs (forgetting levels) as pictured in Figure 17. Here an equivalence class of graphs, which labels a face of the target interval, contains the three graphs horizontally to its left.

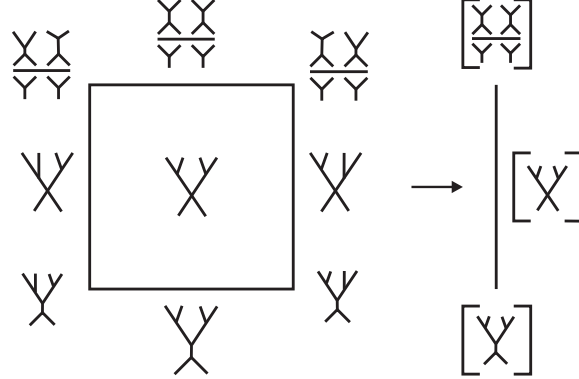

Figure 17: Projection of a degenerate square in  $PP_{3,1}$  to  $KK_{4,2}$ .

The biassociahedra  $KK_{1,1}$ ,  $KK_{2,1}$  and  $KK_{1,2}$  are isolated vertices and correspond to the free matrad generators  $\mathbf{1}$ ,  $\theta_1^2$  and  $\theta_2^1$ , respectively. The biassociahedra  $KK_{n,m}$  with  $4 \leq m+n \leq 6$  are pictured in Figures 18 through 22 below and labelled by partitions and (co)derivation leaf sequences. Note that  $KK_{n,m} \cong KK_{m,n}$  for all  $m, n \geq 1$  and  $KK_{2,m}$  is a subdivision of  $J_m$  when  $m \geq 3$ .

If  $\tilde{e}_{n,m}$  is a proper face of  $KK_{n,m}$ , the decomposition in (9.5) induces a product decomposition of the form

$$(9.6) \quad \tilde{e}_{n,m} = [(\tilde{e}_{y_1^1, x_1^1} \times \cdots \times \tilde{e}_{y_{p_k}^1, x_{p_k}^1}) \times \cdots \times (\tilde{e}_{y_{q_k}^1, x_1^1} \times \cdots \times \tilde{e}_{y_{q_k}^1, x_{p_k}^1})] \\ \times \cdots \times [(\tilde{e}_{y_1^s, x_1^s} \times \cdots \times \tilde{e}_{y_1^s, x_{p_k}^s}) \times \cdots \times (\tilde{e}_{y_{q_k}^s, x_1^s} \times \cdots \times \tilde{e}_{y_{q_k}^s, x_{p_k}^s})],$$

where  $p_1 = q_s = 1$  and  $s \geq 2$ . Here “ $\times$ ” within a bracketed quantity corresponds to the tensor product in a bisequence monomial (controlled by certain iterations of  $\Delta_P$  and the product cell within  $k^{\text{th}}$  bracket is thought of as a subdivision cell of  $K_{n_k+1, m_k+1}$  in the decomposition of  $e_{n,m}$  in (9.5)) and “ $\times$ ” between bracketed quantities corresponds to a  $\Upsilon$ -product, and each  $\tilde{e}_{y_j^k, x_i^k}$  has the form given by (9.6) with  $x_i^k + y_j^k < m+n$ .

We distinguish between two kinds of faces in (9.6). A Type I face is detected by the diagonal  $\Delta_P$  and its representation in (9.6) has  $(p_k, q_k) > (1, 1)$  for all  $k$ ; thus  $\Delta_P$  is only involved in forming the Cartesian products in parentheses. A Type II face  $\tilde{e}_{n,m}$  is independent of  $\Delta_P$  and its representation in (9.6) satisfies  $(p_k, q_k) = (1, 1)$  for all  $k$ ; thus  $\tilde{e}_{n,m}$  has the form  $KK_{n,i_2} \times K_{i_2-i_1+1} \times \cdots \times K_{i_s-i_{s-1}+1}$ ,  $1 \leq i_2 < \cdots < i_s = m$ , or  $K_{j_0-j_1+1} \times \cdots \times K_{j_{s-2}-j_{s-1}+1} \times KK_{j_{s-1},m}$ ,  $1 \leq j_{s-1} < \cdots < j_0 = n$ . In particular, a codimension 1 face (when  $s = 2$ ) has the form  $KK_{n,i} \times K_{m+1-i}$  or  $K_{n+1-j} \times KK_{j,m}$ . Consequently, each cell  $\tilde{e}_{n,m} \subset KK_{n,m}$  is associated with a levelled tree  $\Psi(\tilde{e}_{n,m})$ , whose levels are representations given by (9.6) and whose leaves are  $KK$ -factorizations.

The assignment  $\iota : \theta_p^q \mapsto KK_{q,p}$ , which preserves levels, induces a set map

$$(9.7) \quad \iota : \mathfrak{G}_{n,m} \rightarrow \{\text{faces of } KK_{n,m}\}$$

that sends balanced factorizations to Cartesian matrix factorizations and has the following properties:

- (i) The restriction of  $\iota$  to 0-dimensional module generators of  $F_{n,m}(\Theta)$  establishes a bijection with vertices of  $KK_{n,m}$  by replacing  $\theta_2^1$  with  $\wedge$  and  $\theta_1^2$  with  $\vee$  in each entry of  $\Psi(\beta)$ .
- (ii) There is a *location map*

$$(9.8) \quad \tilde{\iota} : \mathfrak{G}_{q+1,p+1} \rightarrow \{\text{faces of } P_{p+q}\}$$

that commutes the following diagram of set maps

$$\begin{array}{ccc} \mathfrak{G}_{q+1,p+1} & \xrightarrow{\tilde{\iota}} & \{\text{faces of } P_{p+q}\} \\ \iota \downarrow & & \downarrow \vartheta_{q,p} \\ \{\text{faces of } KK_{q+1,p+1}\} & \xrightarrow{\nu} & \{\text{faces of } K_{q+1,p+1}\}, \end{array}$$

where  $\nu$  sends a cell of  $KK$  to the cell of  $K$  of minimal dimension containing it. Indeed, if  $\beta = C_s \cdots C_1 \in \mathcal{B}$  is balanced representative of  $\theta$  with  $C_k \in \mathbf{G}_{\mathbf{x}^k}^{\mathbf{y}^k}$ , consider the (co)derivation leaf sequences  $((\mathbf{x}^1, \mathbf{y}^1), \dots, (\mathbf{x}^s, \mathbf{y}^s))$ , and let  $\mathbf{x}^{i_1}, \dots, \mathbf{x}^{i_k}$  and  $\mathbf{y}^{j_1}, \dots, \mathbf{y}^{j_l}$  be the subsequences obtained by removing all  $\mathbf{x}^i, \mathbf{y}^j = \mathbf{1}$ . Thinking of these subsequences as row and column descent sequences, consider the corresponding faces  $A = A_1 | \cdots | A_k \subset P_{m-1}$  and  $B = B_1 | \cdots | B_l \subset P_{n-1}$  and set

$$e_\theta = \chi(A) *_{(\mathbf{i}, \mathbf{j})} B \subset P_{m+n-2},$$

where  $\chi : P_{m-1} \rightarrow P_{m-1}$  is the cellular involution defined by  $\chi(A_1 | \cdots | A_k) = (m - A_k) | \cdots | (m - A_1)$  and  $(\mathbf{i}, \mathbf{j}) = (i_1 < \cdots < i_k; j_1 < \cdots < j_l)$ . Then  $e_\theta$  is the unique cell of minimal dimension  $\geq k$  such that  $\iota(\theta) \subset \vartheta_{n-1, m-1}(e_\theta)$ ; in particular, when  $s = 2$ ,  $\mathbf{x}^1 = \mathbf{x}$  and  $\mathbf{y}^2 = \mathbf{y}$ , and we recover the special cell  $e_\theta = e_{(\mathbf{y}, \mathbf{x})}$  defined in (6.1). Thus, the term ‘‘location map’’ suggests the fact that  $\tilde{\iota}$  points out the position of the image cells  $\iota(\theta)$  with respect to cells of the permutahedron  $P_{m+n}$ . Under  $\tilde{\iota}$ , the associativity of the  $\Upsilon$ -product on  $\mathfrak{G}$  is compatible with the associativity of the partitioning procedure in  $p+q$  by which  $a_1 | \cdots | a_k$  is obtained from the (ordered) set  $a_1 \cdots a_k$  by inserting bars: Given  $\theta, \zeta \in \mathfrak{G}$ , let  $\xi \in \mathfrak{G}$  be the component shared by  $\partial(\theta)$  and  $\partial(\zeta)$  in  $\mathcal{H}_\infty$ . Then  $\vartheta(\tilde{\iota}(\xi)) \subset \vartheta(\tilde{\iota}(\theta)) \cap \vartheta(\tilde{\iota}(\zeta))$  in  $K_{q+1,p+1} = \vartheta(P_{p+q})$  (see Example 30).

- (iii) Let  $\dim \theta = k$  and let  $\sigma_\theta$  be the set of all 0-dimensional elements of  $\mathcal{H}_\infty$  obtained by all possible compositions  $\partial_{i_k} \cdots \partial_{i_1}(\theta)$  where  $\partial_i$  is a component of  $\partial = \sum_i \partial_i$ . Then  $\iota(\theta)$  is the  $k$ -face of  $KK_{n,m}$  spanned on the set  $\iota(\sigma_\theta)$ .
- (iv) If  $(m, n) \in \{(2, 0), (1, 1), (0, 2)\}$  in item (ii) and  $k = 1$  in item (iii), then  $KK_{n+1, m+1} = K_{n+1, m+1} = P_{m+n}$  is an interval and (ii) agrees with (iii) under the equality  $\iota = \tilde{\iota}|_{\mathfrak{G}_{n+1, m+1}}$  for  $m + n \leq 2$ .

**Remark 6.** *Since  $\tilde{\iota}$  is not surjective, the action of the (pre)matrad axioms on Type II generators forces us to obtain  $KK_{n+1, m+1}$  as a quotient of  $PP_{n, m}$  modulo combinatorial relations in  $PP_{n, m}$  as indicated in Figure 16 above, and thereby extend the equality  $K_{n+1} = P_n / \sim$  induced by Tonks' projection (see Theorem 1 below).*

**Example 30.** *The action of the map  $\theta \rightarrow \tilde{\iota}(\theta)$  involving associativity is illustrated by the example in (4.3):*

$$((221), (31)) \rightarrow 146|2357 \quad \text{and} \quad ((41), (211)) \rightarrow 12456|37$$

while

$$(((221), (2)), ((21), (21)), ((2), (211))) \rightarrow 146|25|37$$

(on left-hand sides only (co)derivation leaf sequences of underlying matrad module generator are shown). Also, from Example 13 we have

$$C_3 C_2 C_1 \xrightarrow{\tilde{\iota}} 357|14|26.$$

The properties above imply that  $\iota$  is a bijection so that  $\mathcal{C}_{n, m}$  indexes the faces of  $KK_{n, m}$ . Define the boundary map in the cellular chain complex  $C_*(KK_{n, m})$  by

$$(9.9) \quad \partial(\chi_m^n) = \sum_{(\alpha, \beta) \in \mathcal{AB}_{m, n}} (-1)^{\epsilon + \epsilon_\alpha + \epsilon_\beta} e_{\alpha, \beta},$$

where  $\epsilon$  is the sign of the cell  $e_{(\mathbf{y}, \mathbf{x})} \subset P_{n-1, m-1}$  defined by (6.1). This sign reflects the fact that the sign of a subdivision cell in the boundary inherits (as a component) the sign of the boundary. Therefore, we immediately obtain:

**Theorem 1.** *For each  $m, n \geq 1$ , there is a canonical isomorphism of chain complexes*

$$(9.10) \quad \iota_* : (\mathcal{H}_\infty)_{n, m} \xrightarrow{\cong} C_*(KK_{n, m})$$

extending the standard isomorphisms

$$\mathcal{A}_\infty(n) = (\mathcal{H}_\infty)_{n, 1} \xrightarrow{\cong} C_*(KK_{n, 1}) = C_*(K_n)$$

and

$$\mathcal{A}_\infty(m) = (\mathcal{H}_\infty)_{1, m} \xrightarrow{\cong} C_*(KK_{1, m}) = C_*(K_m).$$

In other words, the cellular chains of the biassociahedra  $KK$  realize the free matrad resolution  $\mathcal{H}_\infty$  of the bialgebra matrad  $\mathcal{H}$ . In particular, consider the submodule  $\tilde{\mathcal{H}}_\infty \subset \mathcal{H}_\infty$  spanned on the generating set  $\tilde{\Theta}$  fixed by summing of all (distinct) elements of  $\mathfrak{G}$  in  $\mathcal{H}_\infty$  that have the same leaf sequence form. Then (9.8) induces an isomorphism

$$(9.11) \quad (\vartheta \circ \tilde{\iota})_* : (\tilde{\mathcal{H}}_\infty)_{n, m} \xrightarrow{\cong} C_*(K_{n, m})$$



by  $(\vartheta \circ \tilde{\iota})_*(\tilde{\theta}) = \vartheta(\tilde{\iota}(\theta_s))$ , where  $\theta_s \in \mathfrak{G}_{n,m}$  is any summand component of  $\tilde{\theta} \in \tilde{\Theta}$ , and the following diagram commutes:

$$\begin{array}{ccc} (\tilde{\mathcal{H}}_\infty)_{n,m} & \longrightarrow & (\mathcal{H}_\infty)_{n,m} \\ (\vartheta \circ \tilde{\iota})_* \downarrow \approx & & \approx \downarrow \iota_* \\ C_*(K_{n,m}) & \xrightarrow{\nu^\#} & C_*(KK_{n,m}). \end{array}$$

**Example 31.** We have  $\tilde{\iota}((111), (21)) = 1|234 \subset P_4$ , and apply Example 27 for which bijection (9.10) implies

$$\begin{bmatrix} \theta_2^1 \\ \theta_2^1 \\ \theta_2^1 \end{bmatrix} \left[ \begin{array}{cc} \theta_2^3 & \begin{bmatrix} \mathbf{1} \\ \theta_1^2 \end{bmatrix} \theta_1^2 \end{array} \right] \leftrightarrow d_1$$

$$\begin{bmatrix} \theta_2^1 \\ \theta_2^1 \\ \theta_2^1 \end{bmatrix} \left[ \begin{array}{c} \begin{bmatrix} \theta_2^2 \\ \theta_2^1 \end{bmatrix} [\theta_1^2 \ \theta_1^2] \ \theta_1^3 \end{array} \right] \leftrightarrow d_2$$

$$\begin{bmatrix} \theta_2^1 \\ \theta_2^1 \\ \theta_2^1 \end{bmatrix} \left[ \begin{array}{cc} \begin{bmatrix} \theta_1^2 \\ \mathbf{1} \end{bmatrix} \theta_2^2 & \theta_1^3 \end{array} \right] \leftrightarrow d_3.$$

The edge  $(1|3|2|4, z_1)$  in Figure 16 is the intersection  $d_2 \cap d_3$  corresponding to

$$(9.12) \quad A_2 A_1 = \begin{bmatrix} \theta_2^1 \\ \theta_2^1 \\ \theta_2^1 \end{bmatrix} \left[ \begin{array}{c} \left( \begin{bmatrix} \theta_1^2 \\ \mathbf{1} \end{bmatrix} \begin{bmatrix} \theta_2^1 \\ \theta_2^1 \end{bmatrix} [\theta_1^2 \ \theta_1^2] \right) \theta_1^3 \end{array} \right] \in \mathcal{B}_{3,3}.$$

The following proposition applies Proposition 4 to reformulate Theorem 1 in terms of the  $\odot$ -operation defined in (6.3) for  $(M, \gamma) = (F^{\text{pre}}(\Theta), \gamma)$ .

**Proposition 8.** Let  $(F^{\text{pre}}(\Theta), \gamma)$  be the free prematrad and  $(\mathcal{H}_\infty, \partial)$  be the  $A_\infty$ -matrad. If  $\xi = [(\theta \setminus \theta_m^n) \odot (\theta \setminus \theta_m^n)]_m^n$  with  $mn \geq 3$ , the components of  $\xi$  fit the boundary of  $KK_{n,m}$  and  $\partial(\xi) = 0$ .

Thus, an  $A_\infty$ -bialgebra structure on a DGM  $H$  is defined by a morphism of matrads  $\mathcal{H}_\infty \rightarrow U_H$  (compare [13]).

In our forthcoming paper [14], we construct the theory of relative matrads and use it to define a morphism of  $A_\infty$ -bialgebras. Using *relative  $A_\infty$ -matrads*, we prove that over a field, the homology of every biassociative DG bialgebra admits a canonical  $A_\infty$ -bialgebra structure.

For  $KK_{2,2}$ :

$$\begin{aligned} 1|2 &\leftrightarrow \frac{11}{11} = \gamma(\theta_2^1 \theta_2^1; \theta_1^2 \theta_1^2) \\ 2|1 &\leftrightarrow \frac{2}{2} = \gamma(\theta_1^2; \theta_2^1) \end{aligned}$$

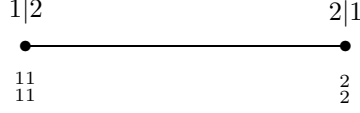

Figure 18. The biassociahedron  $KK_{2,2}$  (an interval)

For  $KK_{3,2}$ :

$$\begin{aligned} 1|23 &\leftrightarrow \frac{111}{111} = \gamma(\theta_2^1 \theta_2^1 \theta_2^1; \gamma(\theta_1^2 \theta_1^1; \theta_2^2) \theta_1^3 + \theta_1^3 \gamma(\theta_1^1 \theta_2^1; \theta_2^2)) \\ 13|2 &\leftrightarrow \frac{12}{11} = \gamma(\theta_2^1 \theta_2^2; \theta_1^2 \theta_1^2) \\ 3|12 &\leftrightarrow \frac{12}{2} = \gamma(\theta_1^1 \theta_2^2; \theta_2^2) \\ 12|3 &\leftrightarrow \frac{21}{11} = \gamma(\theta_2^2 \theta_2^1; \theta_1^2 \theta_1^2) \\ 2|13 &\leftrightarrow \frac{2^1}{2} = \gamma(\theta_1^2 \theta_1^1; \theta_2^2) \\ 23|1 &\leftrightarrow \frac{3}{2} = \gamma(\theta_1^3; \theta_2^1) \end{aligned}$$

For  $KK_{2,3}$ :

$$\begin{aligned} 1|23 &\leftrightarrow \frac{11}{21} = \gamma(\theta_2^1 \theta_2^1; \theta_2^2 \theta_1^2) \\ 13|2 &\leftrightarrow \frac{2}{21} = \gamma(\theta_2^2; \theta_2^1 \theta_1^1) \\ 3|12 &\leftrightarrow \frac{3}{2} = \gamma(\theta_1^2; \theta_3^1) \\ 12|3 &\leftrightarrow \frac{11}{111} = \gamma(\gamma(\theta_2^1; \theta_2^1 \theta_1^1) \theta_3^1 + \theta_3^1 \gamma(\theta_2^1; \theta_1^1 \theta_2^1); \theta_2^2 \theta_1^2 \theta_1^2) \\ 2|13 &\leftrightarrow \frac{11}{12} = \gamma(\theta_2^1 \theta_2^1; \theta_2^2 \theta_2^2) \\ 23|1 &\leftrightarrow \frac{2}{12} = \gamma(\theta_2^2; \theta_1^1 \theta_2^1) \end{aligned}$$

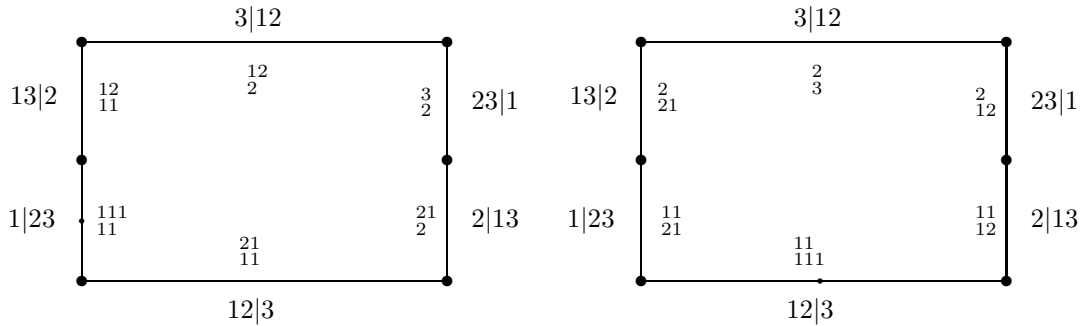

Figure 19. The biassociahedra  $KK_{3,2}$  and  $KK_{2,3}$  (heptagons)

For  $KK_{3,3}$ :

$$\begin{aligned}
 1|234 &\leftrightarrow \frac{111}{21} = \gamma(\theta_2^1\theta_2^1\theta_2^1; \theta_2^3\gamma(\theta_1^1\theta_1^2; \theta_1^2) + a + b), \text{ where} \\
 &\quad a + b = \gamma(\theta_2^2\theta_2^1; \theta_1^2\theta_1^2)\theta_1^3 + \gamma(\theta_1^2\theta_1^1; \theta_2^2)\theta_1^3 \\
 123|4 &\leftrightarrow \frac{21}{111} = \gamma(c + d + \theta_3^2\gamma(\theta_2^1; \theta_1^1\theta_2^1); \theta_1^2\theta_1^2\theta_1^2), \text{ where} \\
 &\quad c + d = \gamma(\theta_2^1\theta_2^1; \theta_2^2\theta_1^2)\theta_1^3 + \gamma(\theta_2^2; \theta_2^1\theta_1^1)\theta_1^3 \\
 2|134 &\leftrightarrow \frac{111}{12} = \gamma(\theta_2^1\theta_2^1\theta_2^1; \gamma(\theta_1^2\theta_1^1; \theta_1^2)\theta_2^3 + e + f), \text{ where} \\
 &\quad e + f = \theta_1^3\gamma(\theta_2^2\theta_2^2; \theta_1^2\theta_1^2) + \theta_1^3\gamma(\theta_1^1\theta_1^2; \theta_2^2) \\
 124|3 &\leftrightarrow \frac{12}{111} = \gamma(g + h + \gamma(\theta_2^1; \theta_2^1\theta_1^1)\theta_3^2; \theta_1^2\theta_1^2\theta_1^2), \text{ where} \\
 &\quad g + h = \theta_3^1\gamma(\theta_2^1\theta_2^1; \theta_1^2\theta_2^2) + \theta_3^1\gamma(\theta_2^2; \theta_1^1\theta_2^1) \\
 134|2 &\leftrightarrow \frac{3}{21} = \gamma(\theta_2^3; \theta_2^1\theta_1^1) \\
 234|1 &\leftrightarrow \frac{3}{12} = \gamma(\theta_2^3; \theta_1^1\theta_2^1) \\
 3|124 &\leftrightarrow \frac{21}{3} = \gamma(\theta_1^2\theta_1^1; \theta_2^3) \\
 4|123 &\leftrightarrow \frac{12}{3} = \gamma(\theta_1^1\theta_1^2; \theta_2^3) \\
 13|24 &\leftrightarrow \frac{21}{21} = \gamma(\theta_2^2\theta_2^1; \theta_2^2\theta_1^2) \\
 24|13 &\leftrightarrow \frac{12}{12} = \gamma(\theta_2^1\theta_2^2; \theta_2^1\theta_2^2) \\
 14|23 &\leftrightarrow \frac{12}{21} = \gamma(\theta_2^1\theta_2^2; \theta_2^2\theta_1^2) \\
 23|14 &\leftrightarrow \frac{21}{12} = \gamma(\theta_2^3\theta_2^1; \theta_2^1\theta_2^2) \\
 34|12 &\leftrightarrow \frac{3}{3} = \gamma(\theta_1^3; \theta_1^3) \\
 12|34 &\leftrightarrow \frac{111}{111} = \gamma[\theta_3^1\gamma(\theta_2^1; \theta_1^1\theta_2^1)\gamma(\theta_2^1; \theta_1^1\theta_2^1) + \gamma(\theta_2^1; \theta_2^1\theta_1^1)\theta_3^1\gamma(\theta_2^1; \theta_1^1\theta_2^1) \\
 &\quad + \gamma(\theta_2^1; \theta_2^1\theta_1^1)\gamma(\theta_2^1; \theta_2^1\theta_1^1)\theta_3^1; \\
 &\quad \theta_1^3\gamma(\theta_1^1\theta_1^2; \theta_1^2)\gamma(\theta_1^1\theta_1^2; \theta_1^2) + \gamma(\theta_1^2\theta_1^1; \theta_2^1)\theta_1^3\gamma(\theta_1^1\theta_1^2; \theta_1^2) + \\
 &\quad + \gamma(\theta_1^2\theta_1^1; \theta_2^1)\gamma(\theta_1^2\theta_1^1; \theta_2^1)\theta_1^3]
 \end{aligned}$$

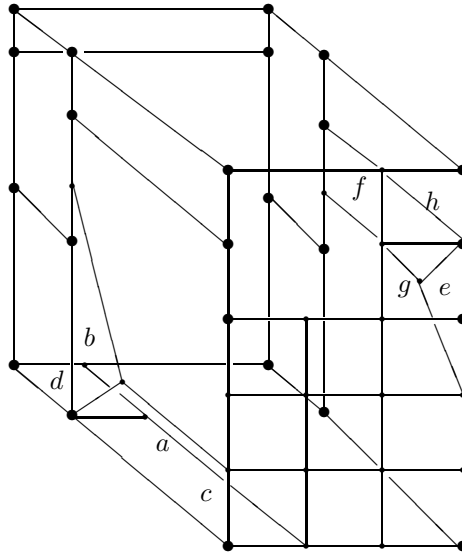

Figure 20. The biassociahedron  $KK_{3,3}$  (a subdivision of  $P_4$ ).

For  $KK_{4,2}$ :

$$\begin{aligned}
123|4 &\leftrightarrow \frac{31}{11} = \gamma(\theta_2^3\theta_2^1; \theta_1^2\theta_1^2) \\
2|134 &\leftrightarrow \frac{2^{11}}{2} = \gamma(\theta_1^2\theta_1^1\theta_1^1; \theta_2^3) \\
124|3 &\leftrightarrow \frac{22}{11} = \gamma(\theta_2^2\theta_2^2; \theta_1^2\theta_1^2) \\
134|2 &\leftrightarrow \frac{13}{11} = \gamma(\theta_2^1\theta_2^3; \theta_1^2\theta_1^2) \\
234|1 &\leftrightarrow \frac{4}{2} = \gamma(\theta_1^4; \theta_2^1) \\
3|124 &\leftrightarrow \frac{121}{2} = \gamma(\theta_1^1\theta_2^2\theta_1^1; \theta_2^3) \\
4|123 &\leftrightarrow \frac{112}{2} = \gamma(\theta_1^1\theta_1^1\theta_2^2; \theta_2^3) \\
13|24 &\leftrightarrow \frac{121}{11} = \gamma[\theta_2^1\theta_2^2\theta_2^1; \theta_1^3\gamma(\theta_1^1\theta_1^2; \theta_1^2)] + \gamma(\theta_1^2\theta_1^1; \theta_1^2)\theta_1^3] \\
14|23 &\leftrightarrow \frac{112}{11} = \gamma[\theta_2^1\theta_2^1\theta_2^2; \theta_1^3\gamma(\theta_1^1\theta_1^2; \theta_1^2)] + \gamma(\theta_1^2\theta_1^1; \theta_1^2)\theta_1^3] \\
23|14 &\leftrightarrow \frac{31}{2} = \gamma(\theta_1^3\theta_1^1; \theta_2^2) \\
34|12 &\leftrightarrow \frac{13}{2} = \gamma(\theta_1^1\theta_2^3; \theta_2^2) \\
12|34 &\leftrightarrow \frac{2^{11}}{11} = \gamma[\theta_2^2\theta_2^1\theta_2^1; \theta_1^3\gamma(\theta_1^1\theta_1^2; \theta_1^2)] + \gamma(\theta_1^2\theta_1^1; \theta_1^2)\theta_1^3] \\
1|234 &\leftrightarrow \frac{1^{111}}{11} = \gamma(\theta_2^1\theta_2^1\theta_2^1\theta_2^1; a + b - c + d + e + f), \text{ where} \\
&\quad a = \theta_1^4\gamma(\theta_1^1\gamma(\theta_1^1\theta_1^2; \theta_1^2); \theta_1^2) \\
&\quad b = \gamma(\gamma(\theta_2^2\theta_1^1; \theta_1^2)\theta_1^1; \theta_1^2)\theta_1^4 \\
&\quad c = \gamma(\theta_1^2\theta_1^1\theta_1^1; \theta_1^3)\gamma(\theta_1^1\theta_1^1\theta_1^2; \theta_1^3) \\
&\quad d = \gamma(\theta_1^3\theta_1^1; \theta_1^2)\gamma(\theta_1^1\theta_1^2\theta_1^1; \theta_1^3) \\
&\quad e = \gamma(\theta_1^3\theta_1^1; \theta_1^2)\gamma(\theta_1^1\theta_1^3; \theta_1^2) \\
&\quad f = \gamma(\theta_1^1\theta_2^2\theta_1^1; \theta_1^3)\gamma(\theta_1^1\theta_1^3; \theta_1^2)
\end{aligned}$$

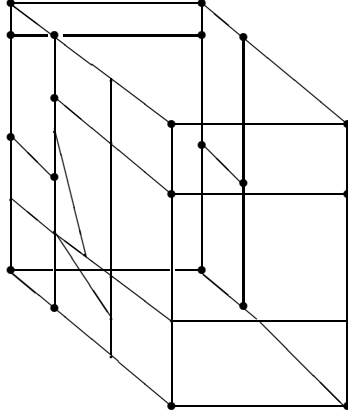

Figure 21. The biassociahedron  $KK_{4,2}$  (a subdivision of  $J_4 = K_{4,2} = \vartheta_{3,1}(P_4)$ ).

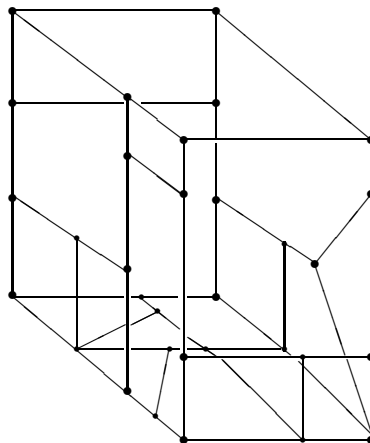

Figure 22. The biassociahedron  $KK_{2,4}$  (a subdivision of  $J_4 = K_{2,4} = \vartheta_{1,3}(P_4)$ ).

#### REFERENCES

- [1] J. F. Adams, “Infinite Loop Spaces,” *Annals of Mathematical studies*, **90**, Princeton University Press, Princeton, New Jersey (1978).
- [2] B. Fresse, Koszul Duality of Operads and Homology of Partition Posets, preprint of the Nice University, November (2002).
- [3] M. Gerstenhaber and S. D. Schack, *Algebras, Bialgebras, Quantum groups, and Algebraic Deformations*, Contemporary Math. 134 A. M. S., Providence (1992), 51-92.
- [4] N. Iwase and M. Mimura, Higher Homotopy Associativity, *Lecture Notes in Math.*, 1370 (1986), 193-220.
- [5] J.-L. Loday and M. Ronco, Hopf Algebra of the Planar Binary Trees, *Adv. in Math.* **139**, No. 2 (1998), 293-309.
- [6] M. Markl, A Cohomology Theory for  $A(m)$ -algebras and Applications, *J. Pure and Appl. Algebra.* 83 (1992), 141-175.
- [7] ———, Cotangent Cohomology of a Category and Deformations, *J. Pure and Appl. Algebra.* 113 (1996), 195-218.
- [8] ———, A Resolution (minimal model) of the PROP for Bialgebras, *J. Pure and Appl. Algebra*, 205 (2006), 341-374.
- [9] M. Markl, S. Shnider and J. Stasheff, “Operads in Algebra, Topology and Physics,” *Mathematical surveys and Monographs*, **96** (2002).
- [10] P. May, “The Geometry of Iterated Loop Spaces,” *SLNM* **271**, Springer-Verlag, Berlin (1972).
- [11] T. Pirashvili, On the PROP Corresponding to Bialgebras, *Cah. Topol. Geom. Differ. Categ.* 43 (2002), no. 3, 221-239.
- [12] S. Sanedlidze and R. Umble, Diagonals on the Permutahedra, Multiplihedra and Associahedra, *J. Homology, Homotopy and Appl.*, **6** (1) (2004), 363-411.
- [13] ———, The Biderivative and  $A_\infty$ -bialgebras, *J. Homology, Homotopy and Appl.*, **7** (2) (2005), 161-177.
- [14] ———, Morphisms of  $A_\infty$ -Bialgebra and Applications, in preparation.
- [15] B. Shoikhet, The CROCs, Non-commutative Deformations, and (Co)associative Bialgebras, preprint, math. QA/0306143.
- [16] J. D. Stasheff, Homotopy Associativity of  $H$ -spaces I, II, *Trans. A. M. S.* 108 (1963), 275-312.
- [17] ———, “ $H$ -spaces from a Homotopy Point of View,” *SLNM* 161, Springer, Berlin (1970).
- [18] A. Tonks, Relating the associahedron and the permutahedron, In “Operads: Proceedings of the Renaissance Conferences (Hartford CT / Luminy Fr 1995)” *Contemporary Mathematics*, 202 (1997), pp.33-36.

A. RAZMADZE MATHEMATICAL INSTITUTE, DEPARTMENT OF GEOMETRY AND TOPOLOGY, M.  
ALEKSIDZE ST. 1, 0193 TBILISI, GEORGIA

*E-mail address:* `sane@rmi.acnet.ge`

DEPARTMENT OF MATHEMATICS, MILLERSVILLE UNIVERSITY OF PENNSYLVANIA, MILLERSVILLE,  
PA. 17551

*E-mail address:* `ron.umble@millersville.edu`

# MATRADS, MATRAHEDRA AND $A_\infty$ -BIALGEBRAS

SAMSON SANEBLIDZE<sup>1</sup> AND RONALD UMBLE<sup>2</sup>

ABSTRACT. We introduce the notion of a matrad  $M = \{M_{n,m}\}$  whose submodules  $M_{*,1}$  and  $M_{1,*}$  are non- $\Sigma$  operads. We define the free matrad  $\mathcal{H}_\infty$  generated by a singleton  $\theta_m^n$  in each bidegree  $(m,n)$  and realize  $\mathcal{H}_\infty$  as the cellular chains on matrahedra  $\{KK_{n,m} = KK_{m,n}\}$ , of which  $KK_{n,1} = KK_{1,n}$  is the associahedron  $K_n$ . We construct the universal enveloping functor from matrads to PROPs and define an  $A_\infty$ -bialgebra as an algebra over  $\mathcal{H}_\infty$ .

## CONTENTS

1. Introduction	2
2. Low Dimensional Matrahedra	3
2.1. Markl's Fraction Product	3
2.2. Low Dimensional Matrad Products	4
3. Diagonal Approximations and the Combinatorial Join	8
3.1. The S-U Diagonals $\Delta_P$ and $\Delta_K$	8
3.2. $k$ -Subdivisions and $k$ -Approximations	9
3.3. The Combinatorial Join of Permutahedra	11
4. Submodules of $TTM$	12
5. Prematrads	15
5.1. $\Upsilon$ -products on $\overline{\mathbf{M}}$	15
5.2. Prematrads Defined	16
5.3. Free Prematrads	18
5.4. The Bialgebra Prematrad	21
5.5. Local Prematrads	22
6. Matrads	22
6.1. Matrads Defined	23
6.2. Free Matrads	26
6.3. The Biderivative	28
7. The Posets $\mathcal{PP}$ and $\mathcal{KK}$	29
8. Constructions of $PP$ and $KK$	34
8.1. Matrices with constant rows or columns	34
8.2. Step 1: The $(m,n)$ -subdivision of $\underline{m}   (\underline{n} + m)$	36
8.3. Step 2: Subdividing cells of $P_{m+n} \setminus \underline{m}   (\underline{n} + m)$	37
8.4. $PP$ -factorization of proper cells	40
8.5. The projection $\vartheta : PP \rightarrow KK$	41
References	49

*Date:* October 8, 2008.

1991 *Mathematics Subject Classification.* Primary 55P35, 55P99; Secondary 52B05.

*Key words and phrases.*  $A_\infty$ -bialgebra, operad, matrad, associahedron, matrahedron.

<sup>1</sup> This research described in this publication was made possible in part by Award No. GM1-2083 of the U.S. Civilian Research and Development Foundation for the Independent States of the Former Soviet Union (CRDF) and by Award No. 99-00817 of INTAS.

<sup>2</sup> This research funded in part by a Millersville University faculty research grant.

## 1. INTRODUCTION

Let  $H$  be a DG module over a commutative ring  $R$  with identity. In [13], we defined an  $A_\infty$ -bialgebra structure on  $H$  in terms of a square-zero  $\odot$ -product on the universal PROP  $U_H = \text{End}(TH)$ . In this paper we take an alternative point-of-view motivated by three classical constructions: First, chain maps  $\text{Ass} \rightarrow U_H$  and  $\mathcal{A}_\infty \rightarrow U_H$  in the category of non- $\Sigma$  operads define strictly (co)associative and  $A_\infty$ -(co)algebra structures on  $H$ ; second, there is a minimal resolution of operads  $\mathcal{A}_\infty \rightarrow \text{Ass}$ ; and third,  $\mathcal{A}_\infty$  is realized by the cellular chains on the Stasheff associahedra  $K = \sqcup K_n$  [10], [9]. It is natural, therefore, to envision a category in which analogs of  $\text{Ass}$  and  $\mathcal{A}_\infty$  define strictly biassociative and  $A_\infty$ -bialgebra structures on  $H$ .

In this paper we introduce the notion of a *matrad* whose distinguished objects  $\mathcal{H}$  and  $\mathcal{H}_\infty$  play the role of  $\text{Ass}$  and  $\mathcal{A}_\infty$ . But unlike the operadic case, freeness considerations are subtle since biassociative bialgebras cannot be simultaneously free and cofree. Although  $\mathcal{H}$  and  $\mathcal{H}_\infty$  are generated by singletons in each bidegree, those in  $\mathcal{H}$  are module generators while those in  $\mathcal{H}_\infty$  are matrad generators. Indeed, as a non-free matrad,  $\mathcal{H}$  has two matrad generators and  $\mathcal{H}_\infty$  is its minimal resolution. Thus  $\mathcal{H}$  and  $\mathcal{H}_\infty$  are the smallest possible constructions that control biassociative bialgebras structures and their homotopy versions (c.f. [8], [15], [11]).

Given a finite sequence  $\mathbf{x}$  in  $\mathbb{N}$ , let  $|\mathbf{x}| = \sum x_i$ . A matrad  $(M, \gamma)$  is a bigraded module  $M = \{M_{n,m}\}_{m,n \geq 1}$  together a family of structure maps

$$\gamma = \left\{ \gamma_{\mathbf{x}}^{\mathbf{y}} : \Gamma_{\mathbf{p}}^{\mathbf{y}}(M) \otimes \Gamma_{\mathbf{x}}^{\mathbf{q}}(M) \rightarrow M_{|\mathbf{y}|, |\mathbf{x}|} \right\}_{\mathbf{x}, \mathbf{y} \in \mathbb{N}^{1 \times p} \times \mathbb{N}^{q \times 1}}$$

defined on certain submodules  $\Gamma_{\mathbf{p}}^{\mathbf{y}}(M) \otimes \Gamma_{\mathbf{x}}^{\mathbf{q}}(M) \subseteq \bigotimes_{j=1}^q M_{y_j, p} \otimes \bigotimes_{i=1}^p M_{q, x_i}$  and generated by certain components of the S-U diagonal  $\Delta_P$  on permutahedra [12]; its substructures  $(\Gamma_1^{\mathbf{y}}(M), \gamma)$  and  $(\Gamma_{\mathbf{x}}^1(M), \gamma)$  are non- $\Sigma$  operads. We think of monomials in  $\Gamma_{\mathbf{x}}^{\mathbf{q}}(M)$  as  $p$ -fold tensor products of multilinear operations with  $q$  outputs, and monomials in  $\Gamma_{\mathbf{p}}^{\mathbf{y}}(M)$  as  $q$ -fold tensor products of multilinear operations with  $p$  inputs.

A general PROP, and  $U_H$  in particular, admits a canonical matrad structure and chain maps  $\mathcal{H} \rightarrow U_H$  and  $\mathcal{H}_\infty \rightarrow U_H$  in the category of matrads define biassociative bialgebra and  $A_\infty$ -bialgebra structures on  $H$ . Furthermore,  $\mathcal{H}_\infty \rightarrow \mathcal{H}$  is a minimal resolution of matrads and  $\mathcal{H}_\infty$  is realized by the cellular chains on a new family of polytopes  $KK = \bigsqcup_{m,n \geq 1} KK_{n,m}$ , called *matrahedra*, in which  $KK_{1,1} = *$ ,  $\dim KK_{n,m} = n + m - 3$  when  $mn > 1$ ,  $KK_{m,n} = KK_{n,m}$ , and  $KK_{1,n}$  is the Stasheff associahedron  $K_n$ . We represent the top dimensional face of  $KK_{n,m}$  graphically by a “double corolla” thought of as an indecomposable element  $\theta_m^n \in \text{PROP}M = \{M_{n,m} = \text{Hom}(H^{\otimes m}, H^{\otimes n})\}$  with data flowing upward through  $m$  input and  $n$  output channels (see Figure 1). The action of the matrad product  $\gamma$  on the submodule  $\Theta = \langle \theta_m^n \rangle_{m,n \geq 1}$  generates  $\mathcal{H}_\infty$ ; we define a differential  $\partial$  of degree  $-1$  on  $\theta_m^n$  and extend it inductively to lower dimensions.

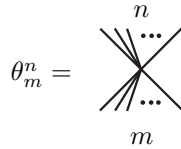

Figure 1.



Among the various attempts to construct homotopy versions of bialgebras, recent independent results of Markl and Shoikhet are related to ours through the theory of PROPs: In characteristic 0, the low-order relations in Markl’s version of a homotopy bialgebra [8] agree with our  $A_\infty$ -bialgebra relations and Shoikhet’s composition product on the universal preCROC [15] agrees with our prematrad operation on  $U_H$ . Thus we construct a functor from matrads to PROPs called the *universal enveloping functor*.

The paper is organized as follows: In Section 2 we construct the matrahedra  $KK_{n,m}$  in the range  $m + n \leq 6$ . These polytopes have a simple description in terms of the S-U diagonal  $\Delta_K$  on associahedra [12] and demonstrate the general construction while avoiding the complicating subtleties. In Section 3 we review the S-U diagonals  $\Delta_P$  and  $\Delta_K$ , and introduce some related combinatorial notions. In Section 4 we discuss various submodules of  $TTM$  (the tensor module of  $TM$ ) that model the geometry of our construction. We introduce the notion of a prematrad in Section 5, specialize to matrads in Section 6, construct the posets  $\mathcal{PP}$  and  $\mathcal{KK}$  in Section 7 and their geometric realization  $PP$  and  $KK$  in Section 8. We identify the cellular chains of  $KK$  with the  $A_\infty$ -bialgebra matrad  $\mathcal{H}_\infty$  and prove that the restriction of the free resolution of prematrads  $\rho^{\text{pre}} : F^{\text{pre}}(\Theta) \rightarrow \mathcal{H}$  to  $\mathcal{H}_\infty$  is a free resolution in the category of matrads.

2. LOW DIMENSIONAL MATRAHEDRA

The matrahedra  $\{KK_{n,m}\}$  in the range  $1 \leq m, n \leq 4$  and  $m + n \leq 6$  are identical to the polytopes  $B_m^n$  constructed by M. Markl in [8], however, the S-U diagonal on associahedra controls our construction and eliminates Markl’s arbitrary choices.

**2.1. Markl’s Fraction Product.** For simplicity, let  $M = \{M_{n,m}\}_{m,n \geq 1}$  be a bigraded  $\mathbb{Z}_2$ -module; sign considerations that arise over a general ground ring will be addressed in subsequent sections. For  $p, q \geq 1$ , let  $\mathbf{x} \times \mathbf{y} = (x_1, \dots, x_p) \times (y_1, \dots, y_q) \in \mathbb{N}^p \times \mathbb{N}^q$ . In [8], M. Markl defined the submodule  $S$  of *special elements* in the free PROP  $M$  whose additive generators are monomials  $\alpha_{\mathbf{x}}^{\mathbf{y}}$  expressed as “elementary fractions” of the form

$$(2.1) \quad \alpha_{\mathbf{x}}^{\mathbf{y}} = \frac{\alpha_p^{y_1} \cdots \alpha_p^{y_q}}{\alpha_{x_1}^q \cdots \alpha_{x_p}^q}$$

in which each  $\alpha_{x_i}^q$  and  $\alpha_p^{y_j}$  are additive generators of  $S$  and the  $j^{\text{th}}$  output of  $\alpha_{x_i}^q$  is linked to the  $i^{\text{th}}$  input of  $\alpha_p^{y_j}$  (juxtaposition in the numerator and denominator denotes tensor product). Representing an indecomposable generator  $\theta_m^n$  graphically by a double corolla as in Figure 1, a general decomposable  $\alpha$  is represented by a connected non-planar graph in which the generators appear in order from left-to-right (see Figures 2 and 9). All such fractions define a *fraction product* on the tensor module  $TM$ ; thus in (2.1) above we have  $\dim \alpha_{\mathbf{x}}^{\mathbf{y}} = \sum_{i,j} \dim \alpha_{x_i}^q + \dim \alpha_p^{y_j}$ . Note that the fraction product is not associative: For example, in the iterated fraction

$$\frac{A}{\frac{B}{C}} = \frac{\frac{\text{graph of } A}{\text{graph of } B}}{\text{graph of } C},$$

$A(BC) = 0$  while  $(AB)C = A(AB \otimes \text{Id}) \neq 0$ .

The matrad  $\mathcal{H}_\infty$  is a proper submodule of  $S$  and the matrad product  $\gamma$  agrees with the restriction of Markl's fraction product to  $S$ . Notationally, let  $\mathbf{M}_\mathbf{x}^q = M_{q,x_1} \otimes \cdots \otimes M_{q,x_p}$  and  $\mathbf{M}_\mathbf{y}^p = M_{y_1,p} \otimes \cdots \otimes M_{y_q,p}$ ; then the fraction product (2.1) can be expressed in terms of our *prematrad product*  $\gamma = \{\gamma_\mathbf{x}^\mathbf{y} : \mathbf{M}_\mathbf{y}^p \otimes \mathbf{M}_\mathbf{x}^q \rightarrow M_{|\mathbf{y}|,|\mathbf{x}|}\}_{\mathbf{x} \times \mathbf{y}}$  as

$$\alpha_\mathbf{x}^\mathbf{y} = \gamma_\mathbf{x}^\mathbf{y} \left( \alpha_p^{y_1} \cdots \alpha_p^{y_q}; \alpha_{x_1}^q \cdots \alpha_{x_p}^q \right).$$

We refer to  $\mathbf{x}$  and  $\mathbf{y}$  as the *leaf sequences* of  $\alpha_\mathbf{x}^\mathbf{y}$ . Note that the action of  $\gamma$  on up-rooted corollas  $\theta_m^1$  (or down-rooted corollas  $\theta_1^n$ ) generates all planar rooted trees with levels (PLTs), and the projection to planar rooted trees (PRTs) by forgetting levels induces the standard operadic product. Thus we may regard the  $A_\infty$ -operad  $\mathcal{A}_\infty$  as either

$$\begin{aligned} \mathcal{H}_{1,*} &= (\langle \theta_m^1 \mid m \geq 1 \rangle / \sim, \partial), \text{ where } \partial(\theta_m^1) = \sum_{\substack{\alpha_m^1 \in \mathcal{H}_{1,*} \cdot \mathcal{H}_{1,*} \\ \dim \alpha_m^1 = m-3}} \alpha_m^1 \text{ or} \\ \mathcal{H}_{*,1} &= (\langle \theta_1^n \mid n \geq 1 \rangle / \sim, \partial), \text{ where } \partial(\theta_1^n) = \sum_{\substack{\alpha_1^n \in \mathcal{H}_{*,1} \cdot \mathcal{H}_{*,1} \\ \dim \alpha_1^n = n-3}} \alpha_1^n. \end{aligned}$$

The operadic products in  $\mathcal{H}_{1,*}$  and  $\mathcal{H}_{*,1}$  extend simultaneously to the *matrad product* on the  $A_\infty$ -bialgebra matrad  $\mathcal{H}_\infty = \langle \theta_m^n \rangle_{m,n \geq 1}$ . While much of the work in constructing  $\mathcal{H}_\infty$  involves making this extension precise, the complicating subtleties appear outside the range considered here.

**2.2. Low Dimensional Matrad Products.** We will construct  $\{\mathcal{H}_{n,m}\}_{m+n \leq 6}$  inductively as stage  $\mathcal{F}_6$  of the increasing filtration  $\mathcal{F}_k = \bigoplus_{m+n \leq k} \mathcal{H}_{n,m}$ ,  $3 \leq k \leq 6$ . Our construction is controlled by the S-U diagonal  $\Delta_K$  on cellular chains of the associahedra  $K$  (see [12]), which in the range of dimensions considered here is given by

$$\begin{aligned} \Delta_K(\text{Y}) &= \text{Y} \otimes \text{Y}, \\ \Delta_K(\text{Y}) &= \text{Y} \otimes \text{Y} + \text{Y} \otimes \text{Y}, \text{ and} \\ \Delta_K(\text{Y}) &= \text{Y} \otimes \text{Y} + \text{Y} \otimes \text{Y} + \text{Y} \otimes \text{Y} \\ &\quad + \text{Y} \otimes \text{Y} + \text{Y} \otimes \text{Y} + \text{Y} \otimes \text{Y}. \end{aligned}$$

Note that  $\Delta_K$  agrees with the Alexander-Whitney diagonal on  $K_2 = *$  and  $K_3 = I$ . Define  $\Delta_K^{(0)} = \text{Id}$ ; for each  $k \geq 1$ , define the (*left*)  $k$ -fold iterate of  $\Delta_K$  by

$$\Delta_K^{(k)} = \left( \Delta_K \otimes \text{Id}^{\otimes k-1} \right) \Delta_K^{(k-1)}$$

and view each component of  $\Delta_K^{(k)}(\theta_p^1)$  (and dually  $\Delta_K^{(k)}(\theta_1^p)$ ) as a  $(p-2)$ -dimensional subcomplex of  $K_p^{\times k+1}$ .

Define  $\mathcal{H}_{1,1} = \langle \theta_1^1 \rangle$ ,  $\mathcal{H}_{1,2} = \langle \theta_2^1 \rangle$ ,  $\mathcal{H}_{2,1} = \langle \theta_1^2 \rangle$  and  $\mathcal{F}_3 = \mathcal{H}_{1,1} \oplus \mathcal{H}_{1,2} \oplus \mathcal{H}_{2,1}$ . To construct  $\mathcal{F}_4$ , use the generators of  $\mathcal{F}_3$  to construct all possible elementary fractions in  $M_{2,2}$  having two inputs and two outputs. There are exactly two such elementary fractions, namely,

$$\alpha_2^2 = \text{Y} \text{ and } \alpha_{11}^{11} = \text{Y} \text{Y},$$

each of dimension zero. Let  $\mathcal{H}_{2,2} = \langle \theta_2^2, \alpha_2^2, \alpha_{11}^{11} \rangle$  and define  $\partial(\theta_2^2) = \alpha_2^2 + \alpha_{11}^{11}$ . This completes the construction of  $\mathcal{F}_4$ . Thus  $KK_{2,2}$  is an interval  $I$  labeled by  $\theta_2^2$  with vertices labeled by  $\alpha_2^2$  and  $\alpha_{11}^{11}$ .

Although all fraction products are used to construct  $\mathcal{F}_4$ , more fraction products than we need appear at the next stage of the construction and beyond. Note that each factor in a numerator or denominator of  $\alpha_2^2$  and  $\alpha_{11}^{11}$  is a component of the iterated S-U diagonal as  $\Delta_K^{(k)}(\theta_1^2)$  or  $\Delta_K^{(k)}(\theta_2^1)$  for some  $k = 0, 1$ . Indeed, the components of  $\Delta_K^{(k)}(\theta_m^1)$  and  $\Delta_K^{(k)}(\theta_n^1)$  will determine which fraction products to admit and which to discard.

Continuing with the construction of  $\mathcal{F}_5$ , use the generators of  $\mathcal{F}_4$  to construct all possible fraction products in  $M_{2,3}$ . There are 18 of these: one in dimension 2, nine in dimension 1 and eight in dimension 0. Since  $KK_{2,3}$  is to have a single top dimensional (indecomposable) 2-cell  $\theta_3^2$ , we must discard the 2-dimensional (decomposable) generator

$$e = \frac{\begin{array}{c} \diagup \quad \diagdown \\ \diagdown \quad \diagup \\ \diagup \quad \diagdown \end{array}}{\begin{array}{c} \diagdown \quad \diagup \\ \diagdown \quad \diagup \\ \diagdown \quad \diagup \end{array}}$$

as well as the appropriate components of its boundary. Note that  $e$  represents a square given by the Cartesian product of the three points in the denominator with the two intervals in the numerator. Thus the boundary of  $e$  consists of the four edges

$$(2.2) \quad \frac{\begin{array}{c} \diagup \quad \diagdown \\ \diagdown \quad \diagup \\ \diagdown \quad \diagup \end{array}}{\begin{array}{c} \diagdown \quad \diagup \\ \diagdown \quad \diagup \\ \diagdown \quad \diagup \end{array}}, \quad \frac{\begin{array}{c} \diagdown \quad \diagup \\ \diagdown \quad \diagup \\ \diagdown \quad \diagup \end{array}}{\begin{array}{c} \diagdown \quad \diagup \\ \diagdown \quad \diagup \\ \diagdown \quad \diagup \end{array}}, \quad \frac{\begin{array}{c} \diagdown \quad \diagup \\ \diagdown \quad \diagup \\ \diagdown \quad \diagup \end{array}}{\begin{array}{c} \diagdown \quad \diagup \\ \diagdown \quad \diagup \\ \diagdown \quad \diagup \end{array}}, \quad \frac{\begin{array}{c} \diagdown \quad \diagup \\ \diagdown \quad \diagup \\ \diagdown \quad \diagup \end{array}}{\begin{array}{c} \diagdown \quad \diagup \\ \diagdown \quad \diagup \\ \diagdown \quad \diagup \end{array}},$$

the first two of which contain components of  $\Delta_K^{(2)}(\theta_1^2)$  and  $\Delta_K^{(1)}(\theta_3^1)$  in their numerators and denominators. Our selection rule admits the first two edges and their vertices.

Express each of the factors  $\alpha_{x_i}^q$  and  $\alpha_p^{y_j}$  in  $\alpha_{\mathbf{x}}^{\mathbf{y}} = \gamma_{\mathbf{x}}^{\mathbf{y}} \left( \alpha_p^{y_1} \cdots \alpha_p^{y_q}; \alpha_{x_1}^q \cdots \alpha_{x_p}^q \right)$  in terms of their respective leaf sequences  $\mathbf{x}_i$ ,  $\mathbf{q}_i$ ,  $\mathbf{y}_j$  and  $\mathbf{p}_j$  so that

$$\alpha_{\mathbf{x}}^{\mathbf{y}} = \frac{\alpha_{\mathbf{p}_1}^{y_1} \cdots \alpha_{\mathbf{p}_q}^{y_q}}{\alpha_{\mathbf{x}_1}^{q_1} \cdots \alpha_{\mathbf{x}_p}^{q_p}}.$$

Then  $(\mathbf{p}_1, \dots, \mathbf{p}_q)$  and  $(\mathbf{q}_1, \dots, \mathbf{q}_p)$  define the *upper and lower contact sequences* of  $\alpha_{\mathbf{x}}^{\mathbf{y}}$ , respectively.

**Example 1.** *The upper and lower contact sequences of*

$$(2.3) \quad \alpha_{111}^{12} = \frac{\alpha_3^1 \alpha_{12}^{11}}{\alpha_1^2 \alpha_1^2 \alpha_1^2} = \frac{\begin{array}{c} \diagup \\ \diagdown \quad \diagup \\ \diagdown \quad \diagup \end{array}}{\begin{array}{c} \diagdown \quad \diagup \\ \diagdown \quad \diagup \\ \diagdown \quad \diagup \end{array}}$$

are  $((3), (1, 2))$  and  $((2), (2), (2))$ , respectively.

A non-vanishing *codimension 1 matrad monomial*

$$\alpha_{\mathbf{x}}^{\mathbf{y}} = \frac{\alpha_{\mathbf{p}_1}^{y_1} \cdots \alpha_{\mathbf{p}_q}^{y_q}}{\alpha_{\mathbf{x}_1}^{q_1} \cdots \alpha_{\mathbf{x}_p}^{q_p}} \in M_{|\mathbf{y}|, |\mathbf{x}|} \text{ with } |\mathbf{x}| + |\mathbf{y}| \leq 6$$

satisfies the following two conditions:

- (i) The upper contact sequence  $(\mathbf{p}_1, \dots, \mathbf{p}_q)$  is the list of leaf sequences in some component of  $\Delta_K^{(q-1)}(\theta_p^1)$ .
- (ii) The lower contact sequence  $(\mathbf{q}_1, \dots, \mathbf{q}_p)$  is the list of leaf sequences in some component of  $\Delta_K^{(p-1)}(\theta_1^q)$ .

**Example 2.** The elementary fraction  $\alpha_{111}^{12} = (\alpha_3^1 \alpha_{12}^{11}) / (\alpha_1^2 \alpha_1^2 \alpha_1^2)$  discussed in Example 1 is a non-vanishing 2-dimensional matrad generator since its upper contact sequence  $((3), (1, 2))$  is the list of leaf sequences in the component

$$\begin{array}{c} \diagup \diagdown \\ \diagdown \diagup \end{array} \otimes \begin{array}{c} \diagup \diagdown \\ \diagdown \diagup \end{array} \text{ of } \Delta_K^{(1)} \left( \begin{array}{c} \diagup \diagdown \\ \diagdown \diagup \end{array} \right)$$

and its lower contact sequence  $((2), (2), (2))$  is the list of leaf sequences in

$$\Upsilon \otimes \Upsilon \otimes \Upsilon = \Delta_K^{(2)}(\Upsilon).$$

Having discarded the last two fractions in (2.2), our selection rule admits seven 1-dimensional generators labeling the edges of  $KK_{2,3}$ . Now linearly extend the boundary map  $\partial$  to these matrad generators and compute the seven admissible 0-dimensional generators labeling the vertices of  $KK_{2,3}$  (see Figure 13). Then in addition to the 2-dimensional generator  $e$  and the last two 1-dimensional generators in (2.2), our selection rule discards the common vertex

$$\frac{\begin{array}{c} \diagup \diagdown \\ \diagdown \diagup \end{array} \begin{array}{c} \diagup \diagdown \\ \diagdown \diagup \end{array}}{\Upsilon \Upsilon \Upsilon}.$$

Different elementary fractions may represent the same element. For example,

$$(2.4) \quad \frac{\begin{array}{c} \diagup \diagdown \\ \diagdown \diagup \end{array} \begin{array}{c} \diagup \diagdown \\ \diagdown \diagup \end{array}}{\Upsilon \Upsilon \Upsilon} = \frac{\begin{array}{c} \diagup \diagdown \\ \diagdown \diagup \end{array} \begin{array}{c} \diagup \diagdown \\ \diagdown \diagup \end{array}}{\begin{array}{c} \diagup \diagdown \\ \diagdown \diagup \end{array} \begin{array}{c} \diagup \diagdown \\ \diagdown \diagup \end{array} \Upsilon}.$$

The associativity and unit axioms in the definition of a prematrad (see Definition 3 below) identify various representations such as these.

Finally, let  $\mathcal{H}_{2,3}$  be the free submodule of  $M_{2,3}$  generated by  $\theta_3^2$  and the 14 elementary fractions given by the selection rule above. Define

$$\partial \left( \begin{array}{c} \diagup \diagdown \\ \diagdown \diagup \end{array} \right) = \frac{\Upsilon}{\begin{array}{c} \diagup \diagdown \\ \diagdown \diagup \end{array}} + \frac{\begin{array}{c} \diagdown \diagup \\ \diagup \diagdown \end{array}}{\begin{array}{c} \diagup \diagdown \\ \diagdown \diagup \end{array} |} + \frac{\begin{array}{c} \diagdown \diagup \\ \diagup \diagdown \end{array}}{| \begin{array}{c} \diagup \diagdown \\ \diagdown \diagup \end{array}} + \frac{\begin{array}{c} \diagup \diagdown \\ \diagdown \diagup \end{array} \begin{array}{c} \diagup \diagdown \\ \diagdown \diagup \end{array}}{\begin{array}{c} \diagdown \diagup \\ \diagup \diagdown \end{array} \Upsilon} + \frac{\begin{array}{c} \diagup \diagdown \\ \diagdown \diagup \end{array} \begin{array}{c} \diagup \diagdown \\ \diagdown \diagup \end{array}}{\Upsilon \begin{array}{c} \diagdown \diagup \\ \diagup \diagdown \end{array}} + \frac{\begin{array}{c} \diagup \diagdown \\ \diagdown \diagup \end{array} \begin{array}{c} \diagup \diagdown \\ \diagdown \diagup \end{array}}{\Upsilon \Upsilon \Upsilon} + \frac{\begin{array}{c} \diagup \diagdown \\ \diagdown \diagup \end{array} \begin{array}{c} \diagup \diagdown \\ \diagdown \diagup \end{array}}{\Upsilon \Upsilon \Upsilon};$$

then  $KK_{2,3}$  is the heptagon pictured in Figure 2. The matrahedron  $KK_{3,2}$  is homeomorphic to  $KK_{2,3}$  (see Figure 20) and we immediately obtain  $\mathcal{H}_{3,2}$ . This completes the construction of  $\mathcal{F}_5$ .

We continue with the construction of  $\mathcal{F}_6$ . Use the generators of  $\mathcal{F}_5$  to construct all possible fraction products in  $M_{4,2}$ . Using the selection rule, admit all elementary fractions in dimension 2 except those whose numerators and denominators agree with some component of  $\Delta_K^{(k)}(\theta_p^1)$  or  $\Delta_K^{(k)}(\theta_1^q)$ ; these represent the 2-faces of  $KK_{4,2}$ . Linearly extend the boundary map  $\partial$  and compute the admissible generators in dimensions 0 and 1. Let  $\mathcal{H}_{4,2}$  be the free submodule of  $M_{4,2}$  generated by  $\theta_2^4$  and

the admissible elementary fractions. Define

$$\begin{aligned} \partial(\times) &= \frac{\Psi}{\wedge} + \frac{|\Psi}{\times} + \frac{\Psi|}{\times} + \frac{||\Psi}{\times} + \frac{|\Psi|}{\times} + \frac{\Psi||}{\times} + \frac{\wedge \times}{\Psi \Psi} + \frac{\times \times}{\Psi \Psi} \\ &+ \frac{\times \wedge}{\Psi \Psi} + \frac{\wedge \wedge \times}{\Psi \Psi} + \frac{\wedge \wedge \times}{\Psi \Psi} + \frac{\wedge \times \wedge}{\Psi \Psi} + \frac{\wedge \times \wedge}{\Psi \Psi} + \frac{\times \wedge \wedge}{\Psi \Psi} + \frac{\times \wedge \wedge}{\Psi \Psi} \\ &+ \frac{\wedge \wedge \wedge \wedge}{\Psi \Psi} + \frac{\wedge \wedge \wedge \wedge}{\Psi \Psi} + \frac{\wedge \wedge \wedge \wedge}{\Psi \Psi} + \frac{\wedge \wedge \wedge \wedge}{\Psi \Psi} + \frac{\wedge \wedge \wedge \wedge}{\Psi \Psi} + \frac{\wedge \wedge \wedge \wedge}{\Psi \Psi}; \end{aligned}$$

then  $KK_{4,2}$  is the 3-dimensional matrahedron pictured in Figures 3 and 22.

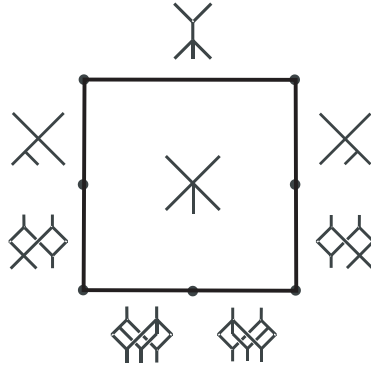

Figure 2. The matrahedron  $KK_{2,3}$ .

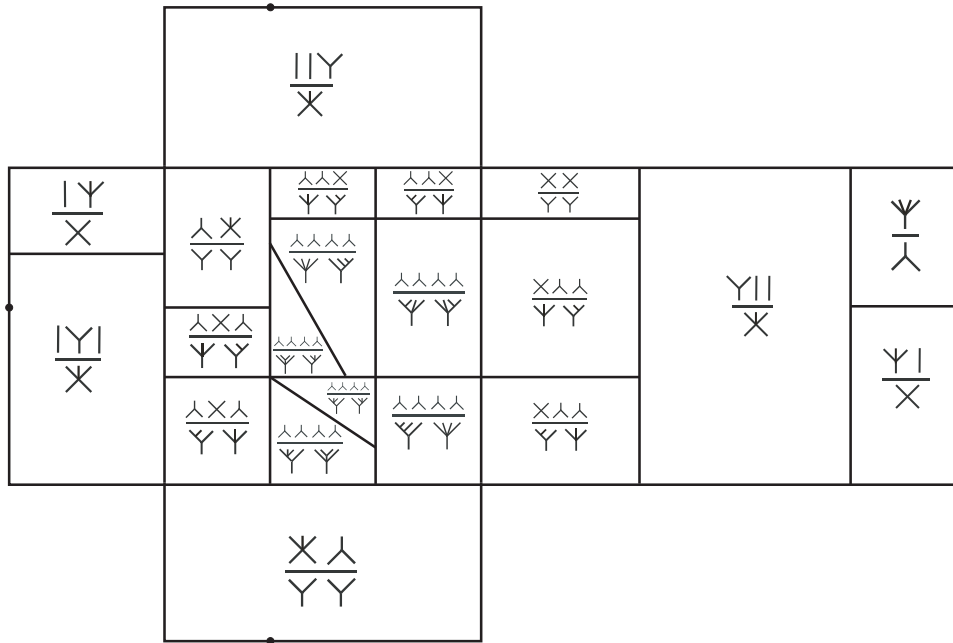

Figure 3. The 2-skeleton of  $KK_{4,2}$ .

Again,  $KK_{2,4}$  is the homeomorphic image of  $KK_{4,2}$  (see Figure 23) and we simultaneously obtain  $\mathcal{H}_{2,4}$ . While similar, the calculations for  $KK_{3,3}$  (see Figure 21) also involve elements such as (2.3); we leave this case to the reader. This completes the construction of  $\mathcal{F}_6$ .

When  $n > 6$  the combinatorial structure of  $K_{n-2}$  is insufficient to control the construction of  $\mathcal{F}_n$ . Instead, the permutahedron  $P_{n-1}$  whose faces are canonically indexed by PLTs provides the combinatorics we need. Nevertheless, the low dimensional examples above demonstrate the general principles, and with these in mind we proceed with the general construction.

### 3. DIAGONAL APPROXIMATIONS AND THE COMBINATORIAL JOIN

Recall that a map  $f : X \rightarrow Y$  of CW-complexes is homotopic to a cellular map  $g : X \rightarrow Y$ , which in turn induces a chain map  $g : C_*(X) \rightarrow C_*(Y)$ . Given a geometric diagonal  $\Delta : X \rightarrow X \times X$ , a cellular map  $\Delta_X : X \rightarrow X \times X$  homotopic to  $\Delta$  is called a *diagonal approximation*. A diagonal approximation  $\Delta_X$  induces a chain map  $\Delta_X : C_*(X) \rightarrow C_*(X) \otimes C_*(X)$ , called a *diagonal*. A brief review of the S-U diagonals  $\Delta_P$  and  $\Delta_K$  on cellular chains of permutahedra  $P = \sqcup_{n \geq 1} P_n$  and associahedra  $K = \sqcup_{n \geq 2} K_n$  (up to sign) now follows (see [12] for details).

**3.1. The S-U Diagonals  $\Delta_P$  and  $\Delta_K$ .** Let  $\underline{n} = \{1, 2, \dots, n\}$ ,  $n \geq 1$ . A matrix  $E$  with entries from  $\{0\} \cup \underline{n}$  is a *step matrix* if the following conditions hold:

- (i) Each element of  $\underline{n}$  appears as an entry of  $E$  exactly once.
- (ii) Elements of  $\underline{n}$  in each row and column of  $E$  form an increasing contiguous block.
- (iii) Each diagonal parallel to the main diagonal of  $E$  contains exactly one element of  $\underline{n}$ .

The non-zero entries in a step matrix form a continuous staircase connecting the lower-left and upper-right most entries. There is a bijective correspondence between step matrices with non-zero entries in  $\underline{n}$  and permutations of  $\underline{n}$ .

Given an integer matrix  $M = (m_{ij})$ , define right-shift and down-shift operations  $R$  and  $D$  on  $G$  as follows: Let  $S \subset \{x \in \text{col}(j) \mid x \neq 0\}$  and let  $T \subset \{y \in \text{row}(i) \mid y \neq 0\}$ .

- (i) *Right-shift*  $R_S M = M$  unless for some  $i$  and all  $k \geq i$ ,  $m_{ij} = \min S > \max \text{col}(j+1)$  and  $m_{k,j+1} = 0$ , in which case each  $m_{kj} \in S$  is interchanged with  $m_{k,j+1}$ .
- (ii) *Down-shift*  $D_T M = M$  unless for some  $j$  and all  $k \geq j$ ,  $m_{ij} = \min T > \max \text{row}(i+1)$  and  $m_{i+1,k} = 0$ , in which case each  $m_{ik} \in T$  is interchanged with  $m_{i+1,k}$ .

We say that a matrix  $F$  is *derived* from a  $q \times p$  step matrix  $E$  if

$$F = D_{N_p} D_{N_{p-1}} \cdots D_{N_1} R_{M_q} R_{M_{q-1}} \cdots R_{M_1} E$$

for some choice of  $M_1, \dots, M_q$  and  $N_1, \dots, N_p$ . Note that step matrices are derived matrices via  $M_i = N_j = \emptyset$  for all  $i, j$ . Let  $a = A_1|A_2|\cdots|A_p$  and  $b = B_q|B_{q-1}|\cdots|B_1$  be partitions of  $\underline{n}$ . The pair  $a \times b$  is an  $(p, q)$ -*complementary pair* (CP) if  $B_i$  and  $A_j$  are the rows and columns of a  $q \times p$  derived matrix. Since faces of  $P_n$  are indexed by partitions of  $\underline{n}$ , and CPs are in one-to-one correspondence with derived matrices, each CP is identified with some product face of  $P_n \times P_n$ . Let  $e^n$  denote the top dimensional face of  $P_{n+1}$ .

**Definition 1.** Define  $\Delta_P(e^0) = e^0 \otimes e^0$ . Inductively, having defined  $\Delta_P$  on  $C_*(P_{k+1})$  for all  $0 \leq k \leq n-1$ , define  $\Delta_P$  on  $C_n(P_{n+1})$  by

$$\Delta_P(e^n) = \sum_{\substack{(p,q)\text{-CPs } u \times v \\ p+q=n+2}} \pm u \otimes v,$$

and extend multiplicatively to all of  $C_*(P_{n+1})$ .

The diagonal  $\Delta_P$  induces a diagonal  $\Delta_K$  on  $C_*(K)$ . Recall that faces of  $P_n$  in codimension  $k$  are indexed by planar rooted trees with  $n+1$  leaves and  $k+1$  levels (PLTs), and forgetting levels defines the cellular projection  $\vartheta_0 : P_n \rightarrow K_{n+1}$  given by A. Tonks [18]. Thus faces of  $P_n$  indexed by PLTs with multiple nodes in the same level degenerate under  $\vartheta_0$ , and corresponding generators span the kernel of the induced map  $\vartheta_0 : C_*(P_n) \rightarrow C_*(K_{n+1})$ . The diagonal  $\Delta_K$  is given by  $\Delta_K \vartheta_0 = (\vartheta_0 \otimes \vartheta_0) \Delta_P$ .

**3.2.  $k$ -Subdivisions and  $k$ -Approximations.** When  $X$  is a polytope one can choose a diagonal approximation  $\Delta_X : X \rightarrow X \times X$  such that

- (i)  $\Delta_X$  acts on each face  $e \subset X$  as a (topological) inclusion  $\Delta_X(e) \subset e \times e$ , and
- (ii) there is an induced (cellular) 1-subdivision  $X^{(1)}$  of  $X$  that converts  $\Delta_X$  into a cellular inclusion  $\Delta_X^{(1)} : X^{(1)} \rightarrow X \times X$ .

If  $e = \bigcup_{i=1}^m e_i$  and  $e_i \subseteq X^{(1)}$ , there are faces  $u_i, v_i \subseteq e_i$  such that  $\Delta_X^{(1)}(e_i) = u_i \times v_i$ . Thus  $\Delta_X(e) = \bigcup_{i=1}^m \Delta_X^{(1)}(e_i) = \bigcup_{i=1}^m u_i \times v_i$ , and in particular,  $\Delta_X^{(1)}$  agrees with the geometric diagonal  $\Delta$  only on vertices of  $X$ .

The 1-subdivision  $X^{(1)}$  arising from an explicit diagonal approximation  $\Delta_X$  can be thought of as the cell complex obtained by gluing the cells in  $\Delta_X(X)$  together along their common boundaries in the only way possible. For example, the A-W diagonal on the simplex  $\Delta^n$ , the Serre diagonal on the cube  $I^n$ , and the S-U diagonals on the permutahedron  $P_{n+1}$  and the associahedron  $K_{n+2}$  (see [12]) induce explicit 1-subdivisions  $(\Delta^n)^{(1)}$ ,  $(I^n)^{(1)}$ ,  $P_{n+1}^{(1)}$  and  $K_{n+2}^{(1)}$  (see Figures 4-7), and it is a good exercise to determine how the vertices of  $(I^n)^{(1)}$  resolve in  $P_{n+1}^{(1)}$  and  $K_{n+2}^{(1)}$ .

Algebraically, the assignment

$$(3.1) \quad e \mapsto \{u_i \times v_i\}_{1 \leq i \leq m}$$

determines a DG diagonal  $\Delta_X : C_*(X) \rightarrow C_*(X) \otimes C_*(X)$  on cellular chains such that  $\Delta_X(C_*(X)) \subseteq C_*(\Delta_X^{(1)}(X^{(1)}))$ , where equality holds in the (unique) case  $X = *$ . Conversely, if a DG diagonal approximation  $\Delta_X$  on  $C_*(X)$  is determined by a cellular decomposition as in (3.1), there is a corresponding 1-subdivision  $X^{(1)}$  and a 1-approximation  $\Delta_X^{(1)} : X^{(1)} \rightarrow X \times X$ .

Furthermore, there is a 2-subdivision  $X^{(2)}$  of  $X$  (see Figure 8) and a corresponding 2-approximation  $\tilde{\Delta}_X^{(2)} : X^{(2)} \rightarrow X^{(1)} \times X$  that sends each cell of  $X^{(2)}$  onto a single cell of  $X^{(1)} \times X$ ; consequently, the composition  $\Delta_X^{(2)} = (\Delta_X^{(1)} \times \text{Id}) \tilde{\Delta}_X^{(2)}$  sends each cell of  $X^{(2)}$  onto a single cell of  $X \times X$ . Inductively, for each  $k$ , there is a  $k$ -subdivision  $X^{(k)}$  and a  $k$ -approximation  $\tilde{\Delta}_X^{(k)} : X^{(k)} \rightarrow X^{(k-1)} \times X$  such that  $\Delta_X^{(k)} = (\Delta_X^{(k-1)} \times \text{Id}) \tilde{\Delta}_X^{(k)}$  sends each cell of  $X^{(k)}$  onto a single cell of  $X \times X$ . Thus,

for each  $k \geq 0$ , a diagonal approximation  $\Delta_X$  fixes the subcomplex  $\Delta^{(k)}(X) := \Delta_X^{(k)}(X^{(k)}) \subset X^{\times k+1}$ , which says that  $\Delta_X$  acts on  $\Delta^{(k)}(X)$  as an inclusion.



Figure 4. The 1-subdivision of  $P_2 = K_3 = I$ .

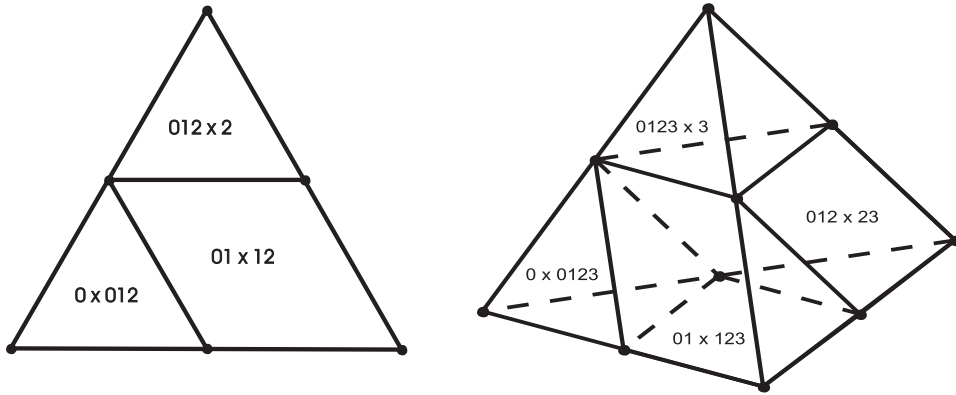

Figure 5. 1-subdivisions of  $\Delta^2$  and  $\Delta^3$  via the A-W diagonal.

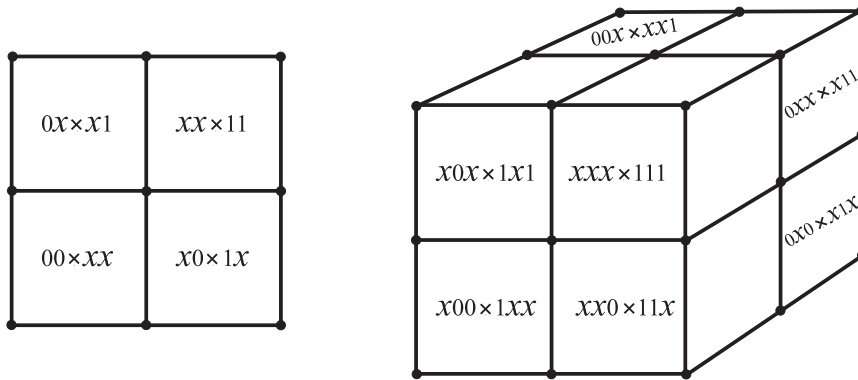
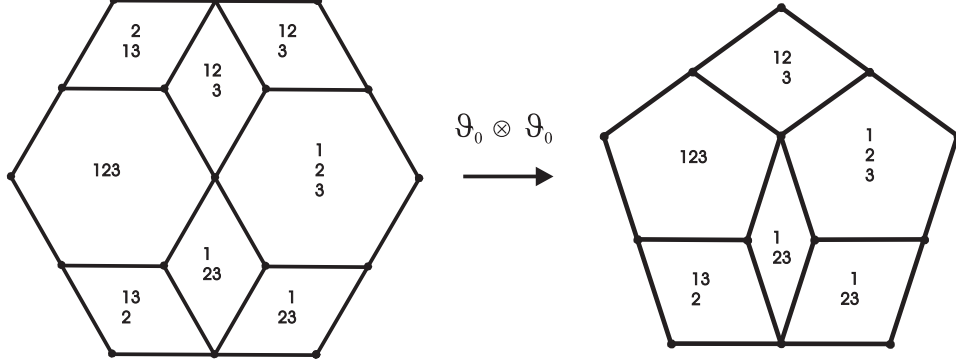
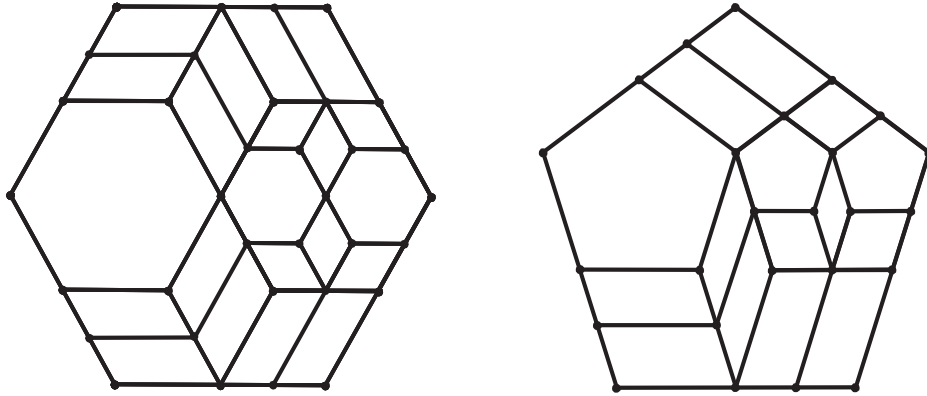

Figure 6. 1-subdivisions of  $I^2$  and  $I^3$  via the Serre diagonal.



 Figure 7. 1-subdivisions of  $P_3$  and  $K_4$  via S-U diagonals  $\Delta_P$  and  $\Delta_K$ .

 Figure 8. 2-subdivisions of  $P_3$  and  $K_4$ .

**3.3. The Combinatorial Join of Permutohedra.** The combinatorial join, which resembles the standard join of spaces, plays an important role in our construction of matrahedra. The *combinatorial join*  $P_m *_c P_n$  of permutahedra  $P_m$  and  $P_n$  is the permutahedron  $P_{m+n}$  constructed as follows: Given faces  $A_1 | \cdots | A_k \subseteq P_m$  and  $B_1 | \cdots | B_l \subseteq P_n$ , let  $s$  be an integer such that  $\max\{k, l\} \leq s \leq k + l$ , and let  $(\mathbf{i}; \mathbf{j}) = (i_1 < \cdots < i_k; j_1 < \cdots < j_l)$ , where  $\mathbf{i} \cup \mathbf{j} = \underline{s}$ . Obtain  $A'_1 | \cdots | A'_s$  and  $B'_1 | \cdots | B'_s$  by setting  $A'_{i_r} = A_r$ ,  $B'_{j_t} = B_t$ , and  $A'_i = B'_j = \emptyset$  otherwise. Note that  $(A'_r, B'_r) \neq (\emptyset, \emptyset)$  for all  $r$ . Given a set  $B = \{b_1, \dots, b_k\} \subset \mathbb{N}$  and  $m \in \mathbb{N}$ , define  $B + m = \{b_1 + m, \dots, b_k + m\}$  and consider the codimension  $s - 1$  face  $A_1 | \cdots | A_k *_{(\mathbf{i}; \mathbf{j})} B_1 | \cdots | B_l = A'_1 \cup (B'_1 + m) | \cdots | A'_s \cup (B'_s + m) \subseteq P_{m+n}$ . When  $s = m + n$ , each pair of vertices  $A_1 | \cdots | A_m \times B_1 | \cdots | B_n \subseteq P_m \times P_n$  generates  $\binom{m+n}{m}$  vertices  $A_1 | \cdots | A_m *_{(\mathbf{i}; \mathbf{j})} B_1 | \cdots | B_n$  of  $P_{m+n}$  as  $(\mathbf{i}; \mathbf{j})$  ranges over all  $(m, n)$ -shuffles of  $(A_1, \dots, A_m; B_1 + m, \dots, B_n + m)$ . Define

$$P_m *_c P_n = \bigcup_{\substack{A_1 | \cdots | A_k \times B_1 | \cdots | B_l \subseteq P_m \times P_n \\ \mathbf{i} \cup \mathbf{j} = \underline{s}; \max\{k, l\} \leq s \leq k + l}} A_1 | \cdots | A_k *_{(\mathbf{i}; \mathbf{j})} B_1 | \cdots | B_l.$$

Thus, given  $m, n \geq 1$  and a cell  $e \subseteq P_{m+n}$ , there is a unique decomposition  $e = A_1 | \cdots | A_k *_{(i;j)} B_1 | \cdots | B_l$  with  $A_1 | \cdots | A_k \subset P_m$  and  $B_1 | \cdots | B_l \subset P_n$ .

**Example 3.** Setting  $s = 2$  produces the 14 codimension 1 faces of  $P_2 *_c P_2 = P_4$  :

(i;j)	A	B	A* <sub>(i;j)</sub> B
(1, 2; 1, 2)	1 2	1 2	13 24
	1 2	2 1	14 23
	2 1	1 2	23 14
	2 1	2 1	24 13
(1; 1, 2)	12	1 2	123 4
	12	2 1	124 3
(1; 2)	12	12	12 34

(i;j)	A	B	A* <sub>(i;j)</sub> B
(2; 1, 2)	12	1 2	3 124
	12	2 1	4 123
(1, 2; 1)	1 2	12	134 2
	2 1	12	234 1
(1, 2; 2)	1 2	12	1 234
	2 1	12	2 134
(2; 1)	12	12	34 12

Fraction products  $a/b$  reappear in Section 8 as combinatorial joins  $a *_c b$ .

#### 4. SUBMODULES OF $TTM$

Let  $M = \{M_{n,m}\}_{m,n \geq 1}$  be a bigraded module over a commutative ring  $R$  with identity  $1_R$ . Various submodules of  $TTM$  will be important in our work, the most basic of which is the  $q \times p$  matrix submodule  $(M^{\otimes p})^{\otimes q}$ . The name ‘‘matrix submodule’’ is motivated by the fact that each pair of  $q \times p$  matrices  $X = (x_{ij})$ ,  $Y = (y_{ij}) \in \mathbb{N}^{q \times p}$  with  $p, q \geq 1$  uniquely determines the submodule

$$M_{Y,X} = (M_{y_{1,1},x_{1,1}} \otimes \cdots \otimes M_{y_{1,p},x_{1,p}}) \otimes \cdots \otimes (M_{y_{q,1},x_{q,1}} \otimes \cdots \otimes M_{y_{q,p},x_{q,p}}) \subset TTM.$$

Fix a set of bihomogeneous module generators  $G \subset M$ . A *monomial in  $TM$*  is an element  $A \in G^{\otimes p}$  and a *monomial in  $TTM$*  is an element  $B \in (G^{\otimes p})^{\otimes q}$ . Thus  $B$  is naturally represented by the  $q \times p$  matrix

$$[B] = \begin{bmatrix} g_{x_{1,1}}^{y_{1,1}} & \cdots & g_{x_{1,p}}^{y_{1,p}} \\ \vdots & & \vdots \\ g_{x_{q,1}}^{y_{q,1}} & \cdots & g_{x_{q,p}}^{y_{q,p}} \end{bmatrix}$$

whose entries lie in  $G$  and whose rows are identified with elements of  $G^{\otimes p}$ . Indeed,  $B$  is the  $q$ -fold tensor product of the rows of  $[B]$ ; we refer to  $B$  as a  $q \times p$  *monomial* and use the symbols  $B$  and  $[B]$  interchangeably. Consequently,

$$(M^{\otimes p})^{\otimes q} = \bigoplus_{X,Y \in \mathbb{N}^{q \times p}} M_{Y,X}$$

and we refer to

$$\overline{\mathbf{M}} = \bigoplus_{\substack{X,Y \in \mathbb{N}^{q \times p} \\ p,q \geq 1}} M_{Y,X} \quad \text{and} \quad \overline{\mathbf{V}} = \overline{\mathbf{M}} \Big/ \bigoplus_{\substack{X,Y \notin \mathbb{N}^{1 \times p} \cup \mathbb{N}^{q \times 1} \\ p,q \geq 1}} M_{Y,X}$$

as the *matrix submodule* and the *vector submodule*, respectively. The matrix transpose  $A \mapsto A^T$  induces the permutation of tensor factors  $\sigma_{p,q} : (M^{\otimes p})^{\otimes q} \xrightarrow{\cong} (M^{\otimes q})^{\otimes p}$  given by

$$(4.1) \quad \begin{aligned} & \left( \alpha_{x_{1,1}}^{y_{1,1}} \otimes \cdots \otimes \alpha_{x_{1,p}}^{y_{1,p}} \right) \otimes \cdots \otimes \left( \alpha_{x_{q,1}}^{y_{q,1}} \otimes \cdots \otimes \alpha_{x_{q,p}}^{y_{q,p}} \right) \mapsto \\ & \left( \alpha_{x_{1,1}}^{y_{1,1}} \otimes \cdots \otimes \alpha_{x_{q,1}}^{y_{q,1}} \right) \otimes \cdots \otimes \left( \alpha_{x_{1,p}}^{y_{1,p}} \otimes \cdots \otimes \alpha_{x_{q,p}}^{y_{q,p}} \right). \end{aligned}$$

Let  $\mathbf{x}, \mathbf{y} \in \mathbb{N}^{q \times p}$  denote matrices with constant columns and constant rows, respectively, and define

$$\overline{\mathbf{M}}_{row} = \bigoplus_{\mathbf{x}, \mathbf{y} \in \mathbb{N}^{q \times p}; p, q \geq 1} M_{Y, \mathbf{x}} \quad \text{and} \quad \overline{\mathbf{M}}^{col} = \bigoplus_{X, \mathbf{y} \in \mathbb{N}^{q \times p}; p, q \geq 1} M_{\mathbf{y}, X}.$$

Consider  $q \times p$  monomials

$$A = \begin{bmatrix} \alpha_{x_1}^{y_{1,1}} & \cdots & \alpha_{x_p}^{y_{1,p}} \\ \vdots & & \vdots \\ \alpha_{x_1}^{y_{q,1}} & \cdots & \alpha_{x_p}^{y_{q,p}} \end{bmatrix} \in M_{Y, \mathbf{x}} \quad \text{and} \quad B = \begin{bmatrix} \beta_{x_{1,1}}^{y_1} & \cdots & \beta_{x_{1,p}}^{y_1} \\ \vdots & & \vdots \\ \beta_{x_{q,1}}^{y_q} & \cdots & \beta_{x_{q,p}}^{y_q} \end{bmatrix} \in M_{\mathbf{y}, X}.$$

The *row (or coderivation) leaf sequence* of  $A$  is the  $p$ -tuple of lower (input) indices  $rls(A) = (x_1, \dots, x_p)$  along each row of  $A$ . Dually, the *column (or derivation) leaf sequence* of  $B$  is the  $q$ -tuple of upper (output) indices  $cls(B) = (y_1, \dots, y_q)^T$  along each column of  $B$ . Pictorially, each graph in the  $j^{th}$  column of  $A$  has  $x_j$  inputs and each graph in the  $i^{th}$  row of  $B$  has  $y_i$  outputs (see Figure 9).

The *bisequence submodule* is the intersection

$$\mathbf{M} = \overline{\mathbf{M}}_{row} \cap \overline{\mathbf{M}}^{col} = \bigoplus_{\mathbf{x}, \mathbf{y} \in \mathbb{N}^{q \times p}; p, q \geq 1} M_{\mathbf{y}, \mathbf{x}}.$$

A  $q \times p$  monomial  $A \in \mathbf{M}$  is represented as a *bisequence matrix* of the form

$$(4.2) \quad A = \begin{bmatrix} \alpha_{x_1}^{y_1} & \cdots & \alpha_{x_p}^{y_1} \\ \vdots & & \vdots \\ \alpha_{x_1}^{y_q} & \cdots & \alpha_{x_p}^{y_q} \end{bmatrix},$$

in which case  $rls(A) = (x_1, \dots, x_p)$ ,  $cls(A) = (y_1, \dots, y_q)^T$ . Since  $\mathbf{M}$  plays a central role in this exposition, we let  $\mathbf{M}_{\mathbf{x}}^{\mathbf{y}} = \langle A \in \mathbf{M} \mid \mathbf{x} = rls(A) \text{ and } \mathbf{y} = cls(A) \rangle$  so that

$$\mathbf{M} = \bigoplus_{\substack{\mathbf{x} \times \mathbf{y} \in \mathbb{N}^{1 \times p} \times \mathbb{N}^{q \times 1} \\ p, q \geq 1}} \mathbf{M}_{\mathbf{x}}^{\mathbf{y}}.$$

By identifying  $(H^{\otimes q})^{\otimes p} \approx (H^{\otimes p})^{\otimes q}$  with  $(q, p) \in \mathbb{N}^2$ , we can think of a  $q \times p$  monomial  $A \in \mathbf{M}_{\mathbf{x}}^{\mathbf{y}}$  as an operator on the positive integer lattice  $\mathbb{N}^2$  and pictured as an arrow from  $(|\mathbf{x}|, q)$  to  $(p, |\mathbf{y}|)$  (see Figure 9 and Example 9). While this representation is helpful conceptually, it is unfortunately not faithful.

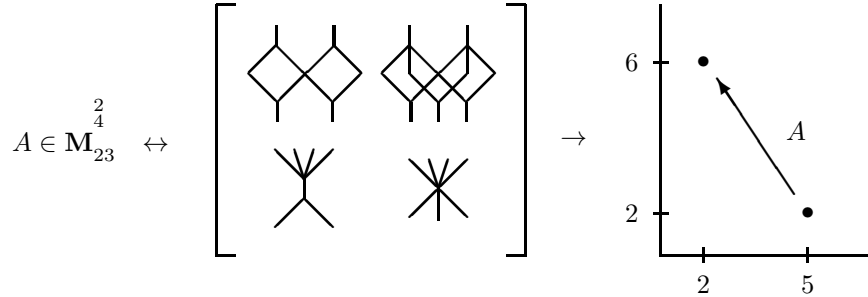

Figure 9. A  $2 \times 2$  monomial in  $\mathbf{M}$  and its arrow representation.

Unless explicitly indicated otherwise, we henceforth assume that  $\mathbf{x} \times \mathbf{y} = (x_1, \dots, x_p) \times (y_1, \dots, y_q)^T \in \mathbb{N}^{1 \times p} \times \mathbb{N}^{q \times 1}$  with  $p, q \geq 1$ . When the context is clear, we will often write  $\mathbf{y}$  as a row vector. The *bisequence vector submodule* is the intersection

$$\mathbf{V} = \overline{\mathbf{V}} \cap \mathbf{M} = M \oplus \bigoplus_{\mathbf{x}, \mathbf{y} \in \mathbb{N}; s, t \in \mathbb{N}} \mathbf{M}_s^{\mathbf{y}} \oplus \mathbf{M}_{\mathbf{x}}^t.$$

**Example 4.** Let  $M = M_{1,1} \oplus M_{2,2} = \langle \theta_1^1 \rangle \oplus \langle \theta_2^2 \rangle$ . Then the bisequence vector submodule of TTM is

$$\begin{aligned} \mathbf{V} &= \mathbf{M}_1^1 \oplus \mathbf{M}_{11}^1 \oplus \mathbf{M}_{111}^1 \oplus \dots \oplus \mathbf{M}_1^{11} \oplus \mathbf{M}_1^{111} \oplus \dots \oplus \\ &\quad \mathbf{M}_2^2 \oplus \mathbf{M}_{22}^2 \oplus \mathbf{M}_{222}^2 \oplus \dots \oplus \mathbf{M}_2^{22} \oplus \mathbf{M}_2^{222} \oplus \dots \\ &\approx T^+(M_{1,1}) \oplus T^+(M_{1,1}) \oplus T^+(M_{2,2}) \oplus T^+(M_{2,2}). \end{aligned}$$

A submodule

$$\mathbf{W} = M \oplus \bigoplus_{\mathbf{x}, \mathbf{y} \in \mathbb{N}; s, t \in \mathbb{N}} \mathbf{W}_s^{\mathbf{y}} \oplus \mathbf{W}_{\mathbf{x}}^t \subseteq \mathbf{V}$$

is *telescoping* if for all  $\mathbf{x}, \mathbf{y}, s, t$

- (i)  $\mathbf{W}_s^{\mathbf{y}} \subseteq \mathbf{M}_s^{\mathbf{y}}, \mathbf{W}_{\mathbf{x}}^t \subseteq \mathbf{M}_{\mathbf{x}}^t$ ;
- (ii)  $\alpha_s^{y_1} \otimes \dots \otimes \alpha_s^{y_q} \in \mathbf{W}_s^{\mathbf{y}}$  implies  $\alpha_s^{y_1} \otimes \dots \otimes \alpha_s^{y_j} \in \mathbf{W}_s^{y_1 \dots y_j}$  for all  $j < q$ ;
- (iii)  $\beta_{x_1}^t \otimes \dots \otimes \beta_{x_p}^t \in \mathbf{W}_{\mathbf{x}}^t$  implies  $\beta_{x_1}^t \otimes \dots \otimes \beta_{x_i}^t \in \mathbf{W}_{x_1 \dots x_i}^t$  for all  $i < p$ .

The term “telescoping” reflects the fact that if  $\beta_{x_1}^t \otimes \dots \otimes \beta_{x_p}^t \in \mathbf{W}$  for some  $p$ , the truncations  $\beta_{x_1}^t \otimes \dots \otimes \beta_{x_i}^t \in \mathbf{W}$  for all  $i < p$ . Note that  $\mathbf{W}_{\mathbf{x}}^t$  is some submodule of  $\mathbf{M}_{x_1}^t \otimes \dots \otimes \mathbf{M}_{x_p}^t$  and is not necessarily of the form  $B_1 \otimes \dots \otimes B_p$  with  $B_i \subseteq \mathbf{M}_{x_i}^t$ .

The “telescopic extension” of a telescoping submodule  $\mathbf{W}$  is the submodule  $\mathcal{W} \subseteq \overline{\mathbf{M}}$  defined as follows: Given  $X = (x_{i,j}), Y = (y_{i,j}) \in \mathbb{N}^{q \times p}$  and  $1 \leq i \leq q$ , consider the  $i^{\text{th}}$  row  $(y_{i,1}, \dots, y_{i,p})$  of  $Y$  and its constant substrings of maximal length, i.e., let  $1 = t_1 < t_2 < \dots < t_{k_i+1} = p + 1$  be those column indices such that for  $t_r \leq u < t_{r+1}$  and  $1 \leq r \leq k_i$  we have  $y_{i,t_r} = y_{i,u} \neq y_{i,t_{r+1}}$ . Form the row matrix  $\mathbf{x}_{i,r} = (x_{i,t_r}, \dots, x_{i,t_{r+1}-1})$  and define

$$W'_{Y,X} = \left( \mathbf{W}_{\mathbf{x}_{1,1}}^{y_{1,1}} \otimes \dots \otimes \mathbf{W}_{\mathbf{x}_{1,k_1}}^{y_{1,t_{k_1}}} \right) \otimes \dots \otimes \left( \mathbf{W}_{\mathbf{x}_{q,1}}^{y_{q,1}} \otimes \dots \otimes \mathbf{W}_{\mathbf{x}_{q,k_q}}^{y_{q,t_{k_q}}} \right).$$

Then  $q \times p$  monomials in  $W'_{Y,X}$  are block matrices whose blocks are row matrices in  $\mathbf{W}_{\mathbf{x}_{i,r}}^{y_{i,t_r}}$ , but unlike standard block matrices, the number of blocks in each row may vary. We remark that block matrices of this kind, as well as their refinements obtained by subdividing the given blocks, appear in general “Block Transverse Pairs” defined below. Dually, obtain  $W''_{Y,X}$  by considering the  $j^{\text{th}}$  row  $(x_{j,1}, \dots, x_{j,p})$  of  $X$  and its constant substrings of maximal length. Let  $\mathbf{y}_{j,r} = (y_{j,1}, \dots, y_{j,t_{r+1}-1})^T$  and note that  $q \times p$  monomials in  $\sigma_{p,q} W''_{Y,X}$  are block matrices whose blocks are column matrices in  $\mathbf{W}_{x_{j,t_r}}^{y_{j,r}}$ . Define

$$\mathcal{W}' = \bigoplus_{X, Y \in \mathbb{N}^{q \times p}; p, q \geq 1} W'_{Y,X} \quad \text{and} \quad \mathcal{W}'' = \bigoplus_{X, Y \in \mathbb{N}^{q \times p}; p, q \geq 1} \sigma_{p,q} W''_{Y,X};$$

then the *telescopic extension* of  $\mathbf{W}$  is

$$\mathcal{W} = \mathcal{W}' \cap \mathcal{W}'' \subseteq \overline{\mathbf{M}}.$$

In view of 4.1,  $\mathcal{W}$  contains all bisequence matrices with rows in some  $\mathbf{W}_{\mathbf{x}}^q$ .

**Remark 1.** When constructing the  $i^{\text{th}}$  (parenthesized) block  $\mathbf{W}_{\mathbf{x}_{i,1}}^{y_{i,1}} \otimes \cdots \otimes \mathbf{W}_{\mathbf{x}_{i,k_i}}^{y_{i,t_{k_i}}}$  of  $W'_{Y,X}$  (and dually, the  $j^{\text{th}}$  block of  $W''_{Y,X}$ ), there are two extremes:

- (i) If adjacent entries in the  $i^{\text{th}}$  row of  $Y$  are distinct, then  $k_i = p$  and the  $i^{\text{th}}$  block of  $W'_{Y,X}$  is  $\mathbf{M}_{\mathbf{x}_{i,1}}^{y_{i,1}} \otimes \cdots \otimes \mathbf{M}_{\mathbf{x}_{i,p}}^{y_{i,p}}$  since  $\mathbf{W}_a^b = \mathbf{M}_a^b$  (and dually for the  $j^{\text{th}}$  row of  $X$ ).
- (ii) If all entries in the  $i^{\text{th}}$  row of  $Y$  are equal, i.e.,  $y_{i,r} = q$  for all  $r$ , then the  $i^{\text{th}}$  block of  $W'_{Y,X}$  is  $\mathbf{W}_{\mathbf{x}_{i,1}}^q$  (and dually for the  $j^{\text{th}}$  row of  $X$ ).

## 5. PREMATRADS

**5.1.  $\Upsilon$ -products on  $\overline{\mathbf{M}}$ .** Given a family of maps  $\bar{\gamma} = \{M^{\otimes q} \otimes M^{\otimes p} \rightarrow M\}_{p,q \geq 1}$ , we describe a canonical extension of the component  $\gamma = \{\gamma_{\mathbf{x}}^{\mathbf{y}} : \mathbf{M}_{\mathbf{p}}^{\mathbf{y}} \otimes \mathbf{M}_{\mathbf{x}}^{\mathbf{q}} \rightarrow \mathbf{M}_{|\mathbf{x}|}^{|\mathbf{y}|}\}$  to a global product  $\Upsilon : \overline{\mathbf{M}} \otimes \overline{\mathbf{M}} \rightarrow \overline{\mathbf{M}}$ . Pairs of bisequence matrices in  $\mathbf{M}_{\mathbf{p}}^{\mathbf{y}} \otimes \mathbf{M}_{\mathbf{x}}^{\mathbf{q}}$  are called “transverse pairs.”

**Definition 2.** Let  $M = \{M_{n,m}\}_{m,n \geq 1}$  be a bigraded  $R$ -module. A  $(q \times s, t \times p)$  monomial pair  $A \otimes B = [\alpha_{v_{kl}}^{y_{kl}}] \otimes [\beta_{x_{ij}}^{u_{ij}}] \in \overline{\mathbf{M}} \otimes \overline{\mathbf{M}}$  is a

- (i) Transverse Pair (TP) if  $s = t = 1$ ,  $u_{1,j} = q$ , and  $v_{k,1} = p$  for all  $j$  and  $k$ , i.e., setting  $x_j = x_{1,j}$  and  $y_k = y_{k,1}$  gives

$$A \otimes B = \begin{bmatrix} \alpha_p^{y_1} \\ \vdots \\ \alpha_p^{y_q} \end{bmatrix} \otimes \begin{bmatrix} \beta_{x_1}^q & \cdots & \beta_{x_p}^q \end{bmatrix} \in \mathbf{M}_{\mathbf{p}}^{\mathbf{y}} \otimes \mathbf{M}_{\mathbf{x}}^{\mathbf{q}}.$$

- (ii) Block Transverse Pair (BTP) if there exist  $t \times s$  block decompositions  $A = [A'_{k',\ell}]$  and  $B = [B'_{i,j}]$  such that  $A'_{i\ell} \otimes B'_{i\ell}$  is a TP for all  $i$  and  $\ell$ .

Unlike the blocks in a standard block matrix, the blocks  $A'_{i\ell}$  (or  $B'_{i\ell}$ ) of a BTP  $A \otimes B \in \overline{\mathbf{M}} \otimes \overline{\mathbf{M}}$  may vary in length within a given row (or column). However, if  $A \otimes B \in \mathbf{M}_{p_1 \cdots p_s}^{y_1 \cdots y_t} \otimes \mathbf{M}_{x_1 \cdots x_s}^{q_1 \cdots q_t}$  is a BTP, each TP  $A'_{i\ell} \otimes B'_{i\ell} \in \mathbf{M}_{p_\ell}^{y_i} \otimes \mathbf{M}_{x_\ell}^{q_i}$  so that for fixed  $i$  (or  $\ell$ ) the blocks  $A'_{i\ell}$  (or  $B'_{i\ell}$ ) have constant length  $q_i$  (or  $p_\ell$ ). BTP block decomposition is unique; furthermore,  $A \otimes B \in \mathbf{M}_{\mathbf{v}}^{\mathbf{y}} \otimes \mathbf{M}_{\mathbf{x}}^{\mathbf{u}}$  is a BTP if and only if  $\mathbf{x} \times \mathbf{y} \in \mathbb{N}^{1 \times |\mathbf{v}|} \times \mathbb{N}^{|\mathbf{u}| \times 1}$  if and only if the initial point of arrow  $A$  coincides with the terminal point of arrow  $B$ .

**Example 5.** A  $(4 \times 2, 2 \times 3)$  monomial pair  $A \otimes B \in \mathbf{M}_{21}^{1543} \otimes \mathbf{M}_{123}^{31}$  is a  $2 \times 2$  BTP per the block decompositions

$$A = \begin{bmatrix} \alpha_2^1 & \alpha_1^1 \\ \alpha_2^5 & \alpha_1^5 \\ \alpha_2^4 & \alpha_1^4 \\ \alpha_2^3 & \alpha_1^3 \end{bmatrix} \quad B = \begin{bmatrix} \beta_1^3 & \beta_2^3 & \beta_3^3 \\ \beta_1^1 & \beta_2^1 & \beta_3^1 \end{bmatrix}.$$

Given a family of maps  $\bar{\gamma} = \{M^{\otimes q} \otimes M^{\otimes p} \rightarrow M\}_{p,q \geq 1}$ , extend the component  $\gamma = \{\gamma_{\mathbf{x}}^{\mathbf{y}} : \mathbf{M}_{\mathbf{p}}^{\mathbf{y}} \otimes \mathbf{M}_{\mathbf{x}}^{\mathbf{q}} \rightarrow \mathbf{M}_{|\mathbf{x}|}^{|\mathbf{y}|}\}$  to a global product  $\Upsilon : \overline{\mathbf{M}} \otimes \overline{\mathbf{M}} \rightarrow \overline{\mathbf{M}}$  by defining

$$(5.1) \quad \Upsilon(A \otimes B) = \begin{cases} [\gamma(A'_{ij} \otimes B'_{ij})], & A \otimes B \text{ is a BTP} \\ 0, & \text{otherwise,} \end{cases}$$

where  $A'_{ij} \otimes B'_{ij}$  is the  $(i, j)^{th}$  TP in the BTP decomposition of  $A \otimes B$ .

We denote the  $\Upsilon$ -product by “.” or juxtaposition. When  $A \otimes B = [\alpha_p^{y_j}]^T \otimes [\beta_{x_i}^q]$  is a TP, we write

$$AB = \gamma(\alpha_p^{y_1}, \dots, \alpha_p^{y_q}; \beta_{x_1}^q, \dots, \beta_{x_p}^q).$$

As an arrow,  $AB$  “transgresses” from the  $x$ -axis to the  $y$ -axis  $\mathbb{N}^2$ . When  $A^{q \times s} \otimes B^{t \times p} \in \mathbf{M}_{\mathbf{y}}^{\mathbf{y}} \otimes \mathbf{M}_{\mathbf{x}}^{\mathbf{u}}$  is a BTP and  $A'_{ij} \otimes B'_{ij} \in \mathbf{M}_{p_j}^{\mathbf{y}_i} \otimes \mathbf{M}_{x_j}^{\mathbf{q}_i}$  is its BTP decomposition,  $AB$  is a  $t \times s$  matrix in  $\mathbf{M}_{|\mathbf{x}_1| \dots |\mathbf{x}_s|}^{|\mathbf{y}_1| \dots |\mathbf{y}_t|}$ . As an arrow,  $AB$  runs from the initial point of  $B$  to the terminal point of  $A$ .

Note that  $\Upsilon$ -products always restrict to the submodules  $\mathbf{M}_{row}$  and  $\mathbf{M}^{col}$ , and consequently to  $\mathbf{M}$ . To see this, consider a BTP  $A \otimes B \in \mathbf{M}^{col} \otimes \mathbf{M}^{col}$  with block decomposition  $[A'_{ij}] \otimes [B'_{ij}]$ . Since each entry along the  $i^{th}$  row of  $B$  has  $q$  outputs, each block  $A'_{ij}$  is a column of length  $q$ . Since all entries along a row of  $A$  have the same number of outputs, the total number of outputs from each block  $A'_{ij}$  is the same for all  $j$ . Thus  $AB \in \mathbf{M}^{col}$ , and dually  $\mathbf{M}_{row} \cdot \mathbf{M}_{row} \subseteq \mathbf{M}_{row}$ .

**Example 6.** Continuing Example 5, the action of  $\Upsilon$  on the  $(4 \times 2, 2 \times 3)$  monomial pair  $A \otimes B \in \mathbf{M}_{21}^{1543} \otimes \mathbf{M}_{123}^{31}$  produces a  $2 \times 2$  monomial in  $\mathbf{M}_{33}^{10,3}$ :

$$\left[ \begin{array}{|c|c|} \hline \alpha_2^1 & \alpha_1^1 \\ \hline \alpha_2^5 & \alpha_1^5 \\ \hline \alpha_2^4 & \alpha_1^4 \\ \hline \alpha_2^3 & \alpha_1^3 \\ \hline \end{array} \right] \left[ \begin{array}{|c|c|c|} \hline \beta_1^3 & \beta_2^3 & \beta_3^3 \\ \hline \beta_1^1 & \beta_2^1 & \beta_3^1 \\ \hline \end{array} \right] = \left[ \begin{array}{|c|c|c|} \hline \alpha_2^1 & & \alpha_1^1 \\ \hline \alpha_2^5 & \beta_1^3 & \beta_2^3 & \alpha_1^5 & \beta_3^3 \\ \hline \alpha_2^4 & & & \alpha_1^4 & \\ \hline \alpha_2^3 & \beta_1^1 & \beta_2^1 & \alpha_1^3 & \beta_3^1 \\ \hline \end{array} \right]$$

In the target,  $(|\mathbf{x}_1|, |\mathbf{x}_2|) = (1 + 2, 3)$  since  $(p_1, p_2) = (2, 1)$ ; and  $(|\mathbf{y}_1|, |\mathbf{y}_2|) = (1 + 5 + 4, 3)$  since  $(q_1, q_2) = (3, 1)$ . As an arrow in  $\mathbb{N}^2$ ,  $AB$  initializes at  $(6, 2)$  and terminates at  $(2, 13)$ .

**5.2. Prematrads Defined.** Let  $1^{1 \times p} = (1, \dots, 1) \in \mathbb{N}^{1 \times p}$  and  $1^{q \times 1} = (1, \dots, 1)^T \in \mathbb{N}^{q \times 1}$ ; we often suppress the exponents when the context is clear.

**Definition 3.** A prematrad  $(M, \gamma, \eta)$  is a bigraded  $R$ -module  $M = \{M_{n,m}\}_{m,n \geq 1}$  together with a family of structure maps  $\gamma = \{\gamma_{\mathbf{x}}^{\mathbf{y}} : \mathbf{M}_{\mathbf{p}}^{\mathbf{y}} \otimes \mathbf{M}_{\mathbf{x}}^{\mathbf{q}} \rightarrow \mathbf{M}_{|\mathbf{x}|}^{|\mathbf{y}|}\}$  and a unit  $\eta : R \rightarrow \mathbf{M}_1^1$  such that

- (i) the induced map  $\Upsilon$  is associative on  $\mathbf{M}$  and
- (ii) for all  $a, b \in \mathbb{N}$ , the following compositions are the canonical isomorphisms:

$$\begin{aligned} R^{\otimes b} \otimes \mathbf{M}_a^b &\xrightarrow{\eta^{\otimes b} \otimes \text{Id}} \mathbf{M}_1^{b \times 1} \otimes \mathbf{M}_a^b \xrightarrow{\gamma_a^{1^{b \times 1}}} \mathbf{M}_a^b; \\ \mathbf{M}_a^b \otimes R^{\otimes a} &\xrightarrow{\text{Id} \otimes \eta^{\otimes a}} \mathbf{M}_a^b \otimes \mathbf{M}_1^{1 \times a} \xrightarrow{\gamma_a^{1^{1 \times a}}} \mathbf{M}_a^b. \end{aligned}$$

We denote the element  $\eta(1_R)$  by  $\mathbf{1}_M$ .

A morphism of prematrads  $(M, \gamma)$  and  $(M', \gamma')$  is a map  $f : M \rightarrow M'$  such that  $f\gamma_{\mathbf{x}}^{\mathbf{y}} = \gamma'_{\mathbf{x}}{}^{\mathbf{y}}(f^{\otimes q} \otimes f^{\otimes p})$  for all  $\mathbf{y} \times \mathbf{x}$ .

**Remark 2.** If  $(M, \gamma)$  is a prematrad, the restrictions  $(M_{1,*}, \gamma_*^1)$  and  $(M_{*,1}, \gamma_1^*)$  are non- $\Sigma$  operads in the sense of May (see [9]).

Given a bisequence matrix  $A^{q \times p} \in \mathbf{M}_{\mathbf{x}}^{\mathbf{y}}$ , let  $\mathbf{1}^{q \times |\mathbf{x}|}$  and  $\mathbf{1}^{|\mathbf{y}| \times p}$  denote the (bisequence) matrices whose entries are constantly  $\mathbf{1}_M$ . Then in view of Axiom (ii) we have  $\Upsilon(\mathbf{1}^{|\mathbf{y}| \times p}; A) = A = \Upsilon(A; \mathbf{1}^{q \times |\mathbf{x}|})$ . Some examples of prematrads now follow.

**Example 7.** A non- $\Sigma$  operad  $(K, \gamma_*)$  with  $\gamma_{\mathbf{x}} : K(p) \otimes K(x_1) \otimes \cdots \otimes K(x_p) \rightarrow K(|\mathbf{x}|)$  is a prematrad via

$$M_{n,m} = \begin{cases} K(m), & \text{if } n = 1 \\ 0, & \text{otherwise} \end{cases} \quad \text{and} \quad \gamma_{\mathbf{x}}^{\mathbf{y}} = \begin{cases} \gamma_{\mathbf{x}}, & \text{if } \mathbf{y} = 1 \\ 0, & \text{otherwise} \end{cases}$$

(c.f. Remark 2). For a discussion of the differential in the special case  $K = \mathcal{A}_\infty$ , see Example 19.

**Example 8.** Let  $(K = \bigoplus_{n \geq 1} K(n), \gamma_*)$  and  $(L = \bigoplus_{m \geq 1} L(m), \gamma^*)$  be non- $\Sigma$  operads with  $K(1) = L(1)$  and the same unit  $\eta$ . Set

$$M_{n,m} = \begin{cases} K(n), & \text{if } m = 1 \\ L(m), & \text{if } n = 1 \\ 0, & \text{otherwise} \end{cases} \quad \text{and} \quad \gamma_{\mathbf{x}}^{\mathbf{y}} = \begin{cases} \gamma_{\mathbf{x}}, & \text{if } \mathbf{y} = 1 \\ \gamma^{\mathbf{y}}, & \text{if } \mathbf{x} = 1 \\ 0, & \text{otherwise,} \end{cases}$$

then  $(M, \gamma)$  is a prematrad.

**Example 9.** The Prematrad PROP  $M$ . There is a canonical prematrad structure on PROP  $M$ , denoted by  $M^{\text{PRE}}$ , with unit  $\eta$  determined by  $\eta(1_R) = \{\text{the unit of PROP } M\}$ . To define the structure map  $\gamma$ , let  $\mathbf{M}$  be the bisequence submodule of TTM. For  $p, q \geq 1$ , iterate the ‘‘horizontal’’ product  $\times : M_{n,m} \otimes M_{n',m'} \rightarrow M_{n+n',m+m'}$  in PROP  $M$  (c.f. [1], [9]) and obtain the map

$$\times^{q-1} \otimes \times^{p-1} : \mathbf{M}_{\mathbf{p}}^{\mathbf{y}} \otimes \mathbf{M}_{\mathbf{x}}^{\mathbf{q}} \longrightarrow \mathbf{M}_{\mathbf{pq}}^{|\mathbf{y}|} \otimes \mathbf{M}_{|\mathbf{x}|}^{qp},$$

where  $\times^0 = \text{Id}$ . View  $\alpha_{|\mathbf{x}|}^{qp} \in \mathbf{M}_{|\mathbf{x}|}^{qp}$  as a graph with  $p$  groups of  $q$  outputs  $(y_{1,1} \cdots y_{1,q}) \cdots (y_{p,1} \cdots y_{p,q})$  (labeled from left-to-right). The leaf permutation

$$\sigma_{q,p} : (y_{1,1} \cdots y_{1,q}) \cdots (y_{p,1} \cdots y_{p,q}) \mapsto (y_{1,1} \cdots y_{p,1}) \cdots (y_{1,q} \cdots y_{p,q})$$

induces a map  $\sigma_{q,p}^* : \mathbf{M}_{|\mathbf{x}|}^{qp} \rightarrow \mathbf{M}_{|\mathbf{x}|}^{pq}$ . And finally, let  $\circ : M_{c,b} \otimes M_{b,a} \rightarrow M_{c,a}$  be the ‘‘vertical’’ product in PROP  $M$ . Then  $\gamma$  is the sum of all compositions

$$(5.2) \quad \gamma_{\mathbf{x}}^{\mathbf{y}} : \mathbf{M}_{\mathbf{p}}^{\mathbf{y}} \otimes \mathbf{M}_{\mathbf{x}}^{\mathbf{q}} \xrightarrow{\times^{q-1} \otimes \times^{p-1}} \mathbf{M}_{\mathbf{pq}}^{|\mathbf{y}|} \otimes \mathbf{M}_{|\mathbf{x}|}^{qp} \xrightarrow{\text{Id} \otimes \sigma_{q,p}^*} \mathbf{M}_{\mathbf{pq}}^{|\mathbf{y}|} \otimes \mathbf{M}_{|\mathbf{x}|}^{pq} \xrightarrow{\circ} \mathbf{M}_{|\mathbf{x}|}^{|\mathbf{y}|}$$

and induces an associative  $\Upsilon$  product on  $\mathbf{M}$  whose values are matrices of (typically) non-planar graphs as in Figure 9. In particular, let  $H$  be a free DG  $R$ -module of finite type and view the universal PROP  $U_H = \text{End}(TH)$  as the bigraded  $R$ -module  $M = \{\text{Hom}(H^{\otimes m}, H^{\otimes n})\}_{n,m \geq 1}$ . Then a  $q \times p$  monomial  $A \in \mathbf{M}_{\mathbf{x}}^{\mathbf{y}}$  admits a representation as an operator on  $\mathbb{N}^2$  via the identification  $(H^{\otimes p})^{\otimes q} \leftrightarrow (p, q)$  with the action of  $A$  given by

$$\left( H^{\otimes |\mathbf{x}|} \right)^{\otimes q} \approx \left( H^{\otimes x_1} \otimes \cdots \otimes H^{\otimes x_p} \right)^{\otimes q} \xrightarrow{A} \left( H^{\otimes y_1} \right)^{\otimes p} \otimes \cdots \otimes \left( H^{\otimes y_q} \right)^{\otimes p}$$

$$\sigma_{y_1,p} \otimes \cdots \otimes \sigma_{y_q,p} (H^{\otimes p})^{\otimes y_1} \otimes \cdots \otimes (H^{\otimes p})^{\otimes y_q} \approx (H^{\otimes p})^{\otimes |\mathbf{y}|}.$$

Thus we think of  $A$  as an arrow  $(|\mathbf{x}|, q) \mapsto (p, |\mathbf{y}|)$  in  $\mathbb{N}^2$ . In this setting, the map  $\times^{q-1} \otimes \times^{p-1}$  in 5.2 is the canonical isomorphism and  $\gamma$  agrees with the composition product on the universal preCROC [15].

**Example 10.** The Universal Enveloping PROP  $U(M)$ . Recall that the structure map  $\gamma_{FP}$  in the free PROP  $FP(M)$  is the sum of all possible (iterated) “horizontal” and “vertical” products  $M_{n,m} \otimes M_{n',m'} \rightarrow M_{n+n',m+m'}$  and  $M_{c,b} \otimes M_{b,a} \rightarrow M_{c,a}$ . Furthermore, the tensor product induces left  $S_n$ - and right  $S_m$ -actions

$$M_{n,n} \otimes M_{n,m} \xrightarrow{\sigma \otimes \text{Id}} M_{n,n} \otimes M_{n,m} \xrightarrow{\gamma_{FP}} M_{n,m} \quad \text{and}$$

$$M_{n,m} \otimes M_{m,m} \xrightarrow{\text{Id} \otimes \sigma} M_{n,m} \otimes M_{m,m} \xrightarrow{\gamma_{FP}} M_{n,m}.$$

Thus if  $(M, \gamma_M)$  is a prematrad,  $\gamma_M$  is a component of  $\gamma_{FP}$  on  $\mathbf{M}_p^{\mathbf{y}} \otimes \mathbf{M}_m^{\mathbf{x}}$ . Let  $J$  be the two-sided ideal generated by  $\bigoplus_{\mathbf{x} \times \mathbf{y}} (\gamma_{FP} - \gamma_M) (\mathbf{M}_p^{\mathbf{y}} \otimes \mathbf{M}_m^{\mathbf{x}})$ . Then

$$U(M) = FP(M)/J$$

is the universal enveloping PROP on  $M$ . Note that the restriction of  $U$  to operads is the standard functor from operads to PROPs [1].

**5.3. Free Prematrad.** “Free prematrads” are fundamentally important. In Definition 4 below, we borrow our notation for the matrix and bisequence submodules of  $TTM$  and use  $\overline{\mathbf{G}}$  to denote the set of matrices over  $G^{\text{pre}}$  and  $\mathbf{G}$  to denote the subset of bisequence matrices in  $\overline{\mathbf{G}}$ .

**Definition 4.** Let  $\Theta = \langle \theta_m^n \rangle_{m,n \geq 1}$  be a free bigraded  $R$ -module generated by singletons  $\theta_m^n$  and set  $G_{1,1}^{\text{pre}} = \theta_1^1 = \mathbf{1} \neq 0$ . For  $mn \geq 2$  and each pair  $(i, j) \leq (m, n)$  such that  $i + j < m + n$ , assume  $G_{j,i}^{\text{pre}}$  has been constructed and define

$$G_{n,m}^{\text{pre}} = \bigcup_{\substack{i+j < m+n \\ (i,j) \leq (m,n)}} \theta_i^j \cup \{A_s \cdots A_1 \mid s \geq 2\}, \quad \text{where}$$

- (i)  $A_1 \in \mathbf{G}_{\mathbf{x}}^q$ ,  $|\mathbf{x}| = i$ ,
- (ii)  $A_s \in \mathbf{G}_p^{\mathbf{y}}$ ,  $|\mathbf{y}| = j$ ,
- (iii)  $A_r \in \overline{\mathbf{G}}$ ,  $1 < r < s$ , and
- (iv) some association of  $A_s \cdots A_1$  defines a sequence of BTPs.

Let  $\sim$  be the equivalence relation on  $G^{\text{pre}} = \bigcup_{m,n \geq 1} G_{n,m}^{\text{pre}}$  generated by

- (v)  $\{A\mathbf{1}^{1 \times p} \sim A \sim \mathbf{1}^{q \times 1}A \mid A \in \overline{\mathbf{G}}_p^q\}$ ,
- (vi)  $\{[A_{ij}B_{ij}] \sim [A_{ij}][B_{ij}] \mid [A_{ij}] \otimes [B_{ij}] \text{ is a BTP in } \overline{\mathbf{G}} \otimes \overline{\mathbf{G}}\}$ , and
- (vii)  $\{(AB)C \sim A(BC) \mid A \otimes B \text{ and } B \otimes C \text{ are BTPs in } \mathbf{G} \otimes \mathbf{G}\}$ .

Define  $\mathcal{G}^{\text{pre}} = G^{\text{pre}} / \sim$  and let  $F^{\text{pre}}(\Theta) = \langle \mathcal{G}^{\text{pre}} \rangle$ . Juxtaposition  $\gamma$  induces an associative product  $\Upsilon$  on  $\mathbf{F}^{\text{pre}}(\Theta)$ , the map  $\eta : R \rightarrow F_{1,1}^{\text{pre}}(\Theta)$  given by  $\eta(1_R) = \mathbf{1}$  is a unit, and  $(F^{\text{pre}}(\Theta), \gamma, \eta)$  is the free prematrad generated by  $\Theta$ .

**Example 11.** The  $\mathcal{A}_\infty$  operad. Let  $\theta_m = \theta_m^1 \neq 0$  and  $\theta^n = \theta_1^n \neq 0$  for all  $m, n \geq 1$ . The non-sigma operads  $K = F^{\text{pre}}(\theta_*)$  and  $L = F^{\text{pre}}(\theta^*)$  are isomorphic to the  $\mathcal{A}_\infty$  operad and encode the combinatorial structure of an  $\mathcal{A}_\infty$ -algebra and an  $\mathcal{A}_\infty$ -coalgebra, respectively. Let  $\theta_m^{p,i}$  denote the  $1 \times p$  matrix  $[\theta_1 \cdots \theta_m \cdots \theta_1]$  with  $\theta_m$  in the  $i^{\text{th}}$  position, and let  $\theta_{q,j}^n$  denote the  $q \times 1$  matrix  $[\theta^1 \cdots \theta^n \cdots \theta^1]^T$  with



$\theta^n$  in the  $j^{\text{th}}$  position. Then modulo prematrad axioms (i) and (ii), the bases for  $K$  and  $L$  given by Definition 4 are

$$\{\theta_{p_k} \theta_{m_k}^{p_k, i_k} \cdots \theta_{m_1}^{p_1, i_1} \in K \mid m_1 + p_1 - 1 \mid m_r = p_{r-1} - p_r + 1\} \quad \text{and}$$

$$\{\theta_{q_l, j_l}^{n_l} \cdots \theta_{q_1, j_1}^{n_1} \theta^{q_1} \in L \mid n_l + q_l - 1 \mid n_r = q_{r+1} - q_r + 1\}.$$

Given  $A \in \mathcal{G}_{n,m}^{\text{pre}} \subset F_{n,m}^{\text{pre}}(\Theta)$ , choose its representative  $A_s \cdots A_1 \in G_{n,m}^{\text{pre}}$ . Then in view of (iv), some association of  $A_s \cdots A_1$  defines a sequence of BTPs; thus  $s-1$  successive applications of  $\Upsilon$  produces a  $1 \times 1$  (bisequence) matrix  $B \in G_{n,m}^{\text{pre}}$ . Now consider all factorizations  $B_k \cdots B_1$  of  $B$  such that  $B_i \in \overline{\mathbf{G}}$  and  $B_i \neq \mathbf{1}$  for all  $i$ . Then some such factorization has maximal length.

**Definition 5.** Let  $A \in \mathcal{G}_{n,m}^{\text{pre}} \subset F_{n,m}^{\text{pre}}(\Theta)$ . A representative  $A_s \cdots A_1 \in G_{n,m}^{\text{pre}}$  of  $A$  is of  $\Theta$ -factorization if for all  $k \leq s$ , each entry of  $A_k$  is an element of  $\Theta$ . A representative  $B_k \cdots B_1 \in G_{n,m}^{\text{pre}}$  of  $A$  is of bisequence factorization if  $B_i \in \mathbf{G}$  and  $B_i \neq \mathbf{1}$  for all  $i \leq k$ . A balanced factorization is a bisequence factorization of maximal length.

**Remark 3.** The factors of each basis element in Example 11 are indecomposable with entries from  $\Theta$ . Consequently, these elements are balanced  $\Theta$ -factorizations.

Note that the  $\Theta$ -factorization

$$A_3 A_2 A_1 = \begin{bmatrix} \theta_1^1 \\ \theta_2^1 \end{bmatrix} \begin{bmatrix} \theta_2^1 & \theta_1^1 \\ \theta_1^1 & \theta_2^1 \end{bmatrix} [\theta_1^2 \quad \theta_1^2 \quad \theta_1^2] \in F_{2,3}^{\text{pre}}(\Theta)$$

is not a bisequence factorization since  $A_2$  is not a bisequence matrix. Also note that  $A_3 A_2 A_1$  only associates on the left since  $A_2 \otimes A_1$  is *not* a BTP. Let  $B_2 = \Upsilon(A_3; A_2) \in \mathbf{F}_{11,3}^{\text{pre}}(\Theta)$ ,  $B_1 = A_1 \in \mathbf{F}_{2,111}^{\text{pre}}(\Theta)$ , and  $B = \gamma(B_2; B_1) \in \mathbf{F}_{2,3}^{\text{pre}}(\Theta)$ ; then  $B_2 B_1$  and  $B$  are bisequence factorizations (see Figure 10) of which

$$(5.3) \quad B_2 B_1 = \begin{bmatrix} \theta_2^1 [\theta_2^1 \quad \theta_1^1] \\ \theta_1^1 [\theta_1^1 \quad \theta_2^1] \end{bmatrix} [\theta_1^2 \quad \theta_1^2 \quad \theta_1^2]$$

is balanced.

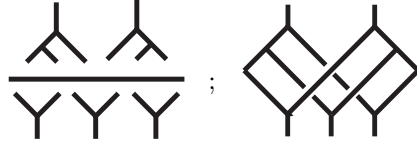

Figure 10. Graphical representations of  $B_2 B_1$  and  $B$ .

In view of Definition 4 item (vii),  $\Upsilon$  is associative on  $\mathbf{F}^{\text{pre}}(\Theta)$ . Although the fractions corresponding to various associations of a bisequence factorization represent the same graph, these fractions can look quite different. For example, the two associations of

$$(5.4) \quad C_3 C_2 C_1 = \begin{bmatrix} \theta_2^2 \\ \theta_2^2 \\ \theta_2^1 \end{bmatrix} \begin{bmatrix} \theta_2^2 & \theta_1^2 \\ \theta_2^2 & \theta_1^1 \end{bmatrix} [\theta_2^2 \quad \theta_1^2 \quad \theta_1^2] \in \mathbf{F}_{5,4}^{\text{pre}}(\Theta)$$

are represented by the fractions

$$\frac{\frac{\frac{XX}{XY} \lambda}{XY}}{\frac{XY}{YY}} = \frac{\frac{XX}{XY} \lambda}{\frac{XY}{YY}}$$

$$(C_3 C_2) C_1 = C_3 (C_2 C_1).$$

In terms of Example 9, there is a polygonal path in  $\mathbb{N}^2$  that represents the balanced  $\Theta$ -factorization in (5.4) and is constructed in one of two ways, depending on the choice of association. If we associate on the left and think of (5.4) as the composition

$$H^{\otimes 4} \xrightarrow{XVY} (H^{\otimes 2})^{\otimes 3} \xrightarrow{\sigma_{2,3}} (H^{\otimes 3})^{\otimes 2} \xrightarrow{(XV)(\lambda)} (H^{\otimes 2})^{\otimes 3} \xrightarrow{\sigma_{2,2} \otimes 1} (H^{\otimes 2})^{\otimes 3} \xrightarrow{(XX)\lambda} H^{\otimes 5}$$

in PROP  $M$ , we obtain the polygonal path in Figure 11.

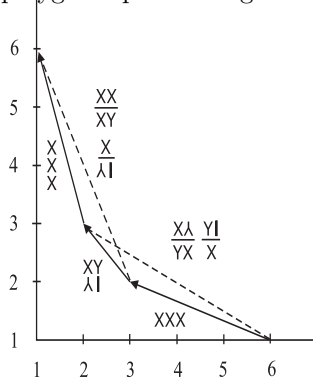
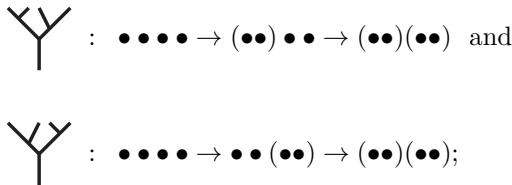

Figure 11: The polygonal path of  $(C_3 C_2) C_1$ .

When  $m, n > 1$ , balanced factorizations  $A_s \cdots A_1$  of a monomial  $A \in \mathbf{F}_{n,m}^{\text{pre}}(\Theta)$  are unique. But when  $A_1$  or  $A_s$  is a  $1 \times 1$ -matrix (which always happens in the operadic cases  $m = 1$  or  $n = 1$ ), there are multiple balanced factorizations of  $A$ , each of which can be identified with some planar rooted leveled tree (PLT). Recall that a PLT with  $s$  levels and  $k$  leaves specifies the order in which  $s$  pairs of parentheses are inserted into a string of  $k$  indeterminants. Thus, each representative of an isomorphism class of PLTs with  $s$  levels represents a different factorization of the same monomial. When such factorizations are balanced, *we always choose the factorization that successively inserts left-most parentheses first*. Given this selection criterion, we henceforth refer to “*the balanced factorization*” of  $A$ . For example, the balanced factorizations  $B_3 B_2 B_1 = [\theta^2 \ \theta^1 \ \theta^1]^T [\theta^1 \ \theta^2]^T \theta^2$  and  $B'_3 B'_2 B'_1 = [\theta^1 \ \theta^1 \ \theta^2]^T [\theta^2 \ \theta^1]^T \theta^2$  in  $L(4) = \mathbf{F}_{4,1}^{\text{pre}}(\Theta)$  are identified with the respective PLTs



hence  $B_3B_2B_1$  is the balanced factorization of  $A = \gamma(\gamma(B_3; B_2); B_1)$ .

We now construct a set that conveniently indexes the module generators  $\mathcal{G}^{\text{pre}} \subset F^{\text{pre}}(\Theta)$ . Define a map  $\phi : \mathcal{G}^{\text{pre}} \rightarrow G^{\text{pre}}$  that splits the projection  $G^{\text{pre}} \rightarrow \mathcal{G}^{\text{pre}} = G^{\text{pre}} / \sim$  as follows: For each pair  $(m, n)$  with  $m + n \leq 3$ , set  $\phi(\text{cls } \theta_m^n) = \theta_m^n$ . Inductively, for each pair  $(m, n)$  with  $m + n \geq 4$ , assume that  $\phi$  has been defined on  $\mathcal{G}_{j,i}^{\text{pre}}$  for  $i + j < m + n$ . Then given a class  $g \in \mathcal{G}_{n,m}^{\text{pre}}$ , define  $\phi(g)$  to be its balanced representative and let  $\mathcal{B}^{\text{pre}} = \bigcup \mathcal{B}_{n,m}^{\text{pre}} = \text{Im } \phi$ .

Although a general element of  $\beta \in \mathcal{B}^{\text{pre}}$  is not a  $\Theta$ -factorization, there is a related PLT  $\Psi(\beta)$  whose leaves are  $\Theta$ -factorizations. Let  $B_s \cdots B_1$  be the balanced factorization of  $\beta$ , and let  $(\beta_k)$  denote the tuple of entries of  $B_k$  listed in row order. If the entries of each  $B_k$  are  $\Theta$ -factorizations, set  $\Psi(\beta) = \Psi_1(\beta) = \beta$ . Otherwise, replace those entries of each  $B_k$  that are not  $\Theta$ -factorizations with their balanced factorizations and form the 2-level tree  $\Psi_2(\beta)$  with root  $\beta$  and leaves labeled by the entries of the  $(\beta_k)$ 's, i.e.,

$$(5.5) \quad \Psi_2(\beta) = \begin{array}{c} B_s \cdots B_1 \\ \diagup \quad | \quad \diagdown \\ (\beta_s) \quad \cdots \quad (\beta_k) \quad \cdots \quad (\beta_1) \end{array}$$

If the leaves of  $\Psi_2(\beta)$  are  $\Theta$ -factorizations, set  $\Psi(\beta) = \Psi_2(\beta)$ . Otherwise, replace those entries of each  $(\beta_k)$  that are not  $\Theta$ -factorizations with their balanced factorizations and obtain the 3-level tree  $\Psi_3(\beta)$  by appending the tree  $\Psi_2(\beta')$  to the branch of each leaf  $\beta'$ . If each level 3 entry of  $\Psi_3(\beta)$  is a  $\Theta$ -factorization, set  $\Psi(\beta) = \Psi_3(\beta)$ ; otherwise continue inductively. This process terminates after  $r$  steps and uniquely determines an  $r$ -level tree  $\Psi(\beta)$  whose leaves are balanced  $\Theta$ -factorizations.

**Example 12.** *The 3-level tree associated with the balanced factorization  $B_2B_1$  in (5.3) above is*

$$\begin{array}{c} B_2B_1 \\ \diagup \quad | \quad \diagdown \quad \diagdown \\ (\theta_2^1 [ \theta_2^1 \quad \theta_1^1 ] \quad \theta_2^1 [ \theta_1^1 \quad \theta_2^1 ]) \quad ( \theta_1^2 \quad \theta_1^2 \quad \theta_1^2 ) \\ \diagup \quad | \quad \diagdown \quad \diagup \quad | \quad \diagdown \quad | \quad | \quad | \\ \theta_2^1 \quad ( \theta_2^1 \quad \theta_1^1 ) \quad \theta_2^1 \quad ( \theta_1^1 \quad \theta_2^1 ) \quad \theta_1^2 \quad \theta_1^2 \quad \theta_1^2 \end{array}$$

Finally, let  $\mathcal{C}_{n,m}^{\text{pre}} = \{ \Psi(\beta) \mid \beta \in \mathcal{B}_{n,m}^{\text{pre}} \}$ ; then  $\mathcal{C}^{\text{pre}} = \bigcup_{m,n} \mathcal{C}_{n,m}^{\text{pre}}$  indexes the set of module generators for  $F^{\text{pre}}(\Theta)$ . In Subsection 6.2 we identify a subset  $\mathcal{C} \subset \mathcal{C}^{\text{pre}}$  whose elements simultaneously index module generators of the “free matrad”  $F(\Theta)$  and cells of the matrahedra  $KK$ . This identification relates the module structure of  $F(\Theta)$  to the combinatorics of permutahedra.

**5.4. The Bialgebra Prematrad.** As is the case for operads and PROPs, prematrads can be described by generators and relations.

**Definition 6.** Let  $\mathcal{H}^{\text{pre}} = F^{\text{pre}}(\Theta) / \sim$ , where  $\Theta = \langle \theta_m^n = \theta_{n,m} \neq 0 \text{ if and only if } m+n \leq 3 \rangle$  and  $A \sim B$  if and only if  $\text{bideg}(A) = \text{bideg}(B)$ . Let  $\eta(\mathbf{1}) = \theta_1^1 = \mathbf{1}$  and let  $\gamma$  be the structure map induced by projection. Then  $(\mathcal{H}^{\text{pre}}, \eta, \gamma)$  is the bialgebra prematrad if the following axioms hold:

- (i) Associativity:  $\gamma(\theta_2^1; \theta_2^1, \mathbf{1}) = \gamma(\theta_2^1; \mathbf{1}, \theta_2^1)$ .
- (ii) Coassociativity:  $\gamma(\theta_1^2; \mathbf{1}; \theta_1^2) = \gamma(\mathbf{1}, \theta_1^2; \theta_1^2)$ .
- (iii) Hopf compatibility:  $\gamma(\theta_1^2; \theta_1^2) = \gamma(\theta_2^1, \theta_2^1; \theta_1^2, \theta_1^2)$ .

Each bigraded component  $\mathcal{H}_{n,m}^{\text{pre}}$  is generated by a singleton  $c_{n,m}$ ; for example,  $c_{1,2} = \theta_2^1$ ,  $c_{2,1} = \theta_1^2$ ,  $c_{1,3} = \gamma(\theta_2^1; \theta_2^1, \mathbf{1})$ ,  $c_{3,1} = \gamma(\theta_1^2; \mathbf{1}; \theta_1^2)$ ,  $c_{2,2} = \gamma(\theta_2^1; \theta_2^1)$ , and so on. Note that  $\mathcal{H}_{1,*}^{\text{pre}}$  and  $\mathcal{H}_{*,1}^{\text{pre}}$  are operads; the first is generated by  $\theta_2^1$  subject to (i) while the second is generated by  $\theta_1^2$  subject to (ii). Both are isomorphic to the associativity operad  $\underline{Ass}$  ([9]). And furthermore, for the bialgebra PROP  $\mathcal{B}$  we have  $\mathcal{B}^{\text{pre}} = \mathcal{H}^{\text{pre}}$  and  $U(\mathcal{H}^{\text{pre}}) = \mathcal{B}$ .

Given a graded  $R$ -module  $H$ , a map of prematrads  $\mathcal{H}^{\text{pre}} \rightarrow U_H$  defines a bialgebra structure on  $H$  and vice versa. Since each path of arrows from  $(m, 1)$  to  $(1, n)$  in  $\mathbb{N}^2$  represents some  $\Upsilon$ -factorization of  $c_{n,m}$  (see Figure 11), we think of all such paths as equal. Therefore  $\mathcal{H}^{\text{pre}}$  is the smallest module among existing general constructions that describe bialgebras (c.f. [8], [15]). Although the symmetric groups do not act on prematrads, the permutation  $\sigma_{n,m}$  built into the associativity axiom minimizes the modules involved.

**5.5. Local Prematrads.** Let  $M = \{M_{n,m}\}_{m,n \geq 1}$  be a bigraded  $R$ -module, let  $\mathbf{W}$  be a telescoping submodule of  $TTM$ , let  $\mathcal{W}$  be its telescopic extension, and let  $\gamma_{\mathbf{w}} = \left\{ \gamma_{\mathbf{x}}^{\mathbf{y}} : \mathbf{W}_{\mathbf{p}}^{\mathbf{y}} \otimes \mathbf{W}_{\mathbf{x}}^{\mathbf{q}} \rightarrow \mathbf{W}_{|\mathbf{x}|}^{|\mathbf{y}|} \right\}$  be a structure map. If  $A \otimes B$  is a BTP in  $\mathcal{W} \otimes \mathcal{W}$ , each TP  $A' \otimes B'$  in  $A \otimes B$  lies in  $\mathbf{W}_{\mathbf{p}}^{\mathbf{y}} \otimes \mathbf{W}_{\mathbf{x}}^{\mathbf{q}}$  for some  $\mathbf{x}, \mathbf{y}, \mathbf{p}, \mathbf{q}$ . Consequently,  $\gamma_{\mathbf{w}}$  extends to a global product  $\Upsilon : \mathcal{W} \otimes \mathcal{W} \rightarrow \mathcal{W}$  as in (5.1). In fact,  $\mathcal{W}$  is the smallest matrix submodule containing  $\mathbf{W}$  on which  $\Upsilon$  is well-defined.

**Definition 7.** Let  $\mathbf{W}$  be a telescoping submodule of  $TTM$ , let  $\gamma_{\mathbf{w}} = \left\{ \gamma_{\mathbf{x}}^{\mathbf{y}} : \mathbf{W}_{\mathbf{p}}^{\mathbf{y}} \otimes \mathbf{W}_{\mathbf{x}}^{\mathbf{q}} \rightarrow \mathbf{W}_{|\mathbf{x}|}^{|\mathbf{y}|} \right\}$  be a structure map, and let  $\eta : R \rightarrow \mathbf{M}$ . The triple  $(M, \gamma_{\mathbf{w}}, \eta)$  is a local prematrad (with domain  $\mathbf{W}$ ) if the following axioms are satisfied:

- (i)  $\mathbf{W}_{\mathbf{x}}^1 = \mathbf{M}_{\mathbf{x}}^1$  and  $\mathbf{W}_1^{\mathbf{y}} = \mathbf{M}_1^{\mathbf{y}}$  for all  $\mathbf{x}, \mathbf{y}$ .
- (ii)  $\Upsilon$  is associative on  $\mathcal{W} \cap \mathbf{M}$ .
- (iii) The prematrad unit axiom holds for  $\gamma_{\mathbf{w}}$ .

**Example 13.** Let  $\mathbf{V}$  be the bisequence vector submodule of  $TTM$ . If  $(M, \gamma)$  is a prematrad, then  $\gamma = \gamma_{\mathbf{v}}$  and  $(M, \gamma)$  is a local prematrad with domain  $\mathbf{V}$ . Local sub-prematrads  $(M, \gamma_{\mathbf{w}}) \subset (M, \gamma)$  are obtained by restricting the domain to submodules such as  $\mathbf{M}_1^*$ ,  $\mathbf{M}_*^1$ , and  $\mathbf{M}_*^1 \cup \mathbf{M}_1^*$ . Note that  $(M, \gamma_{\mathbf{M}_1^*})$  and  $(M, \gamma_{\mathbf{M}_*^1})$  are operads.

## 6. MATRADS

In this section we introduce the objects in the category of matrads; morphisms require a relative theory that will be constructed in the sequel. As motivation, let  $\Theta = \langle \theta_m^n \neq 0 \rangle_{m,n \geq 1}$ , let  $\mathbf{1} = \theta_1^1$ , and consider the canonical projection  $\rho^{\text{pre}} : F^{\text{pre}}(\Theta) \rightarrow \mathcal{H}^{\text{pre}}$ ; then

$$\rho^{\text{pre}}(\theta_m^n) = \begin{cases} \theta_m^n, & m+n \leq 3 \\ 0, & \text{otherwise.} \end{cases}$$

Now consider a differential  $\partial^{\text{pre}}$  on  $F^{\text{pre}}(\Theta)$  such that  $\rho^{\text{pre}}$  is a free resolution in the category of prematrads. Then the induced isomorphism  $\varrho^{\text{pre}} : H_*(F^{\text{pre}}(\Theta), \partial^{\text{pre}}) \approx \mathcal{H}^{\text{pre}}$  implies

$$\partial^{\text{pre}}(\theta_2^1) = \partial^{\text{pre}}(\theta_1^2) = 0$$

$$\partial^{\text{pre}}(\theta_3^1) = \gamma(\theta_2^1; \mathbf{1}, \theta_2^1) - \gamma(\theta_2^1; \theta_2^1, \mathbf{1})$$

$$\partial^{\text{pre}}(\theta_2^2) = \gamma(\theta_1^2; \theta_2^1) - \gamma(\theta_2^1 \theta_2^1; \theta_1^2 \theta_1^2)$$

$$\partial^{\text{pre}}(\theta_1^3) = \gamma(\mathbf{1}, \theta_1^2; \theta_1^2) - \gamma(\theta_1^2, \mathbf{1}; \theta_1^2).$$

However, defining  $\partial^{\text{pre}}$  on all of  $\Theta$  is quite subtle, and while it is possible to canonically extend  $\partial^{\text{pre}}$  to all of  $\Theta$ , acyclicity is difficult to verify. Instead, there is a canonical proper submodule  $\mathcal{H}_\infty \subset F^{\text{pre}}(\Theta)$  and a differential  $\partial$  on  $\mathcal{H}_\infty$  such that the canonical projection  $\varrho : \mathcal{H}_\infty \rightarrow \mathcal{H}^{\text{pre}}$  is a free resolution in the category of “matrads.” Furthermore, we conjecture that the minimal resolution of  $\mathcal{H}$  in the category of PROPs (and consequently, in the category of prematrads) is recovered by the universal enveloping functor  $U$  discussed in Example 18 below, i.e., the minimal resolution of the bialgebra PROP  $\mathcal{B}$  is  $U(\rho) : U(\mathcal{H}_\infty) \rightarrow U(\mathcal{H}^{\text{pre}}) = \mathcal{B}$ , in which case  $\mathcal{H}_\infty$  is the smallest extension of  $\mathcal{H}^{\text{pre}}$  in the category of modules.

The precise definition of  $\mathcal{H}_\infty$  requires more machinery.

**6.1. Matrads Defined.** Consider a family of pairs  $(\mathbf{W}_\alpha, \gamma_\alpha)$ , where  $\mathbf{W}_\alpha \subset TTM$  is a telescoping submodule, and the corresponding family of telescopic extensions  $(\mathcal{W}_\alpha, \Upsilon_\alpha)$ . To each pair  $(\mathcal{W}_\alpha, \Upsilon_\alpha)$  the  $\Upsilon$ -factorizations given by via Definition 8 below determine a unique “configuration module”  $\Gamma(\mathbf{W}_\alpha) \subseteq \mathcal{W}_\alpha$  with the following property: If  $\mathbf{W}_\alpha \subseteq \mathbf{W}_\beta$  and  $\gamma_{\mathbf{w}_\alpha} = \gamma_{\mathbf{w}_\beta} \Big|_{\mathbf{w}_\alpha}$ , then  $\Gamma(\mathbf{W}_\alpha) \subseteq \Gamma(\mathbf{W}_\beta)$ . The local prematrad  $(M, \gamma_{\mathbf{w}_\alpha})$  is a “matrad” if  $\mathbf{W}_\alpha$  is “ $\Gamma$ -stable,” i.e.,  $\mathbf{W}_\alpha$  is the smallest telescoping submodule such that  $\Gamma(\mathbf{W}_\alpha) = \Gamma(\mathbf{W}_\beta)$  whenever  $\mathbf{W}_\alpha \subset \mathbf{W}_\beta$  and  $\gamma_{\mathbf{w}_\alpha} = \gamma_{\mathbf{w}_\beta} \Big|_{\mathbf{w}_\alpha}$ .

Matrads are intimately related to the permutahedra  $P = \sqcup_{n \geq 1} P_n$ . Recall that codimension  $k-1$  faces of  $P_{n-1}$  are parametrized by planar rooted leveled trees (PLTs) with  $n$  leaves and  $k$  levels (see [5], [12]). If  $n \geq 3$ , an  $n$ -leaf sequence is an  $r$ -tuple  $\mathbf{n} = (n_1, \dots, n_r) \in \mathbb{N}^r$  such that  $r \geq 2$  and  $|\mathbf{n}| = n$ . Let  $\theta_1^q$  denote the down-rooted  $q$ -leaf corolla and identify  $\mathbf{n} = (n_1, \dots, n_r)$  with the fraction  $\theta_1^{n_1} \dots \theta_1^{n_r} / \theta_1^n$ . Then  $n$ -leaf sequences parametrize the codimension 1 faces of  $P_{n-1}$ . More generally, for  $n \geq 2$ , define the  $(n, 1)$ -leaf sequence of the  $n$ -leaf corolla  $\theta_1^n$  to be  $\mathbf{n}_1 = n$ . Given a PLT  $T = T^1$  with  $n \geq 3$  leaves and  $k \geq 2$  levels, write  $T^1 = \theta_1^{n_{1,1}} \dots \theta_1^{n_{1,r_1}} / T^2$  and define the *first leaf sequence* of  $T$  to be the  $r_1$ -tuple  $\mathbf{n}_1 = (n_{1,1}, \dots, n_{1,r_1})$ . Inductively, if  $i < k$  and  $\mathbf{n}_i = (n_{i,1}, \dots, n_{i,r_i})$  is the  $i^{\text{th}}$  leaf sequence of  $T$ , define the  $(i+1)^{\text{st}}$  leaf sequence of  $T$  to be the first leaf sequence of  $T^{i+1}$ . The induction terminates with  $\mathbf{n}_k = n_{k,1}$ , and we define the  $(n, k)$ -leaf sequence of  $T$  to be the  $k$ -tuple  $(\mathbf{n}_1, \dots, \mathbf{n}_k)$ .

Conversely, an  $(n, k)$ -leaf sequence  $(\mathbf{n}_1, \dots, \mathbf{n}_k)$  with  $n \geq 2$  and  $1 \leq k \leq n-1$  is defined to be the  $(n, k)$ -leaf sequence of some PLT with  $n$  leaves and  $k$  levels. Thus

$(n, k)$ -leaf sequences parametrize the codimension  $k - 1$  faces of  $P_{n-1}$ , and in particular, its vertices are parametrized by all  $(n, n - 1)$ -leaf sequences  $(\mathbf{n}_1, \dots, \mathbf{n}_{n-1})$ , where  $\mathbf{n}_i = (1, \dots, 2, \dots, 1) \in \mathbb{N}^{n-i}$  with 2 in position  $j$  for some  $1 \leq j \leq n - i$ .

Each face of  $P_{n-1}$  is identified with two PLTs—an up-rooted PLT and its down-rooted mirror image. To avoid ambiguity, we will often refer to leaf sequences of up-rooted PLTs as *ascent sequences* and to those of down-rooted PLTs as *descent sequences*.

Given a telescoping submodule  $\mathbf{W}$  and its telescopic extension  $\mathcal{W}$ , let  $\mathcal{W}_{\text{row}} = \mathcal{W} \cap \overline{\mathbf{M}}_{\text{row}}$  and  $\mathcal{W}^{\text{col}} = \mathcal{W} \cap \overline{\mathbf{M}}^{\text{col}}$ .

**Definition 8.** Given a local prematrad  $(M, \gamma_{\mathbf{W}})$  and  $p, q \geq 2$ , let  $\zeta \in M_{*,m}$  and  $\xi \in M_{n,*}$ .

- (i) A row factorization of  $\zeta$  with respect to  $\mathbf{W}$  is a  $\Upsilon$ -factorization  $A_1 \cdots A_k = \zeta$  such that  $A_j \in \mathcal{W}_{\text{row}}$  and  $\text{rls}(A_j) \neq \mathbf{1}$  for all  $j$ . The sequence  $(\text{rls}(A_k), \dots, \text{rls}(A_1))$  is the related  $(m, k)$ -ascent sequence of  $\zeta$ .
- (ii) A column factorization of  $\xi$  with respect to  $\mathbf{W}$  is a  $\Upsilon$ -factorization  $B_l \cdots B_1 = \xi$  such that  $B_i \in \mathcal{W}^{\text{col}}$  and  $\text{cls}(B_i) \neq \mathbf{1}$  for all  $i$ . The sequence  $(\text{cls}(B_l), \dots, \text{cls}(B_1))$  is the related  $(n, l)$ -descent sequence of  $\xi$ .

Clearly, column and row factorizations are not unique. Note that an element  $A \in M_{n,*}$  always has a trivial column factorization as the  $1 \times 1$  matrix  $[A]$ . When matrix entries in a row factorization are pictured as graphs, terms of the ascent sequence are “lower (input) leaf sequences” of the graphs along any row, and dually for column factorizations.

**Example 14.** A  $\Upsilon$ -product

$$C = C_1 C_2 C_3 = \begin{bmatrix} \theta_2^1 \\ \alpha_2^2 \\ \beta_2^2 \end{bmatrix} \begin{bmatrix} \theta_1^2 & \zeta_2^2 \\ \theta_1^1 & \theta_2^1 \end{bmatrix} [\theta_1^2 \ \xi_2^2 \ \theta_1^2] \in M_{5,4}$$

is simultaneously a row and column factorization of  $C$ . As a row factorization, the  $(4, 3)$ -ascent sequence of  $C$  is

$$(\text{rls}(C_3), \text{rls}(C_2), \text{rls}(C_1)) = ((121), (12), 2);$$

as a column factorization, the related  $(5, 3)$ -descent sequence of  $C$  is

$$(\text{cls}(C_1), \text{cls}(C_2), \text{cls}(C_3)) = \left( \left( \begin{pmatrix} 1 \\ 2 \\ 2 \end{pmatrix} \right), \left( \begin{pmatrix} 2 \\ 1 \end{pmatrix}, 2 \right) \right).$$

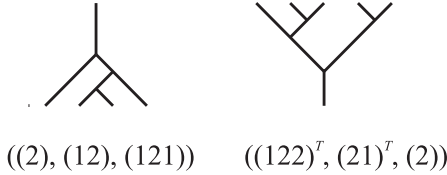

Figure 12. Ascent and descent sequences of  $C$ .

Let  $m, n \geq 2$ . Given  $A \in M_{*,m}$  and  $B \in M_{n,*}$ , choose a row factorization  $A_1 \cdots A_k$  of  $A$  and a column factorization  $B_l \cdots B_1$  of  $B$ ; let  $\mathbf{m}$  and  $\mathbf{n}$  be their respective  $(m, k)$ -ascent and  $(n, l)$ -descent sequences. The ascent sequence  $\mathbf{m}$  identifies  $A$  with an up-rooted  $m$ -leaf  $k$ -level PLT and hence with a codimension  $k - 1$

face  $\hat{e}_A$  of  $P_{m-1}$ . Dually, the descent sequence  $\mathbf{n}$  identifies  $B$  with a down-rooted  $n$ -leaf  $l$ -level PLT and hence with a codimension  $l-1$  face  $\check{e}_B$  of  $P_{n-1}$ . Extending to Cartesian products, given monomials  $A = A_1 \otimes \cdots \otimes A_q \in (M_{*,m})^{\otimes q}$  and  $B = B_1 \otimes \cdots \otimes B_p \in (M_{n,*})^{\otimes p}$  are identified with the product cells

$$\hat{e}_A = \hat{e}_{A_1} \times \cdots \times \hat{e}_{A_q} \subset (P_{m-1})^{\times q} \quad \text{and} \quad \check{e}_B = \check{e}_{B_1} \times \cdots \times \check{e}_{B_p} \subset (P_{n-1})^{\times p}.$$

Now consider the S-U diagonal  $\Delta_P$  and the cellular inclusions  $\Delta^{(k-1)}(P_r) \subset (P_r)^{\times k}$  defined for each  $r, k \geq 1$  (see Subsection 3.2). Then for each  $q \geq 2$ , the product cell  $\hat{e}_A$  either is or is not in the subcomplex  $\Delta^{(q-1)}(P_{m-1}) \subset (P_{m-1})^{\times q}$ , and dually for  $\check{e}_B$  and  $\Delta^{(p-1)}(P_{n-1}) \subset (P_{n-1})^{\times p}$ . This leads to the notion of ‘‘configuration module.’’

Let  $\mathbf{x}_m^{p,i} = (1, \dots, m, \dots, 1) \in \mathbb{N}^{1 \times p}$  with  $m$  in the  $i^{\text{th}}$  position and let  $\mathbf{y}_{q,j}^n = (1, \dots, n, \dots, 1)^T \in \mathbb{N}^{q \times 1}$  with  $n$  in the  $j^{\text{th}}$  position.

**Definition 9.** *The (left) configuration module of a local prematrad  $(M, \gamma_{\mathbf{w}})$  is the  $R$ -module*

$$\Gamma(M, \gamma_{\mathbf{w}}) = M \oplus \bigoplus_{\mathbf{x}, \mathbf{y} \notin \mathbb{N}; s, t \geq 1} \Gamma_s^{\mathbf{y}}(M) \oplus \Gamma_{\mathbf{x}}^t(M), \quad \text{where}$$

$$\Gamma_s^{\mathbf{y}}(M) = \begin{cases} \langle A \in \mathbf{W}_s^{\mathbf{y}} \mid \hat{e}_A \subset \Delta^{(q-1)}(P_{s-1}) \rangle, & s \geq 2 \\ \mathbf{M}_1^{\mathbf{y}}, & \mathbf{y} = \mathbf{y}_{q,j}^n \text{ for some } j, n, q \\ 0, & \text{otherwise,} \end{cases}$$

$$\Gamma_{\mathbf{x}}^t(M) = \begin{cases} \langle B \in \mathbf{W}_{\mathbf{x}}^t \mid \check{e}_B \subset \Delta^{(p-1)}(P_{t-1}) \rangle, & t \geq 2 \\ \mathbf{M}_{\mathbf{x}}^1, & \mathbf{x} = \mathbf{x}_m^{p,i} \text{ for some } i, m, p \\ 0, & \text{otherwise.} \end{cases}$$

Thus  $\Gamma_{\mathbf{x}}^t(M)$  is generated by those tensor monomials  $B = B_1 \otimes \cdots \otimes B_p \in \mathbf{W}_{\mathbf{x}}^t \subset M_{t,x_1} \otimes \cdots \otimes M_{t,x_p}$  whose tensor factor  $B_i$  is identified with the cellular component of  $\Delta^{(p-1)}(P_{t-1})$  corresponding to some column factorization  $B_i = B_{i,l} \cdots B_{i,1}$  with respect to  $\mathbf{W}$ , and dually for  $\Gamma_s^{\mathbf{y}}(M)$ .

**Example 15.** *Referring to Example 4, let  $M = M_{1,1} \oplus M_{2,2} = \langle \theta_1^1 \rangle \oplus \langle \theta_2^2 \rangle$ , and consider the local prematrad  $(M, \gamma_{\mathbf{v}})$ . Note that the action of  $\gamma_{\mathbf{v}}$  is trivial modulo unit (e.g.,  $\mathbf{M}_2^2 \cdot \mathbf{M}_1^1 = \mathbf{M}_2^2$  and  $\mathbf{M}_2^{22} \cdot \mathbf{M}_2^{22} \subseteq \mathbf{M}_4^4 = 0$ ). Then*

$$\Gamma_*^1(M) \approx \Gamma_1^*(M) \approx T^+(M_{1,1}).$$

Since  $A = (\theta_2^2)^{\otimes q}$  can be thought of as an element of either  $\mathbf{M}_2^{2 \cdots 2}$  or  $\mathbf{M}_{2 \cdots 2}^2$  we have  $\check{e}_A = \hat{e}_A = (P_1)^{\times q} = \Delta^{(q-1)}(P_1)$  so that

$$\Gamma_*^2(M) \approx \Gamma_2^*(M) \approx T^+(M_{2,2}).$$

Thus

$$\Gamma(M, \gamma_{\mathbf{v}}) = \mathbf{V}.$$

Since  $r = 1$  is the only case in which we have the equality  $\Delta^{(k-1)}(P_r) = (P_r)^{\times k}$  for each  $k$ , it follows immediately that if  $A \in M_{n,m}$  is  $\gamma_{\mathbf{w}}$ -indecomposable (in which case its row and column factorizations with respect to  $\mathbf{W}$  are trivial) and  $\hat{e}_A \times \cdots \times \hat{e}_A = e^{m-2} \times \cdots \times e^{m-2}$  is a subcomplex of  $\Delta^{(n-1)}(P_{m-1})$ , then either  $m =$

2 and  $n$  is arbitrary or  $m > 2$  and  $n = 1$ ; dually, if  $\check{e}_A \times \cdots \times \check{e}_A = e^{n-2} \times \cdots \times e^{n-2}$  is a subcomplex of  $\Delta^{(m-1)}(P_{n-1})$ , then either  $m$  is arbitrary and  $n = 2$  or  $m = 1$  and  $n > 2$ . Consequently,

$$\bigoplus_{\mathbf{x}} \Gamma_{\mathbf{x}}^2(M) \approx T^+(M_{2,*}) \quad \text{and} \quad \bigoplus_{\mathbf{y}} \Gamma_{\mathbf{y}}^2(M) \approx T^+(M_{*,2}).$$

On the other hand, if  $m+n \geq 4$ ,  $(m,n) \neq (2,2)$ , and  $A^{\otimes r} \in \Gamma(M, \gamma_{\mathbf{w}})$ , then  $r = 1$ , and the inclusion  $\Gamma_{\mathbf{s}}^{\mathbf{y}}(M) \subseteq \mathbf{M}_{\mathbf{s}}^{\mathbf{y}}$  is proper whenever  $s \geq 3$ ,  $\mathbf{y} \in \mathbb{N}^{q \times 1}$  with  $q \geq 2$ , and  $M_{y_j, s}$  contains a  $\gamma_{\mathbf{w}}$ -indecomposable element for each  $1 \leq j \leq q$ , and dually for  $\Gamma_{\mathbf{x}}^t(M) \subseteq \mathbf{M}_{\mathbf{x}}^t$ .

We are ready to define the notion of a matrad.

**Definition 10.** *A local prematrad  $(M, \gamma_{\mathbf{w}}, \eta)$  is a (left) matrad if*

$$\Gamma_p^{\mathbf{y}}(M, \gamma_{\mathbf{w}}) \otimes \Gamma_{\mathbf{x}}^q(M, \gamma_{\mathbf{w}}) = \mathbf{W}_p^{\mathbf{y}} \otimes \mathbf{W}_{\mathbf{x}}^q$$

for all  $p, q \geq 2$ . A morphism of matrads is a map of underlying local prematrads.

**Example 16.** The Bialgebra Matrad  $\mathcal{H}$ . *The bialgebra prematrad  $\mathcal{H}^{\text{pre}}$  satisfies  $\Gamma_p^{\mathbf{y}}(M) \otimes \Gamma_{\mathbf{x}}^q(M) = \mathbf{M}_p^{\mathbf{y}} \otimes \mathbf{M}_{\mathbf{x}}^q$  for  $p, q \geq 2$ . Hence  $\mathcal{H}^{\text{pre}}$  is also a matrad, called the bialgebra matrad and henceforth denoted by  $\mathcal{H}$ .*

**Example 17.** *Continuing Example 13, the inclusions  $(M_{1,*}, \gamma_{\mathbf{M}_1^*}) \subset (M, \gamma_{\mathbf{M}_1^*})$  and  $(M_{*,1}, \gamma_{\mathbf{M}_1^*}) \subset (M, \gamma_{\mathbf{M}_1^*})$  are inclusions of matrads since  $\Gamma_p^{\mathbf{y}}(M, \gamma_{\mathbf{M}_1^*}) \otimes \Gamma_{\mathbf{x}}^q(M, \gamma_{\mathbf{M}_1^*}) = \mathbf{M}_p^{\mathbf{y}} \otimes \mathbf{M}_{\mathbf{x}}^q = 0$  for  $p, q \geq 2$ . In particular, when  $M = F^{\text{pre}}(\Theta)$  and  $\theta_m^n \neq 0$  for all  $m, n \geq 1$ , the free operad  $(\mathcal{A}_{\infty}, \gamma_{\mathbf{M}_1^*})$  embeds in  $(F^{\text{pre}}(\Theta), \gamma_{\mathbf{M}_1^*})$  as a submatrad (c.f. Example 11 and Definition 11 below).*

**Example 18.** The Universal Enveloping Functor  $U(M)$ . *The universal enveloping PROP  $U(M)$  discussed in Example 10 induces a functor  $U$  from the category of matrads to the category of PROPs. Given a matrad  $(M, \gamma_{\mathbf{w}})$ , let  $FP(M)$  be the free PROP generated by  $M$  and let  $J$  is the two-sided ideal generated by the elements  $\bigoplus_{\mathbf{x} \times \mathbf{y}} (\gamma_{\mathbf{w}} - \gamma_{FP}) (\Gamma_p^{\mathbf{y}}(M) \otimes \Gamma_{\mathbf{x}}^q(M))$ . Then*

$$U(M) = FP(M)/J$$

is the universal enveloping functor on  $M$ .

**6.2. Free Matrads.** Recall that the domain of the free prematrad  $(M = F^{\text{pre}}(\Theta), \gamma, \eta)$  generated by  $\Theta = \langle \theta_m^n \rangle_{m,n \geq 1}$  is  $\mathbf{V} = M \oplus \bigoplus_{\mathbf{x}, \mathbf{y} \notin \mathbb{N}; s, t \in \mathbb{N}} \mathbf{M}_s^{\mathbf{y}} \oplus \mathbf{M}_{\mathbf{x}}^t$  whose submod-

ules  $M$ ,  $\mathbf{M}_{\mathbf{x}}^1$ , and  $\mathbf{M}_1^{\mathbf{y}}$  are contained in the configuration module  $\Gamma(M)$ . As above, the symbol “ $\cdot$ ” denotes the  $\gamma$  product.

**Definition 11.** *Let  $(M = F^{\text{pre}}(\Theta), \gamma, \eta)$  be the free prematrad generated by  $\Theta = \langle \theta_m^n \rangle_{m,n \geq 1}$ . The free matrad generated by  $\Theta$  is the triple*

$$(F(\Theta) = \Gamma(M) \cdot \Gamma(M), \gamma_{\Gamma(F(\Theta))} := \gamma|_{\Gamma(M) \otimes \Gamma(M)}, \eta).$$

Let  $\beta \in \mathcal{B}^{\text{pre}}$ . In Subsection 5.3 we constructed the  $r$ -level tree  $\Psi(\beta)$  whose leaves are balanced  $\Theta$ -factorizations; the set  $\mathcal{C}^{\text{pre}} = \{\Psi(\beta) \mid \beta \in \mathcal{B}^{\text{pre}}\}$  indexes the set  $\mathcal{G}^{\text{pre}}$  of module generators of the free prematrad  $F^{\text{pre}}(\Theta)$ . Let  $\mathcal{G} = F(\Theta) \cap \mathcal{G}^{\text{pre}}$  and let  $\mathcal{B} = \phi(\mathcal{G})$ . Then

$$\mathcal{C} = \{\Psi(\beta) \mid \beta \in \mathcal{B}\}$$

indexes the set  $\mathcal{G}$  of module generators of  $F(\Theta)$ .



To establish the relationship between elements of  $\mathcal{G}$  and cells of  $KK_{n,m}$ , let  $\beta = A_s \cdots A_1 \in \mathcal{B}_{n,m}^{\text{pre}}$  and observe that  $\beta \in \mathcal{B}_{n,m}$  if and only if the tensor monomials along each row and column of  $A_k$  lie in  $\Gamma(F^{\text{pre}}(\Theta))$  for all  $k$  (see (8.7) below). Let

$$\mathcal{C}_{n,m}'' = \{\Psi(\beta) \mid \beta = A_s \cdots A_1 \in \mathcal{B}_{n,m} \text{ and either } A_1 \text{ or } A_s \text{ is a } 1 \times 1\};$$

then in particular,  $\mathcal{C}_{1,m}'' = \mathcal{C}_{1,m}$  and  $\mathcal{C}_{n,1}'' = \mathcal{C}_{n,1}$ . Let  $\mathcal{C}'_{n,m} = \mathcal{C}_{n,m} \setminus \mathcal{C}''_{n,m}$ ; then  $\mathcal{C}_{n,m} = \mathcal{C}'_{n,m} \sqcup \mathcal{C}''_{n,m}$  for each  $m, n \geq 1$ . Elements of  $\mathcal{C}'$  are defined in terms of  $\Delta_P$ ; elements of  $\mathcal{C}''$  are independent of  $\Delta_P$ .

Define the dimension of  $\theta_1^1 = \mathbf{1}$  to be zero and the dimension of  $\theta_m^n$  to be  $m + n - 3$ ; if  $A \in \mathcal{G}$ , then the dimension of  $A$ , denoted by  $|A|$ , is the sum of the dimensions of the matrix entries in any representative monomial in  $G$ , and in particular, in its balanced factorization in  $\mathcal{B}$ . Clearly, given  $\mathbf{y} \times \mathbf{x} \in \mathbb{N}^{q \times 1} \times \mathbb{N}^{1 \times p}$ , the set  $\{|A| \mid A \in \mathbf{G}_{\mathbf{x}}^{\mathbf{y}}\}$  is bounded and, consequently, has a maximal element. For example, if  $A$  is a monomial in  $\Gamma_s^{\mathbf{y}}(F(\Theta))$  with  $s \geq 2$  and  $\hat{e}_A$  is the corresponding subcomplex of  $\Delta_P^{(q-1)}(e^{s-2})$ , then  $|A| = |\hat{e}_A| + |\mathbf{y}| - q$ ; and dually, if  $B$  is a monomial in  $\Gamma_{\mathbf{x}}^t(F(\Theta))$  with  $t \geq 2$  and  $\check{e}_B$  is the corresponding subcomplex of  $\Delta_P^{(p-1)}(e^{t-2})$ , then  $|B| = |\check{e}_B| + |\mathbf{x}| - p$ . Consequently,  $\max\{|A| \mid A \in \Gamma_s^{\mathbf{y}}(F(\Theta))\} = |\mathbf{y}| + s - q - 2$  and  $\max\{|B| \mid B \in \Gamma_{\mathbf{x}}^t(F(\Theta))\} = |\mathbf{x}| + t - p - 2$ . In particular, if  $A \in \mathcal{G}_{n+1, m+1}$  has balanced factorization  $\beta = A_s \cdots A_1$ ,  $1 \leq s \leq m + n$ , then  $\text{codim } A \geq s - 1$  and  $\text{codim } A = s - 1$  if and only if the dimensions of each bisequence matrix  $A_k$  is maximal (see (8.12) below).

**Example 19.** *The  $A_\infty$ -bialgebra Matrad  $\mathcal{H}_\infty$ . Let  $\Theta = \langle \theta_m^n \neq 0 \rangle_{m, n \geq 1}$ . We say that  $\beta \in \mathcal{C}$  has word length 2 if and only if  $\beta = C_2 C_1$  for some  $C_1 \in \mathbf{G}_{\mathbf{x}}^{\mathbf{y}}$  and  $C_2 \in \mathbf{G}_{\mathbf{p}}^{\mathbf{y}}$  with  $\mathbf{y} \times \mathbf{x} \in \mathbb{N}^{q \times 1} \times \mathbb{N}^{1 \times p}$ . Define a differential  $\partial : F(\Theta) \rightarrow F(\Theta)$  of degree  $-1$  as follows: Let*

$$\mathcal{AB}_{n,m} = \{\Psi(\beta) \mid \beta \in \mathcal{C}_{n,m} \text{ and has word length 2}\}.$$

Denote the corresponding bases of  $\Gamma_{\mathbf{x}}^q(F(\Theta))$  and  $\Gamma_{\mathbf{p}}^{\mathbf{y}}(F(\Theta))$  by  $\{B_{\mathbf{x}}^q\}_{\beta \in \mathcal{B}_{\mathbf{x}}^q}$  and  $\{A_{\mathbf{p}}^{\mathbf{y}}\}_{\alpha \in \mathcal{A}_{\mathbf{p}}^{\mathbf{y}}}$  respectively. Then  $A_i^j = B_i^j = \theta_i^j$  with  $|\theta_i^j| = i + j - 3$ ;  $B_{\mathbf{x}}^1 = \theta_m^{p,i}$  with  $\mathbf{x} = \mathbf{x}_m^{p,i}$  and  $|B_{\mathbf{x}}^1| = m - 2$ , and  $A_1^{\mathbf{y}} = \theta_{q,j}^n$  with  $\mathbf{y} = \mathbf{y}_{q,j}^n$  and  $|A_1^{\mathbf{y}}| = n - 2$  (c.f. Example 11). In general,  $|(B_{\mathbf{x}}^q)_\beta| = |\mathbf{x}| + q - p - 2$  and  $|(A_{\mathbf{p}}^{\mathbf{y}})_\alpha| = |\mathbf{y}| + p - q - 2$  for  $p, q \geq 2$ . Then each  $\hat{e}_{A_\alpha}$  is a component of  $\Delta_P^{(q-1)}(e^{p-2})$  with the associated sign  $(-1)^{\epsilon_\alpha}$  and each  $\hat{e}_{B_\beta}$  is a component of  $\Delta_P^{(p-1)}(e^{q-2})$  with the associated sign  $(-1)^{\epsilon_\beta}$ . Define  $\partial$  on generators by

$$(6.1) \quad \partial(\theta_m^n) = \sum_{(\alpha, \beta) \in \mathcal{AB}_{m,n}} (-1)^{\epsilon_\alpha + \epsilon_\beta} \gamma[(A_{\mathbf{p}}^{\mathbf{y}})_\alpha; (B_{\mathbf{x}}^q)_\beta],$$

where  $(-1)^\epsilon$  is the standard sign of the codimension 1 face  $e_{(\mathbf{y}, \mathbf{x})} \subset P_{m+n-2}$  defined in (6.3) below. Extend  $\partial$  as a derivation of  $\gamma$ ; then  $\partial^2 = 0$  follows from the associativity of  $\gamma$ . The DG matrad  $(F(\Theta), \partial)$ , denoted by  $\mathcal{H}_\infty$  and called the  $A_\infty$ -bialgebra matrad, is realized by the matrahedra  $\{KK_{n,m} \leftrightarrow \theta_m^n\}$  (see Theorem 1 below). One recovers  $\mathcal{A}_\infty$  by restricting  $\partial$  to  $(\mathcal{H}_\infty)_{1,*}$  or  $(\mathcal{H}_\infty)_{*,1}$ .

The codimension 1 face  $e_{(\mathbf{y}, \mathbf{x})} \subset P_{m+n}$  in Example 19 is defined as follows: For  $\mathbf{x} \in \mathbb{N}^p$  with  $|\mathbf{x}| > p > 1$ , let  $A_{\mathbf{x}}|B_{\mathbf{x}}$  denote the codimension 1 face of  $P_{|\mathbf{x}|-1}$  with leaf

sequence  $\mathbf{x}$ . Let  $\chi : P_n \rightarrow P_n$  be the cellular involution defined for  $A_1 | \cdots | A_k \subset P_n$  by

$$(6.2) \quad \chi(A_1 | \cdots | A_k) = (-A_k + n + 1) | \cdots | (-A_1 + n + 1).$$

Then given integer sequences  $(\mathbf{y}, \mathbf{x})$  such that  $|\mathbf{x}| = m + 1$ ,  $|\mathbf{y}| = n + 1$ ,  $m, n \geq 2$ , set

$$A_1 | B_1 = \begin{cases} \underline{m} | \emptyset, & \mathbf{x} = \mathbf{1}^{m+1} \\ \emptyset | \underline{m}, & \mathbf{x} = m + 1 \\ \chi(A_{\mathbf{x}} | B_{\mathbf{x}}), & \text{otherwise,} \end{cases} \quad A_2 | B_2 = \begin{cases} \emptyset | \underline{n}, & \mathbf{y} = \mathbf{1}^{n+1} \\ \underline{n} | \emptyset, & \mathbf{y} = n + 1 \\ A_{\mathbf{y}} | B_{\mathbf{y}}, & \text{otherwise,} \end{cases}$$

and define

$$(6.3) \quad e_{(\mathbf{y}, \mathbf{x})} = A_1 \cup (A_2 + m) | B_1 \cup (B_2 + m).$$

Then, for example,  $e_{(\mathbf{1}^{n+1}, \mathbf{1}^{m+1})} = \underline{m} | (\underline{n} + m)$  and  $e_{((n+1), (m+1))} = (\underline{n} + m) | \underline{m}$ , while  $e_{((21), (21))} = 13|24$ . Note that  $\epsilon = i(m - 1)$  in (6.1) gives the sign of the cell  $e_{(\mathbf{y}_p^m, \mathbf{1})} = e_{(\mathbf{1}, \mathbf{x}_m^p)}$   $\subset P_{m+p-2}$  (see [12]) and simplifies the standard sign in the differential on  $\mathcal{A}_\infty$  [9].

**Example 20.** For  $m = n = 3$ ,  $p = 2$ ,  $q = 3$ ,  $\mathbf{x} = (2, 1)$  and  $\mathbf{y} = (1, 1, 1)^T$ , we have  $\mathcal{A}_2^{111} = \{\alpha\}$  and  $\mathcal{B}_{21}^3 = \{\beta_1, \beta_2, \beta_3\}$  and corresponding bases

$$A_\alpha = \begin{bmatrix} \theta_2^1 \\ \theta_2^1 \\ \theta_2^1 \end{bmatrix} \quad \text{and} \quad B_{\beta_1} = \begin{bmatrix} \theta_2^3 & \begin{bmatrix} \theta_1^1 \\ \theta_1^1 \end{bmatrix} & \theta_1^2 \end{bmatrix}, \\ B_{\beta_2} = \begin{bmatrix} \begin{bmatrix} \theta_2^2 \\ \theta_1^2 \end{bmatrix} & [\theta_1^2 \ \theta_1^2] & \theta_1^3 \end{bmatrix}, \quad B_{\beta_3} = \begin{bmatrix} \begin{bmatrix} \theta_1^2 \\ \theta_1^1 \end{bmatrix} & \theta_2^2 & \theta_1^3 \end{bmatrix}.$$

Thus,  $\partial(\theta_3^3) = -\gamma(A_\alpha; B_{\beta_1} + B_{\beta_2} + B_{\beta_3}) + \cdots$  (see Example 31).

**6.3. The Biderivative.** In [13] we used the canonical prematrad structure  $\gamma$  on the universal PROP  $U_A = \text{End}(TA)$  to define the biderivative operator. By replacing  $U_A$  with an arbitrary prematrad  $(M, \gamma)$  we obtain the general biderivative operator  $Bd_\gamma : \mathbf{M} \rightarrow \mathbf{M}$  having the property  $Bd_\gamma \circ Bd_\gamma = Bd_\gamma$ . An element  $A \in \mathbf{M}$  is a  $\gamma$ -biderivative if  $A = Bd_\gamma(A)$ . Note that  $Bd_\gamma(\mathbf{M}) \subseteq (\Gamma(M), \gamma)$ ; when  $M$  is generated by singletons in each bidegree, the image  $Bd_\gamma(\mathbf{M})$  is the module of fixed points of  $Bd_\gamma$  and gives rise to an algorithmic construction of an additive basis for the  $\mathcal{A}_\infty$ -bialgebra matrad  $\mathcal{H}_\infty$ . More precisely:

**Proposition 1.** Let  $(M, \gamma)$  be a prematrad generated by  $\Theta = \{\theta_m^n\}_{m, n \geq 1}$ , and let  $Bd_\gamma : \mathbf{M} \rightarrow \mathbf{M}$  denote the associated biderivative operator. Then

- (i)  $Bd_\gamma(\mathbf{M}) \subseteq \Gamma(M, \gamma)$  and  $Bd_\gamma \circ Bd_\gamma = Bd_\gamma$ .
- (ii) Each element  $\theta \in \Theta$  has a unique  $\gamma$ -biderivative  $d_\theta^\gamma \in \mathbf{M}$ .
- (iii)  $\Gamma(M, \gamma) = \langle d_\theta^\gamma \rangle$ .

Thus the  $\gamma$ -biderivative can be viewed as a non-linear map  $d_\bullet^\gamma : M \rightarrow \mathbf{M}$ . When  $M = \text{End}(TA)$  we omit the symbol  $\gamma$  and denote the biderivative of  $\theta$  by  $d_\theta$  as in [13].

In particular, the modules  $\langle Bd_\gamma(M_{*,2}) \rangle \subseteq T^+(M_{*,2})$  and  $\langle Bd_\gamma(M_{2,*}) \rangle \subseteq T^+(M_{2,*})$  are spanned by symmetric tensors (compare Example 15); furthermore,  $Bd_\gamma(M_{n,m}) = M_{n,m}$  for  $m, n > 2$ .

Finally, the algorithm that produces  $d_\theta^\gamma$  for  $(M, \gamma) = (F^{\text{pre}}(\Theta), \gamma)$  simultaneously produces an additive basis for  $\mathcal{H}_\infty$ .

**Proposition 2.** *Let  $\Theta = \langle \theta_m^n \neq 0 \rangle_{m,n \geq 1}$  as in Example 19. Elements of the bases  $\{(A_p^\mathbf{y})_\alpha\}_{\alpha \in A_p^\mathbf{y}}$  and  $\{(B_x^q)_\beta\}_{\beta \in B_x^q}$  are exactly the components of  $d_\theta^\mathbf{y}$  in  $\Gamma_p^\mathbf{y}(F(\Theta), \gamma)$  and  $\Gamma_x^q(F(\Theta), \gamma)$  with degrees  $|\mathbf{y}| + p - q - 2$  and  $|\mathbf{x}| + q - p - 2$ , respectively. Thus*

$$\partial(\theta_{n,m}) = \sum_{\substack{|\mathbf{x}|=m; |\mathbf{y}|=n \\ A \times B \in (d_\theta^\mathbf{y})_p^\mathbf{y} \times (d_\theta^\mathbf{x})_q^\mathbf{x}}} \gamma(A; B).$$

*Proof.* The proof follows from the definition of  $d_\theta^\mathbf{y}$  and is straightforward.  $\square$

6.3.1. *The  $\odot$ -Product.* Given a prematrad  $(M, \gamma)$ , define a (non-bilinear) operation

$$(6.4) \quad \odot : M \times M \xrightarrow{d_\theta^\mathbf{y} \times d_\theta^\mathbf{x}} \mathbf{M} \times \mathbf{M} \xrightarrow{\Upsilon} \mathbf{M} \xrightarrow{proj} M,$$

where *proj* is the canonical projection. The following facts are now obvious:

**Proposition 3.** *The  $\odot$  operation acts bilinearly on  $M_{*,1}$  and  $M_{1,*}$ . In fact, when  $M = \text{End}(TH)$ , the  $\odot$  operation coincides with Gerstenhaber's  $\circ$ -operation on  $M_{1,*}$  (see [3]) and dually on  $M_{*,1}$ .*

**Remark 4.** *The bilinear part of the  $\odot$  operation, i.e., its restriction to either  $M_{*,1}$  or  $M_{1,*}$ , is completely determined by the associahedra  $K = \sqcup K_n$  (rather than permutahedra) and induces the cellular projection  $\vartheta_0 : P_n \rightarrow K_{n+1}$  due to A. Tonks [18].*

## 7. THE POSETS $\mathcal{PP}$ AND $\mathcal{KK}$

In this section we construct a poset  $\mathcal{PP}$  and an appropriate quotient poset  $\mathcal{KK}$ . The elements of  $\mathcal{KK}$  correspond with the 0-dimensional module generators of the free matrad  $\mathcal{H}_\infty$ . The geometric realization of  $\mathcal{KK}$ , constructed in Section 8, is the disjoint union of matrahedra  $\{KK_{n,m}\}_{m,n \geq 1}$  whose cellular chains are identified with  $\mathcal{H}_\infty$ .

Let  $\mathcal{V}_n$  denote the set of vertices of  $P_n$  and identify  $\mathcal{V}_n$  with the set  $S_n$  of permutations of  $\underline{n} = \{1, 2, \dots, n\}$  via the standard bijection  $\mathcal{V}_n \leftrightarrow S_n$ . The Bruhat partial ordering on  $S_n$  generated by the relation  $a_1 | \dots | a_n < a_1 | \dots | a_{i+1} | a_i | \dots | a_n$  if and only if  $a_i < a_{i+1}$  imposes a poset structure on  $\mathcal{V}_n$ . For  $n \geq 1$ , set  $\mathcal{PP}_{n,0} = \mathcal{PP}_{0,n} = \mathcal{V}_n$  and define the *geometric realization*  $PP_{n,0} = |\mathcal{PP}_{n,0}| = |\mathcal{PP}_{0,n}| = PP_{0,n}$  to be the permutahedron  $P_n$ . Then  $KK_{n+1,1} = |\mathcal{KK}_{n+1,1}| = |\mathcal{KK}_{1,n+1}| = KK_{1,n+1}$  is the Stasheff associahedron  $K_{n+1}$  (see [16], [17], [12]). In the discussion that follows, we construct the posets  $\mathcal{PP}_{n,m}$  and  $\mathcal{KK}_{n+1,m+1}$  and their geometric realizations  $PP_{n,m}$  and  $KK_{n+1,m+1}$  for all  $m, n \geq 1$ .

Denote the sets of uprooted and down-rooted binary trees with  $n+1$  leaves and  $n$  levels by  $\wedge_n$  and  $\vee_n$ , respectively, so that each vertex of  $P_n$  is indexed by two trees, one the reflection of the other. These indexing sets have a poset structure induced by the standard bijections  $\hat{\ell} : \wedge_n \rightarrow \mathcal{V}_n$  and  $\check{\ell} : \vee_n \rightarrow \mathcal{V}_n$ , and the products  $\wedge_n^{\times m}$ ,  $\vee_n^{\times m}$ , and  $\wedge_m^{\times n} \times \vee_n^{\times m}$  are posets with respect to lexicographic ordering. When faces of  $P_n$  are indexed by uprooted trees, its top dimensional cell is indexed by the uprooted corolla  $\theta_{n+1}^1$ , and dually when faces are indexed by downrooted trees. Now think of  $\Delta_P^{(n)}(\theta_{m+1}^1)$  as a subcomplex of  $P_m^{\times n+1}$  with faces indexed by products of uprooted trees; dually, think of  $\Delta_P^{(m)}(\theta_1^{n+1})$  as a subcomplex of  $P_n^{\times m+1}$  with faces indexed by products of down-rooted trees. Then the 0-skeletons

$X_m^{n+1} \subseteq \Delta_P^{(n)}(\theta_{m+1}^1)$  and  $Y_n^{m+1} \subseteq \Delta_P^{(m)}(\theta_1^{n+1})$  are subsets of  $\wedge_m^{\times n+1}$  and  $\vee_n^{\times m+1}$  and there is the inclusion of posets

$$X_m^{n+1} \times Y_n^{m+1} \hookrightarrow \wedge_m^{\times n+1} \times \vee_n^{\times m+1}.$$

Express  $x \in \wedge_m^{\times n}$  as an  $n \times 1$  column matrix of uprooted binary trees and replace  $x$  with its (unique) BTP factorization as a  $\Upsilon$ -product  $x_1 \cdots x_m \in \overline{\mathbf{M}}$ , where  $x_i$  is an  $n \times i$  matrix over  $\{\mathbf{1}, \lambda = \theta_2^1\}$  with  $\lambda$  appearing in each row exactly once. Dually, express  $y \in \vee_n^{\times m}$  as a  $1 \times m$  row matrix of down-rooted binary trees and replace  $y$  with its (unique) BTP factorization as a  $\Upsilon$ -product  $y_n \cdots y_1 \in \overline{\mathbf{M}}$ , where  $y_j$  is an  $j \times m$  matrix over  $\{\mathbf{1}, \gamma = \theta_1^2\}$  with  $\gamma$  appearing in each column exactly once.

**Example 21.** *The fact that  $\Delta_P^{(1)}(\lambda) = \lambda \times \lambda$  and  $\Delta_P^{(1)}(\gamma) = \gamma \times \gamma$  implies*

$$X_1^2 = \begin{bmatrix} \lambda \\ \lambda \end{bmatrix} \quad \text{and} \quad Y_1^2 = [\gamma \gamma] \quad \text{so that} \quad X_1^2 \times Y_1^2 = \begin{bmatrix} \lambda & \\ & \lambda \end{bmatrix} [\gamma \gamma].$$

When  $m = n = 2$ , the subcomplexes  $\Delta_P^{(1)}(\theta_3^1)$  and  $\Delta_P^{(1)}(\theta_1^3)$  of  $P_2 \times P_2$  agree with the Alexander-Whitney diagonal approximation on the square. Representations of its three vertices as products of permutations and matrix sequences are:

$$a|b \times c|d \quad : \quad 1|2 \times 1|2 \quad < \quad 1|2 \times 2|1 \quad < \quad 2|1 \times 2|1$$

$$X_2^2 \quad : \quad \begin{bmatrix} \lambda \\ \lambda \end{bmatrix} \begin{bmatrix} \lambda & \mathbf{1} \\ \lambda & \mathbf{1} \end{bmatrix} < \begin{bmatrix} \lambda \\ \lambda \end{bmatrix} \begin{bmatrix} \lambda & \mathbf{1} \\ \mathbf{1} & \lambda \end{bmatrix} < \begin{bmatrix} \lambda \\ \lambda \end{bmatrix} \begin{bmatrix} \mathbf{1} & \lambda \\ \mathbf{1} & \lambda \end{bmatrix}$$

$$Y_2^2 \quad : \quad \begin{bmatrix} \gamma & \mathbf{1} \\ \gamma & \mathbf{1} \end{bmatrix} [\gamma \gamma] < \begin{bmatrix} \gamma & \mathbf{1} \\ \mathbf{1} & \gamma \end{bmatrix} [\gamma \gamma] < \begin{bmatrix} \mathbf{1} & \gamma \\ \mathbf{1} & \gamma \end{bmatrix} [\gamma \gamma]$$

Furthermore,  $\Delta_P^{(2)}(\gamma) = \gamma \times \gamma \times \gamma$  implies  $Y_1^3 = [\gamma \gamma \gamma]$  so that  $X_2^2 \times Y_1^3 =$

$$\left\{ \begin{bmatrix} \lambda \\ \lambda \end{bmatrix} \begin{bmatrix} \lambda & \mathbf{1} \\ \lambda & \mathbf{1} \end{bmatrix} [\gamma \gamma \gamma] < \begin{bmatrix} \lambda \\ \lambda \end{bmatrix} \begin{bmatrix} \lambda & \mathbf{1} \\ \mathbf{1} & \lambda \end{bmatrix} [\gamma \gamma \gamma] < \begin{bmatrix} \lambda \\ \lambda \end{bmatrix} \begin{bmatrix} \mathbf{1} & \lambda \\ \mathbf{1} & \lambda \end{bmatrix} [\gamma \gamma \gamma] \right\}.$$

**Definition 12.** *Let  $A = [a_{ij}]$  be an  $(n+1) \times m$  matrix over  $\{\mathbf{1}, \lambda\}$ , each row of which contains the entry  $\lambda$  exactly once. Let  $B = [b_{ij}]$  be an  $n \times (m+1)$  matrix over  $\{\mathbf{1}, \gamma\}$ , each column of which contains the entry  $\gamma$  exactly once. Then  $(A, B)$  is an  $(i, j)$ -edge pair if*

- (i)  $A \otimes B$  is a BTP,
- (ii)  $a_{ij} = a_{i+1, j} = \lambda$  and  $b_{ij} = b_{i, j+1} = \gamma$ .

For  $A_1 \cdots A_m B_n \cdots B_1 \in X_m^{n+1} \times Y_n^{m+1}$ , the only possible edge pair in is  $(A_m, B_n)$ . In  $X_2^3 \times Y_2^3$ , for example, the respective matrix sequences

$$\begin{bmatrix} \lambda \\ \lambda \\ \lambda \end{bmatrix} \begin{bmatrix} \lambda & \mathbf{1} \\ \lambda & \mathbf{1} \\ \lambda & \mathbf{1} \end{bmatrix} \begin{bmatrix} \gamma & \gamma & \mathbf{1} \\ \mathbf{1} & \mathbf{1} & \gamma \end{bmatrix} [\gamma \gamma \gamma] \quad \text{and} \quad \begin{bmatrix} \lambda \\ \lambda \\ \lambda \end{bmatrix} \begin{bmatrix} \lambda & \mathbf{1} \\ \lambda & \mathbf{1} \\ \lambda & \mathbf{1} \end{bmatrix} \begin{bmatrix} \gamma & \mathbf{1} & \mathbf{1} \\ \mathbf{1} & \gamma & \gamma \end{bmatrix} [\gamma \gamma \gamma]$$

do and do not contain an edge pair.

**Definition 13.** *Let  $Q$  be a poset and let  $x_1 \leq x_2 \in Q$ . The pair  $(x_1, x_2)$  is an edge of  $Q$  if  $x \in Q$  and  $x_1 \leq x \leq x_2$  implies  $x = x_1$  or  $x = x_2$ .*

Edges of  $X_m^{n+1} \times Y_n^{m+1}$  correspond to 1-dimensional elements of  $\mathcal{H}_\infty$  generated by  $\{\mathbf{1}, \theta_2^1, \theta_1^2, \theta_3^1, \theta_1^3\}$ ; 1-dimensional elements of  $\mathcal{H}_\infty$  generated by  $\{\mathbf{1}, \theta_2^1, \theta_1^2, \theta_2^2\}$

correspond to edges of a poset  $Z_{n,m}$  related to but disjoint from  $X_m^{n+1} \times Y_n^{m+1}$ , which we now define.

Let  $A^{i^*}$  and  $B^{*j}$  denote the matrices obtained by deleting the  $i^{\text{th}}$  row of  $A$  and the  $j^{\text{th}}$  column of  $B$ .

**Definition 14.** Let  $c = C_1 \cdots C_r$  be a sequence of matrices such that  $(C_k, C_{k+1})$  is an  $(i, j)$ -edge pair for some  $k \leq r - 1$ . The  $(i, j)$ -transposition of  $c$  in position  $k$  is the sequence

$$\mathcal{T}_{ij}^k(c) = C_1 \cdots C_{k+1}^{*j} C_k^{i^*} \cdots C_r.$$

The symbol  $\mathcal{T}_{ij}^k(c)$  implies that the action of  $\mathcal{T}_{ij}^k$  on  $c$  is defined.

Note that if  $\mathcal{T}_{ij}^k$  acts on  $u = A_1 \cdots A_m B_n \cdots B_1 \in X_m^{n+1} \times Y_n^{m+1}$ , then  $k = m$  and the potential edge pairs of consecutive matrices in

$$\mathcal{T}_{ij}^m(u) = A_1 \cdots A_{m-1} B_n^{*j} A_m^{i^*} B_{n-1} \cdots B_1$$

are  $(A_{m-1}, B_n^{*j})$  and  $(A_m^{i^*}, B_{n-1})$ . If  $(A_{m-1}, B_n^{*j})$  is an edge pair and  $\mathcal{T}_{kl}^{m-1}$  is defined on  $\mathcal{T}_{ij}^m(u)$ , then

$$\mathcal{T}_{kl}^{m-1} \mathcal{T}_{ij}^m(u) = A_1 \cdots A_{m-2} B_n^{*j*l} A_{m-1}^{k*} A_m^{i^*} B_{n-1} \cdots B_1,$$

and so on. In this manner, iterate  $\mathcal{T}$  on each element  $u \in X_m^{n+1} \times Y_n^{m+1}$  in all possible ways and obtain

$$Z_{n,m} = \left\{ \mathcal{T}_{i_t j_t}^{k_t} \cdots \mathcal{T}_{i_1 j_1}^{k_1}(u) \mid u \in X_m^{n+1} \times Y_n^{m+1}, t \geq 1 \right\}.$$

Then

$$\mathcal{PP}_{n,m} = X_m^{n+1} \times Y_n^{m+1} \cup Z_{n,m}.$$

To extend the partial ordering to  $Z_{n,m}$ , first define  $c < \mathcal{T}_{ij}^k(c)$  for  $c \in \mathcal{PP}_{n,m}$ . To define a generating relation on  $Z_{n,m}$ , note that each composition  $\mathcal{T}_{i_t j_t}^{k_t} \cdots \mathcal{T}_{i_1 j_1}^{k_1}$  defined on  $u \in X_m^{n+1} \times Y_n^{m+1}$  uniquely determines an  $(m, n)$ -shuffle  $\sigma$ , in which case we denote

$$\mathcal{T}_\sigma(u) = \mathcal{T}_{i_t j_t}^{k_t} \cdots \mathcal{T}_{i_1 j_1}^{k_1}(u)$$

and define  $\mathcal{T}_{\text{Id}} = \text{Id}$ . On the other hand, if some  $(m, n)$ -shuffle  $\sigma \neq \text{Id}$  cannot be realized as a composition of  $(i, j)$ -transpositions on  $u$ , the symbol  $\mathcal{T}_\sigma(u)$  is undefined. For  $u_1 \leq u_2 \in X_m^{n+1} \times Y_n^{m+1}$ , define  $\mathcal{T}_\sigma(u_1) \leq \mathcal{T}_\sigma(u_2)$  if  $(u_1, u_2)$  is an edge of  $X_m^{n+1} \times Y_n^{m+1}$  or  $u_2$  is “ $\sigma$ -compatible” with  $u_1$  in the following sense: Let  $a = a_1 | \cdots | a_m \in S_m$  and  $b = b_1 | \cdots | b_n \in S_n$ . The action of  $\sigma$  on  $(a; b)$  decomposes  $a$  and  $b$  into subsequences  $\mathbf{m}_1, \dots, \mathbf{m}_k$  and  $\mathbf{n}_1, \dots, \mathbf{n}_l$  in one of the following four ways:

$$\sigma(a; b) = \begin{cases} \mathbf{m}_1, \mathbf{n}_1, \mathbf{m}_2, \mathbf{n}_2, \dots, \mathbf{n}_{k-1}, \mathbf{m}_k, & \sigma(a_1) = a_1, \sigma(b_n) \neq b_n \\ \mathbf{m}_1, \mathbf{n}_1, \mathbf{m}_2, \mathbf{n}_2, \dots, \mathbf{m}_k, \mathbf{n}_k, & \sigma(a_1) = a_1, \sigma(b_n) = b_n \\ \mathbf{n}_1, \mathbf{m}_1, \mathbf{n}_2, \mathbf{m}_2, \dots, \mathbf{n}_k, \mathbf{m}_k, & \sigma(a_1) \neq a_1, \sigma(b_n) \neq b_n \\ \mathbf{n}_1, \mathbf{m}_1, \mathbf{n}_2, \mathbf{m}_2, \dots, \mathbf{m}_k, \mathbf{n}_{k+1}, & \sigma(a_1) \neq a_1, \sigma(b_n) = b_n. \end{cases}$$

Define  $\mathbf{I}_\sigma = \{(\alpha_1, \dots, \alpha_{n+1}) \in S_m^{\times n+1} \mid \alpha_i \in S_{\#\mathbf{m}_1} \times \cdots \times S_{\#\mathbf{m}_k} \subset S_m\}$  for all  $i$  and  $\mathbf{J}_\sigma = \{(\beta_1, \dots, \beta_{m+1}) \in S_n^{\times m+1} \mid \beta_j \in S_{\#\mathbf{n}_1} \times \cdots \times S_{\#\mathbf{n}_l} \subset S_n\}$  for all  $j$ . Let  $\chi : \mathcal{V}_m \rightarrow \mathcal{V}_m$  be the involutory bijection defined by

$$\chi(a_1 | \cdots | a_m) = (m+1-a_m) | \cdots | (m+1-a_1)$$

and fix the inclusion of posets

$$(7.1) \quad X_m^{n+1} \times Y_n^{m+1} \xrightarrow{\kappa} \mathcal{V}_m^{\times n+1} \times \mathcal{V}_n^{\times m+1} \leftrightarrow S_m^{\times n+1} \times S_n^{\times m+1},$$

where  $\kappa = (\chi \circ \ell)^{\times n+1} \times (\tilde{\ell})^{\times m+1}$ . Then  $u_2$  is  $\sigma$ -compatible with  $u_1$  if  $u_2 = (\alpha \times \beta)(u_1)$  for some  $\alpha \times \beta \in \mathbf{I}_\sigma \times \mathbf{J}_\sigma$ .

To view this geometrically, suppose  $u_2 = A'_1 \cdots A'_m B'_n \cdots B'_1$  is  $\sigma$ -compatible with  $u_1 = A_1 \cdots A_m B_n \cdots B_1$  in  $X_m^{n+1} \times Y_n^{m+1}$ . For each  $i$ , let  $a_i = i_1 | \cdots | i_m$  and  $a'_i = i'_1 | \cdots | i'_m$  be the permutations of  $\underline{m}$  corresponding with the up-rooted trees given by  $\gamma$ -products  $A_{i,1} \cdots A_{i,m}$  and  $A'_{i,1} \cdots A'_{i,m}$  of  $i^{\text{th}}$  rows, respectively; dually, for each  $j$ , let  $b_j = j_1 | \cdots | j_n$  and  $b'_j = j'_1 | \cdots | j'_n$  be the permutations of  $\underline{n}$  corresponding with the down-rooted trees given by the  $\gamma$ -products  $B_{n,j} \cdots B_{1,j}$  and  $B'_{n,j} \cdots B'_{1,j}$  of  $j^{\text{th}}$  columns, respectively. Then for each  $(i, j)$ , the  $\sigma$ -partition of  $(a_i; b_j)$  determines a product face  $\mathbf{m}_1 | \cdots | \mathbf{m}_k \times \mathbf{n}_1 | \cdots | \mathbf{n}_l \subset P_m \times P_n$  containing the vertices  $a_i \times b_j$  and  $a'_i \times b'_j$  and an oriented path of edges from  $a_i \times b_j$  to  $a'_i \times b'_j$ .

**Remark 5.** Note that if  $(u_1, u_2)$  is an edge of  $X_m^{n+1} \times Y_n^{m+1}$ , the partial ordering in  $\mathcal{PP}_{n,m}$  implies that  $(\mathcal{T}(u_1), \mathcal{T}(u_2))$  is an edge of  $\mathcal{PP}_{n,m}$ . The transpose map  $X_m^{n+1} \times Y_n^{m+1} \rightarrow X_m^{n+1} \times Y_n^{m+1}$  given by  $A_1 \cdots A_m B_n \cdots B_1 \mapsto B_1^T \cdots B_n^T A_m^T \cdots A_1^T$  induces a canonical order-preserving bijection  $\mathcal{PP}_{n,m} \leftrightarrow \mathcal{PP}_{m,n}$ .

**Example 22.** Using the notation of Example 21, let us determine those elements  $u_i \in X_2^2 \times Y_1^3$  that are  $\sigma$ -compatible with  $u_1$ . Since all matrices in  $u_1$  have constant columns or rows,  $a_i \times b_j = 1|2 \times 1 \subset P_2 \times P_1$  for all  $i, j$ . The  $(2, 1)$ -shuffles of  $(1, 2; 3)$  are  $\sigma_0 = 1|2|3$ ,  $\sigma_1 = 1|3|2$  and  $\sigma_2 = 3|1|2$ . The  $\sigma_1$ -partition of  $(1|2; 1)$  determines the face  $1|2 \times 1 \subset P_2 \times P_1$  whose only vertex is  $u_1$ . Hence the only element of  $X_2^2 \times Y_1^3$  that is  $\sigma_1$ -compatible with  $u_1$  is itself. If  $\sigma \in \{\sigma_0, \sigma_2\}$ , the  $\sigma$ -partition of  $(1|2; 1)$  determines the face  $12 \times 1 \subset P_2 \times P_1$  with vertices are  $1|2 \times 1$  and  $2|1 \times 1$ . Since all matrices in  $u_3$  have constant columns or rows,  $a'_i \times b'_j = 2|1 \times 1$  for all  $i, j$  implies that  $u_3$  is  $\sigma$ -compatible with  $u_1$ . Furthermore,  $a'_1 \times b'_j = 1|2 \times 1$  and  $a'_2 \times b'_j = 2|1 \times 1$  for all  $j$  implies that  $u_2$  is also  $\sigma$ -compatible with  $u_1$ . Since  $u_1 < u_3$  we have  $\mathcal{T}_{\sigma_2}(u_1) < \mathcal{T}_{\sigma_2}(u_3)$ .

**Example 23.** Since  $Z_{1,1} = [\gamma][\lambda]$  we have

$$\mathcal{PP}_{1,1} = \left\{ \left[ \begin{array}{c} \lambda \\ \lambda \end{array} \right] [\gamma\gamma] < [\gamma][\lambda] \right\}.$$

Using the notation of Example 22, the action of  $\mathcal{T}$  on

$$u_1 = \left[ \begin{array}{c} \lambda \\ \lambda \end{array} \right] \left[ \begin{array}{c} \lambda \mathbf{1} \\ \lambda \mathbf{1} \end{array} \right] [\gamma \gamma \gamma] \text{ and } u_3 = \left[ \begin{array}{c} \lambda \\ \lambda \end{array} \right] \left[ \begin{array}{c} \mathbf{1} \lambda \\ \mathbf{1} \lambda \end{array} \right] [\gamma \gamma \gamma]$$

produces the following four elements of  $Z_{1,2}$ :

$$\begin{aligned} u_1 &\xrightarrow{\mathcal{T}_{\sigma_1}} \left[ \begin{array}{c} \lambda \\ \lambda \end{array} \right] [\gamma\gamma][\lambda \mathbf{1}] \xrightarrow{\mathcal{T}_{\sigma_2}} [\gamma][\lambda][\lambda \mathbf{1}]; \\ u_3 &\xrightarrow{\mathcal{T}_{\sigma_1}} \left[ \begin{array}{c} \lambda \\ \lambda \end{array} \right] [\gamma\gamma][\mathbf{1} \lambda] \xrightarrow{\mathcal{T}_{\sigma_2}} [\gamma][\lambda][\mathbf{1} \lambda]. \end{aligned}$$

Thus  $\mathcal{PP}_{1,2} = \{u_1 < \mathcal{T}_{\sigma_1}(u_1) < \mathcal{T}_{\sigma_2}(u_1), u_2, u_3 < \mathcal{T}_{\sigma_1}(u_3) < \mathcal{T}_{\sigma_2}(u_3)\}$ . Recall that the action of  $\mathcal{T}$  on  $u_2$  is undefined, and as mentioned in Examples 21 and 22,  $u_1 < u_2 < u_3$  and  $\mathcal{T}_{\sigma_2}(u_1) < \mathcal{T}_{\sigma_2}(u_3)$  (see Figure 13).

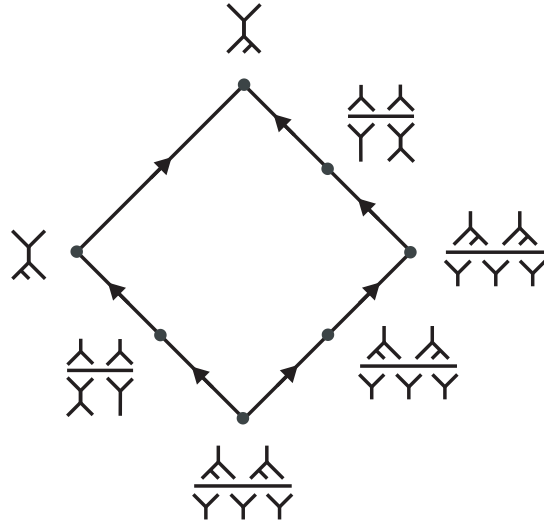

Figure 13. The digraph of  $\mathcal{PP}_{1,2}$ .

One can represent  $u = A_1 \cdots A_m B_n \cdots B_1 \in X_m^{n+1} \times Y_n^{m+1}$  and  $z = \mathcal{T}_\sigma(u) \in Z_{n,m}$  as piecewise linear paths of from  $(m+1, 1)$  to  $(1, n+1)$  in the integer lattice  $\mathbb{N}^2$  with  $m+n$  horizontal and vertical directed components. The arrow  $(i+1, n+1) \rightarrow (i, n+1)$  represents  $A_i$ , while the arrow  $(m+1, j) \rightarrow (m+1, j+1)$  represents  $B_j$ . Consequently,  $u$  is represented by the path  $(m+1, 1) \rightarrow \cdots \rightarrow (m+1, n+1) \rightarrow \cdots \rightarrow (1, n+1)$ , and  $z$  by some other path. In general, if the path  $(r+1, s-1) \rightarrow (r+1, s) \rightarrow (r, s)$  represents the edge pair  $(A'_k, B'_l)$  in  $z$ , the path  $(r+1, s-1) \rightarrow (r, s-1) \rightarrow (r, s)$  represents its transposition  $(B''_l, A''_k)$  in  $\mathcal{T}(z)$  (see Figure 14).

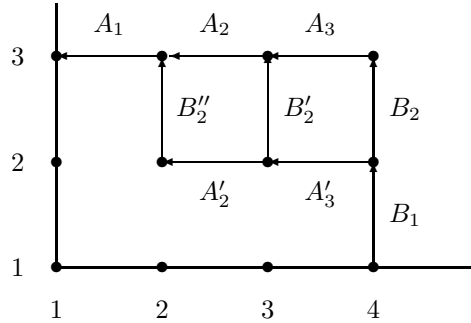

Figure 14.  $A_1 A_2 A_3 B_2 B_1 < A_1 A_2 B'_2 A'_3 B_1 < A_1 B''_2 A'_2 A'_3 B_1$ .

The poset  $\mathcal{KK}$  is a quotient of  $\mathcal{PP}$ , which we now describe. Recall Tonks' projection  $\vartheta_0 : P_m \rightarrow K_{m+1}$  [18]: If  $a$  and  $b$  are faces of  $P_m$ , then  $\vartheta_0(a) = \vartheta_0(b)$  if and only if corresponding PLTs are isomorphic as planar rooted trees (forgetting levels). Define  $a \sim b$  if  $\vartheta_0(a) = \vartheta_0(b)$ . Then  $\tilde{\mathcal{V}}_{m+1} = \vartheta_0(\mathcal{V}_m)$  is the set of vertices of  $K_{m+1}$ . For example,  $3|1|2 = 1|3|2 \in \tilde{\mathcal{V}}_4$ , since  $3|1|2$  and  $1|3|2$  are end points of the degenerate edge  $13|2 \subset P_3$ , and in terms matrix sequences we have  $[\lambda][\lambda \mathbf{1}][\mathbf{1} \mathbf{1} \lambda] = [\lambda][\mathbf{1} \lambda][\lambda \mathbf{1} \mathbf{1}]$  (and dually  $[\mathbf{1} \mathbf{1} \gamma]^T [\gamma \mathbf{1}]^T [\gamma] = [\gamma \mathbf{1} \mathbf{1}]^T [\mathbf{1} \gamma]^T [\gamma]$ ). Of course,  $\mathcal{V}_1 = \tilde{\mathcal{V}}_2 = [\lambda]$  and  $\mathcal{V}_2 = \tilde{\mathcal{V}}_3 = \{[\lambda][\lambda \mathbf{1}], [\lambda][\mathbf{1} \lambda]\}$ .

For matrix sequences in  $X_m^{n+1}$ , define  $x'_1 \cdots x'_m \sim_X x_1 \cdots x_m$  if the trees produced by  $\gamma$ -products of  $i^{\text{th}}$  rows are equivalent for each  $i$ . Dually, for matrix sequences in  $Y_n^{m+1}$ , define  $y'_n \cdots y'_1 \sim_Y y_n \cdots y_1$  if the trees produced by  $\gamma$ -products of  $j^{\text{th}}$  columns are equivalent for each  $j$ . Define  $a \times b \sim c \times d$  in  $X_m^{n+1} \times Y_n^{m+1}$  if  $a \sim_X c$  and  $b \sim_Y d$ . Finally, for  $u_1 \leq u_2 \in X_m^{n+1} \times Y_n^{m+1}$  and  $z_1 = \mathcal{T}_\sigma(u_1) \leq z_2 = \mathcal{T}_\sigma(u_2)$ , define  $z_1 \sim z_2$  if  $u_1 \sim u_2$ . Then

$$\mathcal{K}\mathcal{K}_{n+1,m+1} = \mathcal{P}\mathcal{P}_{n,m}/\sim ;$$

and  $\vartheta : \mathcal{P}\mathcal{P}_{n,m} \rightarrow \mathcal{K}\mathcal{K}_{n+1,m+1}$  denotes the projection.

## 8. CONSTRUCTIONS OF $PP$ AND $KK$

We conclude the paper with constructions of the geometric realizations  $PP = |\mathcal{P}\mathcal{P}|$  and  $KK = |\mathcal{K}\mathcal{K}|$ . While the edges of  $PP$  and  $KK$  realize the edges of  $\mathcal{P}\mathcal{P}$  and  $\mathcal{K}\mathcal{K}$ , it is difficult to imagine their higher dimensional faces. Fortunately,  $PP_{n,m}$  is a subdivision of the permutahedron  $P_{m+n}$ , which is a subdivision of  $I^{n+m-1}$ . Thus the higher dimensional combinatorics of  $PP_{n,m}$  are determined by the orientation on the faces of  $I^{m+n-1}$ . More precisely, we construct  $PP_{n,m}$  as a two-step subdivision process: (1) Perform an “ $(m, n)$ -subdivision” of the codimension 1 cell  $\underline{m} | (\underline{n} + m) \subset P_{m+n}$  and (2) use the  $(m, n)$ -subdivision to subdivide certain other cells of  $P_{m+n}$ . But first we need some preliminaries.

**8.1. Matrices with constant rows or columns.** Given a set  $Q$  of matrix sequences, let

$$\text{con } Q = \{C_1 \cdots C_s \in Q \mid C_k \text{ has constant rows or constant columns}\}.$$

Note that if  $A_1 \cdots A_m \in \text{con } X_m^{n+1}$ , each  $A_i$  has constant columns; dually, if  $B_n \cdots B_1 \in \text{con } Y_n^{m+1}$ , each  $B_j$  has constant rows. Consequently, the inclusion of posets  $\kappa : X_m^{n+1} \times Y_n^{m+1} \hookrightarrow \mathcal{V}_m^{\times n+1} \times \mathcal{V}_n^{\times m+1}$  given in (7.1) restricts to an order-preserving bijection

$$\begin{aligned} (\chi \circ \hat{\ell}) \times \check{\ell} : \text{con}(X_m^{n+1} \times Y_n^{m+1}) &\leftrightarrow \text{con } X_m^{n+1} \times \text{con } Y_n^{m+1} \\ (8.1) \quad &\leftrightarrow \Delta(\mathcal{V}_m^{\times n+1}) \times \Delta(\mathcal{V}_n^{\times m+1}) \leftrightarrow \mathcal{V}_m \times \mathcal{V}_n, \end{aligned}$$

where  $\Delta(\mathcal{V}_m^{\times n+1}) \leftrightarrow \mathcal{V}_m$  is given by the embedding  $\mathcal{V}_m \hookrightarrow \mathcal{V}_m^{\times n+1}$  along the diagonal subposet  $\Delta(\mathcal{V}_m^{\times n+1}) = \{(v, \dots, v) \mid v \in \mathcal{V}_m\}$ . Thus elements of  $\mathcal{V}_m \times \mathcal{V}_n$  may be represented as matrix sequences in  $\text{con}(X_m^{n+1} \times Y_n^{m+1})$ .

Note that  $(i, j)$ -transpositions preserve constant rows and columns, i.e.,  $u \in \text{con } \mathcal{P}\mathcal{P}_{n,m}$  if and only if  $\mathcal{T}_{ij}^k(u) \in \text{con } \mathcal{P}\mathcal{P}_{n,m}$ . And furthermore, if  $u = A_1 \cdots A_m B_n \cdots B_1 \in \text{con}(X_m^{n+1} \times Y_n^{m+1})$ , and  $\sigma$  is an  $(m, n)$ -shuffle,  $\mathcal{T}_\sigma(u)$  is defined since each  $A_i$  has a constant column of  $\lambda$ 's and each  $B_j$  has a constant row of  $\gamma$ 's. Thus

$$(8.2) \quad \text{con } \mathcal{P}\mathcal{P}_{n,m} = \bigcup_{(m,n)\text{-shuffles } \sigma} \mathcal{T}_\sigma(\text{con}(X_m^{n+1} \times Y_n^{m+1})).$$

The order-preserving bijection

$$\text{con } \mathcal{P}\mathcal{P}_{1,2} = \mathcal{P}\mathcal{P}_{1,2} \setminus \{u_2\} \leftrightarrow \mathcal{V}_3$$

discussed in Example 23 illustrates the following remarkable fact:



**Proposition 4.** *The bijection  $(\chi \circ \hat{\ell}) \times \check{\ell} : \text{con}(X_m^{n+1} \times Y_n^{m+1}) \rightarrow \mathcal{V}_m \times \mathcal{V}_n$  extends to a canonical order-preserving bijection*

$$\kappa_\# : \text{con}\mathcal{PP}_{n,m} \rightarrow \mathcal{V}_{m+n}.$$

Thus  $|\kappa_\#| : |\text{con}\mathcal{PP}_{n,m}| \xrightarrow{\cong} P_{m+n}$ .

*Proof.* There is the order-preserving bijection  $(\chi \circ \hat{\ell}) \times \check{\ell} : \text{con}(X_m^{n+1} \times Y_n^{m+1}) \leftrightarrow S_m \times S_n$  via the identification  $\mathcal{V}_m \times \mathcal{V}_n \leftrightarrow S_m \times S_n$ . Thus

$$\text{con}\mathcal{PP}_{n,m} \leftrightarrow \{\sigma \circ (\sigma_m \times \sigma_n) \mid \sigma \text{ is an } (m, n)\text{-shuffle; } \sigma_m \times \sigma_n \in S_m \times S_n\}$$

by formula (8.2). But each permutation in  $S_{m+n}$  factors as  $\sigma \circ (\sigma_m \times \sigma_n)$  for some  $(m, n)$ -shuffle  $\sigma$  and some  $\sigma_m \times \sigma_n \in S_m \times S_n$ . Therefore  $(\chi \circ \hat{\ell}) \times \check{\ell}$  extends to  $\kappa_\# : \text{con}\mathcal{PP}_{n,m} \leftrightarrow S_{m+n} \leftrightarrow \mathcal{V}_{m+n}$ .  $\square$

**Corollary 1.** *For all  $m, n \geq 1$ , there is the commutative diagram*

$$\begin{array}{ccc} |\text{con}(X_m^{n+1} \times Y_n^{m+1})| & \leftrightarrow & |\text{con}\mathcal{PP}_{n,m}| \\ |\kappa| \downarrow \approx & & \approx \downarrow |\kappa_\#| \\ \underline{m} | (\underline{n} + m) & \leftrightarrow & P_{m+n}. \end{array}$$

Note that Corollary 1 involves two different correspondences between  $\gamma$ -products of matrices and vertices of permutahedra.

**Example 24.** *Continuing Example 23, the identification  $\text{con}\mathcal{PP}_{1,1} \leftrightarrow \mathcal{V}_2$  is given by*

$$\begin{array}{ccc} \begin{bmatrix} \lambda \\ \lambda \end{bmatrix} [\gamma \gamma] & \xrightarrow{\mathcal{T}} & [\gamma] [\lambda] \\ \downarrow & & \downarrow \\ 1 | (1 + 1) & \xrightarrow{(1,1)\text{-shuffle}} & 2 | 1. \end{array}$$

The identification  $\text{con}\mathcal{PP}_{1,2} \leftrightarrow \mathcal{V}_3$ :

$$\begin{bmatrix} \lambda \\ \lambda \end{bmatrix} \begin{bmatrix} \lambda & \mathbf{1} \\ \lambda & \mathbf{1} \end{bmatrix} \leftrightarrow \theta_2^1 [\theta_2^1 \ \theta_1^1] \leftrightarrow 1 | 2 \in S_2 \text{ and } [\gamma \ \gamma \ \gamma] \leftrightarrow \theta_1^2 \leftrightarrow 1 \in S_1$$

so that

$$u_1 = \begin{bmatrix} \lambda \\ \lambda \end{bmatrix} \begin{bmatrix} \lambda & \mathbf{1} \\ \lambda & \mathbf{1} \end{bmatrix} [\gamma \ \gamma \ \gamma] \leftrightarrow 1 | 2 | (1 + 2) = 1 | 2 | 3 \in S_2 \times S_1.$$

Similarly,

$$u_3 = \begin{bmatrix} \lambda \\ \lambda \end{bmatrix} \begin{bmatrix} \mathbf{1} & \lambda \\ \mathbf{1} & \lambda \end{bmatrix} [\gamma \ \gamma \ \gamma] \leftrightarrow 2 | 1 | (1 + 2) = 2 | 1 | 3 \in S_2 \times S_1$$

and we have

$$\begin{array}{ccc}
\begin{bmatrix} \lambda \\ \lambda \end{bmatrix} \begin{bmatrix} \lambda & \mathbf{1} \\ \lambda & \mathbf{1} \end{bmatrix} [\Upsilon \Upsilon \Upsilon] & \xrightarrow{\mathcal{T}_{\sigma_1}} & \begin{bmatrix} \lambda \\ \lambda \end{bmatrix} [\Upsilon \Upsilon] [\lambda \mathbf{1}] \xrightarrow{\mathcal{T}_{\sigma_2}} [\Upsilon][\lambda][\lambda \mathbf{1}] \\
\downarrow & & \downarrow \qquad \qquad \qquad \downarrow \\
1|2|3 & & 1|3|2 \qquad \qquad \qquad 3|1|2 \\
& & \underbrace{\hspace{10em}} \\
& & (2, 1)\text{-shuffles of } 1|2|3
\end{array}$$
  

$$\begin{array}{ccc}
\begin{bmatrix} \lambda \\ \lambda \end{bmatrix} \begin{bmatrix} \mathbf{1} \lambda \\ \mathbf{1} \lambda \end{bmatrix} [\Upsilon \Upsilon \Upsilon] & \xrightarrow{\mathcal{T}_{\sigma_1}} & \begin{bmatrix} \lambda \\ \lambda \end{bmatrix} [\Upsilon \Upsilon] [\mathbf{1} \lambda] \xrightarrow{\mathcal{T}_{\sigma_2}} [\Upsilon][\lambda][\mathbf{1} \lambda] \\
\downarrow & & \downarrow \qquad \qquad \qquad \downarrow \\
2|1|3 & & 2|3|1 \qquad \qquad \qquad 3|2|1 \\
& & \underbrace{\hspace{10em}} \\
& & (2, 1)\text{-shuffles of } 2|1|3.
\end{array}$$

The projection  $\vartheta : \text{con } \mathcal{PP}_{n,m} \rightarrow \text{con } \mathcal{PP}_{n,m} / \sim$  has the following simple geometrical interpretation: An element of  $\text{con } (X_m^{n+1} \times Y_n^{m+1})$  is represented as a fraction with multiple copies of the *same* leveled binary tree in the numerator and likewise in the denominator. Two such elements are equivalent if and only if the trees in their numerators or denominators (possibly both) are isomorphic as PRTs. So equivalence in  $\text{con } (X_m^{n+1} \times Y_n^{m+1})$  amounts to forgetting levels as in Tonks' projection. The poset structure then propagates this equivalence to general elements of  $\text{con } \mathcal{PP}_{n,m}$ .

**Remark 6.** *Our constructions are independent of the various choices involved here. If  $\tilde{\Delta}_P^{(k)}$  iterates  $\Delta_P$  on factors other than the those on the extreme left, let  $\tilde{X}_m^{n+1} \times \tilde{Y}_n^{m+1}$  be the poset defined in terms of  $\tilde{\Delta}_P^{(k)}$  and let  $\widetilde{\mathcal{PP}}_{n,m}$  be the poset produced by our construction. Then there is a canonical bijection  $\mathcal{PP}_{n,m} \leftrightarrow \widetilde{\mathcal{PP}}_{n,m}$  and the corresponding geometric realizations are canonically homeomorphic. When  $\Delta_P$  acts on the extreme right, for example, a (combinatorial) isomorphism  $|\mathcal{PP}_{n,m}| \cong |\widetilde{\mathcal{PP}}_{n,m}|$  is evident pictorially: The picture of  $|\mathcal{PP}_{n,m}|$  uses the standard orientation of the interval  $P_2$ , while the picture of  $|\widetilde{\mathcal{PP}}_{n,m}|$  uses the opposite orientation, but nevertheless, these pictures are identical.*

**8.2. Step 1: The  $(m, n)$ -subdivision of  $\underline{m} | (\underline{n} + m)$ .** The first step in our construction of  $PP_{n,m}$  performs an “ $(m, n)$ -subdivision” of the codimension 1 cell  $\underline{m} | (\underline{n} + m) \subset P_{n+m}$ . In Subsection 3.2 we applied the left-iterated diagonal  $\Delta_P^{(n)}$  to construct the  $n$ -subdivision  $P_m^{(n)}$  of  $P_m$ . Since poset  $X_m^{n+1}$  is the 0-skeleton of  $\Delta_P^{(n)}(\lambda_{m+1})$ , the geometric realization  $|X_m^{n+1}| = P_m^{(n)}$ , and dually  $|Y_n^{m+1}| = P_n^{(m)}$ . The cellular subdivision  $|X_m^{n+1} \times Y_n^{m+1}| = P_m^{(n)} \times P_n^{(m)}$  of  $\underline{m} | (\underline{n} + m) = P_m \times P_n$  is called the  $(m, n)$ -subdivision of  $\underline{m} | (\underline{n} + m)$ ; thus each cell in this subdivision has a canonical Cartesian product decomposition. The *basic subdivision vertices* of  $PP_{n,m}$  are elements of

$$\mathcal{BS}_{n,m} = (X_m^{n+1} \times Y_n^{m+1}) \setminus \mathcal{V}_{m+n}.$$

Each subdivision cell of  $PP_{n,m}$  is a proper subset of some cell of  $P_{m+n}$  and is the geometric realization of its poset of vertices.

**Example 25.** The 1-subdivision  $P_2^{(1)}$  consists of two 1-cells obtained by subdividing the interval  $P_2$  at its midpoint (see Figure 4). Thus the  $(2, 1)$ -subdivision  $P_2^{(1)} \times P_1^{(2)}$  of the edge  $12|3 \subset P_3$  contains one basic subdivision vertex represented by the midpoint

$$u_2 = \begin{bmatrix} \lambda \\ \lambda \end{bmatrix} \begin{bmatrix} \lambda & \mathbf{1} \\ \mathbf{1} & \lambda \end{bmatrix} [\gamma \ \gamma \ \gamma] \in X_2^2 \times Y_1^3 \setminus \text{con}(X_2^2 \times Y_1^3),$$

and two 1-cells of  $PP_{1,2}$ . In fact,  $PP_{1,2}$  is exactly the heptagon obtained by subdividing  $P_3$  in this way. The 2-subdivision  $P_2^{(2)}$  consists of three 1-cells obtained by subdividing  $P_2$  at its midpoint and again at its three-quarter point. Thus the  $(2, 2)$ -subdivision  $P_2^{(2)} \times P_2^{(2)}$  of the square  $12|34 \subset P_4$  contains twelve basic subdivision vertices and nine 2-cells of  $PP_{2,2}$  as pictured in Figure 15.

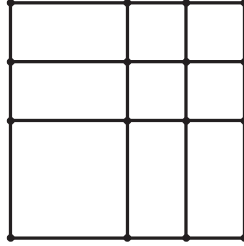

Figure 15. The  $(2, 2)$ -subdivision  $P_2^{(2)} \times P_2^{(2)}$ .

The  $(3, 1)$ -subdivision  $P_3^{(1)} \times P_1^{(3)}$  of the hexagon  $123|4 \subset P_4$  is identified with the 1-subdivision  $P_3^{(1)}$  and contains eleven basic subdivision vertices and eight 2-cells of  $PP_{3,1}$  as pictured in Figure 16.

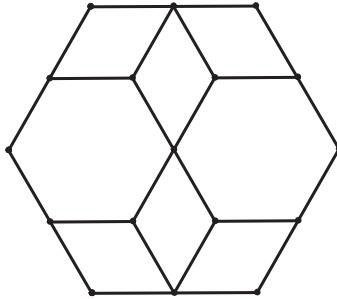

Figure 16. The  $(3, 1)$ -subdivision  $P_3^{(1)} \times P_1^{(3)}$ .

The  $(3, 2)$ -subdivision  $P_3^{(2)} \times P_2^{(3)}$  of the cylinder  $123|45 \subset P_5$ , obtained from  $P_3^{(2)} \times I$  by subdividing along the horizontal cross-sections  $P_3^{(2)} \times \frac{1}{2}$ ,  $P_3^{(2)} \times \frac{3}{4}$ , and  $P_3^{(2)} \times \frac{7}{8}$ , contains 140 basic subdivision vertices and eighty-four 3-cells of  $PP_{3,2}$  ( $P_3^{(2)}$  is pictured in Figure 8).

**8.3. Step 2: Subdividing cells of  $P_{m+n} \setminus \underline{m} | (\underline{n} + m)$ .** Recall that elements of  $Z_{n,m}$  arise from the non-trivial action of  $\mathcal{T}_\sigma$  on  $X_m^{n+1} \times Y_n^{m+1}$ . When  $\sigma$  ranges over all  $(m, n)$ -shuffles (including the identity), we obtain the poset

$$\mathcal{S}_{n,m} = \bigcup_{(m,n)\text{-shuffles } \sigma} \mathcal{T}_\sigma(\mathcal{BS}_{n,m})$$

of *subdivision vertices* of  $\mathcal{PP}_{n,m}$ . Thus as sets,  $\mathcal{PP}_{n,m} = \text{con } \mathcal{PP}_{n,m} \sqcup \mathcal{S}_{n,m}$ .

The second step of our construction detects those cells of  $P_{m+n} \setminus \underline{m} | (\underline{n} + m)$  that contain subdivision vertices. We refer to such cells as Type I cells; all other cells have Type II. We use the poset structure of subdivision vertices to subdivide Type I cells, and having done so, our construction of  $\mathcal{PP}_{n,m}$  will be complete.

To begin, let us characterize those Type I cells of minimal dimension that contain *non-basic* subdivision vertices. If  $e$  is a cell of some polytope, denote the set of vertices of  $e$  by  $\mathcal{V}_e$ . Given an  $(m, n)$ -shuffle  $\sigma$  and a cell  $e \subset \underline{m} | (\underline{n} + m)$ , let  $\mathcal{T}(\sigma, e)$  denote the cell of  $P_{m+n}$  of minimal dimension such that  $\overline{\mathcal{T}_\sigma}(\mathcal{V}_e) \subseteq \mathcal{V}_{\mathcal{T}(\sigma, e)}$ . This defines a map

$$\mathcal{T} : \{(m, n)\text{-shuffles}\} \times \{\text{partitions of } \underline{m} | (\underline{n} + m)\} \rightarrow \{\text{partitions of } \underline{m} + \underline{n}\},$$

which extends the map  $(\sigma, \sigma_m \times \sigma_n) \mapsto \sigma \circ (\sigma_m \times \sigma_n)$  in the proof of Proposition 4. To define  $\mathcal{T}$  at a particular shuffle  $\sigma$  and partition  $e = A_1 | \cdots | A_k | B_1 | \cdots | B_l \subset \underline{m} | (\underline{n} + m)$ , remove all block delimiters of  $e$  and think of  $e$  as a permutation of  $\underline{m} + \underline{n}$  in which  $A_i$  and  $B_j$  are contiguous subsequences. Consider the set  $\{D_1, \dots, D_r\}$  of all contiguous subsequences  $\sigma(A_i)$  and  $\sigma(B_j)$  of  $\sigma(e)$  that preserve the contiguity of the  $B_j$ 's and  $A_i$ 's, respectively, then reinsert block delimiters so that

$$\mathcal{T}(\sigma, e) = C_1 | D_{i_1} | \cdots | C_r | D_{i_r} | C_{r+1}.$$

Since each cell of  $P_{m+n}$  can be expressed uniquely as a component of the combinatorial join  $P_m *_c P_n$ , we have

$$(8.3) \quad \mathcal{T}(\sigma, e) = E *_{(\mathbf{i}; \mathbf{j})} F = E'_1 \cup (F'_1 + m) | \cdots | E'_s \cup (F'_s + m),$$

where  $E_i$  and  $F_j$  are the unions of consecutive blocks  $A_{i'} | \cdots | A_{i'+i''}$  and  $B_{j'} | \cdots | B_{j'+j''}$  of  $e$ , respectively. Thus  $\sigma$  acts on the blocks of  $e$  as a  $(k, l)$ -shuffle if and only if  $C_i = \emptyset$  for all  $i$  if and only if  $\mathcal{T}(\sigma, e) = A_1 | \cdots | A_k *_{(\mathbf{i}; \mathbf{j})} B_1 | \cdots | B_l$  for some  $(k, l)$ -unshuffle  $(\mathbf{i}; \mathbf{j}) = (i_1 < \cdots < i_k; j_1 < \cdots < j_l)$  of  $\underline{k} + \underline{l}$ . Clearly, a cell  $a \subset P_{n+m}$  contains a non-basic subdivision vertex  $\mathcal{T}_\sigma(u)$  if and only if  $a = \mathcal{T}(\sigma, e)$  for some cell  $e \subset \underline{m} | (\underline{n} + m)$  containing a basic subdivision vertex  $u$  on which  $\mathcal{T}_\sigma$  acts non-trivially. In fact,  $a$  contains at most one non-basic subdivision vertex when  $m + n \leq 4$ .

The following proposition incorporates the property of  $\mathcal{T}$  described in Remark 5 and will be applied in our subsequent examination of the poset structure of  $\mathcal{PP}_{n,m}$ .

**Proposition 5.** *If a cell  $e \subset \underline{m} | (\underline{n} + m)$  contains a subdivision cell  $a \subset |X_m^{n+1} \times Y_n^{m+1}|$  and  $\mathcal{T}_\sigma(\mathcal{V}_a) \subset (\mathcal{S}_{n,m} \cap \mathcal{T}(\sigma, e)) \cup \mathcal{V}_{\mathcal{T}(\sigma, e)}$ , then  $|\mathcal{T}_\sigma(\mathcal{V}_a)|$  is a subdivision cell of  $\mathcal{T}(\sigma, e)$  (combinatorially) isomorphic to  $a$ ; in particular, if  $a = a_1 \times a_2$ , then*

$$|\mathcal{T}_\sigma(\mathcal{V}_{a_1 \times a_2})| = |\mathcal{T}_\sigma(\mathcal{V}_{a_1})| \times |\mathcal{T}_\sigma(\mathcal{V}_{a_2})|.$$

*Proof.* Since  $\mathcal{T}_\sigma(u)$  is defined for all  $u \in \mathcal{V}_a$  and  $\mathcal{T}_\sigma$  preserves the poset structure of  $\mathcal{V}_a$ , the cells  $a = |\mathcal{V}_a|$  and  $|\mathcal{T}_\sigma(\mathcal{V}_a)|$  are combinatorially isomorphic.  $\square$

**Example 26.** *The action of  $\mathcal{T}$  on the four vertices of  $12|34$  partitions the 24 vertices of  $P_4$  into four mutually disjoint sets of six vertices each. The vertices  $v_1 = 1|2|3|4$  and  $v_2 = 1|2|4|3$  of edge  $e = 1|2|34$  correspond respectively to*

$$\begin{bmatrix} \lambda \\ \lambda \\ \lambda \\ \lambda \end{bmatrix} \begin{bmatrix} \lambda & \mathbf{1} \\ \lambda & \mathbf{1} \\ \lambda & \mathbf{1} \end{bmatrix} \begin{bmatrix} \gamma & \gamma & \gamma \\ \mathbf{1} & \mathbf{1} & \mathbf{1} \end{bmatrix} [\gamma \gamma \gamma] \quad \text{and} \quad \begin{bmatrix} \lambda \\ \lambda \\ \lambda \end{bmatrix} \begin{bmatrix} \lambda & \mathbf{1} \\ \lambda & \mathbf{1} \\ \lambda & \mathbf{1} \end{bmatrix} \begin{bmatrix} \mathbf{1} & \mathbf{1} & \mathbf{1} \\ \gamma & \gamma & \gamma \end{bmatrix} [\gamma \gamma \gamma].$$

There are two basic subdivision vertices  $u_1$  and  $u_2$  along  $e$ , exactly one of which admits a non-trivial action of  $\mathcal{T}$ , namely,

$$\begin{aligned}
 u_1 &= \begin{bmatrix} \lambda \\ \lambda \\ \lambda \end{bmatrix} \begin{bmatrix} \lambda & \mathbf{1} \\ \lambda & \mathbf{1} \\ \lambda & \mathbf{1} \end{bmatrix} \begin{bmatrix} \Upsilon & \Upsilon & \mathbf{1} \\ \mathbf{1} & \mathbf{1} & \Upsilon \end{bmatrix} [\Upsilon \Upsilon \Upsilon] \\
 \mathcal{T}_{\sigma_1} = \mathcal{T}_{11}^2 &\longrightarrow z_1 = \begin{bmatrix} \lambda \\ \lambda \\ \lambda \end{bmatrix} \begin{bmatrix} \Upsilon & \mathbf{1} \\ \mathbf{1} & \Upsilon \end{bmatrix} \begin{bmatrix} \lambda & \mathbf{1} \\ \lambda & \mathbf{1} \end{bmatrix} [\Upsilon \Upsilon \Upsilon] \\
 \mathcal{T}_{\sigma_2} \searrow &\qquad \qquad \qquad \downarrow \mathcal{T}_{11}^3 \\
 & z_2 = \begin{bmatrix} \lambda \\ \lambda \\ \lambda \end{bmatrix} \begin{bmatrix} \Upsilon & \mathbf{1} \\ \mathbf{1} & \Upsilon \end{bmatrix} [\Upsilon \Upsilon] [\lambda \mathbf{1}].
 \end{aligned}$$

To physically position  $z_1$  and  $z_2$ , first note that  $\mathcal{T}_{\sigma_1}(\mathcal{V}_e) = \{\mathcal{T}_{\sigma_1}(v_1) = 1|3|2|4, \mathcal{T}_{\sigma_1}(v_2) = 1|4|2|3\}$  and  $\mathcal{T}_{\sigma_2}(\mathcal{V}_e) = \{\mathcal{T}_{\sigma_2}(v_1) = 1|3|4|2, \mathcal{T}_{\sigma_2}(v_2) = 1|4|3|2\}$ . Now  $e = A_1|A_2|B_1 = 1|2|34$  and  $\sigma_1(e) = 1324$ ; thus  $\sigma_1(B_1)$  is not contiguous in  $\sigma_1(e)$  and  $\sigma_1(A_2)$  breaks the contiguity of  $B_1$  in  $\sigma_1(e)$ . Thus  $D_1 = \sigma_1(A_1)$  and  $\mathcal{T}(\sigma_1, e) = 1|234$ . On the other hand,  $\sigma_2(e) = 1342$ ; in this case  $\mathcal{T}(\sigma_2, e) = 1|34|2$  since  $\sigma_2$  acts on the blocks of  $e$  as a  $(2, 1)$ -shuffle. Consequently, we represent the vertices  $z_1$  and  $z_2$  as interior points of the faces  $1|234$  and  $1|34|2$ , respectively. To complete the subdivision of  $1|234$ , use the poset structure to construct new edges from  $u_1$  to  $z_1$  and from  $z_1$  to  $z_2$ , and apply Proposition 5 to the subdivision cell  $a = (v_1, u_1) \subset e$  to construct the edge  $|\mathcal{T}_{\sigma_1}(\mathcal{V}_a)|$  from  $1|3|2|4$  to  $z_1$ . Then  $1|234 = d_1 \cup d_2 \cup d_3$  in which  $\mathcal{V}_{d_1} = \{u_1, u_2, v_2, \mathcal{T}_{\sigma_1}(v_2), \mathcal{T}_{\sigma_2}(v_2), z_2, z_1\}$ ,  $\mathcal{V}_{d_2} = \{u_1, v_1, \mathcal{T}_{\sigma_1}(v_1), z_1\}$ , and  $\mathcal{V}_{d_3} = \{\mathcal{T}_{\sigma_1}(v_1), \mathcal{T}_{\sigma_2}(v_1), z_2, z_1\}$  (see Figure 17 and Example 27). An algebraic interpretation of these cells appears in the discussion of  $KK_{3,3}$  following Theorem 1.

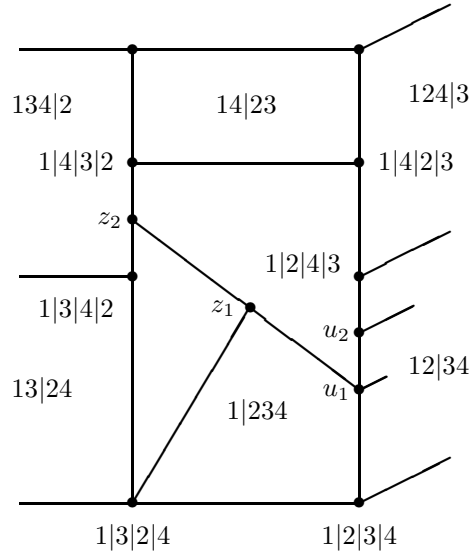

Figure 17. The subdivision of  $1|234$  in  $PP_{3,3}$ .

**8.4.  $PP$ -factorization of proper cells.** Recall that an element of  $\mathcal{PP}_{n,m}$  is assigned to a unique directed piece-wise linear path from  $(m+1, 1)$  to  $(1, n+1)$  in  $\mathbb{N}^2$  with  $m+n$  components of unit length (see Figure 14). Let  $\Pi_{n,m}$  denote the set of all such paths and consider the map  $\pi : \mathcal{PP}_{n,m} \rightarrow \Pi_{n,m}$ . If  $u \in \text{con}(X_m^{n+1} \times Y_n^{m+1})$ , i.e.,  $u$  is a vertex of  $\underline{m} | (\underline{n} + m)$ , then  $\pi$  restricts to a bijection  $\{\mathcal{T}_\sigma(u) \mid (m, n)\text{-shuffles } \sigma\} \leftrightarrow \Pi_{n,m}$ , and in view of Proposition 4,  $\pi$  assigns each vertex of  $P_{m+n}$  to a path in  $\Pi_{n,m}$  albeit non-injectively.

Now consider a proper cell  $c = C_1 | \cdots | C_s \subset |\text{con} \mathcal{PP}_{n,m}| \leftrightarrow P_{m+n}$ . Each factor  $C_t$  is a permutahedron  $P_{m_t+n_t}$  whose vertices are assigned to connected subpaths of paths in  $\Pi_{n,m}$ . Assign  $c$  to a directed piece-wise linear path  $\varepsilon_c = \cup \varepsilon_t$  in the following way: Write  $c = E_1 | \cdots | E_f *_{(i;j)} F_1 | \cdots | F_g$  and obtain sequences

$$(8.4) \quad \gamma = \{m+1 = \gamma_0 > \cdots > \gamma_f = 1\} \quad \text{and} \quad \delta = \{1 = \delta_0 < \cdots < \delta_g = n+1\},$$

where  $\gamma_{i+1} = \gamma_i - \#E_{f-i}$  and  $\delta_{j+1} = \delta_j + \#F_{g-j}$ , and assign  $C_t = E'_t \cup (F'_t + m)$  to the path

- (1)  $\varepsilon_t : (\gamma_{t'-1}, n+1-j) \rightarrow (\gamma_{t'}, n+1-j)$ , if  $C_t = E_{\gamma_{t'}}$  for some  $t'$  and maximal  $j$  such that  $F'_{s_1}, \dots, F'_{s_j} \neq \emptyset$  and  $s_1 < \cdots < s_j < t$ ;
- (2)  $\varepsilon_t : (i, \delta_{t'}) \rightarrow (i, \delta_{t'+1})$ , if  $C_t = F_{\delta_{t'}} + m$  for some  $t'$  and maximal  $i$  such that  $E'_{s_1}, \dots, E'_{s_i} \neq \emptyset$  and  $s_1 < \cdots < s_i < t$ ;
- (3)  $\varepsilon_t : (\gamma_i, \delta_j) \rightarrow (\gamma_{i+1}, \delta_{j+1})$ , if  $C_t = E_{\gamma_i} \cup (F_{\delta_j} + m)$  with  $E_{\gamma_i}, F_{\delta_j} \neq \emptyset$  for some  $i, j$ .

In particular, a cell  $a = A_1 \cdots A_k B_l \cdots B_1 \subset |\text{con}(X_m^{n+1} \times Y_n^{m+1})| \leftrightarrow \underline{m} | (\underline{n} + m)$  is assigned to the path

$$\varepsilon_a : (m+1, \beta_0) \xrightarrow{B_1^1} \cdots \xrightarrow{B_l^1} (m+1, \beta_l) \xrightarrow{A_k^1} (\alpha_1, n+1) \xrightarrow{A_{k-1}^1} \cdots \xrightarrow{A_1^1} (\alpha_k, n+1),$$

where  $\alpha = \{m+1 = \alpha_0 > \cdots > \alpha_k = 1\}$  and  $\beta = \{1 = \beta_0 < \cdots < \beta_l = n+1\}$  (case (3) does not occur). Thus if  $c = \mathcal{T}(\sigma, a)$ , the observation in (8.3) implies that  $\gamma \subseteq \alpha$  and  $\delta \subseteq \beta$ .

Given a subdivision cell  $d \subseteq \mathcal{T}(\sigma, a)$ , there is a subdivision subcomplex  $u \subset a$  such that  $d = |\mathcal{T}_\sigma(\mathcal{V}_u)|$ . Representing  $a$  as a partition  $U_1 | \cdots | U_s$  of  $\underline{m} | (\underline{n} + m)$ , there is a Cartesian product decomposition  $d = D_1 \times \cdots \times D_s$  in which  $D_t$  is a subdivision cell of  $U_t$ . The representation  $U_1 | \cdots | U_s = E *_{(i;j)} F$  relates the paths associated with the vertices of  $U_t$  to the vertices of  $D_t$ , and in view of case (3) above, the vertices of  $D_t$  are assigned to paths related to those  $z \in \mathcal{T}_\sigma(\mathcal{V}_u)$  given by the action of  $\mathcal{T}_\sigma$  on the matrix sequences  $x_{\gamma_{i+1}} \cdots x_{\gamma_i-1} y_{\delta_{j+1}-1} \cdots y_{\delta_j}$  associated with the vertices of  $u$  as a  $(\gamma_i - \gamma_{i+1}, \delta_{j+1} - \delta_j)$ -shuffle. But in every case, there is the Cartesian product decomposition

$$D_t = (e_{y_1^t, x_1^t} \times \cdots \times e_{y_1^t, x_{p_t}^t}) \times \cdots \times (e_{y_{q_t}^t, x_1^t} \times \cdots \times e_{y_{q_t}^t, x_{p_t}^t}),$$

where  $e_{y_j^t, x_i^t}$  is some cell of  $PP_{y_j^t, x_i^t}$  and  $(p_t, q_t) \in \{(\gamma_{t'}, n+1-j), (i, \delta_{t'}), (\gamma_{i+1}, \delta_j)\}$ ,  $p_1 + \cdots + p_t \in \{\gamma_{t'-1}, i, \gamma_i\}$ , and  $q_1 + \cdots + q_t \in \{n+1-j, \delta_{t'+1}, \delta_{j+1}\}$  (Cartesian product decomposition of  $D_t$  is trivial whenever  $m=1$  or  $n=1$ ). Therefore every proper cell  $e_{n,m} \subset PP_{n,m}$  has a *Cartesian matrix factorization*

$$(8.5) \quad e_{n,m} = [(e_{y_1^1, x_1^1} \times \cdots \times e_{y_1^1, x_{p_k}^1}) \times \cdots \times (e_{y_{q_k}^1, x_1^1} \times \cdots \times e_{y_{q_k}^1, x_{p_k}^1})] \times \cdots \\ \times [(e_{y_1^s, x_1^s} \times \cdots \times e_{y_1^s, x_{p_k}^s}) \times \cdots \times (e_{y_{q_k}^s, x_1^s} \times \cdots \times e_{y_{q_k}^s, x_{p_k}^s})],$$

where  $p_1 = q_s = 1$  and  $s \geq 2$ . The decomposition in (8.5) is a *PP-factorization* if each factor  $e_{y_j^k, x_i^k}$  lies in the family *PP*.

Indeed, each factor  $e_{y_j^k, x_i^k}$  of  $e_{n,m}$  has a Cartesian matrix factorization with  $x_i^k + y_j^k < m + n$ , and we may inductively apply the decomposition in (8.5) to obtain a decomposition of  $e_{n,m}$  as a Cartesian product of polytopes in the family  $PP$ . This decomposition involves Cartesian products in two settings: Those within bracketed quantities correspond to tensor products of entries in a bisequence monomial (controlled by  $\Delta_P^{(k)}$ ) and those between bracketed quantities correspond to  $\Upsilon$ -products of bisequence monomials. And indeed, this decomposition is encoded by a leveled tree  $\Psi(e_{n,m})$  constructed in the same way we constructed  $\Psi(\phi(\xi))$  for  $\xi \in \mathcal{G}$ . Whereas the levels and the leaves of  $\Psi(\phi(\xi))$  are bisequence and  $\Theta$ -factorizations, the levels and leaves of  $\Psi(e_{n,m})$  are Cartesian matrix and  $PP$ -factorizations.

**Example 27.** Refer to Example 26 and consider the codimension 1 cell  $c = C_1|C_2 = 1|234 \subset P_{2+2}$ . Write  $c = E_1|E_2 * F_1 = 1|2 * 12$  and obtain  $\gamma_0 = 3$ ,  $\gamma_1 = 2$ ,  $\gamma_2 = 1$ ; and  $\delta_0 = 1$ ,  $\delta_1 = 3$ . Then  $C_1 = E'_1 \cup F'_1 = E_1 \cup \emptyset$  and  $C_2 = E'_2 \cup (F'_2 + 2) = E_2 \cup (F_1 + 2)$ . The path  $C_1$  is assigned to the path component  $\varepsilon_1 : (2, 3) \rightarrow (1, 3)$  and  $C_2$  is assigned to  $\varepsilon_2 : (3, 1) \rightarrow (2, 3)$ ; in this case there is the action of a  $(\gamma_0 - \gamma_1, \delta_1 - \delta_0) = (1, 2)$ -shuffle on  $x_{\gamma_0-1}y_{\delta_1-1}y_{\delta_0} = x_2y_2y_1$ , which generates (classes of) vertices of  $C_2$ . Let  $u$  be the subdivision subcomplex of  $1|2|34$  consisting of the two edges  $(u_1, u_2)$  and  $(u_2, v_2)$  (see Figure 17). Then for  $i = 1, 2, 3$ , the subdivision cell  $d_i = D_1^i \times D_2^i$ , where  $D_1^i = C_1 = P_1$  is a vertex and  $D_2^i \subset C_2$  has the form  $D_2^i = e_{3,2}^i \times e_{3,1}^i$ , where  $(\dim e_{3,2}^i, \dim e_{3,1}^i) = (2, 0)$  and  $(\dim e_{3,2}^i, \dim e_{3,1}^i) = (1, 1)$  ( $e_{3,2}^1 = PP_{2,1}$  is a heptagon and  $e_{3,1}^1$  is a vertex of  $PP_{2,0}$ ;  $e_{3,2}^i$  is an edge of  $PP_{2,1}$  and  $e_{3,1}^i = PP_{2,0}$  for  $i = 2, 3$ ). Thus up to homeomorphism we have

$$\begin{aligned} d_1 &= [PP_{0,1} \times PP_{0,1} \times PP_{0,1}] \times [PP_{2,1} \times (PP_{1,0} \times PP_{1,0})] \\ d_2 &= [PP_{0,1} \times PP_{0,1} \times PP_{0,1}] \times [(PP_{1,1} \times PP_{1,0}) \times PP_{2,0}] \\ d_3 &= [PP_{0,1} \times PP_{0,1} \times PP_{0,1}] \times [(PP_{1,0} \times PP_{1,1}) \times PP_{2,0}]. \end{aligned}$$

**8.5. The projection  $\vartheta\vartheta : PP \rightarrow KK$ .** The final piece of our construction establishes a geometric interpretation of the projection  $\vartheta\vartheta : PP_{m,n} \rightarrow KK_{n+1,m+1}$  induced by the quotient map  $\mathcal{P}P_{n,m} \rightarrow \mathcal{K}K_{n+1,m+1}$ . Let  $\mathcal{P}_{n,m} = \text{con}\mathcal{P}P_{n,m}$ ,  $P_{n,m} = |\mathcal{P}_{n,m}|$ , and  $K_{n+1,m+1} = |\mathcal{K}_{n,m}/\sim|$ ; we obtain  $KK_{n+1,m+1}$  as the subdivision of  $K_{n+1,m+1}$  that commutes the following diagram:

$$\begin{array}{ccc} PP_{n,m} & \xrightarrow{\approx} & P_{m+n} \\ \vartheta\vartheta \downarrow & & \downarrow \vartheta \\ KK_{n+1,m+1} & \xrightarrow[\approx]{} & K_{n+1,m+1} \end{array}$$

(the horizontal maps are non-cellular homeomorphisms induced by the subdivision process). We identify the cellular chains  $C_*(KK)$  with the free matrad  $\mathcal{H}_\infty$  and prove that the restriction of the free resolution of prematrads  $\rho^{\text{pre}} : F^{\text{pre}}(\Theta) \rightarrow \mathcal{H}$  to  $\mathcal{H}_\infty$  is a free resolution in the category of matrads.

To simplify notation, we suppress the subscripts of  $\vartheta_{n,m} : P_{n,m} \rightarrow K_{n+1,m+1}$  when  $m$  and  $n$  are clear from context. Since  $|\mathcal{P}_{n,m}| = P_{n,m} = P_{m+n}$ , a proper face  $e \subset P_{n,m}$  is a product of permutahedra

$$e = P_{n_1, m_1} \times \cdots \times P_{n_s, m_s}$$

and projects to a product

$$\tilde{e} = \vartheta(e) = \vartheta(P_{n_1, m_1}) \times \cdots \times \vartheta(P_{n_s, m_s}) = K_{n_1+1, m_1+1} \times \cdots \times K_{n_s+1, m_s+1}.$$

The fact that  $\vartheta_{n,m} = Id$  when  $1 \leq m, n \leq 2$  implies  $K_{n+1, m+1} = P_{m+n}$ ; also,  $K_{n,2} \cong K_{2,n}$  is the multiplihedron  $J_n$  for all  $n$  (see [17], [4], [12], [14]). The faces  $24|13$  and  $1|24|3$  of  $P_{3,1}$  are degenerate in  $K_{4,2}$  since  $\vartheta_{3,1}(24|13) = 24|1|3$  and  $\vartheta_{3,1}(1|24|3) = 1|2|4|3$ ; and dually, the faces  $24|13$  and  $2|13|4$  of  $P_{1,3}$  are degenerate in  $KK_{2,4}$  since  $\vartheta_{1,3}(24|13) = 2|4|13$  and  $\vartheta_{1,3}(2|13|4) = 2|1|3|4$ . Observe that the product cell  $K_{m+1} \times K_{n+1} = \vartheta(P_m \times P_n) \subset \vartheta(P_{m+n}) = \vartheta(P_{n,m}) = K_{n+1, m+1}$  admits the  $(m, n)$ -subdivision  $K_{m+1}^{(n)} \times K_{n+1}^{(m)} = \vartheta\vartheta(P_m^{(n)} \times P_n^{(m)}) \subset \vartheta\vartheta(P_{n,m}) = KK_{n+1, m+1}$ .

**Example 28.** The  $(2, 2)$ -subdivision  $K_3^{(2)} \times K_3^{(2)}$  of the face  $\vartheta_{2,2}(12|34) = K_3 \times K_3 \subset K_{3,3}$  produces 9 cells of  $KK_{3,3}$  (see Figures 15 and 21); the  $(3, 1)$ -subdivision  $K_2^{(3)} \times K_4^{(1)}$  of the face  $\vartheta_{1,3}(1|234) = K_2 \times K_4 \subset K_{4,2}$  produces 6 cells of  $KK_{4,2}$  (see Figures 7 and 22).

Define

$$\widetilde{\mathcal{BS}}_{n+1, m+1} = (\vartheta_* \times \vartheta_*)(\mathcal{BS}_{n,m}).$$

**Example 29.** The matrahedron  $KK_{3,3} = PP_{2,2}$  and has 44 vertices, 16 of which lie in  $12|34$ . Of these 16 vertices, 4 lie in  $\mathcal{P}_{2,2}$  and generate the other 20 vertices of  $K_{3,3} = P_4$ ; another 4 lie  $\widetilde{\mathcal{BS}}_{3,3}$  and generate the 8 remaining vertices of  $KK_{3,3}$  (see Figure 21). By contrast,  $KK_{4,2}$  is a non-trivial quotient of  $PP_{3,1}$ . As in Tonks' projection  $\vartheta_0 : P_n \rightarrow K_{n+1}$ , we identify faces of  $PP_{3,1}$  indexed by isomorphic graphs (forgetting levels) as pictured in Figure 18. Here an equivalence class of graphs, which labels a face of the target interval, contains the three graphs horizontal to its left.

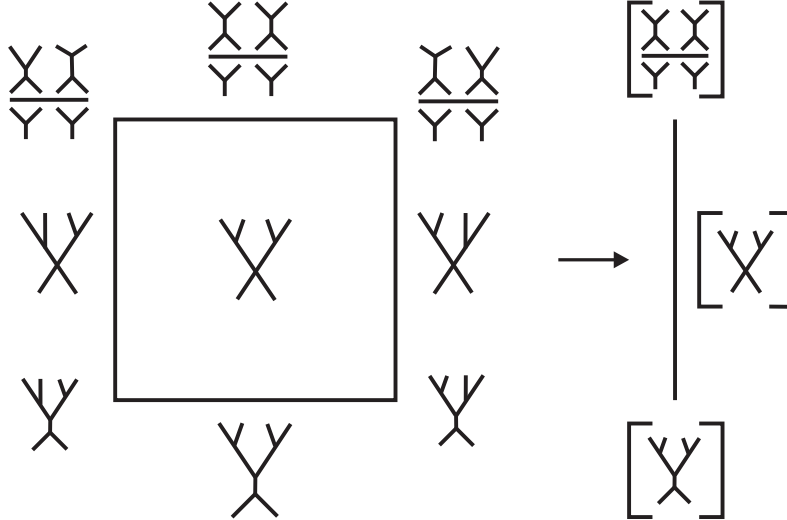

Figure 18: Projection of a degenerate square in  $PP_{3,1}$  to  $KK_{4,2}$ .

The matrahedra  $KK_{1,1}$ ,  $KK_{2,1}$  and  $KK_{1,2}$  are isolated vertices and correspond to the free matrad generators  $\mathbf{1}$ ,  $\theta_1^2$  and  $\theta_2^1$ , respectively. The matrahedra  $KK_{n,m}$  with  $4 \leq m+n \leq 6$  are pictured in Figures 19 through 23 below and labelled by



partitions and (co)derivation leaf sequences. Note that  $KK_{n,m} \cong KK_{m,n}$  for all  $m, n \geq 1$  and  $KK_{2,m}$  is a subdivision of  $J_m$  when  $m \geq 3$ .

If  $\tilde{e}_{n,m}$  is a proper face of  $KK_{n,m}$ , the decomposition in (8.5) induces a product decomposition of the form

$$(8.6) \quad \tilde{e}_{n,m} = [(\tilde{e}_{y_1^1, x_1^1} \times \cdots \times \tilde{e}_{y_{p_k}^1, x_{p_k}^1}) \times \cdots \times (\tilde{e}_{y_{q_k}^1, x_1^1} \times \cdots \times \tilde{e}_{y_{q_k}^1, x_{p_k}^1})] \\ \times \cdots \times [(\tilde{e}_{y_1^s, x_1^s} \times \cdots \times \tilde{e}_{y_{p_k}^s, x_{p_k}^s}) \times \cdots \times (\tilde{e}_{y_{q_k}^s, x_1^s} \times \cdots \times \tilde{e}_{y_{q_k}^s, x_{p_k}^s})],$$

where  $p_1 = q_s = 1$  and  $s \geq 2$ . Here “ $\times$ ” within a bracketed quantity corresponds to the tensor product in a bisequence monomial (controlled by certain iterations of  $\Delta_P$  and the product cell within  $k^{\text{th}}$  bracket is thought of as a subdivision cell of  $K_{n_k+1, m_k+1}$  in the decomposition of  $e_{n,m}$  in (8.5)) and “ $\times$ ” between bracketed quantities corresponds to a  $\Upsilon$ -product, and each  $\tilde{e}_{y_j^k, x_i^k}$  has the form given by (8.6) with  $x_i^k + y_j^k < m + n$ .

We distinguish between two kinds of faces in (8.6). A Type I face is detected by the diagonal  $\Delta_P$  and its representation in (8.6) has  $(p_k, q_k) > (1, 1)$  for all  $k$ ; thus  $\Delta_P$  is only involved in forming the Cartesian products in parentheses. A Type II face  $\tilde{e}_{n,m}$  is independent of  $\Delta_P$  and its representation in (8.6) satisfies  $(p_k, q_k) = (1, 1)$  for all  $k$ ; thus  $\tilde{e}_{n,m}$  has the form  $KK_{n, i_2} \times K_{i_2 - i_1 + 1} \times \cdots \times K_{i_s - i_{s-1} + 1}$ ,  $1 \leq i_2 < \cdots < i_s = m$ , or  $K_{j_0 - j_1 + 1} \times \cdots \times K_{j_{s-2} - j_{s-1} + 1} \times KK_{j_{s-1}, m}$ ,  $1 \leq j_{s-1} < \cdots < j_0 = n$ . In particular, a codimension 1 face (when  $s = 2$ ) has the form  $KK_{n, i} \times K_{m+1-i}$  or  $K_{n+1-j} \times KK_{j, m}$ . Consequently, each cell  $\tilde{e}_{n,m} \subset KK_{n,m}$  is associated with a levelled tree  $\Psi(\tilde{e}_{n,m})$ , whose levels are representations given by (8.6) and whose leaves are  $KK$ -factorizations.

The assignment  $\iota : \theta_p^q \mapsto KK_{q,p}$ , which preserves levels, induces a set map

$$(8.7) \quad \iota : \mathcal{G}_{n,m} \rightarrow \{\text{faces of } KK_{n,m}\}$$

that sends balanced factorizations to Cartesian matrix factorizations and has the following properties:

- (i) The restriction of  $\iota$  to 0-dimensional module generators of  $F_{n,m}(\Theta)$  establishes a bijection with vertices of  $KK_{n,m}$  by replacing  $\theta_2^1$  with  $\wedge$  and  $\theta_1^2$  with  $\Upsilon$  in each entry of  $\Psi(\beta)$ .
- (ii) There is a *location map*

$$(8.8) \quad \tilde{\iota} : \mathcal{G}_{q+1, p+1} \rightarrow \{\text{faces of } P_{p+q}\}$$

that commutes the following diagram of set maps

$$\begin{array}{ccc} \mathcal{G}_{q+1, p+1} & \xrightarrow{\tilde{\iota}} & \{\text{faces of } P_{p+q}\} \\ \iota \downarrow & & \downarrow \vartheta_{q,p} \\ \{\text{faces of } KK_{q+1, p+1}\} & \xrightarrow{\nu} & \{\text{faces of } K_{q+1, p+1}\}, \end{array}$$

where  $\nu$  sends a cell of  $KK$  to the cell of  $K$  of minimal dimension containing it. Indeed, if  $\beta = A_s \cdots A_1 \in \mathcal{B}$  is balanced representative of  $\theta$  with  $A_k \in \mathbf{G}_{\mathbf{x}^k}^{\mathbf{y}^k}$ , consider the (co)derivation leaf sequences  $((\mathbf{x}^1, \mathbf{y}^1), \dots, (\mathbf{x}^s, \mathbf{y}^s))$ , and let  $\mathbf{x}^{i_1}, \dots, \mathbf{x}^{i_k}$  and  $\mathbf{y}^{j_1}, \dots, \mathbf{y}^{j_l}$  be the subsequences obtained by removing all  $\mathbf{x}^i, \mathbf{y}^j = \mathbf{1}$ . Thinking of these subsequences as ascent and descent sequences, consider the corresponding faces  $A = A_1 | \cdots | A_k \subset P_{m-1}$  and  $B = B_1 | \cdots | B_l \subset P_{n-1}$  and set

$$e_\theta = \chi(A) *_{(i,j)} B \subset P_{m+n-2},$$

where  $\chi$  is the cellular involution defined in (6.2) and  $(\mathbf{i}, \mathbf{j}) = (i_1 < \cdots < i_k; j_1 < \cdots < j_l)$ . Then  $e_\theta$  is the unique cell of minimal dimension  $\geq k$  such that  $\iota(\theta) \subset \vartheta_{n-1, m-1}(e_\theta)$ ; in particular, when  $s = 2$ ,  $\mathbf{x}^1 = \mathbf{x}$  and  $\mathbf{y}^2 = \mathbf{y}$ , and we recover the special cell  $e_\theta = e_{(\mathbf{y}, \mathbf{x})}$  defined in (6.3). Thus, the term ‘‘location map’’ suggests the fact that  $\tilde{\iota}$  points out the position of the image cells  $\iota(\theta)$  with respect to cells of the permutahedron  $P_{m+n}$ . Under  $\tilde{\iota}$ , the associativity of the  $\Upsilon$ -product on  $\mathcal{G}$  is compatible with the associativity of the partitioning procedure in  $p+q$  by which  $a_1 | \cdots | a_k$  is obtained from the (ordered) set  $a_1 \cdots a_k$  by inserting bars: Given  $\theta, \zeta \in \mathcal{G}$ , let  $\xi \in \mathcal{G}$  be the component shared by  $\partial(\theta)$  and  $\partial(\zeta)$  in  $\mathcal{H}_\infty$ . Then  $\vartheta(\tilde{\iota}(\xi)) \subset \vartheta(\tilde{\iota}(\theta)) \cap \vartheta(\tilde{\iota}(\zeta))$  in  $K_{q+1, p+1} = \vartheta(P_{p+q})$  (see Example 30).

- (iii) Let  $\dim \theta = k$  and let  $\sigma_\theta$  be the set of all 0-dimensional elements of  $\mathcal{H}_\infty$  obtained by all possible compositions  $\partial_{i_k} \cdots \partial_{i_1}(\theta)$  where  $\partial_i$  is a component of  $\partial = \sum_i \partial_i$ . Then  $\iota(\theta)$  is the  $k$ -face of  $KK_{n, m}$  spanned on the set  $\iota(\sigma_\theta)$ .
- (iv) If  $(m, n) \in \{(2, 0), (1, 1), (0, 2)\}$  in item (ii) and  $k = 1$  in item (iii), then  $KK_{n+1, m+1} = K_{n+1, m+1} = P_{m+n}$  is an interval and (ii) agrees with (iii) under the equality  $\iota = \tilde{\iota}|_{\mathcal{G}_{n+1, m+1}}$  for  $m+n \leq 2$ .

**Remark 7.** *Since  $\tilde{\iota}$  is not surjective, the action of the (pre)matrad axioms on Type II generators forces us to obtain  $KK_{n+1, m+1}$  as a quotient of  $PP_{n, m}$  modulo combinatorial relations in  $PP_{n, m}$  as indicated in Figure 17 above, and thereby extend the equality  $K_{n+1} = P_n / \sim$  induced by Tonks’ projection (see Theorem 1 below).*

**Example 30.** *The action of the map  $\theta \rightarrow \tilde{\iota}(\theta)$  involving associativity is illustrated by the example in (5.4):*

$$((221), (31)) \rightarrow 146|2357 \quad \text{and} \quad ((41), (211)) \rightarrow 12456|37$$

while

$$(((221), (2)), ((21), (21)), ((2), (211))) \rightarrow 146|25|37$$

(on left-hand sides only (co)derivation leaf sequences of underlying matrad module generator are shown). Also, from Example 14 we have

$$C_3 C_2 C_1 \xrightarrow{\tilde{\iota}} 357|14|26.$$

The properties above imply that  $\iota$  is a bijection so that  $\mathcal{C}_{n, m}$  indexes the faces of  $KK_{n, m}$ . Let  $e^{m+n-3}$  denote the top dimensional cell of  $KK_{n, m}$  and define the boundary map in the cellular chain complex  $C_*(KK_{n, m})$  by

$$(8.9) \quad \partial(e^{m+n-3}) = \sum_{(\alpha, \beta) \in \mathcal{AB}_{m, n}} (-1)^{\epsilon + \epsilon_\alpha + \epsilon_\beta} e_{\alpha, \beta},$$

where  $\epsilon$  is the sign of the cell  $e_{(\mathbf{y}, \mathbf{x})} \subset P_{n-1, m-1}$  defined by (6.3). This sign reflects the fact that the sign of a subdivision cell in the boundary inherits (as a component) the sign of the boundary. Therefore, we immediately obtain:

**Theorem 1.** *For each  $m, n \geq 1$ , there is a canonical isomorphism of chain complexes*

$$(8.10) \quad \iota_* : (\mathcal{H}_\infty)_{n, m} \xrightarrow{\cong} C_*(KK_{n, m})$$

extending the standard isomorphisms

$$\mathcal{A}_\infty(n) = (\mathcal{H}_\infty)_{n, 1} \xrightarrow{\cong} C_*(KK_{n, 1}) = C_*(K_n)$$

and

$$\mathcal{A}_\infty(m) = (\mathcal{H}_\infty)_{1,m} \xrightarrow{\cong} C_*(KK_{1,m}) = C_*(K_m).$$

In other words, the cellular chains of the matrahedra  $KK$  realize the free matrad resolution  $\mathcal{H}_\infty$  of the bialgebra matrad  $\mathcal{H}$ . In particular, consider the submodule  $\tilde{\mathcal{H}}_\infty \subset \mathcal{H}_\infty$  spanned on the generating set  $\tilde{\Theta}$  fixed by summing of all (distinct) elements of  $\mathcal{G}$  in  $\mathcal{H}_\infty$  that have the same leaf sequence form. Then (8.8) induces an isomorphism

$$(8.11) \quad (\vartheta \circ \tilde{\iota})_* : (\tilde{\mathcal{H}}_\infty)_{n,m} \xrightarrow{\cong} C_*(K_{n,m})$$

by  $(\vartheta \circ \tilde{\iota})_*(\tilde{\theta}) = \vartheta(\tilde{\iota}(\theta_s))$ , where  $\theta_s \in \mathcal{G}_{n,m}$  is any summand component of  $\tilde{\theta} \in \tilde{\Theta}$ , and the following diagram commutes:

$$\begin{array}{ccc} (\tilde{\mathcal{H}}_\infty)_{n,m} & \longrightarrow & (\mathcal{H}_\infty)_{n,m} \\ (\vartheta \circ \tilde{\iota})_* \downarrow \cong & & \cong \downarrow \iota_* \\ C_*(K_{n,m}) & \xrightarrow{\nu^\#} & C_*(KK_{n,m}). \end{array}$$

**Example 31.** We have  $\tilde{\iota}((111), (21)) = 1|234 \subset P_4$ , and apply Example 27 for which bijection (8.10) implies

$$\begin{bmatrix} \lambda \\ \lambda \\ \lambda \end{bmatrix} \left[ \theta_2^3 \begin{bmatrix} \mathbf{1} \\ \gamma \end{bmatrix} \gamma \right] \leftrightarrow d_1$$

$$\begin{bmatrix} \lambda \\ \lambda \\ \lambda \end{bmatrix} \left[ \begin{bmatrix} \theta_2^2 \\ \lambda \end{bmatrix} [\gamma\gamma] \theta_1^3 \right] \leftrightarrow d_2$$

$$\begin{bmatrix} \lambda \\ \lambda \\ \lambda \end{bmatrix} \left[ \begin{bmatrix} \gamma \\ \mathbf{1} \end{bmatrix} \theta_2^2 \theta_1^3 \right] \leftrightarrow d_3.$$

The edge  $(1|3|2|4, z_1)$  in Figure 17 is the intersection  $d_2 \cap d_3$  corresponding to

$$(8.12) \quad A_2 A_1 = \begin{bmatrix} \lambda \\ \lambda \\ \lambda \end{bmatrix} \left[ \left( \begin{bmatrix} \gamma \\ \mathbf{1} \end{bmatrix} \begin{bmatrix} \lambda \\ \lambda \end{bmatrix} [\gamma\gamma] \right) \theta_1^3 \right] \in \mathcal{B}_{3,3}.$$

The following proposition applies Proposition 2 to reformulate Theorem 1 in terms of the  $\odot$ -operation defined in (6.4) for  $(M, \gamma) = (F^{\text{pre}}(\Theta), \gamma)$ .

**Proposition 6.** Let  $(F^{\text{pre}}(\Theta), \gamma)$  be the free prematrad and  $(\mathcal{H}_\infty, \partial)$  be the  $A_\infty$ -matrad. If  $\xi = [(\theta \setminus \theta_m^n) \odot (\theta \setminus \theta_m^n)]_m^n$  with  $mn \geq 3$ , the components of  $\xi$  fit the boundary of  $KK_{n,m}$  and  $\partial(\xi) = 0$ .

Thus, an  $A_\infty$ -bialgebra structure on a DGM  $H$  is defined by a morphism of matrads  $\mathcal{H}_\infty \rightarrow U_H$  (compare [13]).

In our forthcoming paper [14], we construct the theory of relative matrads and use it to define a morphism of  $A_\infty$ -bialgebras. Using *relative  $A_\infty$ -matrads*, we prove that over a field, the homology of every biassociative DG bialgebra admits a canonical  $A_\infty$ -bialgebra structure.

For  $KK_{2,2}$ :

$$\begin{aligned} 1|2 &\leftrightarrow \frac{11}{11} = \gamma(\theta_2^1 \theta_2^1; \theta_1^2 \theta_1^2) \\ 2|1 &\leftrightarrow \frac{2}{2} = \gamma(\theta_1^2; \theta_2^1) \end{aligned}$$

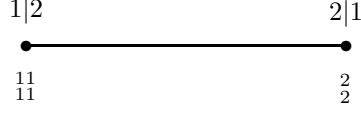

Figure 19. The matrahedron  $KK_{2,2}$  (an interval)

For  $KK_{3,2}$ :

$$\begin{aligned} 1|23 &\leftrightarrow \frac{111}{11} = \gamma(\theta_2^1 \theta_2^1 \theta_2^1; \gamma(\theta_1^2 \theta_1^1; \theta_1^2) \theta_1^3 + \theta_1^3 \gamma(\theta_1^1 \theta_1^2; \theta_1^2)) \\ 13|2 &\leftrightarrow \frac{12}{11} = \gamma(\theta_2^1 \theta_2^2; \theta_1^2 \theta_1^2) \\ 3|12 &\leftrightarrow \frac{12}{2} = \gamma(\theta_1^1 \theta_2^2; \theta_2^2) \\ 12|3 &\leftrightarrow \frac{21}{11} = \gamma(\theta_2^2 \theta_2^1; \theta_1^2 \theta_1^2) \\ 2|13 &\leftrightarrow \frac{2^1}{2} = \gamma(\theta_1^2 \theta_1^1; \theta_2^2) \\ 23|1 &\leftrightarrow \frac{3}{2} = \gamma(\theta_3^1; \theta_2^1) \end{aligned}$$

For  $KK_{2,3}$ :

$$\begin{aligned} 1|23 &\leftrightarrow \frac{11}{21} = \gamma(\theta_3^1 \theta_2^1; \theta_2^2 \theta_1^2) \\ 13|2 &\leftrightarrow \frac{2}{21} = \gamma(\theta_2^2; \theta_2^1 \theta_1^1) \\ 3|12 &\leftrightarrow \frac{3}{2} = \gamma(\theta_1^2; \theta_3^1) \\ 12|3 &\leftrightarrow \frac{11}{111} = \gamma(\gamma(\theta_2^1; \theta_2^1 \theta_1^1) \theta_3^1 + \theta_3^1 \gamma(\theta_2^1; \theta_1^1 \theta_2^1); \theta_1^2 \theta_1^2 \theta_1^2) \\ 2|13 &\leftrightarrow \frac{11}{12} = \gamma(\theta_3^1 \theta_2^1; \theta_1^2 \theta_2^2) \\ 23|1 &\leftrightarrow \frac{2}{12} = \gamma(\theta_2^2; \theta_1^1 \theta_2^1) \end{aligned}$$

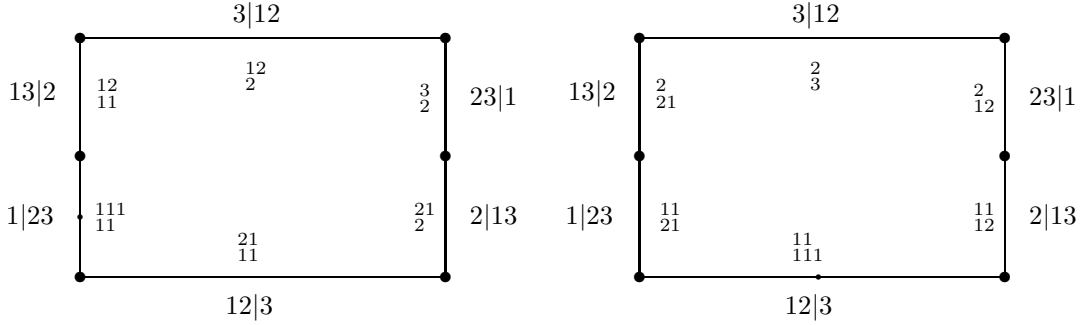

Figure 20. The matrahedra  $KK_{3,2}$  and  $KK_{2,3}$  (heptagons)

For  $KK_{3,3}$ :

$$\begin{aligned}
 1|234 &\leftrightarrow \frac{111}{21} = \gamma(\theta_2^1 \theta_2^1 \theta_2^1; \theta_2^3 \gamma(\theta_1^1 \theta_1^2; \theta_1^2) + a + b), \text{ where} \\
 &\quad a + b = \gamma(\theta_2^2 \theta_2^1; \theta_1^2 \theta_1^2) \theta_1^3 + \gamma(\theta_1^2 \theta_1^1; \theta_2^2) \theta_1^3 \\
 123|4 &\leftrightarrow \frac{21}{111} = \gamma(c + d + \theta_3^2 \gamma(\theta_2^1; \theta_1^1 \theta_2^1); \theta_1^2 \theta_1^2 \theta_1^2), \text{ where} \\
 &\quad c + d = \gamma(\theta_2^1 \theta_2^1; \theta_2^2 \theta_1^2) \theta_1^1 + \gamma(\theta_2^2; \theta_2^1 \theta_1^1) \theta_1^3 \\
 2|134 &\leftrightarrow \frac{111}{12} = \gamma(\theta_2^1 \theta_2^1 \theta_2^1; \gamma(\theta_1^2 \theta_1^1; \theta_1^2) \theta_3^3 + e + f), \text{ where} \\
 &\quad e + f = \theta_1^3 \gamma(\theta_2^2 \theta_2^2; \theta_1^2 \theta_1^2) + \theta_1^3 \gamma(\theta_1^1 \theta_1^2; \theta_2^2) \\
 124|3 &\leftrightarrow \frac{12}{111} = \gamma(g + h + \gamma(\theta_2^1; \theta_2^1 \theta_1^1) \theta_3^2; \theta_1^2 \theta_1^2 \theta_1^2), \text{ where} \\
 &\quad g + h = \theta_3^1 \gamma(\theta_2^1 \theta_2^1; \theta_1^2 \theta_2^2) + \theta_3^1 \gamma(\theta_2^2; \theta_1^1 \theta_2^1) \\
 134|2 &\leftrightarrow \frac{3}{21} = \gamma(\theta_2^3; \theta_2^1 \theta_1^1) \\
 234|1 &\leftrightarrow \frac{3}{12} = \gamma(\theta_2^3; \theta_1^1 \theta_2^1) \\
 3|124 &\leftrightarrow \frac{21}{3} = \gamma(\theta_1^2 \theta_1^1; \theta_2^3) \\
 4|123 &\leftrightarrow \frac{12}{3} = \gamma(\theta_1^1 \theta_1^2; \theta_2^3) \\
 13|24 &\leftrightarrow \frac{21}{21} = \gamma(\theta_2^2 \theta_2^1; \theta_2^2 \theta_1^2) \\
 24|13 &\leftrightarrow \frac{12}{12} = \gamma(\theta_2^1 \theta_2^2; \theta_2^1 \theta_2^2) \\
 14|23 &\leftrightarrow \frac{12}{21} = \gamma(\theta_2^1 \theta_2^2; \theta_2^2 \theta_1^2) \\
 23|14 &\leftrightarrow \frac{21}{12} = \gamma(\theta_2^3 \theta_2^1; \theta_2^2 \theta_2^2) \\
 34|12 &\leftrightarrow \frac{3}{3} = \gamma(\theta_1^3; \theta_3^1) \\
 12|34 &\leftrightarrow \frac{111}{111} = \gamma[\theta_3^1 \gamma(\theta_2^1; \theta_1^1 \theta_2^1) \gamma(\theta_2^1; \theta_1^1 \theta_2^1) + \gamma(\theta_2^1; \theta_2^1 \theta_1^1) \theta_3^1 \gamma(\theta_2^1; \theta_1^1 \theta_2^1) \\
 &\quad + \gamma(\theta_2^1; \theta_2^1 \theta_1^1) \gamma(\theta_2^1; \theta_2^1 \theta_1^1) \theta_3^1; \\
 &\quad \theta_1^3 \gamma(\theta_1^1 \theta_1^2; \theta_1^2) \gamma(\theta_1^1 \theta_1^2; \theta_1^2) + \gamma(\theta_1^2 \theta_1^1; \theta_2^2) \theta_1^3 \gamma(\theta_1^1 \theta_1^2; \theta_1^2) + \\
 &\quad + \gamma(\theta_1^2 \theta_1^1; \theta_2^2) \gamma(\theta_1^1 \theta_1^2; \theta_1^2) \theta_1^3]
 \end{aligned}$$

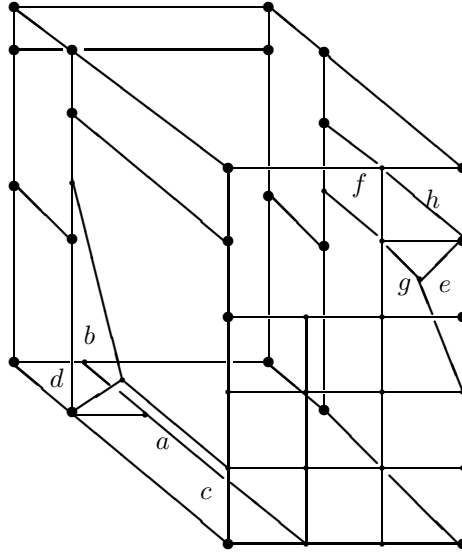

Figure 21. The matrahedron  $KK_{3,3}$  (a subdivision of  $P_4$ ).

For  $KK_{4,2}$ :

$$\begin{aligned}
123|4 &\leftrightarrow \frac{31}{11} = \gamma(\theta_2^3\theta_2^1; \theta_1^2\theta_1^2) \\
2|134 &\leftrightarrow \frac{2^{11}}{2} = \gamma(\theta_1^2\theta_1^1\theta_1^1; \theta_2^3) \\
124|3 &\leftrightarrow \frac{22}{11} = \gamma(\theta_2^2\theta_2^2; \theta_1^2\theta_1^2) \\
134|2 &\leftrightarrow \frac{13}{11} = \gamma(\theta_2^1\theta_2^3; \theta_1^2\theta_1^2) \\
234|1 &\leftrightarrow \frac{4}{2} = \gamma(\theta_1^4; \theta_2^1) \\
3|124 &\leftrightarrow \frac{121}{2} = \gamma(\theta_1^1\theta_1^2\theta_1^1; \theta_2^3) \\
4|123 &\leftrightarrow \frac{112}{2} = \gamma(\theta_1^1\theta_1^1\theta_1^2; \theta_2^3) \\
123|4 &\leftrightarrow \frac{31}{11} = \gamma(\theta_2^3\theta_2^1; \theta_1^2\theta_1^2) \\
2|134 &\leftrightarrow \frac{2^{11}}{2} = \gamma(\theta_1^2\theta_1^1\theta_1^1; \theta_2^3) \\
124|3 &\leftrightarrow \frac{22}{11} = \gamma(\theta_2^2\theta_2^2; \theta_1^2\theta_1^2) \\
134|2 &\leftrightarrow \frac{13}{11} = \gamma(\theta_2^1\theta_2^3; \theta_1^2\theta_1^2) \\
234|1 &\leftrightarrow \frac{4}{2} = \gamma(\theta_1^4; \theta_2^1) \\
3|124 &\leftrightarrow \frac{121}{2} = \gamma(\theta_1^1\theta_1^2\theta_1^1; \theta_2^3) \\
4|123 &\leftrightarrow \frac{112}{2} = \gamma(\theta_1^1\theta_1^1\theta_1^2; \theta_2^3) \\
13|24 &\leftrightarrow \frac{121}{11} = \gamma[\theta_2^1\theta_2^2\theta_2^1; \theta_1^3\gamma(\theta_1^1\theta_1^2; \theta_1^2) + \gamma(\theta_1^2\theta_1^1; \theta_1^2)\theta_1^3] \\
14|23 &\leftrightarrow \frac{112}{11} = \gamma[\theta_2^1\theta_2^1\theta_2^2; \theta_1^3\gamma(\theta_1^1\theta_1^2; \theta_1^2) + \gamma(\theta_1^2\theta_1^1; \theta_1^2)\theta_1^3] \\
23|14 &\leftrightarrow \frac{31}{2} = \gamma(\theta_1^3\theta_1^1; \theta_2^2) \\
34|12 &\leftrightarrow \frac{13}{2} = \gamma(\theta_1^1\theta_1^3; \theta_2^2) \\
12|34 &\leftrightarrow \frac{2^{11}}{11} = \gamma[\theta_2^2\theta_2^1\theta_2^1; \theta_1^3\gamma(\theta_1^1\theta_1^2; \theta_1^2) + \gamma(\theta_1^2\theta_1^1; \theta_1^2)\theta_1^3] \\
1|234 &\leftrightarrow \frac{1^{111}}{11} = \gamma(\theta_2^1\theta_2^1\theta_2^1\theta_2^1; a + b - c + d + e + f), \text{ where} \\
&\quad a = \theta_1^4\gamma(\theta_1^1\gamma(\theta_1^1\theta_1^2; \theta_1^2); \theta_1^2) \\
&\quad b = \gamma(\gamma(\theta_1^2\theta_1^1; \theta_1^2)\theta_1^1; \theta_1^2)\theta_1^4 \\
&\quad c = \gamma(\theta_1^2\theta_1^1\theta_1^1; \theta_1^3)\gamma(\theta_1^1\theta_1^1\theta_1^2; \theta_1^3) \\
&\quad d = \gamma(\theta_1^3\theta_1^1; \theta_1^2)\gamma(\theta_1^1\theta_1^2\theta_1^1; \theta_1^3) \\
&\quad e = \gamma(\theta_1^3\theta_1^1; \theta_1^2)\gamma(\theta_1^1\theta_1^3; \theta_1^2) \\
&\quad f = \gamma(\theta_1^1\theta_1^2\theta_1^1; \theta_1^3)\gamma(\theta_1^1\theta_1^3; \theta_1^2)
\end{aligned}$$

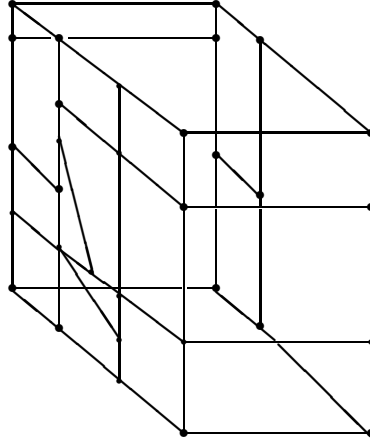

Figure 22. The matrahedron  $KK_{4,2}$  (a subdivision of  $J_4 = K_{4,2} = \vartheta_{3,1}(P_4)$ ).

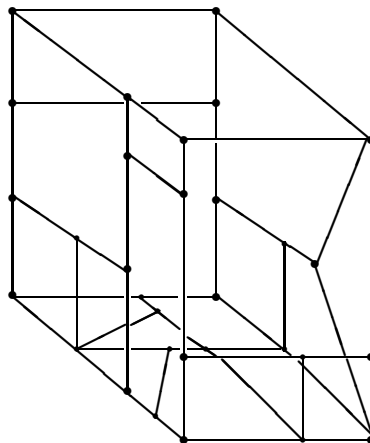

Figure 23. The matrahedron  $KK_{2,4}$  (a subdivision of  $J_4 = K_{2,4} = \vartheta_{1,3}(P_4)$ ).

## REFERENCES

- [1] J. F. Adams, "Infinite Loop Spaces," Annals of Mathematical studies, **90**, Princeton University Press, Princeton, New Jersey (1978).
- [2] B. Fresse, Koszul Duality of Operads and Homology of Partition Posets, preprint of the Nice University, November (2002).
- [3] M. Gerstenhaber and S. D. Schack, Algebras, Bialgebras, Quantum groups, and Algebraic Deformations, Contemporary Math. 134 A. M. S., Providence (1992), 51-92.
- [4] N. Iwase and M. Mimura, Higher Homotopy Associativity, Lecture Notes in Math., 1370 (1986), 193-220.
- [5] J.-L. Loday and M. Ronco, Hopf Algebra of the Planar Binary Trees, *Adv. in Math.* **139**, No. 2 (1998), 293-309.
- [6] M. Markl, A Cohomology Theory for  $A(m)$ -algebras and Applications, *J. Pure and Appl. Algebra.* 83 (1992), 141-175.
- [7] ———, Cotangent Cohomology of a Category and Deformations, *J. Pure and Appl. Algebra.* 113 (1996), 195-218.
- [8] ———, A Resolution (minimal model) of the PROP for Bialgebras, *J. Pure and Appl. Algebra.* 205 (2006), 341-374.
- [9] M. Markl, S. Shnider and J. Stasheff, "Operads in Algebra, Topology and Physics," Mathematical surveys and Monographs, **96** (2002).
- [10] P. May, "The Geometry of Iterated Loop Spaces," *SLNM* **271**, Springer-Verlag, Berlin (1972).
- [11] T. Pirashvili, On the PROP Corresponding to Bialgebras, *Cah. Topol. Geom. Differ. Categ.* 43 (2002), no. 3, 221-239.
- [12] S. Sanedlidze and R. Umble, Diagonals on the Permutohedra, Multiplihedra and Associahedra, *J. Homology, Homotopy and Appl.*, **6** (1) (2004), 363-411.
- [13] ———, The Biderivative and  $A_\infty$ -bialgebras, *J. Homology, Homotopy and Appl.*, **7** (2) (2005), 161-177.
- [14] ———, Matrads and the Category of  $A_\infty$ -bialgebras, in preparation.
- [15] B. Shoikhet, The CROCs, Non-commutative Deformations, and (Co)associative Bialgebras, preprint, math. QA/0306143.
- [16] J. D. Stasheff, Homotopy Associativity of  $H$ -spaces I, II, *Trans. A. M. S.* 108 (1963), 275-312.
- [17] ———, "H-spaces from a Homotopy Point of View," *SLNM* 161, Springer, Berlin (1970).
- [18] A. Tonks, Relating the associahedron and the permutohedron, In "Operads: Proceedings of the Renaissance Conferences (Hartford CT / Luminy Fr 1995)" *Contemporary Mathematics*, 202 (1997), pp.33-36.

A. RAZMADZE MATHEMATICAL INSTITUTE, GEORGIAN ACADEMY OF SCIENCES, M. ALEKSIDZE  
ST., 1, 0193 TBILISI, GEORGIA

*E-mail address:* `sane@rmi.acnet.ge`

DEPARTMENT OF MATHEMATICS, MILLERSVILLE UNIVERSITY OF PENNSYLVANIA, MILLERSVILLE,  
PA. 17551

*E-mail address:* `ron.umble@millersville.edu`