

PRODUCTS OF FOLDABLE TRIANGULATIONS

MICHAEL JOSWIG AND NIKOLAUS WITTE

ABSTRACT. Regular triangulations of products of lattice polytopes are constructed with the additional property that the dual graphs of the triangulations are bipartite. The (weighted) size difference of this bipartition is a lower bound for the number of real roots of certain sparse polynomial systems by recent results of Soprunova and Sottile [Adv. Math. 204(1):116–151, 2006]. Special attention is paid to the cube case.

1. INTRODUCTION

A triangulation K of an m -polytope P is *foldable* if K admits a non-degenerate simplicial map to an m -simplex. This is equivalent to the property that its 1-skeleton is colorable in the graph-theoretic sense with the minimally possible number of $m + 1$ colors. Further, a triangulation is *regular* if it can be lifted to $m + 1$ dimensions as a lower convex hull. The barycentric subdivision of any regular triangulation is an example of a triangulation which is both regular and foldable. A lattice triangulation of P is *dense* if its vertices are all the lattice points inside P , and, for the sake of brevity, we refer to a regular, dense, and foldable triangulation as an *rdf-triangulation*. It is known that a triangulation of a polytope (or, more generally, any simply connected manifold) is foldable if and only if its dual graph is bipartite; see [19]. From rdf-triangulations of lattice polytopes Soprunova and Sottile [27] construct sparse polynomial systems with non-trivial lower bounds for the number of real roots.

For generic coefficients the exact number of complex solutions of a sparse system of polynomials is known from Kushnirenko’s Theorem [21]. To estimate the number of real solutions, however, is considerably more delicate. The lower bound in the approach of Soprunova and Sottile is the degree of a map on the oriented double cover of the real part Y_P of the toric variety associated with the lattice polytope P , where P comes in as the common Newton polytope of the polynomials in the system. In combinatorial terms this map degree translates into the size difference of the two color classes of facets of a rdf-triangulation K of P . More precisely, only those facets of K count in the size difference, called the *signature*, which have odd normalized volume. We sketch this approach in Section 5.1.

This paper is mainly focused on the combinatorial aspects, but we apply our results to sparse polynomial systems at the end. We form rdf-triangulations of products of lattice polytopes from rdf-triangulations of the factors. As an application we construct triangulations of the d -cube $C_d = [0, 1]^d$, which is the product of d line segments. Here we find rdf-triangulations of C_d with a super exponentially large signature. Optimizing triangulations of cubes for combinatorial parameters is often difficult, and basic questions are still open: Most prominently, for the minimal number of facets in a d -cube triangulation for $d > 7$ only partial asymptotic results are known; see Anderson and Hughes [17], Smith [26], Orden and Santos [22], Bliss and Su [4], and Zong [30]. The question whether the constructed triangulations of the d -cube have maximal signature is not addressed in this paper.

The paper is organized as follows. We start out with studying products of simplices because these naturally form the building blocks in our product triangulations. The key player here is the staircase triangulation studied by Billera, Cushman, and Sanders [3], Gel’fand, Kapranov, and Zelevinsky [14], and others. Then we focus on products of arbitrary simplicial complexes. These simplicial products, which depend on linear orderings of the vertices of the factors, already occur in the work of Eilenberg and Steenrod [10, Section II.8] and Santos [24]. We prove that

Date: November 9, 2018.

Both authors are supported by Deutsche Forschungsgemeinschaft, DFG Research Group “Polyhedral Surfaces.”

the product of two foldable simplicial complexes again has a foldable triangulation. Here it is important that there are still some choices left, a fact which plays a role in the construction of the cube triangulations. Then we can prove the following Combinatorial Product Theorem, which is Theorem 4.5 in this paper.

Theorem. *Let P^λ and Q^μ be rdf-triangulations of an m -dimensional lattice polytope $P \subset \mathbb{R}^m$ and an n -dimensional lattice polytope $Q \subset \mathbb{R}^n$, respectively. For specific vertex orderings of the factors (to be explained later) the simplicial product $P^\lambda \times_{\text{stc}} Q^\mu$ is an rdf-triangulation of the polytope $P \times Q$ with signature*

$$\sigma(P^\lambda \times_{\text{stc}} Q^\mu) = \sigma_{m,n} \sigma(P^\lambda) \sigma(Q^\mu),$$

where $\sigma_{m,n}$ is the signature of the staircase triangulation of the product of simplices $\Delta_m \times \Delta_n$.

For the algebraic applications it is essential that Theorem 4.5 can further be improved. In Theorem 5.10 we show that (with a mild additional assumption) the simplicial product $P^\lambda \times_{\text{stc}} Q^\mu$ meets the geometric requirements of Soprunova and Sottile, provided that both factors do.

As an application of our Product Theorems the paper continues with an explicit construction of rdf-triangulations of the d -cube with signature in $\Omega(\lfloor d/2 \rfloor!)$. This lower bound partially relies on computational results obtained with TOPCOM [23], polymake [11, 12, 13], MAGMA [6], and QEPCAD [16].

2. PRODUCTS OF SIMPLICES

Let $\Delta_m = \text{conv}(0, e_1, \dots, e_m)$ be the standard m -simplex, where e_i denotes the i -th unit vector of \mathbb{R}^m . Its normalized volume $\nu(\Delta_m)$ equals $\text{vol}(\Delta_m) m! = 1$.

The product $\Delta_m \times \Delta_n$ is an $(m+n)$ -dimensional convex polytope with $(m+1)(n+1)$ vertices and $m+n+2$ facets. As one key feature $\Delta_m \times \Delta_n$ has the property that it is *totally unimodular*, that is, each facet of any triangulation which uses no additional vertices has normalized volume 1. As a consequence the size of an arbitrary such triangulation of $\Delta_m \times \Delta_n$ is

$$\nu(\Delta_m \times \Delta_n) = \text{vol}(\Delta_m) \text{vol}(\Delta_n) (m+n)! = \binom{m+n}{m}.$$

We are interested in one particular triangulation of $\Delta_m \times \Delta_n$, the *staircase triangulation* $\text{stc}_{m,n} = \text{stc}(\Delta_m \times \Delta_n)$, which can be described as follows. Consider a rectangular grid of size $m+1$ by $n+1$. Each node in the grid corresponds to one vertex of $\Delta_m \times \Delta_n$. The facets of $\text{stc}_{m,n}$, described as subsets of these nodes, correspond to the non-descending and not-returning paths from the lower left node to the upper right node. These paths, which go only right or up, but never left nor down, look like staircases, and hence the name; see Figure 1 (left).

The choice of “right” and “up” in the definition of $\text{stc}_{m,n}$ implicitly assumes an ordering of the vertices of both factors. Throughout this paper we will keep this ordering fixed. The staircase triangulation of $\Delta_m \times \Delta_n$ is the same as the placing triangulation induced by the *lexrev ordering*, that is, the lexicographic ordering of the vertices with the reversed ordering of the vertices of the second factor. In particular, $\text{stc}_{m,n}$ is a regular triangulation.

Each such staircase can be encoded as a *shuffle* of “up” and “right” moves. The name “shuffle” reflects the fact that the number of “up” and “right” moves is always the same, but their order is all that matters. We write the shuffle in Figure 1 as the bit-string 01001, where 0 means “up” and 1 means “right”. The staircase triangulations occurred in Eilenberg and Steenrod [10, Section II.8]; see also Billera, Cushman, and Sanders [3], Gel’fand, Kapranov, and Zelevinsky [14, §7.D], and Santos [24].

Yet another way to encode a facet F of $\text{stc}_{m,n}$ is to assign a vector $s(F) \in \mathbb{N}^m$ as follows. The bit-string $11\dots 100\dots 0$ corresponds to the origin, and for an arbitrary facet F the k -th entry $s(F)_k$ measures the difference between the position of the k -th one in the bit-representation of F and k . This difference may be viewed as the number of “shifts to the right” of the k -th one, starting with the bit-string corresponding to the origin. For example, the bit-string 01001 in Figure 1 is mapped to $(1, 3)$.

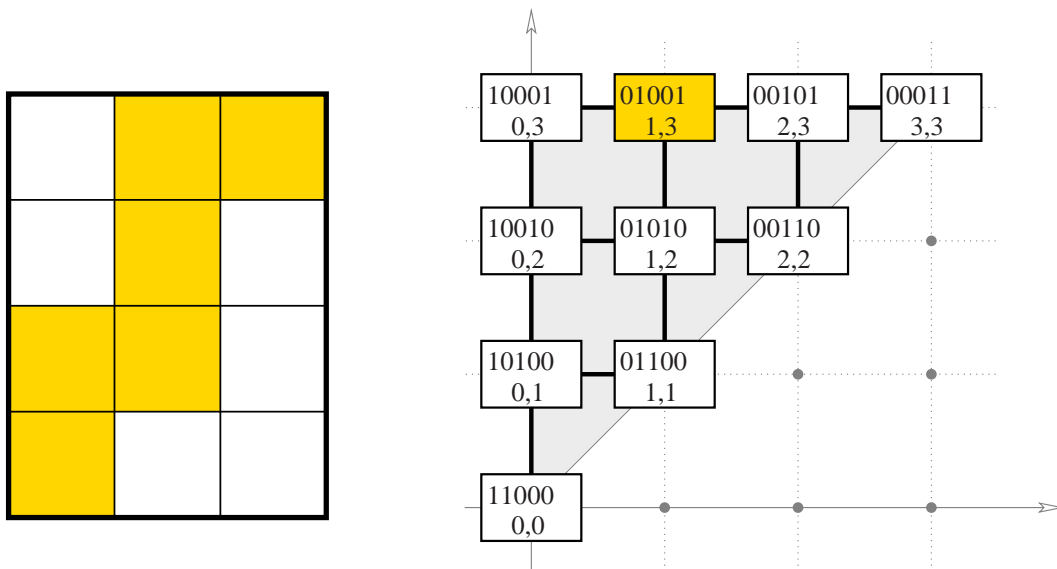

FIGURE 1. The facet 01001 of $\text{stc}(\Delta_2 \times \Delta_3)$ and the dual graph of $\text{stc}(\Delta_2 \times \Delta_3)$ with the facet 01001 marked.

Via the map s the facets of $\text{stc}_{m,n}$ correspond to the integer points in the polytope

$$\mathcal{S}_{m,n} = \left\{ s \in \mathbb{R}^m \mid \begin{array}{l} 0 \leq s_k \leq n \text{ for } 1 \leq k \leq m \\ s_k \leq s_l \text{ for } k < l \end{array} \right\}.$$

This provides us with a convenient description of the dual graph of $\text{stc}_{m,n}$. Let \mathcal{L}_m be the m -dimensional cubic grid, that is, the infinite graph with node set \mathbb{Z}^m , and two nodes are adjacent if they differ in exactly one coordinate by one.

We denote the dual graph of a simplicial complex K by $\Gamma^*(K)$. Its nodes are the facets of K and two facets are adjacent if they differ in one vertex.

Proposition 2.1. *The dual graph $\Gamma^*(\text{stc}_{m,n})$ is the subgraph of \mathcal{L}_m induced by the node set $\mathcal{S}_{m,n} \cap \mathbb{Z}^m$. In particular, this graph is bipartite.*

To conclude this section we mention further aspects of the staircase triangulations, which are, however, inessential for the understanding of rest of this paper.

Remark 2.2. Bit-strings of length $m+n$ with precisely m ones correspond to the vertices of the hypersimplex $H(m+n, m)$. The graph $\Gamma^*(\text{stc}_{m,n})$ is a (not induced) subgraph of the vertex-edge graph of $H(m+n, m)$. The Cayley trick establishes a one-to-one correspondence between the regular triangulations of $\Delta_m \times \Delta_n$ and the fine mixed subdivisions of $(n+1)\Delta_m$; see Santos [25]. In a different context regular triangulations of $\Delta_m \times \Delta_n$ recently re-appeared as the tropical convex hulls of $n+1$ points in the tropical projective space \mathbb{TP}^m ; see Develin and Sturmfels [9]. The staircase triangulations arise as the tropical cyclic polytopes of Block and Yu [5].

3. PRODUCTS OF SIMPLICIAL COMPLEXES

Let K and L be two abstract simplicial complexes. Then the product space $|K| \times |L|$ is equipped with the structure of a cell complex whose cells are the products $f \times g$, where f is a face of K and g is a face of L . This section is about the study of triangulations of $|K| \times |L|$ which refine this natural cell structure.

3.1. The Simplicial Product. Assume that $\dim K = m$ and $\dim L = n$, and denote the vertex sets of K and L by V_K and V_L , respectively. We choose a linear ordering O_K of V_K and another linear ordering O_L of V_L . The product $O_K \times O_L$, defined by

$$(v, w) \geq (v', w') \Leftrightarrow v \geq v' \text{ and } w \geq w',$$

is a partial ordering of the set $V_K \times V_L$. Let $\pi_K : V_K \times V_L \rightarrow V_K$ and $\pi_L : V_K \times V_L \rightarrow V_L$ be the canonical projections.

We define the *simplicial product* (with respect to the vertex orderings O_K and O_L) of K and L as

$$K \times_{\text{stc}} L = \left\{ F \subseteq V_K \times V_L \mid \begin{array}{l} \pi_K(F) \in K \text{ and } \pi_L(F) \in L, \\ \text{and } O|_F \text{ is a total ordering} \end{array} \right\}.$$

The simplicial product $K \times_{\text{stc}} L$ appeared earlier in Eilenberg and Steenrod [10, Section II.8] as the ‘‘Cartesian product’’, and in Santos [24], who calls it the ‘‘staircase refinement’’. Both sources prove the staircase triangulation to be a triangulation of the space $|K| \times |L|$ on the vertex set $V_K \times V_L$.

Let $k = |V_K|$ and $l = |V_L|$ denote the number of vertices of K and L , respectively. There is a convenient way to visualize the simplicial product in the $(k \times l)$ -grid \mathcal{R} : We label the columns of \mathcal{R} with the vertices of K according to the vertex order O_K , and we label the rows of \mathcal{R} with the vertices of L according to the vertex order O_L . For each $f \in K$ and $g \in L$ let $\mathcal{R}_{f,g}$ be the minor of \mathcal{R} induced by f and g . Then we may think of the facets of the simplicial product as the collection of all ascending paths in $\mathcal{R}_{f,g}$ starting bottom-left and finishing top-right. This is a direct generalization of the staircase triangulation of the product of two simplices; see Figure 2. More precisely, we may view the simplicial product $K \times_{\text{stc}} L$ as a subcomplex of the staircase triangulation of the product of a $(k - 1)$ -simplex and an $(l - 1)$ -simplex.

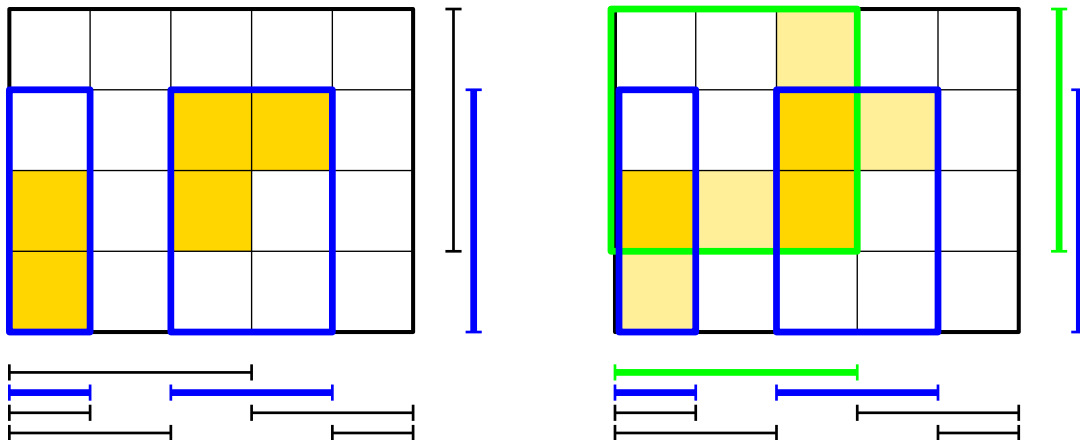

FIGURE 2. A facet defining path of the simplicial product of two different triangulations of the square. On the right two facets intersecting in a low dimensional face.

The ordering of the vertices of K and L is crucial to $K \times_{\text{stc}} L$. Figure 3 depicts the product of the triangulated unit square with the unit interval. The three distinct orderings of the vertices of the triangulated square yield three pairwise non-isomorphic triangulations of the 3-cube C_3 decomposed as $C_2 \times I$.

3.2. Foldable Simplicial Complexes. An m -dimensional pure simplicial complex K is called *foldable* if K admits a non-degenerate simplicial map to an m -simplex. Equivalently, the 1-skeleton of K is $(m + 1)$ -colorable in the graph-theoretic sense: that is, there is a map c from the vertex set V to the set $[m + 1]$ such that for each 1-face $\{u, v\} \in K$ we have $c(u) \neq c(v)$. Here $[k] = \{0, \dots, k - 1\}$ denotes the set of the first k integers. Notice that there is no coloring of the vertices of K with less than $m + 1$ colors, since the $m + 1$ vertices of any facet form a clique. If K is foldable with a connected dual graph then the $(m + 1)$ -coloring of K is unique up to renaming the colors.

Goodman and Onishi [15] observed that the 4-Color-Theorem is equivalent to the property that each simplicial 3-polytope admits a foldable triangulation (with or without additional vertices in the interior).

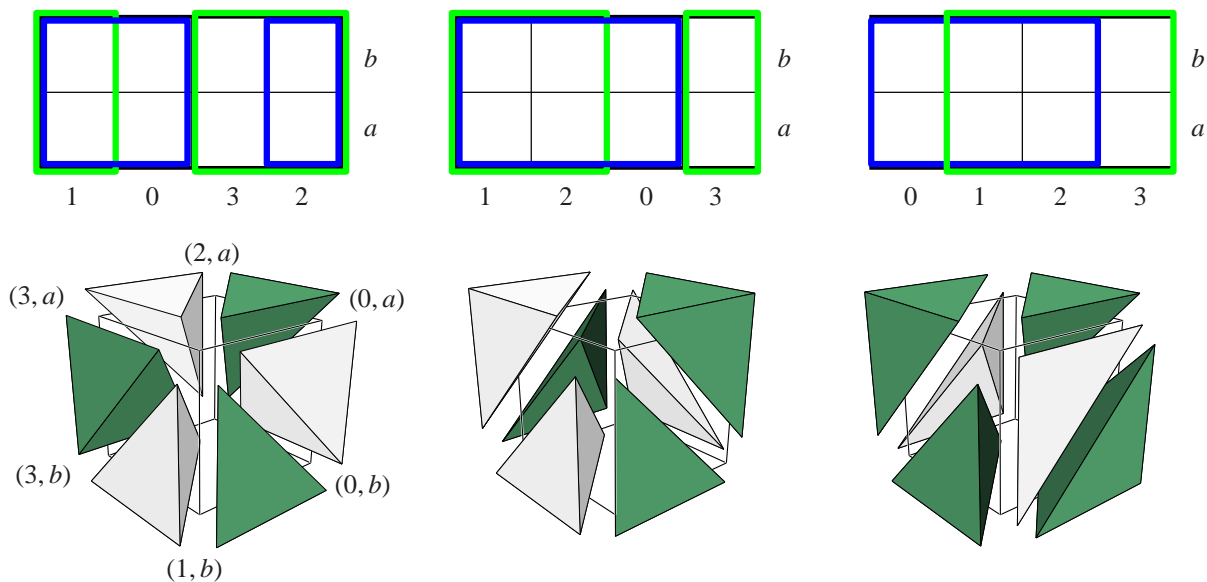

FIGURE 3. Three different orderings of the vertices of the triangulated square $\{\{0, 1, 2\}, \{1, 2, 3\}\}$ and the resulting regular triangulations of the 3-cube. The vertices 0 and 3 of the square are colored the same, and the top-front vertex of the 3-cube is labeled $(1, a)$, and the bottom-back vertex is labeled $(2, b)$. The second and third 3-cube are labeled the same.

Remark 3.1. Other sources, including Billera and Björner [2], Stanley [28], Soprunova and Sottile [27], and [19, 18], call foldable simplicial complexes “balanced.” However, this seems to create conflicts with other concepts: A triangulation of a polygon whose dual graph is a balanced tree is sometimes called “balanced”, and a minimal set of affinely dependent vertices of a polytope with an equal number of positive and negative coefficients is called a “balanced” circuit in Bayer [1]. Goodman and Onishi call foldable triangulations (of balls and spheres) “even.” However, this does not describe the situation in the non-simply connected case. For these reasons we suggest the name “foldable” instead.

If K is pure and, additionally, certain global and local connectivity assumptions are satisfied, then K is foldable if and only if its group of projectivities is trivial. These connectivity assumptions hold, for instance, when K is the triangulation of a manifold (with or without boundary). Moreover, in this case, foldability implies that the dual graph of K is bipartite. The converse holds for simply connected combinatorial manifolds. For these facts and related results see [19, 18]. In the following we study products of foldable simplicial complexes.

Let $[k] = \{0, \dots, k - 1\}$ be the vertex set of K . Assume that there is a coloring of K given by a weakly monotone map $c_K : [k] \rightarrow [m + 1]$. Then we call the natural ordering on $[k]$ *color consecutive*. Any foldable complex admits (many) color consecutive orderings.

Proposition 3.2. *If K and L are foldable simplicial complexes with color consecutive vertex orderings then the corresponding simplicial product $K \times_{\text{stc}} L$ is foldable.*

Proof. Let the vertex sets of K and L be $[k]$ and $[l]$, respectively, with weakly monotone coloring maps $c_K : [k] \rightarrow [m + 1]$ and $c_L : [l] \rightarrow [n + 1]$. We define

$$c : [k] \times [l] \rightarrow [m + n + 1] : (v, w) \mapsto c_K(v) + c_L(w) .$$

In order to show that c is a coloring of $K \times_{\text{stc}} L$ it suffices to check that each facet contains each color at most once. Each facet F of $K \times_{\text{stc}} L$ is contained in a unique cell $f \times g$ where f is a facet of K and g is a facet of L . Let $v \times w$ and $v' \times w'$ be distinct vertices of F . We may assume $v < v'$; then $w \leq w'$ since F is a facet of the staircase triangulation of $f \times g$. As the restrictions $c_K|_f$ and $c_L|_g$ are strictly monotone we have $c(v, w) = c_K(v) + c_L(w) < c_K(v') + c_L(w') = c(v', w')$. For an example see Figure 4. \square

In what follows below it is essential that it is not necessary to have color consecutive orderings for the factors in order to obtain a foldable simplicial product triangulation.

Example 3.3. Let B_n be the triangulation of the bipyramid over the $(n-1)$ -simplex Δ_{n-1} formed of two n -simplices sharing a facet. Combinatorially, B_n is the join of Δ_{n-1} with the zero-dimensional sphere S^0 consisting of two isolated points. The triangulation B_n is obviously foldable. The *symmetric vertex ordering* S_n on B_n starts with one of the two apices and ends with the other apex, the vertices of Δ_{n-1} come in between. That is to say, we take $[n+2]$ as the vertex set of B_n , where 0 and $n+1$ are the apices, and a coloring map $s_n : [n+2] \rightarrow [n+1] : w \mapsto w \bmod(n+1)$. Because of the symmetry properties of B_n the precise ordering of the vertices $1, 2, \dots, n$ does not matter. Likewise it is not necessary to distinguish the two apices.

The triangulation B_n with the symmetric vertex ordering will be used in the construction of certain cube triangulations in Section 6.

Proposition 3.4. *Let K be a foldable simplicial complex with a color consecutive ordering O_K . Then the simplicial product $K \times_{\text{stc}} B_n$ with respect to O_K and S_n is foldable.*

Proof. We use almost the same coloring scheme as in Proposition 3.2. Let $[k]$ be the vertex set of K , and let $c_K : [k] \rightarrow [m+1]$ be a weakly monotone coloring map. We define

$$c : [k] \times [n+2] \rightarrow [m+n+1] : (v, w) \mapsto c_K(v) + w \bmod(m+n+1).$$

This, indeed, is a coloring since there is no facet of $K \times_{\text{stc}} B_n$ containing both, a vertex of the type $(v, 0)$ and a vertex of the type $(v, n+1)$. \square

We refer to Figure 3 for the three different simplicial products of an interval with a square arising from the two color consecutive and the symmetric vertex ordering of the square (which is a bipyramid over a 1-simplex).

3.3. Regular Triangulations of Polytopes. Let P be an m -dimensional convex polytope in \mathbb{R}^m , and let K be a triangulation of P with vertex set V . The triangulation K is *regular* if there is a convex function $\lambda : \mathbb{R}^m \rightarrow \mathbb{R}$ such that K coincides with the polyhedral subdivision of P induced by the lower convex hull of the set $\{(v, \lambda(v)) \in \mathbb{R}^{m+1} \mid v \in V\}$. In this case λ is called a *lifting function* for K . Since we want to stress that a regular triangulation only depends on P and λ we denote such a triangulation as P^λ .

Choose (pairwise distinct) points p_1, \dots, p_k in P such that $\text{conv}\{p_1, \dots, p_k\} = P$. This implies that the vertices of P occur among the chosen points. Then the *placing triangulation* of P with respect to the chosen points in the given ordering is the regular triangulation of P with vertex set $\{p_1, \dots, p_k\}$ and a lifting function λ such that $(p_l, \lambda(p_l))$ is above all affine hyperplanes spanned by points in the set $\{(p_1, \lambda(p_1)), \dots, (p_{l-1}, \lambda(p_{l-1}))\}$. A point $(p, \lambda(p))$ lies *above* the affine hyperplane $H \subset \mathbb{R}^{m+1}$ spanned by the points $\{(p_1, \lambda(p_1)), \dots, (p_{m+1}, \lambda(p_{m+1}))\}$ if and only if the unique $\lambda' \in \mathbb{R}$ with

$$(1) \quad \det \begin{pmatrix} 1 & 1 & 1 & \dots & 1 \\ p & p_1 & p_2 & \dots & p_{m+1} \\ \lambda' & \lambda(p_1) & \lambda(p_2) & \dots & \lambda(p_{m+1}) \end{pmatrix} = 0$$

satisfies $\lambda' < \lambda(p)$.

Example 3.5. Consider the standard simplices $\Delta_m = \text{conv}\{0, e_1, \dots, e_m\}$ and $\Delta_n = \text{conv}\{0, e_1, \dots, e_n\}$. To simplify the formulae below we set $e_0 = 0$. Then the lexrev ordering on the vertices of the product $\Delta_m \times \Delta_n$ is given as

$$O : \{e_0, \dots, e_m\} \times \{e_0, \dots, e_n\} \rightarrow [(m+1)(n+1)] : (e_i, e_j) \mapsto (n+1)i + (n-j).$$

Applying Equation 1 and an easy computation shows that

$$\omega : \{e_0, \dots, e_m\} \times \{e_0, \dots, e_n\} \rightarrow \mathbb{R} : (v, w) \mapsto 2^{O(v,w)}$$

is a lifting function for the staircase triangulation, that is, $(\Delta_m \times \Delta_n)^\omega = \text{stc}_{m,n}$. Additionally, this shows that $\text{stc}_{m,n}$ is a placing triangulation with respect to the lexrev ordering.

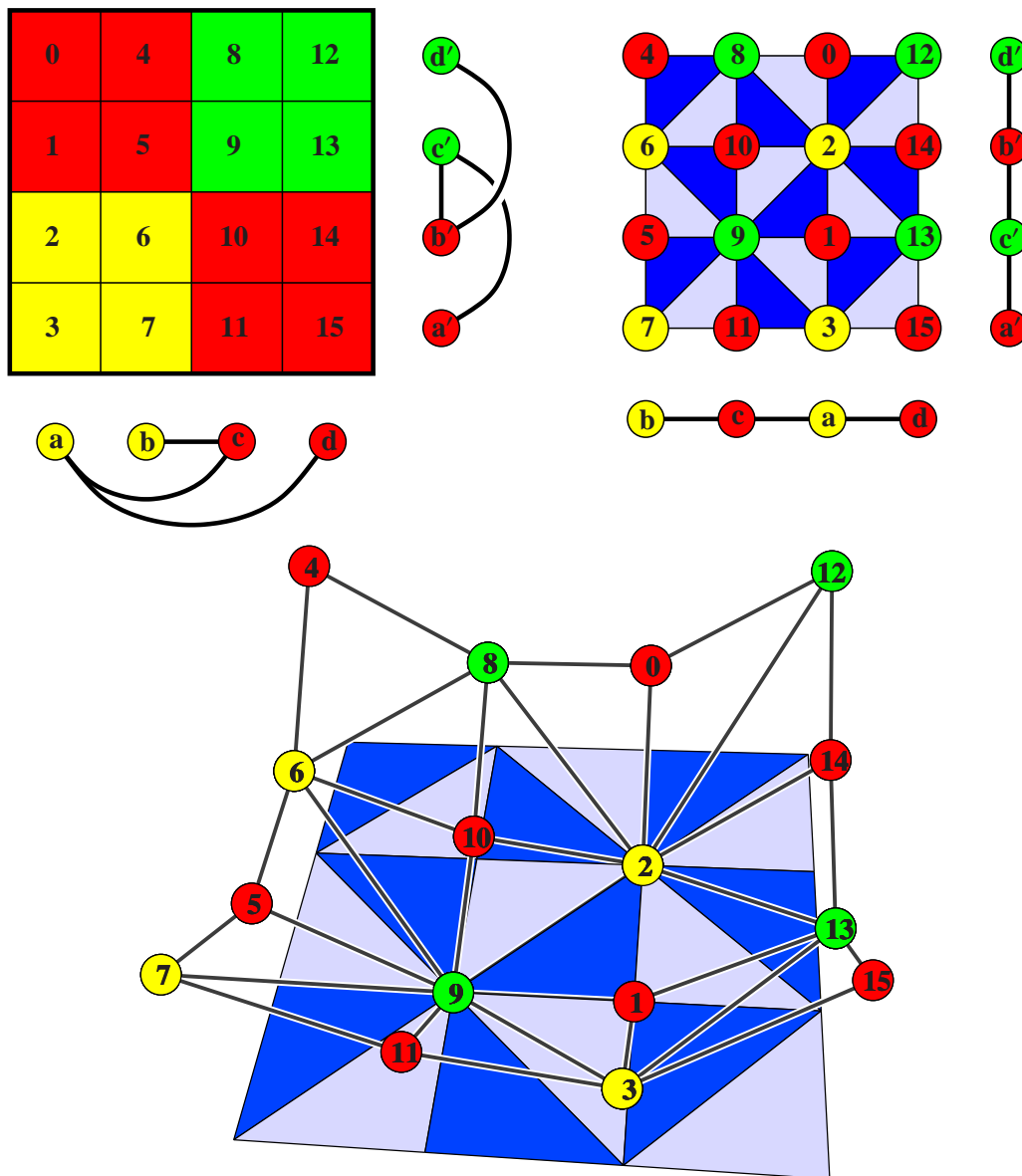

FIGURE 4. Simplicial product of a path I of length 3 with itself, using color consecutive vertex orderings. The vertices of the product are colored according to the color scheme from the proof of Proposition 3.2 and are labeled in lexrev order.

Proposition 3.6. *Let P^λ and Q^μ be regular triangulations of an m -polytope $P \subset \mathbb{R}^m$ and an n -polytope $Q \subset \mathbb{R}^n$, respectively. Then the simplicial product $P^\lambda \times_{\text{stc}} Q^\mu$ is a regular triangulation of the polytope $P \times Q$ for any vertex orderings O_{P^λ} and O_{Q^μ} .*

Proof. Let V_{P^λ} be the vertex set of P^λ equipped with a linear ordering O_{P^λ} , and let V_{Q^μ} be the vertex set of Q^μ with a linear ordering O_{Q^μ} . The simplicial product $P^\lambda \times_{\text{stc}} Q^\mu$ (with respect to O_{P^λ} and O_{Q^μ}) is a triangulation of the product $P \times Q$ on the vertex set $V_{P^\lambda} \times V_{Q^\mu}$.

Let $\lambda : V_{P^\lambda} \rightarrow \mathbb{R}$ and $\mu : V_{Q^\mu} \rightarrow \mathbb{R}$ be lifting functions of P^λ and Q^μ . We construct a lifting function $\omega : V_{P^\lambda} \times V_{Q^\mu} \rightarrow \mathbb{R}$ of $P^\lambda \times_{\text{stc}} Q^\mu$ in two steps. First consider the map

$$\omega_0 : V_{P^\lambda} \times V_{Q^\mu} \rightarrow \mathbb{R} : (x, y) \mapsto \lambda(x) + \mu(y),$$

which is a lifting function for the polytopal complex $P^\lambda \times Q^\mu$. In the second step ω_0 has to be perturbed such that it induces a staircase triangulation on each cell of $P^\lambda \times Q^\mu$. To this end recall that the staircase triangulations are placing, and that the lexrev ordering O on $V_{P^\lambda} \times V_{Q^\mu}$ induces

a placing order on each product of simplices $f \times g$ where $f \in P^\lambda$ and $g \in Q^\mu$. Now define ω as an ϵ -perturbation of ω_0 by the lifting function from Example 3.5 corresponding to O :

$$(2) \quad \omega : V_{P^\lambda} \times V_{Q^\mu} \rightarrow \mathbb{R} : (v, w) \mapsto \lambda(v) + \mu(w) + \epsilon 2^{O(v,w)},$$

for a sufficiently small $\epsilon > 0$. Viewing the simplicial product again as subcomplex of the staircase triangulation of two large simplices, shows that, indeed $(P \times Q)^\omega = P^\lambda \times_{\text{stc}} Q^\mu$. For an example see Figure 4. \square

In general, there may be several perturbations which lead to different lifting functions but which induce the same triangulations. An important special case occurs if the triangulations P^λ and Q^μ additionally are foldable. In this case it is possible to define a perturbation which only depends on the color classes of the vertices of the factors:

Example 3.7. Let $c_{P^\lambda} : V_{P^\lambda} \rightarrow [m+1]$ and $c_{Q^\mu} : V_{Q^\mu} \rightarrow [n+1]$ be coloring maps. Using color consecutive vertex orderings for V_{P^λ} and V_{Q^μ} and the resulting lexrev ordering O for the vertices of $P \times_{\text{stc}} Q$ we may choose a different perturbation than in Equation (2). This yields the following lifting function

$$(3) \quad \omega : V_{P^\lambda} \times V_{Q^\mu} \rightarrow \mathbb{R} : (v, w) \mapsto \lambda(v) + \nu(w) + \epsilon 2^{(n+1)c_{P^\lambda}(v) + (n-c_{Q^\mu}(w))},$$

for $\epsilon > 0$ sufficiently small. Note that we use the same perturbation $\epsilon 2^{(n+1)i + (n-j)}$ for all vertices (v, w) with $c_{P^\lambda}(v) = i$ and $c_{Q^\mu}(w) = j$. Let us restrict our attention to a cell $f \times g$ for facets $f \in P^\lambda$ and $g \in Q^\mu$. Since any color $i \in [m+1]$ appears exactly once in the coloring of f and any color $j \in [n+1]$ appears exactly once in the coloring of g , respectively, there is exactly one vertex $(v, w) \in f \times g$ with $c_{P^\lambda}(v) = i$ and $c_{Q^\mu}(w) = j$ for each $(i, j) \in [m+1] \times [n+1]$. Hence ω restricted to $f \times g$ induces the staircase triangulation $f \times_{\text{stc}} g$ from Example 3.5, and ω induces the simplicial product triangulation $(P \times Q)^\omega = P^\lambda \times_{\text{stc}} Q^\mu$ on $P^\lambda \times Q^\mu$.

4. TRIANGULATIONS OF LATTICE POLYTOPES

Let P be an m -dimensional *lattice polytope*, that is, we assume that its vertex coordinates are integral. Since the determinant of an integral matrix is an integer it follows that the *normalized volume* $\nu(P) = m! \text{vol}(P)$ is an integer, where $\text{vol}(P)$ is the usual m -dimensional volume of P . A lattice simplex is called *even* or *odd* depending on the parity of its normalized volume. A triangulation K of a lattice polytope P is *dense* if it uses all lattice points inside P , that is, its vertex set is $P \cap \mathbb{Z}^m$. In the case that K is additionally regular, say with lifting function λ , we again write P^λ for K since it only depends on P and λ .

Let P^λ be an rdf-triangulation of P , that is, P^λ is regular, dense, and foldable. In particular P^λ is a lattice triangulation. Recall that P^λ is foldable if and only if its dual graph is bipartite. Usually we refer to the two color classes as “black” and “white”. Then the *signature* $\sigma(P^\lambda)$ of P^λ is defined as the absolute value of the difference of the odd black and the odd white facets in P^λ . Note that the even facets are not accounted for in any way. Moreover, in the important special case where P^λ is *unimodular*, that is, where all the facets have a normalized volume equal to 1, all facets are odd. For examples of unimodular triangulations of the 3-cube with signatures equal to 0 and 2 see Figure 3; note that all triangulations of the 3-cube without additional vertices are regular.

Example 4.1. Dense and foldable triangulations do not exist for all lattice polytopes. For instance, in any dimension $m \geq 2$ there are lattice simplices of arbitrarily large volume which admit exactly one dense triangulation (which is regular), but which is not foldable.

For $k \geq 1$ let $\Delta_2(k) = \text{conv}\{(0, 1), (1, 0), (2k, 2)\}$, a triangle with normalized volume $\nu(\Delta_2(k)) = 2k + 1$. For $m \geq 3$ we define $\Delta_m(k)$ as the cone over $\Delta_{m-1}(k)$ with the m -th unit vector as its apex; this is an m -simplex with normalized volume $\nu(\Delta_m(k)) = \nu(\Delta_{m-1}(k)) = \dots = 2k + 1$.

The interior point $(k, 1) \in \Delta_2(k)$ is a degree-3-vertex in the unique (regular and) dense triangulation of $\Delta_2(k)$, hence there is no dense and foldable triangulation of $\Delta_2(k)$. The cone over a triangulation K of $\Delta_{m-1}(k)$ is foldable if and only if K is foldable and any triangulation of $\Delta_m(k)$ arises as a cone over a triangulation of $\Delta_{m-1}(k)$. Therefore there is no rdf-triangulation of $\Delta_m(k)$ by induction.

goes all the way to the right and then all the way up in Figure 1. To determine the sign $\delta(f, g)$ amounts to determining the color of the facet $F_0(f, g)$ in $P^\lambda \times_{\text{stc}} Q^\mu$.

We first consider the case where P^λ is a lattice m -simplex Δ_m (without interior lattice points) and Q^μ consists of two neighboring n -simplices (without interior lattice points), that is, Q^μ is the rdf-triangulation B_n of the bipyramid over the $(n-1)$ -simplex from Example 3.3. Note that Δ_m is an rdf-triangulation of itself. Further, the signature of Δ_m vanishes if the normalized volume of Δ_m is even and equals 1 otherwise.

Lemma 4.4. *The simplicial product $\Delta_m \times_{\text{stc}} B_n$ is an rdf-triangulation of the product of Δ_m and a lattice bipyramid over the $(n-1)$ -simplex with signature*

$$\sigma(\Delta_m \times_{\text{stc}} B_n) = \begin{cases} \sigma_{m,n} \sigma(\Delta_m) \sigma(B_n) & \text{if the vertex ordering on } B_n \text{ is} \\ & \text{color consecutive or if } m \text{ is even,} \\ \sigma_{m,n} \sigma(\Delta_m) \omega & \text{if the vertex ordering on } B_n \\ & \text{is symmetric and } m \text{ is odd.} \end{cases}$$

Here $\omega \in \{0, 1, 2\}$ counts the number of odd simplices in B_n .

Proof. It is a consequence of Propositions 3.2 and 3.6 that $\Delta_m \times_{\text{stc}} B_n$ is an rdf-triangulation.

Let g and g' be the two facets of B_n . In both cases we get a contribution of $\delta(\Delta_m, g) \sigma_{m,n} \sigma(\Delta_m)$ to $\sigma(\Delta_m \times_{\text{stc}} B_n)$ if g is odd, and similarly a contribution of $\delta(\Delta_m, g') \sigma_{m,n} \sigma(\Delta_m)$ to $\sigma(\Delta_m \times_{\text{stc}} B_n)$ if g' is odd; see Equation (4).

It remains to compare $\delta(\Delta_m, g)$ and $\delta(\Delta_m, g')$, which depends on the vertex ordering of B_n . We have $\delta(\Delta_m, g) = -\delta(\Delta_m, g')$ if and only if $F_0(\Delta_m, g)$ and $F_0(\Delta_m, g')$ are colored differently which in turn holds if and only if the distance between $F_0(\Delta_m, g)$ and $F_0(\Delta_m, g')$ in $\Gamma^*(\Delta_m \times_{\text{stc}} B_n)$ is odd.

Since $\Gamma^*(\Delta_m \times_{\text{stc}} B_n)$ is bipartite, each path from $F_0(\Delta_m, g)$ to $F_0(\Delta_m, g')$ has the same parity, and we may choose any path to determine the parity of the distance. Let $\tilde{F}_0(\Delta_m, g) \in \text{stc}(\Delta_m \times g)$ and $\tilde{F}_0(\Delta_m, g') \in \text{stc}(\Delta_m \times g')$ be neighboring facets. Then the distance between $F_0(\Delta_m, g)$ and $F_0(\Delta_m, g')$ is odd if and only if the distance between $F_0(\Delta_m, g)$ and $\tilde{F}_0(\Delta_m, g)$ has the same parity as the distance between $F_0(\Delta_m, g')$ and $\tilde{F}_0(\Delta_m, g')$ (keep in mind that the distance between $\tilde{F}_0(\Delta_m, g)$ and $\tilde{F}_0(\Delta_m, g')$ is 1).

We first consider the case where the vertex ordering of B_n is color consecutive. Let c be the color of the unique vertex $v \in g \setminus g'$ (which is the same as the color of the unique vertex $v' \in g' \setminus g$). All columns in the lattice grid defining $\Delta_m \times_{\text{stc}} B_n$ corresponding to vertices colored c are consecutive and hence v and v' follow one after another in the vertex ordering of B_n . We distinguish the two cases where v and v' appear somewhere in the middle or at the beginning of the vertex ordering of B_n and where v and v' appear at the end of the vertex ordering; see Figure 5. In the first case we may choose $F_0(\Delta_m, g) = \tilde{F}_0(\Delta, g)$ and $F_0(\Delta_m, g') = \tilde{F}_0(\Delta_m, g')$ and the distance between $F_0(\Delta_m, g)$ and $F_0(\Delta, g')$ is 1. In the second case the distance between $F_0(\Delta_m, g)$ and $\tilde{F}_0(\Delta_m, g)$ equals the distance between $F_0(\Delta_m, g')$ and $\tilde{F}_0(\Delta_m, g')$. Therefore we obtain $\delta(\Delta_m, g) = -\delta(\Delta_m, g')$ in the color consecutive case.

Let the vertex ordering on B_n be symmetric. We have $F_0(\Delta_m, g) = \tilde{F}_0(\Delta_m, g)$ and the distance of $F_0(\Delta_m, g')$ and $\tilde{F}_0(\Delta_m, g')$ is m , hence $\delta(\Delta_m, g) = -\delta(\Delta_m, g')$ if and only if m is even; see Figure 6.

We refer to Figure 3 for an example of three triangulations of $[0, 1] \times B_2$ resulting from different vertex orders of B_2 . \square

Theorem 4.5 (Combinatorial Product Theorem). *Let P^λ and Q^μ be rdf-triangulations of an m -dimensional lattice polytope $P \subset \mathbb{R}^m$ and an n -dimensional lattice polytope $Q \subset \mathbb{R}^n$, respectively. For color consecutive vertex orderings O_P and O_Q the simplicial product $P^\lambda \times_{\text{stc}} Q^\mu$ is an rdf-triangulation of the polytope $P \times Q$ with signature*

$$\sigma(P^\lambda \times_{\text{stc}} Q^\mu) = \sigma_{m,n} \sigma(P^\lambda) \sigma(Q^\mu).$$

Proof. Again, by Propositions 3.2 and 3.6, $P^\lambda \times_{\text{stc}} Q^\mu$ is an rdf-triangulation.

Let $f, f' \in P^\lambda$ and $g, g' \in Q^\mu$ be facets such that $f \times g$ and $f' \times g'$ are neighboring cells of $P^\lambda \times Q^\mu$. We may assume that $f = f'$ and $g \cap g'$ is a ridge. Hence $g \cup g'$ is a bipyramid over the common ridge $g \cap g'$. Applying Lemma 4.4 to $f \times_{\text{stc}} (g \cup g')$ yields $\delta(f, g) = -\delta(f, g')$, and we may

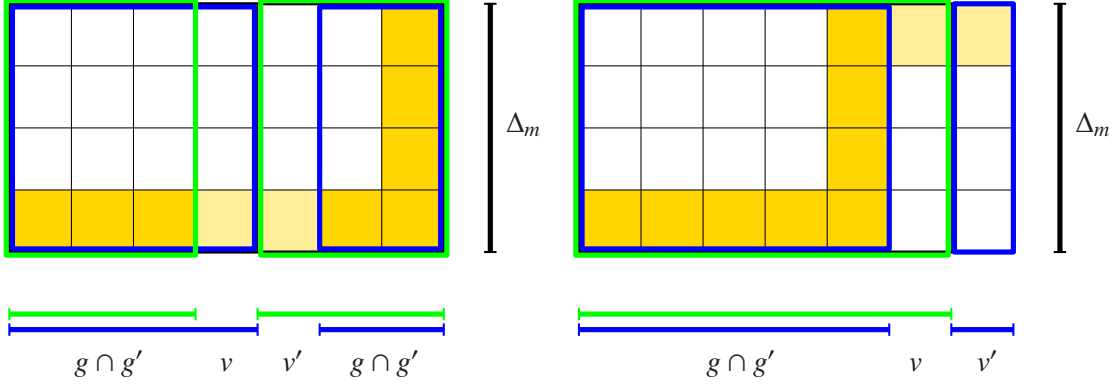

FIGURE 5. Distance of the facets of reference $F_0(\Delta_m, g)$ and $F_0(\Delta_m, g')$ in $\Gamma^*(\Delta_m \times_{\text{stc}} B_n)$ for color consecutive orderings of B_n . The facets $\tilde{F}_0(\Delta_m, g)$ and $\tilde{F}_0(\Delta_m, g')$ and their intersection is shaded. On the left the two apices v, v' occur somewhere in the middle or at the beginning of the vertex ordering of B_n , on the right at the end.

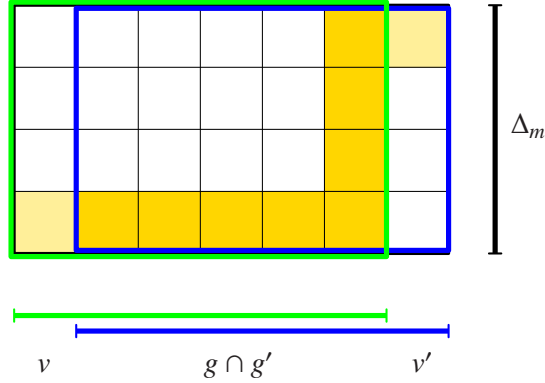

FIGURE 6. Distance of the facets of reference $F_0(\Delta_m, g)$ and $F_0(\Delta_m, g')$ in $\Gamma^*(\Delta_m \times_{\text{stc}} B_n)$ for the symmetric ordering of the vertices of B_n . The facets $\tilde{F}_0(\Delta_m, g)$ and $\tilde{F}_0(\Delta_m, g')$ and their intersection is shaded.

We may think of $\Gamma^*(P^\lambda \times Q^\mu)$ as a copy of $\Gamma^*(P^\lambda)$ for each node of $\Gamma^*(Q^\mu)$. Each copy of $\Gamma^*(P^\lambda)$ may be 2-colored using the bipartition of $\Gamma^*(P^\lambda)$, but we must use the inverse coloring for a copy of $\Gamma^*(P^\lambda)$ if the corresponding node of $\Gamma^*(Q^\mu)$ is colored white. Therefore a node $f \times g$ of $\Gamma^*(P^\lambda \times Q^\mu)$ is labeled +1 if and only if the facets $f \in P^\lambda$ and $g \in Q^\mu$ are colored the same, and using Equation (4) we have

$$\begin{aligned}
 \sigma(P^\lambda \times_{\text{stc}} Q^\mu) &= \sigma_{m,n} \left| \sum_{f \in P^\lambda \text{ black}} (\bar{v}(f) \sum_{g \in Q^\mu \text{ black}} \bar{v}(g)) + \sum_{f \in P^\lambda \text{ white}} (\bar{v}(f) \sum_{g \in Q^\mu \text{ white}} \bar{v}(g)) \right. \\
 &\quad \left. - \sum_{f \in P^\lambda \text{ black}} (\bar{v}(f) \sum_{g \in Q^\mu \text{ white}} \bar{v}(g)) - \sum_{f \in P^\lambda \text{ white}} (\bar{v}(f) \sum_{g \in Q^\mu \text{ black}} \bar{v}(g)) \right| \\
 &= \sigma_{m,n} \left| \sum_{f \in P^\lambda \text{ black}} \bar{v}(f) - \sum_{f \in P^\lambda \text{ white}} \bar{v}(f) \right| \left| \sum_{g \in Q^\mu \text{ black}} \bar{v}(g) - \sum_{g \in Q^\mu \text{ white}} \bar{v}(g) \right| \\
 &= \sigma_{m,n} \sigma(P^\lambda) \sigma(Q^\mu).
 \end{aligned}$$

Finally we consider the case where Q^μ is the rdf-triangulation B_n of the bipyramid over the $(n-1)$ -simplex from Example 3.3. While this seems to cover a very special case only, the result is instrumental for the construction of triangulations of the d -cube with non-trivial signature in Section 6.

Proposition 4.6. *Let P^λ be an rdf-triangulation of an m -dimensional lattice polytope $P \subset \mathbb{R}^m$ with a color consecutive ordering on its vertex set $V_P = P \cap \mathbb{Z}^m$. Then $P^\lambda \times_{\text{stc}} B_n$ is an rdf-triangulation of the product of P with a lattice bipyramid over the $(n-1)$ -simplex with signature*

$$\sigma(P^\lambda \times_{\text{stc}} B_n) = \begin{cases} \sigma_{m,n} \sigma(P^\lambda) \sigma(B_n) & \text{if the vertex ordering on } B_n \text{ is} \\ & \text{color consecutive or if } m \text{ is even,} \\ \sigma_{m,n} \sigma(P^\lambda) \omega & \text{if the vertex ordering on } B_n \\ & \text{is symmetric and } m \text{ is odd.} \end{cases}$$

Here $\omega \in \{0, 1, 2\}$ counts the number of odd simplices in B_n .

One can show that for other vertex orderings of B_n the simplicial product $P^\lambda \times_{\text{stc}} B_n$ is not foldable. In this sense the two cases listed exhaust all the possibilities.

Proof. Propositions 3.2 and 3.6 ensure that $P^\lambda \times_{\text{stc}} Q^\mu$ is an rdf-triangulation. Let g and g' be the two facets of B_n , and let us think of $P^\lambda \times B_n$ as the union of two copies of $P^\lambda \times \Delta_n$, which we denote as $P^\lambda \times g$ and $P^\lambda \times g'$. Further let $f \in P^\lambda$ be an arbitrary but fixed facet. We get a contribution of $\delta(f, g) \sigma(P^\lambda) \sigma_{m,n}$ to $\sigma(P^\lambda \times_{\text{stc}} B_n)$ if g is odd by Theorem 4.5. Similarly we get a contribution of $\delta(f, g') \sigma(P^\lambda) \sigma_{m,n}$ to $\sigma(P^\lambda \times_{\text{stc}} B_n)$ if g' is odd. It remains to compare $\delta(f, g)$ and $\delta(f, g')$. The simplicial product $f \times_{\text{stc}} (g \cup g')$ is a triangulation of the product of an m -simplex and B_n and by Lemma 4.4 we have $\delta(f, g) = -\delta(f, g')$ in the first and $\delta(f, g) = \delta(f, g')$ in the second case. \square

A referee suggested the following generalization of Proposition 4.6, which we state without a proof. Let P^λ and Q^μ be rdf-triangulations of the full dimensional lattice polytopes $P \subset \mathbb{R}^m$ and $Q \subset \mathbb{R}^n$, respectively. Further let the vertices of P^λ be ordered color consecutive, and let the vertices of Q^μ be partitioned into subsets V_0, V_1, \dots, V_n according to their colors. An *almost color consecutive* ordering of the vertices of Q^μ is obtained by splitting V_0 into two subsets V'_0 and V''_0 and taking any vertex ordering compatible with $V'_0 < V_1 < \dots < V_n < V''_0$. The vertex sets V'_0 and V''_0 induce a bipartition on the facets of Q^μ denoted by L' and L'' , and let the facets of L' , respectively L'' be colored “black” and “white” according to the coloring of the facets of Q^μ (neither L' nor L'' is strongly connected in general). Finally we set the *signed signature* $\tilde{\sigma}(L)$ of a geometric simplicial complex L with facets colored “black” and “white” as the number of odd “black” facets minus the number of odd “white” facets.

Proposition 4.7. *The simplicial product $P^\lambda \times_{\text{stc}} Q^\mu$ (with respect to the color consecutive vertex ordering of P^λ and the almost color consecutive vertex ordering of Q^μ) is a rdf-triangulation of $P \times Q$ with signature*

$$\sigma(P^\lambda \times_{\text{stc}} Q^\mu) = \begin{cases} \sigma_{m,n} \sigma(P^\lambda) \sigma(Q^\mu) & \text{if } m \text{ is even,} \\ \sigma_{m,n} \sigma(P^\lambda) |\tilde{\sigma}(L') - \tilde{\sigma}(L'')| & \text{if } m \text{ is odd.} \end{cases}$$

5. LOWER BOUNDS FOR THE NUMBER OF REAL ROOTS OF POLYNOMIAL SYSTEMS

Triangulations which are regular, dense, and foldable are interesting since they yield non-trivial lower bounds for the number of real roots of associated polynomial systems, provided that a number of additional geometric conditions are met. To discuss these issues we first review the construction of Soprunova and Sottile [27].

5.1. Triangulations and Lower Bounds. Let $P \subset \mathbb{R}_{\geq 0}^m$ be a lattice m -polytope contained in the positive orthant, and let $\lambda : P \cap \mathbb{Z}^m \rightarrow \mathbb{R}$ be a lifting function such that the induced triangulation P^λ is an rdf-triangulation. Further let the vertices $P \cap \mathbb{Z}^m$ of P^λ be colored by the map $c : P \cap \mathbb{Z}^m \rightarrow [m+1]$. We define the *coefficient polynomial* $F_{P^\lambda, i, s} \in \mathbb{R}[t_1, \dots, t_m]$ of a color i and an additional parameter $s \in (0, 1]$ as

$$(5) \quad F_{P^\lambda, i, s}(t) = \sum_{v \in c^{-1}(i)} s^{\lambda(v)} t^v,$$

where $t = (t_1, \dots, t_m)$ and $t^v = t_1^{v_1} \dots t_m^{v_m}$. Choosing a real number a_i for each color $i \in [m+1]$ defines a *Wronski polynomial*

$$\mathcal{F}_{P^\lambda, s}(t) = a_0 F_{P^\lambda, 0, s}(t) + a_1 F_{P^\lambda, 1, s}(t) + \dots + a_m F_{P^\lambda, m, s}(t) \in \mathbb{R}[t_1, \dots, t_m],$$

for fixed $s \in (0, 1]$. A *Wronski system* associated with P^λ is a sparse system of m Wronski polynomials which is *generic* in the sense that it attains Kushnirenko's bound [21], that is, it has exactly $\nu(P)$ distinct complex solutions.

Let $M = |P \cap \mathbb{Z}^m|$ denote the number of integer points in P and let $\mathbb{C}\mathbb{P}^{M-1}$ be the complex projective space with coordinates $\{x_v \mid v \in P \cap \mathbb{Z}^m\}$. The toric projective variety $X_P \subset \mathbb{C}\mathbb{P}^{M-1}$ parameterized by the monomials $\{t^v \mid v \in P \cap \mathbb{Z}^m\}$ is given by the closure of the image of the map

$$(6) \quad \varphi_P : (\mathbb{C}^\times)^m \rightarrow \mathbb{C}\mathbb{P}^{M-1} : t \mapsto [t^v \mid v \in P \cap \mathbb{Z}^m],$$

where $[t^{v_1}, \dots, t^{v_m}]$ is a point in $\mathbb{C}\mathbb{P}^{M-1}$ written in homogeneous coordinates. Via φ_P a Wronski system on $(\mathbb{C}^\times)^m$ corresponds to a system of m linear equations on the toric variety $X_P \subset \mathbb{C}\mathbb{P}^{M-1}$.

Let $Y_P = X_P \cap \mathbb{R}\mathbb{P}^{M-1}$ be the real points of the variety X_P . For $s \in (0, 1]$ the s -*deformation* $s.Y_P$ is obtained as the closure of the image of the deformed map

$$s.\varphi_P : (\mathbb{C}^\times)^m \rightarrow \mathbb{C}\mathbb{P}^{M-1} : t \mapsto [s^{\lambda(v)} t^v \mid v \in P \cap \mathbb{Z}^m]$$

intersected with $\mathbb{R}\mathbb{P}^{M-1}$. The s -deformation $s.Y_P$ interpolates between $Y_P = 1.Y_P$ and its homotopic image $0.Y_P$, which is defined as the initial variety $\text{in}_\lambda(Y_P)$; the whole family $\{s.Y_P \mid s \in [0, 1]\}$ is called the *toric degeneration* of Y_P ; for the details see [27, Section 3]. A Wronski polynomial corresponds to the image of $s.Y_P$ under the linear *Wronski projection*

$$\begin{aligned} \mathbb{C}\mathbb{P}^{M-1} \setminus E &\rightarrow \mathbb{C}\mathbb{P}^m \\ \pi_E : [x_v \mid v \in P \cap \mathbb{Z}^m] &\mapsto \left[\sum_{v \in c^{-1}(i)} x_v \mid i = 0, 1, \dots, m \right] \end{aligned}$$

with *center*

$$E = \left\{ x \in \mathbb{C}\mathbb{P}^{M-1} \mid \sum_{v \in c^{-1}(i)} x_v = 0 \text{ for } i = 0, 1, \dots, m \right\}.$$

The toric degeneration *meets* the center of the projection π_E if there are $s \in (0, 1]$ and $t \in \mathbb{R}^m$ such that

$$F_{P^\lambda, 0, s}(t) = F_{P^\lambda, 1, s}(t) = \dots = F_{P^\lambda, m, s}(t) = 0.$$

The sphere \mathbb{S}^{M-1} is a double cover of $\mathbb{R}\mathbb{P}^{M-1}$. Let $Y_P^+ \subset \mathbb{S}^{M-1}$ be the pre-image of Y_P under the covering map. Note that Y_P^+ is not necessarily smooth nor connected. Nonetheless, its orientability is well defined. The following theorem is a slightly simplified version of what is proved in [27].

Theorem 5.1 (Soprunkova & Sottile). *Let $P \subset \mathbb{R}_{\geq 0}^m$ be a non-negative lattice m -polytope such that Y_P^+ is oriented, and let P^λ be an rdf-triangulation of P induced by the lifting function λ . Suppose that there is a number $s_0 \in (0, 1]$ such that the s -deformation $s.Y_P$ does not meet the center of the Wronski projection π_E for all $s \in (0, s_0]$ and all $t \in \mathbb{R}^m$. Then for all $s \in (0, s_0]$ the number of real solutions of any associated Wronski system in $\mathbb{R}[t_1, \dots, t_m]$ is bounded from below by the signature $\sigma(P^\lambda)$.*

In general, it seems difficult to decide the orientability of Y_P^+ . To this end Soprunova and Sottile suggest to consider the following sufficient condition: Let (A, b) be an integral facet description of $P = \{x \in \mathbb{R}^m \mid Ax + b \geq 0\}$ such that the i -th row of the matrix A is the unique inward pointing primitive normal vector of the i -th facet of P . This way, up to a re-ordering of the facets, A and b are uniquely determined. Denote by Λ_A the lattice spanned by the columns of A . Suppose that the lattice spanned by $P \cap \mathbb{Z}^m$ has odd index in \mathbb{Z}^m and that Λ_A has odd index in its saturation $\Lambda_A \otimes_{\mathbb{Z}} \mathbb{Q}$, that is, A has a maximal minor \tilde{A} with $\det \tilde{A}$ odd. If these two parity conditions are satisfied and if, additionally, there is a vector v with only odd entries in the integer column span of (A, b) then Soprunova and Sottile call the double cover Y_P^+ *Cox-oriented*.

We call the rdf-triangulation P^λ *nice* for the value s_0 if all the conditions of Theorem 5.1 are satisfied. Note that the (Cox-)orientability of Y_P^+ solely depends on the polytope P .

Example 5.2. The unique rdf-triangulation of the line segment $[k, l]$, where $0 \leq k < l$, is nice for $s_0 = 1$ (and any lifting function) if and only if $k = 0$. We have $\sigma([0, l]) \in \{0, 1\}$ depending on l being even or odd. This is a sharp lower bound for the number of real roots in the one-dimensional case.

Example 5.3. The staircase triangulation of $\Delta_m \times \Delta_n$ is nice for $s_0 = 1$. This is true at least if one of the two vertices whose color occurs only once is located at the origin.

Example 5.4. Let P^λ be an rdf-triangulation of a lattice polytope $P \subset \mathbb{R}_{\geq 0}^m$, and let Y_P^+ be Cox-oriented. The cone $0 * P^\lambda$ of the triangulation P^λ (embedded into \mathbb{R}^{m+1} via the map $(v_1, \dots, v_m) \mapsto (1, v_1, \dots, v_m)$) with apex $0 \in \mathbb{R}^{m+1}$ is nice for $s_0 = 1$. The signature of $0 * P^\lambda$ equals the signature of P^λ .

5.2. Products of Toric Varieties. Let us consider the *Segre embedding*

$$\begin{aligned} & \mathbb{C}P^{M-1} \times \mathbb{C}P^{N-1} \rightarrow \mathbb{C}P^{MN-1} \\ \iota : & ([x_1, \dots, x_M], [y_1, \dots, y_N]) \mapsto [x_1 y_1, \dots, x_i y_j, \dots, x_M y_N], \end{aligned}$$

which is the tensor product. The restriction $\iota : \mathbb{R}P^{M-1} \times \mathbb{R}P^{N-1} \rightarrow \mathbb{R}P^{MN-1}$ lifts to the double covers $\iota : \mathbb{S}^{M-1} \times \mathbb{S}^{N-1} \rightarrow \mathbb{S}^{MN-1}$.

Proposition 5.5. *Let P be an m -dimensional lattice polytope with M lattice points, and let Q be an n -dimensional lattice polytope with N lattice points. Then we have*

$$\iota(Y_P \times Y_Q) = Y_{P \times Q} \quad \text{and} \quad \iota(Y_P^+ \times Y_Q^+) = Y_{P^+ \times Q^+}.$$

Proof. Let $\varphi_P : (\mathbb{C}^\times)^m \rightarrow \mathbb{C}P^{M-1}$ denote the map in Equation (6) which defines the toric variety X_P . Observe that $\varphi_{P \times Q} = \iota \circ (\varphi_P, \varphi_Q)$. This readily implies $\iota(X_P \times X_Q) = X_{P \times Q}$ and also $\iota(Y_P \times Y_Q) = Y_{P \times Q}$. Now $\iota(Y_P^+ \times Y_Q^+) = Y_{P^+ \times Q^+}$ follows since the map ι lifts to the coverings. \square

Corollary 5.6. *Let P and Q be lattice polytopes such that Y_P^+ and Y_Q^+ are oriented. Then $Y_{P \times Q}^+$ is oriented.*

Proof. The orientability of $Y_{P \times Q}^+$ depends on the orientability of its smooth part, which is the ι -image of the product of the smooth parts of Y_P^+ and Y_Q^+ . The product of orientable manifolds is orientable. \square

Remark 5.7. As a further consequence, if Y_P^+ and Y_Q^+ are Cox-oriented, then $Y_{P \times Q}^+$ is oriented. However, $Y_{P \times Q}^+$ does not have to be Cox-oriented itself. For an example consider products $\Delta_m \times \Delta_n$ of standard simplices for m even and n odd.

The question under which conditions the toric degeneration of $Y_{P \times Q}$ meets the center of the Wronski projection is a little harder to answer. The lifting function ω determines the triangulation of $P \times Q$ and we write $(P \times Q)^\omega = P^\lambda \times_{\text{stc}} Q^\mu$ if we want to emphasize the particular lifting function ω defined in Equation (2). Recall that a vertex (v, w) of $(P \times Q)^\omega$ is colored $k = c_{P^\lambda}(v) + c_{Q^\mu}(w)$ where $c_{P^\lambda} : P \cap \mathbb{Z}^m \rightarrow [m+1]$ and $c_{Q^\mu} : Q \cap \mathbb{Z}^n \rightarrow [n+1]$ denote the coloring

maps; see Proposition 3.2. Therefore for $s \in (0, 1]$ the coefficient polynomial (Equation (5)) of $(P \times Q)^\omega$ for $k \in [m+n+1]$ has the form

$$\begin{aligned} F_{(P \times Q)^\omega, k, s}(t) &= \sum_{c_{P^\lambda}(v) + c_{Q^\mu}(w) = k} s^{\lambda(v) + \mu(w) + \epsilon(v, w)} t^{(v, w)} \\ &= \sum_{c_{P^\lambda}(v) + c_{Q^\mu}(w) = k} s^{\lambda(v)} (t_1, \dots, t_m)^v s^{\mu(w)} (t_{m+1}, \dots, t_{m+n})^w s^{\epsilon(v, w)}. \end{aligned}$$

As in Example 3.5 we may choose the same perturbation $\epsilon(i, j) = \epsilon 2^{(n+1)i + (n-j)}$ (for sufficiently small $\epsilon > 0$) for all vertices (v, w) with $c_{P^\lambda}(v) = i$ and $c_{Q^\mu}(w) = j$ if we choose color consecutive orderings of the vertices of P^λ and Q^μ ; see Equation (3). Summing over all colors i of P^λ and all colors j of Q^μ with $i + j = k$ yields

$$(7) \quad F_{(P \times Q)^\omega, k, s} = \sum_{i+j=k} F_{P^\lambda, i, s} F_{Q^\mu, j, s} s^{\epsilon(i, j)}.$$

The s -degeneration $s.Y_P$ meets the center of the Wronski projection in the points

$$V_s(P^\lambda) = \left\{ t \in \mathbb{R}^m \mid F_{P^\lambda, i, s}(t) = 0 \text{ for all } i \in [m+1] \right\},$$

the real variety generated by the coefficient polynomials of P^λ . Treating the parameter s as an additional indeterminate we arrive at

$$V(P^\lambda) = \left\{ (s, t) \in \mathbb{R}^{1+m} \mid F_{P^\lambda, i, s}(t) = 0 \text{ for all } i \in [m+1] \text{ and } s \in (0, 1] \right\}.$$

Lemma 5.8. *Choose color consecutive orderings of the vertices of P^λ and Q^μ . Then there is a lifting function ω of $P^\lambda \times_{\text{stc}} Q^\mu = (P \times Q)^\omega$, such that the points in the variety $V_s((P \times Q)^\omega)$ are exactly the points $(t, t') = (t_1, \dots, t_{m+n}) \in \mathbb{R}^{m+n}$ with $t \in V_s(P^\lambda)$ or $t' \in V_s(Q^\mu)$, that is,*

$$V_s((P \times Q)^\omega) = (V_s(P^\lambda) \times \mathbb{R}^n) \cup (\mathbb{R}^m \times V_s(Q^\mu)).$$

Remark 5.9. The variety $V_s(P^\lambda)$ may be infinite, in general.

Proof of Lemma 5.8. For a point $t \in V_s(P^\lambda)$ we have $(t, t') \in V_s((P \times Q)^\omega)$ for all $t' \in \mathbb{R}^n$ by Equation (7). Similarly we have $(t, t') \in V_s((P \times Q)^\omega)$ for $(s, t') \in V_s(Q^\mu)$ and all $t \in \mathbb{R}^m$.

For the reverse, let us assume there is a point $(t, t') \in V_s((P \times Q)^\omega)$ but $t \notin V_s(P^\lambda)$ and $t' \notin V_s(Q^\mu)$. Choose $i_0 \in [m+1]$ and $j_0 \in [n+1]$ minimal such that $F_{P^\lambda, i_0, s}(t) \neq 0$ and $F_{Q^\mu, j_0, s}(t') \neq 0$. Further let us assume $i_0 \geq j_0$. We prove by induction on i that $i_0 > m$, or alternatively that $F_{P^\lambda, i, s}(t) = 0$ for all $i \in [m+1]$, contradicting our assumption $t \notin V_s(P^\lambda)$.

We have $F_{P^\lambda, i, s}(t) = 0$ for all $i < j_0$. Note that this is also true for $j_0 = 0$. Now let $F_{P^\lambda, i', s}(t) = 0$ for all $i' < i$. Equation (7) yields for $k = i + j_0$

$$\begin{aligned} F_{(P \times Q)^\omega, i+j_0, s}(t, t') &= \sum_{i'+j'=i+j_0} F_{P^\lambda, i', s}(t) F_{Q^\mu, j', s}(t') s^{\epsilon(i', j')} \\ &= \sum_{i'+j'=i+j_0, i' < i} F_{P^\lambda, i', s}(t) F_{Q^\mu, j', s}(t') s^{\epsilon(i', j')} \\ &\quad + F_{P^\lambda, i, s}(t) F_{Q^\mu, j_0, s}(t') s^{\epsilon(i, j_0)} \\ &\quad + \sum_{i'+j'=i+j_0, i' > i} F_{P^\lambda, i', s}(t) F_{Q^\mu, j', s}(t') s^{\epsilon(i', j')} \\ &= 0, \end{aligned}$$

since we assumed $(t, t') \in V_s((P \times Q)^\omega)$.

We have $F_{P^\lambda, i', s}(t) = 0$ for $i' < i$ by induction and $i' > i$ implies $j < j_0$ hence $F_{Q^\mu, j, s}(t') = 0$ for $i' > i$. We are left with $F_{P^\lambda, i, s}(t) F_{Q^\mu, j_0, s}(t') s^{\epsilon(i, j_0)} = 0$ which in turn yields $F_{P^\lambda, i, s}(t) = 0$ since $s^{\epsilon(i, j_0)} > 0$ and $F_{Q^\mu, j_0, s}(t') \neq 0$; see Figure 7. \square

Now we are ready to state and prove our main result.

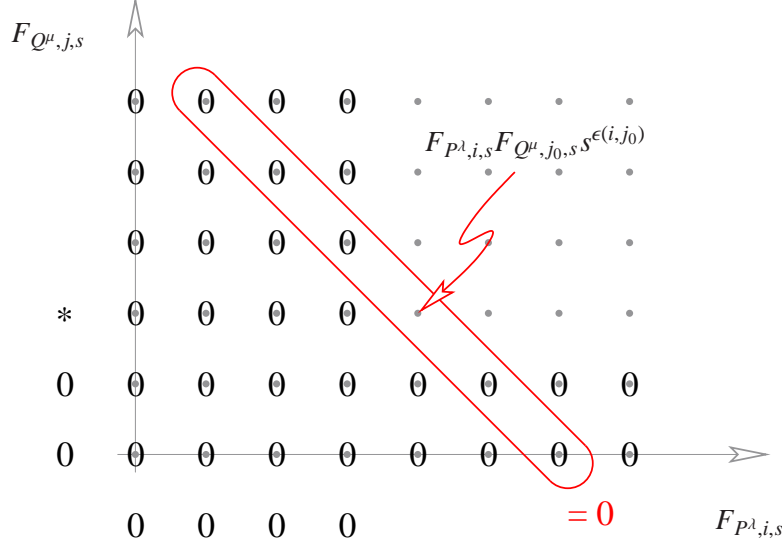

FIGURE 7. The inductive step in the proof of Lemma 5.8. Here * denotes the non-zero value of $F_{Q^\mu, j_0, s}(t')$.

Theorem 5.10 (Algebraic Product Theorem). *Let $P \subset \mathbb{R}_{\geq 0}^n$ and $Q \subset \mathbb{R}_{\geq 0}^n$ be non-negative full-dimensional lattice polytopes with rdf-triangulations P^λ and Q^μ which are nice for some value $s_0 \in (0, 1]$. Further choose any color consecutive vertex orderings for P^λ and Q^μ . Then there is a lifting function $\omega : (P \times Q) \cap \mathbb{Z}^{m+n} \rightarrow \mathbb{R}$ such that $(P \times Q)^\omega = P^\lambda \times_{\text{stc}} Q^\mu$ is nice for s_0 . Moreover, the number of real solutions of any Wronski polynomial system associated with $(P \times Q)^\omega$ is bounded from below by*

$$\sigma((P \times Q)^\omega) = \sigma_{m,n} \sigma(P^\lambda) \sigma(Q^\mu).$$

Proof. The orientability of $Y_{P \times Q}^+$ is a consequence of Corollary 5.6. Now Lemma 5.8 provides a lifting function $\omega : (P \times Q) \cap \mathbb{Z}^{m+n} \rightarrow \mathbb{R}$ of $P^\lambda \times_{\text{stc}} Q^\mu$ such that the s -degeneration $s.Y_{(P \times Q)^\omega}$ does not meet the center of the Wronski projection for $s \in (0, s_0]$ and $(t, t') \in \mathbb{R}^{m+n}$: Since $V_s(P^\lambda) = V_s(Q^\mu) = \emptyset$ for all $s \in (0, s_0]$ we have $V_s((P \times Q)^\omega) = (V_s(P^\lambda) \times \mathbb{R}^n) \cup (\mathbb{R}^m \times V_s(Q^\mu)) = \emptyset$ for all $s \in (0, s_0]$. The claim hence follows from Theorem 5.1 and our Combinatorial Product Theorem 4.5. \square

Remark 5.11. The decomposition $\sigma(P^\lambda \times_{\text{stc}} Q^\mu) = \sigma_{m,n} \sigma(P^\lambda) \sigma(Q^\mu)$ from Theorems 4.5 and 5.10 reflects the geometric situation in the following sense: Let $M = |P \cap \mathbb{Z}^m|$ and $N = |Q \cap \mathbb{Z}^n|$ denote the number of lattice points of P and Q , respectively. The Wronski projection $\pi_E : \mathbb{C}P^{M-1} \setminus E \rightarrow \mathbb{C}P^m$ (and its center E) depends solely on the lifting function $\lambda : \mathbb{R}^m \rightarrow \mathbb{R}$ which induces the rdf-triangulation P^λ on P . Hence we will denote the Wronski projection π_E associated with P^λ by π_{P^λ} , and its lifting to \mathbb{S}^{M-1} by $\pi_{P^\lambda}^+$. To give a lower bound on the number of real roots of the Wronski system associated with $(P \times Q)^\omega = P^\lambda \times_{\text{stc}} Q^\mu$ we have to bound the topological degree of the map $\pi_{(P \times Q)^\omega}^+$ restricted to $Y_{P \times Q}^+$. A decomposition of $\pi_{(P \times Q)^\omega}^+$ by the maps $\pi_{P^\lambda}^+$, $\pi_{Q^\mu}^+$, $\pi_{\Delta_m \times_{\text{stc}} \Delta_n}^+$, and the covers of the Segre embeddings is given by the following diagram which commutes provided that the lifting functions match as in Equation (3). Here the vertical arrows indicate the covers of the Segre embeddings of the appropriate dimensions.

$$\begin{array}{ccccccc}
 \mathbb{S}^{MN-1} & \longleftarrow & Y_{P \times Q}^+ & \xrightarrow{\pi_{(P \times Q)^\omega}^+} & \mathbb{S}^{m+n} & \xleftarrow{\pi_{\text{stc}, m, n}^+} & Y_{\Delta_m \times \Delta_n}^+ \hookrightarrow \mathbb{S}^{mn+m+n} \\
 \uparrow \iota & & \uparrow \iota & & & & \uparrow \iota \\
 \mathbb{S}^{M-1} \times \mathbb{S}^{N-1} & \longleftarrow & Y_P^+ \times Y_Q^+ & \xrightarrow{\pi_{P^\lambda} \times \pi_{Q^\mu}} & Y_{\Delta_m}^+ \times Y_{\Delta_n}^+ & \xlongequal{\quad} & \mathbb{S}^m \times \mathbb{S}^n
 \end{array}$$

This decomposition of $\pi_{(P \times Q)^\omega}^+$ yields the decomposition of $\sigma(P^\lambda \times_{\text{stc}} Q^\mu)$ given in the Theorems 4.5 and 5.10.

6. CUBES

We define the *signature* of a lattice polytope P , denoted as $\sigma(P)$, as the maximum of the signatures of all rdf-triangulations of P . The signature is undefined if P does not admit any such triangulation as in Example 4.1. However, here we are concerned with cubes, which do have rdf-triangulations: This is an immediate consequence of the Product Theorem 4.5 since $C_d = [0, 1]^d = I \times \cdots \times I$ can be triangulated as the d -fold simplicial product $I \times_{\text{stc}} \cdots \times_{\text{stc}} I$ with zero signature.

Since C_d does not contain any non-vertex lattice points, each lattice triangulation of C_d is dense. Note that C_d does have non-regular triangulations for $d \geq 4$; see De Loera [8].

6.1. Regular and Foldable Triangulations with Large Signature. Since the simplicial product of unimodular triangulations is again unimodular it follows that each d -fold simplicial product $I \times_{\text{stc}} \cdots \times_{\text{stc}} I$ has $d!$ facets, which is the maximum that can be obtained for the d -cube without introducing new vertices. On the other hand the minimal number of facets in a triangulation of C_d is known only for $d \leq 7$; see Anderson and Hughes [17]. The best currently known upper and lower bounds are due to Smith [26], Orden and Santos [22], and Bliss and Su [4]. For a recent survey on cubes, their triangulations, and related issues see Zong [30]. Rambau's program TOPCOM allows to enumerate all regular triangulations of C_d for $d \leq 4$ [23]. This then yields the following result.

Proposition 6.1. *We have $\sigma(C_1) = 1$, $\sigma(C_2) = 0$, $\sigma(C_3) = 4$, and $\sigma(C_4) = 2$.*

The cases of $C_1 = I$ and C_2 are trivial. The unique (regular and) foldable triangulation of C_3 with the maximal signature 4 is the unique minimal triangulation; it has one (black) facet of normalized volume 2 and four (white) facets of normalized volume 1.

There is one further ingredient which relies on an explicit construction, a triangulation of C_6 with a non-trivial signature. We give more details on our experiments in Section 6.3 below.

Proposition 6.2. *We have $\sigma(C_6) \geq 4$.*

Theorem 6.3. *The signature of C_d for $d \geq 3$ is bounded from below by*

$$\sigma(C_d) \geq \begin{cases} 2^{\frac{d+1}{2}} \left(\frac{d-1}{2}\right)! & \text{if } d \equiv 1 \pmod{2} \\ \left(\frac{d}{2}\right)! & \text{if } d \equiv 0 \pmod{4} \\ \frac{2}{3} \left(\frac{d}{2}\right)! & \text{if } d \equiv 2 \pmod{4}. \end{cases}$$

Proof. Let us start with the case d odd. Here for C_3 we choose the rdf-triangulation with signature 4 from Proposition 6.1. For $d \geq 5$ we factorize C_d as $C_2 \times C_{d-2}$ and choose a color consecutive vertex ordering for C_{d-2} . There is only one triangulation to choose for C_2 , but we take the symmetric ordering of the vertices; see Example 3.3. The signature of $\text{stc}_{2,d-2}$ equals $(d-1)/2$ by Proposition 4.3 and the second case of Proposition 4.6 inductively gives

$$\sigma(C_d) \geq 2 \sigma_{d-2,2} \sigma(C_{d-2}) \geq 2 \frac{d-1}{2} 2^{\frac{d-3}{2}} \left(\frac{d-3}{2}\right)! = 2^{\frac{d+1}{2}} \left(\frac{d-1}{2}\right)!.$$

If $d \equiv 0 \pmod{4}$ then we inductively prove that $\sigma(C_d) \geq \left(\frac{d}{2}\right)!$. The induction starts with $d = 4$ by Proposition 6.1. For $d \geq 8$ we decompose C_d as $C_4 \times C_{d-4}$. The signature of $\text{stc}_{4,d-4}$ equals $d(d-2)/8$ by Proposition 4.3. Choosing color consecutive orderings for C_4 and C_{d-4} Theorem 4.5 now yields

$$\sigma(C_d) \geq \sigma_{4,d-4} \sigma(C_4) \sigma(C_{d-4}) \geq \frac{d(d-2)}{8} 2 \left(\frac{d-4}{2}\right)! = \left(\frac{d}{2}\right)!.$$

In the remaining case where $d \equiv 2 \pmod{4}$ we construct C_d as a simplicial product of C_6 and C_{d-6} . By the explicit construction in Proposition 6.2 the signature of C_6 is at least 4. The signature of C_{d-6} is bounded from below by $(d-6)/2!$ as just proved. Proposition 4.3 yields $\sigma_{6,d-6} = \left(\frac{d}{3}\right)$, and Theorem 4.5 completes the proof:

$$\sigma(C_d) \geq \sigma_{6,d-6} \sigma(C_6) \sigma(C_{d-6}) \geq \frac{\frac{d}{2} \left(\frac{d}{2} - 1\right) \left(\frac{d}{2} - 2\right)}{3!} 4 \left(\frac{d}{2} - 3\right)! = \frac{2}{3} \left(\frac{d}{2}\right)!.$$

□

6.2. Nice Triangulations. Our main result, the Algebraic Product Theorem 5.10, asserts that the simplicial product of two nice triangulations P^λ and Q^μ is again nice, provided that the vertex ordering of P^λ and Q^μ are color consecutive. So what about the triangulations of the d -cube with signature in $\Omega(\lfloor d/2 \rfloor!)$ constructed in Section 6.1 above? Since the construction for d odd was based on the symmetric vertex ordering for the square, which is not color consecutive, Theorem 5.10 does not apply. The goal of this section is thus to construct nice cube rdf-triangulations from a decomposition into different factors.

The *geometric signature* $\sigma^+(P)$ of a lattice polytope P is defined as the maximum of the signatures of all rdf-triangulations of P which are nice for some parameter $s \in (0, 1]$. Clearly, $\sigma^+(P) \leq \sigma(P)$. Note that $Y_{C_d}^+$ is always oriented by Corollary 5.6 since $C_d = I \times I \times \cdots \times I$, and I is Cox-oriented.

Let us examine two cases of low dimension explicitly: There is a lifting function $C_3 \cap \mathbb{Z}^3 \rightarrow \mathbb{N}$ such that the induced triangulation is the unique minimal triangulation of the 3-cube from Proposition 6.1, and the toric degeneration meets the center only for $s = 1$; see [27]. This implies $\sigma^+(C_3) = 4$. In the subsequent Section 6.3 a triangulation C_4^λ of the 4-cube with signature equal to 2 is constructed explicitly via a lifting function $\lambda : C_4 \cap \mathbb{Z}^4 \rightarrow \mathbb{N}$. The variety $V(C_4^\lambda)$ (see Section 5.2), describing the values of s for which the center of the projection is met, consists of two isolated points for some $s_1 > 1$ and some $s_2 < 0$, hence C_4^λ is nice for any $s_0 \in (0, 1]$. A complete enumeration of all regular triangulation of C_4 shows that $\sigma^+(C_4) = 2$.

We want to avoid to split off factors which are squares, since neither of its two vertex orderings can be used for our purposes: The color consecutive vertex ordering has signature zero, and products with respect to the symmetric vertex ordering are not known to be nice. Hence we factorize

$$C_d = \begin{cases} C_1 \times C_{d-1} & \text{if } d \equiv 1 \pmod{4} \\ C_3 \times C_{d-3} & \text{if } d \equiv 3 \pmod{4}, \end{cases}$$

which means that we reduced the cases $d \equiv 1 \pmod{4}$ and $d \equiv 3 \pmod{4}$ to the case $d \equiv 0 \pmod{4}$. Proposition 4.3 and Theorem 4.5 yield for $d \equiv 1 \pmod{4}$

$$\sigma^+(C_d) \geq \sigma_{1,d-1} \sigma^+(C_1) \sigma^+(C_{d-1}) = \sigma^+(C_{d-1}) \geq \left(\frac{d-1}{2}\right)!.$$

For $d \equiv 3 \pmod{4}$ we have

$$\sigma^+(C_d) \geq \sigma_{3,d-3} \sigma^+(C_3) \sigma^+(C_{d-3}) \geq \frac{d-1}{2} 4 \left(\frac{d-3}{2}\right)! = 4 \left(\frac{d-1}{2}\right)! ,$$

and we obtain an overall lower bound in $\Omega(\lfloor d/2 \rfloor!)$ for the geometric signature of the d -cube. Observe that this lower bound for the signature in the case of d odd is significantly weaker than the bound given in Theorem 6.3, which does not take the geometric properties of the Wronski projection into account.

Corollary 6.4. *For $3 \leq d \not\equiv 2 \pmod{4}$ there are rdf-triangulations of the d -cube with signature at least $\lfloor d/2 \rfloor!$ which are nice for any $s_0 \in (0, 1)$.*

Proving that the triangulation of the 6-cube with signature 4 from Proposition 6.2 (together with its generating lifting function) is nice for some $s_0 \in (0, 1]$ would also settle the $d \equiv 2 \pmod{4}$ case. However, with the techniques of Section 6.3 one needs to solve a system of seven polynomials in the seven unknowns s, x_1, \dots, x_6 of maximal total degree 386; see Problem 6.7. This is beyond the scope of this paper.

6.3. Constructions and Computer Experiments. We completely enumerated all regular triangulations of the d -cube C_d up to symmetry using TOPCOM [23]. These 235,277 triangulations were then checked whether they are foldable by polymake [11, 12, 13]; it turns out that their total number is 454. For all the foldable ones we computed the signature, and we found 36 triangulations with signature 2, all other foldable triangulations of C_d have a vanishing signature.

The regularity of Example 6.5 was independently verified by the explicit construction of a lifting function.

Example 6.5. We now give an explicit description of an rdf-triangulation C_4^λ of the 4-cube with signature two. To this end we encode the vertices of C_4 , that is, the 0/1-vectors of length 4 as the hexadecimal digits $0, 1, \dots, 9, a, b, c, d, e, f$. The lifting function λ and the vertex 5-coloring is given in Table 1. The facets of C_4^λ are listed in Table 2, and the f -vector reads $(16, 64, 107, 81, 23)$.

TABLE 1. The vertex 5-coloring c and a lifting function λ for C_4^λ described in Example 6.5. The vertices of the first facet 01248 are chosen as the colors.

v	0	1	2	3	4	5	6	7	8	9	a	b	c	d	e	f
$\lambda(v)$	0	0	0	4	0	2	8	8	10	11	19	19	10	19	24	31
$c(v)$	0	1	2	4	4	0	0	1	8	2	1	0	2	4	4	8

TABLE 2. Facets of the triangulation C_4^λ .

01248	12358	12458	13589	2378b	23578	24578	24678
2678e	278be	28abe	35789	3789b	4578c	4678c	5789d
578cd	678ce	789bd	78bcd	78bce	7bcef	7bcd f	

As mentioned before, the double cover $Y_{C_d}^+$ of the associated real toric variety of the d -cube is indeed oriented for all dimensions d . To prove that C_4^λ is nice for any $s_0 \in (0, 1]$ we examine the variety $V(C_4^\lambda)$, describing the values of s for which the center of the projection is met; see Section 5.2. The variety $V(C_4^\lambda)$ is the solution set of the ideal $I(C_4^\lambda)$ generated by the five coefficient polynomials

$$\begin{aligned}
 F_{C_4^\lambda,0,s} &= 1 + s^2 x_1 x_3 + s^8 x_2 x_3 + s^{19} x_1 x_2 x_4, \\
 F_{C_4^\lambda,1,s} &= x_1 + s^8 x_1 x_2 x_3 + s^{19} x_2 x_4, \\
 F_{C_4^\lambda,2,s} &= x_2 + s^{10} x_3 x_4 + s^{11} x_1 x_4, \\
 F_{C_4^\lambda,3,s} &= x_3 + s^4 x_1 x_2 + s^{19} x_1 x_3 x_4 + s^{24} x_2 x_3 x_4, \text{ and} \\
 F_{C_4^\lambda,4,s} &= x_4 + s^{31} x_1 x_2 x_3 x_4.
 \end{aligned}$$

For the lexicographical ordering $x_4 > x_3 > x_2 > x_1 > s$ a Gröbner basis of $I(C_4^\lambda)$ reads (computed by MAGMA [6])

$$\{ x_4 + g_4(s), x_3 + g_3(s), x_2 + g_2(s), x_1 + g_1(s), g_s(s) \},$$

for certain polynomials $g_s, g_1, \dots, g_4 \in \mathbb{Q}[s]$. The polynomial $g_s(s)$ is displayed in Figure 8, and the others are by far too large to be listed. The essential feature of this Gröbner basis is that knowing the (real) roots of the polynomial $g_s(s)$ of degree 444 allows to compute the values for x_1, \dots, x_4 directly.

TABLE 3. Approximate coordinates for the two points in the variety $V(C_4^\lambda)$.

s	-0.9955941875452	1.0003839818262
x_1	1.3469081499925	-1.1340421741317
x_2	0.7663015145691	-1.8447577233888
x_3	1.1109881050869	-0.4723488390037
x_4	3.4823714929884	-1.1436761629897

It turns out that $g_s(s)$ has exactly two real roots s_1 and s_2 with $s_1 > 1$ and $-1 < s_2 < 0$. Given $g_s(s)$ this can be verified with any standard computer algebra program by computing all 444 distinct (complex) solutions. Additionally, this was counter-checked via Collins' method

$$\begin{aligned}
& s^{444} - 2s^{418} - 4s^{417} - 4s^{415} - 2s^{412} - 6s^{401} + s^{400} - s^{399} - 5s^{398} + 5s^{397} + 3s^{396} - 6s^{394} + 3s^{393} + \\
& 3s^{392} - 4s^{391} + 5s^{390} + 10s^{389} + 10s^{388} + 12s^{386} + 8s^{385} + 5s^{383} + 13s^{380} + 4s^{379} - 15s^{375} + 31s^{374} - \\
& 8s^{373} + 14s^{372} + 29s^{371} - 32s^{370} + 19s^{369} + 29s^{368} - 28s^{367} + 4s^{366} + 45s^{365} - 18s^{364} - 8s^{363} + \\
& 42s^{362} - 12s^{361} - 20s^{360} - 6s^{359} - 13s^{358} - 26s^{357} - 12s^{356} + 24s^{355} - 17s^{354} - 87s^{353} + 21s^{352} + \\
& 5s^{351} - 59s^{350} + 131s^{349} + 36s^{348} - 125s^{347} + 142s^{346} - 36s^{345} - 86s^{344} + 46s^{343} - 113s^{342} - \\
& 4s^{341} + 20s^{340} - 131s^{339} + 43s^{338} + 43s^{337} - 142s^{336} - 55s^{335} - 7s^{334} - 60s^{333} + 124s^{332} + 56s^{331} - \\
& 54s^{330} + 23s^{329} + 13s^{328} - 202s^{327} + 84s^{326} + 185s^{325} - 292s^{324} + 32s^{323} + 191s^{322} - 189s^{321} - \\
& 20s^{320} - 77s^{319} - 147s^{318} + 104s^{317} - 188s^{316} - 93s^{315} + 467s^{314} - 50s^{313} - 269s^{312} + 236s^{311} + \\
& 29s^{310} - 433s^{309} + 349s^{308} + 203s^{307} - 449s^{306} + 74s^{305} + 178s^{304} + 69s^{303} - 165s^{302} - 260s^{301} + \\
& 625s^{300} - 455s^{299} - 430s^{298} + 1018s^{297} - 661s^{296} - 493s^{295} + 1170s^{294} - 790s^{293} - 411s^{292} + \\
& 1222s^{291} - 432s^{290} - 201s^{289} + 605s^{288} - 624s^{287} + 243s^{286} + 938s^{285} - 352s^{284} - 553s^{283} + \\
& 1328s^{282} - 560s^{281} - 1343s^{280} + 1506s^{279} - 1263s^{278} - 826s^{277} + 1988s^{276} - 1423s^{275} + \\
& 828s^{274} + 2093s^{273} - 1779s^{272} + 1129s^{271} + 686s^{270} - 2280s^{269} + 1292s^{268} + 938s^{267} - \\
& 1279s^{266} - 48s^{265} + 1606s^{264} - 595s^{263} - 1445s^{262} + 1409s^{261} - 876s^{260} - 1256s^{259} + 1340s^{258} + \\
& 325s^{257} + 1433s^{256} + 29s^{255} + 571s^{254} + 1933s^{253} - 3175s^{252} + 181s^{251} + 1768s^{250} - 3124s^{249} + \\
& 1204s^{248} + 432s^{247} - 1215s^{246} + 2103s^{245} - 683s^{244} - 521s^{243} + 786s^{242} - 1184s^{241} - 355s^{240} + \\
& 1889s^{239} + 1888s^{238} - 2616s^{237} + 3311s^{236} + 2553s^{235} - 6876s^{234} + 3628s^{233} + 886s^{232} - \\
& 6562s^{231} + 4543s^{230} - 1364s^{229} - 2218s^{228} + 5371s^{227} - 2353s^{226} + 292s^{225} + 2304s^{224} - \\
& 2830s^{223} + 540s^{222} + 1685s^{221} + 641s^{220} - 2651s^{219} + 3260s^{218} + 2777s^{217} - 6771s^{216} + \\
& 3916s^{215} + 837s^{214} - 6602s^{213} + 4239s^{212} - 2085s^{211} - 611s^{210} + 4945s^{209} - 3172s^{208} + \\
& 3461s^{207} + 978s^{206} - 4176s^{205} + 3841s^{204} - 909s^{203} - 2110s^{202} + 416s^{201} + 789s^{200} + 1019s^{199} - \\
& 2635s^{198} + 1849s^{197} + 595s^{196} - 3099s^{195} + 859s^{194} - 1946s^{193} + 2463s^{192} + 870s^{191} - \\
& 2980s^{190} + 6933s^{189} - 1758s^{188} - 4228s^{187} + 6606s^{186} - 2718s^{185} - 4392s^{184} + 2695s^{183} - \\
& 875s^{182} - 1806s^{181} + 455s^{180} + 1139s^{179} - 1102s^{178} - 156s^{177} + 846s^{176} - 2773s^{175} + 2989s^{174} + \\
& 43s^{173} - 3244s^{172} + 5688s^{171} - 1833s^{170} - 3051s^{169} + 5638s^{168} - 2460s^{167} - 3614s^{166} + \\
& 2791s^{165} - 1135s^{164} - 2479s^{163} + 796s^{162} + 1119s^{161} - 1792s^{160} - 403s^{159} + 1850s^{158} - \\
& 1662s^{157} + 756s^{156} + 588s^{155} - 1355s^{154} + 2376s^{153} - 1103s^{152} - 1312s^{151} + 3206s^{150} - \\
& 1518s^{149} - 2313s^{148} + 1869s^{147} - 343s^{146} - 1914s^{145} + 575s^{144} + 1203s^{143} - 1568s^{142} - \\
& 506s^{141} + 1542s^{140} - 753s^{139} - 540s^{138} + 759s^{137} - 254s^{136} + 119s^{135} + 24s^{134} - 68s^{133} + \\
& 692s^{132} - 463s^{131} - 306s^{130} + 156s^{129} - 209s^{128} - 127s^{127} + 94s^{126} + 215s^{125} - 444s^{124} + \\
& 15s^{123} + 274s^{122} - 211s^{121} - 339s^{120} + 240s^{119} - 159s^{118} - 132s^{117} + 133s^{116} + 127s^{115} + 49s^{114} - \\
& 173s^{113} + 197s^{112} - 114s^{111} - 180s^{110} + 203s^{109} + 78s^{108} - 109s^{107} - 53s^{106} + 191s^{105} - 80s^{104} - \\
& 20s^{103} - 160s^{102} + s^{101} - 191s^{100} - 75s^{99} + 15s^{98} + 61s^{97} - 57s^{96} + 43s^{94} + 2s^{93} - 34s^{92} + 43s^{91} + \\
& 10s^{90} - 27s^{89} - 2s^{88} + 44s^{87} - 38s^{86} + 70s^{85} - 105s^{84} - 16s^{83} - 83s^{82} - 31s^{81} - 25s^{80} + 44s^{79} - \\
& 89s^{78} + 28s^{77} - 15s^{76} + 16s^{75} - 23s^{74} + 24s^{73} - 11s^{72} - 9s^{71} + 14s^{70} - s^{69} + 2s^{68} + 20s^{67} - 29s^{66} - \\
& 8s^{65} - 16s^{64} - 20s^{63} + 6s^{62} + 18s^{61} - 42s^{60} + 10s^{59} - s^{57} - 18s^{56} + 16s^{55} - 19s^{54} - 3s^{53} + 3s^{52} + \\
& 5s^{51} + 3s^{49} - 5s^{48} + s^{47} - 2s^{46} - 3s^{45} + 2s^{44} + 6s^{43} - 9s^{42} + 2s^{41} - 6s^{38} + 4s^{37} - 15s^{36} + 2s^{33} - 6s^{18} - 1
\end{aligned}$$

FIGURE 8. The polynomial $g_s(s)$ of the Gröbner basis of $I(C_4^\lambda)$.

of cylindrical algebraic decomposition [7], as implemented in QEPCAD [16]. Approximate values for the two real zeroes of g_s are given in Table 3. It follows that C_4^λ is nice for any $s_0 \in (0, 1]$.

While, with current computers, it seems to be out of reach to completely enumerate all triangulations of most polytopes in dimension 5 and beyond, TOPCOM can still be used to enumerate large numbers of triangulations. We let TOPCOM compute altogether 59,083 different triangulations which originate from randomly chosen placing triangulations by successive flipping. Not a single triangulation among these was foldable. Next we took the triangulation of C_5 with signature 16 that comes from Theorem 6.3 and we inspected 102,184 triangulations by random flipping. This way we found only two more foldable triangulations, one with signature 14 and a second one with signature 16.

For C_6 the situation is more complicated. None of our results so far directly yields any foldable triangulation with a positive signature: All the simplicial product triangulations of C_6 arising from decomposing C_6 as a product of two (or more) cubes of smaller dimensions do not yield

a non-trivial lower bound since at least one factor vanishes in the corresponding expressions in Proposition 4.6 and Theorem 4.5. And, as can be expected from the 5-dimensional case, TOPCOM did not find a foldable triangulation with a positive signature either. Therefore we took a detour in that we used TOPCOM to study triangulations of the product of the 4-simplex and the square. This time we were lucky to find a foldable triangulation with signature 2, which also turned out to be regular.

Proposition 6.6. *We have $\sigma(\Delta_4 \times C_2) \geq 2$*

In the sequel we denote this rdf-triangulation of $\Delta_4 \times C_2$ with signature 2 by S , and let C_4^λ be the rdf-triangulation of C_4 with signature 2 from Proposition 6.1. Then the product $C_6 = C_4 \times C_2$ inherits a polytopal subdivision into facets of type $\Delta_4 \times C_2$ from C_4^λ . Each of these facets can now be triangulated using S in such a way that one obtains an rdf-triangulation of C_6 with signature 4. Its f -vector equals (64, 656, 2640, 5298, 5676, 3115, 690). This establishes Proposition 6.2.

Problem 6.7. In order to decide whether the triangulation of C_6 from Proposition 6.2 (together with its generating lifting function) is nice for some $s_0 \in (0, 1]$, it suffices to prove that the real variety generated by

$$\begin{aligned}
 F_{C_{6,0},s} &= 1 + s^2 x_5 x_6 + s^8 x_1 x_6 + s^{55} x_1 x_3 + s^{57} x_1 x_3 x_5 x_6 + s^{124} x_2 x_3 + s^{151} x_2 x_3 x_5 x_6 + \\
 &\quad s^{157} x_1 x_2 x_3 x_6 + s^{197} x_1 x_2 x_4 + s^{218} x_2 x_4 x_6 + s^{224} x_1 x_2 x_4 x_5 x_6, \\
 F_{C_{6,1},s} &= x_6 + s^4 x_1 x_5 + s^{41} x_2 x_5 x_6 + s^{55} x_1 x_3 x_6 + s^{122} x_1 x_4 x_5 x_6 + s^{128} x_1 x_2 x_3 x_5 + \\
 &\quad s^{149} x_2 x_3 x_6 + s^{167} x_3 x_4 x_5 x_6 + s^{189} x_2 x_4 x_5 + s^{222} x_1 x_2 x_4 x_6, \\
 F_{C_{6,2},s} &= x_5 + s^8 x_1 x_5 x_6 + s^{55} x_1 x_3 x_5 + s^{124} x_2 x_3 x_5 + s^{157} x_1 x_2 x_3 x_5 x_6 + s^{197} x_1 x_2 x_4 x_5 + \\
 &\quad s^{218} x_2 x_4 x_5 x_6, \\
 F_{C_{6,3},s} &= x_1 + s^8 x_2 x_5 + s^{35} x_3 x_6 + s^{55} x_4 x_5 x_6 + s^{89} x_1 x_4 x_5 + s^{92} x_1 x_2 x_6 + s^{124} x_1 x_2 x_3 + \\
 &\quad s^{134} x_3 x_4 x_5 + s^{185} x_2 x_4 + s^{218} x_1 x_3 x_4 x_6 + s^{311} x_2 x_3 x_4 x_6 + s^{380} x_1 x_2 x_3 x_4 x_5 x_6, \\
 F_{C_{6,4},s} &= x_2 + s^{10} x_3 x_5 + s^{39} x_4 x_6 + s^{67} x_1 x_2 x_5 + s^{81} x_1 x_4 + s^{126} x_3 x_4 + s^{193} x_1 x_3 x_4 x_5 + \\
 &\quad s^{286} x_2 x_3 x_4 x_5 + s^{364} x_1 x_2 x_3 x_4 x_6, \\
 F_{C_{6,5},s} &= x_3 + s^{12} x_4 x_5 + s^{37} x_2 x_6 + s^{57} x_1 x_2 + s^{118} x_1 x_4 x_6 + s^{163} x_3 x_4 x_6 + s^{183} x_1 x_3 x_4 + \\
 &\quad s^{276} x_2 x_3 x_4 + s^{337} x_1 x_2 x_3 x_4 x_5, \text{ and} \\
 F_{C_{6,6},s} &= x_4 + s^{49} x_3 x_5 x_6 + s^{106} x_1 x_2 x_5 x_6 + s^{325} x_1 x_2 x_3 x_4 + s^{325} x_2 x_3 x_4 x_5 x_6 + \\
 &\quad s^{232} x_1 x_3 x_4 x_5 x_6
 \end{aligned}$$

is empty for all $s \in (0, s_0]$. We leave this as an open problem.

7. A FURTHER REMARK AND SEVERAL ACKNOWLEDGMENTS

Triangulations of the rectangular grid $G_{k,l} = [0, k] \times [0, l]$ are an interesting subject of its own; see, for instance, Kaibel and Ziegler [20] and the references there. Note that each triangulation of the grid is dense if and only if it is unimodular. Even without the assumption of regularity we do not know of a single dense and foldable triangulation of $G_{k,l}$ with a positive signature.

Problem 7.1. For which parameters k and l , if any, does the rectangular grid $G_{k,l}$ admit a unimodular and foldable triangulation with a positive signature?

Till Stegers helped with Gröbner bases computations. Chris W. Brown gave a first computer based proof of the fact that the variety $V(C_4^\lambda)$ consists of two isolated points via QEPCAD [16], and he also provided our approximate coordinates. Frank Sottile helped us to a better understanding of the geometric situation. In particular, he noticed that the product of two Cox-orientable lattice polytopes is not necessarily Cox-orientable. Two referees gave very useful comments on a previous version. We are indebted to all of them. Finally, we are grateful to Thorsten Theobald for stimulating discussions on the subject.

REFERENCES

1. Margaret M. Bayer, *Equidecomposable and weakly neighborly polytopes*, Israel J. Math. **81** (1993), no. 3, 301–320. MR **MR1231196** (**94m**:52015)
2. Louis J. Billera and Anders Björner, *Face numbers of polytopes and complexes*, Handbook of discrete and computational geometry (Jacob E. Goodman and Joseph O'Rourke, eds.), CRC Press Series on Discrete Mathematics and its Applications, CRC Press, 1997, pp. 407–430.
3. Louis J. Billera, R. Cushman, and J. A. Sanders, *The Stanley decomposition of the harmonic oscillator*, Nederl. Akad. Wetensch. Indag. Math. **50** (1988), no. 4, 375–393. MR **MR976522** (**89m**:13013)
4. Adam Bliss and Francis Edward Su, *Lower bounds for simplicial covers and triangulations of cubes*, Discrete Comput. Geom. **33** (2005), no. 4, 669–686.
5. Florian Block and Josephine Yu, *Tropical convexity via cellular resolutions*, arXiv:math.MG/0503279, 2005.
6. John Cannon et al., *Magma, version 2.11*, <http://magma.maths.usyd.edu.au/>, 2004.
7. George E. Collins, *Quantifier elimination for real closed fields by cylindrical algebraic decomposition*, Automata theory and formal languages (Second GI Conf., Kaiserslautern, 1975), Springer, Berlin, 1975, pp. 134–183. Lecture Notes in Comput. Sci., Vol. 33. MR **MR0403962** (53 #7771)
8. Jesús A. De Loera, *Nonregular triangulations of products of simplices*, Discrete Comput. Geom. **15** (1996), no. 3, 253–264. MR **MR1380393** (**97i**:52017)
9. Mike Develin and Bernd Sturmfels, *Tropical convexity*, Doc. Math. **9** (2004), 1–27 and 205–206 (Erratum). MR **MR2054977** (**2005f**:52024)
10. Samuel Eilenberg and Norman Steenrod, *Foundations of algebraic topology*, Princeton University Press, Princeton, New Jersey, 1952. MR **MR0050886** (14,398b)
11. Ewgenij Gawrilow and Michael Joswig, *polymake, version 2.1.0: a software package for analyzing convex polytopes*, <http://www.math.tu-berlin.de/diskregeom/polymake>, 1997–2005, with contributions by Thilo Schröder and Nikolaus Witte.
12. ———, *polymake: a framework for analyzing convex polytopes*, Polytopes — Combinatorics and Computation (Gil Kalai and Günter M. Ziegler, eds.), Birkhäuser, 2000, pp. 43–74.
13. ———, *Geometric reasoning with polymake*, arXiv:math.CO/0507273, 2005.
14. Israel M. Gel'fand, Mikhail M. Kapranov, and Andrei V. Zelevinsky, *Discriminants, resultants, and multidimensional determinants*, Mathematics: Theory & Applications, Birkhäuser Boston Inc., Boston, MA, 1994. MR **MR1264417** (**95e**:14045)
15. Jacob Eli Goodman and Hironori Onishi, *Even triangulations of S^3 and the coloring of graphs*, Trans. Amer. Math. Soc. **246** (1978), 501–510. MR **MR515556** (**80a**:05092)
16. Hoon Hong et al., *QEPCAD B - quantifier elimination by partial cylindrical algebraic decomposition, version 1.9*, <http://www.cs.usna.edu/~qepcad/>, 2003.
17. Robert B. Hughes and Michael R. Anderson, *Simplexity of the cube*, Discrete Math. **158** (1996), no. 1-3, 99–150. MR **MR1411113** (**97g**:90083)
18. Ivan Izmistiev and Michael Joswig, *Branched coverings, triangulations, and 3-manifolds*, Adv. Geom. **3** (2003), no. 2, 191–225. MR **MR1967999** (**2004b**:57004)
19. Michael Joswig, *Projectivities in simplicial complexes and colorings of simple polytopes*, Math. Z. **240** (2002), no. 2, 243–259. MR **MR1900311** (**2003f**:05047)
20. Volker Kaibel and Günter M. Ziegler, *Counting lattice triangulations*, Surveys in combinatorics, 2003 (Bangor), London Math. Soc. Lecture Note Ser., vol. 307, Cambridge Univ. Press, Cambridge, 2003, pp. 277–307. MR **MR2011739** (**2004k**:05020)
21. A. G. Kushnirenko, *The Newton polyhedron and the number of solutions of a system of k equations in k unknowns*, Usp. Math. Nauk. **30** (1975), 266–267.
22. David Orden and Francisco Santos, *Asymptotically efficient triangulations of the d -cube*, Discrete Comput. Geom. **30** (2003), no. 4, 509–528. MR **MR2013970** (**2004i**:68231)
23. Jörg Rambau, *TOPCOM, version 0.13.2*, <http://www.uni-bayreuth.de/departments/wirtschaftsmathematik/rambau/TOP%COM/index.en.html>.
24. Francisco Santos, *A point set whose space of triangulations is disconnected*, J. Amer. Math. Soc. **13** (2000), no. 3, 611–637 (electronic). MR **MR1758756** (**2001f**:52026)
25. ———, *The Cayley trick and triangulations of products of simplices*, Integer points in polyhedra—geometry, number theory, algebra, optimization, Contemp. Math., vol. 374, Amer. Math. Soc., Providence, RI, 2005, pp. 151–177. MR **MR2134766**
26. Warren D. Smith, *A lower bound for the simplexity of the n -cube via hyperbolic volumes*, European J. Combin. **21** (2000), no. 1, 131–137, Combinatorics of polytopes. MR **MR1737333** (**2001c**:52004)
27. Evgenia Soprunova and Frank Sottile, *Lower bounds for real solutions to sparse polynomial systems*, Adv. Math. **204** (2006), no. 1, 116–151.
28. Richard P. Stanley, *Combinatorics and commutative algebra*, Progress in Mathematics, vol. 41, Birkhäuser Boston Inc., Boston, MA, 1983. MR **MR725505** (**85b**:05002)
29. Dennis E. White, *Sign-balanced posets*, J. Combin. Theory Ser. A **95** (2001), no. 1, 1–38. MR **MR1840476** (**2002e**:05151)

30. Chuanming Zong, *What is known about unit cubes*, Bull. Amer. Math. Soc. (N.S.) **42** (2005), no. 2, 181–211 (electronic). MR **MR2133310** (2006e:52036)

MICHAEL JOSWIG, FACHBEREICH MATHEMATIK, AG 7, TU DARMSTADT, 64289 DARMSTADT, GERMANY
E-mail address: joswig@mathematik.tu-darmstadt.de

NIKOLAUS WITTE, FACHBEREICH MATHEMATIK, AG 7, TU DARMSTADT, 64289 DARMSTADT, GERMANY
E-mail address: witte@math.tu-berlin.de