

ON ITERATED TWISTED TENSOR PRODUCTS OF ALGEBRAS

PASCUAL JARA MARTÍNEZ, JAVIER LÓPEZ PEÑA, FLORIN PANAITÉ, AND FRED VAN OYSTAEYEN

ABSTRACT. We introduce and study the definition, main properties and applications of iterated twisted tensor products of algebras, motivated by the problem of defining a suitable representative for the product of spaces in noncommutative geometry. We find conditions for constructing an iterated product of three factors, and prove that they are enough for building an iterated product of any number of factors. As an example of the geometrical aspects of our construction, we show how to construct differential forms and involutions on iterated products starting from the corresponding structures on the factors, and give some examples of algebras that can be described within our theory. We prove a certain result (called “invariance under twisting”) for a twisted tensor product of two algebras, stating that the twisted tensor product does not change when we apply certain kind of deformation. Under certain conditions, this invariance can be iterated, containing as particular cases a number of independent and previously unrelated results from Hopf algebra theory.

INTRODUCTION

The difficulty of constructing concrete, nontrivial examples of noncommutative spaces starting from simpler ones is a common problem in all different descriptions of noncommutative geometry. If we think of the commutative situation, we have an easy procedure, the cartesian product, which allows us to generate spaces of dimension as big as we want from lower dimensional spaces. Thinking in terms of the existing dualities between the categories of spaces and the categories of (commutative) algebras, the natural replacement for the cartesian product of commutative spaces turns out to be the tensor product of commutative algebras. The tensor product has often been considered a replacement for the product of spaces represented by noncommutative algebras. As it was pointed out in [CSV95], this is a very restricted approach. If the “axiom” of noncommutative geometry consists in considering noncommutative algebras as the representatives for the algebras of functions over certain “quantum” spaces, hence assuming that two different measurements (or functions) on this kind of spaces do not commute to each other, then why should we assume that the measurements on the product commute to each other? There is no reason for imposing this artificial commutation, hence what we need is a “noncommutative” replacement of the tensor product of two algebras, which is supposed

Pascual Jara and Javier López have been partially supported by projects MTM2004-08125 and FQM-266 (Junta de Andalucía Research Group). Javier López has also been supported by the Spanish MEC FPU-grant AP2003-4340 and the European Science Foundation Programme on NONCOMMUTATIVE GEOMETRY (NOG). Florin Panaite and Fred Van Oystaeyen have been partially supported by the EC programme LIEGRITS, RTN 2003, 505078, and by the bilateral project “New techniques in Hopf algebras and graded ring theory”, of the Flemish and Romanian Ministries of Research. Florin Panaite has also been partially supported by the CEEEX programme of the Romanian Ministry of Education and Research, contract nr. CEx05-D11-11/2005 .

to fit better as an analogue of the product of two noncommutative spaces and in the same time to be a useful tool for overcoming the lack of examples formerly mentioned.

When we impose the natural restrictions a product should have, namely that it contains the factors in a natural way and having linear size equal to the product of the linear sizes of the factors, we arrive precisely at the definition of a twisted tensor product formerly studied by many people, either for the particular case of algebras (cf. [Tam90], [CSV95], [VDVK94]) or aiming to define similar structures for discrete groups, Lie groups, Lie algebras and Hopf algebras (as in [Tak81], [Maj90] and [Mic90]). Often, this structure appears in the so-called *factorization problem* of studying under what conditions we may write an object as a product of two subobjects having minimal intersection (see for instance the early paper [Maj90b]). From a purely algebraic point of view, twisted tensor products arise as a tool for building algebras starting with simpler ones, and also, as shown in [VDVK94], in close relation with certain nonlinear equations. Historically, the starting point of this theory was the “braided geometry” developed by Majid in the early 1990’s, including the “braided tensor product” of algebras in a braided monoidal category, of which the twisted tensor product of algebras is a sort of “local” version.

Whatever the chosen approach to twisted tensor products is, a number of examples of both classical and recently defined objects fits into this construction. Ordinary and graded tensor products, crossed products, Ore extensions and skew group algebras are just some examples of well-known constructions in classical ring theory that can be described as twisted tensor products. In the Hopf algebras and quantum groups area we find smash products, Drinfeld and Heisenberg doubles, and diagonal crossed products. With a more geometrical flavour, quantum planes and tori may be realized as noncommutative products of commutative spaces. And last, but not least, we may also find some physical models for which this structure is particularly well suited, such as the Fock space representations of a particle system with generalized statistics, which is studied in [BM00] using techniques which arise directly from the realisation of certain crossed enveloping algebras as twisted tensor products.

In the present work, our aim is to look at the twisted tensor product structure from a more geometrical point of view, regarding it as the natural representative for the cartesian product of noncommutative spaces. When we think of this construction geometrically, it becomes unnatural to restrict ourselves to take the product of only two spaces, so it appears the problem of finding suitable conditions that allow us to iterate the construction, and, whenever this is possible, to check that the obtained iterated product is “associative” in the same sense in which the usual tensor product is. Also, we will be interested in analyzing whether we may lift geometrical invariants that we are able to calculate on the single factors to the iterated twisted product and how to do this, if possible.

Being such an ubiquitous construction, there are several equivalent definitions of the twisted tensor product appearing in the literature, often using different names and notation. In the Preliminaries we recall some of the results we will use later on, fixing a unified notation. Concretely, we introduce the definition of a twisted tensor product $A \otimes_R B$ of two algebras A and B by means of a twisting map $R : B \otimes A \rightarrow A \otimes B$, whose existence is sufficient

for the existence of a deformed product in the tensor product vector space $A \otimes B$, and is also necessary when we impose unitality conditions.

In Section 2, we deal with the problem of iterating the twisted tensor products, and the lifting of several structures to the iteration, finding that for three given algebras A , B and C , and twisting maps $R_1 : B \otimes A \rightarrow A \otimes B$, $R_2 : C \otimes B \rightarrow B \otimes C$, $R_3 : C \otimes A \rightarrow A \otimes C$, a sufficient condition for being able to define twisting maps $T_1 : C \otimes (A \otimes_{R_1} B) \rightarrow (A \otimes_{R_1} B) \otimes C$ and $T_2 : (B \otimes_{R_2} C) \otimes A \rightarrow A \otimes (B \otimes_{R_2} C)$ associated to R_1 , R_2 and R_3 and ensuring that the algebras $A \otimes_{T_2} (B \otimes_{R_2} C)$ and $(A \otimes_{R_1} B) \otimes_{T_1} C$ are equal, can be given in terms of the twisting maps R_1 , R_2 and R_3 only. Namely, they have to satisfy the compatibility condition

$$(A \otimes_{R_2}) \circ (R_3 \otimes B) \circ (C \otimes R_1) = (R_1 \otimes C) \circ (B \otimes R_3) \circ (R_2 \otimes A).$$

This relation may be regarded as a “local” version of the hexagonal relation satisfied by the braiding of a (strict) braided monoidal category. We also prove that whenever the algebras and the twisting maps are unital, the compatibility condition is also necessary. As it happens for the classical tensor product, and for the twisted tensor product, the iterated twisted tensor product also satisfies a Universal Property, which we will state formally in Theorem 2.7. Once the conditions needed to iterate the construction of the twisted tensor product are fulfilled, we will prove the Coherence Theorem, stating that whenever one can build the iterated twisted product of any three factors, it is possible to construct the iterated twisted product of any number of factors, and that all the ways one might do this are essentially the same. This result will allow us to lift to any iterated product every property that can be lifted to three-factors iterated products. As applications of the former results we will characterize the modules over an iterated twisted tensor product, also giving a method to build some of them from modules given over each factor. As a first step towards our aim of building geometrical invariants over these structures, we will show how to build the algebras of differential forms and how to lift the involutions of $*$ -algebras to the iterated twisted tensor products.

In Section 3, we illustrate our theory by presenting some examples of different structures that arose in different areas of mathematics and can be constructed using our method. Two of them (the generalized smash products and diagonal crossed products) come from Hopf algebra theory, while the other two (the noncommutative $2n$ -planes defined by Connes and Dubois-Violette, and the observable algebra \mathcal{A} of Nill–Szlachányi) appear in a more geometrical or physical context. In particular, we show that the algebras defined by Connes and Dubois-Violette can be seen as (iterated) noncommutative products of commutative algebras (as it happens for the quantum planes and tori), and give a new proof of the fact that the algebra \mathcal{A} is an AF-algebra, proof which does not imply calculating any representation of it. We would like to point out that the earliest nontrivial example of an iterated twisted tensor product of algebras was given by Majid in [Maj90c], in the form of an iterated sequence of double cross products of certain bialgebras.

Section 4 (together with several results from Section 2), illustrates the fact that Hopf algebra theory represents not only a rich source of examples for the theory of twisted tensor products of algebras, but also a valuable source of inspiration for it. In this section we prove a result, called “invariance under twisting”, for a twisted tensor product of two algebras, which arose

as a generalization of the invariance under twisting for the Hopf smash product (hence the name). It states that if we start with a twisted tensor product $A \otimes_R B$ together with a certain kind of datum corresponding to it, we can deform the multiplication of A to a new algebra structure A^d , we can deform R to a new twisting map $R^d : B \otimes A^d \rightarrow A^d \otimes B$, so that the twisted tensor products $A^d \otimes_{R^d} B$ and $A \otimes_R B$ are isomorphic. It turns out that our result is general enough to include as particular cases some more independent results from Hopf algebra theory: the well-known theorem of Majid stating that the Drinfeld double of a quasitriangular Hopf algebra is isomorphic to an ordinary smash product, a recent result of Fiore–Steinacker–Wess from [FSW03] concerning a situation where a braided tensor product can be “unbraided”, and also a recent result of Fiore from [Fi02] concerning a situation where a smash product can be “decoupled” (this result in turn contains as a particular case the well-known fact that a smash product corresponding to a strongly inner action is isomorphic to the ordinary tensor product). We also prove that, under certain circumstances, our theorem can be iterated, containing thus, as a particular case, the invariance under twisting of the two-sided smash product from [BPVO].

Though we are mainly interested in results of geometrical nature, and hence most algebras we would like to work with are defined over the field \mathbb{C} of complex numbers, most of the results can be stated with no change for algebras over a field or commutative ring k , that we assume fixed throughout all the paper. All algebras will be supposed to be associative, and usually unital, k -algebras. The term *linear* will always mean k -linear, and the unadorned tensor product \otimes will stand for the usual tensor product over k . We will also identify every object with the identity map defined on it, so that $A \otimes f$ will mean $\text{Id}_A \otimes f$. For an algebra A we will write μ_A to denote the product in A and $u_A : k \rightarrow A$ its unit, and for an A -module M we will use λ_M to denote the action of A on M . For bialgebras and Hopf algebras we use the Sweedler-type notation $\Delta(h) = h_1 \otimes h_2$.

It is worth noting that the proofs of most of our main results are still valid if instead of considering algebras over k we take algebras in an arbitrary monoidally closed category.

1. PRELIMINARIES

1.1. Twisted tensor products of algebras. The notion of twisted tensor product of algebras has been independently discovered a number of times, and can be found in the literature under different names and notation. In this section we collect some results that will be used later, fixing a unified notation. Main references for definitions and proofs are [CSV95] and [VDVK94].

When dealing with spaces that involve a number of tensor products, notation often becomes obscure and complex. In order to overcome this difficulty, especially when dealing with iterated products, we will use a graphical braiding notation in which tangle diagrams represent morphisms in monoidal categories. For this braiding notation we refer to [RT90], [Maj94] and [Kas95].

In this notation, a linear map $f : A \rightarrow B$ is simply represented by $\begin{array}{c} A \\ \boxed{f} \\ B \end{array}$. The composition of morphisms can be written simply by placing the boxes corresponding to each morphism along

the same string, being the topmost box the corresponding to the map that is applied in the first place. Several strings placed aside will represent a tensor product of vector spaces (usually algebras), and a tensor product of two linear maps, $f \otimes g : A \otimes B \rightarrow C \otimes D$ will be written as



With this notation, some well-known properties of morphisms on tensor products become very intuitive. For instance, the identity $f \otimes g = (f \otimes D) \circ (A \otimes g) = (C \otimes g) \circ (f \otimes B)$ is written in braiding notation as

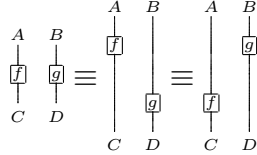

There are several special classes of morphisms that will receive a particular treatment. Namely, the identity will be simply written as a straight line (without any box on it), the algebra product will be denoted by . With this notation, the associativity of the algebra product can be written as:

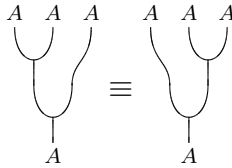

and the fact that $f : A \rightarrow B$ is an algebra morphism may be drawn as

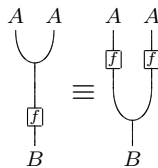

We will also adopt the convention of not writing the base field (or ring) whenever it appears as a factor (representing the fact that scalars can be pushed in or out every factor). According to this convention, the unit map of an algebra A is represented by , and the compatibility of the unit with the product and with algebra morphisms are respectively written as

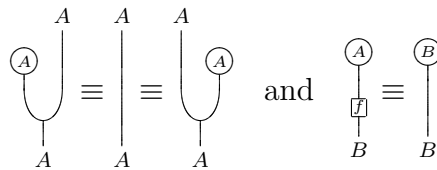

This conventions may also be applied to module morphisms. If M is a left A -module, we will denote by  the module action. Note that, in spite of the fact that the drawing is the same, there is no risk of confusing the module action with the algebra product, since the strings are labeled. Note that, for a morphism $f : M \rightarrow N$ of left A -modules, the module morphism

property is not written the same way as the algebra morphism property, but as

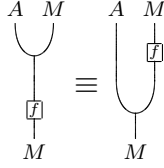

Recall that given two algebras A, B over k and $R : B \otimes A \rightarrow A \otimes B$ a k -linear map such that

$$(1.1) \quad R \circ (B \otimes \mu_A) = (\mu_A \otimes B) \circ (A \otimes R) \circ (R \otimes A),$$

$$(1.2) \quad R \circ (\mu_B \otimes A) = (A \otimes \mu_B) \circ (R \otimes B) \circ (B \otimes R),$$

then the application $\mu_R := (\mu_A \otimes \mu_B) \circ (A \otimes R \otimes B)$ is an associative product on $A \otimes B$. In this case, the map R is said to be a **twisting map**, and we will denote by $A \otimes_R B$ the algebra $(A \otimes B, \mu_R)$ that has $A \otimes B$ as underlying vector space, endowed with the product μ_R . If, using a Sweedler-type notation, we denote by $R(b \otimes a) = a_R \otimes b_R = a_r \otimes b_r$, for $a \in A, b \in B$, then (1.1) and (1.2) may be rewritten as:

$$(1.3) \quad (aa')_R \otimes b_R = a_R a'_r \otimes (b_R)_r,$$

$$(1.4) \quad a_R \otimes (bb')_R = (a_R)_r \otimes b_r b'_R.$$

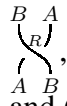
In braiding notation, we will represent a twisting map $R : B \otimes A \rightarrow A \otimes B$ by a crossing , where we will omit the label R when there is no risk of confusion, and equations (1.1) and (1.2) are represented respectively by

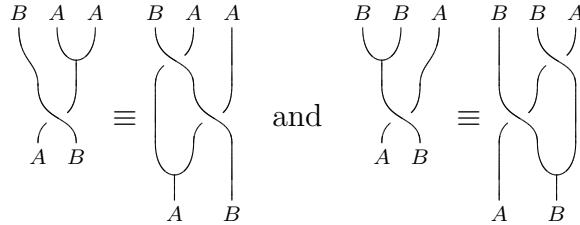

For further use, we record the following consequence of (1.3) and (1.4):

$$(1.5) \quad (aa')_R \otimes (bb')_R = (a_R)_{\mathcal{R}}(a'_r)_{\bar{\mathcal{R}}} \otimes (b_{\mathcal{R}})_{\bar{\mathcal{R}}}(b'_R)_{\mathcal{R}},$$

for all $a, a' \in A$ and $b, b' \in B$, where \mathcal{R} and $\bar{\mathcal{R}}$ are two more copies of R ; in braiding notation this last identity is written as:

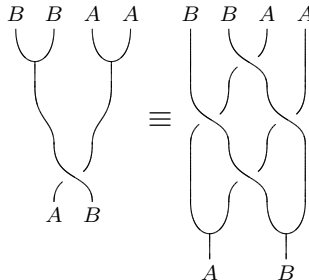

Whenever A and B are unital, if R is a twisting map that satisfies the extra conditions

$$(1.6) \quad \left. \begin{aligned} R(1 \otimes a) &= a \otimes 1 \\ R(b \otimes 1) &= 1 \otimes b \end{aligned} \right\}$$

then the canonical maps $i_A : A \rightarrow A \otimes_R B$ and $i_B : B \rightarrow A \otimes_R B$ defined by $i_A(a) := a \otimes 1$, $i_B(b) := 1 \otimes b$, are algebra morphisms, and $A \otimes_R B$ is a unital algebra, with unit $1 \otimes 1$. In this case, we say that R is a **unital twisting map**. Most of the twisting maps we will study are unital; however, it is worth noting that associativity constraints do not depend on the unitality of the twisting map. In braiding notation, the unitality conditions read

A special family of examples of twisting maps involves bijective maps. Concerning this situation, we can state the following result from [CMZ02], which will be used later:

Proposition 1.1. *Let $A \otimes_R B$ be a twisted tensor product of algebras such that the map R is bijective, and denote by $V : A \otimes B \rightarrow B \otimes A$ its inverse. Then V is also a twisting map and R is an algebra isomorphism between $B \otimes_V A$ and $A \otimes_R B$.*

In classical homological algebra, the usual tensor product is commonly introduced by means of its universal property, where the commutation between elements belonging to the first factor and elements belonging to the second one is implicitly required. In this property, we have to consider the canonical algebra monomorphisms $i_A : A \hookrightarrow A \otimes B$ and $i_B : B \hookrightarrow A \otimes B$ given by $i_A(a) := a \otimes 1$ and $i_B(b) := 1 \otimes b$ respectively. Because of the twisting map conditions, these maps are still algebra morphisms when we consider a twisted tensor product $A \otimes_R B$ instead of $A \otimes B$; moreover, twisted tensor products may be characterized as algebra structures defined on $A \otimes B$ such that the above maps are algebra inclusions and satisfying $a \otimes b = i_A(a)i_B(b)$ for all $a \in A, b \in B$. As a consequence, with a slight modification, that essentially involves replacing the usual flip by the twisting map, one may also state a universal property for twisted tensor products, as shown in [CIMZ00]:

Theorem 1.2. *Let A, B be two k -algebras, and let $R : B \otimes A \rightarrow A \otimes B$ be a unital twisting map. Given a k -algebra X , and algebra morphisms $u : A \rightarrow X, v : B \rightarrow X$ such that*

$$(1.7) \quad \mu_X \circ (v \otimes u) = \mu_X \circ (u \otimes v) \circ R,$$

then we can find a unique algebra map $\varphi : A \otimes_R B \rightarrow X$ such that

$$(1.8) \quad \varphi \circ i_A = u,$$

$$(1.9) \quad \varphi \circ i_B = v.$$

If A and B are $*$ -algebras with involutions j_A and j_B , and $R : B \otimes A \rightarrow A \otimes B$ is a twisting map such that

$$(1.10) \quad (R \circ (j_B \otimes j_A) \circ \tau) \circ (R \circ (j_B \otimes j_A) \circ \tau) = A \otimes B,$$

then $A \otimes_R B$ is a $*$ -algebra with involution $R \circ (j_B \otimes j_A) \circ \tau$, where $\tau : A \otimes B \rightarrow B \otimes A$ denotes the usual flip. Moreover, if R is unital, then i_A and i_B become $*$ -morphisms. This involutive condition is written down in braiding notation in the following way:

When we have a left A -module M , a left B -module N , a twisting map $R : B \otimes A \rightarrow A \otimes B$ and a linear map $\tau_{M,B} : B \otimes M \rightarrow M \otimes B$ such that

$$(1.11) \quad \tau_{M,B} \circ (\mu_B \otimes M) = (M \otimes \mu_B) \circ (\tau_{M,B} \otimes B) \circ (B \otimes \tau_{M,B}),$$

$$(1.12) \quad \tau_{M,B} \circ (B \otimes \lambda_M) = (\lambda_M \otimes B) \circ (A \otimes \tau_{M,B}) \circ (R \otimes M),$$

then the map $\lambda_{\tau_{M,B}} : (A \otimes_R B) \otimes (M \otimes N) \rightarrow M \otimes N$ defined by $\lambda_{\tau_{M,B}} := (\lambda_M \otimes \lambda_N) \circ (A \otimes \tau_{M,B} \otimes N)$ yields a left $(A \otimes_R B)$ -module structure on $M \otimes N$, which furthermore is compatible with the inclusion of A . In this case, we say that $\tau_{M,B}$ is a **(left) module twisting map**.

If we denote by $\begin{matrix} B & M \\ \curvearrowright & \\ M & B \end{matrix}$ the module twisting map, the module twisting conditions look the same as the twisting conditions for algebra twisting maps (replacing A by M). Unlike what happens for algebra twisting maps, usually is not enough to have a left $(A \otimes_R B)$ -module structure on $M \otimes N$ in order to recover a module twisting map. Some sufficient conditions for this to happen can be found in [CSV95]

Besides module lifting conditions, in [CSV95] is shown how to lift twisting maps to algebras of differential forms on them. More precisely:

Theorem 1.3. *Let A, B be two algebras. Then any twisting map $R : B \otimes A \rightarrow A \otimes B$ extends to a unique twisting map $\tilde{R} : \Omega B \otimes \Omega A \rightarrow \Omega A \otimes \Omega B$ which satisfies the conditions*

$$(1.13) \quad \tilde{R} \circ (d_B \otimes \Omega A) = (\varepsilon_A \otimes d_B) \circ \tilde{R},$$

$$(1.14) \quad \tilde{R} \circ (\Omega B \otimes d_A) = (d_A \otimes \varepsilon_B) \circ \tilde{R},$$

where d_A and d_B denote the differentials on ΩA and ΩB , and $\varepsilon_A, \varepsilon_B$ stand for the gradings on ΩA and ΩB , respectively. Moreover, $\Omega A \otimes_{\tilde{R}} \Omega B$ is a graded differential algebra with differential $d(\varphi \otimes \omega) := d_A \varphi \otimes \omega + (-1)^{|\varphi|} \varphi \otimes d_B \omega$.

Conditions (1.13) and (1.14) can be translated, in braiding notation, to the equalities

$$\begin{array}{ccc}
 \begin{array}{c} \Omega B \Omega A \\ \boxed{d_B} \\ \downarrow \\ \tilde{R} \\ \downarrow \\ \Omega A \Omega B \end{array} & \equiv & \begin{array}{c} \Omega B \Omega A \\ \tilde{R} \\ \downarrow \\ \boxed{\varepsilon_A} \quad \boxed{d_B} \\ \downarrow \\ \Omega A \Omega B \end{array} & \text{and} & \begin{array}{c} \Omega B \Omega A \\ \boxed{d_A} \\ \downarrow \\ \tilde{R} \\ \downarrow \\ \Omega A \Omega B \end{array} & \equiv & \begin{array}{c} \Omega B \Omega A \\ \tilde{R} \\ \downarrow \\ \boxed{d_A} \quad \boxed{\varepsilon_B} \\ \downarrow \\ \Omega A \Omega B \end{array}
 \end{array}$$

respectively.

1.2. The noncommutative planes of Connes and Dubois–Violette. The original definition of noncommutative 4–planes (and 3–spheres) arises from some K –theoretic equations, inspired by the properties of the Bott projector on the cohomology of classical spheres. We do not need this interpretation here, so we adopt directly the equivalent definition given by means of generators and relations. Any reader interested in full details on the construction and properties of noncommutative planes and spheres should look at [CDV02]. Our study will be centered on the noncommutative planes associated to critical points of the scaling foliation, as the definition of the noncommutative plane in these points is easily generalized to higher dimensional frameworks.

Let us then consider $\theta \in \mathcal{M}_n(\mathbb{R})$ an antisymmetric matrix, $\theta = (\theta_{\mu\nu})$, $\theta_{\nu\mu} = -\theta_{\mu\nu}$, and let $C_{alg}(\mathbb{R}^{2n}_\theta)$ be the associative algebra generated by $2n$ elements $\{z^\mu, \bar{z}^\mu\}_{\mu=1,\dots,n}$ with relations

$$(1.15) \quad \left. \begin{array}{l} z^\mu z^\nu = \lambda^{\mu\nu} z^\nu z^\mu \\ \bar{z}^\mu \bar{z}^\nu = \lambda^{\mu\nu} \bar{z}^\nu \bar{z}^\mu \\ \bar{z}^\mu z^\nu = \lambda^{\nu\mu} z^\nu \bar{z}^\mu \end{array} \right\} \forall \mu, \nu = 1, \dots, n, \text{ being } \lambda^{\mu\nu} := e^{i\theta_{\mu\nu}}.$$

Note that $\lambda^{\nu\mu} = (\lambda^{\mu\nu})^{-1} = \overline{\lambda^{\mu\nu}}$ for $\mu \neq \nu$, and $\lambda^{\mu\mu} = 1$ by antisymmetry.

We can now endow the algebra $C_{alg}(\mathbb{R}^{2n}_\theta)$ with the unique involution of \mathbb{C} –algebras $x \mapsto x^*$ such that $(z^\mu)^* = \bar{z}^\mu$. This involution gives a structure of $*$ –algebra on $C_{alg}(\mathbb{R}^{2n}_\theta)$. As a $*$ –algebra, $C_{alg}(\mathbb{R}^{2n}_\theta)$ is a deformation of the commutative algebra $C_{alg}(\mathbb{R}^{2n})$ of complex polynomial functions on \mathbb{R}^{2n} , and it reduces to it when we take $\theta = 0$. The algebra $C_{alg}(\mathbb{R}^{2n}_\theta)$ will be then referred to as the **(algebra of complex polynomial functions on the) noncommutative $2n$ –plane \mathbb{R}^{2n}_θ** . In fact, former relations define a deformation \mathbb{C}_θ^n of \mathbb{C}^n , so we can identify the noncommutative complex n –plane \mathbb{C}_θ^n with \mathbb{R}^{2n}_θ by writing $C_{alg}(\mathbb{C}_\theta^n) := C_{alg}(\mathbb{R}^{2n}_\theta)$.

We define $\Omega_{alg}(\mathbb{R}^{2n}_\theta)$, **the algebra of algebraic differential forms on the noncommutative plane \mathbb{R}^{2n}_θ** , to be the complex unital associative graded algebra

$$\Omega_{alg}(\mathbb{R}^{2n}_\theta) := \bigoplus_{p \in \mathbb{N}} \Omega_{alg}^p(\mathbb{R}^{2n}_\theta)$$

generated by $2n$ elements z^μ, \bar{z}^μ of degree 0, with relations:

$$\left. \begin{array}{l} z^\mu z^\nu = \lambda^{\mu\nu} z^\nu z^\mu \\ \bar{z}^\mu \bar{z}^\nu = \lambda^{\mu\nu} \bar{z}^\nu \bar{z}^\mu \\ \bar{z}^\mu z^\nu = \lambda^{\nu\mu} z^\nu \bar{z}^\mu \end{array} \right\} \forall \mu, \nu = 1, \dots, n, \text{ being } \lambda^{\mu\nu} := e^{i\theta_{\mu\nu}},$$

and by $2n$ elements $dz^\mu, d\bar{z}^\mu$ of degree 1, with relations:

$$(1.16) \quad \left. \begin{aligned} dz^\mu dz^\nu + \lambda^{\mu\nu} dz^\nu dz^\mu &= 0, & z^\mu dz^\nu &= \lambda^{\mu\nu} dz^\nu z^\mu, \\ d\bar{z}^\mu d\bar{z}^\nu + \lambda^{\mu\nu} d\bar{z}^\nu d\bar{z}^\mu &= 0, & \bar{z}^\mu d\bar{z}^\nu &= \lambda^{\mu\nu} d\bar{z}^\nu \bar{z}^\mu, \\ d\bar{z}^\mu dz^\nu + \lambda^{\nu\mu} dz^\nu d\bar{z}^\mu &= 0, & \bar{z}^\mu dz^\nu &= \lambda^{\nu\mu} dz^\nu \bar{z}^\mu, \\ dz^\mu d\bar{z}^\nu &= 0, & z^\mu d\bar{z}^\nu &= \lambda^{\nu\mu} d\bar{z}^\nu z^\mu, \end{aligned} \right\} \forall \mu, \nu = 1, \dots, n.$$

In this setting, there exists a unique differential d of $\Omega_{alg}(\mathbb{R}_\theta^{2n})$ (that is, an antiderivation of degree 1 such that $d^2 = 0$) which extends the mapping $z^\mu \mapsto dz^\mu, \bar{z}^\mu \mapsto d\bar{z}^\mu$. Indeed, such a differential is obtained by extending the definition on the generators according to the Leibniz rule. With this differential, $\Omega_{alg}(\mathbb{R}_\theta^{2n})$ becomes a graded differential algebra. It is also possible to extend the mapping $z^\mu \mapsto \bar{z}^\mu, dz^\mu \mapsto d\bar{z}^\mu =: \overline{(dz^\mu)}$ to the whole algebra $\Omega_{alg}(\mathbb{R}_\theta^{2n})$ as an antilinear involution $\omega \mapsto \bar{\omega}$ such that $\overline{\overline{\omega}} = (-1)^{pq} \omega' \bar{\omega}$ for any $\omega \in \Omega_{alg}^p(\mathbb{R}_\theta^{2n}), \omega' \in \Omega_{alg}^q(\mathbb{R}_\theta^{2n})$. For this extension we have that $d\bar{\omega} = \overline{d\omega}$.

Our interest in these algebras arises from the fact that the noncommutative 4-plane can easily be realized as a twisted tensor product of two commutative algebras (namely as a twisted product of two copies of $\mathbb{C}[x, \bar{x}]$, which is nothing but the algebra of polynomial functions on the complex plane), hence looking like the algebra representing a sort of *noncommutative cartesian product* of two commutative spaces. Our original interest in iterated twisted tensor products came when we asked ourselves about the possibility of looking at the $2n$ -noncommutative plane as a certain product of commutative algebras.

2. ITERATED TWISTED TENSOR PRODUCTS

In this section, our aim is to study the construction of iterated twisted tensor products. If we think of twisted tensor products as natural noncommutative analogues for the usual cartesian product of spaces, it is natural to require that the product of three or more spaces still respects every single factor.

Morally, the construction of a twisting map boils down to giving a rule for exchanging factors between the algebras involved in the product. A natural way for doing this would be to perform a series of two factors twists, that should be related to the already given notion of twisting map, and afterwards to apply algebra multiplication in each factor.

Suppose that A, B and C are algebras, let

$$\begin{aligned} R_1 &: B \otimes A \longrightarrow A \otimes B, \\ R_2 &: C \otimes B \longrightarrow B \otimes C, \\ R_3 &: C \otimes A \longrightarrow A \otimes C \end{aligned}$$

(unital) twisting maps, and consider now the application

$$T_1 : C \otimes (A \otimes_{R_1} B) \longrightarrow (A \otimes_{R_1} B) \otimes C$$

given by $T_1 := (A \otimes R_2) \circ (R_3 \otimes B)$. We can also build the map

$$T_2 : (B \otimes_{R_2} C) \otimes A \longrightarrow A \otimes (B \otimes_{R_2} C)$$

given by $T_2 = (R_1 \otimes C) \circ (B \otimes R_3)$. It is a natural question to ask if these maps are twisting maps. In general, this is not the case, as we will show in (Counter)example 2.2. In the following Theorem, we state necessary and sufficient conditions for this to happen.

Theorem 2.1. *With the above notation, the following conditions are equivalent:*

- (1) T_1 is a twisting map.
- (2) T_2 is a twisting map.
- (3) The maps R_1 , R_2 and R_3 satisfy the following compatibility condition (called the hexagon equation):

$$(2.1) \quad (A \otimes R_2) \circ (R_3 \otimes B) \circ (C \otimes R_1) = (R_1 \otimes C) \circ (B \otimes R_3) \circ (R_2 \otimes A),$$

that is, the following diagram is commutative.

$$\begin{array}{ccccc}
 & & C \otimes A \otimes B & \xrightarrow{R_3 \otimes B} & A \otimes C \otimes B \\
 & \nearrow^{C \otimes R_1} & & & \searrow^{A \otimes R_2} \\
 C \otimes B \otimes A & & & & & A \otimes B \otimes C \\
 & \searrow_{R_2 \otimes A} & & & \nearrow_{R_1 \otimes C} \\
 & & B \otimes C \otimes A & \xrightarrow{B \otimes R_3} & B \otimes A \otimes C
 \end{array}$$

Moreover, if all the three conditions are satisfied, then the algebras $A \otimes_{T_2} (B \otimes_{R_2} C)$ and $(A \otimes_{R_1} B) \otimes_{T_1} C$ are equal. In this case, we will denote this algebra by $A \otimes_{R_1} B \otimes_{R_2} C$.

PROOF We prove only the equivalence between (1) and (3), being the equivalence between (2) and (3) completely analogous.

3 \Rightarrow 1 Suppose that the hexagon equation is satisfied. In order to prove that T_1 is a twisting map, we have to check the conditions (1.1) and (1.2) for T_1 , namely, we have to check the relations

$$(2.2) \quad T_1 \circ (C \otimes \mu_{R_1}) = (\mu_{R_1} \otimes C) \circ (A \otimes B \otimes T_1) \circ (T_1 \otimes A \otimes B),$$

$$(2.3) \quad T_1 \circ (\mu_C \otimes A \otimes B) = (A \otimes B \otimes \mu_C) \circ (T_1 \otimes C) \circ (C \otimes T_1).$$

To prove this we use braiding notation. Taking into account that the hexagon equation is written as:

the proof of condition (2.2) is given by:

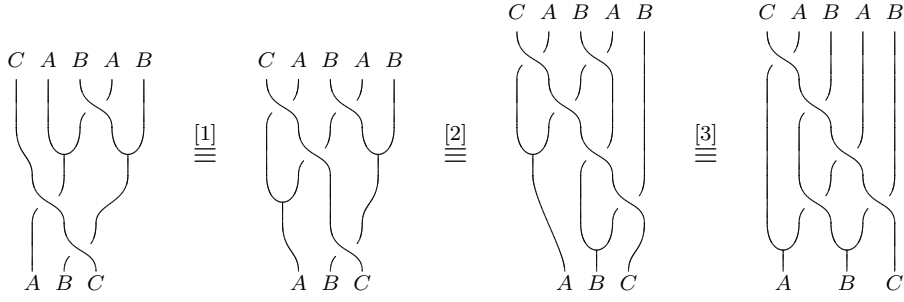

where in [1] we use the twisting condition for R_3 , in [2] we use the twisting condition for R_2 , and in [3] we use the hexagon equation. On the other hand, condition (2.3) is proven as follows:

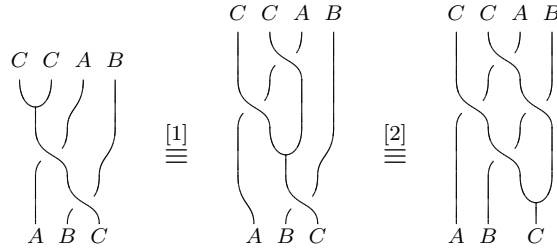

where now [1] is due to the twisting conditions for R_3 , and [2] to twisting conditions for R_2 . This proves that T_1 satisfies the pentagonal equations. Furthermore, if R_2 and R_3 are unital, then we have that

$$T_1(c \otimes 1 \otimes 1) = (A \otimes R_2)(R_3 \otimes B)(c \otimes 1 \otimes 1) = (A \otimes R_2)(1 \otimes c \otimes 1) = 1 \otimes 1 \otimes c,$$

$$T_1(1 \otimes a \otimes b) = (A \otimes R_2)(R_3 \otimes B)(1 \otimes a \otimes b) = (A \otimes R_2)(a \otimes 1 \otimes b) = a \otimes b \otimes 1,$$

so T_1 is also a unital twisting map.

1 \Rightarrow 3 Now we assume (2.2) and (2.3). It is enough to apply (2.2) to an element of the form $c \otimes 1 \otimes b \otimes a \otimes 1$ in order to recover the hexagon equation for a generic element $c \otimes b \otimes a$ of the tensor product $C \otimes B \otimes A$.

To finish the proof, assume that the three equivalent conditions are satisfied. To see that the algebras $A \otimes_{T_2} (B \otimes_{R_2} C)$ and $(A \otimes_{R_1} B) \otimes_{T_1} C$ are equal, it is enough to expand the expressions of the products

$$\mu_{T_2} = (\mu_A \otimes \mu_{R_2}) \circ (A \otimes T_2 \otimes B \otimes C),$$

$$\mu_{T_1} = (\mu_{R_1} \otimes \mu_C) \circ (A \otimes B \otimes T_1 \otimes C),$$

and realize that they are exactly the same application, for which we only have to observe that $(A \otimes B \otimes R_2) \circ (R_1 \otimes C \otimes B) = R_1 \otimes R_2 = (R_1 \otimes B \otimes C) \circ (B \otimes A \otimes R_2)$. \square

When three twisting maps satisfy the hypotheses of Theorem 2.1, we will say either that they are *compatible twisting maps*, or that the twisting maps satisfy the *hexagon (or braid) equation*. If the twisting maps R_i are not unital, the hexagon equation is still sufficient for getting associative products associated to T_1 and T_2 , but in general we need unitality to recover the compatibility condition from the associativity of the iterated products.

One could wonder whether the braid relation is automatically satisfied for any three unital twisting maps. This is not the case, as shown in the following example:

Example 2.2. Take H a noncocommutative (finite dimensional) bialgebra, $A = B = H^*$, $C = H$. Consider the left regular action of H on H^* given by $(h \rightharpoonup p)(h') := p(h'h)$; with this action, H^* becomes a left H -module algebra, so we can define the twisting map induced by the action as:

$$\begin{aligned} \sigma : H \otimes H^* &\longrightarrow H^* \otimes H \\ h \otimes p &\longmapsto (h_1 \rightharpoonup p) \otimes h_2. \end{aligned}$$

If we consider now the twisting maps $R_1 : B \otimes A \longrightarrow A \otimes B$, $R_2 : C \otimes B \longrightarrow B \otimes C$, $R_3 : C \otimes A \longrightarrow A \otimes C$, defined as $R_1 := \tau$, $R_2 = R_3 := \sigma$, being τ the usual flip, then the braid relation among R_1 , R_2 and R_3 boils down to the equality

$$(h_1 \rightharpoonup q) \otimes (h_2 \rightharpoonup p) \otimes h_3 = (h_2 \rightharpoonup q) \otimes (h_1 \rightharpoonup p) \otimes h_3,$$

for all $h \in H$, $p, q \in H^*$, but this relation is false, as we chose H to be noncocommutative.

Remark 2.3. *The multiplication in the algebra $A \otimes_{R_1} B \otimes_{R_2} C$ can be given, using the Sweedler-type notation recalled before, by the formula:*

$$(2.4) \quad (a \otimes b \otimes c)(a' \otimes b' \otimes c') = a(a'_{R_3})_{R_1} \otimes b_{R_1} b'_{R_2} \otimes (c_{R_3})_{R_2} c'.$$

The next natural question that arises is whether whenever we have a twisting map $T : C \otimes (A \otimes_R B) \rightarrow (A \otimes_R B) \otimes C$, it splits as a composition of two suitable twisting maps. Once again, this is not possible in general.

Theorem 2.4 (Right splitting). *Let A, B, C be algebras, $R_1 : B \otimes A \rightarrow A \otimes B$ and $T : C \otimes (A \otimes_{R_1} B) \rightarrow (A \otimes_{R_1} B) \otimes C$ unital twisting maps. The following are equivalent:*

- (1) *There exist $R_2 : C \otimes B \rightarrow B \otimes C$ and $R_3 : C \otimes A \rightarrow A \otimes C$ twisting maps such that $T = (A \otimes R_2) \circ (R_3 \otimes B)$.*
- (2) *The map T satisfies the **(right) splitting conditions**:*

$$(2.5) \quad T(C \otimes (A \otimes 1)) \subseteq (A \otimes 1) \otimes C,$$

$$(2.6) \quad T(C \otimes (1 \otimes B)) \subseteq (1 \otimes B) \otimes C.$$

PROOF

1 \Rightarrow 2 It is trivial.

2 \Rightarrow 1 Because of the conditions imposed to T , the map $R_2 : C \otimes B \rightarrow B \otimes C$ given as the only k -linear map such that $(u_A \otimes R_2) \circ (\tau \otimes B) = T \circ (C \otimes (u_A \otimes B))$ is well defined. From the fact that T is a twisting map it is immediately deduced that also R_2 is a twisting map. Analogously, we can define $R_3 : C \otimes A \rightarrow A \otimes C$ as the only k -linear map such that $(A \otimes \tau) \circ (R_3 \otimes u_B) = T \circ (C \otimes (A \otimes u_B))$, which is also a well defined twisting map. We

only have to check that $T = (A \otimes R_2) \circ (R_3 \otimes B)$. Using braiding notation we have

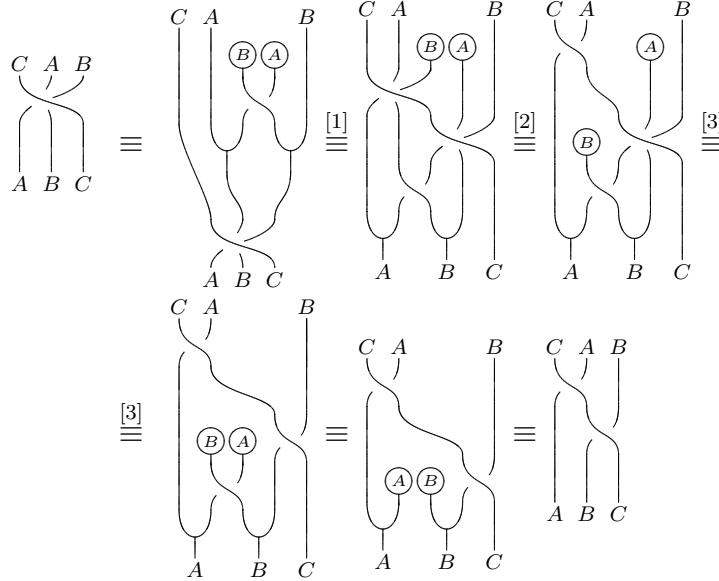

as we wanted to show, and where in [1] we are using that T is a twisting map, and in [2] and [3] the definitions of R_3 and R_2 respectively. \square

Again, we can ask ourselves whether the condition we required for the twisting map T to split might be trivial. The following example shows a situation in which an iterated twisted tensor product cannot be split:

Example 2.5. We give an example of twisting maps $R : B \otimes A \rightarrow A \otimes B$ and $T : C \otimes (A \otimes_R B) \rightarrow (A \otimes_R B) \otimes C$ for which it is *not* true that $T(c \otimes (a \otimes 1)) \in (A \otimes 1) \otimes C$ for all $a \in A$, $c \in C$.

Let H be a finite dimensional Hopf algebra with antipode S . Recall that the Drinfeld double $D(H)$ is a Hopf algebra having $H^{*cop} \otimes H$ as coalgebra structure and multiplication

$$(p \otimes h)(p' \otimes h') = p(h_1 \rightharpoonup p' \leftarrow S^{-1}(h_3)) \otimes h_2 h',$$

for all $p, p' \in H^*$ and $h, h' \in H$, where \rightharpoonup and \leftarrow are the left and right regular actions of H on H^* given by $(h \rightharpoonup p)(h') = p(h'h)$ and $(p \leftarrow h)(h') = p(hh')$. The Heisenberg double $\mathcal{H}(H)$ is the smash product $H \# H^*$, where H^* acts on H via the left regular action $p \rightharpoonup h = p(h_2)h_1$. Recall from [Lu94] that $\mathcal{H}(H)$ becomes a left $D(H)$ -module algebra, with action

$$(p \otimes h) \rightharpoonup (h' \otimes q) = p_2(h'_2)q_2(h)(h'_1 \otimes p_3 q_1 S^{*-1}(p_1)),$$

for all $p, q \in H^*$ and $h, h' \in H$, which is just the left regular action of $D(H)$ on $\mathcal{H}(H)$ identified as vector space with $D(H)^*$.

Now, we take $A = H$, $B = H^*$, $C = D(H)$, $R : H^* \otimes H \rightarrow H \otimes H^*$, $R(p \otimes h) = p_1 \rightharpoonup h \otimes p_2$ (hence $H \otimes_R H^* = H \# H^* = \mathcal{H}(H)$) and

$$\begin{aligned} T : D(H) \otimes \mathcal{H}(H) &\rightarrow \mathcal{H}(H) \otimes D(H), \\ T((p \otimes h) \otimes (h' \otimes q)) &= (p \otimes h)_1 \rightharpoonup (h' \otimes q) \otimes (p \otimes h)_2 \end{aligned}$$

(hence $\mathcal{H}(H) \otimes_T D(H) = \mathcal{H}(H) \# D(H)$, so T is a twisting map). Now we can see that

$$T((p \otimes h) \otimes (h' \otimes 1)) = p_3(h'_2)(h'_1 \otimes p_4 S^{*-1}(p_2)) \otimes (p_1 \otimes h),$$

which in general does *not* belong to $(H \otimes 1) \otimes D(H)$.

Of course, there exists an analogous left splitting theorem, that we state for completeness, and whose proof is analogous to the former one.

Theorem 2.6 (Left splitting). *Let A, B, C be algebras, $R_2 : C \otimes B \rightarrow B \otimes C$ and $T : (B \otimes_{R_2} C) \otimes A \rightarrow A \otimes (B \otimes_{R_2} C)$ twisting maps. The following are equivalent:*

- (1) *There exist $R_1 : B \otimes A \rightarrow A \otimes B$ and $R_3 : C \otimes A \rightarrow A \otimes C$ twisting maps such that $T = (R_1 \otimes C) \circ (B \otimes R_3)$.*
- (2) *The map T satisfies the (left) splitting conditions:*

$$(2.7) \quad T((1 \otimes C) \otimes A) \subseteq (A \otimes 1) \otimes C,$$

$$(2.8) \quad T((B \otimes 1) \otimes A) \subseteq A \otimes (B \otimes 1).$$

The universal property (Theorem 1.2) formerly stated can be easily extended to the iterated setting, as we show in the following result:

Theorem 2.7. *Let (A, B, C, R_1, R_2, R_3) be as in Theorem 2.1. Assume that we have a k -algebra X and algebra morphisms $u : A \rightarrow X, v : B \rightarrow X, w : C \rightarrow X$, such that*

$$(2.9) \quad \mu_X \circ (w \otimes v \otimes u) = \mu_X \circ (u \otimes v \otimes w) \circ (A \otimes R_2) \circ (R_3 \otimes B) \circ (C \otimes R_1).$$

Then there exists a unique algebra map $\varphi : A \otimes_{R_1} B \otimes_{R_2} C \rightarrow X$ such that $\varphi \circ i_A = u, \varphi \circ i_B = v, \varphi \circ i_C = w$.

PROOF Assume the we have a map φ satisfying the conditions in the theorem, then we may write

$$\begin{aligned} \varphi(a \otimes b \otimes c) &= \varphi((a \otimes 1 \otimes 1)(1 \otimes b \otimes 1)(1 \otimes 1 \otimes c)) \\ &= \varphi(a \otimes 1 \otimes 1)\varphi(1 \otimes b \otimes 1)\varphi(1 \otimes 1 \otimes c) \\ &= \varphi(i_A(a))\varphi(i_B(b))\varphi(i_C(c)) \\ &= u(a)v(b)w(c), \end{aligned}$$

and so φ is uniquely defined.

For the existence part, define $\varphi(a \otimes b \otimes c) := u(a)v(b)w(c)$, and let us check that this map is indeed an algebra morphism. Using formula (2.4), we have

$$\begin{aligned} \varphi((a \otimes b \otimes c)(a' \otimes b' \otimes c')) &= \varphi(a(a'_{R_3})_{R_1} \otimes b_{R_1} b'_{R_2} \otimes (c_{R_3})_{R_2} c') \\ &= u(a)u((a'_{R_3})_{R_1})v(b_{R_1})v(b'_{R_2})w((c_{R_3})_{R_2})w(c'). \end{aligned}$$

On the other hand, we have

$$\begin{aligned} \varphi(a \otimes b \otimes c)\varphi(a' \otimes b' \otimes c') &= u(a)v(b)w(c)u(a')v(b')w(c') \\ &= u(a)v(b)u(a'_{R_3})w(c_{R_3})v(b')w(c') \\ &= u(a)u((a'_{R_3})_{R_1})v(b_{R_1})v(b'_{R_2})w((c_{R_3})_{R_2})w(c'), \end{aligned}$$

and thus we conclude that φ is an algebra morphism. The fact that φ satisfies the required relations with u, v and w is immediately deduced from its definition. \square

To reach completely the aim of defining an analogue for the product of spaces, one should be able to construct a product of any number of factors. In order to construct the three–factors product, we had to add one extra condition, namely the hexagon equation, to the conditions that were imposed for building the two–factors product (the twisting map conditions). Fortunately, in order to build a general n –factors twisted product of algebras one needs no more conditions besides the ones we have already met. Morally, this just means than having pentagonal (twisting) and hexagonal (braiding) conditions, we can build any product without worrying about where to put the parentheses. The way to prove this is using induction. As our induction hypothesis, we assume that whenever we have $n - 1$ algebras B_1, \dots, B_{n-1} , with a twisting map $S_{ij} : B_j \otimes B_i \rightarrow B_i \otimes B_j$ for every $i < j$, and such that for any $i < j < k$ the maps S_{ij}, S_{jk} and S_{ik} are compatible, then we can build the iterated product $B_1 \otimes_{S_{12}} B_2 \otimes_{S_{23}} \dots \otimes_{S_{n-1 n}} B_n$ without worrying about parentheses. Let then A_1, \dots, A_n be algebras, $R_{ij} : A_j \otimes A_i \rightarrow A_i \otimes A_j$ twisting maps for every $i < j$, such that for any $i < j < k$ the maps R_{ij}, R_{jk} and R_{ik} are compatible. Define now for every $i < n - 1$ the map

$$T_{n-1,n}^i : (A_{n-1} \otimes_{R_{n-1 n}} A_n) \otimes A_i \rightarrow A_i \otimes (A_{n-1} \otimes_{R_{n-1 n}} A_n)$$

by $T_{n-1,n}^i := (R_{i n-1} \otimes A_n) \circ (A_{n-1} \otimes R_{i n})$, which are twisting maps for every i , as we can directly apply Theorem 2.1 to the maps $R_{i n-1}, R_{i n}$ and $R_{n-1 n}$. Furthermore, we have the following result:

Lemma 2.8. *In the above situation, for every $i < j < n - 1$, the maps $R_{ij}, T_{n-1,n}^i$ and $T_{n-1,n}^j$ are compatible.*

PROOF Using braiding notation the proof can be written as:

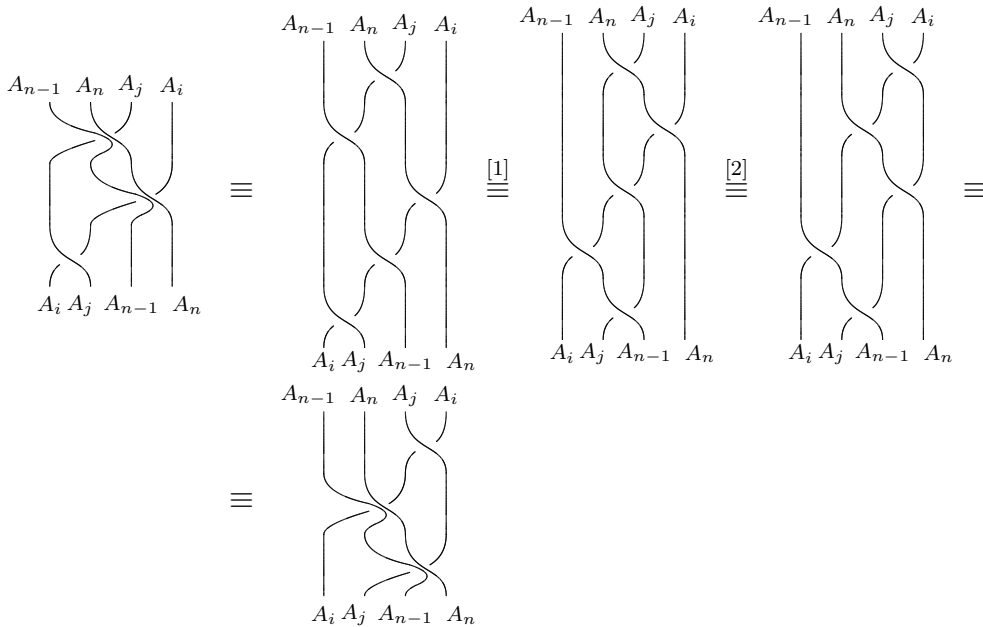

where in [1] we use the compatibility condition for R_{ij} , $R_{i_{n-1}}$ and $R_{j_{n-1}}$, and in [2] we use the compatibility condition for R_{ij} , R_{in} and R_{jn} . \square

So we can apply the induction hypothesis to the $n-1$ algebras A_1, \dots, A_{n-2} , and $(A_{n-1} \otimes_{R_{n-1n}} A_n)$, and we obtain that we can build the twisted product of these $n-1$ factors without worrying about parentheses, so we can build the algebra

$$A_1 \otimes_{R_{12}} \cdots \otimes_{R_{n-2}} A_{n-2} \otimes_{T_{n-1,n}^{n-2}} (A_{n-1} \otimes_{R_{n-1n}} A_n).$$

Simply observing that

$$A_{n-2} \otimes_{T_{n-1,n}^{n-2}} (A_{n-1} \otimes_{R_{n-1n}} A_n) = (A_{n-2} \otimes_{R_{n-2n-1}} A_{n-1}) \otimes_{T_{n-2n-1}^n} A_n,$$

we see that we could have grouped together any two consecutive factors. Summarizing, we have sketched the proof of the following theorem (which we will not write formally to avoid the cumbersome notation it would involve):

Theorem 2.9 (Coherence Theorem). *Let A_1, \dots, A_n be algebras, $R_{ij} : A_j \otimes A_i \rightarrow A_i \otimes A_j$ (unital) twisting maps for every $i < j$, such that for any $i < j < k$ the maps R_{ij} , R_{jk} and R_{ik} are compatible. Then the maps*

$$T_{j-1,j}^i : (A_{j-1} \otimes_{R_{j-1j}} A_j) \otimes A_i \rightarrow A_i \otimes (A_{j-1} \otimes_{R_{j-1j}} A_j)$$

defined for every $i < j-1$ by $T_{j-1,j}^i := (R_{ij-1} \otimes A_j) \circ (A_{j-1} \otimes R_{ij})$, and the maps

$$T_{j-1,j}^i : A_i \otimes (A_{j-1} \otimes_{R_{j-1j}} A_j) \rightarrow (A_{j-1} \otimes_{R_{j-1j}} A_j) \otimes A_i$$

defined for every $i > j$ by $T_{j-1,j}^i := (A_{j-1} \otimes R_{ji}) \circ (R_{j-1i} \otimes A_j)$, are twisting maps with the property that for every $i, k \notin \{j-1, j\}$ the maps R_{ik} , $T_{n-1,n}^i$ and $T_{n-1,n}^k$ are compatible. Moreover, for any i the (inductively defined) algebras

$$A_1 \otimes_{R_{12}} \cdots \otimes_{R_{i-3,i-2}} A_{i-2} \otimes_{T_{i-1,i}^{i-2}} (A_{i-1} \otimes_{R_{i-1i}} A_i) \otimes_{T_{i-1,i}^{i+1}} A_{i+1} \otimes_{R_{i+1,i+2}} \cdots \otimes_{R_{n-1n}} A_n$$

are all equal.

As a consequence of this theorem, any property that can be lifted to iterated twisted tensor products of three factors can be lifted to products of any number of factors. One of the most interesting consequences of the Coherence Theorem, or more accurately, of the former lemma, is that we can state a universal property, analogous to Theorems 1.2 and 2.7. In order to state the result it is convenient to introduce some notation. Let us first define the maps

$$\begin{aligned} \mathcal{T}_1 &: A_n \otimes \cdots \otimes A_1 \longrightarrow A_1 \otimes A_n \otimes \cdots \otimes A_2, \\ \mathcal{T}_1 &:= (R_{1n} \otimes \text{Id}_{A_{n-1} \otimes \cdots \otimes A_2}) \circ \cdots \circ (\text{Id}_{A_n \otimes \cdots \otimes A_3} \otimes R_{12}), \\ \mathcal{T}_2 &: A_1 \otimes A_n \otimes \cdots \otimes A_2 \longrightarrow A_1 \otimes A_2 \otimes A_n \otimes \cdots \otimes A_3, \\ \mathcal{T}_2 &:= (A_1 \otimes R_{2n} \otimes \text{Id}_{A_{n-1} \otimes \cdots \otimes A_3}) \circ \cdots \circ (\text{Id}_{A_1 \otimes A_n \otimes \cdots \otimes A_4} \otimes R_{23}), \\ &\vdots \\ \mathcal{T}_{n-1} &: A_1 \otimes \cdots \otimes A_{n-2} \otimes A_n \otimes A_{n-1} \longrightarrow A_1 \otimes \cdots \otimes A_{n-2} \otimes A_{n-1} \otimes A_n, \\ \mathcal{T}_{n-1} &:= A_1 \otimes \cdots \otimes A_{n-2} \otimes R_{n-1n}, \end{aligned}$$

and now define the map

$$\begin{aligned}\mathcal{S} &: A_n \otimes A_{n-1} \otimes \cdots \otimes A_1 \longrightarrow A_1 \otimes A_2 \otimes \cdots \otimes A_n, \\ \mathcal{S} &:= \mathcal{T}_{n-1} \circ \cdots \circ \mathcal{T}_2 \circ \mathcal{T}_1.\end{aligned}$$

With this notation, we can state the Universal Property for iterated twisted tensor products as follows:

Theorem 2.10 (Universal Property). *Let A_1, \dots, A_n be algebras, $R_{ij} : A_j \otimes A_i \rightarrow A_i \otimes A_j$ (unital) twisting maps for every $i < j$, such that for any $i < j < k$ the maps R_{ij} , R_{jk} and R_{ik} are compatible. Suppose that we have an algebra X together with n algebra morphisms $u_i : A_i \rightarrow X$ such that*

$$(2.10) \quad \mu_X \circ (u_n \otimes \cdots \otimes u_1) = \mu_X \circ (u_1 \otimes \cdots \otimes u_n) \circ \mathcal{S}.$$

Then there exists a unique algebra morphism

$$\varphi : A_1 \otimes_{R_{12}} A_2 \otimes_{R_{23}} \cdots \otimes_{R_{n-1n}} A_n \longrightarrow X$$

such that

$$\varphi \circ i_{A_j} = u_j, \quad \text{for all } j = 1, \dots, n.$$

PROOF Following the same procedure as in the proof of Theorem 2.7, it is easy to see that any map φ verifying the conditions of the theorem must satisfy

$$\varphi(a_1 \otimes \cdots \otimes a_n) = u_1(a_1) \cdots u_n(a_n),$$

and hence it must be unique. Whence it suffices to define φ as above. The checking of the multiplicative property is also similar to the one done in the proof of Theorem 2.7, and thus is left to the reader. \square

A further step in the study of the iterated twisted tensor products is the lifting of module structures on the factors. Again, if we have M a left A -module, N a left B -module, and P a left C -module, the natural way in order to define a left $(A \otimes_{R_1} B \otimes_{R_2} C)$ -module structure on $M \otimes N \otimes P$ is looking for module twisting maps $\tau_{M,C} : C \otimes M \rightarrow M \otimes C$, $\tau_{M,B} : B \otimes M \rightarrow M \otimes B$ and $\tau_{N,C} : C \otimes N \rightarrow N \otimes C$, and defining

$$\lambda_{M \otimes N \otimes P} := (\lambda_M \otimes \lambda_N \otimes \lambda_P) \circ (A \otimes \tau_{M,B} \otimes \tau_{N,C} \otimes P) \circ (A \otimes B \otimes \tau_{M,C} \otimes N \otimes P).$$

However, as it happened with the iterated product of algebras, in order to have a left module action it is not enough that $\tau_{M,C}$, $\tau_{N,C}$ and $\tau_{M,B}$ are module twisting maps. Realize that, using the $A \otimes_{R_1} B$ -module structure induced on $M \otimes N$ by $\tau_{M,B}$, we can also write the above action as

$$\begin{aligned}\lambda_{M \otimes N \otimes P} &= (\lambda_{M \otimes N} \otimes \lambda_P) \circ (A \otimes B \otimes M \otimes \tau_{N,C} \otimes P) \circ (A \otimes B \otimes \tau_{M,C} \otimes N \otimes P) \\ &= (\lambda_{M \otimes N} \otimes \lambda_P) \circ (A \otimes B \otimes \sigma_C \otimes P),\end{aligned}$$

where $\sigma_C : C \otimes (M \otimes N) \rightarrow (M \otimes N) \otimes C$ is defined by $\sigma_C := (M \otimes \tau_{N,C}) \circ (\tau_{M,C} \otimes N)$, so proving that the three module twisting maps induce a left module structure on $M \otimes N \otimes P$ is equivalent to prove that the map σ_C is a module twisting map, thus giving a left $(A \otimes_{R_1} B) \otimes_{T_1}$

C -module structure on $(M \otimes N) \otimes P$. We give sufficient conditions for this to happen in the following result.

Theorem 2.11. *With the above notation, suppose that the module twisting maps $\tau_{M,C}$, $\tau_{M,B}$ and the twisting map R_2 satisfy the compatibility relation (also called the **module hexagon condition**)*

$$(2.11) \quad (M \otimes R_2) \circ (\tau_{M,C} \otimes B) \circ (C \otimes \tau_{M,B}) = (\tau_{M,B} \otimes C) \circ (B \otimes \tau_{M,C}) \circ (R_2 \otimes M),$$

that is, the following diagram

$$\begin{array}{ccccc}
 & & C \otimes M \otimes B & \xrightarrow{\tau_{M,C} \otimes B} & M \otimes C \otimes B \\
 & \nearrow^{C \otimes \tau_{M,B}} & & & \searrow^{M \otimes R_2} \\
 C \otimes B \otimes M & & & & & M \otimes B \otimes C \\
 & \searrow^{R_2 \otimes M} & & & \nearrow^{\tau_{M,B} \otimes C} \\
 & & B \otimes C \otimes M & \xrightarrow{B \otimes \tau_{M,C}} & B \otimes M \otimes C
 \end{array}$$

is commutative; then:

- (1) The map $\sigma_C : C \otimes (M \otimes N) \rightarrow (M \otimes N) \otimes C$ given by $\sigma_C := (M \otimes \tau_{N,C}) \circ (\tau_{M,C} \otimes N)$ is a module twisting map.
- (2) The map $\sigma_{B \otimes C} : (B \otimes C) \otimes M \rightarrow M \otimes (B \otimes C)$ given by $\sigma_{B \otimes C} := (\tau_{M,B} \otimes C) \circ (B \otimes \tau_{M,C})$ is a module twisting map (giving a left $A \otimes_{T_2} (B \otimes_{R_2} C)$ -module structure on $M \otimes (N \otimes P)$).

Moreover, the module structures induced on $M \otimes N \otimes P$ by σ_C and $\sigma_{B \otimes C}$ are equal.

PROOF

1 We have to check that σ_C satisfies the conditions (1.11) and (1.12). For the first one, we have that

where in [1] we are using the first module twisting condition for $\tau_{M,C}$, and in [2] the first module twisting condition for $\tau_{N,C}$. For the second one, we have

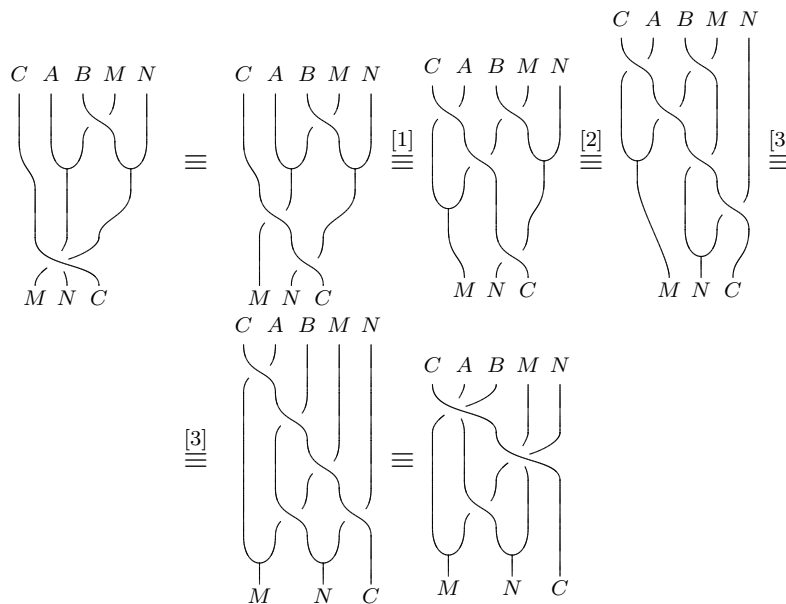

where in [1] and [2] we use again the module twisting conditions and in [3] the module hexagon condition.

The proof of (2) is very similar and left to the reader. \square

Remark 2.12. *Note that in this case we cannot prove the module hexagon condition from the twisting conditions on the maps. The situation is similar to what happens for the case of the existence of module twisting maps. It is reasonable to think that some sufficient conditions on the modules and the algebras can be given in order to recover the converse. For instance, if the modules are free, the situation is analogous to the iterated twisting construction for algebras, and the converse result can easily be stated.*

We recall that it is possible to give an explicit description of modules over various twisted tensor products of algebras arising in Hopf algebra theory. The same holds in general, as the next result shows.

Proposition 2.13. *Let A, B be associative unital algebras and $R : B \otimes A \rightarrow A \otimes B$ a unital twisting map. If M is a vector space, then M is a left $A \otimes_R B$ -module if and only if it is a left A -module and a left B -module satisfying the compatibility condition*

$$(2.12) \quad b \cdot (a \cdot m) = a_R \cdot (b_R \cdot m), \text{ for all } a \in A, b \in B, m \in M,$$

where we denote by \cdot both the actions of A and B .

PROOF If M is a left $A \otimes_R B$ -module, it becomes a left A -module with action $a \cdot m = (a \otimes 1) \cdot m$ and a left B -module with action $b \cdot m = (1 \otimes b) \cdot m$. Conversely, it becomes an $A \otimes_R B$ -module with action $(a \otimes b) \cdot m = a \cdot (b \cdot m)$, details are left to the reader. \square

This result can be iterated, generalizing thus the description of modules over a two-sided smash product from [Pan02].

Proposition 2.14. *Assume that the hypotheses of Theorem 2.1 are satisfied, such that all algebras and twisting maps are unital. If M is a vector space, then M is a left $A \otimes_{R_1} B \otimes_{R_2} C$ -module if and only if it is a left A -module, a left B -module, a left C -module (all actions are denoted by \cdot) satisfying the compatibility conditions*

$$(2.13) \quad b \cdot (a \cdot m) = a_{R_1} \cdot (b_{R_1} \cdot m),$$

$$(2.14) \quad c \cdot (b \cdot m) = b_{R_2} \cdot (c_{R_2} \cdot m),$$

$$(2.15) \quad c \cdot (a \cdot m) = a_{R_3} \cdot (c_{R_3} \cdot m),$$

for all $a \in A$, $b \in B$, $c \in C$, $m \in M$ (by Proposition 2.13, these conditions tell that M is a left module over $A \otimes_{R_1} B$, $B \otimes_{R_2} C$ and $A \otimes_{R_3} C$).

PROOF We only prove that M becomes a left $A \otimes_{R_1} B \otimes_{R_2} C$ -module with action $(a \otimes b \otimes c) \cdot m = a \cdot (b \cdot (c \cdot m))$. We compute (using formula (2.4)):

$$\begin{aligned} ((a \otimes b \otimes c)(a' \otimes b' \otimes c')) \cdot m &= a(a'_{R_3})_{R_1} \cdot (b_{R_1} b'_{R_2} \cdot ((c_{R_3})_{R_2} c' \cdot m)) \\ (2.14) &= a(a'_{R_3})_{R_1} \cdot (b_{R_1} \cdot (c_{R_3} \cdot (b' \cdot (c' \cdot m)))) \\ (2.13) &= a \cdot (b \cdot (a'_{R_3} \cdot (c_{R_3} \cdot (b' \cdot (c' \cdot m)))))) \\ (2.15) &= a \cdot (b \cdot (c \cdot (a' \cdot (b' \cdot (c' \cdot m)))))) \\ &= (a \otimes b \otimes c) \cdot ((a' \otimes b' \otimes c') \cdot m), \end{aligned}$$

finishing the proof. \square

Our next result arises as a generalization of the fact from [HN99], [BPVO] that a two-sided smash product over a Hopf algebra is isomorphic to a diagonal crossed product.

Proposition 2.15. *Let (A, B, C, R_1, R_2, R_3) be as in Theorem 2.1, and assume that R_2 is bijective with inverse $V : B \otimes C \rightarrow C \otimes B$. Then (A, C, B, R_3, V, R_1) satisfy also the hypotheses of Theorem 2.1, and the map $A \otimes R_2 : A \otimes_{R_3} C \otimes_V B \rightarrow A \otimes_{R_1} B \otimes_{R_2} C$ is an algebra isomorphism.*

PROOF By Proposition 1.1, V is a twisting map, and it is obvious that the hexagon condition for (R_3, V, R_1) is equivalent to the one for (R_1, R_2, R_3) . Obviously $A \otimes R_2$ is bijective, we only have to prove that it is an algebra map. This can be done either by direct computation or, more conceptually, as follows. Denote $T_2 = (R_1 \otimes C) \circ (B \otimes R_3)$ and $\tilde{T}_2 = (R_3 \otimes B) \circ (C \otimes R_1)$, hence $A \otimes_{R_3} C \otimes_V B = A \otimes_{\tilde{T}_2} (C \otimes_V B)$ and $A \otimes_{R_1} B \otimes_{R_2} C = A \otimes_{T_2} (B \otimes_{R_2} C)$. By Proposition 1.1 we know that $R_2 : C \otimes_V B \rightarrow B \otimes_{R_2} C$ is an algebra map, and we obviously have $(A \otimes R_2) \circ \tilde{T}_2 = T_2 \circ (R_2 \otimes A)$, because this is just the hexagon condition. Now it follows that $A \otimes R_2$ is an algebra map, using the following general fact from [BM00]: if $A \otimes_R B$ and $C \otimes_T D$ are twisted tensor products of algebras and $f : A \rightarrow C$ and $g : B \rightarrow D$ are algebra maps satisfying the condition $(f \otimes g) \circ R = T \circ (g \otimes f)$, then $f \otimes g : A \otimes_R B \rightarrow C \otimes_T D$ is an algebra map. \square

As our main motivations aimed at applications of our construction to the field of noncommutative geometry, we are especially interested in finding processes that allow us to lift constructions associated to geometrical invariants of the algebras to their (iterated) twisted tensor

products. Among these geometrical invariants, the first one to be taken into account is of course the algebra of differential forms. For the case of the twisted product of two algebras, a twisted product of the algebras of universal differential forms is build in a unique way, as it is shown in Theorem 1.3; there, the construction of these extended twisting maps is deduced from the universal property of the first order universal differential calculus. This extension is compatible with our extra condition for constructing iterated products, as we show in the following result:

Theorem 2.16. *Let A, B, C be algebras, and let $R_1 : B \otimes A \longrightarrow A \otimes B, R_2 : C \otimes B \longrightarrow B \otimes C, R_3 : C \otimes A \longrightarrow A \otimes C$ be twisting maps satisfying the hexagon equation, then the extended twisting maps \tilde{R}_1, \tilde{R}_2 and \tilde{R}_3 also satisfy the hexagon equation. Moreover, $\Omega A \otimes_{\tilde{R}_1} \Omega B \otimes_{\tilde{R}_2} \Omega C$ is a differential graded algebra, with differential*

$$d = d_A \otimes \Omega B \otimes \Omega C + \varepsilon_A \otimes d_B \otimes \Omega C + \varepsilon_A \otimes \varepsilon_B \otimes d_C.$$

PROOF For proving that the extended twisting maps satisfy the hexagon equation, we use a standard technique when dealing with algebras of differential forms.

Firstly, observe that when restricted to the zero degree part of the algebras of differential forms, the extended twisting maps coincide with the original ones, and hence they trivially satisfy the hexagon equation.

Now, suppose that we have elements $\omega \in \Omega A, \eta \in \Omega B, \theta \in \Omega C$ such that the hexagon equation is satisfied when evaluated on $\omega \otimes \eta \otimes \theta$, and let us show that then the hexagon equation is also satisfied when evaluated in $d_A \omega \otimes \eta \otimes \theta, \omega \otimes d_B \eta \otimes \theta$ and $\omega \otimes \eta \otimes d_C \theta$, that is, we will show that the hexagon condition is stable under application of any of the differentials d_A, d_B and d_C .

Let us start proving that the condition holds for $\omega \otimes \eta \otimes d_C \theta$. Using again braiding notation, we have

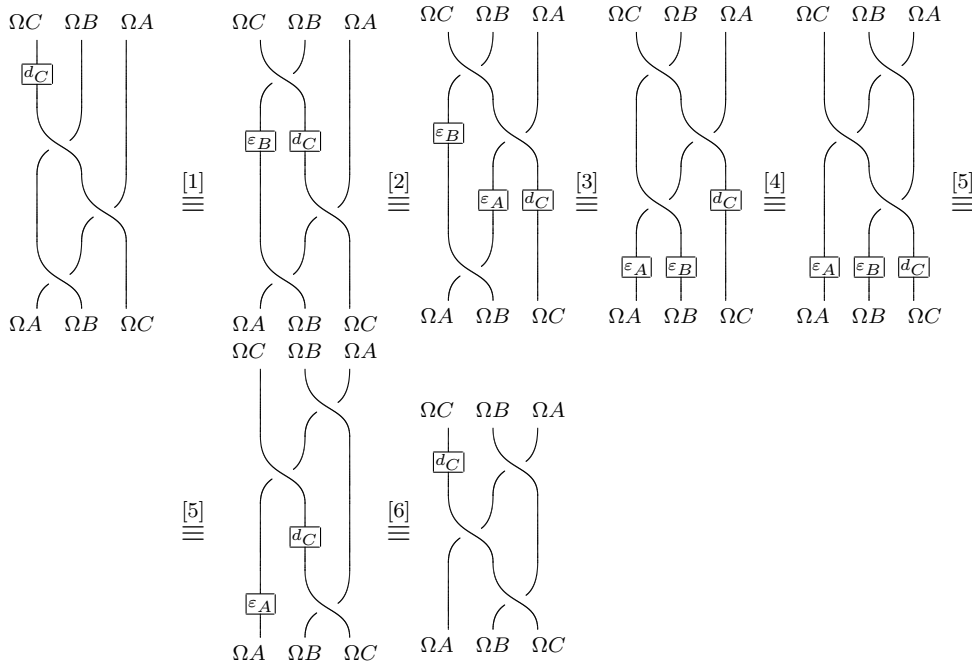

where in [1], [2], [5] and [6] we are using the property (1.13) for d_C with respect to R_2 and R_3 respectively, in [3] the (obvious) fact that the gradings commute with the extended twisting maps (since they are homogeneous), and in [4] we are using the hexagon equation for $\omega \otimes \eta \otimes \theta$. The corresponding proofs for $\omega \otimes d\eta \otimes \theta$ and $d\omega \otimes \eta \otimes \theta$ are almost identical. Summarizing, the hexagon condition is stable under differentials in ΩA , ΩB and ΩC .

Finally, suppose that we have elements $\omega \in \Omega A$, $\eta \in \Omega B$, $\theta_1, \theta_2 \in \Omega C$ such that the hexagon equation is satisfied when evaluated on $\omega \otimes \eta \otimes \theta_1$ and $\omega_2 \otimes \eta \otimes \theta_2$, and let us show that in this case the hexagon condition also holds on $\omega \otimes \eta \otimes \theta_1 \theta_2$:

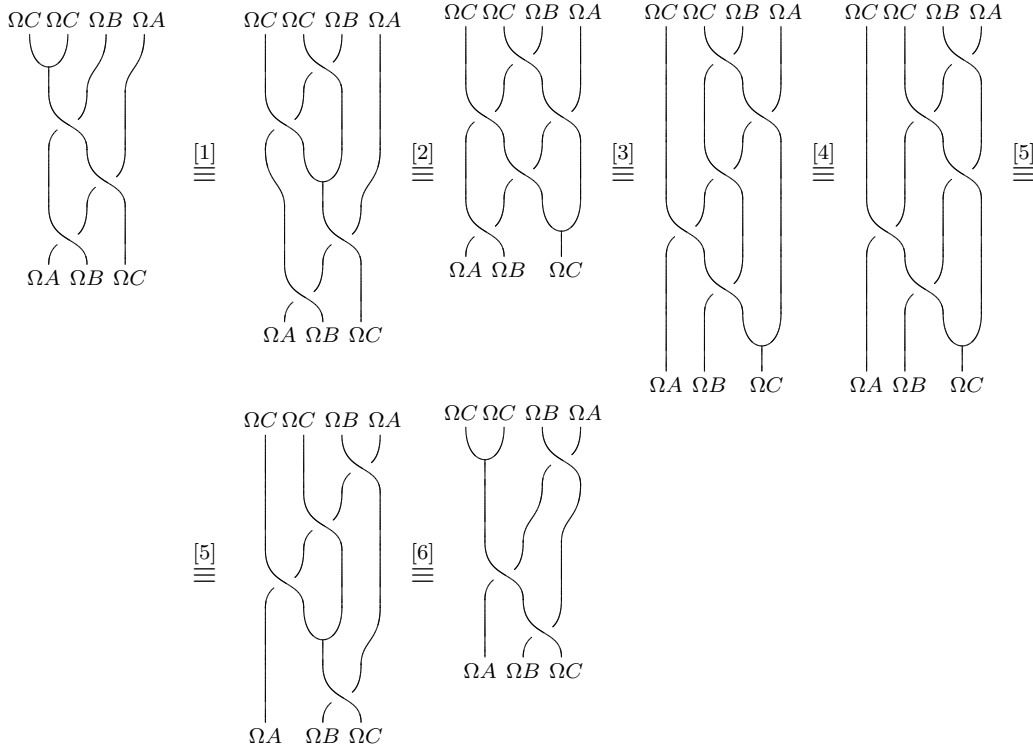

where in [1], [2], [5] and [6] we use the pentagon equations (1.2) for the twisting maps \tilde{R}_2 and \tilde{R}_3 , and in [3] and [4] we use the hexagon condition for $\omega \otimes \eta \otimes \theta_1$ and $\omega \otimes \eta \otimes \theta_2$ respectively. In a completely analogous way we can prove that the hexagon condition holds for $\omega \otimes \eta_1 \eta_2 \otimes \theta$ and $\omega_1 \omega_2 \otimes \eta \otimes \theta$, that is: the hexagon condition remains stable under products in ΩA , ΩB and ΩC .

Now, taking into account that ΩA , ΩB and ΩC are generated as graded differential algebras by the elements of degree 0, we may conclude that the hexagon condition holds completely.

In order to prove that $\Omega A \otimes_{\tilde{R}_1} \Omega B \otimes_{\tilde{R}_2} \Omega C$ is a graded differential algebra, it is enough to observe that $\Omega A \otimes_{\tilde{R}_1} \Omega B \otimes_{\tilde{R}_2} \Omega C = (\Omega A \otimes_{\tilde{R}_1} \Omega B) \otimes_{\tilde{T}_2} \Omega C$, the last being (because of Theorem 1.3) a graded differential algebra with differential

$$d = d_{A \otimes_{R_1} B} \otimes \Omega C + \varepsilon_{A \otimes_{R_1} B} \otimes d_C,$$

and taking into account that

$$\begin{aligned} d_{A \otimes_{R_1} B} &= d_A \otimes \Omega B + \varepsilon_A \otimes d_B, \\ \varepsilon_{A \otimes_{R_1} B} &= \varepsilon_A \otimes \varepsilon_B, \end{aligned}$$

we obtain

$$d = d_A \otimes \Omega B \otimes \Omega C + \varepsilon_A \otimes d_B \otimes \Omega C + \varepsilon_A \otimes \varepsilon_B \otimes d_C,$$

as we wanted to show. \square

As most of our motivation comes from some algebras used in Connes' theory, in order to deal properly with $*$ -algebras we would like to find a suitable extension of condition (1.10) to our framework. As the definition of the involution in a twisted tensor product also involves the usual flip τ , before extending the conditions to an iterated product, we need a technical (and easy to prove) result:

Lemma 2.17. *Let A, B, C be algebras, and let $R : B \otimes A \rightarrow A \otimes B$ be a twisting map. Consider also the usual flips $\tau_{BC} : B \otimes C \rightarrow C \otimes B$ and $\tau_{AC} : A \otimes C \rightarrow C \otimes A$, then the maps τ_{AC}, R and τ_{BC} satisfy the hexagon condition (in $B \otimes A \otimes C$).*

PROOF Just write down both sides of the equation and realize they are equal. \square

Remark 2.18. *In general, we can say that any twisting map is compatible with a pair of usual flips, regardless the ordering of the factors. As the inverse of a usual flip is also a usual flip, we may also use this result when one of the flips is inverted.*

Similarly to what happened with differential forms, in order to be able to extend the involutions to the iterated product, it is enough that condition (1.10) is satisfied for every pair of algebras. More concretely, we have the following result:

Theorem 2.19. *Let A, B, C be $*$ -algebras with involutions j_A, j_B and j_C respectively, $R_1 : B \otimes A \rightarrow A \otimes B, R_2 : C \otimes B \rightarrow B \otimes C$ and $R_3 : C \otimes A \rightarrow A \otimes C$ compatible twisting maps such that*

$$(2.16) \quad (R_1 \circ (j_B \otimes j_A) \circ \tau_{AB}) \circ (R_1 \circ (j_B \otimes j_A) \circ \tau_{AB}) = A \otimes B,$$

$$(2.17) \quad (R_2 \circ (j_C \otimes j_B) \circ \tau_{BC}) \circ (R_2 \circ (j_C \otimes j_B) \circ \tau_{BC}) = B \otimes C,$$

$$(2.18) \quad (R_3 \circ (j_C \otimes j_A) \circ \tau_{AC}) \circ (R_3 \circ (j_C \otimes j_A) \circ \tau_{AC}) = A \otimes C.$$

Then $A \otimes_{R_1} B \otimes_{R_2} C$ is a $*$ -algebra with involution

$$j = (R_1 \otimes C) \circ (B \otimes R_3) \circ (R_2 \otimes A) \circ (j_C \otimes j_B \otimes j_A) \circ (C \otimes \tau_{AB}) \circ (\tau_{AC} \otimes B) \circ (A \otimes \tau_{BC}),$$

where $\tau_{AB} : A \otimes B \rightarrow B \otimes A, \tau_{BC} : B \otimes C \rightarrow C \otimes B$, and $\tau_{AC} : A \otimes C \rightarrow C \otimes A$ denote the usual flips.

PROOF Consider j defined as above, and let us check that it is an involution, i. e., that $j^2 = A \otimes B \otimes C$. Firstly, observe that, if we denote by τ all the usual flips and by $\bar{\tau}$ their

inverses, we have that

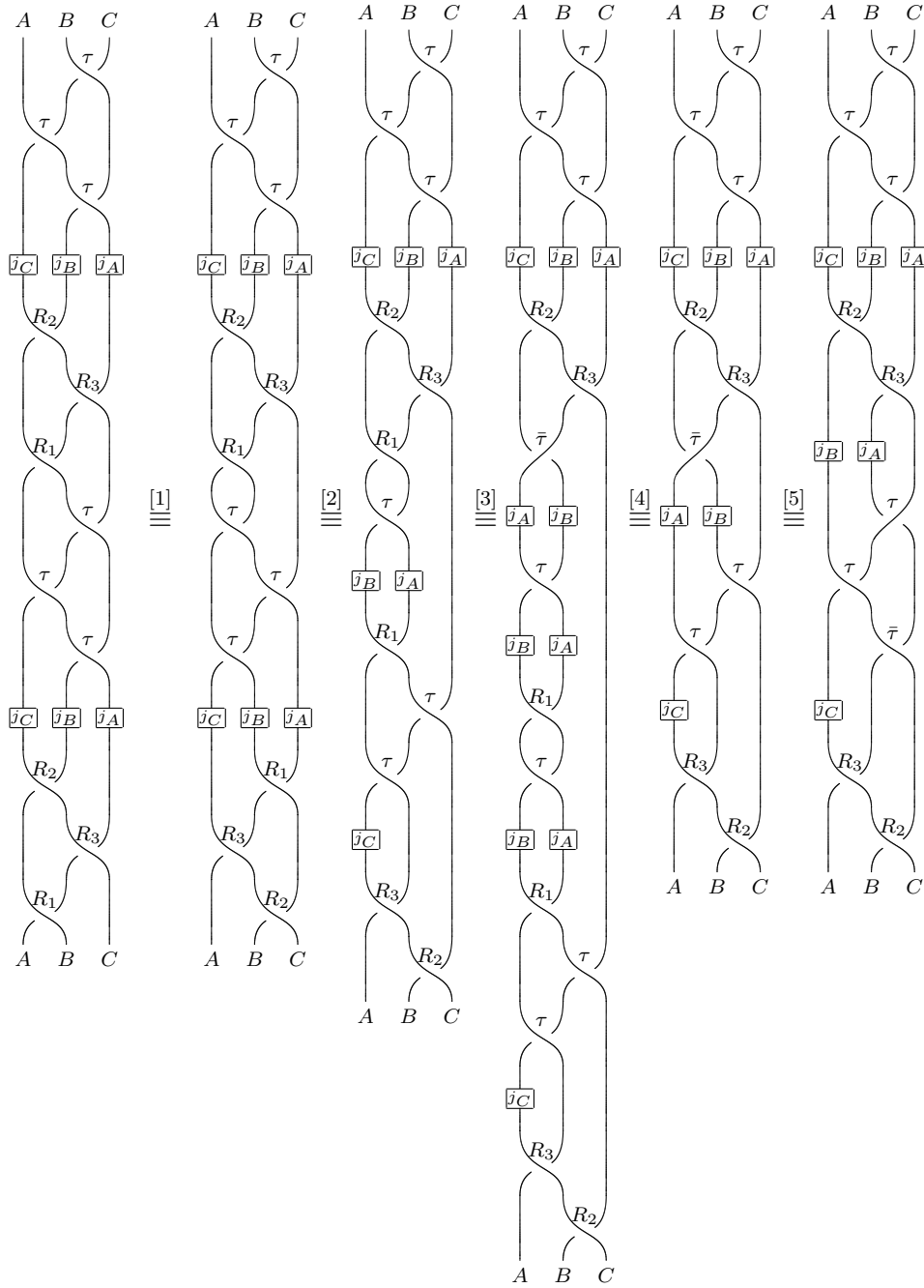

where in [1] we use the hexagon conditions for the flips (which is obvious) and the hexagon conditions for R_1, R_2, R_3 , in [2] we use the fact that the involutions j_A and j_B commute with the flips, and the hexagon condition for R_1 and two flips (as stated in the former lemma). Equivalence [3] is due to the fact that both the square of the involutions, and the composition of a flip with its inverse are the identity. In [4] we apply (2.16), and in [5] we use again that the involutions commute with the flips, plus the hexagon condition for τ_{AB}^{-1} and two usual flips. To conclude the proof, observe that

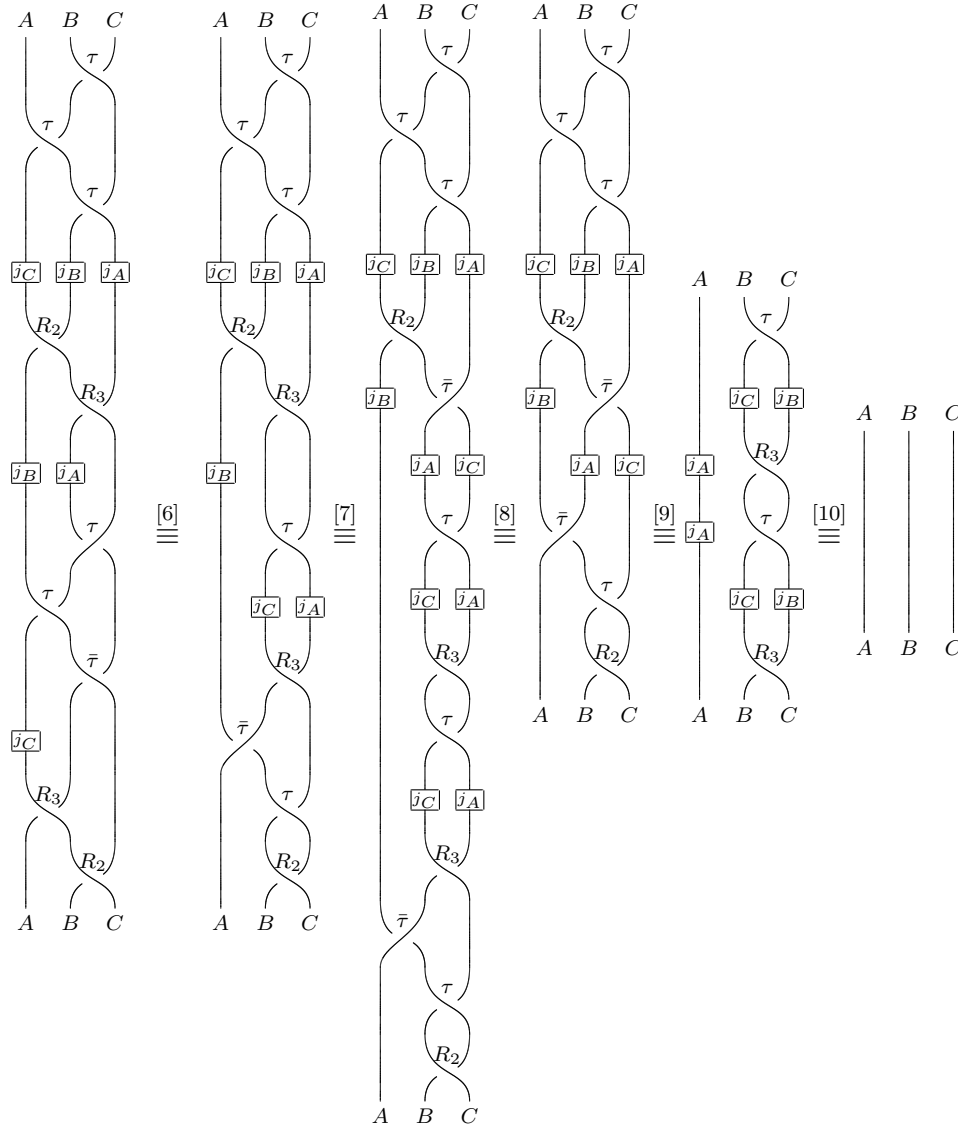

where in [6] we apply (twice) the commutation of j_C with the flips, plus the hexagon for R_3 and two flips (again because of the former lemma). Equality [7] holds again because we are just adding a term (two squared involutions, a flip, and its inverse) that equals the identity, while [8] holds by applying (2.17). [9] is due to the fact that in the last diagram the element of A is not modified at all, since all the crossings are usual flips, and we get [10] using (2.17) and the fact that j_A is an involution. \square

3. EXAMPLES

3.1. Generalized smash products. We begin by recalling the construction of the so-called generalized smash products. Let H be a bialgebra. For a right H -comodule algebra (\mathfrak{A}, ρ) we denote $\rho(\mathfrak{a}) = \mathfrak{a}_{<0>} \otimes \mathfrak{a}_{<1>}$, for any $\mathfrak{a} \in \mathfrak{A}$. Similarly, for a left H -comodule algebra (\mathfrak{B}, λ) , if $\mathfrak{b} \in \mathfrak{B}$ then we denote $\lambda(\mathfrak{b}) = \mathfrak{b}_{[-1]} \otimes \mathfrak{b}_{[0]}$.

Let A be a left H -module algebra and \mathfrak{B} a left H -comodule algebra. Denote by $A \blacktriangleright \mathfrak{B}$ the k -vector space $A \otimes \mathfrak{B}$ with newly defined multiplication

$$(3.19) \quad (a \blacktriangleright b)(a' \blacktriangleright b') = a(b_{[-1]} \cdot a') \blacktriangleright b_{[0]} b',$$

for all $a, a' \in A$ and $b, b' \in \mathfrak{B}$. Then $A \blacktriangleright \mathfrak{B}$ is an associative algebra with unit $1_A \blacktriangleright 1_{\mathfrak{B}}$. If we take $\mathfrak{B} = H$ then $A \blacktriangleright H$ is just the ordinary smash product $A \# H$, whose multiplication is

$$(a \# h)(a' \# h') = a(h_1 \cdot a') \# h_2 h'.$$

The algebra $A \blacktriangleright \mathfrak{B}$ is called the (left) generalized smash product of A and \mathfrak{B} .

Similarly, if B is a right H -module algebra and \mathfrak{A} is a right H -comodule algebra, then we denote by $\mathfrak{A} \blacktriangleright B$ the k -vector space $\mathfrak{A} \otimes B$ with the newly defined multiplication

$$(3.20) \quad (a \blacktriangleright b)(a' \blacktriangleright b') = a a'_{\langle 0 \rangle} \blacktriangleright (b \cdot a'_{\langle 1 \rangle}) b',$$

for all $a, a' \in \mathfrak{A}$ and $b, b' \in B$. Then $\mathfrak{A} \blacktriangleright B$ is an associative algebra with unit $1_{\mathfrak{A}} \blacktriangleright 1_B$, called also the (right) generalized smash product of \mathfrak{A} and B .

We recall some facts from [BPVO]. Let H be a bialgebra, A a left H -module algebra, B a right H -module algebra and \mathbb{A} an H -bicomodule algebra. Then $A \blacktriangleright \mathbb{A}$ becomes a right H -comodule algebra with structure

$$A \blacktriangleright \mathbb{A} \rightarrow (A \blacktriangleright \mathbb{A}) \otimes H, \quad a \blacktriangleright u \mapsto (a \blacktriangleright u_{\langle 0 \rangle}) \otimes u_{\langle 1 \rangle},$$

and $\mathbb{A} \blacktriangleright B$ becomes a left H -comodule algebra with structure

$$\mathbb{A} \blacktriangleright B \rightarrow H \otimes (\mathbb{A} \blacktriangleright B), \quad u \blacktriangleright b \mapsto u_{[-1]} \otimes (u_{[0]} \blacktriangleright b).$$

Moreover, we have:

Proposition 3.1. ([BPVO]) $(A \blacktriangleright \mathbb{A}) \blacktriangleright B \equiv A \blacktriangleright (\mathbb{A} \blacktriangleright B)$ as algebras. If $\mathbb{A} = H$, this algebra is denoted by $A \# H \# B$ and is called a two-sided smash product.

This result is a particular case of Theorem 2.1. Indeed, define the maps

$$\begin{aligned} R_1 : \mathbb{A} \otimes A &\rightarrow A \otimes \mathbb{A}, & R_1(u \otimes a) &= u_{[-1]} \cdot a \otimes u_{[0]}, \\ R_2 : B \otimes \mathbb{A} &\rightarrow \mathbb{A} \otimes B, & R_2(b \otimes u) &= u_{\langle 0 \rangle} \otimes b \cdot u_{\langle 1 \rangle}, \\ R_3 : B \otimes A &\rightarrow A \otimes B, & R_3(b \otimes a) &= a \otimes b, \end{aligned}$$

which obviously are twisting maps because $A \otimes_{R_1} \mathbb{A} = A \blacktriangleright \mathbb{A}$ and $\mathbb{A} \otimes_{R_2} B = \mathbb{A} \blacktriangleright B$ are associative algebras. Moreover, if we define the maps

$$\begin{aligned} T_1 : B \otimes (A \otimes \mathbb{A}) &\rightarrow (A \otimes \mathbb{A}) \otimes B, & T_1 &:= (A \otimes R_2) \circ (R_3 \otimes \mathbb{A}), \\ T_2 : (\mathbb{A} \otimes B) \otimes A &\rightarrow A \otimes (\mathbb{A} \otimes B), & T_2 &:= (R_1 \otimes B) \circ (\mathbb{A} \otimes R_3), \end{aligned}$$

then one can see that

$$(A \blacktriangleright \mathbb{A}) \otimes_{T_1} B = (A \blacktriangleright \mathbb{A}) \blacktriangleright B, \quad A \otimes_{T_2} (\mathbb{A} \blacktriangleright B) = A \blacktriangleright (\mathbb{A} \blacktriangleright B).$$

3.2. Generalized diagonal crossed products. We recall the construction of the so-called generalized diagonal crossed product, cf. [BPVO], [HN99]. Let H be a Hopf algebra with bijective antipode S , \mathcal{A} an H -bimodule algebra and \mathbb{A} an H -bicomodule algebra. Then the generalized diagonal crossed product $\mathcal{A} \bowtie \mathbb{A}$ is the following associative algebra structure on $\mathcal{A} \otimes \mathbb{A}$:

$$(3.21) \quad (\varphi \bowtie u)(\varphi' \bowtie u') = \varphi(u_{\{-1\}} \cdot \varphi' \cdot S^{-1}(u_{\{1\}})) \bowtie u_{\{0\}}u',$$

for all $\varphi, \varphi' \in \mathcal{A}$ and $u, u' \in \mathbb{A}$, where

$$u_{\{-1\}} \otimes u_{\{0\}} \otimes u_{\{1\}} := u_{<0>[-1]} \otimes u_{<0>[0]} \otimes u_{<1>} = u_{[-1]} \otimes u_{[0]<0>} \otimes u_{[0]<1>}.$$

We recall some facts from [PVO]. Let H be a Hopf algebra with bijective antipode S , \mathcal{A} an H -bimodule algebra and \mathbb{A} an H -bicomodule algebra. Let also A be an algebra in the Yetter-Drinfeld category ${}^H_H\mathcal{YD}$, that is, A is a left H -module algebra, a left H -comodule algebra (with left H -comodule structure denoted by $a \mapsto a_{(-1)} \otimes a_{(0)} \in H \otimes A$) and the Yetter-Drinfeld compatibility condition holds:

$$(3.22) \quad h_1 a_{(-1)} \otimes h_2 \cdot a_{(0)} = (h_1 \cdot a)_{(-1)} h_2 \otimes (h_1 \cdot a)_{(0)}, \quad \forall h \in H, a \in A.$$

Consider first the generalized smash product $\mathcal{A} \blacktriangleright A$, as associative algebra. From the condition (3.22), it follows that $\mathcal{A} \blacktriangleright A$ becomes an H -bimodule algebra, with H -actions

$$\begin{aligned} h \cdot (\varphi \blacktriangleright a) &= h_1 \cdot \varphi \blacktriangleright h_2 \cdot a, \\ (\varphi \blacktriangleright a) \cdot h &= \varphi \cdot h \blacktriangleright a, \end{aligned}$$

for all $h \in H$, $\varphi \in \mathcal{A}$ and $a \in A$, hence we may consider the algebra $(\mathcal{A} \blacktriangleright A) \bowtie \mathbb{A}$.

Then, consider the generalized smash product $A \blacktriangleright \mathbb{A}$, as associative algebra. Using the condition (3.22), one can see that $A \blacktriangleright \mathbb{A}$ becomes an H -bicomodule algebra, with H -coactions

$$\begin{aligned} \rho : A \blacktriangleright \mathbb{A} &\rightarrow (A \blacktriangleright \mathbb{A}) \otimes H, & \rho(a \blacktriangleright u) &= (a \blacktriangleright u_{<0>}) \otimes u_{<1>}, \\ \lambda : A \blacktriangleright \mathbb{A} &\rightarrow H \otimes (A \blacktriangleright \mathbb{A}), & \lambda(a \blacktriangleright u) &= a_{(-1)} u_{[-1]} \otimes (a_{(0)} \blacktriangleright u_{[0]}), \end{aligned}$$

for all $a \in A$ and $u \in \mathbb{A}$, hence we may consider the algebra $\mathcal{A} \bowtie (A \blacktriangleright \mathbb{A})$.

A similar computation to the one in the proof of Proposition 3.4 in [PVO] shows:

Proposition 3.2. *We have an algebra isomorphism $(\mathcal{A} \blacktriangleright A) \bowtie \mathbb{A} \cong \mathcal{A} \bowtie (A \blacktriangleright \mathbb{A})$, given by the trivial identification.*

This result is also a particular case of Theorem 2.1. Indeed, define the maps:

$$\begin{aligned} R_1 : A \otimes \mathcal{A} &\rightarrow \mathcal{A} \otimes A, & R_1(a \otimes \varphi) &= a_{(-1)} \cdot \varphi \otimes a_{(0)}, \\ R_2 : \mathbb{A} \otimes A &\rightarrow A \otimes \mathbb{A}, & R_2(u \otimes a) &= u_{[-1]} \cdot a \otimes u_{[0]}, \\ R_3 : \mathbb{A} \otimes \mathcal{A} &\rightarrow \mathcal{A} \otimes \mathbb{A}, & R_3(u \otimes \varphi) &= u_{\{-1\}} \cdot \varphi \cdot S^{-1}(u_{\{1\}}) \otimes u_{\{0\}}, \end{aligned}$$

which are all twisting maps because $\mathcal{A} \otimes_{R_1} A = \mathcal{A} \blacktriangleright A$, $A \otimes_{R_2} \mathbb{A} = A \blacktriangleright \mathbb{A}$ and $\mathcal{A} \otimes_{R_3} \mathbb{A} = \mathcal{A} \bowtie \mathbb{A}$ are associative algebras. Now, if we define the maps

$$\begin{aligned} T_1 : \mathbb{A} \otimes (\mathcal{A} \otimes A) &\rightarrow (\mathcal{A} \otimes A) \otimes \mathbb{A}, & T_1 &:= (\mathcal{A} \otimes R_2) \circ (R_3 \otimes A), \\ T_2 : (A \otimes \mathbb{A}) \otimes \mathcal{A} &\rightarrow \mathcal{A} \otimes (A \otimes \mathbb{A}), & T_2 &:= (R_1 \otimes \mathbb{A}) \circ (A \otimes R_3), \end{aligned}$$

then one can check that we have

$$(\mathcal{A} \blacktriangleright \triangleleft A) \otimes_{T_1} \mathbb{A} = (\mathcal{A} \blacktriangleright \triangleleft A) \bowtie \mathbb{A}, \quad \mathcal{A} \otimes_{T_2} (A \blacktriangleright \triangleleft \mathbb{A}) = \mathcal{A} \bowtie (A \blacktriangleright \triangleleft \mathbb{A}),$$

hence indeed we recover Proposition 3.2.

3.3. The noncommutative $2n$ -planes. Recall from section 1 that the noncommutative plane associated to an antisymmetric matrix, $\theta = (\theta_{\mu\nu}) \in \mathcal{M}_n(\mathbb{R})$, is the associative algebra $C_{alg}(\mathbb{R}^{2n}_\theta)$ generated by $2n$ elements $\{z^\mu, \bar{z}^\mu\}_{\mu=1, \dots, n}$ with relations

$$\left. \begin{aligned} z^\mu z^\nu &= \lambda^{\mu\nu} z^\nu z^\mu \\ \bar{z}^\mu \bar{z}^\nu &= \lambda^{\mu\nu} \bar{z}^\nu \bar{z}^\mu \\ \bar{z}^\mu z^\nu &= \lambda^{\nu\mu} z^\nu \bar{z}^\mu \end{aligned} \right\} \forall \mu, \nu = 1, \dots, n, \text{ being } \lambda^{\mu\nu} := e^{i\theta_{\mu\nu}},$$

and endowed with the $*$ -operation induced by $(z^\mu)^* := \bar{z}^\mu$ (cf. [CDV02]).

Observe that as θ is antisymmetric, we have that $z^\mu \bar{z}^\mu = \bar{z}^\mu z^\mu$, so for every $\mu = 1, \dots, n$ the algebra A_μ generated by the elements z^μ and \bar{z}^μ is commutative, so $A_\mu \cong \mathbb{C}[z^\mu, \bar{z}^\mu]$. We have then n commutative algebras (indeed, n copies of the polynomial algebra in two variables) contained in the noncommutative plane. Consider, for $\mu < \nu$, the mappings defined on generators by

$$\begin{aligned} R_{\mu\nu} : \mathbb{C}[z^\nu, \bar{z}^\nu] \otimes \mathbb{C}[z^\mu, \bar{z}^\mu] &\longrightarrow \mathbb{C}[z^\mu, \bar{z}^\mu] \otimes \mathbb{C}[z^\nu, \bar{z}^\nu], \\ z^\nu \otimes z^\mu &\longmapsto \lambda^{\nu\mu} z^\mu \otimes z^\nu, \\ \bar{z}^\nu \otimes \bar{z}^\mu &\longmapsto \lambda^{\nu\mu} \bar{z}^\mu \otimes \bar{z}^\nu, \\ \bar{z}^\nu \otimes z^\mu &\longmapsto \lambda^{\mu\nu} z^\mu \otimes \bar{z}^\nu, \\ z^\nu \otimes \bar{z}^\mu &\longmapsto \lambda^{\mu\nu} \bar{z}^\mu \otimes z^\nu. \end{aligned}$$

Obviously these formulae extend in a unique way to (unital) twisting maps $R_{\mu\nu}$. Condition (1.10) is trivially satisfied, so every possible twisted tensor product is still a $*$ -algebra. As on the algebra generators our twisting map is just the usual flip multiplied by a constant, the hexagon condition is also satisfied in a straightforward way. The iterated twisted tensor product

$$C[z^1, \bar{z}^1] \otimes_{R_{12}} C[z^2, \bar{z}^2] \otimes_{R_{23}} \cdots \otimes_{R_{n-1n}} C[z^n, \bar{z}^n]$$

is isomorphic to the noncommutative $2n$ -plane $C_{alg}(\mathbb{R}^{2n}_\theta)$. Furthermore, for every $\mu = 1, \dots, n$, let $\Omega_\mu := \Omega_{alg}(\mathbb{R}^2)$ be the graded differential algebra of algebraic differential forms build over the algebra $\mathbb{C}[z^\mu, \bar{z}^\mu]$, and observe that for $\mu < \nu$ the map $\bar{R}_{\mu\nu} : \Omega_\nu \otimes \Omega_\mu \longrightarrow \Omega_\mu \otimes \Omega_\nu$ defined on generators by

$$\begin{aligned} z^\nu \otimes z^\mu &\longmapsto \lambda^{\nu\mu} z^\mu \otimes z^\nu, & \bar{z}^\nu \otimes \bar{z}^\mu &\longmapsto \lambda^{\nu\mu} \bar{z}^\mu \otimes \bar{z}^\nu, \\ \bar{z}^\nu \otimes z^\mu &\longmapsto \lambda^{\mu\nu} z^\mu \otimes \bar{z}^\nu, & z^\nu \otimes \bar{z}^\mu &\longmapsto \lambda^{\mu\nu} \bar{z}^\mu \otimes z^\nu, \\ dz^\nu \otimes dz^\mu &\longmapsto -\lambda^{\nu\mu} dz^\mu \otimes dz^\nu, & d\bar{z}^\nu \otimes d\bar{z}^\mu &\longmapsto -\lambda^{\nu\mu} d\bar{z}^\mu \otimes d\bar{z}^\nu, \\ d\bar{z}^\nu \otimes dz^\mu &\longmapsto -\lambda^{\mu\nu} dz^\mu \otimes d\bar{z}^\nu, & dz^\nu \otimes d\bar{z}^\mu &\longmapsto -\lambda^{\mu\nu} d\bar{z}^\mu \otimes dz^\nu, \\ z^\nu \otimes dz^\mu &\longmapsto \lambda^{\nu\mu} dz^\mu \otimes z^\nu, & \bar{z}^\nu \otimes d\bar{z}^\mu &\longmapsto \lambda^{\nu\mu} d\bar{z}^\mu \otimes \bar{z}^\nu, \\ \bar{z}^\nu \otimes dz^\mu &\longmapsto \lambda^{\mu\nu} dz^\mu \otimes \bar{z}^\nu, & z^\nu \otimes d\bar{z}^\mu &\longmapsto \lambda^{\mu\nu} d\bar{z}^\mu \otimes z^\nu, \end{aligned}$$

extends in a unique way to a twisting map defined on $\Omega_\nu \otimes \Omega_\mu$. This twisting map satisfies conditions (1.13) and (1.14), hence, by the uniqueness of the twisting map extension to the algebras

of differential forms given by Theorem 1.3, the maps $\overline{R}_{\mu\nu}$ coincide with the maps $\widetilde{R}_{\mu\nu}$ obtained in the theorem. So, by applying Theorem 2.16 it follows that they are compatible twisting maps. It is then easy to check that the iterated twisted tensor product $\Omega_1 \otimes_{\overline{R}_{12}} \cdots \otimes_{\overline{R}_{n-1n}} \Omega_n$ is isomorphic, as a graded (involutive) differential algebra, to the algebra $\Omega_{alg}(\mathbb{R}_\theta^{2n})$ of algebraic differential forms on the noncommutative $2n$ -plane.

3.4. The Observable Algebra of Nill–Szlachányi. In [NS97], Nill and Szlachányi construct, given a finite dimensional C^* -Hopf algebra H and its dual \hat{H} , the *algebra of observables*, denoted by \mathcal{A} , by means of the smash products defined by the natural actions existing between H and \hat{H} . Their interest in studying such an algebra arises as it turns out to be the *observable algebra of a generalized quantum spin chain with H -order and \hat{H} -disorder symmetries*, and they also observe that when $H = \mathbb{C}G$ is a group algebra this algebra \mathcal{A} becomes an ordinary G -spin model. We do not need here the physical interpretation of this algebra, our aim is to show that the construction of the algebra \mathcal{A} carried out in [NS97] fits inside our framework of iterated twisted tensor products.

We start by fixing H a finite dimensional C^* -Hopf algebra, that is, a C^* -algebra endowed with a comultiplication $\Delta : H \rightarrow H \otimes H$, a counit $\varepsilon : H \rightarrow \mathbb{C}$ and an antipode $S : H \rightarrow H$ satisfying the usual compatibility relations required for defining Hopf algebras, and with the extra assumptions that Δ and ε are $*$ -algebra morphisms, and such that $S(S(x)^*)^* = x$ for all $x \in H$ (see [Kas95, Section IV.8] for details). If H is a $*$ -Hopf algebra, it follows that $S^{-1} = \bar{S} = * \circ S \circ *$ is the antipode of the opposite Hopf algebra H_{op} (see [Swe69] for details). The dual Hopf algebra of a $*$ -Hopf algebra is also a $*$ -Hopf algebra, with involution given by $\varphi^* := \overline{S(\varphi_*)}$, where $\varphi \mapsto \varphi_*$ is the antilinear involutive algebra automorphism given by $\varphi_*(x) := \overline{\varphi(x^*)}$. We have canonical pairings between H and \hat{H} given by

$$\begin{aligned} \langle , \rangle : H \otimes \hat{H} &\rightarrow \mathbb{C}, & a \otimes \varphi &\mapsto \langle a, \varphi \rangle := \varphi(a), \\ \langle , \rangle : \hat{H} \otimes H &\rightarrow \mathbb{C}, & \varphi \otimes a &\mapsto \langle \varphi, a \rangle := \varphi(a), \end{aligned}$$

that give a structure of *dual pairing of Hopf algebras* between H and \hat{H} . Associated to this pairing we have the natural actions

$$\begin{aligned} \triangleright : H \otimes \hat{H} &\rightarrow \hat{H}, & a \otimes \varphi &\mapsto \varphi_1 \langle a, \varphi_2 \rangle, \\ \triangleleft : \hat{H} \otimes H &\rightarrow \hat{H}, & \varphi \otimes a &\mapsto \langle \varphi_1, a \rangle \varphi_2. \end{aligned}$$

Now, for every $i \in \mathbb{Z}$, let us take $A_i := \hat{H}$ if i is odd and $A_i := H$ if i is even, and define the maps:

$$\begin{aligned} R_{2k\ 2k+1} : A_{2k+1} \otimes A_{2k} &\longrightarrow A_{2k} \otimes A_{2k+1}, \\ \varphi \otimes a &\longmapsto (\varphi_1 \triangleright a) \otimes \varphi_2 = a_1 \langle a_2, \varphi_1 \rangle \otimes \varphi_2, \\ R_{2k-1\ 2k} : A_{2k} \otimes A_{2k-1} &\longrightarrow A_{2k-1} \otimes A_{2k}, \\ a \otimes \varphi &\longmapsto (a_1 \triangleright \varphi) \otimes a_2 = \varphi_1 \langle \varphi_2, a_1 \rangle \otimes a_2, \\ R_{ij} : A_j \otimes A_i &\longrightarrow A_i \otimes A_j, \\ a \otimes b &\longmapsto b \otimes a, \quad \text{whenever } j - i > 2. \end{aligned}$$

As all the maps R_{ij} are either usual flips or the maps induced by a module algebra action, it is clear that all of them are twisting maps. Furthermore, it is easy to check that they satisfy condition (1.10), so they define an involution on every twisted tensor product. Let us now check that these maps are compatible. More precisely, let $i < j < k$, and consider the three maps R_{ij} , R_{jk} , and R_{ik} , and let us check that they satisfy the hexagon equation. We have to distinguish among several cases:

- If both $|j - i|, |k - j| \geq 2$, all three maps are just usual flips, and thus the hexagon condition is trivially satisfied.
- If $|j - i| = 1, |k - j| \geq 2$, then we have that both R_{ik} and R_{jk} are usual flips, and so the compatibility of R_{ij} with them follows from Lemma 2.17. The same thing happens if $|k - j| = 1, |j - i| \geq 2$.
- If $j = i + 1, k = i + 2$, then only the map $R_{i,i+2}$ is a flip. Then we face two possible situations.

If $i = 2n - 1$ is odd, then, describing explicitly the maps, we have that

$$\begin{aligned} R_{2n-1,2n}(a \otimes \varphi) &= \langle \varphi_2, a_1 \rangle \varphi_1 \otimes a_2, \\ R_{2n,2n+1}(\varphi \otimes b) &= \langle b_2, \varphi_1 \rangle b_1 \otimes \varphi_2. \end{aligned}$$

Hence, applying the left-hand side of the hexagon equation to a generator $a \otimes \varphi \otimes b$ of $A_{2n+1} \otimes A_{2n} \otimes A_{2n-1} = H \otimes \hat{H} \otimes H$, we have

$$\begin{aligned} (A_{2n-1} \otimes R_{2n,2n-1})(\tau \otimes A_{2n})(A_{2n-1} \otimes R_{2n-1,2n})(a \otimes b \otimes c) \\ &= (A_{2n-1} \otimes R_{2n,2n-1})(\tau \otimes A_{2n})(\langle b_2, \varphi_1 \rangle a \otimes b_1 \otimes \varphi_2) \\ &= (A_{2n-1} \otimes R_{2n,2n-1})(\langle b_2, \varphi_1 \rangle a \otimes \varphi_2 \otimes b_1) \\ &= \langle b_2, \varphi_1 \rangle \langle \varphi_3, a_1 \rangle b_1 \otimes \varphi_2 \otimes a_2. \end{aligned}$$

On the other hand, for the right hand side we get

$$\begin{aligned} (R_{2n-1,2n} \otimes A_{2n+1})(A_{2n} \otimes \tau)(R_{2n,2n+1} \otimes A_{2n-1})(a \otimes \varphi \otimes b) \\ &= (R_{2n-1,2n} \otimes A_{2n+1})(A_{2n} \otimes \tau)(\langle \varphi_2, a_1 \rangle \varphi_1 \otimes a_1 \otimes b) \\ &= (R_{2n-1,2n} \otimes A_{2n+1})(\langle \varphi_2, a_1 \rangle \varphi_1 \otimes b \otimes a_1) \\ &= \langle b_2, \varphi_1 \rangle \langle \varphi_3, a_1 \rangle b_1 \otimes \varphi_2 \otimes a_2, \end{aligned}$$

where for both expressions we are using the coassociativity of \hat{H} . This proves the hexagon condition for i odd. For i even, the proof is very similar.

Now, once proven that any three twisting maps chosen from the above ones are compatible, we can apply the Coherence Theorem and build any iterated twisted tensor product of these algebras. In particular, for any $n \leq m \in \mathbb{Z}$ we may define the algebras

$$A_{n,m} := A_n \otimes_{R_{n,n+1}} A_{n+1} \otimes \cdots \otimes_{R_{m-1,m}} A_m.$$

It is easy to see that if $n' \leq n$ and $m \leq m'$, then $A_{n,m} \subseteq A_{n',m'}$ and hence the inclusions give us a direct system of algebras $\{A_{n,m}\}_{n,m \in \mathbb{Z}}$, being its direct limit $\varinjlim A_{n,m}$ precisely the observable algebra \mathcal{A} defined in [NS97]. Furthermore, as the action that defines the twisting map is a $*$ -Hopf algebra action, we have an involution defined on any of these products, and

all the involved algebras being of finite dimension, we have no problem involving nuclearity nor completeness, and henceforth all the algebras $A_{n,m}$ are well defined, finite dimensional C^* -algebras (a fact that was proven in [NS97] using representations of these algebras on some Hilbert spaces). In particular, we get a new proof of the fact that the algebra \mathcal{A} is an AF-algebra.

4. INVARIANCE UNDER TWISTING

We begin this section with a result which does not involve a twisted tensor product of algebras and which is of independent interest.

Proposition 4.1. *Let A, B be two algebras and $R : B \otimes A \rightarrow A \otimes B$ a linear map, with notation $R(b \otimes a) = a_R \otimes b_R$, for all $a \in A$ and $b \in B$. Assume that we are given two linear maps, $\mu : B \otimes A \rightarrow A$, $\mu(b \otimes a) = b \cdot a$, and $\rho : A \rightarrow A \otimes B$, $\rho(a) = a_{(0)} \otimes a_{(1)}$, and denote $a * a' := a_{(0)}(a_{(1)} \cdot a')$, for all $a, a' \in A$. Assume that the following conditions are satisfied: $\rho(1) = 1 \otimes 1$, $1 \cdot a = a$, $a_{(0)}(a_{(1)} \cdot 1) = a$, for all $a \in A$, and*

$$(4.1) \quad b \cdot (a * a') = a_{(0)R}(b_R a_{(1)} \cdot a'),$$

$$(4.2) \quad \rho(a * a') = a_{(0)} a'_{(0)R} \otimes a_{(1)R} a'_{(1)},$$

for all $a, a' \in A$ and $b \in B$. Then $(A, *, 1)$ is an associative unital algebra, denoted in what follows by A^d .

PROOF Obviously 1 is the unit, so we only prove the associativity of $*$; we compute:

$$\begin{aligned} (a * a') * a'' &= (a * a')_{(0)}((a * a')_{(1)} \cdot a'') \\ &\stackrel{(4.2)}{=} a_{(0)} a'_{(0)R} (a_{(1)R} a'_{(1)} \cdot a''), \end{aligned}$$

$$\begin{aligned} a * (a' * a'') &= a_{(0)}(a_{(1)} \cdot (a' * a'')) \\ &\stackrel{(4.1)}{=} a_{(0)} a'_{(0)R} (a_{(1)R} a'_{(1)} \cdot a''), \end{aligned}$$

and we see that the two terms are equal. \square

Remark 4.2. *The datum in Proposition 4.1 is a generalization of the left-right version of a so-called left twisting datum in [FST99], which is obtained if B is a bialgebra and the map R is given by $R(b \otimes a) = b_1 \cdot a \otimes b_2$.*

As a consequence of Proposition 4.1 we can obtain the following result from [BCZ96]:

Corollary 4.3. ([BCZ96]) *Let H be a bialgebra and A a right H -comodule algebra with comodule structure $A \rightarrow A \otimes H$, $a \mapsto a_{(0)} \otimes a_{(1)}$, together with a linear map $H \otimes A \rightarrow A$, $h \otimes a \mapsto h \cdot a$, satisfying $1 \cdot a = a$, $h \cdot 1 = \varepsilon(h)1$, for all $h \in H$, $a \in A$, and*

$$(4.3) \quad (h_2 \cdot a)_{(0)} \otimes h_1(h_2 \cdot a)_{(1)} = h_1 \cdot a_{(0)} \otimes h_2 a_{(1)},$$

$$(4.4) \quad h \cdot (a * a') = (h_1 \cdot a_{(0)})(h_2 a_{(1)} \cdot a'),$$

where we denoted $a * a' = a_{(0)}(a_{(1)} \cdot a')$. Then $(A, *, 1)$ is an associative algebra.

PROOF We take $B = H$ and $R : H \otimes A \rightarrow A \otimes H$, $R(h \otimes a) = h_1 \cdot a \otimes h_2$. Then (4.1) is exactly (4.4) and (4.2) is an easy consequence of (4.3) and of the fact that A is a comodule algebra. \square

Theorem 4.4. *Assume that the hypotheses of Proposition 4.1 are satisfied, such that moreover R is a twisting map. Assume also that we are given a linear map $\lambda : A \rightarrow A \otimes B$, with notation $\lambda(a) = a_{[0]} \otimes a_{[1]}$, such that $\lambda(1) = 1 \otimes 1$ and the following relations hold:*

$$(4.5) \quad \lambda(aa') = a_{[0]} * (a'_R)_{[0]} \otimes (a'_R)_{[1]}(a_{[1]})_R,$$

$$(4.6) \quad a_{(0)[0]} \otimes a_{(0)[1]} a_{(1)} = a \otimes 1,$$

$$(4.7) \quad a_{0} \otimes a_{[0](1)} a_{[1]} = a \otimes 1,$$

for all $a, a' \in A$. Define the map

$$(4.8) \quad R^d : B \otimes A^d \rightarrow A^d \otimes B, \quad R^d(b \otimes a) = (a_{(0)R})_{[0]} \otimes (a_{(0)R})_{[1]} b_R a_{(1)}.$$

Then R^d is a twisting map and we have an algebra isomorphism

$$A^d \otimes_{R^d} B \simeq A \otimes_R B, \quad a \otimes b \mapsto a_{(0)} \otimes a_{(1)} b.$$

PROOF It is easy to see that R^d satisfies (1.6). We check (1.3) for R^d ; we compute (denoting also $R = r = \mathcal{R} = \bar{r}$ copies of R):

$$\begin{aligned} (a * a')_{R^d} \otimes b_{R^d} &= ((a * a')_{(0)R})_{[0]} \otimes ((a * a')_{(0)R})_{[1]} b_R (a * a')_{(1)} \\ &\stackrel{(4.2)}{=} ((a_{(0)} a'_{(0)r})_R)_{[0]} \otimes ((a_{(0)} a'_{(0)r})_R)_{[1]} b_R a_{(1)r} a'_{(1)} \\ &\stackrel{(1.3)}{=} (a_{(0)R} (a'_{(0)r})_{\mathcal{R}})_{[0]} \otimes (a_{(0)R} (a'_{(0)r})_{\mathcal{R}})_{[1]} (b_R)_{\mathcal{R}} a_{(1)r} a'_{(1)} \\ &\stackrel{(4.5)}{=} (a_{(0)R})_{[0]} * (((a'_{(0)r})_{\mathcal{R}})_{\bar{r}})_{[0]} \otimes (((a'_{(0)r})_{\mathcal{R}})_{\bar{r}})_{[1]} ((a_{(0)R})_{[1]})_{\bar{r}} \\ &\quad (b_R)_{\mathcal{R}} a_{(1)r} a'_{(1)}, \end{aligned}$$

$$\begin{aligned} a_{R^d} * a'_{r^d} \otimes (b_{R^d})_{r^d} &= (a_{(0)R})_{[0]} * a'_{r^d} \otimes ((a_{(0)R})_{[1]} b_R a_{(1)})_{r^d} \\ &= (a_{(0)R})_{[0]} * (a'_{(0)r})_{[0]} \otimes (a'_{(0)r})_{[1]} ((a_{(0)R})_{[1]} b_R a_{(1)})_r a'_{(1)} \\ &\stackrel{(1.4)}{=} (a_{(0)R})_{[0]} * (((a'_{(0)r})_{\mathcal{R}})_{\bar{r}})_{[0]} \otimes (((a'_{(0)r})_{\mathcal{R}})_{\bar{r}})_{[1]} ((a_{(0)R})_{[1]})_{\bar{r}} \\ &\quad (b_R)_{\mathcal{R}} a_{(1)r} a'_{(1)}, \end{aligned}$$

and we see that the two terms coincide. Now we check (1.4) for R^d ; we compute:

$$\begin{aligned} a_{R^d} \otimes (bb')_{R^d} &= (a_{(0)R})_{[0]} \otimes (a_{(0)R})_{[1]} (bb')_R a_{(1)} \\ &\stackrel{(1.4)}{=} ((a_{(0)R})_r)_{[0]} \otimes ((a_{(0)R})_r)_{[1]} b_r b'_R a_{(1)}, \\ (a_{R^d})_{r^d} \otimes b_{r^d} b'_{R^d} &= ((a_{(0)R})_{[0]})_{r^d} \otimes b_{r^d} (a_{(0)R})_{[1]} b'_R a_{(1)} \\ &= (((a_{(0)R})_{[0]})_{(0)r})_{[0]} \otimes (((a_{(0)R})_{[0]})_{(0)r})_{[1]} b_r \\ &\quad ((a_{(0)R})_{[0]})_{(1)} (a_{(0)R})_{[1]} b'_R a_{(1)} \\ &\stackrel{(4.7)}{=} ((a_{(0)R})_r)_{[0]} \otimes ((a_{(0)R})_r)_{[1]} b_r b'_R a_{(1)}, \end{aligned}$$

and we see that the two terms coincide, hence indeed R^d is a twisting map. We prove now that the map $\varphi : A^d \otimes_{R^d} B \rightarrow A \otimes_R B$, $\varphi(a \otimes b) = a_{(0)} \otimes a_{(1)} b$, is an algebra isomorphism.

First, using (4.6) and (4.7), it is easy to see that φ is bijective, with inverse given by $a \otimes b \mapsto a_{[0]} \otimes a_{[1]} b$. It is obvious that $\varphi(1 \otimes 1) = 1 \otimes 1$, so we only have to prove that φ is multiplicative. We compute:

$$\begin{aligned}
\varphi((a \otimes b)(a' \otimes b')) &= \varphi(a * a'_{R^d} \otimes b_{R^d} b') \\
&= \varphi(a * (a'_{(0)_R})_{[0]} \otimes (a'_{(0)_R})_{[1]} b_{R^d} a'_{(1)} b') \\
&= (a * (a'_{(0)_R})_{[0]})_{(0)} \otimes (a * (a'_{(0)_R})_{[0]})_{(1)} (a'_{(0)_R})_{[1]} b_{R^d} a'_{(1)} b' \\
&\stackrel{(4.2)}{=} a_{(0)} (((a'_{(0)_R})_{[0]})_{(0)})_r \otimes a_{(1)_r} ((a'_{(0)_R})_{[0]})_{(1)} (a'_{(0)_R})_{[1]} b_{R^d} a'_{(1)} b' \\
&\stackrel{(4.7)}{=} a_{(0)} (a'_{(0)_R})_r \otimes a_{(1)_r} b_{R^d} a'_{(1)} b',
\end{aligned}$$

$$\begin{aligned}
\varphi(a \otimes b) \varphi(a' \otimes b') &= (a_{(0)} \otimes a_{(1)} b) (a'_{(0)} \otimes a'_{(1)} b') \\
&= a_{(0)} a'_{(0)_R} \otimes (a_{(1)} b)_{R^d} a'_{(1)} b' \\
&\stackrel{(1.4)}{=} a_{(0)} (a'_{(0)_R})_r \otimes a_{(1)_r} b_{R^d} a'_{(1)} b',
\end{aligned}$$

finishing the proof. \square

Let H be a bialgebra and $F \in H \otimes H$ a 2-cocycle, that is F is invertible and satisfies

$$\begin{aligned}
(\varepsilon \otimes id)(F) &= (id \otimes \varepsilon)(F) = 1, \\
(1 \otimes F)(id \otimes \Delta)(F) &= (F \otimes 1)(\Delta \otimes id)(F).
\end{aligned}$$

We denote $F = F^1 \otimes F^2$ and $F^{-1} = G^1 \otimes G^2$. We denote by H_F the Drinfeld twist of H , which is a bialgebra having the same algebra structure as H and comultiplication given by $\Delta_F(h) = F \Delta(h) F^{-1}$, for all $h \in H$.

If A is a left H -module algebra (with H -action denoted by $h \otimes a \mapsto h \cdot a$), the invariance under twisting of the smash product $A \# H$ is the following result (see [Maj97], [BPVO00]). Define a new multiplication on A , by $a * a' = (G^1 \cdot a)(G^2 \cdot a')$, for all $a, a' \in A$, and denote by $A_{F^{-1}}$ the new structure; then $A_{F^{-1}}$ is a left H_F -module algebra (with the same action as for A) and we have an algebra isomorphism

$$(4.9) \quad A_{F^{-1}} \# H_F \simeq A \# H, \quad a \# h \mapsto G^1 \cdot a \# G^2 h.$$

We prove that this result is a particular case of Theorem 4.4.

We take $B = H$ and $R : H \otimes A \rightarrow A \otimes H$, $R(h \otimes a) = h_1 \cdot a \otimes h_2$, hence $A \otimes_R B = A \# H$. Define the maps

$$\begin{aligned}
\mu : H \otimes A &\rightarrow A, \quad \mu(h \otimes a) = h \cdot a, \\
\rho : A &\rightarrow A \otimes H, \quad \rho(a) = G^1 \cdot a \otimes G^2, \\
\lambda : A &\rightarrow A \otimes H, \quad \lambda(a) = F^1 \cdot a \otimes F^2,
\end{aligned}$$

hence the corresponding product $*$ on A is given by

$$a * a' = a_{(0)}(a_{(1)} \cdot a') = (G^1 \cdot a)(G^2 \cdot a'),$$

which is exactly the product of $A_{F^{-1}}$. One can check, by direct computation, that all the necessary conditions for applying Theorem 4.4 are satisfied, hence we have the twisting map $R^d : H \otimes A_{F^{-1}} \rightarrow A_{F^{-1}} \otimes H$, which looks as follows:

$$\begin{aligned}
R^d(h \otimes a) &= (a_{(0)R})_{[0]} \otimes (a_{(0)R})_{[1]} h_R a_{(1)} \\
&= (h_1 \cdot a_{(0)})_{[0]} \otimes (h_1 \cdot a_{(0)})_{[1]} h_2 a_{(1)} \\
&= (h_1 G^1 \cdot a)_{[0]} \otimes (h_1 G^1 \cdot a)_{[1]} h_2 G^2 \\
&= F^1 h_1 G^1 \cdot a \otimes F^2 h_2 G^2 \\
&= h_{(1)} \cdot a \otimes h_{(2)},
\end{aligned}$$

where we denoted by $\Delta_F(h) = h_{(1)} \otimes h_{(2)}$ the comultiplication of H_F . Hence, we obtain that $A^d \otimes_{R^d} B = A_{F^{-1}} \otimes_{R^d} H = A_{F^{-1}} \# H_F$, and it is obvious that the isomorphism $A^d \otimes_{R^d} B \simeq A \otimes_R B$ provided by Theorem 4.4 coincides with the one given by (4.9).

Let H be a finite dimensional Hopf algebra with antipode S . As before, we work with the realization of the Drinfeld double on $H^{*cop} \otimes H$. A well-known theorem of Majid (see [Maj91]) asserts that if (H, r) is quasitriangular then the Drinfeld double of H is isomorphic to an ordinary smash product. More explicitly, for the realization of $D(H)$ we work with, the isomorphism is given as follows. First, we have a left H -module algebra structure on H^* , denoted by \underline{H}^* , given by (we denote $r = r^1 \otimes r^2$):

$$\begin{aligned}
h \cdot \varphi &= h_1 \rightharpoonup \varphi \leftarrow S^{-1}(h_2), \\
\varphi * \varphi' &= (\varphi \leftarrow S^{-1}(r^1))(r_1^2 \rightharpoonup \varphi' \leftarrow S^{-1}(r_2^2)),
\end{aligned}$$

for all $h \in H$ and $\varphi, \varphi' \in H^*$, and then we have an algebra isomorphism

$$(4.10) \quad \underline{H}^* \# H \simeq D(H), \quad \varphi \# h \mapsto \varphi \leftarrow S^{-1}(r^1) \otimes r^2 h.$$

We prove now that this result is also a particular case of Theorem 4.4.

We take $A = H^*$, with its ordinary algebra structure, $B = H$, and $R : H \otimes H^* \rightarrow H^* \otimes H$, $R(h \otimes \varphi) = h_1 \rightharpoonup \varphi \leftarrow S^{-1}(h_3) \otimes h_2$, hence $A \otimes_R B = D(H)$. Denoting $r^{-1} = u^1 \otimes u^2$, we define the maps:

$$\begin{aligned}
\mu : H \otimes H^* &\rightarrow H^*, & \mu(h \otimes \varphi) &= h \cdot \varphi = h_1 \rightharpoonup \varphi \leftarrow S^{-1}(h_2), \\
\rho : H^* &\rightarrow H^* \otimes H, & \rho(\varphi) &= \varphi \leftarrow S^{-1}(r^1) \otimes r^2, \\
\lambda : H^* &\rightarrow H^* \otimes H, & \lambda(\varphi) &= \varphi \leftarrow S^{-1}(u^1) \otimes u^2,
\end{aligned}$$

hence the corresponding product $*$ on H^* is given by

$$\begin{aligned}
\varphi * \varphi' &= \varphi_{(0)}(\varphi_{(1)} \cdot \varphi') \\
&= (\varphi \leftarrow S^{-1}(r^1))(r^2 \cdot \varphi') \\
&= (\varphi \leftarrow S^{-1}(r^1))(r_1^2 \rightharpoonup \varphi' \leftarrow S^{-1}(r_2^2)),
\end{aligned}$$

which is exactly the product of \underline{H}^* . One can check, by direct computation, that all the necessary conditions for applying Theorem 4.4 are satisfied, hence we have the twisting map

$R^d : H \otimes \underline{H}^* \rightarrow \underline{H}^* \otimes H$, which looks as follows:

$$\begin{aligned}
R^d(h \otimes \varphi) &= (\varphi_{(0)_R})_{[0]} \otimes (\varphi_{(0)_R})_{[1]} h_R \varphi_{(1)} \\
&= \varphi_{(0)_R} \leftarrow S^{-1}(u^1) \otimes u^2 h_R \varphi_{(1)} \\
&= (\varphi \leftarrow S^{-1}(r^1))_R \leftarrow S^{-1}(u^1) \otimes u^2 h_R r^2 \\
&= h_1 \rightarrow \varphi \leftarrow S^{-1}(r^1) S^{-1}(h_3) S^{-1}(u^1) \otimes u^2 h_2 r^2 \\
&= h_1 \rightarrow \varphi \leftarrow S^{-1}(u^1 h_3 r^1) \otimes u^2 h_2 r^2 \\
&= h_1 \rightarrow \varphi \leftarrow S^{-1}(h_2) \otimes h_3 \\
&= h_1 \cdot \varphi \otimes h_2
\end{aligned}$$

(for the sixth equality we used the fact that $\Delta^{cop}(h)r = r\Delta(h)$), hence we obtain that $A^d \otimes_{R^d} B = \underline{H}^* \otimes_{R^d} H = \underline{H}^* \# H$, and it is obvious that the isomorphism $A^d \otimes_{R^d} B \simeq A \otimes_R B$ provided by Theorem 4.4 coincides with the one given by (4.10).

Proposition 4.1 and Theorem 4.4 admit right-left versions, whose proofs are similar to the left-right versions above and therefore will be omitted:

Proposition 4.5. *Let B, C be two algebras and $R : C \otimes B \rightarrow B \otimes C$ a linear map, with notation $R(c \otimes b) = b_R \otimes c_R$, for all $b \in B$ and $c \in C$. Assume that we are given two linear maps, $\nu : C \otimes B \rightarrow C$, $\nu(c \otimes b) = c \cdot b$, and $\theta : C \rightarrow B \otimes C$, $\theta(c) = c_{<-1>} \otimes c_{<0>}$, and denote $c * c' = (c \cdot c'_{<-1>}) c'_{<0>}$, for all $c, c' \in C$. Assume that the following conditions are satisfied: $\theta(1) = 1 \otimes 1$, $c \cdot 1 = c$, $(1 \cdot c_{<-1>}) c_{<0>} = c$, for all $c \in C$, and*

$$(4.11) \quad (c * c') \cdot b = (c \cdot c'_{<-1>} b_R) c'_{<0>_R},$$

$$(4.12) \quad \theta(c * c') = c_{<-1>} c'_{<-1>_R} \otimes c_{<0>_R} c'_{<0>},$$

for all $c, c' \in C$ and $b \in B$. Then $(C, *, 1)$ is an associative unital algebra, denoted in what follows by ${}^d C$.

Theorem 4.6. *Assume that the hypotheses of Proposition 4.5 are satisfied, such that moreover R is a twisting map. Assume also that we are given a linear map $\gamma : C \rightarrow B \otimes C$, with notation $\gamma(c) = c_{\{-1\}} \otimes c_{\{0\}}$, such that $\gamma(1) = 1 \otimes 1$ and the following relations hold:*

$$(4.13) \quad \gamma(cc') = c'_{\{-1\}_R} (c_R)_{\{-1\}} \otimes (c_R)_{\{0\}} * c'_{\{0\}},$$

$$(4.14) \quad c_{<-1>} c_{<0>_{\{-1\}}} \otimes c_{<0>_{\{0\}}} = 1 \otimes c,$$

$$(4.15) \quad c_{\{-1\}} c_{\{0\}_{<-1>}} \otimes c_{\{0\}_{<0>}} = 1 \otimes c,$$

for all $c, c' \in C$. Define the map

$$(4.16) \quad {}^d R : {}^d C \otimes B \rightarrow B \otimes {}^d C, \quad {}^d R(c \otimes b) = c_{<-1>} b_R (c_{<0>_R})_{\{-1\}} \otimes (c_{<0>_R})_{\{0\}}.$$

Then ${}^d R$ is a twisting map and we have an algebra isomorphism

$$B \otimes_{{}^d R} {}^d C \simeq B \otimes_R C, \quad b \otimes c \mapsto b c_{<-1>} \otimes c_{<0>}.$$

A particular case of Theorem 4.6 is the invariance under twisting of the right smash product from [BPVO]. Namely, let H be a bialgebra, C a right H -module algebra (with action denoted by $c \otimes h \mapsto c \cdot h$) and $F \in H \otimes H$ a 2-cocycle. The right smash product $H \# C$ has multiplication

$$(h \# c)(h' \# c') = h h'_1 \# (c \cdot h'_2) c'.$$

If we define a new multiplication on C , by $c * c' = (c \cdot F^1)(c' \cdot F^2)$ and denote the new structure by ${}_F C$, then ${}_F C$ becomes a right H_F -module algebra and we have an algebra isomorphism $H_F \# {}_F C \simeq H \# C$, $h \# c \mapsto h F^1 \# c \cdot F^2$, see [BPVO]. This result may be reobtained as a consequence of Theorem 4.6, by taking $B = H$, $R(c \otimes h) = h_1 \otimes c \cdot h_2$, $\nu(c \otimes h) = c \cdot h$, $\theta(c) = F^1 \otimes c \cdot F^2$, $\gamma(c) = G^1 \otimes c \cdot G^2$, where we denoted as before $F^{-1} = G^1 \otimes G^2$.

A careful look at the proof of Theorem 4.4 shows that actually it admits a more general form, which we record here for further use (the same holds for Theorem 4.6).

Theorem 4.7. *Let $A \otimes_R B$ be a twisted tensor product of algebras, and denote the multiplication of A by $a \otimes a' \mapsto aa'$. Assume that on the vector space A we have one more algebra structure, denoted by A' , with the same unit as A and multiplication denoted by $a \otimes a' \mapsto a * a'$ (for instance, A' may be A itself or A^d as in Proposition 4.1). Assume that we are given two linear maps $\rho, \lambda : A \rightarrow A \otimes B$, with notation $\rho(a) = a_{(0)} \otimes a_{(1)}$ and $\lambda(a) = a_{[0]} \otimes a_{[1]}$, such that ρ is an algebra map from A' to $A \otimes_R B$, $\lambda(1) = 1 \otimes 1$ and relations (4.5), (4.6), (4.7) are satisfied. Then the map*

$$(4.17) \quad R' : B \otimes A' \rightarrow A' \otimes B, \quad R'(b \otimes a) = (a_{(0)_R})_{[0]} \otimes (a_{(0)_R})_{[1]} b_R a_{(1)},$$

is a twisting map and we have an algebra isomorphism

$$A' \otimes_{R'} B \simeq A \otimes_R B, \quad a \otimes b \mapsto a_{(0)} \otimes a_{(1)} b.$$

Theorem 4.8. *Let $B \otimes_R C$ be a twisted tensor product of algebras and denote the multiplication of C by $c \otimes c' \mapsto cc'$. Assume that on the vector space C we have one more algebra structure, denoted by C' , with the same unit as C and multiplication denoted by $c \otimes c' \mapsto c * c'$ (for instance, C' may be C itself or ${}^d C$ as in Proposition 4.5). Assume that we are given two linear maps $\theta, \gamma : C \rightarrow B \otimes C$, with notation $\theta(c) = c_{<-1>} \otimes c_{<0>}$ and $\gamma(c) = c_{\{-1\}} \otimes c_{\{0\}}$, such that θ is an algebra map from C' to $B \otimes_R C$, $\gamma(1) = 1 \otimes 1$ and relations (4.13), (4.14), (4.15) are satisfied. Then the map*

$$(4.18) \quad R' : C' \otimes B \rightarrow B \otimes C', \quad R'(c \otimes b) = c_{<-1>} b_R (c_{<0>_R})_{\{-1\}} \otimes (c_{<0>_R})_{\{0\}},$$

is a twisting map and we have an algebra isomorphism

$$B \otimes_{R'} C' \simeq B \otimes_R C, \quad b \otimes c \mapsto b c_{<-1>} \otimes c_{<0>}.$$

We recall the following result of G. Fiore from [Fi02], in a slightly modified (but equivalent) form. Let H be a Hopf algebra with antipode S and A a left H -module algebra. Assume that there exists an algebra map $\varphi : A \# H \rightarrow A$ such that $\varphi(a \# 1) = a$ for all $a \in A$. Define the map

$$\theta : H \rightarrow A \otimes H, \quad \theta(h) = \varphi(1 \# S(h_1)) \otimes h_2.$$

Then θ is an algebra map from H to $A \# H$ and the smash product $A \# H$ is isomorphic to the ordinary tensor product $A \otimes H$.

We prove that this result is a particular case of Theorem 4.8, with $B = A$ and $C = C' = H$ (in the notation of Theorem 4.8).

Define the map $\gamma : H \rightarrow A \otimes H$, $\gamma(h) = \varphi(1 \# h_1) \otimes h_2$, and denote as above $\theta(h) = h_{<-1>} \otimes h_{<0>}$ and $\gamma(h) = h_{\{-1\}} \otimes h_{\{0\}}$. The relations (4.14) and (4.15) are easy to check, so we

only have to prove (4.13) (here, the map $R : H \otimes A \rightarrow A \otimes H$ is given by $R(h \otimes a) = h_1 \cdot a \otimes h_2$). We will need the following relation from [Fi02]:

$$(4.19) \quad \varphi(1 \# h)a = (h_1 \cdot a)\varphi(1 \# h_2),$$

for all $h \in H$, $a \in A$. Now we compute:

$$\begin{aligned} (h'_{\{-1\}})_R(h_R)_{\{-1\}} \otimes (h_R)_{\{0\}}h'_{\{0\}} &= \varphi(1 \# h'_1)_R \varphi(1 \# (h_R)_1) \otimes (h_R)_2 h'_2 \\ &= (h_1 \cdot \varphi(1 \# h'_1))\varphi(1 \# h_2) \otimes h_3 h'_2 \\ &\stackrel{(4.19)}{=} \varphi(1 \# h_1)\varphi(1 \# h'_1) \otimes h_2 h'_2 \\ &= \varphi(1 \# h_1 h'_1) \otimes h_2 h'_2 \\ &= \gamma(h h'), \end{aligned}$$

hence (4.13) holds. Theorem 4.8 may thus be applied, and we get the twisting map R' , which looks as follows:

$$\begin{aligned} R'(h \otimes a) &= h_{\langle -1 \rangle} a_R (h_{\langle 0 \rangle_R})_{\{-1\}} \otimes (h_{\langle 0 \rangle_R})_{\{0\}} \\ &= \varphi(1 \# S(h_1)) a_R (h_{2_R})_{\{-1\}} \otimes (h_{2_R})_{\{0\}} \\ &= \varphi(1 \# S(h_1))(h_2 \cdot a)(h_3)_{\{-1\}} \otimes (h_3)_{\{0\}} \\ &= \varphi(1 \# S(h_1))(h_2 \cdot a)\varphi(1 \# h_3) \otimes h_4 \\ &\stackrel{(4.19)}{=} \varphi(1 \# S(h_1))\varphi(1 \# h_2)a \otimes h_3 \\ &= \varphi(1 \# S(h_1)h_2)a \otimes h_3 \\ &= a \otimes h, \end{aligned}$$

so R' is the usual flip, hence we obtain $A \# H \simeq A \otimes H$ as a consequence of Theorem 4.8.

Remark 4.9. Let H be a Hopf algebra, let A be an algebra and $u : H \rightarrow A$ an algebra map; consider the strongly inner action of H on A afforded by u , that is $h \cdot a = u(h_1)au(S(h_2))$, for all $h \in H$, $a \in A$. Then it is well-known (see for instance [Mon93], Example 7.3.3) that the smash product $A \# H$ is isomorphic to the ordinary tensor product $A \otimes H$. This result is actually a particular case of Fiore's theorem presented above (hence of Theorem 4.8 too), because one can easily see that the map $\varphi : A \# H \rightarrow A$, $\varphi(a \# h) = au(h)$ is an algebra map satisfying $\varphi(a \# 1) = a$ for all $a \in A$.

We recall now the following result from [FSW03], with a different notation and in a slightly modified (but equivalent) form, adapted to our purpose. Let (H, r) be a quasitriangular Hopf algebra, H^+ and H^- two Hopf subalgebras of H such that $r \in H^+ \otimes H^-$ (we will denote $r = r^1 \otimes r^2 = \mathcal{R}^1 \otimes \mathcal{R}^2 \in H^+ \otimes H^-$). Let B be a right H^+ -module algebra and C a right H^- -module algebra (actions are denoted by \cdot), and consider their braided product $B \underline{\otimes} C$, which is just the twisted tensor product $B \otimes_R C$, with twisting map given by

$$R : C \otimes B \rightarrow B \otimes C, \quad R(c \otimes b) = b \cdot r^1 \otimes c \cdot r^2.$$

Assume that there exists an algebra map $\pi : H^+ \# B \rightarrow B$ (where $H^+ \# B$ is the right smash product recalled before) such that $\pi(1 \# b) = b$ for all $b \in B$. Define the map

$$\theta : C \rightarrow B \otimes C, \quad \theta(c) = \pi(r^1 \# 1) \otimes c \cdot r^2.$$

Then θ is an algebra map from C to $B \underline{\otimes} C$ and the braided tensor product $B \underline{\otimes} C$ is isomorphic to the ordinary tensor product $B \otimes C$ (hence the existence of π allows to “unbraid” the braided tensor product; many examples where this happens may be found in [FSW03], especially coming from quantum groups).

We prove now that this result is a particular case of Theorem 4.8, with $C' = C$ (in the notation of Theorem 4.8).

We first need to recall the axioms of a quasitriangular structure:

$$(4.20) \quad (\Delta \otimes id)(r) = r_{13}r_{23},$$

$$(4.21) \quad (id \otimes \Delta)(r) = r_{13}r_{12},$$

$$(4.22) \quad \Delta^{cop}(h)r = r\Delta(h), \quad \forall h \in H.$$

Define the map $\gamma : C \rightarrow B \otimes C$, $\gamma(c) = \pi(u^1 \# 1) \otimes c \cdot u^2$, where we denote $r^{-1} = u^1 \otimes u^2 = U^1 \otimes U^2 \in H^+ \otimes H^-$. Denote as above $\theta(c) = c_{<-1>} \otimes c_{<0>}$ and $\gamma(c) = c_{\{-1\}} \otimes c_{\{0\}}$. The relations (4.14) and (4.15) are easy to check, hence we only have to prove (4.13) (here, we recall, $*$ coincides with the multiplication of C). We first record the relation:

$$(4.23) \quad c_{\{-1\}}b \otimes c_{\{0\}} = b_R(c_R)_{\{-1\}} \otimes (c_R)_{\{0\}}, \quad \forall b \in B, c \in C,$$

which can be proved as follows:

$$\begin{aligned} b_R(c_R)_{\{-1\}} \otimes (c_R)_{\{0\}} &= (b \cdot r^1)(c \cdot r^2)_{\{-1\}} \otimes (c \cdot r^2)_{\{0\}} \\ &= (b \cdot r^1)\pi(u^1 \# 1) \otimes c \cdot r^2 u^2 \\ &= \pi(1 \# b \cdot r^1)\pi(u^1 \# 1) \otimes c \cdot r^2 u^2 \\ &= \pi((1 \# b \cdot r^1)(u^1 \# 1)) \otimes c \cdot r^2 u^2 \\ &= \pi(u_1^1 \# b \cdot r^1 u_2^1) \otimes c \cdot r^2 u^2 \\ &\stackrel{(4.20)}{=} \pi(U^1 \# b \cdot r^1 u^1) \otimes c \cdot r^2 u^2 U^2 \\ &= \pi(U^1 \# b) \otimes c \cdot U^2 \\ &= \pi(U^1 \# 1)\pi(1 \# b) \otimes c \cdot U^2 \\ &= \pi(U^1 \# 1)b \otimes c \cdot U^2 \\ &= c_{\{-1\}}b \otimes c_{\{0\}}. \end{aligned}$$

Now we compute:

$$\begin{aligned} \gamma(cc') &= \pi(u^1 \# 1) \otimes (c \cdot u_1^2)(c' \cdot u_2^2) \\ &\stackrel{(4.21)}{=} \pi(u^1 U^1 \# 1) \otimes (c \cdot u^2)(c' \cdot U^2) \\ &= \pi(u^1 \# 1)\pi(U^1 \# 1) \otimes (c \cdot u^2)(c' \cdot U^2) \\ &= c_{\{-1\}}c'_{\{-1\}} \otimes c_{\{0\}}c'_{\{0\}} \\ &\stackrel{(4.23)}{=} c'_{\{-1\}_R}(c_R)_{\{-1\}} \otimes (c_R)_{\{0\}}c'_{\{0\}}, \end{aligned}$$

hence (4.13) holds. Theorem 4.8 may thus be applied, and we get the twisting map R' , which looks as follows:

$$\begin{aligned}
R'(c \otimes b) &= c_{\langle -1 \rangle} b_R(c_{\langle 0 \rangle_R})_{\{-1\}} \otimes (c_{\langle 0 \rangle_R})_{\{0\}} \\
&= \pi(r^1 \# 1) b_R((c \cdot r^2)_R)_{\{-1\}} \otimes ((c \cdot r^2)_R)_{\{0\}} \\
&= \pi(r^1 \# 1) (b \cdot \mathcal{R}^1) (c \cdot r^2 \mathcal{R}^2)_{\{-1\}} \otimes (c \cdot r^2 \mathcal{R}^2)_{\{0\}} \\
&= \pi(r^1 \# 1) \pi(1 \# b \cdot \mathcal{R}^1) \pi(u^1 \# 1) \otimes c \cdot r^2 \mathcal{R}^2 u^2 \\
&= \pi((r^1 \# 1) (1 \# b \cdot \mathcal{R}^1) (u^1 \# 1)) \otimes c \cdot r^2 \mathcal{R}^2 u^2 \\
&= \pi(r^1 u_1^1 \# b \cdot \mathcal{R}^1 u_2^1) \otimes c \cdot r^2 \mathcal{R}^2 u^2 \\
&\stackrel{(4.20)}{=} \pi(r^1 U^1 \# b \cdot \mathcal{R}^1 u^1) \otimes c \cdot r^2 \mathcal{R}^2 u^2 U^2 \\
&= \pi(1 \# b) \otimes c \\
&= b \otimes c,
\end{aligned}$$

so R' is the usual flip, hence we obtain $B \underline{\otimes} C \simeq B \otimes C$ as a consequence of Theorem 4.8.

A natural question that arises is to see whether Theorems 4.4 and 4.6 can be combined, namely, if (A, B, C, R_1, R_2, R_3) are as in Theorem 2.1 and we have a datum as in Theorem 4.4 between A and B and a datum as in Theorem 4.6 between B and C , under what conditions it follows that $(A^d, B, {}^d C, R_1^d, {}^d R_2, R_3)$ satisfy again the hypotheses of Theorem 2.1.

Our first remark is that this does *not* happen in general, a counterexample may be obtained as follows. Take $B = H$ a bialgebra, A a left H -module algebra, C a right H -module algebra and $F \in H \otimes H$ a 2-cocycle. Here $R_1(h \otimes a) = h_1 \cdot a \otimes h_2$, $R_2(c \otimes h) = h_1 \otimes c \cdot h_2$ and $R_3 = \tau_{CA}$, the usual flip, hence $A \otimes_{R_1} H \otimes_{R_2} C = A \# H \# C$, the two-sided smash product. We consider the datum between A and H that allows us to define $A_{F^{-1}} \# H_F$, hence $R_1^d(h \otimes a) = F^1 h_1 G^1 \cdot a \otimes F^2 h_2 G^2$, and the trivial datum between H and C . One can see that in general (R_1^d, R_2, R_3) do *not* satisfy the hexagon condition.

Hence, the best we can do is to find sufficient conditions on the initial data ensuring that $(R_1^d, {}^d R_2, R_3)$ satisfy the hexagon condition. This is achieved in the next result. Note that the conditions we found are not the most general one can imagine (in particular, we need to assume that R_3 is the flip), but they are general enough to include as a particular case the invariance under twisting of the two-sided smash product from [BPVO], which was our guiding example for this result.

Theorem 4.10. *Let (A, B, C, R_1, R_2, R_3) be as in Theorem 2.1, with $R_3 = \tau_{CA}$, the usual flip. Assume that we have a datum between A and B as in Theorem 4.4 and a datum between B and C as in Theorem 4.6, with notation as in these results. Assume also that the following compatibility conditions hold:*

$$(4.24) \quad a_{(0)} \otimes a_{(1)_{R_2}} (c_{R_2})_{\{-1\}} \otimes (c_{R_2})_{\{0\}} = a_{(0)_{R_1}} \otimes c_{\{-1\}_{R_1}} a_{(1)} \otimes c_{\{0\}},$$

$$(4.25) \quad a_{[0]} \otimes c_{\langle -1 \rangle_{R_2}} a_{[1]_{R_2}} \otimes c_{\langle 0 \rangle_{R_2}} = (a_{R_1})_{[0]} \otimes (a_{R_1})_{[1]} c_{\langle -1 \rangle_{R_1}} \otimes c_{\langle 0 \rangle},$$

$$(4.26) \quad a_{(0)_{R_1}} \otimes c_{\langle -1 \rangle_{R_1}} a_{(1)_{R_2}} \otimes c_{\langle 0 \rangle_{R_2}} = a_{(0)} \otimes a_{(1)} c_{\langle -1 \rangle} \otimes c_{\langle 0 \rangle},$$

for all $a \in A, c \in C$. Then $(A^d, B, {}^dC, R_1^d, {}^dR_2, R_3)$ satisfy also the hypotheses of Theorem 2.1, and we have an algebra isomorphism

$$A^d \otimes_{R_1^d} B \otimes_{{}^dR_2} {}^dC \simeq A \otimes_{R_1} B \otimes_{R_2} C, \quad a \otimes b \otimes c \mapsto a_{(0)} \otimes a_{(1)}bc_{\langle -1 \rangle} \otimes c_{\langle 0 \rangle}.$$

PROOF We prove the hexagon condition for $(R_1^d, {}^dR_2, R_3)$; we compute:

$$\begin{aligned} & (A \otimes {}^dR_2) \circ (R_3 \otimes B) \circ (C \otimes R_1^d)(c \otimes b \otimes a) \\ & \stackrel{(4.8),(4.16)}{=} (a_{(0)R_1})_{[0]} \otimes c_{\langle -1 \rangle} \left((a_{(0)R_1})_{[1]} b_{R_1} a_{(1)} \right)_{R_2} (c_{\langle 0 \rangle R_2})_{\{-1\}} \otimes (c_{\langle 0 \rangle R_2})_{\{0\}} \\ & \stackrel{(1.3)}{=} (a_{(0)R_1})_{[0]} \otimes c_{\langle -1 \rangle} \left((a_{(0)R_1})_{[1]} \right)_{R_2} (b_{R_1})_{r_2} (a_{(1)})_{\mathcal{R}_2} \left((c_{\langle 0 \rangle R_2})_{r_2} \right)_{\mathcal{R}_2} \{-1\} \\ & \quad \otimes \left((c_{\langle 0 \rangle R_2})_{r_2} \right)_{\mathcal{R}_2} \{0\} \\ & \stackrel{(4.24)}{=} \left((a_{(0)})_{\mathcal{R}_1} \right)_{R_1} [0] \otimes c_{\langle -1 \rangle} \left(\left((a_{(0)})_{\mathcal{R}_1} \right)_{R_1} [1] \right)_{R_2} (b_{R_1})_{r_2} \\ & \quad \left((c_{\langle 0 \rangle R_2})_{r_2} \right)_{\{-1\}} \mathcal{R}_1 a_{(1)} \otimes \left((c_{\langle 0 \rangle R_2})_{r_2} \right)_{\{0\}}, \end{aligned}$$

$$\begin{aligned} & (R_1^d \otimes C) \circ (B \otimes R_3) \circ ({}^dR_2 \otimes A)(c \otimes b \otimes a) \\ & \stackrel{(4.8),(4.16)}{=} (a_{(0)R_1})_{[0]} \otimes (a_{(0)R_1})_{[1]} (c_{\langle -1 \rangle} b_{R_2} (c_{\langle 0 \rangle R_2})_{\{-1\}})_{R_1} a_{(1)} \otimes (c_{\langle 0 \rangle R_2})_{\{0\}} \\ & \stackrel{(1.4)}{=} \left((a_{(0)R_1})_{r_1} \right)_{\mathcal{R}_1} [0] \otimes \left((a_{(0)R_1})_{r_1} \right)_{\mathcal{R}_1} [1] (c_{\langle -1 \rangle})_{R_1} (b_{R_2})_{r_1} \\ & \quad \left((c_{\langle 0 \rangle R_2})_{\{-1\}} \right)_{R_1} a_{(1)} \otimes (c_{\langle 0 \rangle R_2})_{\{0\}} \\ & \stackrel{(4.25)}{=} \left((a_{(0)R_1})_{r_1} \right)_{[0]} \otimes c_{\langle -1 \rangle} \left(\left((a_{(0)R_1})_{r_1} \right)_{[1]} \right)_{r_2} (b_{R_2})_{r_1} \left((c_{\langle 0 \rangle r_2})_{R_2} \right)_{\{-1\}} R_1 \\ & \quad a_{(1)} \otimes \left((c_{\langle 0 \rangle r_2})_{R_2} \right)_{\{0\}}, \end{aligned}$$

and the two terms are equal because of the hexagon condition for (R_1, R_2, R_3) :

$$a_{R_1} \otimes (b_{R_1})_{R_2} \otimes c_{R_2} = a_{R_1} \otimes (b_{R_2})_{R_1} \otimes c_{R_2}.$$

We prove now that the map

$$\begin{aligned} \psi : A^d \otimes_{R_1^d} B \otimes_{{}^dR_2} {}^dC & \rightarrow A \otimes_{R_1} B \otimes_{R_2} C, \\ \psi(a \otimes b \otimes c) & = a_{(0)} \otimes a_{(1)}bc_{\langle -1 \rangle} \otimes c_{\langle 0 \rangle}, \end{aligned}$$

is an algebra isomorphism. First, using (4.6), (4.7), (4.14), (4.15), it is easy to see that ψ is bijective, with inverse given by $a \otimes b \otimes c \mapsto a_{[0]} \otimes a_{[1]}bc_{\{-1\}} \otimes c_{\{0\}}$. We prove now that ψ is multiplicative. We compute (using (2.4)):

$$\begin{aligned}
& \psi((a \otimes b \otimes c)(a' \otimes b' \otimes c')) \\
&= \psi(a * a'_{R_1^d} \otimes b_{R_1^d} b'_{dR_2} \otimes c_{dR_2} * c') \\
&\stackrel{(4.8),(4.16)}{=} \psi(a * (a'_{(0)R_1})_{[0]} \otimes (a'_{(0)R_1})_{[1]} b_{R_1} a'_{(1)} c_{<-1>} b'_{R_2} (c_{<0>}_{R_2})_{\{-1\}} \\
&\quad \otimes (c_{<0>}_{R_2})_{\{0\}} * c') \\
&= (a * (a'_{(0)R_1})_{[0]})_{(0)} \otimes (a * (a'_{(0)R_1})_{[0]})_{(1)} (a'_{(0)R_1})_{[1]} b_{R_1} a'_{(1)} c_{<-1>} b'_{R_2} \\
&\quad (c_{<0>}_{R_2})_{\{-1\}} ((c_{<0>}_{R_2})_{\{0\}} * c')_{<-1>} \otimes ((c_{<0>}_{R_2})_{\{0\}} * c')_{<0>} \\
&\stackrel{(4.2),(4.12)}{=} a_{(0)} (((a'_{(0)R_1})_{[0]})_{(0)})_{r_1} \otimes a_{(1)r_1} (((a'_{(0)R_1})_{[0]})_{(1)} (a'_{(0)R_1})_{[1]} b_{R_1} a'_{(1)} c_{<-1>} b'_{R_2} \\
&\quad (c_{<0>}_{R_2})_{\{-1\}} ((c_{<0>}_{R_2})_{\{0\}})_{<-1>} (c'_{<-1>}_{r_2} \otimes (((c_{<0>}_{R_2})_{\{0\}})_{<0>}_{r_2} c'_{<0>} \\
&\stackrel{(4.7),(4.15)}{=} a_{(0)} (a'_{(0)R_1})_{r_1} \otimes a_{(1)r_1} b_{R_1} a'_{(1)} c_{<-1>} b'_{R_2} c'_{<-1>}_{r_2} \otimes (c_{<0>}_{R_2})_{r_2} c'_{<0>}, \\
& \psi(a \otimes b \otimes c) \psi(a' \otimes b' \otimes c') \\
&= (a_{(0)} \otimes a_{(1)} b c_{<-1>} \otimes c_{<0>}) (a'_{(0)} \otimes a'_{(1)} b' c'_{<-1>} \otimes c'_{<0>}) \\
&= a_{(0)} a'_{(0)R_1} \otimes (a_{(1)} b c_{<-1>})_{R_1} (a'_{(1)} b' c'_{<-1>})_{R_2} \otimes c_{<0>}_{R_2} c'_{<0>} \\
&\stackrel{(1.3),(1.4)}{=} a_{(0)} (((a'_{(0)})_{\mathcal{R}_1})_{R_1})_{r_1} \otimes a_{(1)r_1} b_{R_1} (c_{<-1>})_{\mathcal{R}_1} (a'_{(1)})_{\mathcal{R}_2} b'_{R_2} c'_{<-1>}_{r_2} \\
&\quad \otimes (((c_{<0>})_{\mathcal{R}_2})_{R_2})_{r_2} c'_{<0>} \\
&\stackrel{(4.26)}{=} a_{(0)} (a'_{(0)R_1})_{r_1} \otimes a_{(1)r_1} b_{R_1} a'_{(1)} c_{<-1>} b'_{R_2} c'_{<-1>}_{r_2} \otimes (c_{<0>}_{R_2})_{r_2} c'_{<0>},
\end{aligned}$$

and we see that the two terms are equal. \square

Let now H be a bialgebra, A a left H -module algebra, C a right H -module algebra and $F \in H \otimes H$ a 2-cocycle. Then, by [BPVO], we have an algebra isomorphism (notation as before):

$$A_{F^{-1}} \# H_F \#_F C \simeq A \# H \# C, \quad a \# h \# c \mapsto G^1 \cdot a \# G^2 h F^1 \# c \cdot F^2.$$

One can easily see that this result is a particular case of Theorem 4.10; indeed, the relations (4.24), (4.25), (4.26) are easy consequences of the 2-cocycle condition for F .

REFERENCES

- [BCZ96] M. Beattie, C.-Y. Chen, and J. J. Zhang. Twisted Hopf comodule algebras. *Comm. Algebra*, 24:1759–1775, 1996.
- [BM00] A. Borowiec and W. Marcinek. On crossed product of algebras. *J. Math. Phys.*, 41:6959–6975, 2000.
- [BPVO] D. Bulacu, F. Panaite, and F. Van Oystaeyen. Generalized diagonal crossed products and smash products for quasi-Hopf algebras. Applications. arXiv:math.QA/0506570.
- [BPVO00] D. Bulacu, F. Panaite, and F. Van Oystaeyen. Quasi-Hopf algebra actions and smash products. *Comm. Algebra*, 28:631–651, 2000.
- [CDV02] A. Connes and M. Dubois-Violette. Noncommutative finite-dimensional manifolds I. Spherical manifolds and related examples. *Comm. Math. Phys.*, 230:539–579, 2002.
- [CMZ02] S. Caenepeel, G. Militaru, and S. Zhu. *Frobenius and separable functors for generalized module categories and nonlinear equations*. Lect. Notes Math., 1787. Springer Verlag, Berlin, 2002.

- [CIMZ00] S. Caenepeel, B. Ion, G. Militaru, and S. Zhu. The factorisation problem and smash biproducts of algebras and coalgebras. *Algebr. Represent. Theory*, 3:19–42, 2000.
- [CSV95] A. Cap, H. Schichl, and J. Vanžura. On twisted tensor products of algebras. *Comm. Algebra*, 23:4701–4735, 1995.
- [FST99] W. R. Ferrer Santos and B. Torrecillas. Twisting products in algebras II. *K-Theory*, 17:37–53, 1999.
- [Fi02] G. Fiore. On the decoupling of the homogeneous and inhomogeneous parts in inhomogeneous quantum groups. *J. Phys. A*, 35:657–678, 2002.
- [FSW03] G. Fiore, H. Steinacker, and J. Wess. Unbraiding the braided tensor product. *J. Math. Phys.*, 44:1297–1321, 2003.
- [HN99] F. Hausser and F. Nill. Diagonal crossed products by duals of quasi-quantum groups. *Rev. Math. Phys.*, 11:553–629, 1999.
- [Kas95] C. Kassel. *Quantum Groups*. Graduate Texts in Math., 155. Springer Verlag, Berlin, 1995.
- [Lu94] J. H. Lu. On the Drinfeld double and the Heisenberg double of a Hopf algebra. *Duke Math. J.*, 74:763–776, 1994.
- [Maj90] S. Majid. Matched pairs of Lie groups associated to solutions of the Yang–Baxter equations. *Pacific J. Math.*, 141:311–332, 1990.
- [Maj90b] S. Majid. Physics for algebraists: Non-commutative and non-cocommutative Hopf algebras by a bicrossproduct construction. *J. Algebra*, 130:17–64, 1990.
- [Maj90c] S. Majid. More examples of bicrossproduct and double cross product Hopf algebras. *Israel J. Math.*, 72:133–148, 1990.
- [Maj91] S. Majid. Doubles of quasitriangular Hopf algebras. *Comm. Algebra*, 19:3061–3073, 1991.
- [Maj94] S. Majid. Algebras and Hopf algebras in braided categories. In *Advances in Hopf algebras*, 55–105. Marcel Dekker, 1994.
- [Maj95] S. Majid. *Foundations of quantum group theory*. Cambridge Univ. Press, 1995.
- [Maj97] S. Majid. Quasi- $*$ structure on q -Poincaré algebras. *J. Geom. Phys.*, 22:14–58, 1997.
- [Mic90] P. W. Michor. Knt products of graded Lie algebras and groups. In *Proc. of the Winter School on Geometry and Physics*, Supp. ai Rend. Circ. Mat. di Palermo, Serie II, 1990.
- [Mon93] S. Montgomery. *Hopf algebras and their actions on rings*. CBMS Regional Conference Series, 82. Amer. Math. Soc., Providence, RI, 1993.
- [NS97] F. Nill and K. Szlachányi. Quantum chains of Hopf algebras with quantum double cosymmetry. *Comm. Math. Phys.*, 187:159–200, 1997.
- [Pan02] F. Panaite. Hopf bimodules are modules over a diagonal crossed product algebra. *Comm. Algebra*, 30:4049–4058, 2002.
- [PVO] F. Panaite and F. Van Oystaeyen. L-R-smash product for (quasi) Hopf algebras. arXiv:math.QA/0504386.
- [RT90] N. Yu. Reshetikhin and V. G. Turaev. Ribbon graphs and their invariants derived from quantum groups. *Comm. Math. Phys.*, 127:1–26, 1990.
- [Swe69] M. E. Sweedler. *Hopf algebras*. Benjamin, New York, 1969.
- [Tak81] M. Takeuchi. Matched pairs of groups and bismash products of Hopf algebras. *Comm. Algebra*, 9:841–882, 1981.
- [Tam90] D. Tambara. The coendomorphism bialgebra of an algebra. *J. Fac. Sci. Univ. Tokyo Sect. IA Math.*, 37:425–456, 1990.
- [VDVK94] A. Van Daele and S. Van Keer. The Yang–Baxter and Pentagon equation. *Compositio Math.*, 91:201–221, 1994.

DEPARTMENT OF ALGEBRA, UNIVERSITY OF GRANADA, AVDA. FUENTENUEVA S/N, E-18071, GRANADA, SPAIN

E-mail address: `pjara@ugr.es`

DEPARTMENT OF ALGEBRA, UNIVERSITY OF GRANADA, AVDA. FUENTENUEVA S/N, E-18071, GRANADA, SPAIN

E-mail address: `jlopez@ugr.es`

INSTITUTE OF MATHEMATICS OF THE ROMANIAN ACADEMY., PO-BOX 1-764, RO-014700 BUCHAREST (ROMANIA)

E-mail address: `Florin.Panaite@imar.ro`

DEPARTMENT OF MATHEMATICS AND COMPUTER SCIENCES, UNIVERSITY OF ANTWERP., MIDDELHEIMLAAN 1, B-2020 ANTWERP (BELGIUM)

E-mail address: `Francine.Schoeters@ua.ac.be` (secretary)