

Around Vogt's theorem

Alexey Kurnosenko

September 18, 2018

Institute for High Energy Physics, Protvino, Russia, 142281

Abstract

Vogt's theorem, concerning boundary angles of a convex arc with monotonic curvature (*spiral arc*), is taken as a starting point to establish basic properties of spirals. The theorem is expanded by removing requirements of convexity and curvature continuity; the cases of inflection and multiple windings are considered. Positional restrictions for a spiral arc with two given curvature elements at the endpoints are established, as well as the necessary and sufficient conditions for the existence of such spiral.

Keywords: Vogt's theorem, spiral, inversive invariant, monotonic curvature, lense, biarc, bilense.

2000 MSC: 53A04

1 Introduction

Vogt's theorem was published in 1914 ([12], Satz 12). It concerns convex arcs of planar curves with continuous monotonic curvature of constant sign. The later proofs [4, 5, 11] did not extend the class of invoked curves. Guggenheimer ([3], p.48) applies the term *spiral arc* to such curves, and formulates Vogt's theorem as follows:

“Let A and B be the endpoints of a spiral arc, the curvature nondecreasing from A to B . The angle β of the tangent to the arc at B with the chord AB is not less than the angle α of the tangent at A with AB . $\alpha = \beta$ only if the curvature is constant”.

Below α and β denote algebraic values of the boundary angles with respect to the positive direction of X -axis, same as the direction of the chord \overrightarrow{AB} . Signed curvatures at the endpoints A and B are denoted as k_1 and k_2 . Vogt assumes positive values for angles and curvatures, and the theorem states that $|\alpha| > |\beta|$ for $|k_1| > |k_2|$, and vice versa. Five cases, depicted in Fig. 1 as arcs AB_i , can be detailed as

$$\begin{array}{llll}
 AB_1 : & k_1 < k_2 < 0, & \alpha = |\alpha| > |\beta| = -\beta & \implies & \alpha + \beta > 0; \\
 AB_2 : & 0 > k_1 > k_2, & \alpha = |\alpha| < |\beta| = -\beta & \implies & \alpha + \beta < 0; \\
 AB_0 : & k_1 = k_2, & \pm\alpha = |\alpha| = |\beta| = \mp\beta & \implies & \alpha + \beta = 0; \\
 AB_3 : & k_1 > k_2 > 0, & -\alpha = |\alpha| > |\beta| = \beta & \implies & \alpha + \beta < 0; \\
 AB_4 : & 0 < k_1 < k_2, & -\alpha = |\alpha| < |\beta| = \beta & \implies & \alpha + \beta > 0;
 \end{array}$$

and unified to

$$\text{sign}(\alpha + \beta) = \text{sign}(k_2 - k_1) \tag{1}$$

for whichever kind of monotonicity and curvature sign. In this notation the theorem remains valid for non-convex arcs. The proof for this case, lemma 1 in [7], required curve to be one-to-one projectable onto its chord.

A variety of situations is illustrated by a family of arcs of Cornu spirals with fixed α and varying β , shown in Fig. 2. The sum $\alpha + \beta$ for curves 1 and 2 with decreasing curvature is negative; it vanishes at circular arc 3, and becomes positive for curves 4–10 with increasing curvature. Vogt's theorem covers cases 1–4 (arc 5 is not convex), lemma 1 in [7] — cases 3–8, curves 3–4 are covered by both, and 9–10 — by neither. General proof for cases 1–10, defined below as *short* arcs, is the first extension of Vogt's theorem proposed herein.

The requirements of convexity or projectability both served to somehow shorten the arc. But it turned out that Vogt's theorem can also be formulated for “long” spirals like curve 11 in Fig. 2.

2 Preliminary definitions and notation

We describe curves by intrinsic equation $k = k(s)$, k being curvature, and s , arc length: $0 \leq s \leq S$. Functions $Z(s) = x(s) + iy(s)$ and $\tau(s)$ represent coordinates and the direction of tangent. The terms “*increasing*” and “*decreasing*”, applied to any function $f(s)$, are accompanied in this article by the adverb “*strictly*” when necessary; otherwise non-strict monotonicity with $f(s) \not\equiv \text{const}$ is assumed.

Definition 2.1. *Spiral* is a planar curve of monotonic, piecewise continuous curvature, not containing the circumference of a circle. Inflection and infinite curvatures at the endpoints are admitted.

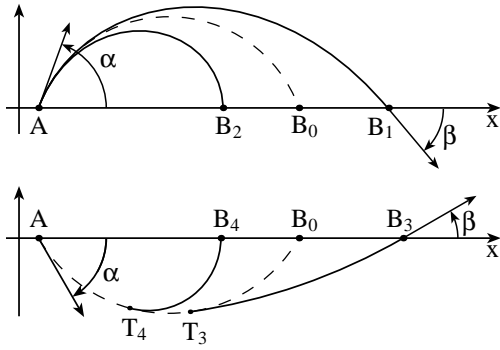

Fig. 1.

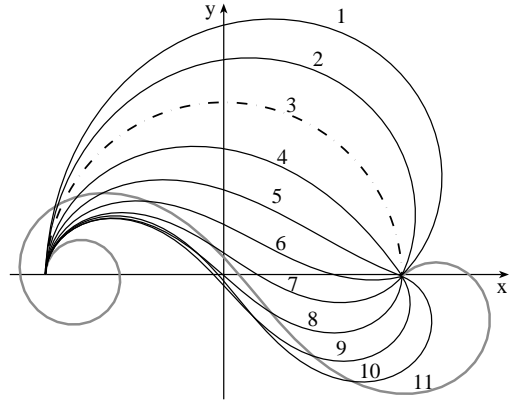

Fig. 2.

Definition 2.2. *Biarc* is a spiral, composed of two arcs of constant curvature (like arcs AT_3B_3 and AT_4B_4 in Fig. 1).

Definition 2.3. An arc \widehat{AB} is *short*, if its tangent never achieves the direction \vec{BA} , opposite to the direction of its chord, except, possibly, at the endpoints.

Definition 2.4. An arc \widehat{AB} is *short*, if it does not intersect the complement of its chord to the infinite straight line (possibly intersecting the chord itself).

Def. 2.3 will be used until the equivalence of definitions 2.3 and 2.4 is proven (corollary 5.10). The term “*very short*” will be sometimes used to denote an arc, one-to-one projectable onto its chord (curves 3–8 in Fig. 2).

Guggenheimer uses terms *line element* to denote a pair (P, \mathbf{t}) of a point and a direction, and *curvature element* $(P, \mathbf{t}, \rho \mathbf{n})$, $\mathbf{n} \perp \mathbf{t}$, adding curvature radius ρ at P ([3], p. 50). We modify these definitions to (x, y, τ) and (x, y, τ, k) with tangent angle τ and signed curvature k at the point $P = (x, y)$. Notation

$$\mathcal{K}_i = K(x_i, y_i, \tau_i, k_i)$$

serves to denote both the i -th curvature element and *directed curve of constant curvature* produced by \mathcal{K}_i . Whether it be a straight line or a circular arc, it goes under general name *circle [of curvature]*.

As in [6], we use an implicit equation of the circle $\mathcal{K}_0 = K(x_0, y_0, \tau_0, k_0)$ in the form

$$C(x, y; \mathcal{K}_0) \equiv k_0 [(x-x_0)^2 + (y-y_0)^2] + 2(x-x_0) \sin \tau_0 - 2(y-y_0) \cos \tau_0 = 0. \quad (2)$$

The sign of $C(x, y; \mathcal{K}_0)$ reflects the position of the point (x, y) with respect to \mathcal{K}_0 : it is from the left ($C < 0$) or from the right ($C > 0$) of the circle’s boundary. Keeping in mind applications to geometric modelling, define the following:

Definition 2.5. The *region of material* of the circle \mathcal{K} is

$$\text{Mat}(\mathcal{K}) = \{(x, y) : C(x, y; \mathcal{K}) \leq 0\}.$$

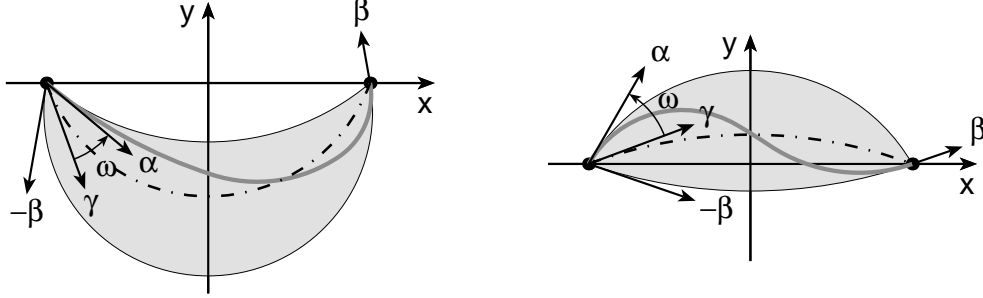

Fig. 3.

To consider properties of a spiral arc in relation to its chord \overrightarrow{AB} , $|AB| = 2c$, we choose the coordinate system such that the chord becomes the segment $[-c, c]$ of X-axis. With $\alpha = \tau(0)$, $k_1 = k(0)$, and $\beta = \tau(S)$, $k_2 = k(S)$, the boundary circles of curvature take form

$$\mathcal{K}_1 = K(-c, 0, \alpha, k_1), \quad \mathcal{K}_2 = K(c, 0, \beta, k_2). \quad (3)$$

It is often convenient to assume homothety with the coefficient c^{-1} , and to operate on the segment $[-1, 1]$. The coordinates x, y and curvatures k become normalized dimensionless quantities, corresponding to x/c , y/c and $kc = \kappa$. With such homothety applied, boundary circles (3) appear as

$$\mathcal{K}_1 = K(-1, 0, \alpha, \kappa_1), \quad \mathcal{K}_2 = K(1, 0, \beta, \kappa_2). \quad (4)$$

Definition 2.6. A curve whose start point is moved into position $A(-c, 0)$, and the endpoint, into $B(c, 0)$, is named *normalized arc*. The product $ck(s) \equiv \kappa(s)$, invariant under homotheties, will be referred to as *normalized curvature*.

Denote $\mathcal{A}(\xi)$ a normalized circular arc, traced from the point $A(-c, 0)$ to $B(c, 0)$ with the direction of tangents ξ at A ($k_{1,2} = -\sin \xi/c$, $\kappa_{1,2} = -\sin \xi$). The arc $\mathcal{A}(\pm\pi)$, passing through infinity, is coincident with the chord's complement to an infinite straight line; the arc $\mathcal{A}(0)$ is the chord AB itself.

Definition 2.7. A *lense* $\mathbf{L}(\xi_1, \xi_2)$ is the region between two arcs $\mathcal{A}(\xi_1)$ and $\mathcal{A}(\xi_2)$, namely

$$\mathbf{L}(\xi_1, \xi_2) = \{ (x, y) : (x, y) \in \mathcal{A}(\xi) \}, \quad \min(\xi_1, \xi_2) < \xi < \max(\xi_1, \xi_2).$$

The arc $\mathcal{A}(\alpha)$ shares tangent with the normalized spiral at the start point; so does $\mathcal{A}(-\beta)$ at the endpoint. The two arcs bound the lense $\mathbf{L}(\alpha, -\beta)$, shown in gray in Fig. 3. The signed half-width ω of the lense, and the direction γ of its *bisector* $\mathcal{A}(\gamma)$ are

$$\omega = \frac{\alpha + \beta}{2}, \quad \gamma = \frac{\alpha - \beta}{2}. \quad (5)$$

Definition 2.8. By the *inflection point* of a spiral, whose curvature $k(s)$ changes sign, shall be meant any inner point $Z(s_0)$ with $k(s_0) = 0$. If there is no such point, i.e. curvature jump $k(s_0-0) \leq 0 \leq k(s_0+0)$ occurs, the jump point will be used as the inflection point with the assignment $k(s_0) = 0$.

3 Vogt's theorem for short spirals

The subsequent proof of the modified Vogt's theorem (1) for short spirals is similar to the proof for "very short" ones from [7]. Both clearly show that only monotonicity of $k(s)$, and not convexity of the arc, is the basis for Vogt's theorem.

Theorem 3.1. *Boundary angles α and β of a normalized short spiral or circular arc obey the following conditions:*

$$\begin{aligned} \text{if } k_1 < k_2 : & \quad \alpha + \beta > 0, & \quad -\pi < \alpha \leq \pi, & \quad -\pi < \beta \leq \pi; \\ \text{if } k_1 > k_2 : & \quad \alpha + \beta < 0, & \quad -\pi \leq \alpha < \pi, & \quad -\pi \leq \beta < \pi; \\ \text{if } k_1 = k_2 : & \quad \alpha + \beta = 0, & \quad -\pi < \alpha < \pi, & \quad -\pi < \beta < \pi. \end{aligned} \tag{6}$$

Proof. Consider the case of increasing curvature $k(s)$, and define a new parameter ξ :

$$\xi(s) = \int_0^s \cos \frac{\tau(\sigma)}{2} d\sigma, \quad 0 \leq \xi \leq \xi_1 = \xi(S).$$

By Def. 2.3, $|\tau(s)| < \pi$ within the interval $(0, S)$, and $\xi(s)$ is therefore strictly increasing with s . Define function $z(\xi)$:

$$z(\xi) = \sin \frac{\tau(s(\xi))}{2}, \quad \frac{dz}{d\xi} = \frac{dz}{ds} \cdot \frac{ds}{d\xi} = \left(\frac{1}{2} \cos \frac{\tau(s)}{2} \frac{d\tau}{ds} \right) \cdot \left(\cos \frac{\tau(s)}{2} \right)^{-1} = \frac{1}{2} k(s(\xi)).$$

Its derivative being increasing, $z(\xi)$ is downwards convex, and its plot lies below straight line segment $l(\xi)$, connecting the endpoints $z(0) = \sin(\alpha/2)$ and $z(\xi_1) = \sin(\beta/2)$:

$$z(\xi) < l(\xi) = \frac{\xi_1 - \xi}{\xi_1} \sin(\alpha/2) + \frac{\xi}{\xi_1} \sin(\beta/2), \quad 0 < \xi < \xi_1.$$

Condition $y(0) = y(S)$ yields

$$\begin{aligned} 0 &= \int_0^S \sin \tau(s) ds = 2 \int_0^S \sin \frac{\tau(s)}{2} \overbrace{\left(\cos \frac{\tau(s)}{2} ds \right)}^{d\xi} = 2 \int_0^{\xi_1} z(\xi) d\xi < \\ &< 2 \int_0^{\xi_1} l(\xi) d\xi = \frac{\xi_1}{2} (\sin(\alpha/2) + \sin(\beta/2)) = \xi_1 \sin \frac{\alpha + \beta}{4} \cos \frac{\alpha - \beta}{4}. \end{aligned}$$

So, inequality $|\alpha + \beta| \leq 2\pi$, resulting from $\alpha, \beta \in [-\pi, \pi]$, can be refined to $0 < \alpha + \beta \leq 2\pi$. Condition $\alpha + \beta > 0$ excludes the value $-\pi$ for α or β , providing inequalities (6) for the case of increasing curvature.

If the curvature of the arc $Z(s)$ is decreasing, i.e. $k_2 < k_1$, consider the arc $\bar{Z}(s)$, symmetric to $Z(s)$ about X -axis. Its boundary angles are $\alpha' = -\alpha$, $\beta' = -\beta$, and the curvature increases: $k'_1 = -k_1 < -k_2 = k'_2$. So, $\alpha' + \beta' > 0$, and $\alpha + \beta < 0$ for the original curve. The case of constant curvature is evident. q.e.d.

4 Basic inequality of the theory of spirals

In article [6] we have introduced *an inversive invariant of a pair of circles* $\mathcal{K}_1 = K(x_1, y_1, \tau_1, k_1)$ and $\mathcal{K}_2 = K(x_2, y_2, \tau_2, k_2)$:

$$\begin{aligned} Q(\mathcal{K}_1, \mathcal{K}_2) &= \frac{1}{4}k_1k_2[(\Delta x)^2 + (\Delta y)^2] + \sin^2 \frac{\Delta\tau}{2} + \\ &+ \frac{1}{2}k_2(\Delta x \sin \tau_1 - \Delta y \cos \tau_1) - \frac{1}{2}k_1(\Delta x \sin \tau_2 - \Delta y \cos \tau_2) \end{aligned} \quad (7)$$

$(\Delta x = x_2 - x_1, \quad \Delta y = y_2 - y_1, \quad \Delta\tau = \tau_2 - \tau_1).$

Its value is independent of arbitrarily chosen line elements (x_i, y_i, τ_i) on each circle, and is invariant under motions, homothety and inversions; and $Q(\mathcal{K}_1, \mathcal{K}_2) = Q(\mathcal{K}_2, \mathcal{K}_1)$. In particular cases,

- a) $k_{1,2} \neq 0$, D is the distance between two centres;
- b) $k_1 = 0$, $k_2 \neq 0$, L is (signed) distance from the centre of \mathcal{K}_2 to the straight line \mathcal{K}_1 ;
- c) any k_1, k_2 , and ψ is intersection angle of two circles;

the invariant Q can be represented as follows:

$$Q^{(a)} = \frac{(k_1k_2D)^2 - (k_2 - k_1)^2}{4k_1k_2}, \quad Q^{(b)} = \frac{1 + k_2L}{2}, \quad Q^{(c)} = \sin^2(\psi/2). \quad (8)$$

If two circles have no real common point, ψ is complex, but Q remains real. In this case $\text{Im}(\psi) = \cosh^{-1}|1 - 2Q|$ is Coxeter's inversive distance of two circles [1]. $Q = 0$ if and only if two circles are tangent, or are two equally directed straight lines. Situation $Q = 1$ can be considered as "antitangency" ($\tau_1 = \tau_2 \pm \pi$ at the common point). Using this invariant is the alternative to cumbersome enumeration of variants with different mutual position (and curvature sign) of the two circles, commonly occurring in describing problems of this sort.

Proposition 4.1. *A curve with increasing curvature intersects its every circle of curvature from right to left (and from left to right if curvature decreases).*

Proving here this familiar statement helps us to have the subsequent proof of our basic theorem 4.2 self-contained. The second needed assumption, invariance of Q , is easy to prove by deducing formulae (8).

Proof. To consider behavior of a spiral at some point $P_1 = Z(s_1)$ choose the coordinate system with the origin at P_1 and the axis of X aligned with $\tau(s_1)$. The curvature element at P_1 becomes then $\mathcal{K}_1 = K(0, 0, 0, k_1)$. Obtain function $C(s)$ by substituting $x = x(s)$ and $y = y(s)$ into implicit equation (2) of \mathcal{K}_1 :

$$C(s) = C(x(s), y(s); \mathcal{K}_1) = k_1[x(s)^2 + y(s)^2] - 2y(s). \quad (9)$$

Differentiating $C(s)$ yields (x, y, τ and k are abbreviated functions of s):

$$\begin{aligned} C'(s) &= 2k_1(x \cos \tau + y \sin \tau) - 2 \sin \tau, \\ C''(s) &= 2k_1 + 2k_1k(y \cos \tau - x \sin \tau) - 2k \cos \tau, \\ C'''(s) &= 2k^2[\sin \tau - k_1(x \cos \tau + y \sin \tau)] - 2k'(s)[\cos \tau + k_1(x \sin \tau - y \cos \tau)]; \\ C(s_1) &= 0, \quad C'(s_1) = 0, \quad C''(s_1) = 0, \quad C'''(s_1) = -2k'(s_1) \leq 0. \end{aligned}$$

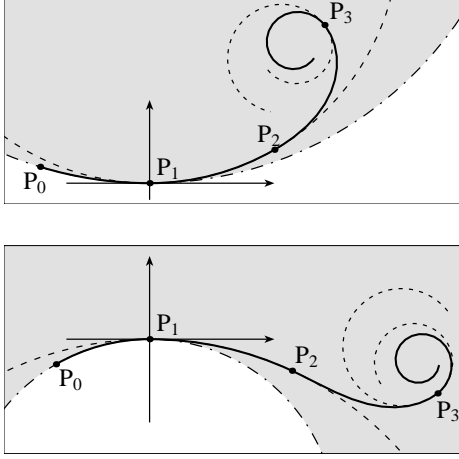

Fig. 4.

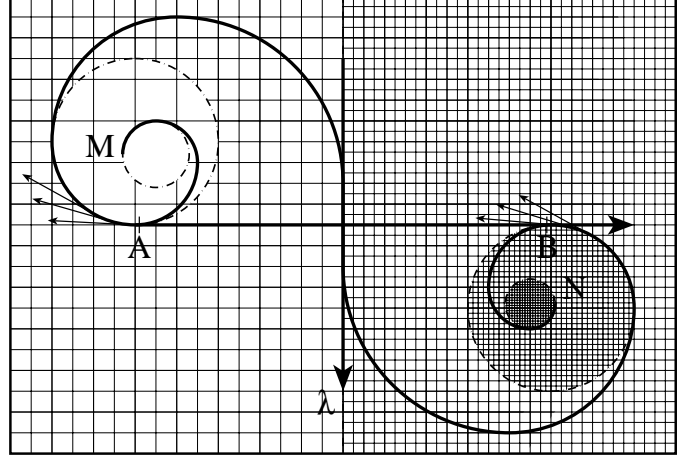

Fig. 5.

Whether $k(s)$ varies continuously or with a jump at s_1 , function $C(s)$ undergoes variation of the opposite sign; $C(s)$ going negative (or positive, if curvature decreases), the curve locally deviates to the left (or to the right) of \mathcal{K}_1 . q.e.d.

Theorem 4.2. *Let \mathcal{K}_1 and \mathcal{K}_2 be two circles of curvature of a spiral curve. Then*

$$Q(\mathcal{K}_1, \mathcal{K}_2) \leq 0, \quad (10)$$

and equality holds if and only if both circles belong to a circular subarc or to a biarc.

Proof. Denote the circle of curvature at the start point as \mathcal{K}_1 , $\mathcal{K}(s)$ being any other circle of curvature:

$$\mathcal{K}(s) = K(x(s), y(s), \tau(s), k(s)), \quad \mathcal{K}_1 = \mathcal{K}(0).$$

Two examples in Fig. 4 illustrate the proof for the case of increasing curvature with negative and positive start values $k_1 = k(0)$. The regions $\text{Mat}(\mathcal{K}_1)$ are shown in gray. Points P_i subdivide the spiral into subarcs $0 \leq s_1 \leq s_2 \leq s_3 \leq s_4 \leq S$, some of them possibly absent: P_0P_1 is the initial subarc of constant curvature (if any), coincident with \mathcal{K}_1 . As soon as the curvature increases at P_1 , with or without jump, the spiral deviates to the left from the circle \mathcal{K}_1 (Prop. 4.1). The arc P_0P_1 may be supplemented to a biarc by another circular arc P_1P_2 ; point P_3 represents any curvature jump, where there are two circles of curvature $\mathcal{K}(s_3 \pm 0)$, left and right. Point $P_4 = Z(s_4)$, if exists, is the point, where local property 4.1 is no more valid, i.e. spiral returns to the boundary of \mathcal{K}_1 . Thus, with expression (9) for $C(s)$ involved,

$$\begin{aligned} C(s) &= 0 & \text{if } 0 \leq s \leq s_1, \quad \text{or } s = s_4, \\ C(s) &< 0 & \text{if } s_1 < s < s_4. \end{aligned}$$

Associate the coordinate system with the line element $(x(s_1), y(s_1), \tau(s_1))$ such that $\mathcal{K}_1 = \mathcal{K}(0) = \mathcal{K}(s_1 - 0) = K(0, 0, 0, k_1)$. Define function $Q(s) = Q(\mathcal{K}_1, \mathcal{K}(s))$ from (7):

$$Q(s) = \frac{1}{4}k(s)C(s) - \frac{k_1}{2}[x(s) \sin \tau(s) - y(s) \cos \tau(s)] + \sin^2 \frac{\tau(s)}{2} \quad [Q(0) = 0] \quad (11)$$

Show that $Q(s)$ is monotonic decreasing in $[0, s_4]$. Differentiating of $Q(s)$ yields

$$Q'(s) = \frac{1}{4}k'(s)C(s) \implies Q'(s) \leq 0 \quad (12)$$

for increasing $k(s)$. Hence, $Q(s)$ is decreasing in every segment of its continuity. Make sure that jumps of $Q(s)$ at some point s_3 , such that $k(s_3-0) < k(s_3+0)$, conform to its decreasing behavior. Because functions $x(s)$, $y(s)$, $\tau(s)$ and $C(s)$ are continuous, and $C(s_3)$ is still negative, we deduce from (11):

$$Q(s_3+0) - Q(s_3-0) = \frac{1}{4}[k(s_3+0) - k(s_3-0)]C(s_3) < 0, \quad (13)$$

and $Q(s)$ is decreasing in the entire segment $[0, s_4]$.

In the case of biarc in $[0, s_1] \cup [s_1, s_2]$, $k(s)$ is piecewise constant. Function $Q(s)$ is continuous and zero up to s_1 , remains so in s_1 (despite of curvature jump, due to $C(s_1)=0$), and until s_2 , due to $k'(s)=0$ in (12). If the entire curve is biarc, the initial circle of curvature \mathcal{K}_1 is never again reached by the second subarc until it makes complete 2π -turn, which contradicts to Def. 2.1.

At $s > s_2$, $Q(s)$ either continuously decreases, or undergoes negative jumps like (13). The theorem holds in $[0, s_4]$. It remains to prove that the point $Z(s_4)$ does not exist. Under conditions $C(s_4)=0$ and $Q_4=Q(s_4) < 0$ at such point, an attempt to determine $Z(s_4)=x_4+iy_4$ from two equations (9,11) fails: excluding x yields

$$\begin{aligned} k_1^2 y_4^2 - 2k_1 y_4 (1 + 2Q_4 \cos \tau_4 - \cos \tau_4) + (2Q_4 - 1 + \cos \tau_4)^2 &= 0, \\ y_4 &= \frac{1}{k_1} \left[1 - \cos \tau_4 (1 - 2Q_4) \pm \sin \tau_4 \sqrt{Q_4(1 - Q_4)} \right], \end{aligned}$$

i.e. unsolvability with $Q_4 < 0$ (or immediate contradiction $\sin^2(\tau_4/2) < 0$, if $k_1 = 0$). So, spiral never returns to its initial circle of curvature \mathcal{K}_1 . If the curvature decreases, the curve deviates to the right of \mathcal{K}_1 , and $C(s)$ changes sign. So do derivative $k'(s)$ and curvature jumps, thus preserving inequalities (13), (12), and (10). q.e.d.

The corollary to this theorem, due to W. Vogt (Satz 1 in [12]), is the absence of double points on a spiral. Kneser's theorem (see [3], theorem 3–12), stating that “*Any circle of curvature of a spiral arc contains every smaller circle of curvature of the arc in its interior and in its turn is contained in the interior of every circle of curvature of greater radius*” concerns spirals without inflection and can be generalized as follows:

Corollary 4.3. *Let $\mathcal{K}(s) = K(x(s), y(s), \tau(s), k(s \pm 0))$ be a family of circles of curvature of a spiral curve. Then the region of material of any circle includes the region of material of any other circle with greater curvature:*

$$k(s_2) > k(s_1) \implies \text{Mat}(\mathcal{K}(s_2)) \subset \text{Mat}(\mathcal{K}(s_1)).$$

Fig. 5 illustrates the statement. The region $\text{Mat}(\mathcal{K}_M)$ of the initial circle of curvature is the whole plane except the interior of \mathcal{K}_M . As the curvature increases, the regions of material become smaller, each next being within the previous one. They remain unbounded up to the inflection point, whose region of material is the right half-plane.

Figs. 6a,b,c illustrate theorem 4.2 for normalized spiral. With boundary circles of curvature (4) and angles ω and γ , defined by (5), inequality (10) takes form

$$\begin{aligned} Q(\kappa_1, \kappa_2, \alpha, \beta) &= \kappa_1 \kappa_2 + \kappa_2 \sin \alpha - \kappa_1 \sin \beta + \sin^2 \gamma = \\ &= (\kappa_1 + \sin \alpha)(\kappa_2 - \sin \beta) + \sin^2 \omega \leq 0, \end{aligned} \quad (14)$$

Having fixed α and β , consider the region of permissible values for normalized boundary curvatures in the plane (κ_1, κ_2) . This region consists of two subregions, each bounded by one of the two branches of the hyperbola $Q(\kappa_1, \kappa_2) = 0$, traced at the left side of Fig. 6. Its centre is located in the point $C(\kappa_1, \kappa_2) = (-\sin \alpha, \sin \beta)$; these two curvatures correspond to those of lense's boundaries.

Biarc marked as h_i in the right side have boundary curvatures (κ_1, κ_2) corresponding to the points H_i of the hyperbola. By theorem 4.2, every biarc represents the *unique spiral*, matching end conditions of this kind. Non-biarc curves are presented by some point K in the plane (κ_1, κ_2) , and the arc k of Cornu spiral in the plane (x, y) .

Corollary 4.4. *End conditions of a normalized spiral arc obey the following inequalities:*

$$\begin{aligned} \kappa_1 < -\sin \alpha, \quad \kappa_2 > \sin \beta, & \quad \text{if } \kappa_1 < \kappa_2; \\ \kappa_1 > -\sin \alpha, \quad \kappa_2 < \sin \beta, & \quad \text{if } \kappa_1 > \kappa_2. \end{aligned} \quad (15)$$

Proof. Inequalities (15) merely reflect the position of two regions $Q \leq 0$ with respect to the asymptotes of the hyperbola, vertical $(\kappa_1 = -\sin \alpha)$ and horizontal one $(\kappa_2 = \sin \beta)$. It remains to show that the line $\kappa_2 = \kappa_1$ separates the two branches of hyperbola, thus connecting inequalities (15) to specified conditions, increasing or decreasing curvature. Substituting $\kappa_1 = \kappa_2 = \kappa$ into the equation $Q(\kappa_1, \kappa_2, \alpha, \beta) = 0$ yields

$$\kappa^2 + \kappa(\sin \alpha - \sin \beta) + \sin^2 \gamma = (\kappa + \sin \gamma \cos \omega)^2 + \sin^2 \gamma \sin^2 \omega = 0. \quad (16)$$

Hence, except special cases $\sin \gamma = 0$ or $\sin \omega = 0$, statement (15) is valid: two convex regions, bounded by the upper left and the lower right branches of hyperbola, are the regions of possible boundary curvatures for $\kappa_1 < \kappa_2$ and $\kappa_1 > \kappa_2$ respectively.

The first exception, $\sin \gamma = 0$, occurs if $\alpha = \beta$ and provides the unique common point $\kappa_1 = \kappa_2 = 0$ without intersecting the hyperbola (point H_0 and degenerate biarc h_0 in Fig. 6b). The statement, assuming $\kappa_1 \neq \kappa_2$, remains valid.

The second exception, $\sin \omega = 0$, i.e. $\alpha = -\beta$, is illustrated by Fig. 6d. The hyperbola degenerates into a pair of straight lines with the centre C on the line $\kappa_1 = \kappa_2$, still separating two regions in question. However, inequalities (15) should be considered as non-strict, like $\kappa_1 \leq -\sin \alpha$, because the hyperbola is coincident with its asymptotes. By theorem 4.2, a spiral, corresponding to equality, may be only biarc. Attempt to construct it gives the only possibility: the first subarc with $\kappa_1 = -\sin \alpha$, going from A to B , and the second subarc being circumference of a circle of any curvature κ_2 from B to B (examples h_1 and h_2). Similar constructions $h_{3,4}$ arise with $\kappa_2 = \sin \beta$ and arbitrary κ_1 . Since Def. 2.1 excludes this construction, the points of such degenerated hyperbola do not produce a spiral, and should be excluded. Inequalities (15) remain strict. q.e.d.

Let us apply inequality (10) to another Vogt's statement, namely, that *spiral has no double tangent* (Satz 7 in [12]). Its refined form is illustrated by the double tangent \overrightarrow{BA} in Fig. 5, and sounds like

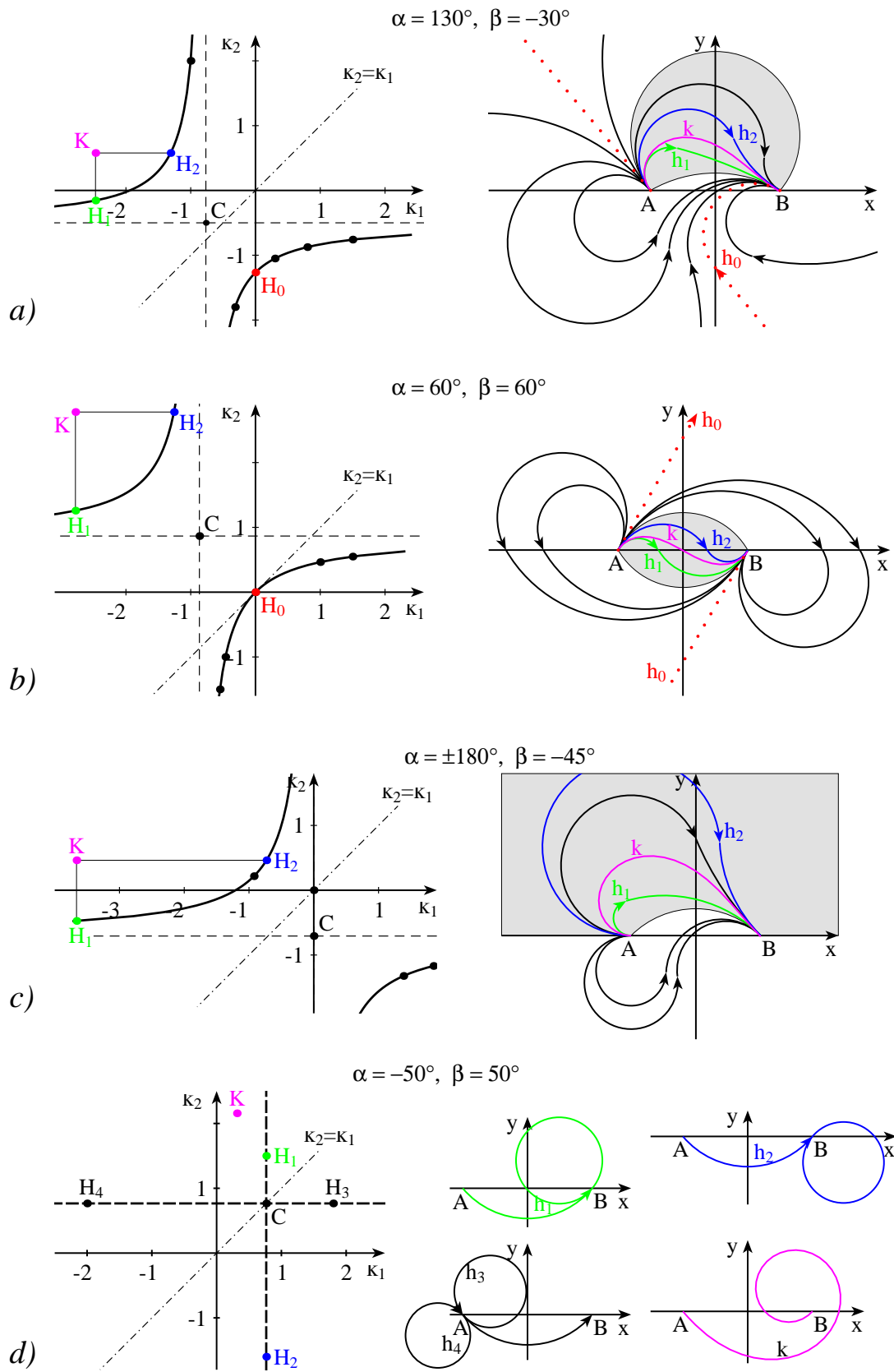

Corollary 4.5. *Spiral curve may have double tangent only if this tangent joins points with opposite curvature sign, or is coincident with the inflection segment of the spiral.*

Proof. Two curvature elements with common tangent can be denoted as

$$K(x_1, y_1, \tau_1, k_1) \quad \text{and} \quad K(x_1+t \cos \tau_1, y_1+t \sin \tau_1, \tau_1, k_2), \quad t \neq 0.$$

Inequality (10) takes form $4Q = k_1 k_2 t^2 \leq 0$, supplying the proof for the general case, $Q < 0$, $k_{1,2} \neq 0$. Consider exceptions. If, say, $k_1 = 0$, the spiral deviates from its tangent as soon as $k(s)$ becomes non-zero. By Cor. 4.3, the spiral has no more common points with this tangent. The biarc case, $Q = 0$, is trivial: two tangent circles may have common tangent only in their unique common point. q.e.d.

Corollary 4.6. *The tangent at the inflection point of a normalized spiral arc cuts the interior of the chord and is directed downwards (i.e. $\sin \tau(s_0) < 0$) if curvature increases, or upwards ($\sin \tau(s_0) > 0$) if curvature decreases.*

Proof. The tangent at the inflection point $Z(s_0)$ is at the same time the circle of curvature \mathcal{K}_0 (Figs. 5 and 11a). By Cor. 4.3, the endpoints A and B of the arc are disposed bilaterally along \mathcal{K}_0 . That's why \mathcal{K}_0 cuts the chord in the interior. For increasing $k(s)$, point A is located from the right of the line \mathcal{K}_0 , and B from the left of it. For normalized curve, when \overrightarrow{AB} is brought horizontal, this is equivalent to downwards directed tangent \mathcal{K}_0 . q.e.d.

Two following propositions are our previous results from [6]. They can be easily derived from parametric equation of curve, inverse to given one, by calculating and differentiating its curvature.

Proposition 4.7. *Inversion, applied to a spiral curve, preserves the monotonicity of the curvature, interchanging its decreasing/increasing character.*

Proposition 4.8. *If a curvature element \mathcal{K}_1 is inverted with respect to a circle of inversion \mathcal{K}_0 , the curvature of the image \mathcal{K}_2 is given by*

$$k_2 = 2k_0(1 - 2Q_{01}) - k_1, \quad Q_{01} = Q(\mathcal{K}_0, \mathcal{K}_1).$$

The direction, artificially assigned to the circle of inversion, does not affect the inverse curve. If \mathcal{K}_0 is reversed, both k_0 and $(1 - 2Q_{01})$ change sign.

5 Vogt's theorem for long spirals

On the spiral $Z(s) = x(s) + iy(s)$, $s \in [0, S]$, consider subarc $s \in [u, v]$ and define functions

$$h(u, v) = |Z(v) - Z(u)|, \quad \mu(u, v) = \arg[Z(v) - Z(u)] \quad (17)$$

for the length and direction of the chord. For any subarc and the entire curve the cumulative boundary angles $\tilde{\alpha}(u, v)$ and $\tilde{\beta}(u, v)$ with respect to varying chord $AB(u, v)$ can be expressed as

$$\begin{aligned} \tilde{\alpha}(u, v) &= \tau(u) - [\mu(u, v) + 2\pi m], \\ \tilde{\beta}(u, v) &= \tau(v) - [\mu(u, v) + 2\pi m], \end{aligned} \quad (18)$$

satisfying the natural condition for the *winding angle* ρ of the arc:

$$\tilde{\beta}(u, v) - \tilde{\alpha}(u, v) = \tau(v) - \tau(u) = \int_u^v k(s) ds = \rho(u, v).$$

This still allows to assign any value $\alpha + 2\pi n$ to $\tilde{\alpha}$. To fix it, we note that the angles $\tilde{\alpha}$ and $\tilde{\beta}$ can be unambiguously determined within the range $(-\pi, \pi)$ for rather short subarc $[u_0, v_0]$. In particular, $\tilde{\alpha}(u, u) = \tilde{\beta}(u, u) = 0$. Define cumulative angular functions for any arc $[u, v]$ as

$$\tilde{\alpha}, \tilde{\beta}(u, v) = \lim_{\substack{u_0 \rightarrow u \\ v_0 \rightarrow v}} \tilde{\alpha}, \tilde{\beta}(u_0, v_0), \quad u \leq u_0 = v_0 \leq v, \quad (19)$$

preserving continuity at $\tilde{\alpha}, \tilde{\beta} = \pm\pi, \pm 3\pi, \dots$, while the limits are being reached.

Lemma 5.1. *Cumulative boundary angles $\tilde{\alpha}, \tilde{\beta}$, defined by Eq. (19), do not depend on the start point $u_0 = v_0$ and the way the limits are reached.*

Proof. To calculate $\tilde{\alpha}(u, v)$ and $\tilde{\beta}(u, v)$ or, for symmetry, function

$$\tilde{\omega}(u, v) = \frac{1}{2}[\tilde{\alpha}(u, v) + \tilde{\beta}(u, v)] = \frac{1}{2}[\tau(u) + \tau(v)] - [\mu(u, v) + 2\pi m], \quad (20)$$

let us restore it from derivatives, which are free from $2\pi m$ -uncertainty:

$$\begin{aligned} \frac{\partial \mu(u, v)}{\partial u} &= \frac{\partial}{\partial u} \arctan \frac{y(v) - y(u)}{x(v) - x(u)} = \\ &= \frac{-\sin \tau(u) \overbrace{[x(v) - x(u)]}^{h \cos \mu} + \cos \tau(u) \overbrace{[y(v) - y(u)]}^{h \sin \mu}}{[x(v) - x(u)]^2 + [y(v) - y(u)]^2} = -\frac{\sin \overbrace{[\tau(u) - \mu(u, v)]}^{\alpha(u, v) + 2\pi m}}{h(u, v)}. \end{aligned}$$

So,

$$\frac{\partial \mu(u, v)}{\partial u} = -\frac{\sin \alpha(u, v)}{h(u, v)}, \quad \frac{\partial \mu(u, v)}{\partial v} = \frac{\sin \beta(u, v)}{h(u, v)},$$

and

$$\begin{aligned} \frac{\partial \tilde{\omega}(u, v)}{\partial u} &= \frac{1}{2}k(u) + \frac{\sin \alpha(u, v)}{h(u, v)} = G(u, v), \\ \frac{\partial \tilde{\omega}(u, v)}{\partial v} &= \frac{1}{2}k(v) - \frac{\sin \beta(u, v)}{h(u, v)} = H(u, v). \end{aligned} \quad (21)$$

Continuous function $\tilde{\omega}(u, v)$ can be now calculated as

$$\int_{W_i W} G(u, v) du + H(u, v) dv \quad (22)$$

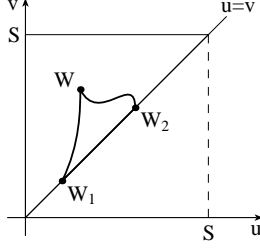

Fig. 7.

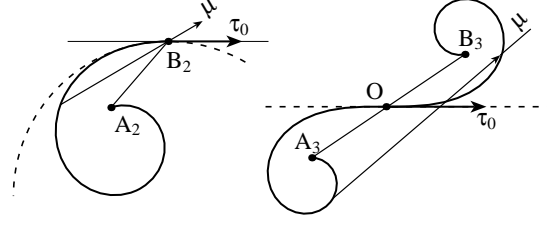
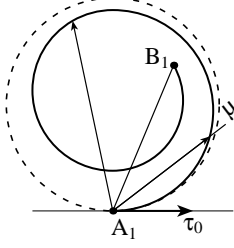

Fig. 8.

along any path $W_i W$ (shown in Fig. 7) in the closed triangular region $0 \leq u \leq v \leq S$ with W_i taken on the boundary $u = v$. From the expansions

$$\begin{aligned} \tau(u+s) &= \tau(u) + sk(u) + O(s^2), \\ Z(u+s) &= Z(u) + se^{i\tau(u)} + \frac{i}{2}s^2k(u)e^{i\tau(u)} + O(s^3), \\ h(u, u+s) &= |Z(u+s) - Z(u)| = s + O(s^2), \\ \mu(u, u+s) &= \arg[Z(u+s) - Z(u)] = \arg[e^{i\tau(u)}(s + \frac{i}{2}s^2k(u) + O(s^3))] = \\ &= \arg[e^{i\tau(u)}(1 + \frac{i}{2}sk(u) + O(s^2))] = \tau(u) + \frac{1}{2}sk(u) + O(s^2), \\ \alpha(u, u+s) &= \tau(u) - \mu(u, u+s) = -\frac{1}{2}sk(u) + O(s^2), \\ \beta(u, u+s) &= \tau(u+s) - \mu(u, u+s) = \frac{1}{2}sk(u) + O(s^2), \end{aligned}$$

it follows that derivatives (21) can be continuously defined on the line $u = v$ as zeros:

$$G(u, u) = \lim_{s \rightarrow 0} G(u, u+s) = \lim_{s \rightarrow 0} \left[\frac{1}{2}k(u) - \frac{\sin[sk(u)/2]}{s} \right] = 0, \quad H(u, u) = \dots = 0$$

This yields $\int_{W_1 W_2} = 0$ along the line $u = v$; and, together with

$$\frac{\partial G(u, v)}{\partial v} = \frac{\partial H(u, v)}{\partial u} \left[= -\frac{\sin(\alpha + \beta)}{h} \right],$$

ensures the independence of the integral (22) on a start point W_i and integration path. In terms of definition (19), the limits do not depend on the start point and the way they are reached. Finally, $\tilde{\alpha} = \tilde{\omega} - \rho/2$, $\tilde{\beta} = \tilde{\omega} + \rho/2$. q.e.d.

Definition 5.2. The angle $\tilde{\omega}$, defined above, will be referred to as *Vogt's angle* of a spiral arc. For short spiral Vogt's angle is the signed half-width of the lense $\mathbf{L}(\alpha, -\beta)$.

Definition 5.3. By the *reference point* of the spiral shall be meant the point $Z(s_0)$, corresponding to the minimal absolute value of curvature (points A_1 , B_2 and O in Fig. 8). If the spiral has inflection, $Z(s_0)$ is the inflection point; otherwise it is either start point ($s_0 = 0$) or the end point ($s_0 = S$).

If curvature increases (decreases), function $\tau(s)$ is downwards (upwards) convex and attains minimal (maximal) value at the reference point.

Lemma 5.4. *Function $\tilde{\tau}(s)$ for normalized spiral, taking cumulative angles $\tilde{\tau}(0) = \tilde{\alpha}$ and $\tilde{\tau}(S) = \tilde{\beta}$ as the boundary values, can be distinguished from its other versions, $\tilde{\tau}(s) \pm 2\pi m$, by the value at the reference point:*

$$0 < |\tilde{\tau}(s_0)| < \pi, \quad \text{or} \quad \begin{array}{ll} -\pi < \tilde{\tau}(s_0) < 0 & \text{if } k_1 < k_2, \\ 0 < \tilde{\tau}(s_0) < \pi & \text{if } k_1 > k_2. \end{array} \quad (23)$$

Proof. Based on lemma 5.1, calculate angles $\tilde{\alpha}(0, S)$ and $\tilde{\beta}(0, S)$ as follows. Choose the coordinate system with the origin at the reference point $Z(s_0)$ with X-axis directed along $\tau(s_0)$ (Fig. 8). In this system function $\tau(s)$ can be defined as

$$\tau(s) = \int_{s_0}^s k(\xi) d\xi, \quad \tau(s_0) = 0.$$

Calculate limits (19) starting from $u_0 = v_0 = s_0$, u nonincreasing, v nondecreasing. Consider the case of increasing curvature. If curvature is nonnegative (spiral A_1B_1), then, by Cor. 4.3, the curve is located in the upper half-plane, except initial subarc of zero curvature, if any. We keep u constant ($u = s_0 = 0$) and increase v . Because

$$\mu(s_0, s_0) = \lim_{\varepsilon \rightarrow +0} \mu(s_0, s_0 + \varepsilon) = \tau(s_0) = 0,$$

the angle $\mu(u, v)$ never attains the values $\pm\pi$, becoming strictly positive as soon as the point $Z(v)$ deviates from the axis of X :

$$0 < \mu(u, v) < \pi \quad \text{if } u \in [0, s_0], \quad v \in [s_0, S], \quad \text{and } k(u) < k(v). \quad (24)$$

The case of increasing nonpositive curvature (spiral A_2B_2) is similar: we start with $u_0 = v_0 = s_0 = S$ (point B_2), u decreasing, $v = S$ kept constant. Curve being located in the lower half-plane, (24) remains valid. So it does in the inflection case (A_3B_3): points $Z(u)$, $u \in [0, s_0]$, are located in the lower half-plane or its boundary, points $Z(v)$, $v \in [s_0, S]$ — in the boundary or upper half-plane. The angle $\mu(u, v)$ becomes strictly positive as soon as the point $Z(u)$ or $Z(v)$ deviates from the axis of X , and never attains the value π . For the three cases $2\pi m$ -uncertainty in (18) disappears, $m = 0$, and

$$\tilde{\alpha} = \tau(0) - \mu(0, S), \quad \tilde{\beta} = \tau(S) - \mu(0, S).$$

To normalize the curve, chords A_iB_i should be brought to horizontal position, i.e. rotation through the angle $-\mu(0, S) \in (-\pi, 0)$ should be applied. This means replacing $\tau(s)$ by

$$\tilde{\tau}(s) = -\mu(0, S) + \tau(s),$$

whose values at $s = 0, S$ and s_0 are equal to

$$\tilde{\tau}(0) = \tau(0) - \mu(0, S) = \tilde{\alpha}, \quad \tilde{\tau}(S) = \tilde{\beta}, \quad \tilde{\tau}(s_0) = 0 - \mu(0, S) \in (-\pi, 0). \quad \text{q.e.d.}$$

The angle $\tilde{\mu}(u, v)$ can be defined in the cumulative sense similarly to $\tilde{\omega}(u, v)$; limits like (19) for $\tilde{\mu}$ can be calculated starting from $\tilde{\mu}(s, s) = \tilde{\tau}(s)$. In an equivalent manner $\tilde{\mu}(u, v)$ can be derived from (20), where it is bracketed as $[\mu(u, v) + 2\pi m]$:

$$\tilde{\mu}(u, v) = \frac{\tilde{\tau}(u) + \tilde{\tau}(v)}{2} - \tilde{\omega}(u, v). \quad (25)$$

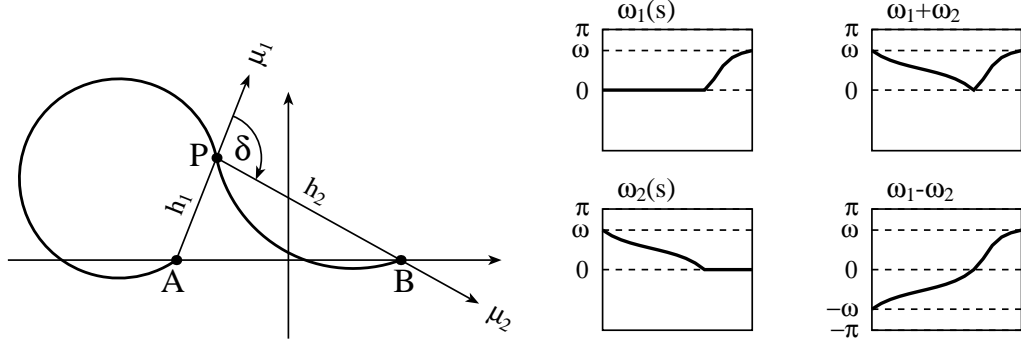

Fig. 9.

For future use we notice, as an immediate corollary of (24), the following inequality:

$$-\pi < \tilde{\mu}(s_0, S) - \tilde{\mu}(0, s_0) < \pi. \quad (26)$$

Theorem 5.5. *With boundary angles, defined in cumulative sense, Vogt's theorem remains valid for a spiral of any length:*

$$\text{sign } \tilde{\omega}(u, v) = \text{sign}[k(v) - k(u)], \quad \text{or} \quad \text{sign}(\tilde{\alpha} + \tilde{\beta}) = \text{sign}(k_2 - k_1).$$

Except the circular subarc, wherein Vogt's angle $\tilde{\omega}(u, v)$ is constant and zero, it is strictly monotonic function of the arc boundaries:

$$|\tilde{\omega}(u_1, v_1)| < |\tilde{\omega}(u, v)| \quad \text{if} \quad [u_1, v_1] \subset [u, v], \quad \text{and} \quad k(u) \neq k(v).$$

Proof. Rewrite derivatives (21) involving normalized curvatures $\kappa_1 = \frac{1}{2}h(u, v)k(u)$, $\kappa_2 = \frac{1}{2}h(u, v)k(v)$, and, assuming increasing curvature, the first row of (15):

$$\frac{\partial \tilde{\omega}(u, v)}{\partial u} = \frac{\kappa_1 + \sin \alpha}{h} \leq 0, \quad \frac{\partial \tilde{\omega}(u, v)}{\partial v} = \frac{\kappa_2 - \sin \beta}{h} \geq 0. \quad (27)$$

Equalities are added to account for the possible occurrence of a circular subarc within the spiral. If it is not the case, or as soon as $k(u) \neq k(v)$, function $\tilde{\omega}(u, v)$ grows up when u decreases and/or v increases. Because $\tilde{\omega}(s, s) = 0$, $\tilde{\omega}(u, v) > 0$ follows. q.e.d.

Recall that Vogt's angle is in fact the intersection angle of two circles. Taking into account continuity of $\tilde{\omega}(u, v)$, and Prop. 4.7, we conclude the following:

Corollary 5.6. *Inversion changes sign of Vogt's angle, preserving its absolute value.*

Now consider the point $P = Z(s)$, moving along the normalized spiral from A to B , and two subarcs of the spiral, AP and PB (Fig.9). Denote $h_1(s) = h(0, s) = |AP|$ and $h_2(s) = h(s, S) = |BP|$, and apply similar notation to introduce functions

$$\begin{aligned} \alpha_1(s) &= \tilde{\alpha}(0, s), & \beta_1(s) &= \tilde{\beta}(0, s), & \omega_1(s) &= \tilde{\omega}(0, s), & \mu_1(s) &= \tilde{\mu}(0, s), \\ \alpha_2(s) &= \tilde{\alpha}(s, S), & \beta_2(s) &= \tilde{\beta}(s, S), & \omega_2(s) &= \tilde{\omega}(s, S), & \mu_2(s) &= \tilde{\mu}(s, S). \end{aligned}$$

From equations

$$\begin{aligned} x(s) &= h_1(s) \cos \mu_1(s) - c = -h_2(s) \cos \mu_2(s) + c, \\ y(s) &= h_1(s) \sin \mu_1(s) = -h_2(s) \sin \mu_2(s) \end{aligned}$$

it follows that

$$h_1(s) = \frac{2c \sin \mu_2(s)}{\sin \delta(s)}, \quad h_2(s) = \frac{-2c \sin \mu_1(s)}{\sin \delta(s)}, \quad \text{where } \delta(s) = \mu_2(s) - \mu_1(s). \quad (28)$$

Function $\delta(s)$ inherits continuity and cumulative treatment from $\mu_{1,2}(s)$. It is the turning of the chord's direction at P , or signed external angle of the triangle APB at P . If P is in the upper half-plane, $\sin \delta(s)$ is negative; it is positive in the lower half-plane; $\delta(s) = 2\pi n$ if P is within the chord, and $\delta(s) = \pi(2n-1)$ if P belongs to chord's complement. The locus of points, where δ is constant, is the arc $\mathcal{A}(-\delta)$.

Lemma 5.7. *Function $\delta(s)$, defined on a spiral with increasing (decreasing) curvature, is strictly increasing (decreasing) from $\delta(0) = -\tilde{\alpha}$ to $\delta(S) = \tilde{\beta}$, taking value $-\pi < \delta(s_0) < \pi$ at the reference point; its derivative is continuous and does not vanish in $[0, S]$.*

Proof. Using (25), rewrite $\delta(s) = \mu_2(s) - \mu_1(s)$ as

$$\delta(s) = \left[\frac{\tilde{\tau}(s) + \tilde{\beta}}{2} - \tilde{\omega}(s, S) \right] - \left[\frac{\tilde{\alpha} + \tilde{\tau}(s)}{2} - \tilde{\omega}(0, s) \right] = \frac{1}{2} \rho(0, S) + \omega_1(s) - \omega_2(s). \quad (29)$$

Apply (21) to calculate derivative:

$$\begin{aligned} \delta'(s) &= \tilde{\omega}'_1(s) - \tilde{\omega}'_2(s) = \frac{\partial \tilde{\omega}(u, v)}{\partial v} \Big|_{u=0}^{v=s} - \frac{\partial \tilde{\omega}(u, v)}{\partial u} \Big|_{u=s}^{v=S} = \\ &= \left[\frac{1}{2} k(s) - \frac{\sin \beta_1(s)}{h_1(s)} \right] - \left[\frac{1}{2} k(s) + \frac{\sin \alpha_2(s)}{h_2(s)} \right] = -\frac{\sin \beta_1(s)}{h_1(s)} - \frac{\sin \alpha_2(s)}{h_2(s)}. \end{aligned} \quad (30)$$

Because $k(s)$ disappears in (30), $\delta'(s)$ is continuous even if the curvature jump occurs (smooth plot $\omega_1 - \omega_2$ in Fig. 9, compared to ω_1 and ω_2 , illustrates it).

As the point $P(s)$ moves along the spiral, the arc AP is lengthening, and the arc PB shortening. From theorem 5.5 it follows that $\omega_1(s)$ is increasing, and $\omega_2(s)$ decreasing (the case of increasing curvature is being considered). The difference $\omega_1(s) - \omega_2(s)$ in (29) is therefore an increasing function. So is $\delta(s)$: $\delta'(s) \geq 0$. The only possibility for equality is that $\tilde{\omega}'_{1,2}(s)$ are simultaneously zeros, i.e. subarcs AP and PB are of constant curvature. This means that the spiral APB is biarc, and P is the point of tangency of its two circular arcs, as depicted in Fig. 9. If it is the case, then the last two fractions in (30) are equal to k_1 and $-k_2$ respectively, and $\delta'(s_P) = \frac{1}{2}(k_2 - k_1) > 0$. The derivative is thus strictly positive everywhere in $(0, S)$, $\delta(s)$ is strictly increasing.

To calculate derivatives at the endpoints we have to resolve uncertainties $0/0$ in (30). For $\delta'(0)$ approximate the spiral near the startpoint by its circle of curvature:

$$\begin{aligned} Z(s) &= -c + \frac{i}{k_1} e^{i\alpha} (1 - e^{ik_1 s}) = -c + e^{i\alpha} s + \frac{i}{2} e^{i\alpha} k_1 s^2 + O(s^3), \\ \delta(s) &= \arg[c - Z(s)] - \arg[Z(s) + c] = \\ &= \left[-\frac{\sin \alpha}{2c} s + O(s^2) \right] - \left[\alpha + \frac{1}{2} k_1 s + O(s^2) \right] = -\alpha - \frac{k_1 c + \sin \alpha}{2c} s + O(s^2). \end{aligned}$$

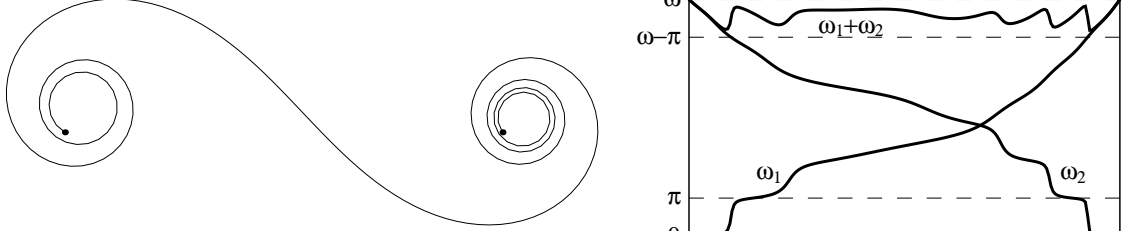

Fig. 10.

The coefficient at s is the derivative $\delta'(0)$. Similarly $\delta'(S)$ at the endpoint B can be found. Both are positive due to (15):

$$\delta'(0) = -\frac{k_1 c + \sin \alpha}{2c} > 0, \quad \delta'(S) = \frac{k_2 c + \sin \beta}{2c} > 0.$$

The value of $\delta(s_0)$ at the reference point is already estimated in (26). Boundary values can be calculated from (29):

$$\delta(0) = \frac{\tilde{\beta} - \tilde{\alpha}}{2} + 0 - \frac{\tilde{\alpha} + \tilde{\beta}}{2} = -\tilde{\alpha}, \quad \delta(S) = \frac{\tilde{\beta} - \tilde{\alpha}}{2} + \frac{\tilde{\alpha} + \tilde{\beta}}{2} - 0 = \tilde{\beta}. \quad \text{q.e.d.}$$

The plots $\omega_1 + \omega_2$ in Figs. 9 and 10 illustrate the following property of Vogt's angles: however large be the range $[0, \tilde{\omega}]$ of the monotonic functions $\omega_1(s)$ and $\omega_2(s)$, their sum is enclosed in the interval of the width π :

Lemma 5.8. *Let $\Omega(s) = |\omega_1(s)| + |\omega_2(s)| - |\tilde{\omega}|$. Then*

$$-\pi < \Omega(s) < 0 \quad \text{for } s \in (0, S). \quad (31)$$

Proof. For the case of increasing curvature all $\tilde{\omega}$'s are nonnegative, and

$$\begin{aligned} \Omega(s) &= \omega_1(s) + \omega_2(s) - \tilde{\omega} \stackrel{(20)}{=} \left[\frac{\tilde{\alpha} + \tilde{\tau}(s)}{2} - \mu_1(s) \right] + \left[\frac{\tilde{\tau}(s) + \tilde{\beta}}{2} - \mu_2(s) \right] - \frac{\tilde{\alpha} + \tilde{\beta}}{2} = \\ &= \tilde{\tau}(s) - \mu_1(s) - \mu_2(s). \end{aligned}$$

Continue calculation of the derivative (30), which is strictly positive:

$$\begin{aligned} \delta'(s) &= -\frac{h_2 \sin \beta_1 + h_1 \sin \alpha_2}{h_1 h_2} \stackrel{(28)}{=} 2c \frac{\sin \mu_1 \sin \beta_1 - \sin \mu_2 \sin \alpha_2}{h_1 h_2 \sin \delta} = \\ &= 2c \frac{\sin \mu_1 \sin(\tilde{\tau} - \mu_1) - \sin \mu_2 \sin(\tilde{\tau} - \mu_2)}{h_1 h_2 \sin \delta} = \frac{-2c}{h_1 h_2} \sin \Omega(s) > 0. \end{aligned}$$

The function $\Omega(s)$ takes zero values at the endpoints, and $\sin \Omega(s)$ is strictly negative in $(0, S)$. Invoking continuity of $\Omega(s)$, we conclude that it never reaches values 0 or $-\pi$ within $(0, S)$. q.e.d.

Now we recall Def. 2.3 to introduce some quantitative measure to the notion of a long spiral. The inflection point, if present, subdivides spiral into two branches, left and right. Points s_i^- , $i = 1, \dots, M_1$ on the left branch, and s_i^+ , $i = 1, \dots, M_2$ on the right branch are those, where Def. 2.3 of short arc is violated, i.e. $0 < s_i^\pm < S$, $\cos \tau(s_i^\pm) = -1$. Because $\sin \tau(s_i^\pm) = 0$, this cannot happen

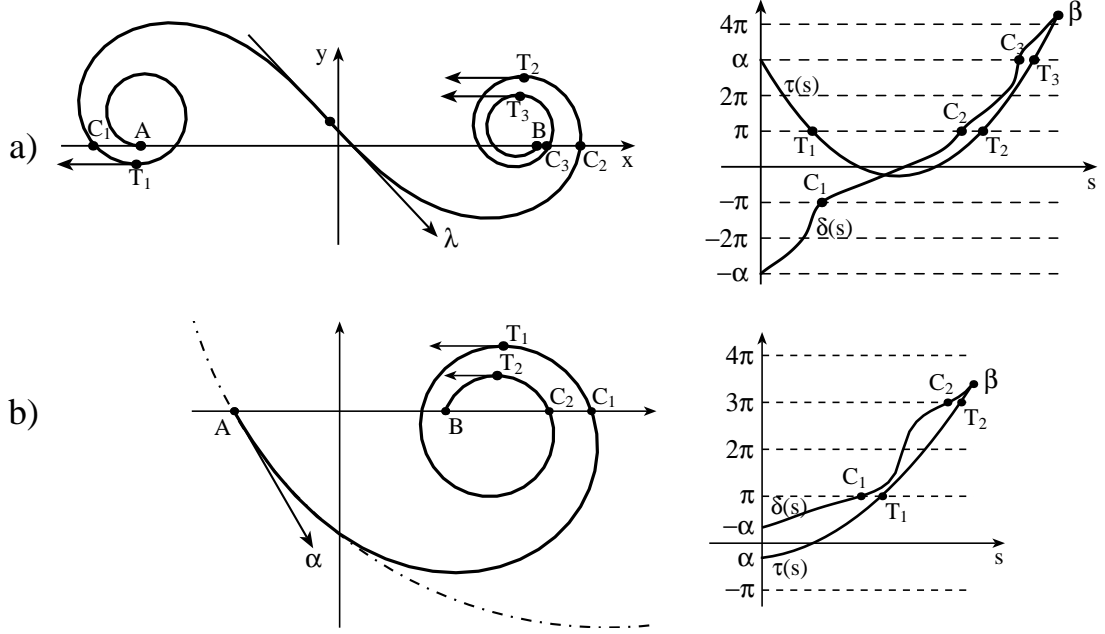

Fig. 11.

at the inflection (Cor. 4.6); so, s_i^\pm are distinct points, not continuous segments, as the inflection could be. If there are no such points or one branch is absent, the corresponding counter $M_{1,2}$ is zero.

Two other counters, $N_{1,2}$, are introduced in the context of Def. 2.4. They count internal points where the spiral meets the left (N_1) and the right (N_2) complements of the chord.

Theorem 5.9. *Counters $M_{1,2}$ and $N_{1,2}$ are pairwise equal. Cumulative boundary angles $\tilde{\alpha}$ and $\tilde{\beta}$ for a normalized spiral arc of increasing/decreasing curvature are*

$$\begin{aligned} k_1 < k_2 : & \quad \tilde{\alpha} = \alpha + 2\pi N_1, & \quad \tilde{\beta} = \beta + 2\pi N_2 & \quad \text{with} & \quad \alpha, \beta \in (-\pi, \pi], \\ k_1 > k_2 : & \quad \tilde{\alpha} = \alpha - 2\pi N_1, & \quad \tilde{\beta} = \beta - 2\pi N_2 & \quad \text{with} & \quad \alpha, \beta \in [-\pi, \pi), \end{aligned}$$

or, rewritten for the case of increasing curvature in more detailed form,

$$0 \leq k_1 < k_2 : \quad -\pi < \alpha < 0, \quad -\pi < \beta \leq \pi, \quad \tilde{\alpha} = \alpha \ (N_1 = 0), \quad \tilde{\beta} = \beta + 2\pi N_2; \quad (32)$$

$$k_1 < 0 < k_2 : \quad -\pi < \alpha \leq \pi, \quad -\pi < \beta \leq \pi, \quad \tilde{\alpha} = \alpha + 2\pi N_1, \quad \tilde{\beta} = \beta + 2\pi N_2; \quad (33)$$

$$k_1 < k_2 \leq 0 : \quad -\pi < \alpha \leq \pi, \quad -\pi < \beta < 0, \quad \tilde{\alpha} = \alpha + 2\pi N_1, \quad \tilde{\beta} = \beta \ (N_2 = 0). \quad (34)$$

Proof. Two cases, (33) and (32), are illustrated by Fig. 11. Right plots show functions $\tilde{\tau}(s)$ and $\delta(s)$. Consider the inflection case (33), Fig. 11a. Function $\tilde{\tau}(s)$ is decreasing from $\tilde{\alpha}$ to its minimal value $\tilde{\tau}(s_0) \in (-\pi, 0)$ at the reference (inflection) point, and then increases to $\tilde{\beta}$. In doing so, it meets $M_1 + M_2$ times the levels $\pi(2m-1)$ (points T_i). The following sequence of its values can be derived according to definition of counters $M_{1,2}$:

$$\tilde{\alpha}, \underbrace{\pi(2M_1-1), \pi(2M_1-3), \dots, \pi}_{M_1}, \tilde{\tau}(s_0), \underbrace{\pi, 3\pi, \dots, \pi(2M_2-1)}_{M_2}, \tilde{\beta}.$$

By lemma 5.7, function $\delta(s)$ is monotonic increasing from $-\tilde{\alpha}$ to $\tilde{\beta}$. Spiral cuts the complement of the chord at points C_i , when $\delta(s)$ meets levels $\pi(2n-1)$. The sequence of its values, similar to that of $\tilde{\tau}(s)$, looks like

$$-\tilde{\alpha}, \underbrace{-\pi(2M_1-1), -\pi(2M_1-3), \dots, -\pi}_{N_1}, \delta(s_0), \underbrace{\pi, 3\pi, \dots, \pi(2M_2-1)}_{N_2}, \tilde{\beta}.$$

The number of underbraced points is N_1+N_2 by definition of counters $N_{1,2}$. Separating them into two groups is justified as follows. First, the tangent at the inflection point separates two branches of the spiral and, by Cor. 4.6, two complements of the chord; hence, all the N_1 intersections with the left complement of the chord belong to the left branch and are followed by the set of the right-sided ones. Second, by lemma 5.7, the value $\delta(s) = -\pi$ terminates the first group of points, whose number is N_1 by definition and M_1 by calculation. Similarly, $M_2 = N_2$.

From the above sequences it follows as well: if the directions of tangents are α and β , and $|\alpha|, |\beta| < \pi$, the values $\alpha+2\pi N_1$ and $\beta+2\pi N_2$ are to be assigned to cumulative angles $\tilde{\alpha}, \tilde{\beta}$. If α or β is equal to $\pm\pi$, the correspondence is kept by the alternative resolved in favour of $+\pi$ (and $-\pi$ in the case of decreasing curvature).

In the case (32) of increasing nonnegative curvature (Fig. 11b), the curve has no left branch, and $M_1=0$ by definition. Point A is the reference point, so, by lemma 5.4, $-\pi < \tilde{\alpha} < 0$, $\tilde{\alpha} = \alpha$; the tangent at A is directed downwards. The region $\text{Mat}(\mathcal{K}_1)$ is either half-plane to the left of \mathcal{K}_1 (if $k_1=0$), or the interior of the circle \mathcal{K}_1 located in this half-plane. It covers the entire curve (Cor. 4.3), and cannot include any point of the left complement of the chord. Therefore $N_1=0=M_1$.

The rest of the proof is similar to that of the inflection case. Equality $N_2=M_2$ results from monotonic increasing behavior of functions $\tilde{\tau}(s)$ (from $\tilde{\alpha}$ to $\tilde{\beta}$) and $\delta(s)$ (from $-\tilde{\alpha}$ to $\tilde{\beta}$), and counting points T_i and C_i .

The proofs for the case (34) of increasing nonpositive curvature can be obtained by applying symmetry about Y-axis. Symmetry about X-axis provides the proof for the three similar cases of decreasing curvature. q.e.d.

Corollary 5.10. *Definitions 2.3 and 2.4 of a short spiral are equivalent.*

Polygonal line $ACDF$ in Fig. 12 bounds the open region of possible values of $\tilde{\alpha}, \tilde{\beta}$ for spirals with increasing curvature. Boundary CD results from Vogt's theorem, AC and DF — from (32)–(34). Triangle GDC , including half-open segments $(CG]$ and $[GD)$, is the boundary for short spirals. Biarc curves can be constructed with $\tilde{\alpha}, \tilde{\beta}$ in the interior of trapezium $BCDEB$ (see discussion in the next section). Similar regions for decreasing curvature are symmetric about the line CD ($\tilde{\alpha}+\tilde{\beta}=0$). Describing these regions in the coordinate system ($\rho = \tilde{\alpha}-\tilde{\beta}$, $2\tilde{\omega} = \tilde{\alpha}+\tilde{\beta}$) looks as follows:

Corollary 5.11. *The winding angle ρ of a spiral is limited by*

$$|\rho| < 2|\tilde{\omega}| + 2\pi.$$

If spiral has no inflection (cases (32) and (34)), than

$$0 < 2|\tilde{\omega}| < |\rho| < 2|\tilde{\omega}| + 2\pi.$$

If a spiral undergoes inversion, $|\tilde{\omega}|$ remains constant, and ρ can vary in these limits. The latter inequality is similar to the fact that a small non-closed circular arc ($|\tilde{\omega}|=0$) can be transformed by inversion to almost 2π -circle, and vice versa ($0 \leq |\rho| < 2|\tilde{\omega}| + 2\pi = 2\pi$).

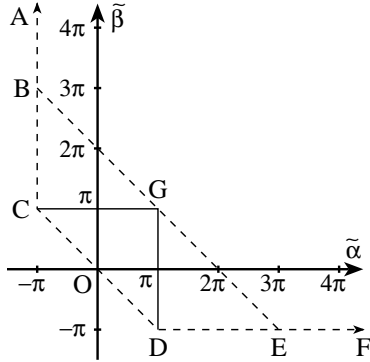

Fig. 12.

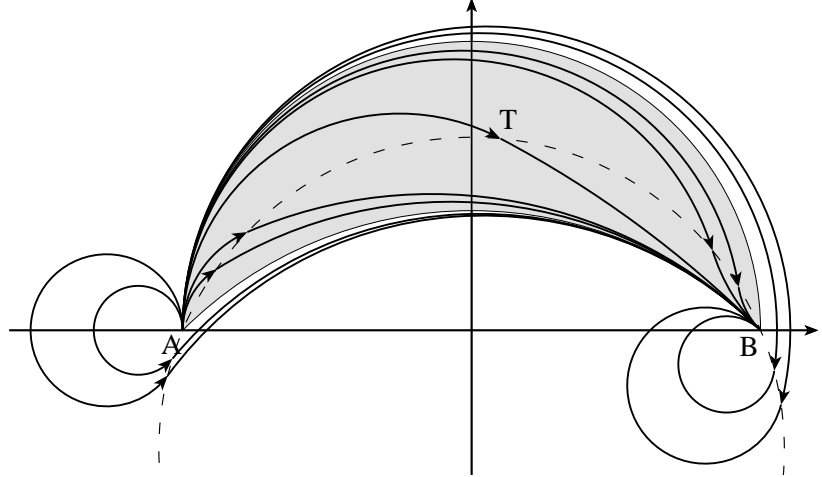

Fig. 13.

6 Biarc curves

Biarc curves, considered hitherto as a flexible tool for curves interpolation, play an important role in the theory of spiral curves. However much had been written about biarcs (see [9] and references herein, [15] for long biarcs), the presented description seems to have several advantages. Normalized position can be considered as canonical for these curves, and allows to separate the parameters of shape from positional ones. The proposed parametrization yields a set of simple and symmetric reference formulae. No different treatment for “C-shaped” and “S-shaped” biarcs is needed. The specific cases of $\alpha = \pm\pi$ or $\beta = \pm\pi$, usually omitted, are taken into consideration.

The condition of tangency of two arcs, forming biarc, is the equation

$$Q(\kappa_1, \kappa_2, \alpha, \beta) = (\kappa_1 + \sin \alpha)(\kappa_2 - \sin \beta) + \sin^2 \omega = 0$$

(recall hyperbolas in Fig. 6). This condition allows two arcs to be a pair of equally directed straight lines (“biarc” h_0 in Fig. 6b). The hyperbola can be parametrized as follows:

$$\begin{cases} \kappa_1(b) = -\sin \alpha - b^{-1} \sin \omega, \\ \kappa_2(b) = \sin \beta + b \sin \omega, \end{cases} \quad (35)$$

Note that ω is the half-width of the lense, equal to Vogt’s angle $\tilde{\omega}$ only if biarc is short; otherwise $\tilde{\omega} = \omega \pm \pi$. Parametrization (35) supplies the parameter b for the one-parametric family of biarcs with fixed chord $[-1, 1]$ and fixed tangent directions α and β . As established in the proof of Cor. 4.4 (Fig. 6d), biarcs with $\sin \omega = 0$ do not exist. Every value of b produces the unique point on the hyperbola, unique pair of circles \mathcal{K}_1 and \mathcal{K}_2 , tangent at the point T , unique path ATB , and unique biarc, denoted below as $\mathcal{B}(b; \alpha, \beta)$ or simply $\mathcal{B}(b)$.

Solving the system of two equations $C(x, y; \mathcal{K}_{1,2}) = 0$ (2) yields coordinates of the point $T = (x_0, y_0)$ of contact of two arcs:

$$x_0 = \frac{b^2 - 1}{\Delta}, \quad y_0 = \frac{2b \sin \gamma}{\Delta}, \quad \Delta = b^2 + 2b \cos \gamma + 1. \quad (36)$$

The direction τ_0 of the common tangent at this point is given by

$$\begin{aligned} \sin \tau_0 &= -(b^2 \sin \alpha + 2b \sin \omega + \sin \beta)/\Delta, \\ \cos \tau_0 &= (b^2 \cos \alpha + 2b \cos \omega + \cos \beta)/\Delta, \end{aligned} \quad \tan \frac{\tau_0}{2} = -\frac{b \sin(\alpha/2) + \sin(\beta/2)}{b \cos(\alpha/2) + \cos(\beta/2)}. \quad (37)$$

The circular arc from B to A , complementary to the arc $\mathcal{A}(\gamma)$, will be referred to as the *complement of the bisector* of the lense. Both bisector and its complement form the circle Γ , shown dashed in Fig. 13:

$$\Gamma = K(-1, 0, \gamma, -\sin \gamma), \quad C(x, y; \Gamma) \stackrel{(2)}{=} -\sin \gamma(x^2 + y^2 - 1) - 2y \cos \gamma.$$

Except property (viii), the following properties of biarcs are either known or easy to prove by means of elementary geometry:

- (i) *The locus of contact points $T(b) = (x_0(b), y_0(b))$ (36) is the circle Γ . Points $T(b)$ with $b > 0$ are located on the bisector, those with $b < 0$, on its complement.*
- (ii) *All biarcs meet the the circle Γ at the constant angle ω .*
- (iii) *Definitions $\mathcal{B}(\infty; \alpha, \beta) = \mathcal{A}(\alpha)$ and $\mathcal{B}(0; \alpha, \beta) = \mathcal{A}(-\beta)$, are illustrated by Fig. 13 and justified as follows:*

$$\begin{aligned} b \rightarrow \infty : \quad \kappa_1 &\rightarrow -\sin \alpha, & \kappa_2 &\rightarrow \infty, & T &\rightarrow B, & \mathcal{B}(b; \alpha, \beta) &\rightarrow \mathcal{A}(\alpha); \\ b \rightarrow 0 : \quad \kappa_1 &\rightarrow \infty, & \kappa_2 &\rightarrow \sin \beta, & T &\rightarrow A, & \mathcal{B}(b; \alpha, \beta) &\rightarrow \mathcal{A}(-\beta). \end{aligned} \quad (38)$$

- (iv) *The possible values for the pair of counters (N_1, N_2) are $(0, 0)$, $(0, 1)$ or $(1, 0)$. For given tangents α, β , the cumulative angles $\tilde{\alpha}, \tilde{\beta}$ can take values (arrows mark the cases of increasing (\uparrow) or decreasing (\downarrow) curvature):*

$$\begin{aligned} \text{if } \alpha + \beta > 0, & \quad (\tilde{\alpha}, \tilde{\beta}) = (\alpha, \beta)^\uparrow, \quad (\alpha - 2\pi, \beta)^\downarrow, \quad (\alpha, \beta - 2\pi)^\downarrow; \\ \text{if } \alpha + \beta < 0, & \quad (\tilde{\alpha}, \tilde{\beta}) = (\alpha, \beta)^\downarrow, \quad (\alpha + 2\pi, \beta)^\uparrow, \quad (\alpha, \beta + 2\pi)^\uparrow. \end{aligned} \quad (39)$$

The first group, biarcs with $(\tilde{\alpha}, \tilde{\beta}) = (\alpha, \beta)$, corresponds to $b > 0$; they are short and enclosed within the lense. Biarcs with $b < 0$ are located outside the lense. They are long, unless $\alpha = \pm\pi$ or $\beta = \pm\pi$ (see vi).

- (v) *Discontinuous biarcs (such as shown in Figs. 6a,b by dotted lines) correspond to nonpositive parameter value b^* , defined by*

$$b^* = \begin{cases} -\frac{\sin \omega}{\sin \alpha} & \text{if } |\alpha| \geq |\beta| \quad [\kappa_1(b^*) = 0], \\ -\frac{\sin \beta}{\sin \omega} & \text{if } |\alpha| \leq |\beta| \quad [\kappa_2(b^*) = 0], \end{cases}.$$

Three biarcs with $b \in \{\infty; b^; 0\}$ subdivide the XY -plane into three regions, one of them being the lense. Every region encloses one of the three subfamilies (39).*

- (vi) *If $\alpha = \pm\pi$ or $\beta = \pm\pi$ (Fig. 6c), one of these three regions, as well as one of three subfamilies (39), disappear. The degenerate biarc is at the same time lense's boundary ($b^* = 0$ or $b^* = \infty$). All such biarcs are short; and $\mathcal{B}(b; \pi, \beta) = \mathcal{B}(-b; -\pi, \beta)$, $\mathcal{B}(b; \alpha, \pi) = \mathcal{B}(-b; \alpha, -\pi)$.*

(vii) Taking into account biarcs $\mathcal{B}(\infty)$, $\mathcal{B}(b^*)$ and $\mathcal{B}(0)$, there is a unique biarc $\mathcal{B}(b(x, y))$, passing through every point (x, y) in the plane, excluding poles A and B . Namely,

$$b(x, y) = \begin{cases} \frac{\sin \omega [(x+1)^2 + y^2]}{(1-x^2-y^2) \sin \alpha - 2y \cos \alpha}, & \text{if } C(x, y; \Gamma) \sin \omega \leq 0, \\ \frac{(1-x^2-y^2) \sin \beta + 2y \cos \beta}{\sin \omega [(x-1)^2 + y^2]}, & \text{if } C(x, y; \Gamma) \sin \omega \geq 0. \end{cases} \quad (40)$$

(viii) The length $L(b)$ of short biarc

$$L(b) = \frac{\tau_0(b) - \alpha}{k_1(b)} + \frac{\beta - \tau_0(b)}{k_2(b)} \quad \left[L(0) = \frac{2c\alpha}{\sin \alpha}, \quad L(\infty) = \frac{2c\beta}{\sin \beta} \right],$$

is strictly monotonic function of b , or constant, if $\alpha = \beta$ (the uncertainties $0/0$, wherever occur, are simply reducible).

To prove (i) note that (36) is the parametric equation of the circle Γ . Ordinates of the points, belonging to the bisector, should have the same sign as the angle γ , and this is achieved at $b > 0$:

$$\gamma \neq 0, \quad b > 0 \quad \implies \quad \text{sign } y_0 = \text{sign } \gamma \quad (\text{Fig. 6a}).$$

If $\gamma = 0$, the bisector is coincident with the chord; this corresponds to $b > 0$ as well:

$$\gamma = 0, \quad b > 0 \quad \implies \quad y_0 = 0, \quad |x_0| = \left| \frac{b^2 - 1}{b^2 + 2b + 1} \right| = \left| \frac{b-1}{b+1} \right| < 1 \quad (\text{Fig. 6b}).$$

In both cases points $T(b)$ for biarcs with $b < 0$ fill the complement of the bisector.

Provided that the locus $T(b)$ is circle Γ , (ii) is evident.

Property (iv) can be derived from the fact that one of two subarcs of a biarc is located inside the circle Γ , and the other outside it. Only outside one can meet the chord's complement; and this may happen only once.

Points of contact $T(b)$, $b > 0$, are inside the lense. So are subarcs AT , TB , and the entire biarc curve. Being inside lense, *biarcs with $b > 0$ are short*, their cumulative boundary angles are $(\tilde{\alpha}, \tilde{\beta}) = (\alpha, \beta)$. Points $T(b)$, $b < 0$, filling the complement of the bisector, are outside the lense together with associated biarcs.

The discontinuous biarc $\mathcal{B}(b^*)$ may arise only if one of the two curvatures is zero. Let $\kappa_1(b^*) = 0$ (Fig. 6a), i.e. $b^* = -\sin \omega / \sin \alpha$. The parametric equation of the subarc AT is

$$x(s) = -1 + s \cos \alpha, \quad y(s) = s \sin \alpha.$$

This ray reaches the point of contact T (36) when $y(s_T) = s_T \sin \alpha = y_0$, i.e.

$$s_T = \frac{2b^* \sin \gamma}{(b^{*2} + 2b^* \cos \gamma + 1) \sin \alpha} = \frac{-2 \sin \gamma \sin \omega}{\sin^2 \alpha - 2 \cos \gamma \sin \alpha \sin \omega + \sin^2 \omega} = -2 \frac{\sin \omega}{\sin \gamma}$$

($\omega + \gamma$ was substituted for α). If $s_T > 0$, then tangency occurs before the ray goes off into infinity, and the biarc is normally continued by the second arc TB with $\kappa_2 \neq 0$. Discontinuity occurs under the condition $-\infty \leq s_T < 0$, equivalent to $\cos \alpha \leq \cos \beta$, and rewritten in (v) as $|\alpha| \geq |\beta|$.

To derive (40), one should first decide, to which subarc of the sought for biarc $\mathcal{B}(b; \alpha, \beta)$ the point (x, y) belongs. The circle Γ separates two subarcs, and the decision depends on the sign of $C(x, y; \Gamma)$. The arc AT goes to the left of Γ ($AT \in \text{Mat}(\Gamma)$, $C(x, y; \Gamma) \leq 0$) if the vector, defined by α , points to the left of the vector, defined by γ : $\gamma < \alpha = \omega + \gamma$, i.e. $\omega > 0$, $\sin \omega > 0$. And AT goes to the right of Γ if $\sin \omega < 0$. So,

$$\begin{aligned} (x, y) \in \widehat{AT} \in \mathcal{K}_1 &\iff [C(x, y; \Gamma) \leq 0 \wedge \sin \omega > 0] \vee [C(x, y; \Gamma) \geq 0 \wedge \sin \omega < 0] \\ &\iff C(x, y; \Gamma) \cdot \sin \omega \leq 0. \end{aligned}$$

Under this condition define b from the implicit equation (2) of circle \mathcal{K}_1 :

$$\underbrace{(-\sin \alpha - b^{-1} \sin \omega)}_{\kappa_1} [(x+1)^2 + y^2] + 2(x+1) \sin \alpha - 2y \cos \alpha = 0.$$

Below we prove property (viii).

Proof. For the case of symmetric lense, i.e. $\alpha = \beta = \omega$, $\gamma = 0$, $\tau_0(b) = -\omega = \text{const}$, and

$$L(b) = \frac{-2\omega}{-\sin \omega - b^{-1} \sin \omega} + \frac{2\omega}{\sin \omega + b \sin \omega} = \frac{2\omega}{\sin \omega}$$

($c = 1$ assumed). For general case, $\gamma \neq 0$, we replace the parameter b by $\theta = \tau_0(b)$. As b varies from 0 to ∞ , θ varies (monotonously) from β to $-\alpha$. Solving (37) for b yields

$$b = -\frac{\tan \frac{\theta}{2} \cos \frac{\beta}{2} + \sin \frac{\beta}{2}}{\tan \frac{\theta}{2} \cos \frac{\alpha}{2} + \sin \frac{\alpha}{2}} = -\frac{\sin \frac{\beta + \theta}{2}}{\sin \frac{\alpha + \theta}{2}},$$

and

$$\begin{aligned} \kappa_1(\theta) &= \sin \gamma \frac{\sin \frac{\alpha - \theta}{2}}{\sin \frac{\beta + \theta}{2}}, & \kappa_2(\theta) &= \sin \gamma \frac{\sin \frac{\beta - \theta}{2}}{\sin \frac{\alpha + \theta}{2}}, & \kappa_2 - \kappa_1 &= -\frac{\sin^2 \gamma \sin \omega}{\sin \frac{\alpha + \theta}{2} \sin \frac{\beta + \theta}{2}}, \\ \kappa_1'(\theta) &= \frac{-\sin \gamma \sin \omega}{2 \sin^2 \frac{\beta + \theta}{2}}, & \kappa_2'(\theta) &= \frac{-\sin \gamma \sin \omega}{2 \sin^2 \frac{\alpha + \theta}{2}}. \end{aligned}$$

The length of biarc as a function of θ , and its derivative appear as

$$\begin{aligned} L(\theta) &= \frac{\theta - \alpha}{\kappa_1(\theta)} + \frac{\beta - \theta}{\kappa_2(\theta)}; \\ L'(\theta) &= \frac{\kappa_1 - (\theta - \alpha)\kappa_1'}{\kappa_1^2} - \frac{\kappa_2 + (\beta - \theta)\kappa_2'}{\kappa_2^2} = \frac{\kappa_1 \kappa_2 (\kappa_2 - \kappa_1) - \kappa_1' \kappa_2^2 (\theta - \alpha) - \kappa_2' \kappa_1^2 (\beta - \theta)}{\kappa_1^2 \kappa_2^2} = \\ &= \frac{\sin \omega \left[-2 \sin \gamma \sin \frac{\alpha - \theta}{2} \sin \frac{\beta - \theta}{2} + (\theta - \alpha) \sin^2 \frac{\beta - \theta}{2} + (\beta - \theta) \sin^2 \frac{\alpha - \theta}{2} \right]}{2 \sin \gamma \sin^2 \frac{\alpha - \theta}{2} \sin^2 \frac{\beta - \theta}{2}}. \end{aligned}$$

We have to prove that the above bracketed expression is of constant sign. Applying one more substitution,

$$\theta = \omega - x, \quad \text{i.e.} \quad \alpha - \theta = x + \gamma, \quad \beta - \theta = x - \gamma,$$

denote this expression as $F(x; \gamma)$:

$$\begin{aligned} F(x; \gamma) &= -2 \sin \gamma \sin \frac{x + \gamma}{2} \sin \frac{x - \gamma}{2} - (x + \gamma) \sin^2 \frac{x - \gamma}{2} + (x - \gamma) \sin^2 \frac{x + \gamma}{2} \\ &= \cos x (\gamma \cos \gamma + \sin \gamma) + x \sin x \sin \gamma - \sin \gamma \cos \gamma - \gamma. \end{aligned}$$

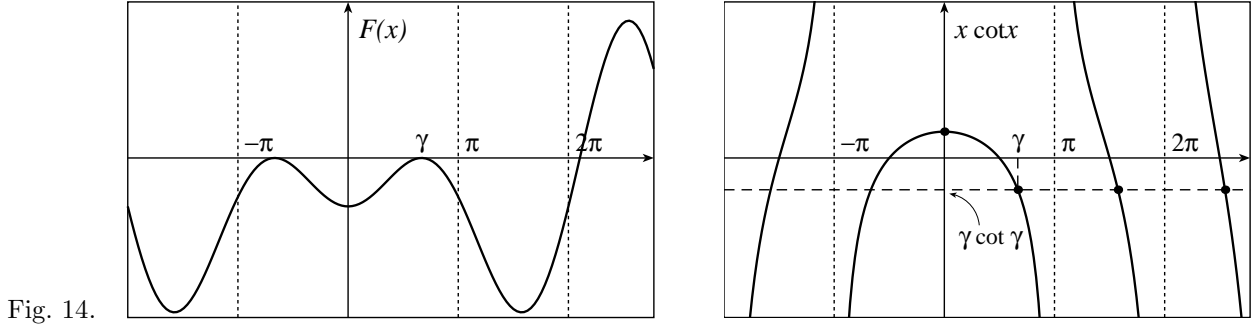

Since $\theta \in [-\alpha, \beta] \in [-\pi, \pi]$ and $|\omega| < \pi$, it is sufficient to explore the interval $x \in [-2\pi, 2\pi]$. Because $F(x; \gamma)$ is even with respect to x [$F(-x; \gamma) = F(x; \gamma)$], and odd with respect to the parameter [$F(x; -\gamma) = -F(x; \gamma)$], we explore its behavior only for $\gamma > 0$ and $x \geq 0$. The plot of $F(x; \frac{2}{3}\pi)$ is shown on the left side of Fig. 14. To find extrema of $F(x; \gamma)$ solve the equation $F'_x(x; \gamma) = 0$:

$$x \cos x \sin \gamma - \gamma \sin x \cos \gamma = 0.$$

Its non-negative roots x_0, x_1, x_2, \dots are: $x_0 = 0$, and those of the equation $x \cot x = \gamma \cot \gamma$; in particular, $x_1 = \gamma$. The roots are shown as dots in the right side of Fig. 14, where the function $x \rightarrow x \cot x$ is plotted. From piecewise monotonicity of this function it is clear that $x_1 \in (0, \pi)$, $x_2 \in (\pi, 2\pi)$, etc. We can now describe the behavior of $F(x; \gamma)$ in $x \in [0, 2\pi]$ as follows. At $x = 0$ function has negative local minimum

$$F(0; \gamma) = 2 \sin^2 \frac{\gamma}{2} (\sin \gamma - \gamma) < 0, \quad F''_{xx}(0; \gamma) = \sin \gamma - \gamma \cos \gamma > 0.$$

It increases to the maximum $F(x_1; \gamma) = F(\gamma; \gamma) = 0$, and then decreases to the subsequent minimum at $x = x_2$. While increasing from x_2 to $x_3 \in (2\pi, 3\pi)$, function passes through the boundary $x = 2\pi$ of the interval under investigation, still remaining negative at this point: $F(2\pi; \gamma) = F(0; \gamma) < 0$. It is therefore negative in $[-2\pi, 2\pi]$, except two zeros at $x = \pm\gamma$. The derivative $L'(\theta)$ does not change sign; and $L(\theta)$ is strictly monotonic. q.e.d.

7 Positional inequalities for short spirals

The following theorem generalizes the earlier results for “very short” spirals (theorem 3 in [7]) and for convex ones (theorem 5 in [10]).

Theorem 7.1. *Short spiral arc is located within its lense. Except endpoints, the arc has no common points with lense’s boundary.*

Proof. As the point $P(s)$ moves along the curve, the circular arcs $APB = \mathcal{A}(-\delta(s))$, containing P , fill continuously the lense (Fig. 15). Because $-\delta(0) = \alpha$, and $\delta(s)$ is strictly monotonic (lemma 5.7), the curve at the very beginning deviates immediately from the boundary arc $\mathcal{A}(\alpha)$ to the interior of the lense. Near the end point the behavior is similar. q.e.d.

Corollary 7.2. *A short spiral may cut its chord only once; and this occurs if and only if the tangent angles α and β are nonzero and of the same sign.*

More severe limitation can be derived if boundary curvatures are known, as shown in Fig. 16. For every inner point of a spiral the unique biarc $\mathcal{B}(b; \alpha, \beta)$ can be constructed. Thus generated subfamily of biarcs fill *bilense*, i.e. the region, bounded by two biarcs, AT_1B and AT_2B . Arcs AT_1 and T_2B belong to boundary circles of curvatures of the enclosed spiral.

Returning to Figs. 6a,b,c, this corresponds to projection of the point $K = (\kappa_1, \kappa_2)$ onto the hyperbola $Q = 0$, yielding two points, $H_1 = (\kappa_1, g_2)$ and $H_2 = (g_1, \kappa_2)$. They provide in turn two biarcs, marked as h_1 and h_2 , and bilense. We are going to prove that any short spiral, whose boundary parameters $(\alpha, \beta, \kappa_1, \kappa_2)$ belong to the closed region KH_1H_2K , is covered by corresponding bilense. If point K is being moved backwards and upwards to infinity (or, in the case of decreasing curvature, forwards and downwards within the lower right branch of hyperbola), biarcs h_1 and h_2 approach the boundaries of the lense (38), covering all shorts spirals with given tangents α, β and $-\infty \leq \kappa_1 < \kappa_2 \leq \infty$. It was the subject of theorem 7.1.

Definition 7.3. A *bilense* $\mathbf{B}(\alpha, \beta, b_1, b_2)$, $0 \leq b_1 < b_2 \leq \infty$, generated by a short non-biarc spiral with end conditions

$$\alpha, \beta, \quad \text{such that} \quad |\omega| \neq \pi, \quad \text{and} \quad \kappa_1 = -\sin \alpha - b_1^{-1} \sin \omega, \quad \kappa_2 = \sin \beta + b_2 \sin \omega,$$

is the region, bounded by two biarcs $\mathcal{B}(b_1; \alpha, \beta)$ and $\mathcal{B}(b_2; \alpha, \beta)$, namely,

$$\mathbf{B}(\alpha, \beta, b_1, b_2) = \{(x, y) : (x, y) \in \mathcal{B}(b; \alpha, \beta)\}.$$

Choosing the parent spiral to be non-biarc, we force Q to be strictly negative, and avoid bilense of zero width. Condition $b_1 < b_2$ in Def. 7.3, for both increasing and decreasing curvature, results from

$$Q(\kappa_1, \kappa_2, \alpha, \beta) = \left(1 - \frac{b_2}{b_1}\right) \sin^2 \omega < 0.$$

Theorem 7.4. *All normalized short spirals with fixed boundary tangents α, β , such that $|\omega| \neq \pi$, and curvature $\kappa(s)$, such that $\kappa_1 \leq \kappa(s) \leq \kappa_2$, or $\kappa_1 \geq \kappa(s) \geq \kappa_2$, are covered by the corresponding bilense $\mathbf{B}(\alpha, \beta, b_1, b_2)$,*

$$b_1 = \frac{-\sin \omega}{\kappa_1 + \sin \alpha}, \quad b_2 = \frac{\kappa_2 - \sin \beta}{\sin \omega}.$$

Proof. Fig. 16 clarifies the proof, based on the monotonicity of the map

point on the curve \rightarrow biarc through this point,

i.e. monotonicity of the function $b(s) = b(x(s), y(s))$, defined by (40). Consider the case of increasing curvature. Denote $C = Z(\bar{s})$ the point where the spiral meets the bisector of the lense. From the proof of theorem 7.1 it is clear that such point exists, is unique, and the subarc AC of the spiral is located in the upper half of the lense. From $\delta(\bar{s}) = -\gamma$ derive equality $\omega_1(\bar{s}) = \omega_2(\bar{s})$:

$$\begin{aligned} 0 &= 2[\delta(\bar{s}) + \gamma] = 2\mu_2(\bar{s}) - 2\mu_1(\bar{s}) + \alpha - \beta = \\ &= \underbrace{[\alpha - \mu_1(\bar{s})]}_{\alpha_1} + \underbrace{[\tau(\bar{s}) - \mu_1(\bar{s})]}_{\beta_1} - \underbrace{[\tau(\bar{s}) - \mu_2(\bar{s})]}_{\alpha_2} + \underbrace{[\beta - \mu_2(\bar{s})]}_{\beta_2} = 2[\omega_1(\bar{s}) - \omega_2(\bar{s})]. \end{aligned}$$

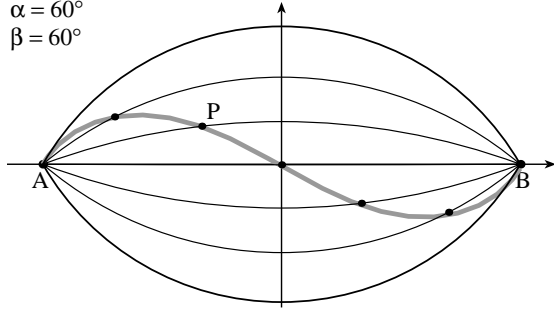
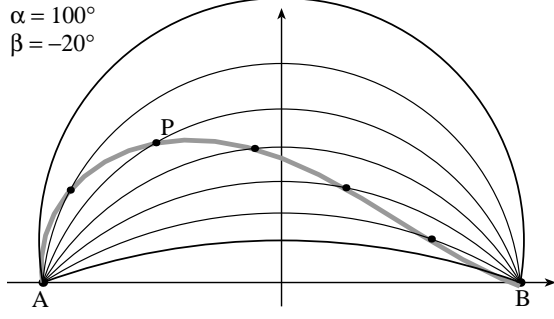

Fig. 15.

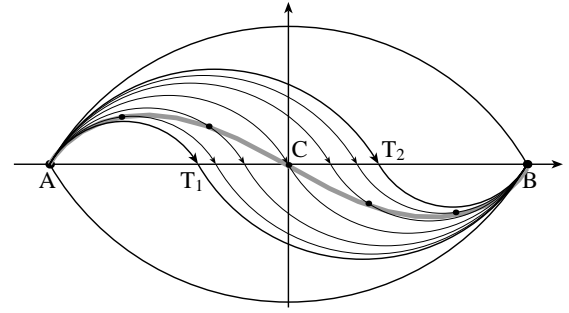
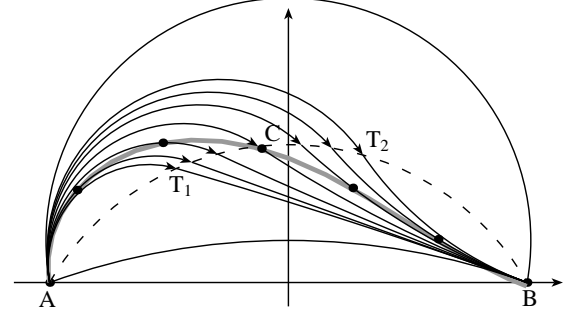

Fig. 16.

Denote $\omega_0 = \omega_1(\bar{s}) = \omega_2(\bar{s})$ and apply inequality (31), taking into account that $0 < \omega < \pi$:

$$\Omega(\bar{s}) = 2\omega_0 - \omega < 0 \implies \omega_0 < \frac{\omega}{2} < \frac{\pi}{2}.$$

The map $b(s) = b(x(s), y(s))$ for the points of AC is determined by the first expression of (40). Applying substitutions

$$\begin{aligned} h_1 &= \sqrt{(x+1)^2 + y^2}, & D &= (1-x^2-y^2) \sin \alpha - 2y \cos \alpha = \frac{h_1^2 \sin \omega}{b}, \\ x' &= \cos \tau, & y' &= \sin \tau, & x+1 &= h_1 \cos \mu_1, & y &= h_1 \sin \mu_1 \end{aligned}$$

($x, y, h_1, \mu_1, \tau, D, b$ are functions of s), calculate derivative $b'(s)$:

$$\begin{aligned} \frac{db}{ds} &= \frac{d}{ds} \frac{h_1^2 \sin \omega}{D} = 2 \sin \omega \frac{[(x+1)x' + yy']D + h_1^2[(xx' + yy') \sin \alpha + y' \cos \alpha]}{D^2} = \\ &= 2 \sin \omega \frac{[(x+1)^2 - y^2] \sin(\alpha + \tau) - 2y(x+1) \cos(\alpha + \tau)}{D^2} = \\ &= 2 \sin \omega \frac{h_1^2 [\cos 2\mu_1 \sin(\alpha + \tau) - \sin 2\mu_1 \cos(\alpha + \tau)]}{[h_1^2 b^{-1} \sin \omega]^2} = \frac{2b^2 \sin 2\omega_1}{h_1^2 \sin \omega} \geq 0. \end{aligned}$$

This expression is non-negative in $(0, \bar{s}]$ because $\omega_1(s)$ is monotonic increasing with s up to the value $\omega_1(\bar{s}) = \omega_0 < \frac{\pi}{2}$. It may be zero while $\omega_1(s) = 0$, i.e. in the case of initial circular subarc, partially coincident with the initial curvature element of the spiral (arc AT_1). The value $b(0)$ can

be calculated from expansions

$$x(s) = -1 + s \cos \alpha - \frac{\kappa_1}{2} s^2 \sin \alpha + O(s^3), \quad y(s) = s \sin \alpha + \frac{\kappa_1}{2} s^2 \cos \alpha + O(s^3) :$$

$$b(0) = \lim_{s \rightarrow 0} b(s) = \lim_{s \rightarrow 0} \frac{(4 + \kappa_1^2 s^2) \sin \omega}{-4(\kappa_1 + \sin \alpha) - \kappa_1^2 s^2 \sin \alpha} = \frac{-\sin \omega}{\kappa_1 + \sin \alpha} = b_1.$$

Similarly, from the second expression of (40), $b(S) = b_2$, and, due to $2\omega_2(s) < \pi$ in $[\bar{s}, S)$, the derivative remains non-negative in $[\bar{s}, S)$:

$$b'(s) = \frac{d}{ds} \frac{(1-x^2-y^2) \sin \beta + 2y \cos \beta}{\sin \omega [(x-1)^2 + y^2]} = \dots = \frac{2 \sin 2\omega_2}{h_2^2 \sin \omega} \geq 0$$

For decreasing curvature functions $\omega_{1,2}(s)$ as well as the constant ω change sign; $b(s)$ remains monotonic increasing. q.e.d.

Fig. 17 illustrates an application of these results to a spiral in the whole. A spiral is presented in Fig. 17a by a set of points P_1, \dots, P_n , $n = 11$, and tangents τ_1, τ_n at the endpoints. The constraint was imposed that the subarcs $\widehat{P_i P_{i+1}}$ were one-to-one projectable onto the corresponding chord (i.e. $|\tilde{\alpha}_i, \tilde{\beta}_i| < \pi/2$). For the practice of curves interpolation it is a quite weak limitation.

In Fig. 17b circular arcs A_1, \dots, A_n are constructed as follows: arc A_1 passes through points P_1 and P_2 , matching at P_1 given tangent τ_1 ; arcs A_i , $i = 2, \dots, n-1$ pass through three consecutive points P_{i-1}, P_i, P_{i+1} ; arc A_n passes through two points P_{n-1}, P_n , matching given tangent τ_n at the endpoint. Thus on each chord $P_i P_{i+1}$ we get a lense, bounded by arcs A_i and A_{i+1} . The following was proven in [7], theorem 5:

- *The sequence k_1, \dots, k_n of curvatures of arcs A_i is monotonic.*
- *The union of such lenses covers all spirals, matching given interpolation data.*

The width of this region is of the order $O(h_i^3)$, $h_i = |P_i P_{i+1}|$. Fig. 17c shows this construction for 15 points. The influence of discretization is also seen from comparing left and right branches of the spiral. Thus, the measure of determinancy of a spiral by inscribed polygonal line is provided, without invoking any empirics of particular interpolational algorithms.

8 Existence theorems

The converse of Vogt's theorem, namely, the problem of joining two line or curvature elements by a spiral arc, was considered by A. Ostrowski [11]. His solution concerns only C^2 -continuous convex spirals. It states that for two given line elements Vogt's theorem is the sufficient condition for the existence of such spiral. If curvatures R_1^{-1} and R_2^{-1} at the endpoints are involved, additional condition $D < |R_2 - R_1|$ is required, D being the distance between the centres of two boundary circles of curvature. Rewritten in terms of this article, this condition is the particular case of inequality $Q(\mathcal{K}_1, \mathcal{K}_2) < 0$. Theorem 2 in [7] establishes this condition for "very short" spirals, regardless of convexity, and includes the biarc case as the unique solution if $Q(\mathcal{K}_1, \mathcal{K}_2) = 0$.

Theorem 8.1. *The necessary and sufficient conditions for the existence of a short spiral curve, matching at the endpoints two given curvature elements (4), are: modified Vogt's theorem (6) and inequality $Q(\mathcal{K}_1, \mathcal{K}_2) \leq 0$; if $Q = 0$, biarc is the unique solution.*

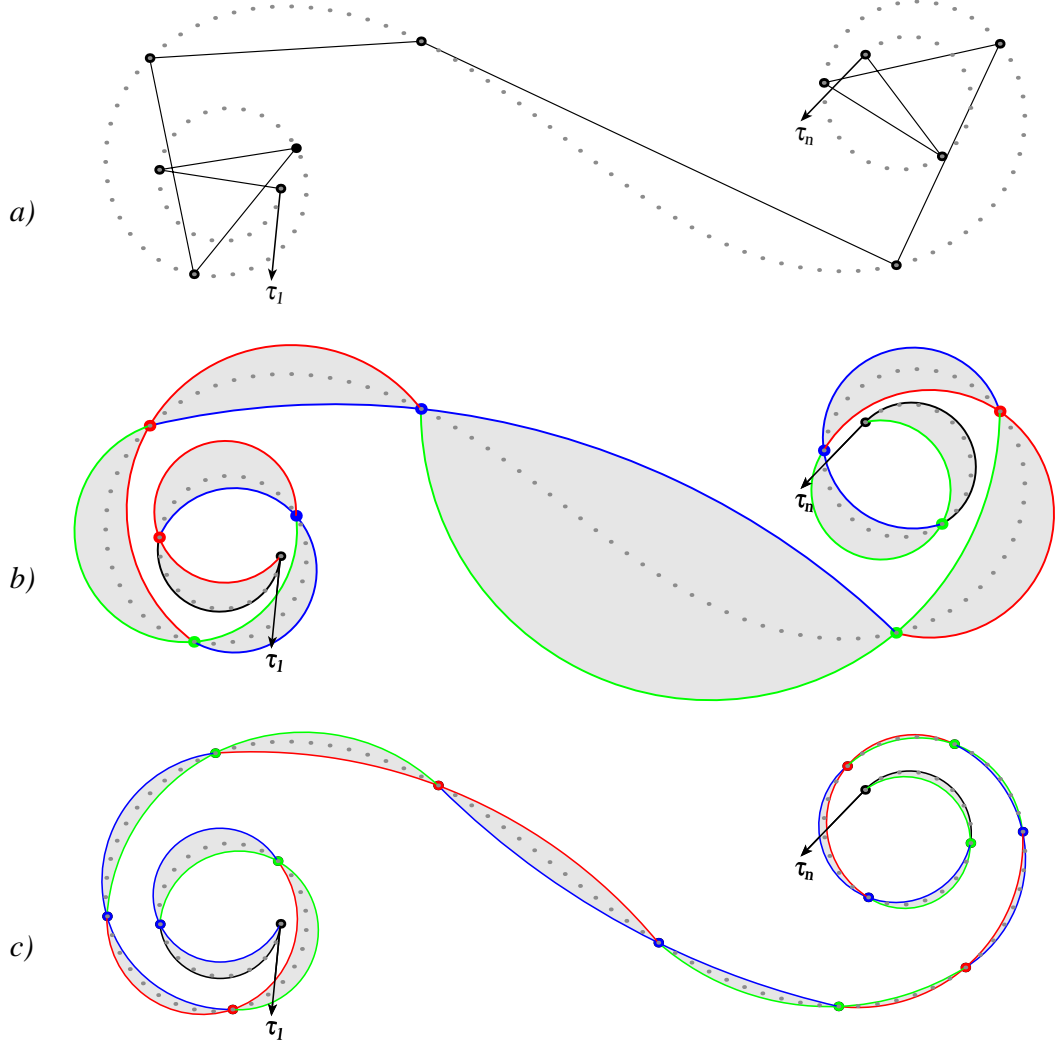

Fig. 17.

Proof. Theorems 3.1 and 4.2 prove the necessity of these conditions. To prove sufficiency, construct a smooth three-arc spiral curve whose boundary curvature elements are \mathcal{K}_1 and \mathcal{K}_2 , shown as AC and DB in Fig. 18. Apply inversion about the circle

$$\mathcal{K}^* = \mathcal{A}(\gamma^*) = K(-1, 0, \gamma^*, \kappa^*), \quad \gamma^* = \gamma/2, \quad \kappa^* = -\sin(\gamma^*),$$

shown dotted-dashed; its centre is the point $O = (0, y^*) = (0, -\cot \gamma^*)$. The inversion is chosen to make the lense symmetric, its former bisector $\mathcal{A}(\gamma)$ is transformed into the chord $\mathcal{A}(0)$. For $\gamma = 0$ this is just a symmetry about X-axis. If $\gamma \neq 0$ (which means $|\omega| < \pi$), we have to verify that all the points of the interior of the lense remain in the interior of its image, i.e. O is located outside the lense. To do it, we enter lense's boundary ordinates as $y_1 = \tan \frac{\alpha}{2}$ and $y_2 = -\tan \frac{\beta}{2}$, and check the sign of the product

$$(y^* - y_1)(y^* - y_2) = \left(-\cot \frac{\gamma}{2} - \tan \frac{\alpha}{2}\right) \left(-\cot \frac{\gamma}{2} + \tan \frac{\beta}{2}\right) = \frac{\cos^2 \frac{\omega}{2}}{\sin^2 \frac{\gamma}{2} \cos \frac{\alpha}{2} \cos \frac{\beta}{2}} > 0.$$

New boundary angles α' , β' can be calculated from conditions $\gamma^* = \frac{1}{2}(\alpha + \alpha')$, $-\gamma^* = \frac{1}{2}(\beta + \beta')$; and

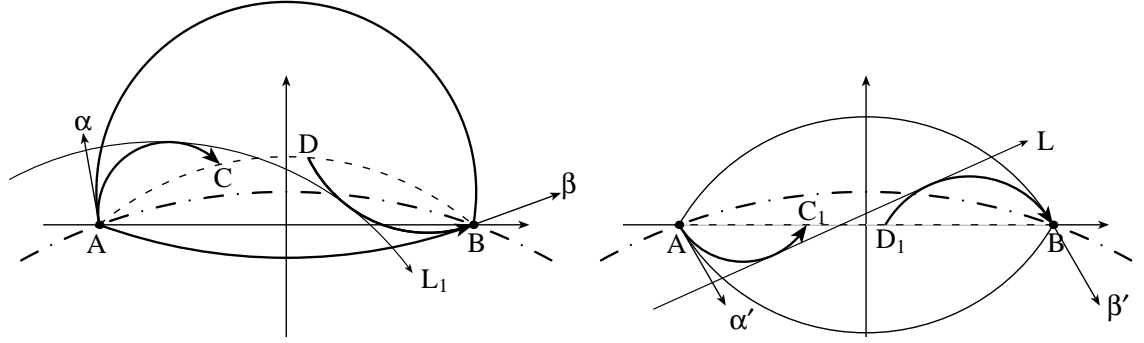

Fig. 18.

new curvatures κ'_1, κ'_2 , from Prop. 4.8:

$$\begin{aligned}\kappa'_1 &= 2\kappa^*(1-2Q_{01}) - \kappa_1, & Q_{01} &= Q(\mathcal{K}^*, \mathcal{K}_1) = \sin^2[(\alpha - \gamma^*)/2], \\ \kappa'_2 &= 2\kappa^*(1-2Q_{02}) - \kappa_2, & Q_{02} &= Q(\mathcal{K}^*, \mathcal{K}_2) = \sin^2[(\gamma^* + \beta)/2]\end{aligned}$$

(to calculate Q 's the last equation of (8) was used). This yields

$$\alpha' = \beta' = \omega' = -\omega, \quad \kappa'_1 = [-\kappa_1 - \sin \alpha] + \sin \omega, \quad \kappa'_2 = -[\kappa_2 - \sin \beta] - \sin \omega.$$

(e.g., $\kappa'_1 = -2 \sin \gamma^* \cos(\alpha - \gamma^*) - \kappa_1 = -\sin \alpha - \sin(2\gamma^* - \alpha) - \kappa_1 = -\kappa_1 - \sin \alpha + \sin \omega$). For the initial conditions, corresponding to increasing curvature (i.e. $0 < \omega \leq \pi$, $\kappa_1 < \kappa_2$), $\sin \omega$ is non-negative, and the bracketed terms are positive. The latter is direct consequence of inequality $Q(\mathcal{K}_1, \mathcal{K}_2) \leq 0$ (Cor. 4.4). New end conditions correspond to decreasing curvature with boundary curvatures opposite in sign for whichever signs of $\kappa_{1,2}$: $\kappa'_1 > 0 > \kappa'_2$. Inversed curvature elements are shown as AC_1 and D_1B . Show that point $C_1 = (x_1, 0)$ is located to the left of $D_1 = (x_2, 0)$:

$$\begin{aligned}AC_1 &= -\frac{2 \sin \alpha'}{\kappa'_1} = \frac{2 \sin \omega}{\sin \omega - \kappa_1 - \sin \alpha}, & x_1 &= -1 + AC_1 = \frac{\sin \omega + \kappa_1 + \sin \alpha}{\sin \omega - \kappa_1 - \sin \alpha}, \\ D_1B &= \frac{2 \sin \beta'}{\kappa'_2} = \frac{2 \sin \omega}{\sin \omega + \kappa_2 - \sin \beta}, & x_2 &= 1 - D_1B = \frac{\kappa_2 - \sin \beta - \sin \omega}{\sin \omega + \kappa_2 - \sin \beta}.\end{aligned}$$

The denominators in the expressions for $x_{1,2}$ being positive, it is easy to check that the condition $x_1 \leq x_2$ is equivalent to $Q \leq 0$. The equalities, if occur, are simultaneous, and two arcs form a unique biarc solution. Otherwise the existence of straight line $L = K(x_0, 0, \lambda, 0)$, smoothly joining two given arcs, is evident; its parameters x_0 and λ ($x_1 < x_0 < x_2$, $\lambda > 0$) can be calculated from two equations $Q(L, \mathcal{K}_{1,2}) = 0$. The backward inversion resets the increasing curvature and yields the sought for solution — intermediate arc L_1 , image of L . q.e.d.

Theorem 8.2. *The necessary and sufficient condition for the existence of a non-biarc spiral curve, matching at the endpoints two given curvature elements (3), is*

$$Q(\mathcal{K}_1, \mathcal{K}_2) = (k_1 c + \sin \alpha)(k_2 c - \sin \beta) + \sin^2 \frac{\alpha + \beta}{2} < 0.$$

Proof. The necessity results from theorem 4.2. To prove sufficiency, a sought for spiral can be constructed as a three-arc curve. This problem was explored in [6], and the existence of solutions, all of them being spirals iff $Q < 0$, was established.

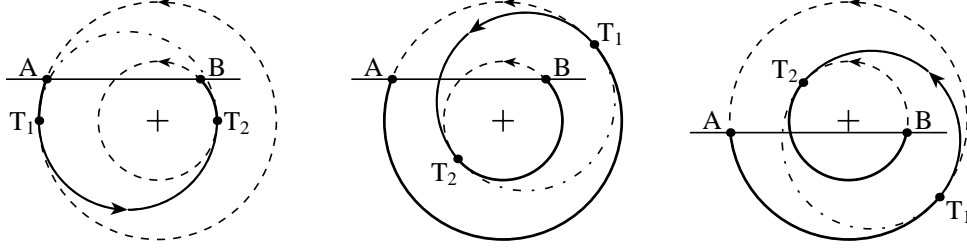

Fig. 19.

A simple proof of sufficiency, alternative to that of [6], can be proposed. Apply inversion, bringing two given circles into concentric position (Fig. 19). Condition $Q < 0$ means that the circles \mathcal{K}_1 and \mathcal{K}_2 do not intersect, and are not tangent. Therefore such inversion exists. Denote the images of \mathcal{K}_1 and \mathcal{K}_2 as

$$\begin{aligned} \mathcal{K}'_1 &= K(x_1, y_1, \alpha', k'_1), & x_1 &= a + \sin \alpha' / k'_1, & y_1 &= b - \cos \alpha' / k'_1, \\ \mathcal{K}'_2 &= K(x_2, y_2, \beta', k'_2), & x_2 &= a + \sin \beta' / k'_2, & y_2 &= b - \cos \beta' / k'_2. \end{aligned}$$

The expressions for $x_{1,2}$ and $y_{1,2}$ assure concentricity with the common centre (a, b) . Recalculate (7), which remains invariant under inversion:

$$Q(\mathcal{K}'_1, \mathcal{K}'_2) = \frac{-(k'_2 - k'_1)^2}{4k'_1 k'_2} = Q(\mathcal{K}_1, \mathcal{K}_2) < 0.$$

Negative value of the invariant means that two curvatures k'_1 and k'_2 are of the same sign, and two circles \mathcal{K}'_1 and \mathcal{K}'_2 are parallel. All possible intermediate arcs $T_1 T_2$ have the same curvature k_0 , and the sequence k'_1, k_0, k'_2 is monotonic:

$$\frac{1}{k_0} = \frac{1}{k'_1} + \frac{1}{k'_2}, \quad k_0 = \frac{2k'_1 k'_2}{k'_1 + k'_2} \implies k'_1 \leq k_0 \leq k'_2.$$

An intermediate arc can be constructed for any images A and B of two given endpoints. The backward inversion restores the initial type of monotonicity of curvature. q.e.d.

Note that the strict form of inequality in theorem 8.2 is strong enough to exclude both the chord of zero length and the equality $k_1 = k_2$: with $c=0$ we get $Q = \sin^2 \gamma$, and with $k_1 c = k_2 c = \kappa$ the invariant Q takes non-negative form (16). We need not to invoke Vogt's theorem: if the sum $\alpha + \beta$ does not suit condition $k_1 \leq k_2$ (1), cumulative angles $\tilde{\alpha} = \alpha \pm 2\pi$ or $\tilde{\beta} = \beta \pm 2\pi$ resolve the contradiction, resulting to a long spiral as a solution.

9 Conclusions

The author's looking at the theory of spirals and revisiting Vogt's theorem was initially tied to the hypothesis that, under certain constraints, the curve can be fairly well reproduced from the interpolation data or inscribed polygon. And, contrary to traditional treatment of this problem, it was interesting to impose more fundamental constraints than, say, artificial limits for derivatives, etc. Such constraint was suggested by the Four-Vertex theorem, and the definition of the problem sounded like:

Amongst all curves matching given interpolation data select those having a minimum of vertices; estimate the region covered by them.

The solution for spiral curves, i.e. with the minimum of vertices being zero, was cited here as Fig. 17. The preliminary extension for non-spiral curves was demonstrated in [7]. Constraints for non-spirals, similar to (15), were discussed in [8].

The tendency to minimize the number of vertices is very close to the notion of *fair curve*, widely discussed in Computer-Aided Design (CAD) applications [14].

In recent years much attention is given to curves with monotonic curvature in CAD related publications. Refs. [10, 13] provide just start points and titles for the bibliographical search. A lot of research is aimed to extract spiral subarcs from Bézier or NURBS curves, whose polynomial nature is far short of spirality. We have chosen a somewhat different approach, having focused on general properties, induced by monotonicity of curvature.

Most of the earlier studies of spiral curves seem to have been aimed at obtaining the results similar to the Four-Vertex-theorem, and limited to this objective. They required continuity of evolute as the basis for the proofs, and therefore were restricted to the curves with continuous curvature of constant sign. Similarly, a lot of CAD applications propose separate treatment of “C-shaped” and “S-shaped” spirals, which is usually unnecessary.

As a final note, we give some attention to the term *spiral* by itself. Literature treatments are not rigorous and vary considerably. A curve with a monotonic polar equation $r(\varphi)$ is often meant by a spiral ([2], p. 325). Considering spirality as a property of shape, the relation to a specific coordinate system is the drawback of this definition. Guggenheimer’s treatment of spirality as monotonicity of curvature is purely shape related. Three examples illustrate some ambiguities:

- Fermat spiral, $r = a\sqrt{\varphi}$: curvature is not monotonous;
- Cornu spiral $k(s) = s/a^2$: no polar equation for the curve as the whole;
- Côtes’ spiral $r = a/\cos(k\varphi)$: neither definition is applicable.

Curves with monotonic curvature comprise an important subset of planar curves. The list of their properties, compiled from [12], [3] (pp. 48–54), and this article, is far short of being complete. This class of curves is worthy of definite naming. To designate them, the term “*true spirals*” is being proposed.

Acknowledgement. The author is grateful to prof. Victor Zalgaller, who explored his collection of references, and called author’s attention to the research of Wolfgang Vogt.

References

- [1] *Coxeter H.S.M.*, Inversive Distance. *Annali di Matematica Pura ed Applicata*, 4, **71**(1966), 73–83.
- [2] *Encyclopedic Dictionary of Mathematics*. Vol. 1. The Mit Press, Cambridge, 1977.
- [3] *Guggenheimer H.W.*, *Differential geometry*. Dover Publications, New York, 1977.
- [4] *Hirano K.*, Simple proofs of Vogt’s theorem. *Tohoku Math. J.*, **47**(1940), 126–128.
- [5] *Katsuura S.*, Ein neuer Beweis des Vogtschen Satzes. *Tohoku Math. J.*, **47**(1940), 94–95.
- [6] *Kurnosenko A.*, Inversive invariant of a pair of circles (in Russian). *Zapiski nauch. sem. POMI*, **261**(1999), 167–186.
(<http://dbserv.ihep.su/~pubs/prep1999/99-59-e.htm>).
- [7] *Kurnosenko A.*, Interpolational properties of planar spiral curves (in Russian). *Fund. i priklad. matematika (Fund. and Appl. Math.)*, **7**(2001), N2, 441–463.
(<http://dbserv.ihep.su/~pubs/prep1998/98-9-e.htm>)
- [8] *Kurnosenko A.*, Inequalities on the planar curves in the vicinity of one or two vertices (in Russian). *Zapiski nauch. sem. POMI*, **280**(2001), 194–210.
- [9] *Meek D.S., Walton D.J.*, Approximation of discrete data by G^1 arc splines. *Computer-Aided Design*, **24**(1992), N6, 301–306.
- [10] *Meek D.S., Walton D.J.*, Approximating smooth planar curves by arc splines. *J. of Comp. and Appl. Math.*, **59**(1995), 221–231.
- [11] *Ostrowski A.*, Über die Verbindbarkeit von Linien- und Krümmungselementen durch monoton gekrümmte Kurvebogen. *Enseignement Math.*, Ser. 2, **2**(1956), 277–292.
- [12] *Vogt W.*, Über monotongekrümmte Kurven. *J. reine und angew. Math.*, **144**(1914), 239–248.
- [13] *Walton D.J., Meek D.S.*, Planar G^2 curve design with spiral segments. *Computer-Aided Design*, **30**(1998), N7, 529–538.
- [14] *Yang X., Wang G.*, Planar point set fairing and fitting by arc splines. *Computer-Aided Design*, **33**(2001), 35–43.
- [15] *Yong J.-H., Hu S.-M., Sun J.-G.*, A note on approximation of discrete data by G^1 arc splines. *Computer-Aided Design*, **31**(1999), 911–915.